

# MICRO™

THE 6502/6809 JOURNAL



**16-page bonus for Apple Computer users!**

**Macros for Micros**

**A C1P Dump Utility**

**Telephone Directory/Dialer for the AIM**

**Horizontal Screen Scrolling on the CBM/PET**



## Turn your Apple into the world's most versatile personal computer.

**The SoftCard™ Solution.** SoftCard turns your Apple into two computers. A Z-80 and a 6502. By adding a Z-80 microprocessor and CP/M to your Apple, SoftCard turns your Apple into a CP/M based machine. That means you can access the single largest body of microcomputer software in existence. Two computers in one. And, the advantages of both.

**Plug and go.** The SoftCard system starts with a Z-80 based circuit card. Just plug it into any slot (except 0) of your Apple. No modifications required. SoftCard supports most of your Apple peripherals, and, in 6502-mode, your Apple is still your Apple.

**CP/M for your Apple.** You get CP/M on disk with the SoftCard package. It's a powerful and simple-to-use operating system. It supports more software than any other microcomputer operating system. And that's the key to the versatility of the SoftCard/Apple.

**BASIC included.** A powerful tool, BASIC-80 is included in the SoftCard package. Running under CP/M, ANSI Standard BASIC-80 is the most powerful microcomputer BASIC available. It includes extensive disk I/O statements, error trapping, integer variables, 16-digit precision, extensive EDIT commands and string functions, high and low-res Apple graphics, PRINT USING, CHAIN and COMMON, plus many additional commands. And, it's a BASIC you can compile with Microsoft's BASIC Compiler.

**More languages.** With SoftCard and CP/M, you can add Microsoft's ANSI Standard COBOL, and FORTRAN, or

Basic Compiler and Assembly Language Development System. All, more powerful tools for your Apple.

**Seeing is believing.** See the SoftCard in operation at your Microsoft or Apple dealer. We think you'll agree that the SoftCard turns your Apple into the world's most versatile personal computer.

**Complete information?** It's at your dealer's now. Or, we'll send it to you and include a dealer list. Write us. Call us.

SoftCard is a trademark of Microsoft. Apple II and Apple II Plus are registered trademarks of Apple Computer. Z-80 is a registered trademark of Zilog, Inc. CP/M is a registered trademark of Digital Research, Inc.

# MICROSOFT

CONSUMER PRODUCTS

Microsoft Consumer Products, 400 108th Ave. N.E.,  
Bellevue, WA 98004. (206) 454-1315

# MR. RAINBOW

presents our valuable free catalog (over 100 pages). He **PROMPTS** you to **PEEK** at the latest collection of software and hardware products for your **APPLE II™**

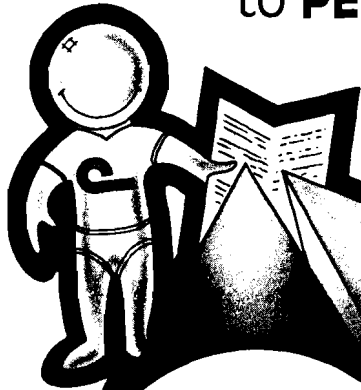

## A STELLAR TREK

the definitive Hi-Res color version of the classic Startrek game. Three different Klingon opponents. Many command prerogatives from use of weapons to repair of damages. Needs 48K Applesoft ROM.

Disk... **\$24.95**

## VERSAWRITER II

A drawing tablet, simply plugs into your game I/O port. Trace, draw, design, or color any type of graphic. Adds words to pictures. Creates schematics. Computes Distance/Area of any figure. New - fill any area on the screen in seconds with over 100 different and distinct colors. Needs 32K Applesoft ROM and disk drive. A bargain at...

**\$249.95**

## BOWLING DATA SYSTEM

This data mangement program provides accurate record keeping and report generation for bowling leagues of up to 40 teams with 6 bowlers per team. Needs 80-column printer, 32K Applesoft ROM.

Disk... **\$79.95**

## SUPER SOUND

Musical rhythms, gunshots, sirens, laser blasts, explosions... add these and many more exciting sounds to your Apple. Use them in your programs, or create your own SUPER SOUNDS. Needs 16K Applesoft.

Have a blast for only

**\$12.95**... Tape

**\$16.95**... Disk

ADD \$2.00 U.S. \$10.00 FOREIGN FOR SHIPPING  
CALIFORNIA RESIDENTS ADD 6% SALES TAX

Don't see what you want here, then write or call today for your free catalog. We're saving one just for you.

Visa / Mastercharge welcome.



Open Tues. - Sun.

GARDEN PLAZA SHOPPING CENTER  
9719 RESEDA BOULEVARD DEPT. 1MI  
NORTHRIDGE, CALIFORNIA 91324  
PHONE (213) 349-0300

# Star Warrior: Slay the Dictator and Save the Civilized People

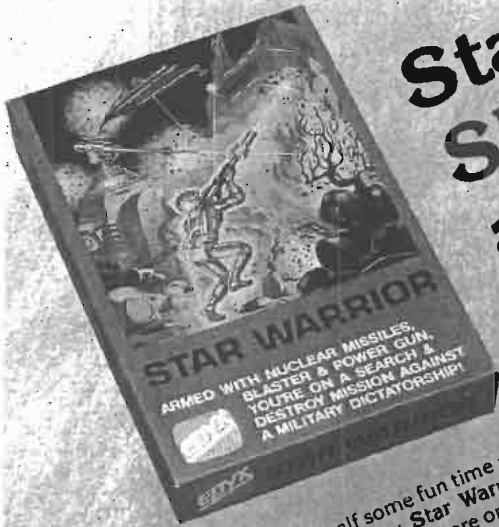

You owe yourself some fun time and you have just loaded the new **Star Warrior** into your computer. Suddenly, you are one of the Furies... and retribution is your business.

The Interstellar Union of Civilized People has been annexed by a soul-crushing dictator-ship. You have been given the mission to assassinate the military governor and then destroy the installation. That's Scenario 2.

In Scenario 1, you are on a diversionary mission for the assassination attempt. You want to do as much damage to the enemy units as possible.

The terrain is dangerous and difficult; the enemy forces are powerful and varied. You may not see the enemy even when you are in the same general area... but, on the other hand, the enemy may not see you either. There is always the chance of an attack by an invisible enemy.

There are two scenarios and five levels of difficulty... level five is almost impossible to win. There are usually no fixed playing times for Scenario 2; you play until you get the governor and escape or until you are killed. But you can even set a fixed playing time in Scenario 1.

You have the choice of suits and equipment, and of movement, combat and special commands.

In other words, like all EPYX games, there are enough variations in the game so that you will never tire of playing. Each game is different and fresh. You will never get bored playing the game. Not in your or your computer's lifetime.

**Star Warrior.** Another bug-free, fantastic game from EPYX. With the unique EPYX lifetime warranty: if anything happens to your cassette or disk at any time and for any reason, send it back with just \$5.00 for shipping and handling and we will send you a brand new one.

(Of course, there is also our 30-day unconditional guarantee: if your EPYX game has any defect whatsoever within 30 days of purchase, return it to us or your dealer and we will replace it free. No questions asked.)

Visit your dealer now and pick up **Star Warrior** in its good-looking, protective box with one of the best instruction books you ever read. Now available on disk for the Apple II (48K RAM with Applesoft) and Radio Shack's TRS-80 (Level II, 16K) and the Atari (32K). Only \$39.95 on disk or cassette.

If your dealer is out of stock and you can't wait, order directly from Automated Simulations, \$39.95 plus \$2.00 for shipping and handling (and sales tax if you are in California). We guarantee you will be delighted with **Star Warrior**. (If it is not exactly what you want, return it to us for full refund. Again, no questions asked.)

Enclose your check. Or if you order by Visa or MasterCard, use our toll-free phones: in the United States: operator 861 (800) 824-7888; in California: operator 861 (800) 852-7777; in Hawaii and Alaska: operator 861 (800) 824-7919. Order today. You and your computer deserve the fun.

**AUTOMATED SIMULATIONS, INC.**  
Dept. SVA, P.O. Box 4247  
1988 Leghorn Street  
Mountain View, CA 94040



# MICRO<sup>TM</sup>

## THE 6502/6809 JOURNAL

### STAFF

Editor/Publisher  
ROBERT M. TRIPP

Associate Publisher  
RICHARD RETTIG

Associate Editor  
MARY ANN CURTIS

Special Projects Editor  
MARJORIE MORSE

Art Director  
GARY W. FISH

Production Assistant  
LINDA GOULD

Typesetting  
EMMALYN H. BENTLEY

Advertising Manager  
CATHI BLAND

Circulation Manager  
CAROL A. STARK

Dealer Orders  
LINDA HENS DILL

MICRO Specialists  
APPLE: FORD CAVALLARI  
PET: LOREN WRIGHT  
OSI: PAUL GEFFEN

Comptroller  
DONNA M. TRIPP

Bookkeeper  
KAY COLLINS

### DEPARTMENTS

- 5 Editorial
- 6 Letterbox
- 16 Club Circuit
- 25 New Publications
- 95 Challenges
- 102 6502 Resource Update
- 105 Software Catalog
- 107 Hardware Catalog
- 108 6502 Bibliography
- 111 Advertisers' Index

### ARTICLES

- 9 **It's Time to Stop Dreaming** ..... *Robert M. Tripp*  
An introduction to the new 6809
- 11 **Programmable Character Generator for the CBM 2022 Printer** ..... *Roger C. Crites*  
Design special characters on screen and store in "dictionary"
- 17 **Musical Duets on the Apple II** ..... *Rick Brown*  
Add harmony to your Apple's music
- 27 **A C1P Dump Utility** ..... *Francois Faguy*  
A debugging tool for machine language and BASIC programs
- 33 **Machine Language to DATA Statement Conversion** ..... *Les Cain*  
Easy and accurate way to put m.l. routines in a BASIC program
- 35 **Telephone Directory/Dialer for the AIM** ..... *Rodney A. Kreuter*  
Turn your AIM into a telephone operator
- 45 **Macros for Micros** ..... *John Figueras*  
An introduction to the MACRO assembler
- 65 **Improved KIM Communication Capabilities** ..... *Ralph Tenny*  
Add new I/O capabilities to your KIM
- 71 **Amper Search for the Apple** ..... *Alan G. Hill*  
Find character strings in BASIC arrays
- 79 **Memory Expansion for the Superboard** ..... *Fred Boness*  
Use the OSI 527 board for low-cost memory expansion
- 81 **Horizontal Screen Scrolling on the CBM/PET** ..... *John E. Girard*  
Simple modification means increase in resolution
- 83 **Integer Flash for the Apple** ..... *Richard C. Vile, Jr.*  
How and why you can get flashing characters
- 88 **Polled Keyboard for C1P/Superboard** ..... *Michael J. Alport*  
Get both upper and lower case characters on your OSI
- 97 **AIM 65 RS-232 Interface** ..... *James Guilbeau*  
Easy installation with electrical information
- 99 **Real Time Clock for Superboard** ..... *James Mason*  
Maintain and display real time in a background mode.

### APPLE BONUS

- 49 **Create a Data Disk for DOS 3.2 and 3.2.1** ..... *Glenn R. Sogge*  
Save space by eliminating DOS
- 53 **Apple Color Filter** ..... *Stephen R. Berggren*  
Filter out any color from Apple's Hi-Res screen
- 59 **Serial Line Editor for the Apple** ..... *Wes Huntress*  
Add features like insertion and deletion to your Apple

# ARE YOU DEVELOPING SHIFT KEY SCHIZOPHRENIA?



Cure it with the lower case system from

**Lazer**  
MICRO-SYSTEMS INC.

The Keyboard +Plus from Lazer MicroSystems turns your Apple's shift key into a . . . shift key! The Keyboard +Plus transforms your Apple's upper case only keyboard into a typewriter style keyboard capable of entering all 128 ASCII characters into your DOS, Pascal, and CP/M applications programs. The use of the shift key is automatic with most programs. You do not have to write complicated "driver programs" or fuss with obscure "BIOS patches" in order to fully utilize this board. For those situations where upper case only input is desired, the Keyboard +Plus supports a caps lock mode that returns the Apple keyboard to it's former state.

Best of all, the keyboard +Plus features a typeahead buffer that gives you the ability to continue typing even though the computer is busy performing other tasks such as accessing the disk. The keyboard +Plus is the second component of Lazer MicroSystems' lower case system. When teamed with the Lazer MicroSystems' highly praised Lower Case +Plus, the lower case system turns your Apple into a sophisticated, user oriented, problem solving machine.

See the Lazer MicroSystems' lower case system at your local Apple dealer. If he is all out, you can order direct from us.

P.O.Box 55518  
Riverside, Calif. 92517  
(714) 682-5268

- \* Keyboard +Plus \$119.95
- \* Lower Case +Plus \$69.95

- \* Calif. residents add 6% tax.
- \* Outside U.S.A. add \$15.00 for Shipping & extra handling
- \* Allow 2 weeks extra for checks to clear. (personal & business)
- \* MC/VISA accepted. Include card number, exp date, and signature

Lower Case +Plus, Keyboard +Plus and +Plus are all trademarks of Lazer MicroSystems Inc.

## About the Cover

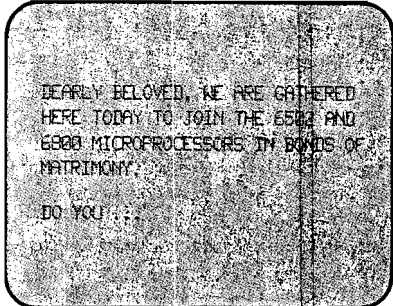

### A Marriage Made in Arizona

This cover depicts the joining of the 6502 and the 6800. The offspring, the 6809, combines the second accumulator, the 16-bit index register and the 16-bit stack of the 6800 with the second index register and improved addressing modes of the 6502. It then adds its own unique new capabilities, including an additional 16-bit stack pointer, a multiply instruction, a number of 16-bit operations, a fantastic Load Effective Address instruction, and many other improvements which make it superior to either of its parents. Hopefully, the generation gap is minimal and can be overcome. It will take willingness to invest a little time in learning how the new generation "thinks" and in getting familiar with its "slang."

**MICRO** is published monthly by:  
MICRO INK, Inc., Chelmsford, MA 01824  
Second Class postage paid at:  
Chelmsford, MA 01824 and Avon, MA  
02322  
USPS Publication Number: 483470  
ISSN: 0271-9002

Send subscriptions, change of address, USPS  
Form 3579, requests for back issues and all  
other fulfillment questions to

MICRO  
P.O. Box 6502  
Chelmsford, MA 01824  
or call  
617/256-5515

Subscription rates	Per Year
U.S.	\$18.00
Foreign surface mail	\$21.00
Air mail:	
Europe	\$36.00
Mexico, Central America	\$39.00
Middle East, North Africa	\$42.00
South America, Central Africa	\$51.00
South Africa, Far East, Australasia	\$60.00

Copyright © 1981 by MICRO INK, Inc.  
All Rights Reserved

# MICRO

## Editorial

### MICRO to Cover the 6809

The first four volumes of MICRO were devoted strictly to covering the 6502 microprocessor, and microcomputers based upon the 6502. Starting with this issue, which is the beginning of volume 5, MICRO will expand its range to include the Motorola 6809 microprocessor and microcomputers based upon it. The reason for this expanded coverage is simple. While the 6502 is a very good microprocessor and will continue to be a major force in the micro world for some time to come, it does have certain limitations, and over a period of time will become less and less competitive. For years we have hoped that MOS Technology, Synertek or Rockwell International, the three manufacturers of the 6502, would produce an improved 6502. At this time it seems unlikely that this will happen. None of the three have announced any new 8-bit upgrade of the 6502, and to do so at this late date would probably be a mistake. It takes a great deal of time and effort to produce a new microprocessor, and even more time to generate the most basic support required: editors, assemblers, language compilers and interpreters, business packages and so on. MICRO feels that it is simply too late for a new 6502-based product. So, what is the alternative? Do MICRO and its readers sit helplessly, watching the rest of the world move on to better micros? We think not. There is a very viable alternative — the 6809.

This microprocessor is very closely related to the 6502. Both are direct descendents of the 6800. They have a very similar basic architecture, compatible instructions, almost identical address, data and control signals, and much more. In fact, if someone had designed a "better 6502," it would probably have come out looking very much like the 6809. The first of a series of articles written to introduce the MICRO readership to the 6809 appears in this issue. Subsequent articles will go into greater detail about this device.

The 6809 is not "brand new." It has been around for a year or two and does have a reasonable amount of support. It

is very quickly finding its way into the 6502 world. Synertek Systems has announced an update kit that converts a SYM-1 to run with the 6809. The kit includes a 6809 version of the SYM monitor in ROM as well as the 6809 and supporting circuitry. Stellation II has announced an add-on for the Apple which permits the Apple to run with both the 6502 and the 6809. Commodore has just announced a new product, "Micro-Mainframe", which is a 6809-based system with extensive software packages including interpreters for BASIC, Pascal, FORTRAN and APL; an editor; operating system; and an assembly language development system. The Computerist Inc. has announced a system which may use the 6502, 6809, or both.

We expect that this is just the start of a whole new generation of microcomputers, based on the 6809, but related to the current 6502 system. MICRO readers should keep abreast of these developments and should become familiar with the 6809. MICRO will do its part by presenting introductory articles about the 6809 and by keeping you informed on all related developments. If you are working on a 6809-based system already, we are interested in reviewing articles about your system.

### A Quick Reference

I told you things were happening fast in the 6809 world. Just today, as this issue goes to the printer, I received a new book: *6809 Microcomputer Programming & Interfacing With Experiments*, by Andrew C. Staugaard, Jr. It is published by Howard W. Sams & Co., Inc. and lists at \$13.95. I have not had time to give it more than a quick "once-over", but it looks very informative.

### The Perfect MICRO

Since MICRO has grown so much in physical size over the past year, and since we expect more growth in the coming year, especially with the Bonus Sections, we have had to go to a different binding technique: Perfect Bound. This should provide a better product with less chance of covers tearing off. The three-hole punch will be maintained.

*Robert M. Taylor*

# MICRO

## Letterbox

The following letters are in response to the March editorial (34:5).

Dear Editor:

Your March editorial concerning "copyright/copywrong" was an articulate plea for honesty and fairness in the use and abuse of "protected" material. While I personally agree with nearly everything the editorial stated, I emphatically *do not* agree with the conclusion you arrived at and I wholeheartedly disagree with the position you have taken.

I am appalled by the assumption you make that anyone who has a program that can copy a protected disk, tape, (whatever), will rush out and run off numerous copies for his friends and relatives [thereby reducing the potential market for the protected material]. Where do you get the moxy to demean the *large majority* of your readers by suggesting they would act in such a manner? That theft exists I am willing to admit. Like you I condemn it unequivocally! It *does* and *has* forced vendors to increase the price to cover "copy wrong" losses. Your statement that theft "may" increase prices is generous to a fault. Those hidden costs (including the added cost in programming time and design effort to "protect" the program) are *already* included in the price. Valid users are already paying for the thieves' practice and for the disregard by vendors and editors who protect themselves at the expense of the utility of the program[s].

I suggest the only real threat to the growth of the software market is the usability and convenience withheld from the end user. Programs that ignore the honest needs of the end user *ought* to face competition from a product that will provide that service to the user. To restrain that sort of competition is the worst disservice a magazine and its editor can do to its readership, its advertisers and the marketplace in general.

Dear Editor:

I am a computer dealer, and as such a software salesman. My own personal computer is an Apple II. Believe me, if I had had to buy every piece of software I have for the Apple, I would very likely never have become a dealer. I wasn't born with 1's and 0's for brain cells as so many computerists I know! My background is electronics. To "get up to speed" in the world of computers, I have worked my tail off through trial and error, reading what I was able to digest on the subject, but most of all running programs other people had written and observing what did and did not work. I freely admit there are many copyrighted programs in my library which I obtained through software swaps and from friends. If I were using any of these for commercial gain or was reselling them through any means, I should be locked up. The fact is that I, and every other computer acquaintance I have, uses whatever kind of quality programs available to learn more about how to write programs. Often as not, what is learned is how *not* to do something. There are some unbelievably atrocious programs out there which are advertised in your magazine and every other computer magazine. Why don't all these self-righteous people who had such a damned fit about your running the ad, get equally worked up about "programmers" asking and getting money for sheer junk?

There are some very good programs available for the Apple and, fortunately, they seem to be increasing in number. Trouble is, the advertisements look just the same whether the programs are any good or not. Since it is almost never possible to try a program before stocking it or buying it for personal use, I for one, will *never* buy a program which cannot be copied either with normal means or, at least, with a bit copier. I think anyone who spends good money for a piece of software should have the right to modify it, customize it, and put it on any number of disks he wishes. I *want* programmers to make money. I also want to own what I pay money for.

Thank you for running the ad and thank you for putting out one of the best computer magazines available today.

# MICRO IS THE APPLE SOURCE

## Coming in August!

*What's Where In the Apple*  
*An Atlas to the Apple Computer*  
by William F. Luebbert,  
Here's a 192-page update of the original, highly popular, 8-page article published by MICRO two years ago (15:36, August 1979). Prof. Luebbert has written the definitive guidebook for programmers to the hardware and firmware of the Apple II, with full details on over 2,000 memory locations.  
\$19.95

## Coming in October!

*MICRO on the Apple*  
*Volume 2*  
Edited by Ford Cavallari  
A successor to the fast-selling first volume of our new series. Volume 2 contains over 30 updated Apple articles and listings and comes with over 30 tested, ready-to-use programs — all on diskette. Book and diskette \$24.95

## Already Here!

*MICRO on the Apple*  
*Volume 1*  
Edited by Ford Cavallari  
If you don't already own this book — and its 38 programs on diskette — turn to the inside back cover of this magazine and read about why and how to become the owner!  
Book and diskette \$24.95

**MICRO**

34 Chelmsford Street  
P.O. Box 6502  
Chelmsford, MA 01824  
(617) 256-5515



# It's Time to Stop Dreaming

**Since there is apparently not going to be an enhanced version of the 6502, it is time to stop dreaming about it. The 6809 is closely related to the 6502 and has many features which make it worth considering as an improved micro.**

Robert M. Tripp  
Editor/Publisher  
MICRO

*This is the first part of a MICRO series on the 6809 microprocessor. Part I covers an overview. Here we'll focus on the "new" chip's characteristics and merits. Future articles will discuss the chip in greater detail, including how to convert 6502-based hardware and software to 6809 systems.*

A good programmer is never totally satisfied with his program. He always wonders if there are more improvements that could be made. Therefore, it is not surprising that ever since the first successful microprocessor was introduced, the 8080, computerists have been seeking improved devices. The Motorola 6800 was one direction of improvement, followed by its fairly direct descendent, the MOS Technology 6502. Even though MICRO was started to help promote the 6502 at a time when it was being virtually ignored by the microcomputer industry, we have always thought about the next generation, an improved 6502. Articles and letters in issues 23, 24, 26 and 34 of MICRO, plus numerous other material which never got into print, indicate that many of our readers are actively interested in the "dream machine," an improved microprocessor based on the 6502.

The time for dreaming has ended. There is now a microprocessor in the 6502 tradition with many of the improvements requested in the articles,

and in our own considerations. It is *not* being made by MOS Technology, Synertek or Rockwell International, the three manufacturers of the 6502. None of these companies has announced any advance development based on the 6502. However, Motorola, the inventor and primary manufacturer of the 6800, has produced a microprocessor which can be considered the 6502 dream machine. The 6809 is based conceptually on the 6800 8-bit microprocessor. But then, so was the 6502. Since 6502 manufacturers do not seem interested in producing an improved version of the 6502, we suggest that the 6809 be seriously considered as the eventual successor to the 6502. This does not mean the 6502 is in any danger of disappearing overnight. It is a firmly established product with a lot of support and is actively being used by thousands of computerists. It will be around for quite a while. But, in this business, change and improvement are the standard, not the exception.

Why should we consider the 6809? Because it is very similar to the 6502 in its architecture and in many of its principles of operation. It is as much an extension of the 6502 as of the 6800, so let's examine its main features.

## Architecture

The 6809's architecture is very similar to the 6502's. It has a 16-bit address space (64K bytes) and uses an 8-bit data bus. Its timing and control signals are almost identical to those of the 6502, so that most expansion boards will be compatible between the 6502 and the 6809 with little or no modification. Figure 1 — the registers of the 6502 and 6809 — shows the similarity between the two chips and some of the improvements in the 6809. The 6502 has one 8-bit accumulator (A) and the 6809 has two (A and B). The 6502 has two 8-bit index registers (X and Y); the 6809 has two 16-bit registers (also X and Y). The 6502 has a single stack located in page one, the

6809 has two stacks. One stack, like the 6502, services hardware requirements (interrupts, JSRs). A second stack is not affected by any hardware conditions. Each stack has a 16-bit register so that it may be located anywhere in memory, and is not limited to a single page in length.

Several of the 6809's logical improvements include:

1. 16-bit X and Y index registers (8-bit on 6502) permitting the various indexing operations to operate anywhere in memory over the full 16-bit addressing range.
2. 16-bit stack register (9-bit on 6502) permitting the stack to be anywhere in memory and to be any size. The 6502 stack can only be 256 bytes maximum and must be on page one.
3. A second 16-bit stack is available for the user and is not affected by hardware operations such as interrupts and subroutine calls. The 6502 does not have a second stack.

The 6502 has a single 8-bit accumulator. The 6809 has two 8-bit accumulators which may be used as a single 16-bit accumulator for particular 16-bit operations. These operations include add, subtract, compare, load, store, transfer between registers and exchange between registers. This 16-bit capability makes the 6809 extremely powerful without adding 16-bit data bus hardware overhead.

The 6502 has a page zero addressing mode which permits fast addressing with one byte of address for data on the zero page. The 6809 has the same type of fast addressing but permits any page of memory to be the target page (direct page). A direct page register contains the address of the page to be accessed as the direct page. Any page can be made to act like the 6502 page zero, effectively providing 256 "page zeros."

## Instruction Set Improvements

With a few minor exceptions, the 6809 has all of the instructions of the 6502. It has a number of new instructions and is more consistent and uniform in its instruction/addressing structure. A number of instructions have been added to the accumulator operations for both A and B accumulators:

1. INC/DEC — increment or decrement either accumulator.
2. One's Complement (COM) and Two's Complement (NEG).
3. Multiply A times B with the result in A and B. This is an 8-bit unsigned multiply with a 16-bit result.
4. Add and Subtract without carry or borrow, as well as the normal add and subtract with carry or borrow.
5. Exchange (EXG) or Transfer (TFR) between any 8-bit registers.
6. Clear either accumulator.

The 16-bit accumulator operations are all new, and work on the combined A and B accumulators in what is addressed as the D register. The operations include:

1. Add and Subtract 16-bit.
2. Compare to memory.
3. Load and Store 16-bits from or to memory.
4. Transfer or Exchange between any 16-bit registers: X, Y, S, U or PC.
5. Push and Pull from either the S or U stacks.

The operations available to the six 16-bit registers offer great potential in developing more efficient programs. These operations include:

1. Compare X, Y, S or U with memory.
2. Exchange or Transfer any 16-bit register with any other 16-bit register.
3. Load or Store any 16-bit register except PC.
4. Push and Pull any 16-bit register to either stack.
5. And a very useful new instruction which loads the effective address of an operation into the X, Y, S or U register.

(This new function opens up a vast number of possibilities for position-independent code and other advanced techniques.)

All of the branches provided by the 6502 are included in the 6809, as well as signed and unsigned branches, a branch to subroutine and a branch always. These branches support position-independent code (PIC) and are therefore important. There is also a branch never, which I haven't figured out a use for yet. The branches may be limited, as on the 6502, to branch forward or back about 128 locations (short) or they may be double byte addresses which permit branching to any location in memory. No more "Branch out of Range" assembly errors!

## Miscellaneous Instructions

Instead of having a number of independent operations to set or clear the condition codes as the 6502, the 6809 uses an ANDCC or ORCC to logically AND or OR the condition code register to set and clear bits. This permits any set of condition codes to be cleared or set in one instruction. The 6502 has one software interrupt (BRK) command. The 6809 has three separate software interrupts which may be used at different levels of the program and for debugging.

## Addressing Modes

Probably the most significant improvements made in the 6809 are in the addressing modes. Many of the 6502 modes have been maintained, which is not too surprising since many of them are rather fundamental: Inherent, Immediate, Absolute (16-bit address), and others. Some have been modified, such as the Relative, which was limited to 8-bit on the 6502 but which can be 8- or 16-bit on the 6809. Some of the 6502 index/indirect modes have been eliminated in their 6502 form, but most can be easily generated by the new 6809 indexed modes. The indexed address modes include:

1. Zero offset in which the 16-bit index value is used as the complete address: LDA X would load the A register with the contents of the memory address contained in the 16-bit X register.
2. Constant offset in which the 16-bit index value plus a 5-, 8- or 16-bit immediate value is used as the effective address: LDA TEST,X would add the value of TEST to the contents of X and use this as the effective address.

3. Accumulator-Offset Indexed address: LDA B,X adds the 8-bit index register to the contents of the accumulator to form the effective address: LDA B,X adds the 8-bit index register to the 16-bit X register to form the effective address.
4. Auto Increment/Decrement Indexed: This is a form of the Zero Offset, but also increments or decrements the index register one or two. This is useful for scanning tables, data, and many other operations on organized data. This mode permits the X and Y index registers to be used as additional software stacks.
5. Indexed Indirect — Most of the index modes permit a level of indirect addressing. The indexing occurs first and the effective address of the indexing operation is used to determine the location in memory which contains the final address. There is no simple Indirect Indexed as on the 6502, but this is easily accomplished by the indexing modes mentioned above.

As mentioned in the Branching instructions, relative addressing may be short (1 byte offset), as on the 6502 or long (2 byte offset). This greatly expands the capabilities of the branching instructions. Another important new addressing mode is Program Counter Relative. One of the difficulties in writing position-independent code (PIC) on the 6502 is that when the code moves, any tables or other data which move with the code lose their absolute addresses. With Program Counter Relative addressing, the addresses of the table or data are calculated relative to the current Program Counter, so that the addresses' relationship between the instruction and the table or data is preserved when they are moved together.

## 6809 Support

No matter how fantastic a microprocessor chip is, it is virtually useless without hardware and software support. The success of the 6502 has been due in part to the success of the Apple II, PET, and other 6502-based microcomputers. While the 6809 is the "new chip in town," it does have some solid initial support. Although the average MICRO reader may want to wait awhile longer before seriously considering a 6809-based system, the paragraphs below provide some insight into what is currently available.

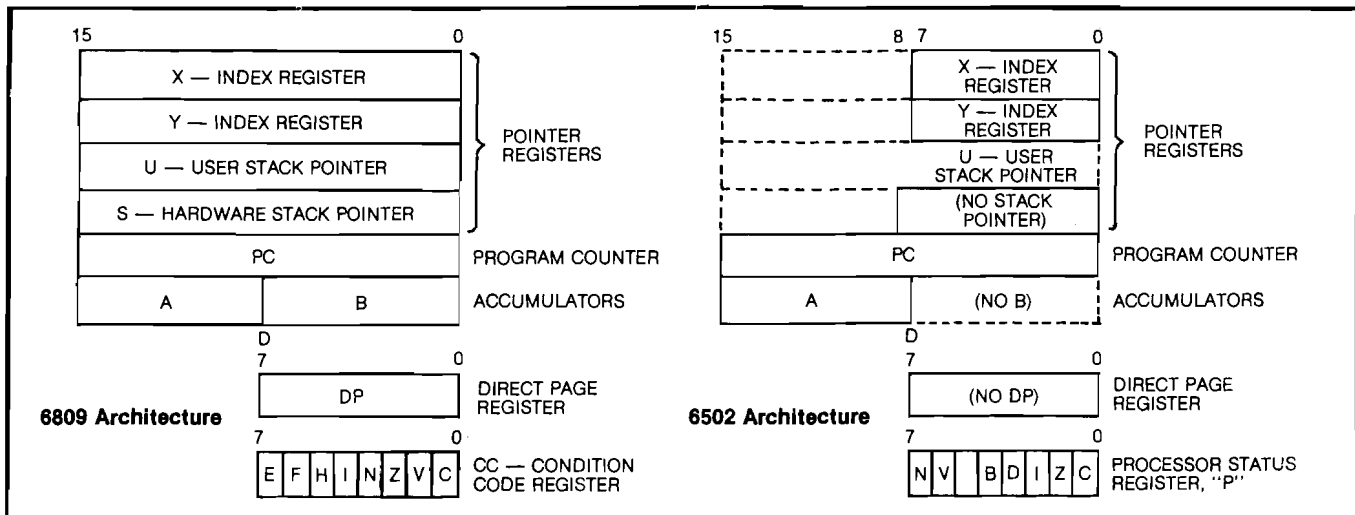

## Hardware

There are a number of hardware devices available. Two are add-ons to existing 6502-based systems. Synertek Systems has a plug-in module which converts the standard SYM-1 into a 6809-based system. It has a monitor equivalent to the 6502 version. This is perhaps the cheapest way to experiment with a 6809 system, particularly if you already own the SYM-1. Stellation Two has "THE MILL," an add-on to the Apple II which permits you to use both the Apple on-board 6502 and the additional 6809. To quote from Stellation's literature:

The 6809 runs at its rated speed of 1MHz at the same time the 6502 is running at 20% of its rated speed. This allows the 6809 to perform time-critical tasks which are being controlled by the 6502. The control program can do all the slow speed operator interaction, and may even be written in the Apple's native BASIC.

Several complete systems are currently available. Motorola has an M6809 Monoboard Microcomputer and a Micromodule 19 (M68MM19) for the EXORciser system. Canon's CX-1 is a 6809 video/floppy desktop computer with up to 96 kilobytes RAM, and supports DOS, BASIC, and has an assembler. Smoke Signal Broadcasting, long involved in the 6800, has a system — 9822 — based on the 6809. Percom Data Company offers the LFD-800. I am sure that there are other systems currently available; we will mention them in future articles as the information reaches us.

In addition to the currently available systems, there are other developments in the works. Rumor,

unconfirmed at this time, has it that the new Radio Shack color computer will be 6809-based. I saw a Hitachi 6980 color system at the West Coast Computer Faire in April. It is 6809-based (the system number may have been a typo!) and looked very sophisticated. It may be available this fall. The Computerist will be offering a board this summer which will have a floppy disk controller, IEEE-488 controller, ACIA controller, multiple VIAs, RAM, EPROM, cassette interface and a 6809 microprocessor. This may be used, with some form of terminal, as a stand-alone system, or may be used in conjunction with MICRO PLUS as a video-based 6809 system.

## Software

Although the 6809 is relatively new, it is upwardly compatible with the older 6800 at the source level, so that much of the existing 6800 software can be readily converted to run on the 6809. This means that the time required to produce support software has been considerably reduced and a fair amount is already available. Motorola offers a broad range of development and support software including BASIC-M, an interactive compiler, 6809 Cross Macro Assembler and Linking Loader, resident Pascal Interpreter and a 6809 Realtime Multitasking System.

Technical System Consultants, long a provider of 6800-based software packages offers: FLEX™ Disk Operating System for SWTPc, EXORciser and general systems; UniFLEX™ Operating System; a BASIC Precompiler; Sort/ Merge Package; BASIC and Extended BASIC; a Text Editor; Mnemonic Assembler System; Cross Assembler; Test Processing System; FLEX Utilities; a Debug Package; and FLEX Diagnostics.

Another broad support software house is Microware Systems Corporation, which has a number of offerings, including: OS-9 Operating System, BASIC09, Stylograph word processing, OS-9 Macro Text Editor, OS-9 Interactive Assembler and OS-9 Interactive Debugger. Smoke Signal Broadcasting offers, in addition to its hardware, the following software: Assembler, Pascal, Forth, COBOL, FORTRAN, and a large number of application packages including A/P, A/R, Payroll, Inventory, Medical and more. Some other companies who have been listed as vendors of 6809 software, but whose catalogs have not been received in time for this article, include: Phoenix Digital, Software Dynamics, and Softech Microsystems, Inc.

## Summary

It may be a little bit early for most MICRO readers to rush out and buy a 6809-based system, but it is definitely not too early to become aware of the relatively new 8-bit microprocessor which may well be the successor, over time, to the 6502. Readers who are active in microcomputer hardware and software development will certainly want to keep abreast of the happenings in this area. MICRO will be generating a series of articles to help readers become more aware of, and understand, the 6809. We invite and encourage anyone who has experience in using the 6809, and particularly in converting from 6502 to 6809, to consider writing about his experiences.

*Editor's note:* All companies developing 6809-based systems, or 6809-based software, are urged to send us related information to be included in a future resource list.

Last year we tested or reviewed 141 PET programs, evaluated 54 peripherals ranging from light pens to printers, and ran 27 major articles on PET programming. Our gossip columnist blew the gaffe on dozens of inside stories, receiving two death threats, five poison pen letters and a dead rat for his pains. We also published 53 letters from PET users, 88

listings, 105 programming hints, and 116 news stories about the CBM/PET.

All this added up to more than 150,000 words of essential PET information. We are PRINTOUT, the independent

magazine about the CBM/PET. Shouldn't you subscribe?

# THE TRUTH ABOUT THE PET

**\$36** buys you the ten issues of Volume 2 (1981) or the complete set of Volume 1 (1980). Simply send us a cheque, postal or money order or the number of your Barclaycard/Visa, Access, Mastercharge or Eurocard. We also accept credit card orders by telephone on 0635-201131. Sample copies of the latest issue are available at **\$5**. All prices include UK postage.

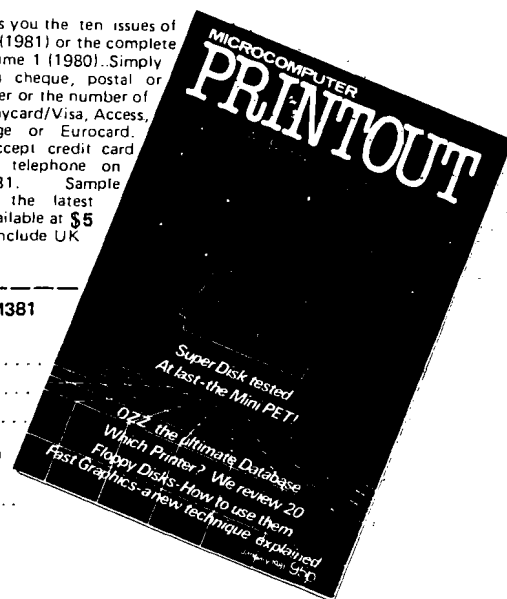

To PRINTOUT PO Box 48, Newbury, Berkshire RG16 0UJ, England. M381

My Name is .....

Address .....

..... Postcode .....

Please Enter my Subscription to :  Volume 2 (1981)  Send me the set of Vol 1 (1980)

I enclose my cheque or Postal Order OR

Debit my Access/Mastercharge/Eurocard/Barclaycard/Visa account No. ....

UK £9.50  Eire £12.50 Punts  Europe (surface) £14.50

Europe Airmail £18  USA Airmail \$45  USA (surface) \$36

Rest of World Air £25  Rest of World (surface) £14.50

Send me a sample copy  UK £1  Europe Air £1.50  USA Air \$5

Send me ... binders @  UK £3.50  Eire £4.50 Punts  Europe £5  Rest of World £7.50  USA \$19

# Programmable Character Generator for the CBM 2022 Printer

The CBM 2022 printer allows programmable characters, but the method provided is tedious. With this BASIC program, a special character can be designed on the screen. The special character codes are generated and can be stored on tape or disk in "dictionary" form for future use.

Roger C. Crites  
11880 Rio Grande  
St. Louis, MO 63138

When I purchased my CBM 2022 printer I was impressed with the availability of programmable characters. I had visions of generating reports with the special math symbols, and charts with special plotting symbols. Text would be vertically, diagonally or otherwise aligned with chart axes. I would make dot plot printer art with subtle shading. I was going to really work the devil out of that programmable character.

Well, it always takes much longer to do anything than you think it will. When the new toy syndrome wore off and I was left with the work that I had bought the printer for in the first place, my enthusiasm over the programmable character fell. It was just too tedious to stop in the middle of a job and figure out the character code needed to achieve the effect desired. After all, it's more important to get the work out, plain, but finished, than to hit the deadline with a very snazzy half job. Before long I came to completely ignore the programmable character, but I never forgot it was there.

After a time I concluded that the bottleneck in the use of this capability was mostly due to the time required to figure out the special character codes. What I needed was an extensive dictionary of all the special codes that I expected to use. If all the character codes

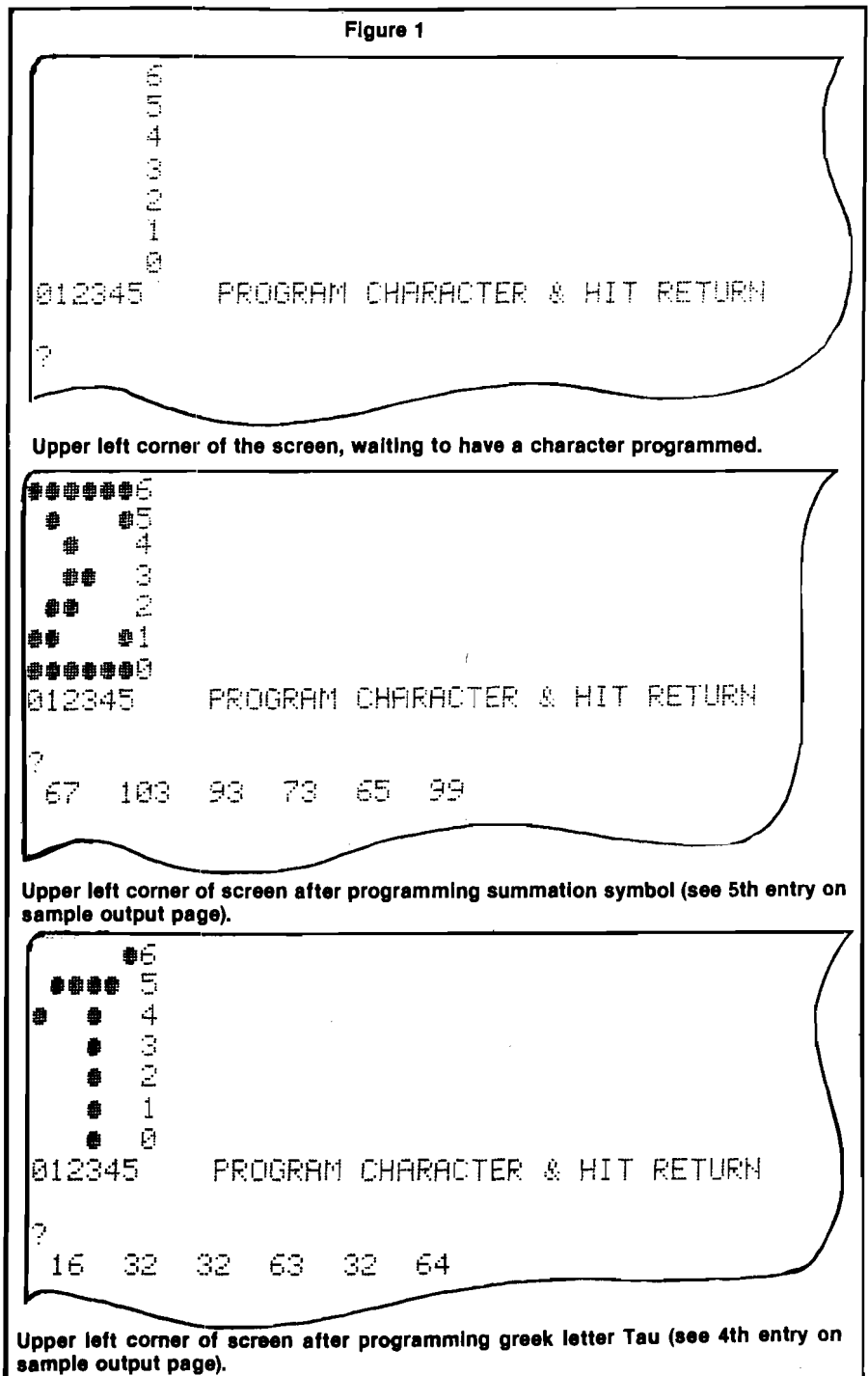

were known, they could be compiled into concise data sets—one for charts and one for text, etc. Stored on tape any "dictionary" could be merged with the current work file as a string array, PC\$(I). From there it's down hill.

If a single special character is needed in a line, the required code is invoked by writing PC\$(I) to printer secondary address 5, then inserting CHR\$(254) in the print stream where needed. If multiple special characters are needed on a line it is a little more tricky. The printer only takes one programmable character at a time. To get more than that on the same line it is necessary to use a return without line feed. This is done by breaking the print string into several components. Each component must contain only one special character. Each component is output, inserting the required special character code in the correct place. The length of the output component is determined,

the return code CHR\$(141); is appended to the component and the resulting string printed. This prints the first component containing the first special character and returns without advancing the paper. The next special character is programmed as before, the length of this component determined, and CHR\$(141); appended. Before outputting this component, however, it is necessary to prefix SPC(CL) to the output string.

CL is the sum of all previous component lengths. When this is output, the printer will space over the previous components, print the current component, and return without advancing the paper. This process is repeated until all components have been output. A blank print then advances the paper, ready for the next line. Admittedly this procedure is somewhat cumbersome, but once the necessary subroutine is worked out it can be implemented in most programs without further effort.

```

100 REM*****
110 REM***          ***
120 REM*** PROGRAMMABLE CHARACTER ***
130 REM***          ***
140 REM*** PROGRAMMER ***
150 REM***          ***
160 REM***          ***
170 REM*****
180 REM THIS PROGRAM PROGRAMS PROGRAMMABLE
190 REM CHARACTERS FOR THE CBM 2022 PRINTER
200 REM
210 OPEN 4,4:OPEN 5,4,5
220 OPEN 6,4,6:PRINT#6,CHR$(16)
230 PRINT#4,CHR$(1)+"PROGRAMMABLE CHARACTERS"+CHR$(10)+CHR$(10)
240 PRINT"J";
250 PRINT"      6"
260 PRINT"      5"
270 PRINT"      4"
280 PRINT"      3"
290 PRINT"      2"
300 PRINT"      1"
310 PRINT"      0"
320 PRINT"012345 PROGRAM CHARACTER & HIT RETURN"
330 INPUT A#
340 IF A#="END"GOTO510
350 FORI=0TO5:C(I)=0:NEXTI
360 FORI=0TO5
370 FORJ=0TO6
380 X=PEEK(32768+40*J+I)
390 IF X<>32 THEN C(I)=C(I)+2*(6-J)
400 NEXTJ
410 NEXTI
420 PRINT"XXXXXXXXXXXX";
430 FOR I=0TO5:PRINTC(I):NEXTI
440 P$=""
450 FOR I=0TO5:P$=P#+CHR$(C(I)):NEXT
460 PRINT#5,P$
470 PRINT#4,"□"
480 PRINT#4,"| "CHR$(254)" |"C(0);C(1);C(2);C(3);C(4);C(5)
490 PRINT#4,"└─┘"
500 GOTO240
510 REM** RESET PRINTER & STOP **
520 PRINT#6,CHR$(24)

```

## PROGRAMMABLE CHARACTERS

Σ	65	99	119	127	107	99
§	0	2	37	89	73	38
∧	3	4	8	24	36	67
Υ	16	32	32	63	32	64
Σ	67	103	93	73	65	99
ø	1	30	37	41	30	32
⊖	127	65	69	125	73	127
α	12	18	18	30	18	18
∂	2	2	14	18	18	14
∪	24	36	4	4	36	24
∩	28	36	36	36	36	28
∅	60	4	28	4	4	60
∴	60	4	28	4	4	4
∂	18	18	30	18	18	12
∞	24	20	20	24	20	24
∩	12	18	16	16	18	12
∅	0	28	34	42	34	28
∂	0	127	34	20	8	0
⊖	63	33	45	45	33	63
±	0	17	17	125	17	17
§	0	54	127	127	54	0
↓	4	2	127	2	4	0
←	8	28	42	8	8	8
→	8	8	8	42	28	8
↑	0	16	32	127	32	16
↖	120	96	80	72	4	2
↗	2	4	72	80	96	120
↙	15	3	5	9	16	32
↘	32	16	9	5	3	15
≈	10	20	20	10	10	20

After I had decided all this, the major task was compiling the special character "dictionary." To aid in this process I called on my PET. The result is a program to compute programmable character codes. With this program anyone (with a PET) can quickly generate a special character dictionary.

Before walking through the program, it will be helpful to review the process of programming a special character for the CBM 2022. The print head produces a 6-column by 7-row dot matrix. The rows are binary weighted starting from the bottom; i.e., 1,2,4,8,16,32,64. The dots to be turned on to form the character are chosen. Then binary weights associated with the chosen dots are summed column-by-column. The result is 6 sums, one for each column. If this is the *l*th character and *S*1, *S*2, ..., *S*6 represent the 6 column sums, then  $PC\$[l] = CHR\$(S1) + CHR\$(S2) + \dots + CHR\$(S6)$ . For a more detailed description of the process refer to the CBM 2022 printer manual.

Now for the program. Line 210 opens files to the printer. File 4 is a general print file and file 5 is the character programmer in the printer. Line 220 adjusts the line spacing and lines 230-320 print a heading on the printer and form a 6 by 7 blank matrix on the screen. Line 330 waits for an input. If the input, *A*\$ = "END", the program jumps to line 510, resets the line spacing and stops. To program a character, home the cursor. Then use the cursor controls to position the cursor, marking the dots (I use a space ball—shift Q) to form the desired special character. That is, you simply draw a picture of the desired character on the screen in the matrix outlined (see the examples). When you have completed the character, hit return.

Since *A*\$ will not be "END", the program drops through to line 350. Lines 350-410 PEEK the character drawn on the screen and calculate the column codes necessary to program the character. Lines 440-490 print out the new special character and its column codes—one more entry in the dic-

tionary. Line 500 loops back to repeat the process.

It should be pointed out that if lines 220 and 520 are omitted this program should also work for the CBM 2023.

The output (as shown for a page of random characters) is a convenient hard copy suitable for filing. Characters needed for any purpose are quickly selected from the dictionary and assembled into character string arrays as previously discussed.

With the aid of this approach to the programmable character, my printouts are finally beginning to benefit. I must admit, however, the results still fall short of my first imaginations. This may be the fault of human nature — reality seldom equals the imagination. In any case the CBM 2022 is capable of producing excellent results.

I suspect that there are others with CBM systems who would like to put the programmable character to work, but like myself have found the process too tedious to be practical. It is for them that I offer these reflections and the character generating program.

MICRO

# HERE IT IS!!!

The First Edition (April, 1981) of the  
**COMMODORE SOFTWARE ENCYCLOPEDIA**

is now available from your  
authorized COMMODORE Dealer, for ... **\$4<sup>95</sup>**

**OVER 150 PAGES! MORE THAN 500 SOFTWARE ENTRIES!**

The next edition of the COMMODORE SOFTWARE ENCYCLOPEDIA will be available in 90 to 120 days. If your software is not listed and you would like to have it listed in the next edition, please submit details to:

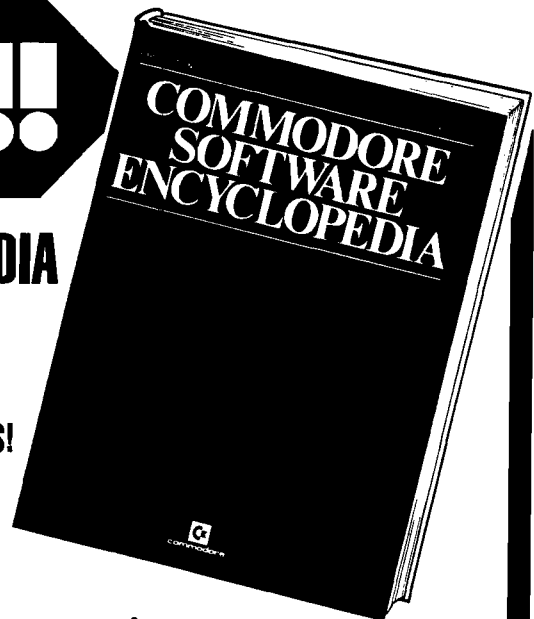

SOFTWARE DEPARTMENT  
**commodore**  
BUSINESS MACHINES, INC.  
*Computer Systems Division*  
300 Valley Forge Square, 681 Moore Road  
King of Prussia, PA 19406

Or call our  
SOFTWARE HOTLINE  
Number

**1-800-523-5622**



# The Newest In

## Apple Fun

We've taken five of our most popular programs and combined them into one tremendous package full of fun and excitement. This disk-based package now offers you these great games:

**Mimic**—How good is your memory? Here's a chance to find out! Your Apple will display a sequence of figures on a 3 x 3 grid. You must respond with the exact same sequence, within the time limit.

There are five different, increasingly difficult versions of the game, including one that will keep going indefinitely. Mimic is exciting, fast paced and challenging—fun for all!

**Air Flight Simulation**—Your mission: Take off and land your aircraft without crashing. You're flying blind—on instruments only.

A full tank of fuel gives you a maximum range of about 50 miles. The computer will constantly display updates of your air speed, compass heading and altitude. Your most important instrument is the Angle of Ascent/Bank Indicator. It tells if the plane is climbing or descending, whether banking into a right or left turn.

After you've acquired a few hours of flying time, you can try flying a course against a map or doing aerobatic maneuvers. Get a little more flight time under your belt, the sky's the limit.

**Colormaster**—Test your powers of deduction as you try to guess the secret color code in this Mastermind-type game. There are two levels of difficulty, and three options of play to vary your games. Not only can you guess the computer's color code, but it will guess yours! It can also serve as referee in a game between two human opponents. Can you make and break the color code...?

**Star Ship Attack**—Your mission is to protect our orbiting food station satellites from destruction by an enemy star ship. You must capture, destroy or drive off the attacking ship. If you fail, our planet is doomed...

**Trilogy**—This contest has its origins in the simple game of tic-tac-toe. The object of the game is to place three of your colors, in a row, into the delta-like, multi-level display. The rows may be horizontal, vertical, diagonal and wrapped around, through the "third dimension". Your Apple will be trying to do the same. You can even have your Apple play against itself!

Minimum system requirements are an Apple II or Apple II Plus computer with 32K of memory and one minidisk drive. Mimic requires Applesoft in ROM, all others run in RAM or ROM Applesoft.

Order No. 0161AD \$19.95

## Solar Energy For The Home

With the price of fossil fuels rising astronomically, solar space-heating systems are starting to become very attractive. But is solar heat cost-effective for you? This program can answer that question.

Just input this data for your home: location, size, interior details and amount of window space. It will then calculate your current heat loss and the amount of gain from any south facing windows. Then, enter the data for the contemplated solar heating installation. The program will compute the NET heating gain, the cost of conventional fuels vs. solar heat, and the calculated payback period—showing if the investment will save you money.

Solar Energy for the Home: It's a natural for architects, designers, contractors, homeowners... anyone who wants to tap the limitless energy of our sun.

Minimum system requirements are an Apple II or Apple II Plus with one disk drive and 28K of RAM. Includes AppleDOS 3.2.

Order No. 0235AD (disk-based version) \$34.95

## Math Fun

The Math Fun package uses the techniques of immediate feedback and positive reinforcement so that students can improve their math skills while playing these games:

**Hanging**—A little man is walking up the steps to the hangman's noose. But YOU can save him by answering the decimal math problems posed by the computer. Correct answers will move the man down the steps and cheat the hangman.

**Spellbinder**—You are a magician battling a computerized wizard. In order to cast death clouds, fireballs and other magic spells on him, you must correctly answer problems involving fractions.

**Whole Space**—Pilot your space craft to attack the enemy planet. Each time you give a correct answer to the whole number problems, you can move your ship or fire. But for every wrong answer, the enemy gets a chance to fire at you.

**Car Jump**—Make your stunt car jump the ramps. Each correct answer will increase the number of buses your car must jump over. These problems involve calculating the areas of different geometric figures.

**Robot Duel**—Fire your laser at the computer's robot. If you give the correct answer to problems on calculating volumes, your robot can shoot at his opponent. If you give the wrong answer, your shield power will be depleted and the computer's robot can shoot at yours.

**Sub Attack**—Practice using percentages as you maneuver your sub into the harbor. A correct answer lets you move your sub and fire at the enemy fleet.

All of these programs run in Applesoft BASIC, except Whole Space, which requires Integer BASIC.

Order No. 0160AD \$19.95

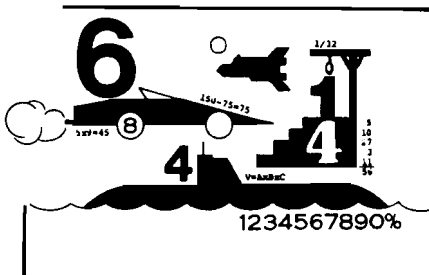

## Skybombers

Two nations, separated by The Big Green Mountain, are in mortal combat! Because of the terrain, their's is an aerial war—a war of SKYBOMBERS!

In this two-player game, you and your opponent command opposing fleets of fighter-bombers armed with bombs and missiles. Your orders? Fly over the mountain and bomb the enemy blockhouse into dust!

Flying a bombing mission over that innocent looking mountain is no milk run. The opposition's aircraft can fire missiles at you or you may even be destroyed by the bombs as they drop. Desperate pilots may even ram your plane or plunge into your blockhouse, suicidally.

Flight personnel are sometimes forced to parachute from badly damaged aircraft. As they float helplessly to earth, they become targets for enemy missiles.

The greater the damage you deal to your enemy, the higher your score, which is constantly updated at the bottom of the display screen.

The sounds of battle, from exploding bombs to the pathetic screams from wounded parachutists, remind each micro-commander of his bounden duty. Press On, SKYBOMBERS—Press On!

Minimum system requirements: An Apple II or Apple II Plus, with 32K RAM, one disk drive and game paddles.

Order No. 0271AD (disk-based version) \$19.95



## Paddle Fun

This new Apple disk package requires a steady eye and a quick hand at the game paddles! It includes:

**Invaders**—You must destroy an invading fleet of 55 flying saucers while dodging the carpet of bombs they drop. Your bomb shelters will help you—for a while. Our version of a well known arcade game! Requires Applesoft in ROM.

**Howitzer**—This is a one or two person game in which you must fire upon another howitzer position. This program is written in HIGH-RESOLUTION graphics using different terrain and wind conditions each round to make this a demanding game. The difficulty level can be altered to suit the ability of the players. Requires Applesoft in ROM.

**Space Wars**—This program has three parts: (1) Two flying saucers meet in laser combat—for two players, (2) two saucers compete to see which can shoot out the most stars—for two players, and (3) one saucer shoots the stars in order to get a higher rank—for one player only. Requires Applesoft.

**Golf**—Whether you win or lose, you're bound to have fun on our 18 hole Apple golf course. Choose your club and your direction and hope to avoid the sandtraps. Losing too many strokes in the water hazards? You can always increase your handicap. Get off the tee and onto the green with Apple Golf. Requires Applesoft.

The minimum system requirement for this package is an Apple II or Apple II Plus computer with 32K of memory and one minidisk drive.

Order No. 0163AD \$19.95

# Instant Software™

\* A trademark of Apple Computer Inc.

PETERBOROUGH, N.H. 03458  
603-924-7296



# Apple\* Software

## From Instant Software

### Santa Paravia and Fiumaccio

*Buon giorno, signore!*

Welcome to the province of Santa Paravia. As your steward, I hope you will enjoy your reign here. I feel sure that you will find it, shall we say, profitable.

Perhaps I should acquaint you with our little domain. It is not a wealthy area, signore, but riches and glory are possible for one who is aware of political realities. These realities include your serfs. They constantly request more food from your grain reserves, grain that could be sold instead for gold florins. And should your justice become a trifle harsh, they will flee to other lands.

Yet another concern is the weather. If it is good, so is the harvest. But the rats may eat much of our surplus and we have had years of drought when famine threatened our population.

Certainly, the administration of a growing city-state will require tax revenues. And where better to gather such funds than the local marketplaces and mills? You may find it necessary to increase custom duties or tax the incomes of the merchants and nobles. Whatever you do, there will be far-reaching consequences... and, perhaps, an elevation of your noble title.

Your standing will surely be enhanced by building a new palace or a magnificent *cattedrale*. You will do well to increase your landholdings, if you also equip a few units of soldiers. There is, alas, no small need for soldiery here, for the unscrupulous Baron Peppone may invade you at any time.

To measure your progress, the official cartographer will draw you a *mappa*. From



it, you can see how much land you hold, how much of it is under the plow and how adequate your defenses are. We are unique in that here, the map IS the territory.

I trust that I have been of help, signore. I look forward to the day when I may address you as His Royal Highness, King of Santa Paravia. *Buona fortuna* or, as you say, "Good luck". For the Apple 48K.

Order No. 0174A \$9.95 (cassette version).

Order No. 0229AD \$19.95 (disk version).

**TO ORDER** SEE YOUR LOCAL INSTANT SOFTWARE DEALER OR USE THE ORDER FORM BELOW

For Fast Service

*call now*

Toll-Free  
1-800-258-5473

### Apple Cassettes

0018A Golf.....	\$7.95
0025A Mimic.....	\$7.95
0040A Bowling/Trilogy.....	\$7.95
0073A Math Tutor I.....	\$7.95
0079A Oil Tycoon.....	\$9.95
0080A Sahara Warriors.....	\$7.95
0088A Accounting Assistant.....	\$7.95
0094A Mortgage w/Prepayment Option/ Financier.....	\$7.95
0096A Space Wars.....	\$7.95
0098A Math Tutor II.....	\$7.95
0174A Santa Paravia and Fiumaccio.....	\$9.95
0148A Air Flight Simulation.....	\$9.95

### We Guarantee It!

**Instant Software  
Guarantee**

OUR PROGRAMS ARE GUARANTEED TO BE QUALITY PRODUCTS. IF NOT COMPLETELY SATISFIED YOU MAY RETURN THE PROGRAM WITHIN 60 DAYS. A CREDIT OR REPLACEMENT WILL BE WILLINGLY GIVEN FOR ANY REASON.

109

Name \_\_\_\_\_

Address \_\_\_\_\_

City \_\_\_\_\_ State \_\_\_\_\_ Zip \_\_\_\_\_

Check     Money Order     VISA     AMEX     Master Charge

Card No. \_\_\_\_\_ Exp. Date \_\_\_\_\_

Signed \_\_\_\_\_ Date \_\_\_\_\_

**Order your Instant Software today!**

Quantity	Order No.	Program name	Unit cost	Total cost
Shipping and handling				\$1.00
Total order				

**Instant Software Inc.**

Peterborough, N.H. 03458

# MICRO Club Circuit

Mike Rowe  
Club Circuit  
P.O. Box 6502  
Chelmsford, MA 01824

*The following club announcements are presented in zip code order.*

## Capital Area PET Enthusiasts (CAPE)

This group meets at the Patrick Henry Library, Route 123, in Vienna, Virginia, on the second Saturday of each month at 1:30 p.m. Robert C. Karpen is president, and membership now totals 40. The group's purpose is to exchange views, experiences and programs, and to discuss problems. For additional information, please write to:

CAPE  
2054 Eakins St.  
Reston, Virginia 22091

## Basically Ohio Scientific Systems (B.O.S.S.)

This recently-formed club meets on the first Tuesday of each month at Sarasota Junior High School at 7:30 p.m. Its objectives include information sharing through the club's library, and demonstrations. B.O.S.S. is open to all current or prospective OSI owners. Dues are \$12.00 per year. Area OSI owners interested in membership, and clubs interested in newsletter exchanges contact:

B.O.S.S.  
P.O. Box 3695  
Sarasota, Florida 33578

## Rockford Area PET Users

Tom Storm is president of this 50-member group. It meets on the second Thursday of each month at 7:00 p.m. at Rock Valley College. The group's purpose is the general exchange of ideas on programming for the PET. If interested, please contact:

Mark J. Niggemann  
912 St. Andrew's Way  
Rockford, Illinois 61107

## Sorbus Komputer Club (O.K.C.)

The purpose of this group is to help members learn programming techniques. Charles Olson is president and meetings are held every Thursday. For additional information contact:

Jim Johannes  
1411 Classen Blvd.  
Suite 348  
Oklahoma City, OK 73106

## New Braunfels 6502 Club

Informal meetings are held on the 4th Tuesday of each month at members' homes. David Sarkozi is the president, and membership stands at 15. The purpose of this club is to trade software and hardware ideas and to assist members having problems with either. For additional information, please contact:

David Sarkozi  
171 Louisiana  
New Braunfels, TX 78130

## Bay Area Atari Users Group

Membership of this group now stands at 120, and Clyde H. Spencer is president. The group meets on the first Monday of each month at Foothill College. Newsletter is \$12/year, and the aim of the group is to share and disseminate information about the Atari personal computer. For information write c/o:

Foothill College  
12345 El Monte Road  
Los Altos Hills, California 94022

## Forth Interest Group

Meets on the fourth Saturday at Noon. Membership is over 1200. The club puts out a publication called "Forth Dimensions." for more information, contact:

Roy Martens, Publisher  
FORTH Interest Group  
P.O. Box 1105  
San Carlos, CA 94070  
(415) 962-8653

## Santa Cruz Apple Users' Group

Jim McCaig is president of the Santa Cruz Apple Users' Group. The group's 15 members meet every 2nd Sunday in Felton. Its purpose is to lend programming assistance and to aid beginners. For additional information contact:

"Jay" Schaffer, Secretary  
345-32nd Avenue  
Santa Cruz, California 95062

## Ohio Scientific Users Group North

This group, begun in 1979, now has members. They meet on the second day of each month at 7:30 p.m. at Data Systems Plaza. Mike Mahon is president, and the group's goal is to share information and ideas about computers and to publish a newsletter. If interested, please contact:

Valerie J. Mahoney  
P.O. Box 14082  
Portland, Oregon 97214

## Niagra Region '6502' Micro Users

This group's purposes are to build a software library that members can draw from, conducting presentations on 6502 micros and their aspects, and publishing the club Newsletter called '6502'. Meetings include demonstrations, seminars, workshops, lecturing, sharing ideas and programs. Meetings are held at the College of Education, Catharines, Ontario. For more information, contact:

Dr. R. Crane  
College of Education  
St. Catharines, Ontario L2S  
(416) 684-7201 ext. 433

## British Apple Systems User Group

This newly-formed group already has over 300 members. They meet weekly, just north of London, and publish a bi-monthly newsletter, as well as software disks. Martin Perrett is the Club's secretary. For more information, please contact him:

c/o British Apple Systems  
User Group  
P.O. Box 174  
Watford, WD2 6NF  
England

## PET Users in West Lancashire

This group meets on the third Tuesday of each month at 7 p.m. at Arnold School in Blackpool. The group has 32 members, with David Jowett serving as president. For more information, contact:

David Jowett  
PET Users in West Lancashire  
197 Victoria Road East  
Thornton, Blackpool  
FY5 3ST England

*MICRO offers a free one year subscription to all clubs registered with us. If you are interested, please write to:*

*MICRO Club Circuit  
Box 6502  
Chelmsford, MA 01824*

# Musical Duets on the Apple II

**Music generated by the Apple II, without extra firmware, is usually limited to one voice. Here are two Applesoft programs which, with the help of an ordinary amplifier, add a new dimension to Apple music — harmony.**

Rick Brown  
8903 Nogal Ave.  
Whittier, California 90606

Anyone who has ever done any serious game-playing on the Apple II surely realizes how a catchy tune played through the Apple's speaker can enhance a program. A short machine language program is all that is needed to generate notes with a wide range of frequencies and durations. Such a tone-generating program is very nice, but it has the drawback of generating only one voice, which is to say, only one note at any given time can be played through the speaker. The usual way to acquire extra voices is to open the piggy bank and buy a music board or some other peripheral device designed for synthesizing music. For the serious music lover, it may be that nothing less will do. But can anything be done to satisfy the rest of us, whose standards (or finances) may not be as high? I chose to try to add, through software, a second voice to the Apple.

Now, before we go further, a little information about how a tone-generating program works is in order. The assembly language instruction LDA \$C030 will toggle the Apple's speaker once every time it is executed, resulting in a little "click." Any sound whatsoever coming from the speaker is nothing but a series of such clicks, and the nature of the sound depends only on the interval of time between one click and the next. In the simplest case, this time interval is constant, and a

steady, single-frequency, "pure" tone is generated. One convenient way to control the length of the pause between clicks is to use a "do-nothing" loop in the program, which generates a pause that is proportional to the number of times the loop is executed. The longer the pause between clicks, the lower the frequency of the resultant tone.

It occurred to me that it might be possible, by interleaving two such "do-nothing" loops, to superimpose one tone upon another and thus create the Apple's second voice. Consider two tones, one with a frequency of 500 Hz, and the other with a frequency of 300 Hz. To generate the first, we make the speaker click at intervals of 0.002s (s = seconds); that is, at these instants: 0.000s, 0.002s, 0.004s, 0.008s, 0.010s, etc.

Similarly, the 300 Hz tone would click at these instants: 0.0000s, 0.0033s, 0.0067s, 0.0100s, etc. Now, to generate both tones simultaneously, we should (it would seem) click the speaker at these instants: 0s, 0.002s, 0.0033s, 0.004s, 0.0067s, 0.008s, 0.01s, and so on. The problem of the two tones "clicking" at the same instant (e.g., at 0s and at 0.01s) is taken care of by a sort of "phase shift" inherent in the way the two "do-nothing" loops are interleaved.

Well, it all looks good on paper, and it might even work, were we using sinusoidally varying pulses instead of instantaneous clicks. But in fact, what results from the above technique is one of the most awful noises I've ever heard coming from the Apple speaker.

## A More Promising Technique

All is not lost. There is another assembly language instruction, LDA \$C020, which toggles not the speaker, but the cassette output. This produces a "click" on a cassette recording, or, if the output jack is connected to an

amplifier, an audible click is produced. This is the secret to the second voice. There are several ways to amplify the signal. Perhaps the simplest is to plug an external speaker into your cassette recorder, and set the recorder in the "record" mode. Then, any input to the microphone jack will be amplified through the external speaker. Alternatively, you could patch from the cassette output jack to the computer to the auxiliary input of a stereo set. This method will probably give you more control over volume and tone. Now, by clicking the Apple speaker at a fixed interval, and clicking the alternate speaker at a different fixed interval, we can produce two distinct simultaneous tones. The Apple now harmonizes with itself!

## Making Music

The core of the programs presented here is a machine language routine which generates two simultaneous notes of different pitches (P1 and P2), and different durations (D1 and D2). These notes are stored in two tables: one contains the melody and the other contains the harmony. After a note (either melody or harmony) is completed, the routine fetches the next pitch and duration from the appropriate table, and plays the next note. When a duration of zero is encountered in either table, the song is considered to be complete, and the machine language routine terminates. A listing of this routine is given in figure 1.

For each note, the pitch and duration take up one byte apiece. Thus there are 256 variations of pitch, and 255 possible durations (recall that a duration of zero will end the song). The value of P (the pitch) is proportional to the time delay between two successive "clicks" of the speaker, so that the highest values of P will produce the lowest notes. Because of this, P should be considered proportional to the wavelength, rather than to the frequency, of the note.

Although we have 256 wavelengths to choose from; most of them produce notes which are "between the keys of a piano." In other words, in order to make use of the isotonic scale to which we are accustomed, and in which music is commonly written, we must use only twelve notes per octave, and discard those values of P which produce non-isotonic notes. The range of 256 wavelengths available to us covers exactly eight octaves, and so the maximum number of isotonic notes we can use is  $8 \times 12$ , or 96. (In practice, the number is limited still further, as explained below.)

The ratio of wavelengths of two consecutive notes on the isotonic scale is a constant  $2^{1/12}$ , or about 1.059, so that the ratio of wavelengths of two notes an octave apart is always 2:1. Thus wavelengths 128 and 64 are an octave apart, as are wavelengths 20 and 10, 2 and 1, and so forth. This fact imposes an obvious limitation on the higher notes.

Suppose we have a very high note—say of wavelength 4. The note one octave higher, then, has a wavelength of 2. Now, since the program uses only integers to represent wavelengths, it cannot generate the 11 isotonic notes between these two wavelengths (in fact, it can only generate one, corresponding to wavelength 3).

Another problem arising out of the use of integers for wavelengths is that the higher notes have an unavoidable tendency to go off-key. Suppose that the exact isotonic wavelength of a particular note (a low note, in this example) is calculated to be 154.43 on a scale from 1 to 256. This is rounded off to 154, creating a relative error of 0.29%. Consider now, a much higher note, whose exact wavelength is 15.43. This is rounded to 15, causing a much higher relative error of 2.8%, and it is this relative error (rather than the absolute error), which is detected by the ear.

Taking into account the limitations discussed earlier, I designed the program to use the lowest 65 isotonic notes available, covering a little more than five octaves, and using wavelengths from 6 to 256 (the latter wavelength is represented by zero in the routine). The highest notes are still a bit off-key, but generally they are rarely used and so won't create much of a problem. As far as the durations of the notes are concerned, they remain, as far as the ear can tell, faithfully proportional to their numerical values, throughout the range from 1 to 255.

Figure 1: The Two-Tone Generating Routine.

```

0800 ;*****
0800 ;*
0800 ;* TWO-TONE GENERATING ROUTINE *
0800 ;*
0800 ;* BY RICK BROWN *
0800 ;*
0800 ;*****
0800 ;*
0800 INDX1L EPZ $06
0800 INDX1H EPZ $07
0800 INDX2L EPZ $08
0800 INDX2H EPZ $09
0800 ;
0800 I EQU $300
0800 P1 EQU $301
0800 D1 EQU $302
0800 P2 EQU $303
0800 D2 EQU $304
0800 I1L EQU $305
0800 I1H EQU $306
0800 I2L EQU $307
0800 I2H EQU $308
0800 ;
0309 ; ORG $309
0309 OBJ $800
0709 ;
0309 AD0503 LDA I1L ;INITIALIZE
030C 8506 STA INDX1L ;POINTERS
030E AD0603 LDA I1H ;TO
0311 8507 STA INDX1H ;BEGINNING
0313 AD0703 LDA I2L ;ADDRESSES
0316 8508 STA INDX2L ;OF
0318 AD0803 LDA I2H ;NOTE
031B 8509 STA INDX2H ;TABLES
031D A900 LDA #$00
031F 8D0003 STA I
0322 206003 JSR READ1 ;FETCH FIRST NOTE OF MELODY
0325 208403 JSR READ2 ;FETCH FIRST NOTE OF HARMONY
0328 CA LBL1 DEX
0329 F007 BEQ TONE1
032B EA NOP ;THESE TWO INSTRUCTIONS CAUSE
032C AD1111 LDA $1111 ;A 6-CYCLE TIME DELAY
032F 4C3803 JMP LBL2
0332 ;
0332 AD30C0 TONE1 LDA $C030 ;CLICK SPEAKER AFTER P1 LOOPS
0335 AE0103 LDX P1 ;RESET X-REGISTER
0338 88 LBL2 DEY
0339 F007 BEQ TONE2
033B EA NOP ;THESE TWO INSTRUCTIONS CAUSE
033C AD1111 LDA $1111 ;A 6-CYCLE TIME DELAY
033F 4C4803 JMP LBL3
0342 ;
0342 AD20C0 TONE2 LDA $C020 ;CLICK SPEAKER AFTER P2 LOOPS
0345 AC0303 LDY P2 ;RESET Y-REGISTER
0348 CE0003 LBL3 DEC I ;AFTER 256 LOOPS,CHECK FOR END OF NOTE
034B D0DB BNE LBL1
034D CE0203 DEC D1 ;END OF MELODY NOTE?
0350 D003 BNE LBL4 ;NO, CHECK HARMONY NOTE
0352 206003 JSR READ1 ;YES, FETCH NEXT NOTE OF MELODY
0355 CE0403 LBL4 DEC D2 ;END OF HARMONY NOTE?
0358 D0CE BNE LBL1 ;NO, LOOP AGAIN
035A 208403 JSR READ2 ;YES, FETCH NEXT NOTE OF HARMONY
035D 4C2803 JMP LBL1 ;THEN LOOP AGAIN
0360 ;
0360 A200 READ1 LDX #$00
0362 A506 LDA INDX1L
0364 D002 BNE LBL5
0366 C607 DEC INDX1H
0368 C606 LBL5 DEC INDX1L
036A A106 LDA (INDX1L,X)
036C 8D0103 STA P1
036F A506 LDA INDX1L
0371 D002 BNE LBL6
0373 C607 DEC INDX1H
0375 C606 LBL6 DEC INDX1L
0377 A106 LDA (INDX1L,X)
0379 8D0203 STA D1 ;DURATION OF MELODY NOTE
037C D002 BNE LBL7
037E 68 PLA ;IF D1=0, POP RETURN ADDRESS
037F 68 PLA ;OFF STACK, SO RTS WILL END PROGRAM
0380 AE0103 LBL7 LDX P1
0383 60 RTS
0384 ;
0384 A000 READ2 LDY #$00
0386 A508 LDA INDX2L
0388 D002 BNE LBL8
038A C609 DEC INDX2H
038C C608 LBL8 DEC INDX2L
038E B108 LDA (INDX2L),Y
0390 8D0303 STA P2 ;PITCH (WAVELENGTH) OF HARMONY NOTE
0393 A508 LDA INDX2L
0395 D002 BNE LBL9
0397 C609 DEC INDX2H
0399 C608 LBL9 DEC INDX2L
039B B108 LDA (INDX2L),Y
039D 8D0403 STA D2 ;DURATION OF HARMONY NOTE
03A0 D002 BNE LBL10
03A2 68 PLA ;IF D2=0, POP RETURN ADDRESS
03A3 68 PLA ;OFF STACK, SO RTS WILL END PROGRAM
03A4 AC0303 LBL10 LDY P2
03A7 60 RTS

```

## The Programs

Two programs are presented here, either of which can be used to play duets. However, the main purpose of the first program is to assemble the note tables from the data input by the user and to save the song on tape, while the second program is used only to load and play previously-recorded songs.

### The Note-Table Assembler Program

This program provides an easy way to input a song, listen to it, edit it according to taste, and finally to save it on tape for later use. The song is input to the program through the use of DATA statements, which are typed in by the user each time the program is run. All such DATA statements must have line numbers greater than 690. The elements in these DATA statements will indicate the key signature (if any), the name and relative duration of each note, and the end of each part (melody or harmony) of the song. In order to facilitate the entry of these data, the notes are called by their alphabetic names (A,B,C,D,E,F,G) and

converted by the program to the appropriate numerical values. The key signature, by default, determines whether a given note is to be played sharp, flat, or natural, but the signature may be overridden by appending the character "#" (sharp), "&" (flat), or "N" (natural) to the note's name.

Notes of different octaves are indicated by a single digit appended to the note name. If no such digit appears, octave 0 (zero) is assumed (this is the lowest octave which can be notated). Thus, G3 is one octave above G2, and D#1 is one octave above D#. The lowest letter-name within an octave is A, and the highest is G. Thus A2 is just a little above G1, while G#4 and A&5 designate the same note. A detailed description of the formats of the data elements is given below:

1. **Key Signature (optional):** If the music is written in a key other than C, the first two data elements should indicate the key signature. The first element should consist of the word "SHARP" or "FLAT", and the second element should be a string consisting of the letter names (in

any order) of the notes to be sharped or flatted. Example:

```
730 DATA FLAT,ADBE
```

2. **Note Names:** Each note name is an alphanumeric data item of the form XYM, where:

X is one of the letters A, B, C, D, E, F, G, or R (rest)...

Y is an optional character indicating sharp (#), flat (&), or natural (N). Any of these characters will override the key signature...

M is a number from 0 to 9, indicating which octave the note belongs to. (However, the range within one song is limited to 65 notes, or about 5½ octaves.) M can be omitted if it equals zero.

If X equals "R", then Y and M are omitted. Each note name must be followed by its note-duration.

3. **Note Duration:** This is a numerical quantity indicating the relative duration of the note that precedes it (the absolute duration will be calculated later). For example, if a

Figure 2: "Blue Bells of Scotland"

```
800 DATA G,1
801 DATA C1,2,B1,1,A1,1
802 DATA G,2,A1,1,B1,.5,C1,.5
803 DATA E,1,E,1,F,1,D,1
804 DATA C,3,G,1
805 DATA C1,2,B1,1,A1,1
806 DATA G,2,A1,1,B1,.5,C1,.5
807 DATA E,1,E,1,F,1,D,1
808 DATA C,3,G,1
809 DATA E,1,C,1,E,1,G,1
810 DATA C1,2,A1,1,B1,.5,C1,.5
811 DATA B1,1,G,1,A1,1,F#,1
812 DATA G,2,A1,1,B1,1
813 DATA C1,2,B1,1,A1,1
814 DATA G,2,A1,1,B1,.5,C1,.5
815 DATA E,1,E,1,F,1,D,1
816 DATA C,3
817 DATA ENDL
900 DATA R,1
901 DATA R,1,E,1,F,1,F,1
902 DATA E,2,F,2
903 DATA G,1,C,1,D,1,F,1
904 DATA E,3,R,1
905 DATA R,1,E,1,F,1,F,1
906 DATA E,2,F,2
907 DATA G,1,C,1,D,1,F,1
908 DATA E,3,R,1
909 DATA C1,3,D1,1
910 DATA A1,2,F,1,G,.5,A1,.5
911 DATA D1,2,C1,2
912 DATA B1,1,D1,1,G,1,F,1
913 DATA E,2,F,1,F,1
914 DATA E,2,F,1,F,1
915 DATA G,1,C,1,D,1,F,1
916 DATA E,3
917 DATA ENDL
```

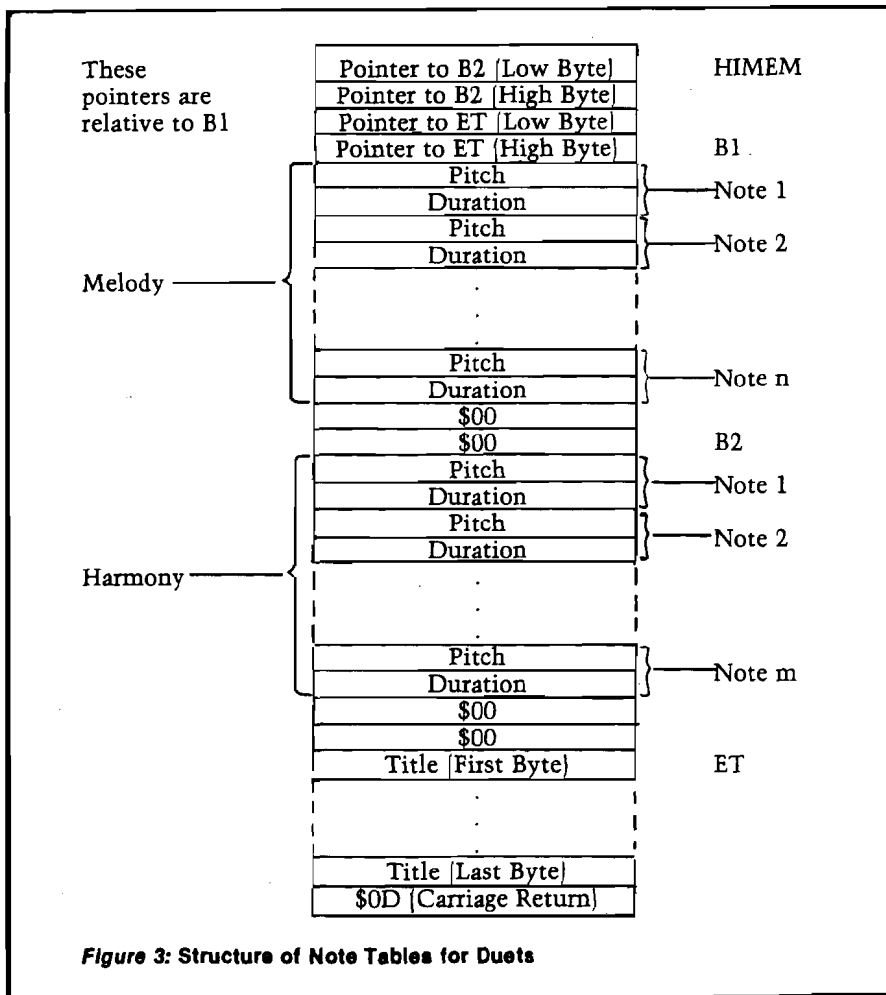

Figure 3: Structure of Note Tables for Duets

quarter-note is given a duration of 1, then a half-note would have a duration of 2, etc. Example:

740 DATA F1,.5,F#1,1,R,2,BN,1.5

4. *END1*: In a duet, the data element "END1" must follow the last note duration of the first part (melody) of the song.
5. *Second Part*: Note names and durations for the second part (harmony) of the song must follow "END1", in the format indicated in 2 and 3. The key signature (if any) is still in effect and should not be repeated here.
6. *END2*: The data element "END2" must follow the last note duration of the second part (harmony) of the song.

The above format applies to duets. There is also an option for entering and playing 1-part solos. To do this, enter key signature, note names and note durations for one part, as described above, but following the last note duration, enter the string "ENDSOLO" as the last data element. This will cause the same tune to be played through both speakers.

### Running the Program

Before running the program as shown, you may find it necessary to change the value of M in line 10. HIMEM will be set to this value, which will be the highest byte occupied by the note tables, plus 1. The value shown in the listing is for a 32K system without DOS. Modify line 10 if necessary, then save the program on tape as shown (without any DATA statements).

Now, each time you load the program, type in the DATA statements according to the format explained above, remembering to give them line numbers higher than 690. Caution: for alphanumeric data, trailing blanks are considered to be part of the string, and may cause the data to be misinterpreted by the program. Avoid trailing blanks!

After all the necessary DATA statements have been entered, type "RUN". In a few seconds, you will see the prompt "TEMPO,KEY?" The tempo you input will be proportional to the length of the song, so that higher values will actually produce slower music. Notice that this is opposite from the usual interpretation of tempo. The tempo is multiplied by the relative note duration obtained from the DATA statement, the product is rounded to

MESSAGE	PROBABLE CAUSE
ILLEGAL QUANTITY ERROR	Tempo 0
BAD SUBSCRIPT ERROR	Illegal note name in DATA statement
OUT OF DATA ERROR	No "END2", or no "ENDSOLO"
SYNTAX ERROR	Bad DATA statement format; data type mismatch
ERROR: KEY IS TOO HIGH	Key would cause notes to be outside of allowable range
ERROR: KEY IS TOO LOW	
ERROR: TEMPO IS TOO LONG	Tempo * Relative Duration 25: for some note
ERROR: INSUFFICIENT MEMORY FOR NOTE TABLES	DATA statements plus note table take up too much memory
WARNING: PART X IS XXX UNITS SHORTER THAN PART X. SONG WILL END EARLY.	The sums of the durations obtained from the DATA statements do not match. Song will play up to the end of the shorter part.
WARNING: DURATIONS OF SOME NOTES WERE ROUNDED TO THE NEAREST INTEGER. TUNES MAY NOT BE SYNCHRONIZED.	Tempo * Relative Duration does not equal an integer for some note(s).

Table 1: Error/Warning Messages

```

0 REM      NOTE-TABLE ASSEMBLER
1 REM
2 REM
10 M = 32768: REM  M = SYSTEM'S CAPACITY
20 B1 = M - 4: HIMEM: M
30 DIM N%(65),P%(7)
40 DEF FN HI(X) = INT (X / 256)
50 DEF FN LO(X) = X - FN HI(X) * 256
55 REM  LOAD MACHINE LANGUAGE PROGRAM
60 P$ = "1730050031330061730060031330071730070031330081730080031330091690
0014100003032096003032132003202240007234173017017076056003173048192
174001003136240007234173017017"
70 FOR I = 777 TO 830: POKE I, VAL ( MID$( P$,3 * (I - 777) + 1,3)): NEX

80 P$ = "0760720031730321921720030032060000032082192060020032080030320960
03206004003208206032132003076040003162000165006208002198007198006161
006141001003165006208002198"
90 FOR I = 831 TO 883: POKE I, VAL ( MID$( P$,3 * (I - 831) + 1,3)): NEX

93 P$ = "0071980061610061410020032080021041041740010030961600001650082080
02198009198008177008141003003165008208002198009198008177008141004003
208002104104172003003096"
95 FOR I = 884 TO 935: POKE I, VAL ( MID$( P$,3 * (I - 884) + 1,3)): NEX

115 P$ = ""
120 N%(0) = 1:N%(1) = 0
125 REM  SET ISOTONIC WAVELENGTHS
130 FOR I = 2 TO 65
140 N%(I) = 256 / (2 ^ ((I - 1) / 12)) + .5
150 NEXT I
153 REM  ABCDEFG

```

```

155 P%(1) = 0:P%(2) = 2:P%(3) = 3:P%(4) = 5
156 P%(5) = 7:P%(6) = 8:P%(7) = 10
160 E = M - FRE (0) + 200: HIMEM: E
170 B$ = CHR$(7) + "ERROR: "
180 RESTORE : INPUT "TEMPO,KEY? ";TM,K:L = 0:F1 = 0
190 READ P$: IF P$ = "SHARP" OR P$ = "FLAT" THEN 680
200 RESTORE :LN = 0
210 FOR I = B1 - 1 TO E STEP - 2
220 READ P$: IF LEFT$(P$,3) = "END" THEN 370
230 IF P$ = "R" THEN P = 0: GOTO 330
240 P = P%(ASC C(P$) - 64) + 12 * VAL ( RIGHT$(P$,1)) + K
250 A$ = MID$(P$,2,1)
255 IF A$ = "N" THEN 310
260 IF A$ = "#" THEN P = P + 1: GOTO 310
270 IF A$ = "&" THEN P = P - 1: GOTO 310
280 IF LN = 0 THEN 310
290 FOR J = 1 TO LN
295 IF MID$(SF$,J,1) = LEFT$(P$,1) THEN P = P + Q: GOTO 310
300 NEXT
310 IF P < 1 THEN PRINT B$;"KEY IS TOO LOW": GOTO 180
320 IF P > 65 THEN PRINT B$;"KEY IS TOO HIGH": GOTO 180
330 READ DD:L = L + DD:DD = DD * TM:D = INT (DD + .5)
340 IF D > 255 THEN PRINT B$;"TEMPO IS TOO LONG": GOTO 180
350 IF D < > DD THEN F1 = 1
355 REM POKE PITCH,DURATION INTO NOTE TABLE
360 POKE I,N%(P): POKE I - 1,D: GOTO 390
370 POKE I,0: POKE I - 1,0
375 IF LEFT$(P$,7) = "ENDSOLO" THEN B2 = B1:ET = I - 2:L2 = L1: GOTO 4
00
380 IF LEFT$(P$,4) = "END2" THEN ET = I - 2:L2 = L - L1: GOTO 400
385 B2 = I - 1:L1 = L
390 NEXT I: PRINT B$;"INSUFFICIENT MEMORY": PRINT "FOR NOTE TABLE S": HIM
EM:
M: END
400 POKE M - 1, FN LO(B1 - B2): POKE M - 2, FN HI(B1 - B2)
405 POKE M - 3, FN LO(B1 - ET): POKE M - 4, FN HI(B1 - ET)
410 IF L1 < > L2 THEN SH = .5 * (3 - SGN (L2 - L1)): PRINT "WA
RNING: PART ";SH;" IS "; ABS (L1 - L2);" UNITS SHORTER": PRINT "THAN
PART ";3 - SH;". SONG WILL END EARLY."
420 IF F1 THEN PRINT : PRINT "WARNING: DURATIONS OF SOME NOTES WERE": PRI
NT
"ROUNDED TO THE NEAREST INTEGER. TUNES": PRINT "MAY NOT BE SYNCHRONI
ZED."
430 POKE 773, FN LO(B1): POKE 774, FN HI(B1)
440 POKE 775, FN LO(B2): POKE 776, FN HI(B2)
450 PRINT : INPUT COM$
460 IF COM$ < > "GO" THEN 500
470 INPUT "REPETITIONS? ";R
480 FOR I = 1 TO R
490 CALL 777: NEXT I: GOTO 450
500 IF COM$ = "CHANGE" THEN 180
510 IF COM$ = "EDIT" THEN HIMEM: M: LIST 691,: END
520 IF COM$ < > "SAVE" THEN PRINT "WHAT?": GOTO 450
530 J = ET - E: IF J > 255 THEN J = 255
535 PRINT "TITLE(1-";J;" CHARACTERS):"
540 FOR I = ET TO ET - J STEP - 1
550 GET P$: IF P$ = CHR$(8) THEN I = I + 1: PRINT " "; CHR$(8); CHR$(
8);: GOTO 550
555 IF P$ = CHR$(21) THEN 550
557 IF P$ = CHR$(24) THEN PRINT CHR$(92): GOTO 535
560 PRINT P$;: POKE I, ASC (P$): IF P$ = CHR$(13) THEN 580
570 NEXT I: PRINT : PRINT B$;"TITLE TOO LONG": GOTO 530
580 HOME : PRINT
590 PRINT "AFTER ADJUSTING VOLUME, PRESS 'RECORD',"
600 PRINT "THEN HIT ANY KEY.": GET P$
610 HOME : VTAB 12: FLASH : HTAB 12: PRINT "<<RECORDING>>": NORMAL
615 REM ADDRESS -307 IS MONITOR WRITE ROUTINE:
620 REM LOCATIONS 60-63 POINT TO BEGINNING
625 REM AND ENDING ADDRESS OF WRITE.
630 POKE 6, FN LO(M - 1 - I): POKE 7, FN HI(M - 1 - I)
640 POKE 60,6: POKE 61,0: POKE 62,7: POKE 63,0: CALL - 307
650 POKE 60, FN LO(I): POKE 61, FN HI(I)
660 POKE 62, FN LO(M - 1): POKE 63, FN HI(M - 1): CALL - 307
670 HOME : GOTO 450
680 Q = 1: IF P$ = "FLAT" THEN Q = - 1
690 READ SF$:LN = LEN (SF$): GOTO 210

```

the nearest integer, and the final value is POKEd into the note table. So, for best results, you should input a tempo which, when multiplied by the note duration, always yields an integer (thus avoiding any rounding error). In no case may the product of the tempo and the relative note duration exceed 255. A product of 255 will produce a note about 3.0 seconds long. All other durations are proportionally shorter.

The KEY is an integer value [positive, negative, or zero] indicating how many semitones the song will be shifted up or down on the isotonic scale. Thus, for example, a key of 22 is one octave (12 semitones) higher than a key of 10. If the input key causes any note to fall outside the available range of 65 notes, an error message will be given.

After the tempo and key have been input, the program begins assembling the note tables. As the program processes the DATA statements, error or warning messages may be given, generated either by the program or by Applesoft. These messages are described in detail in table 1.

## Program Commands

After the note tables are assembled, you will be prompted with a question mark. In response to this, you may type one of the following commands:

GO plays the song, in harmony and stereo, with as many repetitions as desired. (Be sure your amplifier is properly connected.)

SWAP causes parts 1 and 2 to switch speakers. Before this command is executed, part 1 plays through the Apple speaker, part 2 through your amplifier. Another SWAP will restore the original speakers.

CHANGE allows you to change the tempo and key, and reassemble the note tables.

EDIT lists the DATA statements and ends the program, allowing you to modify the song.

SAVE requests a song title, then saves the title and the note tables on tape. Since the program uses the GET command to input the title, any characters may be input, including colons, commas, and quotes. A carriage return terminates the input and causes recording instructions to be displayed.

quarter-note is given a duration of 1, then a half-note would have a duration of 2, etc. Example:

740 DATA F1,,5,F#1,1,R,2,BN,1.5

4. *END1*: In a duet, the data element "END1" must follow the last note duration of the first part (melody) of the song.
5. *Second Part*: Note names and durations for the second part (harmony) of the song must follow "END1", in the format indicated in 2 and 3. The key signature (if any) is still in effect and should not be repeated here.
6. *END2*: The data element "END2" must follow the last note duration of the second part (harmony) of the song.

The above format applies to duets. There is also an option for entering and playing 1-part solos. To do this, enter key signature, note names and note durations for one part, as described above, but following the last note duration, enter the string "ENDSOLO" as the last data element. This will cause the same tune to be played through both speakers.

### Running the Program

Before running the program as shown, you may find it necessary to change the value of M in line 10. HIMEM will be set to this value, which will be the highest byte occupied by the note tables, plus 1. The value shown in the listing is for a 32K system without DOS. Modify line 10 if necessary, then save the program on tape as shown (without any DATA statements).

Now, each time you load the program, type in the DATA statements according to the format explained above, remembering to give them line numbers higher than 690. Caution: for alphanumeric data, trailing blanks are considered to be part of the string, and may cause the data to be misinterpreted by the program. Avoid trailing blanks!

After all the necessary DATA statements have been entered, type "RUN". In a few seconds, you will see the prompt "TEMPO,KEY?" The tempo you input will be proportional to the length of the song, so that higher values will actually produce slower music. Notice that this is opposite from the usual interpretation of tempo. The tempo is multiplied by the relative note duration obtained from the DATA statement, the product is rounded to

MESSAGE	PROBABLE CAUSE
ILLEGAL QUANTITY ERROR	Tempo 0
BAD SUBSCRIPT ERROR	Illegal note name in DATA statement
OUT OF DATA ERROR	No "END2", or no "ENDSOLO"
SYNTAX ERROR	Bad DATA statement format; data type mismatch
ERROR: KEY IS TOO HIGH	Key would cause notes to be outside of allowable range
ERROR: KEY IS TOO LOW	
ERROR: TEMPO IS TOO LONG	Tempo * Relative Duration 255 for some note
ERROR: INSUFFICIENT MEMORY FOR NOTE TABLES	DATA statements plus note tables take up too much memory
WARNING: PART X IS XXX UNITS SHORTER THAN PART X. SONG WILL END EARLY.	The sums of the durations obtained from the DATA statements do not match. Song will play up to the end of the shorter part.
WARNING: DURATIONS OF SOME NOTES WERE ROUNDED TO THE NEAREST INTEGER. TUNES MAY NOT BE SYNCHRONIZED.	Tempo * Relative Duration does not equal an integer for some note(s).

Table 1: Error/Warning Messages

```

0 REM     NOTE-TABLE ASSEMBLER
1 REM
2 REM
10 M = 32768: REM M = SYSTEM'S CAPACITY
20 B1 = M - 4: HIMEM: M
30 DIM N%(65),P%(7)
40 DEF FN HI(X) = INT (X / 256)
50 DEF FN LO(X) = X - FN HI(X) * 256
55 REM LOAD MACHINE LANGUAGE PROGRAM
60 P$ = "1730050031330061730060031330071730070031330081730080031330091690
00141000003032096003032132003202240007234173017017076056003173048192
174001003136240007234173017017"
70 FOR I = 777 TO 830: POKE I, VAL ( MID$ (P$,3 * (I - 777) + 1,3)): NEXT

80 P$ = "0760720031730321921720030032060000032082192060020032080030320960
03206004003208206032132003076040003162000165006208002198007198006161
006141001003165006208002198"
90 FOR I = 831 TO 883: POKE I, VAL ( MID$ (P$,3 * (I - 831) + 1,3)): NEXT

93 P$ = "0071980061610061410020032080021041041740010030961600001650082080
02198009198008177008141003003165008208002198009198008177008141004003
208002104104172003003096"
95 FOR I = 884 TO 935: POKE I, VAL ( MID$ (P$,3 * (I - 884) + 1,3)): NEXT

115 P$ = ""
120 N%(0) = 1:N%(1) = 0
125 REM SET ISOTONIC WAVELENGTHS
130 FOR I = 2 TO 65
140 N%(I) = 256 / (2 ^ ((I - 1) / 12)) + .5
150 NEXT I
153 REM ABCDEFG

```



```

155 P%(1) = 0:P%(2) = 2:P%(3) = 3:P%(4) = 5
156 P%(5) = 7:P%(6) = 8:P%(7) = 10
160 E = M - FRE (0) + 200: HIMEM: E
170 B$ = CHR$(7) + "ERROR: "
180 RESTORE : INPUT "TEMPO,KEY? ";TM,K%:L = 0:F1 = 0
190 READ P$: IF P$ = "SHARP" OR P$ = "FLAT" THEN 680
200 RESTORE :LN = 0
210 FOR I = B1 - 1 TO E STEP - 2
220 READ P$: IF LEFT$(P$,3) = "END" THEN 370
230 IF P$ = "R" THEN P = 0: GOTO 330
240 P = P%(ASC C(P$) - 64) + 12 * VAL (RIGHT$(P$,1)) + K%
250 A$ = MID$(P$,2,1)
255 IF A$ = "N" THEN 310
260 IF A$ = "#" THEN P = P + 1: GOTO 310
270 IF A$ = "&" THEN P = P - 1: GOTO 310
280 IF LN = 0 THEN 310
290 FOR J = 1 TO LN
295 IF MID$(SF$,J,1) = LEFT$(P$,1) THEN P = P + Q: GOTO 310
300 NEXT
310 IF P < 1 THEN PRINT B$;"KEY IS TOO LOW": GOTO 180
320 IF P > 65 THEN PRINT B$;"KEY IS TOO HIGH": GOTO 180
330 READ DD:L = L + DD:DD = DD * TM:D = INT (DD + .5)
340 IF D > 255 THEN PRINT B$;"TEMPO IS TOO LONG": GOTO 180
350 IF D < > DD THEN F1 = 1
355 REM POKE PITCH,DURATION INTO NOTE TABLE
360 POKE I,N%(P): POKE I - 1,D: GOTO 390
370 POKE I,0: POKE I - 1,0
375 IF LEFT$(P$,7) = "ENDSOLO" THEN B2 = B1:ET = I - 2:L2 = L1: GOTO 4
00
380 IF LEFT$(P$,4) = "END2" THEN ET = I - 2:L2 = L - L1: GOTO 400
385 B2 = I - 1:L1 = L
390 NEXT I: PRINT B$;"INSUFFICIENT MEMORY": PRINT "FOR NOTE TABLE S": HIM
EM:
M: END
400 POKE M - 1, FN LO(B1 - B2): POKE M - 2, FN HI(B1 - B2)
405 POKE M - 3, FN LO(B1 - ET): POKE M - 4, FN HI(B1 - ET)
410 IF L1 < > L2 THEN SH = .5 * (3 - SGN (L2 - L1)): PRINT : PRINT "WA
RNING: PART ";SH;" IS "; ABS (L1 - L2);" UNITS SHORTER": PRINT "THAN
PART ";3 - SH;". SONG WILL END EARLY."
420 IF F1 THEN PRINT : PRINT "WARNING: DURATIONS OF SOME NOTES WERE": PRI
NT
"ROUNDED TO THE NEAREST INTEGER. TUNES": PRINT "MAY NOT BE SYNCHRONI
ZED."
430 POKE 773, FN LO(B1): POKE 774, FN HI(B1)
440 POKE 775, FN LO(B2): POKE 776, FN HI(B2)
450 PRINT : INPUT COM$
460 IF COM$ < > "GO" THEN 500
470 INPUT "REPETITIONS? ";R
480 FOR I = 1 TO R
490 CALL 777: NEXT I: GOTO 450
500 IF COM$ = "CHANGE" THEN 180
510 IF COM$ = "EDIT" THEN HIMEM: M: LIST 691,: END
520 IF COM$ < > "SAVE" THEN PRINT "WHAT?": GOTO 450
530 J = ET - E: IF J > 255 THEN J = 255
535 PRINT "TITLE(1-";J;") CHARACTERS):"
540 FOR I = ET TO E - J STEP - 1
550 GET P$: IF P$ = CHR$(8) THEN I = I + 1: PRINT " "; CHR$(8); CHR$
(8);: GOTO 550
555 IF P$ = CHR$(21) THEN 550
557 IF P$ = CHR$(24) THEN PRINT CHR$(92): GOTO 535
560 PRINT P$;: POKE I, ASC (P$): IF P$ = CHR$(13) THEN 580
570 NEXT I: PRINT : PRINT B$;"TITLE TOO LONG": GOTO 530
580 HOME : PRINT
590 PRINT "AFTER ADJUSTING VOLUME, PRESS 'RECORD', "
600 PRINT "THEN HIT ANY KEY.": GET P$
610 HOME : VTAB 12: FLASH : HTAB 12: PRINT "<<RECORDING>>": NORMAL
615 REM ADDRESS -307 IS MONITOR WRITE ROUTINE:
620 REM LOCATIONS 60-63 POINT TO BEGINNING
625 REM AND ENDING ADDRESS OF WRITE.
630 POKE 6, FN LO(M - 1 - I): POKE 7, FN HI(M - 1 - I)
640 POKE 60,6: POKE 61,0: POKE 62,7: POKE 63,0: CALL - 307
650 POKE 60, FN LO(I): POKE 61, FN HI(I)
660 POKE 62, FN LO(M - 1): POKE 63, FN HI(M - 1): CALL - 307
670 HOME : GOTO 450
680 Q = 1: IF P$ = "FLAT" THEN Q = - 1
690 READ SF$:LN = LEN (SF$): GOTO 210

```

the nearest integer, and the final value is POKed into the note table. So, for best results, you should input a tempo which, when multiplied by the note duration, always yields an integer (thus avoiding any rounding error). In no case may the product of the tempo and the relative note duration exceed 255. A product of 255 will produce a note about 3.0 seconds long. All other durations are proportionally shorter.

The KEY is an integer value (positive, negative, or zero) indicating how many semitones the song will be shifted up or down on the isotonic scale. Thus, for example, a key of 22 is one octave (12 semitones) higher than a key of 10. If the input key causes any note to fall outside the available range of 65 notes, an error message will be given.

After the tempo and key have been input, the program begins assembling the note tables. As the program processes the DATA statements, error or warning messages may be given, generated either by the program or by Applesoft. These messages are described in detail in table 1.

## Program Commands

After the note tables are assembled, you will be prompted with a question mark. In response to this, you may type one of the following commands:

GO plays the song, in harmony and stereo, with as many repetitions as desired. (Be sure your amplifier is properly connected.)

SWAP causes parts 1 and 2 to switch speakers. Before this command is executed, part 1 plays through the Apple speaker, part 2 through your amplifier. Another SWAP will restore the original speakers.

CHANGE allows you to change the tempo and key, and reassemble the note tables.

EDIT lists the DATA statements and ends the program, allowing you to modify the song.

SAVE requests a song title, then saves the title and the note tables on tape. Since the program uses the GET command to input the title, any characters may be input, including colons, commas, and quotes. A carriage return terminates the input and causes recording instructions to be displayed.

## The Playback Program

After I wrote the program just described (the first version of which did not include the SAVE command), it occurred to me that you could spend a lot of time inputting a masterpiece, and lose it all when the computer was turned off. Of course, it's always possible to save the entire program, and thus preserve the DATA statements, but this can run into a lot of tape if you make a habit of it. Another drawback of this method is that every time the program is reloaded, the note tables have to be re-assembled, a process which can take several minutes for long songs. With all this in mind, I added the SAVE feature to the note-table assembler program, and wrote another program whose sole purpose was to load and play previously-recorded songs. Since this playback program loads note tables which are already assembled, we do not experience the delay associated with assembling, and of course a lot of time and tape is saved for anyone who wants to build up a library of songs.

### Running the Program

As can be seen from the listing, line 10 of this program is the same as line 10 of the note-table assembler program. If necessary, modify this line as previously described before running the program.

After typing "RUN", you will be given brief instructions for loading a song from tape. After the song is loaded, its title will appear on the screen, and you will be prompted with a question mark. In response to the question mark, any of the following commands can be typed:

GO plays the song. Same as the GO command described earlier.

SWAP switches the speakers. Same as the SWAP command described earlier.

COPY allows you to copy the note tables to another tape. Similar to the SAVE command of the other program, but does not request a new song title.

LOAD allows you to load and play another song from tape.

It should be noted that there are no CHANGE or EDIT commands here; this is a "read-only" type program. When running the first program, then, you should be sure the tempo and key are adjusted to their most pleasing values before SAVEing the song.

```
0 REM PLAYBACK PROGRAM
1 REM
2 REM
10 M = 32768: REM M = SYSTEM'S CAPACITY
15 REM LOAD MACHINE LANGUAGE PROGRAM
20 P$ = "173005003133006173006003133007173007003133008173008003133009169
    0014100000303209600303213200320224000723417301701707605600317304819
    174001003136240007234173017017"
30 FOR I = 777 TO 830: POKE I, VAL ( MIDS ( P$, 3 * ( I - 777 ) + 1, 3 ) ): NE

40 P$ = "076072003173032192172003003206000003208219206002003208003032096(
    0320600400320820603213200307604000316200016500620800219800719800616)
    006141001003165006208002198"
50 FOR I = 831 TO 883: POKE I, VAL ( MIDS ( P$, 3 * ( I - 831 ) + 1, 3 ) ): NE

60 P$ = "007198006161006141002003208002104104174001003096160000165008208(
    0219800919800817700814100300316500820800219800919800817700814100400:
    208002104104172003003096"
70 FOR I = 884 TO 935: POKE I, VAL ( MIDS ( P$, 3 * ( I - 884 ) + 1, 3 ) ): NE

80 DEF FN HI(X) = INT ( X / 256 )
90 DEF FN LO(X) = X - FN HI(X) * 256
100 HIMEM: M: B1 = M - 4
110 HOME : PRINT
120 PRINT "AFTER ADJUSTING VOLUME, PRESS 'PLAY',"
130 PRINT "THEN HIT ANY KEY.": GET P$
140 SHLOAD : REM LOAD NOTE TABLES
150 B2 = B1 - ( PEEK ( M - 1 ) + 256 * PEEK ( M - 2 ) )
170 T = B1 - ) PEEK ( M - 3 ) + 256 * PEEK ( M - 4 ) )
180 HOME : PRINT : PRINT "TITLE:": PRINT
190 FOR I = T TO 0 STEP - 1
200 PRINT CHR$ ( PEEK ( I ) ); IF PEEK ( I ) = 13 THEN 215
210 NEXT
215 ET = I
217 REM LOAD BEGINNING ADDRESSES OF NOTE TABLES
220 POKE 773, FN LO(B1): POKE 774, FN HI(B1)
230 POKE 775, FN LO(B2): POKE 776, FN HI(B2)
240 PRINT : INPUT COM$
250 IF COM$ < > "GO" THEN 280
260 INPUT "REPETITIONS? "; R
270 FOR I = 1 TO R: CALL 777: NEXT I: GOTO 240
280 IF COM$ = "LOAD" THEN 100
290 IF COM$ < > "SWAP" THEN 330
300 POKE 819, 80 - PEEK ( 819 ): POKE 835, 80 - PEEK ( 835 )
310 GOTO 240
330 IF COM$ < > "COPY" THEN PRINT "WHAT?": GOTO 240
340 POKE 6, FN LO(M - 1 - ET): POKE 7, FN HI(M - 1 - ET)
350 POKE 60, 6: POKE 61, 0: POKE 62, 7: POKE 63, 0
360 HOME : PRINT : PRINT "AFTER ADJUSTING VOLUME, PRESS 'RECORD',"
370 PRINT "THEN HIT ANY KEY.": GET AS
380 HOME : FLASH : VTAB 12: HTAB 12: PRINT "<<RECORDING>>": NORMAL
390 CALL - 307: REM WRITE-TO-CASSETTE ROUTINE
400 POKE 60, FN LO(ET): POKE 61, FN HI(ET)
410 POKE 62, FN LO(M - 1): POKE 63, FN HI(M - 1)
420 CALL - 307: HOME : GOTO 240
```

### A Sample Song

In figure 2, the DATA statements for a short song are given. This is a folk song entitled "Blue Bells of Scotland." The recommended tempo and key for this song are 30, 20. These DATA statements illustrate several techniques which come in handy when you're inputting a song:

1. Input one measure per DATA statement. This way, if you get a warning that the two parts are not of the same length, you can simply check

each DATA statement until you find the measure that doesn't "add up." This technique also helps you to relate the DATA statements to the sheet music.

2. Choose note durations which will take the least amount of typing. In this example, quarter notes are represented by 1, and eighth notes by .5. If a song contains a preponderance of eighth notes, on the other hand, might be wiser to represent eighth notes by 1, and quarter notes by 2, etc. so that you would not have to type

(Continued on page 2)

# CONTINENTAL SOFTWARE THE APPLE SOURCE.

**For Apple owners only. Thoroughly tested, well documented programs for business and pleasure. All written by professionals. Each checked out carefully by experts in its field.**

## **HYPERSPACE WARS 2 GAMES FOR THE PRICE OF 1 \$29.95**

**48K Trek.** Stardate 3421. The Terraunion is being attacked. You command United Starship Excalibur. Your mission: destroy the deadly Klepton invasion force. Four levels, Novice to Master.

**3-D Space Battle.** Use your on-board scanners to search for alien ships in hires three-dimensional space. Destroy as many aliens as you can before you run out of fuel or your ship is destroyed. Hi-res graphics. Req: 48K, Applesoft in Rom+1 disk drive. Dos. 3.2 or 3.3.

## **L.A. LAND MONOPOLY \$29.95**

Bankrupt your opponents while becoming the richest player in the game. Buy, sell, rent and trade to accumulate the most cash and property. Two to six may play. Computer is banker. Create your own special version using streets in your own town.

Hi-res graphics. Req. 48K, Applesoft in Rom+1 disc drive. Dos. 3.2 or 3.3.

## **HOME MONEY MINDER \$34.95**

Complete home financial system combines an excellent Home Checkbook Program with Budgeting. Transactions by month by budget category. Bank reconciliation. Budget for year. Total expenses compared monthly and year-to-date. Plus much more.

Req. 48K, Applesoft in Rom, 1 disk drive+printer. Avail. in Dos. 3.3.

## **THE MAILROOM \$34.95**

Stores up to 750 names per disk. Prints master lists and labels 1, 2 or 3 across. Sorts in 5 seconds. Sort on any of 12 items, search any sorted item in 10-20 seconds maximum. Easy editing, customized inputs.

Req. 48K, Applesoft in Rom, 1 disk drive+printer (132 column capability needed to print Master List.) in Dos. 3.3.

## **THE COMPUTER PROGRAMMED ACCOUNTANT FOUR MODULES**

Buy all four now—or add as you expand **\$175 each** (\$250 after 6/1/81)

The first programs for your Apple that your accountant will like as much as you do. Nobody makes it better—or easier to use—than Continental Software. Simple step-by-step instructions. Excellent error checking. Modules can be used individually, or integrated into a complete Accounting System. Manuals only: just \$15 each.

### **CPA1 GENERAL LEDGER.**

True double entry bookkeeping with complete, accurate audit trails showing the source of each entry in the general ledger. Concise, meaningful reports generated include Balance Sheet, Profit & Loss Summary, Trial Balance and Complete Journal Activity Report. Reports show monthly, year-to-date and last year monthly+YTD for comparison. Custom charting feature includes hi-res-plotting of one or more accounts.

### **CPA2 ACCOUNTS RECEIVABLE**

Prints invoices on available custom forms or on plain paper. Back orders and extensions computed. Issues statements for all customers, one or more customers, or only those with current, 30-, 60-, 90- or 150-day balances. Maintain up to 300 customers. Customized journals. Allows simulation of manual special journal entries. Posts to General Ledger. Prints aging report to 150 days. Also prints customer lists and labels.

### **CPA3 ACCOUNTS PAYABLE**

Prints checks to vendors and non-vendors on available pre-printed checks or plain paper. Each check stub shows invoice(s) paid, discounts taken, net paid, Prints Purchases and Cash

Disbursement Journals. Customized journals. Allows simulation of manual special journal entries. Prints Aging Report to 150 days, vendor list and labels and even a Cash Requirements Report. Posts to General Ledger.

### **CPA4 PAYROLL**

Maintains personnel records for as many as 100 employees. Quarter-to-date and year-to-date earnings and deduction records. Employees are departmentalized and designated hourly or salaried. Prints complete Payroll Checks, 941 information, W-2s, State of California DE-3 information. Prints Payroll Journal and posts to General Ledger.

These are just some of the features of each CPA module. All require 48K, Applesoft in Rom, Dos. 3.3, 2 disk drives+printer.

**At your local dealer or fill out and mail today. Phone for immediate delivery.**

## **OK, I'LL BYTE.**

Send me these revolutionary programs:

- Hyperspace Wars... \$ \_\_\_\_\_
- L.A. Land Monopoly. \_\_\_\_\_
- Home Money Minder \_\_\_\_\_
- The Mailroom. .... \_\_\_\_\_
- CPA1 General Ledger. .... \_\_\_\_\_
- CPA2 Accts. Rec. ... \_\_\_\_\_
- CPA3 Accts. Pay. ... \_\_\_\_\_
- CPA4 Payroll. .... \_\_\_\_\_
- No. C.O.D.s Subtotal \_\_\_\_\_
- Cal. res. add 6% \_\_\_\_\_
- TOTAL** \_\_\_\_\_

Name \_\_\_\_\_  
Address \_\_\_\_\_  
City \_\_\_\_\_ State \_\_\_\_\_ Zip \_\_\_\_\_  
Card No. \_\_\_\_\_ Exp. \_\_\_\_\_

M16/81

# CONTINENTAL SOFTWARE

12101 Jefferson Blvd.,  
Culver City, CA 90230

(213) 371-5612



(Continued from page 22)

so many decimal points. This would simply require a corresponding adjustment in the TEMPO when the program is run.

3. Number the DATA statements so that a measure in the melody can be easily related to the corresponding measure in the harmony. In the example, DATA statements of corresponding measures have line numbers separated by 100.

The Applesoft programs described provide a convenient method for transferring a song from sheet music to the computer. However, the assembly language routine can be used independently, as long as note tables are created, and the pointers to the beginnings of the note tables are initialized. Thus it is possible to experiment with more exotic kinds of music, using all 256 wavelengths instead of just the 65 to which my note-table assembler is

limited. CALL 777 will start the song playing. If the song is interrupted (as with a RESET), CALL 840 will cause it to pick up where it left off.

When you create the note tables "by hand", (without the aid of the note-table assembler program), follow the structure illustrated in figure 3, POKEing the first note into the *highest* memory location, and working your way down. The first pointer (decimal locations 773,774) should be set to the location of the first pitch of the first part, *plus one*. Similarly, the second pointer (decimal locations 775,776) should be set to the location of the first pitch of the *second* part, plus one. In the case of solos, the first part *is* the second part, so both pointers are set to the same location. By judicious placement of these pointers, you can play duets, play solos, create a short delay between the two speakers for an

"echo" effect, or even "listen" computer's ROM. For another interesting effect, execute the following instruction:

POKE 835,80 - PEEK(835)

Then, when you do a CALL 777, parts of the song will be sent through the same speaker. This will provide an excellent demonstration of why I use two speakers instead of one

Whether you use the machine language routine independently with the programs described in this article, or within your own BASIC programs, there is plenty of room for experimentation, and I will be anxious to hear about any enhancements or suggestions from readers. In any case, I think you will agree that two voices are at least twice as good as one.

AK

# Don't buy Apple Software

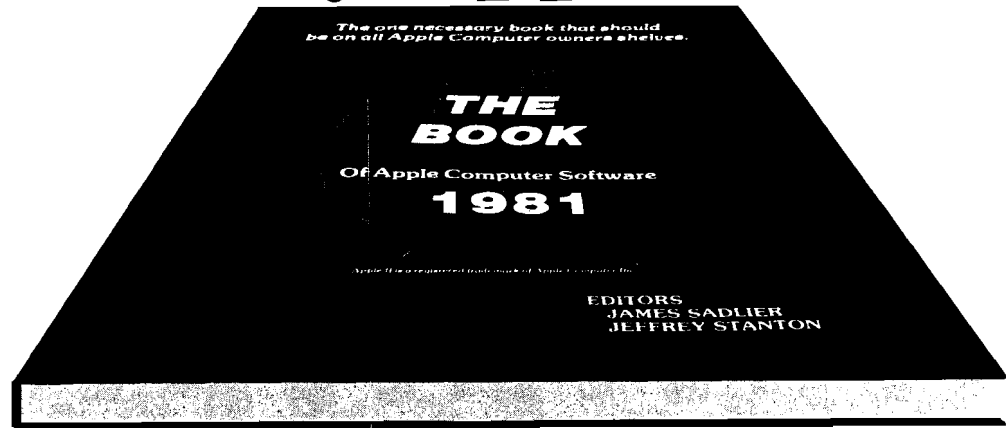

## until you read this book.

First check The Book—the one complete critical analysis of most Apple Software available. Games, Educational, Business, Utility programs and more. Each comprehensively rated on 11 separate points. Each reviewed by an expert in its field. Just \$19.95.

Now you can compare and get more for your software dollar. Does the program you need exist? How good is it? Which software vendors offer the best support? Find out all this and much more.

MasterCard & Visa accepted. Fill out and mail today or call for shipment.

Calif. residents add 6%

16720 HAWTHORNE BLVD., LAWNSDALE, CA 90260. (213) 371-4012.

NAME \_\_\_\_\_  
 ADDRESS \_\_\_\_\_  
 CITY \_\_\_\_\_ STATE \_\_\_\_\_ ZIP \_\_\_\_\_  
 CARD NUMBER \_\_\_\_\_ EXP. \_\_\_\_\_

### TheBookCompany

M16/81

# MICRO

## New Publications

Mike Rowe  
New Publications  
P.O. Box 6502  
Chelmsford, MA 01824

### General 6809

**Using Microprocessors and Microcomputers: The 6800 Family** by Joseph D. Greenfield and William C. Wray. John Wiley & Sons, 605 Third Avenue, New York, New York 10158, 1981, xiv, 460 pages, 7 $\frac{3}{4}$  x 9 $\frac{1}{2}$  inches, hardbound. ISBN: 0-471-02727-8 \$22.95

This textbook for electronic technology and engineering students explains the uses and operation of the 6800 family of microcomputer components. Although only a few pages are devoted specifically to the 6809, the authors' comments are noteworthy: "The newer more powerful microprocessors, like the 6809, seem to be destined to replace the 6800 in new designs in the coming years.... A thorough introduction to the most promising of these microprocessors, the 6809, is presented so that the student may understand its advantages and incorporate it in new designs."

### General 6502

**Beyond Games: System Software for Your 6502 Personal Computer** by Ken Skier. BYTE/McGraw-Hill, Book Division (70 Main Street, Peterborough, New Hampshire 03458), 1981, iv, 434 pages, diagrams and listings, 7 $\frac{1}{2}$  x 9 3/16 inches, paperbound. ISBN: 0-07-057860-5 \$14.95

This book introduces newcomers to assembly-language programming in general, and of the 6502 in particular, and presents software tools for use in developing assembly-language programs for the 6502. The book's software runs on an Apple II, an Atari 400 or 800, an Ohio Scientific (OSI) Challenger 1-P, or a PET 2001. The author claims that with proper initialization of the System Data Block, the software should run on any 6502-based computer equipped with a keyboard and a memory-mapped, character-graphics video display.

**CONTENTS:** Introduction; Your Computer; Introduction to Assembler; Loops and Subroutines; Arithmetic and Logic; Screen Utilities; The Visible Monitor; Print Utilities; Two Hexdump Tools; A Table-Driven Disassembler; A General MOVE Utility; A Simple Text Editor; Extending the Visible Monitor; Entering the Software Into Your System. **Appendices:** A. Hexadecimal Conversion Table; ASCII Character Codes; 6502 Instruction Set — Mnemonic List; 6502 Instruction Set — Opcode List; Instruction Execution Times; 6502 Opcodes by Mnemonic and Addressing Mode. B. The Ohio Scientific Challenger 1-P; The PET 2001; The Apple II; The Atari 800. C. Screen Utilities; Visible Monitor (Top Level and Display Subroutines); Visible Monitor (Update Subroutine); Print Utilities; Two Hexdump Tools; Table-Driven Disassembler (Top Level and Utility Subroutines); Table-Driven Disassembler (Addressing Mode Subroutines); Table-Driven Disassembler (Tables); Move Utilities; Simple Text Editor (Top Level and Display Subroutines); Simple Text Editor (EDITIT Subroutines); Extending the Visible Monitor; System Data Block for the Ohio Scientific C-1P; System Data Block for the PET 2001; System Data Block for the Apple II; System Data Block for the Atari 800. D. Screen Utilities; Visible Monitor (Top Level and Display Subroutines); Visible Monitor (Update Subroutine); Print Utilities; Two Hexdump Tools; Table-Driven Disassembler (Top Level and Utility Subroutines); Table-Driven Disassembler (Addressing Mode Subroutines); Table-Driven Disassembler (Tables); Move Utilities; Simple Text Editor; Extending the Visible Monitor. E. Screen Utilities; Visible Monitor (Top Level and Display Subroutines); Visible Monitor (Update Subroutines); Print Utilities; Two Hexdump Tools; Table-Driven Disassembler (Top Level and Utility Subroutines); Table-Driven Disassembler (Addressing Mode Subroutine); Table-Driven Disassembler (Tables); Move Utilities; Simple Text Editor; Extending the Visible Monitor; System Data Block for the Ohio Scientific C-1P; System Data Block for the PET 2001; System Data Block for the Apple II; System Data Block for the Atari 800. **Index.**

**Micro Chart: 6502 (65XX), Microprocessor Instant Reference Card** by James D. Lewis (Micro Logic Corp., P.O. Box 174, Hackensack, New Jersey 07602), 1980: one 8 $\frac{1}{2}$ -x-11-inch plastic card, 2-color, 2-sided, 4-hole punched.

\$5.95  
(includes \$1.00 for shipping)

This sturdy, plastic sheet for programmers, engineers, and students clearly and concisely lists significant and frequently referenced 6502 data.

**CONTENTS:** *Side I*—Hex to Instruction Conversion; Memory Map; Effect on Flags; Status Flags; Interrupts; Addressing Modes; ASCII Character Set; Hex and Decimal Conversion; 6502 Pins; Registers; Unsigned Comparisons; Abbreviations; Miscellaneous. *Side II*—Instruction Set; Instructions Notes; Shift Instructions; Added Cycle Time; Assembler Symbols.

### Apple

**MICRO/Apple, Volume 1**, edited by Ford Cavallari. MICRO/Apple Series (ISSN: 0275-3537). Micro Ink, Inc. (34 Chelmsford Street, P.O. Box 6502, Chelmsford, Massachusetts 01824), 1981, 224 pages, listings and diagrams, 6 x 9 inches, cardstock cover with Wire-o binding. The inside back cover has a pocket containing a floppy disk. ISBN: 0-938222-05-8 \$24.95  
(Including floppy disk)

This first volume of a new series on the Apple Computer contains 30 articles selected from *MICRO, The 6502 Journal*, 1977-1980, updated by the authors or MICRO's staff. Introductory material has been added and the 38 programs provided have been re-entered, listed, tested, and put on diskette (13-sector DOS 3.2 format, convertible to DOS 3.3).

**CONTENTS:** Introduction. BASIC Aids (4 articles); I/O Enhancements (4 articles); Runtime Utilities (4); Graphics (5); Education (4); Games (4); Reference (5). Language Index; Author Index (with biographies) Disk Information.

### General Microcomputer

**IEEE Micro** is a new quarterly which began publication in February 1981. It is published by the IEEE Computer Society (10662 Los Vaqueros Circle, Los Alamitos, California 90720). It covers microcomputer design and applications and is edited for the practicing hardware and software engineer employed in design and application in areas such as communication; process control; consumer electronics; medicine; energy management; data acquisition; transportation; test, measurement, and instrumentation; navigation and guidance; military electronics; small business; microprocessor design and standardization; and education. An annual subscription to *IEEE Micro* is \$8.00 in addition to society member dues (\$14.00) or \$23.00 for non-members.

(Continued on page 39)

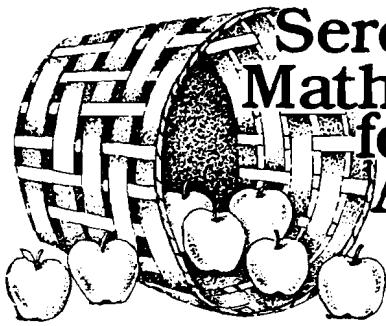

# Serendipity Math Tools for your Apple II

**INTER-STAT** offers you a full range of interactive statistical analysis techniques, from averages and medians to binomial and poisson distributions, correlation coefficients and one- and two-way analysis of variance. \$169.

**ADVANCED MATH ROUTINES** is the mathematical tool kit for common, yet complex numerical problems. Routines include: linear regression, matrix operations, numerical calculus, differential equations and data set recall for iterative calculations. \$169.

Thoroughly tested, well documented and easy to master, each package includes a 30+ page self-teaching manual. Serendipity's complete line of software solutions for business, education and professional applications are available at your local Computerland or Apple dealer.

For a free brochure, or to order direct contact Serendipity Systems, 225 Elmira Road, Ithaca, NY 14850. Phone 607-277-4889. Visa and MC accepted.

\*Apple Computer

## SERENDIPITY SYSTEMS

## ☆ SOFTWARE FOR OSI

- ☆ **VIDEO GAMES 1** ..... Three Games. Head-On is like the popular arcade game Battle is a tank game for two to four. Trap! is an ent blockade style game.
- ☆ **VIDEO GAMES 2** ..... Three games. Gremlin Hunt is an arcade-style game for three. Gunfight is a duel of mobile artillery. Indy is a race for one or two.
- ☆ **ADVENTURE: MAROONED IN SPACE** ..... An adventure that runs in 8K! Save your ship and yourse destruction.
- ☆ **DUNGEON CHASE** ..... A real-time video game where you explore a twenty dungeon.
- ☆ **BOARD GAMES 1** ..... Two games. Mini-gomoku is a machine language vers five stones gomoku. Cubic is a 3-D tic-tac-toe game. Bot graphics.
- ☆ **DISASSEMBLER** ..... Use this to look at the ROMs in your machine to see makes BASIC tick. Reconstruct the assembler source co machine language programs to understand how they Our disassembler outputs unique suffixes which identi addressing mode being used, no other program has th
- ☆ **SUPER! BIORHYTHMS** ..... A sophisticated biorhythm program with many ur features.

☆ **C1 SHORTHAND** ..... Use only two keys to enter any one of the BASIC comm or keywords. Saves much typing when ent programs. Written in machine language.

For all BASIC-in-ROM systems. Selected programs available on disk. Color and sound on video games.

Send for **FREE** catalog.



## ORION SOFTWARE ASSO

147 Main St. Ossining, NY 10

### \*\*SPECIAL INTRODUCTORY OFFER\*\*

**Programmable Character Generator Board** \$89.95

You can use OSI's characters or you can make your own. Imagine you can now do true high resolution graphics 512 x 256 dots in the 64 x 32 screen format. And all under your control!

Other mods available — send for catalog.

#### SOFTWARE (with Documentation)

**PC Chess V1.9** \$14.95

Play Chess against your computer!

**Helicopter Pilot: (64 CHR Video Only)** \$ 8.95

An Excellent Graphics Program!

**Golf Challenger** \$14.95

From 1 to 4 players. Play a round of golf on your 18 hole golf course. One of the best programs I have ever seen! You can even design your own course. Comes with full documentation (14 pages).

#### Two Very Intricate Simulations!

**Wild Weasel II:** You operate a Sam Missile base during a Nuclear War. Not as easy as you think! You must operate in a three dimensional environment.

**Fallsafe II:** The shoe is on the other foot! Here you are in the attacking bomber and you must penetrate deep into enemy territory. Can you survive? An extremely complex electronic warfare simulation! **SPECIAL:** both for 19.95

**Hardware: C1P Video Mod:** Makes your 600 Video evr bit as good as the 4P and 8P. Gives 32/64 CHR/Line w guardbands 1 and 2 Mhz. CPU clock with 300, 600 a 1200 baud for Serial Port. Complete Plans \$19.

**KIT (Hardware and Software) \$39.95**

Installed: 32CHR — \$79.95, 64CHR-\$89.95

Extra K of Video RAM for 64CHR not included!

Set of 3 ROMs available \$75.00

**C1P Sound Effects Board:** Completely programmabl For the discriminating hobbist, the best board on t market for creating sound and music. Can be interr driven so that you can use it for gaming purposes. H on board audio amp, 16 bit interval timer, 128 Bytes RAM and two 8 bit parallel I/O Ports.

Assembled and tested \$89.95 Bare Board \$39.9

Both include Prog. Manual and Sample Software.

**C1P HI Speed Cassette Kit:** Gives a reliable 300, 60 and 1200 Baud. No symmetry adjustments — the ide fix for OSI's cassette interface. Easily implemented i 30 minutes. Will save you time and money even the fir: night you use it! \$12.9

Many, many more. Send for Catalog with free prograr (Hard Copy) and BASIC Memory Map. \$1.00. Tw locations to serve you:

Progressive Computing  
3336 Avondale Court, Windsor, Ontario  
Canada, N9E 1X6  
(519) 969-2500

or

3281 Countryside Circle, Pontiac TWP, MI 48057  
(313) 373-0468

VISA

MASTER CHARGE

# A C1P Dump Utility

## This article describes a debugging tool for machine language and BASIC programs.

Francois Faguy  
P.O. Box 86  
L'Islet-sur-mer  
Quebec, Canada GOR 2B0

You have your C1P, have tried a few simple BASIC programs and want to get into more serious usage. You read magazines like MICRO and see all those great programs for Microsoft BASIC, as implemented for the Apple, PET or TRS-80 computers. They should run on your C1P since they use the same BASIC, but as soon as programs make use of machine-dependent features or BASIC flags and pointers, they don't work. The reasons are:

1. Although all these computers (and many more) use the same BASIC interpreter, they don't use the same version and release.
2. Microsoft 8K BASIC is only a BASIC interpreter. The I/O support routines are the responsibility of the system manufacturer.
3. Manufacturers add extensions to Microsoft BASIC.
4. All these systems include some kind of a monitor program; but they are all very different.

I wanted to use the technique discussed in Virginia Lee Brady's article (MICRO 27:7) for a program I am writing. I used the monitor to dump some of the page zero locations discussed and found that they did not match. So I tried dumping contiguous locations with the monitor. I wanted to check if the difference was due to a reorganization of work areas in page zero between OSI Microsoft BASIC Version 1.0, revision 3.2 and the Applesoft Version of Microsoft BASIC. But it could take years to find what I was looking

for, dumping one byte at a time, and using the monitor. So I wrote the Dump program discussed in this article to get a better picture of the problem.

The Dump program is designed to be loaded at the high-end of RAM, where it can stay as long as the machine is powered-up, and as long as

you enter the right memory size when you cold start. It uses 359 bytes (167 hex). On my 8K system, I set the start address to \$1E00. If you wish to use Dump on a larger system, change the address in line 50 (listing 3) to the desired origin value and re-assemble the program.

### Listing 1

```
10 REM THIS PROGRAM COPIES
20 REM THE LOADER FROM
30 REM THE OSI ASM/EDIT TAPE
100 DIM A$(1000)
200 INPUT "READY INPUT";A$
205 REM SET LOAD MODE
210 POKE 515,255
220 FOR I = 0 TO 239
230 INPUT A$(I)
240 NEXT I
245 REM CLEAR LOAD MODE
250 POKE 515,0
260 INPUT "READY OUTPUT";A$
265 REM SET SAVE MODE
270 POKE 517,255
280 FOR I = 0 TO 239
290 PRINT A$(I); CHR$(13);
300 NEXT I
305 REM CLEAR SAVE MODE
310 POKE 517,0
```

### Listing 2

```
10 REM THIS PROGRAM WRITES
20 REM THE START ADDRESS
30 REM OF A MACHINE LANGUAGE
40 REM PROGRAM AT THE END OF
50 REM A SELF-LOADING/AUTO-START
60 REM OBJECT TAPE
80 INPUT "ENTER START ADDR";A$
90 A$ = "$" + A$
100 INPUT "READY OUTPUT";A$
110 REM SET SAVE MODE
120 POKE 517,255
130 PRINT A$
140 REM CLEAR SAVE MODE
150 POKE 517,0
```

## Installation Procedure

Dump is too big to be POKEd with a BASIC program. It is preferable to use an object tape. The OSI Assembler/Editor will generate an object tape, but you need a loader. OSI does not tell you, but they give you a loader; you can use the Assembler/Editor check-sum loader to load your object tape. Listing 1 is a BASIC program that will copy the loader from OSI Assembler/Editor tape (the input tape) to your object tape (the output tape).

Once the loader is on the object tape, load the Assembler/Editor and input the Dump program (listing 3). Note that comment lines in listing 3 do not have line numbers. This is because the source file of the 8K version is too small to hold the Dump program with the comments. So do not input any comments if your machine has only 8K.

Next, assemble the program with "A1" to ensure that there are no errors. Then save the source listing as this can be useful if you wish to customize Dump later. While still in save mode, put the object tape in the cassette recorder, wind it past the end of the loader, and type "A2", ready the recorder for writing and hit RETURN. This will write the object program on the tape.

If you wish a self-starting tape, the BASIC program in listing 2 will write the start address in the format required by the loader at the end of the object file on the tape. For the 8K version, reply 1E00 to "ENTER START ADDRESS". If you do not write a start address on the object tape, use the BREAK key to exit from the loader. Typing M1E00G will run Dump.

## Using Dump

To load the program, hit BREAK, type "ML", put the object tape in the recorder, and start the recorder. Once the program is loaded, it will self-start. The screen is first cleared and three prompts are displayed at the bottom of the screen. You can:

1. Enter the 4-digit hexadecimal address of where the dump is to start and 64 bytes will be displayed (see figure 1).

2. Hit RETURN to dump the next higher 64 bytes. If RETURN is used the first time round, the dump will start at \$0000.

3. Enter "R", to cause Dump to execute a RTS instruction.

## Listing 3

```

0800 ;*****
0800 ;*
0800 ;* OSI CIP MEMORY DUMP PROGRAM *
0800 ;*
0800 ;* BY FRANCOIS FAGUY *
0800 ;*
0800 ;*****
0800 ;*
0800 ;DUMPS 64 BYTES OF MEMORY ON THE SCREEN
0800 ; IN BOTH HEX AND ASCII
0800 ;
0800 ;CAN BE RUN FROM THE MONITOR: M 1E00 G
0800 ; OR AS A USR(X) FUNCTION FROM BASIC
0800 ;
0800 DLOC EPZ $14 ;CURRENT DISPLAY LOCATION
0800 DADDR EPZ $16 ;POINTER TO CURRENT ADDRESS
0800 ;
0800 BASIN EQU $FFEB ;BASIC KEYBOARD INPUT ROUTINE
0800 DSPLY EQU 53510 ;FIRST BYTE USED IN VIDEO RAM
0800 ;
1E00 ; ORG $1E00
1E00 OBJ $800
1E00 ;
1E00 ;CLEAR THE SCREEN
1E00 ;
1E00 A200 DUMP LDX #$00 ;INIT X REG.
1E02 A920 LDA #$20 ;SPACE
1E04 9D00D3 CLEAR STA $D300,X ;FILL VIDEO RAM WITH SPACES
1E07 9D00D2 STA $D200,X
1E0A 9D00D1 STA $D100,X
1E0D 9D00D0 STA $D000,X
1E10 E8 INX
1E11 D0F1 BNE CLEAR
1E13 ;
1E13 ;DISPLAY PROMPT MESSAGES
1E13 ;
1E13 A011 LDY #17
1E15 B9331F MSG10 LDA MSG1,Y
1E18 9926D3 STA DSPLY+544,Y
1E1E 88 DEY
1E1C 10F7 BPL MSG10
1E1E A011 LDY #17
1E20 B9451F MSG20 LDA MSG2,Y
1E23 9946D3 STA DSPLY+576,Y
1E26 88 DEY
1E27 10F7 BPL MSG20
1E29 A010 LDY #16
1E2B B9571F MSG30 LDA MSG3,Y
1E2E 9966D3 STA DSPLY+608,Y
1E31 88 DEY
1E32 10F7 BPL MSG30
1E34 ;
1E34 ;GET THE START ADDRESS FROM THE KEYBOARD
1E34 ;
1E34 A2FC GET LDX #252 ;INIT REG. X FOR 4 CHAR.
1E36 20EBFF GET05 JSR BASIN ;READ A CHARACTER
1E39 C90D CMP #$0D ;<CR> ?
1E3B F046 BEQ DUMPO5 ;YES, DUMP NEXT 64 BYTES
1E3D C952 CMP #'R'
1E3F D001 BNE GET08 ;NO, CARRY ON
1E41 60 RTS
1E42 9DCACF GET08 STA DSPLY-316,X ;DISPLAY THE CHARACTER
1E45 C930 CMP #'0'
1E47 30ED BMI GET05 ;<0 = ERROR
1E49 C93A CMP #'9'+1
1E4B 300A BMI GET10 ;NO = GOOD CHARACTER
1E4D C941 CMP #'A'
1E4F 30E5 BMI GET05 ;<'A' = ERROR
1E51 C947 CMP #'F'+1
1E53 B0E1 BCS GET05 ;>'F' = ERROR
1E55 E906 SBC #$06 ;('A'-19'-2)--CONVERT HEX DIGITS
1E57 290F GET10 AND #$0F ;CONVERT HEX DIGITS 0-F
1E59 9D2B1E STA ADDRIN-252,X ;SAVE HEX DIGIT
1E5C E8 INX ;CHECK FOR 4 CHARACTERS
1E5D D0D7 BNE GET05 ;NEXT CHARACTER
1E5F ;
1E5F ;PACK ADDRESS IN TWO BYTES
1E5F ;
1E5F AD291F LDA ADDRIN+2 ;THIRD HEX DIGIT
1E62 0A ASL
1E63 0A ASL
1E64 0A ASL
1E65 0A ASL
1E66 0D2A1F ORA ADDRIN+3 ;FOURTH HEX DIGIT
1E69 8D2C1F STA ADDR+1 ;SAVE LOW BYTE OF ADDRESS
1E6C AD271F LDA ADDRIN ;FIRST HEX DIGIT
1E6F 0A ASL ;SHIFT TO 4 HIGH BITS OF ACC.
1E70 0A ASL
1E71 0A ASL
1E72 0A ASL
1E73 0D281F ORA ADDRIN+1 ;SECOND HEX DIGIT
1E76 8D2B1F STA ADDR ;SAVE HIGH BYTE OF ADDRESS
1E79 ;
1E79 ;ERASE INPUT AREA
1E79 ;
1E79 A203 LDX #$03
1E7B A920 LDA #$20 ;SPACE
1E7D 9DC6D0 GET15 STA DSPLY-64,X
1E80 CA DEX
1E81 10FA BPL GET15

```

(continued)



### Listing 3

```

1E83 ;
1E83 ;NOW THAT WE HAVE THE START ADDRESS,
1E83 ; START DUMPING
1E83 ;
1E83 18 DUMP05 CLC
1E84 AD2C1F LDA ADDR+1 ;SAVE START ADDRESS + 64
1E87 6940 ADC #64
1E89 8D2E1F STA SADDR+1
1E8C AD2B1F LDA ADDR
1E8F 6900 ADC #S00 ;ADD CARRY TO HIGH BYTE
1E91 8D2D1F STA SADDR
1E94 AD2F1F LDA SLOC ;SET STARTING VIDEO RAM ADDR.
1E97 8514 STA DLOC
1E99 AD301F LDA SLOC+1
1E9C 8515 STA DLOC+1
1E9E ;
1E9E ;DISPLAY ADDRESS OF FIRST BYTE OF THIS LINE
1E9E ;
1E9E AD311F DUMP10 LDA ADDR+1 ;SETUP ADDR. FOR HEXASC
1EA1 8516 STA DADDR
1EA3 AD321F LDA ADDR+1
1EA6 8517 STA DADDR+1
1EA8 A001 LDY #S01 ;INIT REG. Y FOR 2 BYTES
1EAA 20F21E JSR HEXASC ;DISPLAY ADDRESS
1EAD ;
1EAD ;DISPLAY NEXT 4 BYTES IN HEX
1EAD ;
1EAD 18 CLC
1EAE AD2C1F LDA ADDR+1 ;SETUP ADDR. FOR HEXASC.
1EB1 8516 STA DADDR
1EB3 6904 ADC #S04 ;AND ADD 4 TO ADDRESS
1EB5 8D2C1F STA ADDR+1
1EB8 AD2B1F LDA ADDR
1EBB 8517 STA DADDR+1
1EBD 6900 ADC #S00 ;ADD CARRY TO HIGH BYTE
1EBF 8D2B1F STA ADDR
1EC2 A905 LDA #S05 ;ADD 5 TO VIDEO RAM POINTER
1EC4 201B1F JSR INCLOC
1EC7 A003 LDY #S03 ;INIT REG. Y FOR 4 BYTES
1EC9 20F21E JSR HEXASC ;DISPLAY 4 BYTES
1ECC ;
1ECC ;DISPLAY SAME 4 BYTES IN ASCII
1ECC ;
1ECC A909 LDA #S09 ;ADD 9 TO VIDEO RAM POINTER
1ECE 201B1F JSR INCLOC
1ED1 A003 LDY #S03 ;INIT REG. Y FOR 4 BYTES
1ED3 B116 DUMP15 LDA (DADDR),Y ;GET BYTE
1ED5 9114 STA (DLOC),Y ;DISPLAY IT
1ED7 88 DEY ;MORE BYTES?
1ED8 10F9 BPL DUMP15 ;YES, DISPLAY THEM
1EDA A912 LDA #18 ;ADD 18 TO VIDEO RAM POINTER
1EDC 201B1F JSR INCLOC
1EDF ;
1EDF ;CHECK IF WE ARE FINISHED
1EDF ;
1EDF AD2E1F LDA SADDR+1 ;LOW BYTE EQUAL?
1EE2 CD2C1F CMP ADDR+1
1EE5 D0B7 BNE DUMP10 ;NO, NEXT LINE
1EE7 AD2D1F LDA SADDR
1EEA CD2B1F CMP ADDR ;HIGH BYTE EQUAL?
1EED D0AF BNE DUMP10 ;GET NEXT START ADDRESS
1EEF 4C341E JMP GET ;GET NEXT START ADDRESS
1EF2 ;
1EF2 ;THIS SUBROUTINE CONVERTS FROM 2 HEX DIGITS
1EF2 ; PER BYTE TO 2 ASCII CHARACTERS IN 2 BYTES
1EF2 ;
1EF2 ;DADDR: POINTS TO THE FIRST INPUT BYTE
1EF2 ;DLOC : POINTS TO OUTPUT AREA
1EF2 ;Y REG: NUMBER OF BYTES MINUS 1 TO CONVERT
1EF2 ;
1EF2 B116 HEXASC LDA (DADDR),Y ;GET BYTE
1EF4 AA TAX ;SAVE IT IN REG. X
1EF5 98 TYA
1EF6 CA ASL ;MULTIPLY REG. Y BY 2
1EF7 A8 TAY
1EF8 8A TXA ;PUT BYTE BACK IN REG. A
1EF9 4A LSR ;EXTRACT FIRST DIGIT
1EFA 4A LSR
1EFB 4A LSR
1EFC 4A LSR
1EFD 20121F JSR HEXA10 ;MAKE IT A CHARACTER
1F00 9114 STA (DLOC),Y ;DISPLAY IT
1F02 8A TXA ;PUT BYTE BACK IN REG. A
1F03 290F AND #S0F ;EXTRACT SECOND DIGIT
1F05 C8 INY ;NEXT OUTPUT BYTE
1F06 20121F JSR HEXA10 ;MAKE IT A CHARACTER
1F09 9114 STA (DLOC),Y ;DISPLAY IT
1F0B 98 TYA
1F0C 4A LSR ;DIVIDE REG. Y BY 2
1F0D A8 TAY
1F0E B8 DEY ;MORE BYTES?
1F0F 10E1 BPL HEXASC ;YES, CONVERT THEM
1F11 60 RTS ;NO, RETURN
1F12 ;
1F12 ;CONVERT UNPACKED HEX DIGIT IN REG. A
1F12 ; TO ASCII CHARACTER IN REG. A
1F12 ;
1F12 C90A HEXA10 CMP #10 ;LESS THAN 10?
1F14 9002 BCC HEXA15

```

(continued)

The last option can be useful for debugging: Dump can be called from an assembler program using JSR \$1E00 or from BASIC using the USR(X) function. You can dump part of memory and then continue your program execution where it left off.

To use Dump with BASIC, hit BREAK when the program is loaded, then type "C" to cold start and reply 7680 to "MEMORY SIZE".

### Program Logic

(All line numbers refer to listing 3)

Lines 10 to 40 are equates for the following symbols:

**BASIN:** the BASIC input routine, used by Dump for all keyboard input.

**DSPLY:** the start of the first line of dump in the video RAM. This value can be adjusted if your TV monitor has a different overscan from mine.

**DLOC and DADDR:** two page-zero words used as pointers with indirect-postindexed addressing. Locations \$14-\$17 are part of a BASIC input buffer and using them does not seem to have any adverse effect.

Lines 60-150 clear the screen.

Lines 160-330 display the prompts.

Lines 340-780 read the keyboard and execute a RTS if "R" is entered, or branch to DUMP05 if you hit RETURN, or translate the 4 hexadecimal digits to an address.

At lines 790-900 at label DUMP05, the start address plus 64 is saved in SADDR. SADDR will be used later to decide when the display is full. The page-zero pointer [DLOC] to video RAM is set to the DSPLY value.

Lines 910-970 display the address of the first byte of the current line.

Lines 980-1100 display the hexadecimal value of the next four bytes.

Lines 1110-1200 display the same 4 bytes in ASCII.

Lines 1210-1270 check for the end of the 64 bytes.

Lines 1280-1580 are the subroutine HEXASC. It is used to display addresses and the hexadecimal dump. Refer to

listing 3 for more details.

Lines 1590-1660 are the subroutine INCLC. It is used to update the current video RAM position pointer (DLOC).

Francois Faguy has 10 years of programming experience. Starting as an application programmer, he moved to operating system support and data base administration. His hardware experience includes the DEC PDP 11 line and almost all systems marketed by IBM in the last 15 years, from the 1130 to the 3033. After working for large Canadian corporations, he is now a freelance consultant.

**MICRO**

**Figure 1: The information displayed by the DUMP Utility Program. The first four characters of each line represent the address in hex of the first byte displayed on the line. The next eight characters, are the hex content of four bytes. The last four characters are the ASCII or graphic value of the same four bytes.**

**Listing 3 (continued)**

```

1F16 6906          ADC #S06          ;NO, ADD OFFSET FOR A-F
1F18 6930          HEXA15 ADC #'0'      ;ADD OFFSET FOR ASCII
1F1A 60           RTS
1F1B             ;
1F1B             ;THIS SUBROUTINE ADDS REG. A TO DLOC
1F1B             ;
1F1B 18           INCLC CLC
1F1C 6514          ADC DLOC          ;ADD TO LOW BYTE
1F1E 8514          STA DLOC          ;SAVE LOW BYTE
1F20 A515          LDA DLOC+1        ;GET HIGH BYTE
1F22 6900          ADC #S00          ;ADD CARRY
1F24 8515          STA DLOC+1        ;SAVE HIGH BYTE
1F26 60           RTS
1F27             ;
1F27             ;WORK AREAS
1F27             ;
1F27 000000        ADDRIN HEX 00000000      ;SAVE 4 HEX DIGITS OF START ADDR
1F2A 00           ADDR  HEX 0000          ;POINTER TO NEXT BYTE TO DUMP
1F2B 0000          SADDR  HEX 0000        ;START ADDRESS + 64
1F2D 0000          SLOC   ADR DSPLY       ;STARTING VIDEO RAM LOCATION
1F2F 06D1          ADDR  ADR ADDR        ;POINTER TO ADDR FOR HEXASC
1F31 2B1F          MSG1  ASC '<CR>:NEXT 64 BYTES'
1F33 3C4352
1F36 3E3A4E
1F39 455854
1F3C 203634
1F3F 204259
1F42 544553
1F45 523A52
1F48 455455
1F4B 524E20
1F4E 544F20
1F51 43414C
1F54 4C4552
1F57 342044
1F5A 494749
1F5D 545320
1F60 484558
1F63 204144
1F66 4452
MSG2  ASC 'R:RETURN TO CALLER'
MSG3  ASC '4 DIGITS HEX ADDR'

```

HEX	DEC	+0	+5	+10	+15	+20	DEC	HEX
D083	53379						53403	D09B
D0A3	53411						53435	D0BB
D0C3	53443		1 F 2 0				53467	D0DB
D0E3	53475						53499	D0FB
D103	53507		1 F 2 0	A 5 1 5 6 9 0 0		i	53531	D11B
D123	53539		1 F 2 4	8 5 1 5 6 0 0 1			53563	D13B
D143	53571		1 F 2 8	0 F 0 2 0 0 1 F			53595	D15B
D163	53603		1 F 2 C	3 0 1 F 6 0 0 6		0	53627	D17B
D183	53635		1 F 3 0	D 1 2 B 1 F 3 C		+	53659	D19B
D1A3	53667		1 F 3 4	4 3 5 2 3 E 3 A		C R :	53691	D1BB
D1C3	53699		1 F 3 8	4 E 4 5 5 8 5 4		N E X T	53723	D1DB
D1E3	53731		1 F 3 C	2 0 3 6 3 4 2 0		6 4	53755	D1FB
D203	53763		1 F 4 0	4 2 5 9 5 4 4 5		B Y T E	53787	D21B
D223	53795		1 F 4 4	5 3 5 2 3 A 5 2		S R : R	53819	D23B
D243	53827		1 F 4 8	4 5 5 4 5 5 5 2		E T U R	53851	D25B
D263	53859		1 F 4 C	4 E 2 0 5 4 4 F		N T O	53883	D27B
D283	53891		1 F 5 0	2 0 4 3 4 1 4 C		C A L	53915	D29B
D2A3	53923		1 F 5 4	4 C 4 5 5 2 3 4		L E R 4	53947	D2BB
D2C3	53955		1 F 5 8	2 0 4 4 4 9 4 7		D I G	53979	D2DB
D2E3	53987		1 F 5 C	4 9 5 4 5 3 2 0		I T S	54011	D2FB
D303	54019						54043	D31B
D323	54051		C R	: N E X T	6 4	B Y T E S	54075	D33B
D343	54083		R :	R E T U R N	T O	C A L L E R	54107	D35B
D363	54115		4	D I G I T S	H E X	A D D R	54139	D37B
D383	54147						54171	D39B

A JOURNAL FOR OSI USERS!!

The Aardvark Journal is a bimonthly tutorial for OSI users. It features programs customized for OSI and has run articles like these:

- 1) Using String Variables.
- 2) High Speed Basic On An OSI.
- 3) Hooking a Cheap Printer To An OSI.
- 4) An OSI Disk Primer.
- 5) A Word Processor For Disk Or Tape Machines.
- 6) Moving The Disk Directory Off Track 12.

First year issues already available!  
\$9.00 per year (6 issues)

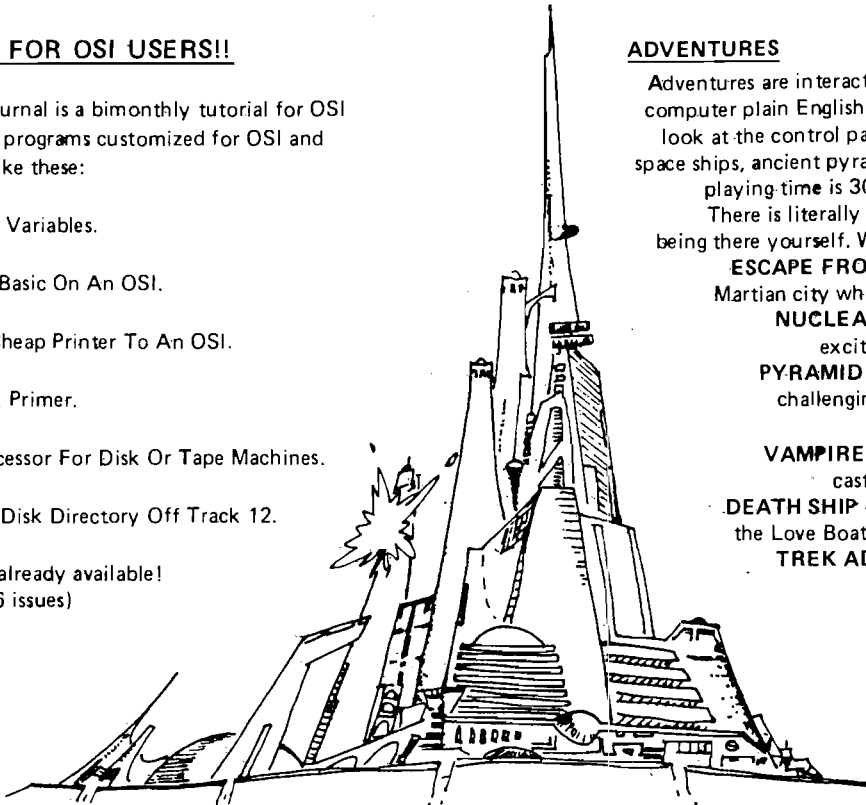
ADVENTURES

Adventures are interactive fantasies where you give the computer plain English commands (i.e. take the sword, look at the control panel.) as you explore alien cities, space ships, ancient pyramids and sunken subs. Average playing time is 30 to 40 hours in several sessions.

There is literally nothing else like them — except being there yourself. We have six adventures available.

**ESCAPE FROM MARS** — Explore an ancient Martian city while you prepare for your escape.

**NUCLEAR SUBMARINE** — Fast moving excitement at the bottom of the sea.

**PYRAMID** — Our most advanced and most challenging adventure. Takes place in our own special ancient pyramid.

**VAMPIRE CASTLE** — A day in old Drac's castle. But it's getting dark outside.

**DEATH SHIP** — It's a cruise ship — but it ain't the Love Boat and survival is far from certain.

**TREK ADVENTURE** — Takes place on a familiar starship. Almost as good as being there.

NEW SUPPORT ROMS FOR BASIC IN ROM MACHINES

**C1S** — for the C1P only, this ROM adds full screen edit functions (insert, delete, change characters in a basic line). Software selectable scroll windows, two instant screen clears (scroll window only and full screen), software chose of OSI or standard keyboard format, Bell support, 600 Baud cassette support, and a few other features. It plugs in in place of the OSI ROM. NOTE: this ROM also supports video conversions for 24, 32, 48 or 64 characters per line. Replaces video swap tape on C1P model 2. All that and it sells for a measly \$39.95.

**C1E/C2E** for C1/C2/C4/C8 Basic in ROM machines. This ROM adds full screen editing, software selectable scroll windows, keyboard correction (software selectable), and contains an extended machine code monitor. It has breakpoint utilities, machine code load and save, block memory move and hex dump utilities. A must for the machine code programmer replaces OSI support ROM. Requires installation of additional chip when installed in a C2 or C4. C1 installation requires only a jumper move. Specify system \$59.95.

DISK UTILITIES

**SUPER COPY** — Single Disk Copier  
This copy program makes multiple copies, copies track zero, and copies all the tracks that your memory can hold at one time — up to 12 tracks at a pass. It's almost as fast as dual disk copying. — \$15.95

**MAXIPROSS (WORD PROCESSOR)** — 65D polled keyboard only - has global and line edit, right and left margin justification, imbedded margin commands, choice of single, double or triple spacing, file access capabilities and all the features of a major word processor — and it's only \$39.95.

P.C. BOARDS

**MEMORY BOARDS!** — for the C1P, — and they contain parallel ports!

Aardvark's new memory board supports 8K of 2114's and has provision for a FIA to give a parallel ports! It sells as a bare board for \$29.95. When assembled, the board plugs into the expansion connector on the 600 board. Available now!

**PROM BURNER FOR THE C1P** — Burns single supply 2716's. Bare board — \$24.95.

**MOTHER BOARD** — Expand your expansion connector from one to five connectors or use it to adapt our C1P boards to your C4/8P. — \$14.95.

ARCADE AND VIDEO GAMES

**GALAXIA** one of the fastest and finest arcade games ever written for the OSI, this one features rows of evasive, hardhitting, dogfighting aliens thirsty for your blood. For those who loved (and tired of) Alien Invaders. — P.S. The price is a giveaway. SPECIFY SYSTEM!  
Cassette \$9.95 — Disk \$12.95

**TIME TREK (8K)** — real time Startrek action. See your torpedoes move across the screen! Real graphics — no more scrolling displays. \$9.95

**INTERCEPTOR C1P ONLY!** An all machine code program as fast and smooth as the arcades. You use your interceptor to protect your cities from hordes of enemy invaders. A pair of automatic cannons help out, but the action speeds up with each wave of incoming ships. The fastest and most exciting C1P game yet.  
C1P Cassette \$19.95

**MINOS** — A game with amazing 3D graphics. You see a maze from the top, the screen blanks, and then you are in the maze at ground level, finding your way through on foot. Realistic enough to cause claustrophobia. — \$12.95

SINGLE STEPPER / MONITOR

This is probably the finest debugging tool for machine code ever offered for OSI systems. Its trace function allows you to single step through a machine code program while it continuously displays the A, X, Y and status registers and the program and stack pointers. You can change any of the registers or pointers or any memory location at any time under program control. It takes well under 1k and can be relocated anywhere in free memory. It is a fine tool for all systems — and the best news of all is the extremely low price we put on it. — Tape \$19.95 — Disk \$24.95

**FOR DISK SYSTEMS** — (65D, polled keyboard and standard video only.)

**SUPERDISK.** Contains a basic text editor with functions similar to the above programs and also contains a renamer, variable table maker, search and new BEXEC\* programs. The BEXEC\* provides a directory, create, delete, and change utilities on one track and is worth having by itself. — \$24.95 on 5" disk - \$26.95 on 8".

AARDVARK IS NOW AN OSI DEALER!

Now you can buy from people who can support your machine.

— THIS MONTH'S SPECIALS —

Superboard II	\$279
C1P Model II	429
C4P	749
8K 610 board for C1P	269
Epson MX-80 printer with RS232 installed	595

... and we'll include a free Text Editor Tape with each machine!

True 32X32 Video Mod Plans for C1P  
(4 Chips \$3.00 Crystal Required)  
\$7.95



This is only a partial listing of what we have to offer. We now offer over 100 programs, data sheets, ROMS, and boards for OSI systems. Our \$1.00 catalog lists it all and contains free program listings and programming hints to boot.



OSI

Aardvark Technical Services • 1690 Bolton • Walled Lake, MI 48088

(313) 669-3110

OSI

# MICRO

## Classified

*Each classified ad costs only \$10.00 per insertion, pre-paid with typewritten copy. These ads are limited to one per company/individual per month. Please limit these entries to less than 40 words. (Oversized ads will be rejected and returned.) Title line, name and address are not considered in count. Ads received before the 20th of the second month preceding the month of publication will be published in next issue, i.e. May 20th for the July issue. For further information, call (617) 256-5515.*

### Atari Game Owners

Turn your Video Game Console into a 6502 microcomputer with our MagiCard. Write programs using your keyboard controllers, with full access to Atari video capabilities. Includes 1K bytes RAM, ROM monitor, disassembler, instruction manual, cassette interface plans. Send \$49.88 (Illinois add 6%) to:

Computer Magic Inc.  
P.O. 3383M  
Fox Valley Center  
Aurora, Illinois 60505

### Spanish Hangman

2,000 SPANISH words and sentences taught in a fun way on the Apple. Send for your school's free 30-day evaluation diskette, from:

George Earl  
1302 South General McMullen  
San Antonio, Texas 78237

### AIM-65 Newsletter \* \* Target

Target provides hardware and software information useful for AIM-65 and 6502 users. The 1979 and 1980 back issues are available for \$12.00 while a continuing subscription costs \$6.00. Just write to:

Target  
Donald Clem  
Route 2  
Spenserville, Ohio 45887

### Turnkey Medical Billing System

Interactive data entry. Automated file management. Outputs: Patient statements, Universal Claim Forms, financial reports. Customized by user-developed text files. Requires Apple, Applesoft, printer. One disk drive manages 150 accounts; 2 drives—400 accounts. \$350 for programs and 25 pp documentation.

Jerome B. Blumenthal, M.D.  
7500 E. Hellman  
Rosemead, California 91770

### C1P Extended Monitor

2K EPROM has 14 cursor control/editing functions, improved keyboard decoding. Machine language save, load, display, modify, move, breakpoint processing and much more. For 24, 32, 64 char/line. \$39.95 plus \$1.00 shipping. \$1.00 for complete information.

Bustek  
P.O. Box A  
St. Charles, Missouri 63301

### PET Machine Language Guide

Comprehensive manual to aid machine language programmer. More than 30 routines are fully detailed so that the reader can put them to immediate use. OLD or NEW ROMs. \$6.95 + .75 postage. VISA & Mastercharge accepted.

Abacus Software  
P.O. Box 7211  
Grand Rapids, Michigan 49510

### New Catalog

Includes hardware and software for C1P/Superboard and other computers. Games, simulations, utilities, chips, boards and programs. Send \$1.00 for catalog and sample program (refund order).

Software Plus +  
1818 Ridge Avenue  
Florence, Alabama 35630

### Ohio Scientific

SPACE WARS: for C1P or Superboard. Put your ship through S-turns, fire lasers at the enemy. WIZARDS & WARRIORS: fight the creatures in dungeons, search for treasure. When finish one dungeon there's another. W & W for all OSI. SPACE WARRIORS: \$4.95, WIZARDS & WARRIORS: \$4.95, cassette only.

Danny Havey  
14430 Whittier Blvd., Suite 109  
Whittier, California 90605

### Accounts Receivable by SBSC

For the Apple II. This conversion of Osborne's Accounts Receivable software contains the same capabilities, plus enhancements that increase your Apple's flexibility, speed, and performance. alone or integrate with existing Ge Ledger program. Retail price \$180.

Small Business Computer System  
4140 Greenwood  
Lincoln, Nebraska 68504

### AppleChess Openings

This program contains 1310 half moves, 86 final positions that are reached in less than 7 moves and no more than 10 moves. Requires 48K, Applesoft, Integer in ROM drive, chess board and pieces. Available only on disk (please specify 3.2 or 3.3). Send \$20 in check or money order to:

Bill Cowan  
24329 Westwood Dr.  
Westlake, Ohio 44145

# OHIO SCIENTIFIC USERS

SOFTWARE - GAME AND UTILITY PROGRAMS FOR AS LOW AS \$1.00. ALL WITH LISTINGS AND COMPLETE DOCUMENTATION.

KITS - UPDATE YOUR COMPUTER TO PLAY MUSIC, INCREASE OPERATING SPEED, HIGH RESOLUTION GRAPHICS AND MUCH MORE. KITS INCLUDE PARTS AND COMPLETE ASSEMBLY INSTRUCTIONS. LOW AS \$3.00.

OUR \$1.00 CATALOG INCLUDES OSI PROGRAMMING TIPS PLUS DESCRIPTIONS OF AVAILABLE PROGRAMS AND KITS.

MITTENDORF ENGINEERING 905 VILLA NUEVA DR. LITCHFIELD PARK, AZ 85340

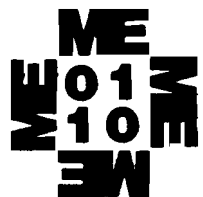

# Machine Language to DATA Statement Conversion

Many times machine language routines are implemented in BASIC programs as DATA statements. This article will demonstrate an easy and accurate way to incorporate the routines into your BASIC programs.

Les Cain  
1319 N. 16th  
Grand Junction, Colorado 81501

Anyone who has written machine code routines and then tried to convert them to DATA statements to include in a BASIC program, knows the problems encountered in converting hex to decimal, and then typing in the DATA statements. This method works but is slow and is subject to numerous errors.

While converting an Othello program from Mr. Earl Morris to work on disk BASIC, I had to change some of the machine code to work with the disk USR[X] functions, and then redo the DATA statements to POKE in the correct code. That was too much trouble, so I wrote the following short program to do the work for me.

Lines 70 through 110 prompt for the beginning and the ending addresses of the machine code. Subroutine 250 enters with a hex number and returns a decimal number. If you are just looking at the data then line numbers are not needed, and the beginning and ending addresses are printed.

To record on tape, line numbers are required. Be sure line numbers are compatible with the BASIC program. Change line 155 [cassette tape output]

to suit your particular system. Change line 230 to a REM statement, then turn on recorder and run the program. Output will have line numbers and DATA statements along with the machine

code in decimal format. Then all that is required is to input from cassette into your BASIC program, put in the READ and POKE statements and you're on your way.

MICRO

```
1 REM MACHINE CODE TO DATA STATEMENT ROUTINE
2 REM BY LES CAIN
3 REM MICRO #36 JUNE 1981
4 REM
10 DIM D(4)
20 FOR I = 1 TO 30: PRINT : NEXT
30 PRINT TAB( 20);"PEEKs AT MACHINE CODE "
40 PRINT TAB( 20);"AND RETURNS DATA"
50 FOR I = 1 TO 10: PRINT : NEXT
70 INPUT "BEGIN ADDRESS";BE$:N$ = BE$
90 GOSUB 250:B = D:C = B
100 INPUT "END ADDRESS";EN$:N$ = EN$
110 GOSUB 250:E = D:F = E
120 GOSUB 330
130 PRINT : PRINT : PRINT
140 PRINT "DECIMAL";B; TAB( 20);"$";BE$
150 PRINT : PRINT : PRINT
155 REM --INSERT ROUTINE TO OUTPUT TO TAPE AT THIS LINE
170 IF F > = C THEN PRINT LN;: PRINT "DATA";
180 AA$ = ""
190 FOR J = B TO B + 15
200 A$ = STR$( PEEK (J))
210 AB$ = ""
220 FOR I = 2 TO LEN (A$):AB$ = AB$ + MID$( A$,I,1): NEXT
225 AA$ = AA$ + AB$
226 F = F - 1
227 IF J < > B + 15 AND F > C THEN AA$ = AA$ + ","
228 IF F < = C THEN PRINT AA$: GOTO 230
229 NEXT : PRINT AA$:B = B + 16:LN = LN + IN: GOTO 170
230 PRINT : PRINT : PRINT "DECIMAL";E; TAB( 20);"HEX $"EN$
231 GOTO 70
250 J = 1
260 FOR I = 1 TO 4:D(I) = 0: NEXT
270 FOR I = 1 TO 4
280 D(I) = ASC ( MID$( N$,J)) - 48
290 IF D(I) > 9 THEN D(I) = D(I) - 7
300 J = J + 1: NEXT
310 D = 4096 * D(1) + 256 * D(2) + 16 * D(3) + D(4)
320 RETURN
330 INPUT "BEGIN LINE NUMBER";LN
340 INPUT "INCREMENT";IN
350 RETURN
```

# we carry it all...

## Atari® Software

VisiCalc .....	149
CX4101 Invitation to Programming 1 ..	17
CX4104 Mailing List .....	17
CX4102 Kingdom .....	13
CX4103 Statistics .....	17
CX4105 Blackjack .....	13
CX4106 Invitation to Programming 2 ..	20
CX4107 Biorhythm .....	13
CX4108 Hangman .....	13
CX4109 Graph It .....	17
CX4111 Space Invader .....	17
CX4110 Touch Typing .....	20
CX4115 Mortgage & Loan Analysis .....	13
CX4116 Personal Fitness Program .....	13
CX4117 Invitation to Programming 3 ..	20
CX4118 Conversational French .....	45
CX4119 Conversational German .....	45
CX4120 Conversational Spanish .....	45
CX4121 Energy Czar .....	13
CX4125 Conversational Italian .....	45
CX8108 Stock Charting .....	20
CXL4001 Educational System Master ..	21
CXL4002 Basic Computing Language ..	46
CXL4003 Assembler Editor .....	46
CXL4004 Basketball .....	30
CXL4005 Video Easel .....	30
CXL4006 Super Breakout .....	30
CXL4007 Music Composer .....	45
CXL4009 Chess .....	30
CXL4010 3-D Tic-Tac-Toe .....	30
CXL4011 Star Raiders .....	45
CXL4015 TeleLink .....	20

Talk & Teach Courseware:  
CX6001 to CX6017 .....



Atari® 800™  
Personal Computer  
32K RAM

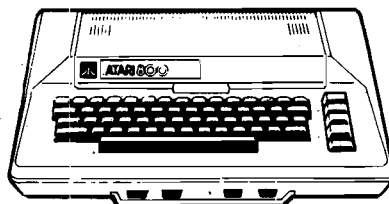

**\$759**

## Printers

NEC 5530 .....	2495	Starwriter .....	\$1495
Diablo 630 .....	2195	Trendcom 200 .....	489
Trendcom 100 .....	299	Paper Tiger 445G .....	769
		Paper Tiger 460G .....	1219
		Epson MX-80 .....	499
		Tally 8024 .....	1699

everything for Commodore  
and Atari

## Atari® Peripherals:

400 8K .....	\$ 419
400 16K .....	449
410 Recorder .....	62
810 Disk .....	479
815 Disk .....	1199
822 Printer .....	359
825 Printer .....	759
830 Modem .....	159
850 Interface Module .....	164

## Atari® Accessories

CX852 8K RAM .....	94
CX853 16K RAM .....	149
CX70 Light Pen .....	64
CX30 Paddle .....	18
CX40 Joystick .....	18
CX86 Printer Cable .....	42
CO16345 822 Thermal Printer Paper .....	5
CAO16087 825 80-col. Printer Ribbon (3/box) .....	17
Microtek 16K RAM .....	99
Microtek 32K RAM .....	179

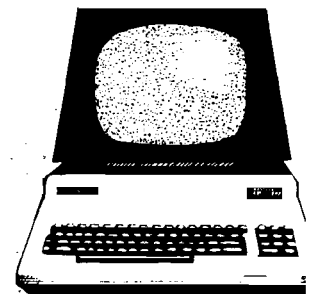

**commodore**

VIC-20 .....	\$ 27
8096 .....	185
4032 .....	105
8032 .....	145
CBM 4022 Printer .....	65
CBM 4040 Drive .....	99
CBM 8050 Drive .....	144
CBM C2N Drive .....	8
PET-IEEE Cable .....	3
IEEE-IEEE Cable .....	4

## Disks

Maxell Disks .....	10 for \$3
Syncom Disks .....	10 for 2
Atari Disks .....	5 for 2

## Software

EBS Accounts Receivable Inventory System .....	\$59
Dr. Daley Mailing List .....	12
Dr. Daley Inventory .....	8
OZZ Information System .....	32
BPI General Ledger .....	32
Tax Package .....	39
Dow Jones Portfolio Management ..	12
Pascal .....	23
WordPro 3 (40 col.) .....	18
WordPro 4 (80 col.) .....	27
WordPro 4 Plus (80 col.) .....	33

No Risk -

No Deposit On  
Phone Orders -

COD or  
Credit Card - Shipped Same Day You Call\*  
Prepaid Orders Receive Free Shipping

\* on all in stock units

Computer Mail Order

501 E. Third St., Williamsport, PA 17701 (717) 323-7921

Please Call Between 11AM & 6PM  
(Eastern Standard Time)

**(800) 233-8950**



# Telephone Directory/Dialer for the AIM

Turn your AIM into a telephone operator with a directory and dialer program.

Rodney A. Kreuter  
Route 1, Box 310  
Fincastle, Virginia 24090

Although using a micro to dial a telephone is certainly not a new idea, I think you'll find this directory/dialer a useful program to add to your AIM 65 library. The directory/dialer can store and dial approximately 100 names and phone numbers in a 4K AIM 65. Since it is written entirely in assembly language, you will not need the BASIC or assembler ROMS. However, you will need at least 2K of RAM to hold the program and the directory.

The directory is simply the list of names and phone numbers that you wish to store. There are a few restrictions: the name can only be 16 characters long (see program modification for longer names). The name can be alpha/numeric but must not contain an '=' sign. The name must be followed by an '=' sign. The number must not contain any character that is not numeric, and each entry must end with a carriage return. For example:

- Valid DAD = 5630211[CR]
- Valid HARDWARE ON 2nd = 3894217[CR]
- Invalid MARY = (703)9458512 [CR] ( ) are not numeric
- Invalid JOE = 814-502-4907 [CR] - - are not numeric

Table 1

Location	Name	Description
\$0000,0001	PNTR	This is the pointer used to store the directory in RAM.
\$0002,0003	BTMPTR	The bottom or end RAM location of your directory.
\$0004,0005	MSGPTR	Message pointer—points to the message string.
\$0006,0007	FINPTR	Find pointer—used by string search to find the string.
\$0008	LEN	Length of the string entered.
\$0020 - 002F	STRING	User entered string.
\$0030 - ??	NUMBER	ASCII of number to be dialed.
\$0200,0201	----	Image of PNTR.
\$0202,0203	----	Directory end address.
\$0204,0205	----	Directory start address.

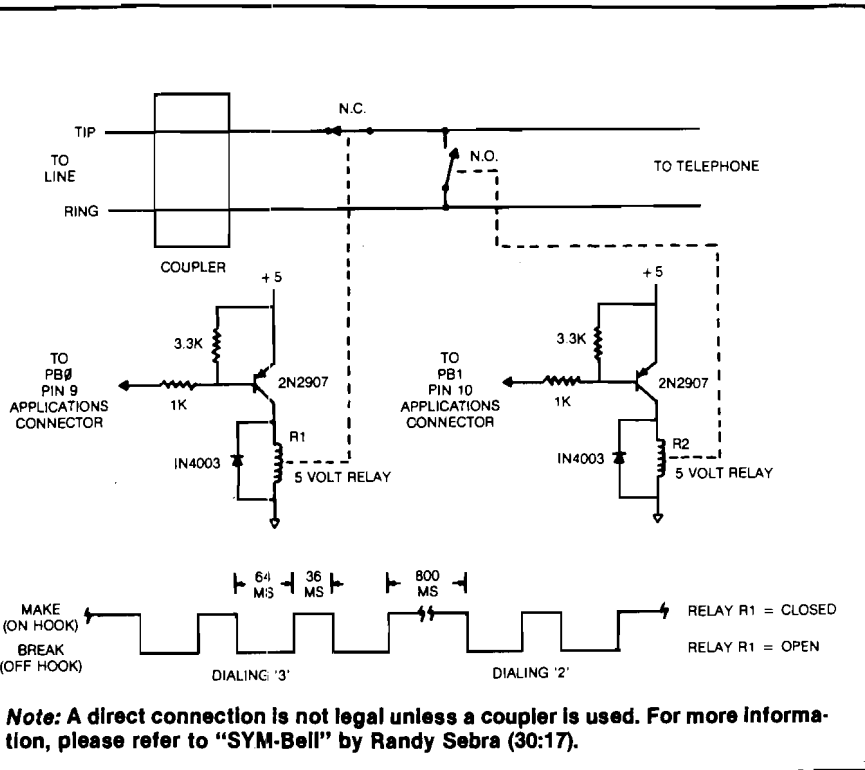

## About the Program

The directory/dialer can be divided into three basic programs:

1. *Entry program*: This allows you to assign directory storage space and does the actual storing of your data.

2. *String search program*: This program scans your directory and finds the number you wish to dial.

3. *Interface program*: This program does the actual dialing by using two relays connected to one of the user ports.

Since this program is not heavily commented [I barely had enough RAM to assemble it], some definitions will help in understanding the program. They appear in table 1.

The three pointers from \$0200-\$0205 were put there so that they are saved on cassette when the program is dumped. This way the directory can always be updated. Be sure to dump from \$0200 to the end of your directory.

After loading the program begin execution at \$0210. *Note*: It does not begin at \$0200.

The following is a sample run:

```
AIM: Dial (D) or Enter (E)?
USER: E
AIM: New (N) or Add (A)?
USER: N
```

*Note*: The first time the program is run you must respond with New in order to assign directory space. Later you will add additional numbers by replying ADD (A).

```
AIM: From =
USER: 0450 [CR]
AIM: To =
USER: 0600 [CR]
AIM: ^
USER: ; (Semi-colon gets you
out of the entry mode)
AIM: Dial (D) or Enter?
USER: D
AIM: Name ?
USER: Rod
AIM: Rod = 4732128
USER: (Pick up the phone and
wait for dial tone. Hit any key
and the AIM will begin dialing)
AIM: Redial?
USER: (Any key except 'Y' if you
do not wish to redial, 'Y' if you do)
```

```
0800 ;*****
0800 ;*
0800 ;* TELEPHONE DIRECTORY/DIALER FOR AIM 65 *
0800 ;*
0800 ;* BY RODNEY A. KREUTER *
0800 ;*****
0800 ;*
0800 ;AIM SUBROUTINES
0800 ;
0800 BLANK2 EQU $E83B
0800 CRLW EQU $EA13
0800 FROM EQU $E7A3
0800 OUTPUT EQU $E97A
0800 READ EQU $E93C
0800 REDOUT EQU $E973
0800 TO EQU $E7A7
0800 ;
0800 PNTR EPZ $00 ;RAM POINTER
0800 BTMPTR EPZ $02 ;END OF RAM
0800 MSGPTR EPZ $04
0800 FINPTR EPZ $06 ;USED TO FIND STRIN
0800 LEN EPZ $08 ;LENGTH OF STRING
0800 STRING EPZ $20
0800 NUMBER EPZ $30
0800 ;
0210 ORG $210
0210 OBJ $800
0210 ;
0210 A200 GO LDX #$00
0212 207C03 JSR MSGSUB
0215 203CE9 LPO JSR READ
0218 C945 CMP #'E' ;ENTER?
021A F006 BEQ ENTER
021C C944 CMP #'D' ;DIAL?
021E F070 BEQ DIAL
0220 D0F3 BNE LPO
0222 ;
0222 A201 ENTER LDX #$01
0224 207C03 JSR MSGSUB
0227 203CE9 LP1 JSR READ
022A C941 CMP #'A' ;ADD?
022C F030 BEQ ADD
022E C94E CMP #'N' ;NEW?
0230 F002 BEQ NEW
0232 D0F3 BNE LP1
0234 ;
0234 2013EA NEW JSR CRLW
0237 20A3E7 JSR FROM
023A AD1CA4 LDA $A41C
023D 8D0002 STA $200
0240 8D0402 STA $204
0243 AD1DA4 LDA $A41D
0246 8D0102 STA $201
0249 8D0502 STA $205
024C 203BE8 JSR BLANK2
024F ;
024F 20A7E7 MORE JSR TO
0252 AD1CA4 LDA $A41C
0255 8D0202 STA $202
0258 AD1DA4 LDA $A41D
025B 8D0302 STA $203
025E ;
025E ;MOVE POINTER TO ZERO PAGE
025E ;
025E ADD JSR CRLW
0261 A203 LDX #$03
0263 BD0002 LP2 LDA $200,X
0266 9500 STA $00,X
0268 CA DEX
0269 10F8 BPL LP2
026B A000 LDY #$00
026D ;
026D ;GET HIS INPUT
026D ;
026D PUTIN JSR REDOUT
0270 9100 STA (PNTR),Y ;PUT IT IN RAM
0272 C93B CMP #','
0274 F09A BEQ GO
0276 C90D CMP #$0D
0278 D003 BNE NCR
```



```

027A 2013EA          JSR CRLW
027D                ;
027D                ;NO CARRIAGE RETURN
027D                ;
027D 209803         NCR   JSR INCPTR
0280 90EB           BCC PUTIN
0282 A202           LDX #$02
0284 207C03         JSR MSGSUB
0287 203CE9         JSR READ
028A 2013EA         JSR CRLW
028D 4C4F02         JMP MORE
0290                ;
0290 A203           DIAL  LDX #$03
0292 207C03         JSR MSGSUB
0295 A200           LDX #$00
0297 2073E9         LP3   JSR REDOUT
029A 9520           STA STRING,X
029C C90D           CMP #$0D
029E F003           BEQ LP7
02A0 E8             INX
02A1 D0F4           BNE LP3
02A3 CA             LP7   DEX
02A4 8608           STX LEN
02A6 AD0402         LDA $204
02A9 8506           STA FINPTR
02AB AD0502         LDA $205
02AE 8507           STA FINPTR+1
02B0                ;
02B0                ;FIND HIS STRING
02B0                ;
02B0 A200           LP5   LDX #$00
02B2 A000           LDY #$00
02B4 B106           LP4   LDA (FINPTR),Y
02B6 D520           CMP STRING,X
02B8 D00A           BNE INCFIN
02BA B520           LDA STRING,X
02BC E408           CPX LEN
02BE F029           BEQ DIALIT
02C0 E8             INX
02C1 C8             INY
02C2 D0F0           BNE LP4
02C4 18             INCFIN CLC
02C5 D8             CLD
02C6 A506           LDA FINPTR
02C8 6901           ADC #$01
02CA 8506           STA FINPTR
02CC A507           LDA FINPTR+1
02CE 6900           ADC #$00
02D0 8507           STA FINPTR+1
02D2 C503           CMP BTMPTR+1
02D4 90DA           BCC LP5           ;OK
02D6 D006           BNE NOFIND
02D8 A506           LDA FINPTR
02DA C502           CMP BTMPTR
02DC 90D2           BCC LP5           ;OK
02DE                ;
02DE A205           NOFIND LDX #$05
02E0 207C03         JSR MSGSUB
02E3 203CE9         JSR READ
02E6 4C9002         JMP DIAL
02E9                ;
02E9 2013EA         DIALIT JSR CRLW
02EC A000           LDY #$00
02EE B106           LP8   LDA (FINPTR),Y
02F0 C90D           CMP #$0D
02F2 F006           BEQ DODIAL
02F4 207AE9         JSR OUTPUT
02F7 C8             INY
02F8 D0F4           BNE LP8
02FA                ;
02FA 203CE9         DODIAL JSR READ
02FD A000           LDY #$00
02FF A200           LDX #$00
0301 B106           LP9   LDA (FINPTR),Y
0303 C93D           CMP #'='
0305 F003           BEQ GOTIT
0307 C8             INY
0308 D0F7           BNE LP9
030A                ;
030A C8             GOTIT INY
030B B106           LP10  LDA (FINPTR),Y

```

(continued)

## Special Cases

If the AIM cannot find the string you have entered it will respond with:

AIM: Can't find that name.

Hit any key to get back to the string enter point.

If your directory is full, AIM will respond with:

AIM: Out of memory.

Hit any key and AIM will ask for a new directory ending address.

## Hardware

The hardware required to do the actual dialing is shown in figure 1 and is fairly straightforward. Dial pulsing was chosen instead of tones since it is still the only universal method of dialing. Relay R2 is used to short the phone during dialing to suppress annoying clicks and pops. Relay R1 does the actual pulsing.

## Program Modifications

The dialer/directory was not written to be relocatable since the AIM 65 is the only machine on which it will run. Modifying it to run on other machines will require a fair amount of work. The only references that make it difficult to relocate in the AIM are the six references to \$0200 - \$0205.

Longer names may be used by relocating "number" in page zero. This will allow the string to be longer without overrunning the number storage.

The dialing time is set up for standard 10 pulses/second dialing. The make time [set up by subroutine TIM64] is 64 milliseconds. The break time (TIM36) is 36 milliseconds. Inter-digit time is 800 milliseconds caused by jumping to subroutine TIM50 sixteen times. Other dialing methods may call for a change in this timing.

---

Rod Kreuter is a senior circuit designer for International Telephone and Telegraph in Roanoke, Virginia. At work he uses a Rockwell System 65 to develop 6502 machine controls for ITT, and has an AIM 65 at home. His home system consists of a 4K AIM 65 with a homebrew CRT interface similar to the one described in Rockwell's application note R6500 N1.2. His hobbies include writing, skiing, and photography.

---

MICRO

# APPLE II\* SOFTWARE FROM POWERSOFT

P. O. BOX 157  
PITMAN, NEW JERSEY 08071  
(609) 589-5500

**SUPER CHECKBOOK III** - A vastly improved version of our popular selling program. With new features such as: simplified but powerful transaction entry and modification routines, new reconciliation routines, additional features such as 30 percent increase in the total number of checks handled, posting of interest from interest bearing checking accounts, automatic teller transactions, bullet proof error handling, and smart disk routines. Plus the program still contains the options of bar graphs, sorting, activities, and account status. . . . .  
Disk Only/Applesoft \$49.95

**ADDRESS FILE GENERATOR** - Allows the user to create any number of four types of address files: Holiday, Birthday, Home and Commercial. The program contains a menu of seven major commands used to: Create, Add, Edit, Display, Search, Sort, and Reorganize Files. Up to three fields may be used for the sort criteria. Major commands have subordinate commands which adds to the flexibility of this powerful software system. We doubt you could buy a better program for maintaining and printing address files. . . . .  
Disk Only/Apple Printer Card/Applesoft \$24.95

**SPANISH VOCABULARY DRILL  
FRENCH VOCABULARY DRILL  
ITALIAN VOCABULARY DRILL  
GERMAN VOCABULARY DRILL**

These programs provide practice in foreign language vocabulary by means of three types of drills: *Matching, Foreign Language to English, and English to Foreign Language.* Although the diskette comes with some lessons on it, these are intended to be samples. The most effective way to use these programs is to enter your own lessons from the course you are studying. To facilitate the entry of new lessons, each program contains a complete Lesson Editor which has various entry and revision options. The manual also contains instructions for converting the programs to other languages. . . . .  
Disk Only/Applesoft each \$24.95

**SPACE TREK J** - Your mission is to patrol the galaxy, and to seek out and destroy the ships of the Klarian fleet. At your command is the starship Lexington. The Lexington has a wide variety of weapons, sensors and other devices useful in your mission. There are two kinds of Klarian ships Regular and Super. Regular Klarians have an average energy supply of 5000 to 12000 quarks while Super Klarians have 12500 to 15000 quarks and are protected from some of the Lexington's weapons and attack strategies. . . . .  
Disk Only/Applesoft \$19.95

**WORLD OF ODYSSEY** - An adventure game utilizing the full power of Disk II, which enables the player to explore 353 rooms on 6 different levels full of dragons, dwarfs, orcs, goblins, gold and jewels. The program allows the player to stop the game and to resume at a later time. . . . .  
Disk Only/Applesoft \$24.95

**GALACTIC EMPIRES** - Pits 1 to 20 players against each other and the computer in a struggle for control of up to 40 star systems. The players compete by sending out fleets of ships to capture neutral planets and to attack the colonies of other players. The victor is the player who controls the most stars by game's end. . . . .  
Applesoft \$14.95

**Dealer Inquiries Invited**

Visa and MasterCard, Check or Money Order include \$2.00 for shipping and handling. C.O.D. \$2.00 additional.

\*Apple II and Applesoft are the registered trademarks of APPLE COMPUTER INC.

**POWERSOFT**  
P. O. BOX 157  
PITMAN, NEW JERSEY 08071  
(609) 589-5500

```

030D 9530          STA NUMBER,X
030F C90D          CMP #S0D
0311 F004          BEQ PULSE
0313 C8            INY
0314 E8            INX
0315 D0F4          BNE LP10
0317              ;
0317 A200          PULSE LDX #S00
0319 8E0BA0        STX $A00B
031C 8E0EA0        STX $A00E
031F A203          LDX #S03
0321 8E02A0        STX $A002
0324 8E00A0        STX $A000
0327 A200          LDX #S00
0329 B530          LP11  LDA NUMBER,X
032B C90D          CMP #S0D
032D F036          BEQ DONE
032F C930          CMP #S30          ;IS IT A ZERO?
0331 D005          BNE NTZERO
0333 A00A          LDY #S0A
0335 4C3D03        JMP RELAY
0338 38            NTZERO SEC
0339 D8            CLD
033A E930          SBC #S30
033C A8            TAY
033D              ;
033D A901          RELAY LDA #S01
033F 8D00A0        STA $A000          ;CLOSE RELAY R2
0342 8A            TXA
0343 48            PHA
0344 A20F          LDX #S0F          ;800 MS INTERDIGIT
0346 20C903        LP12  JSR TIM50
0349 CA            DEX
034A D0FA          BNE LP12
034C 68            PLA
034D AA            TAX
034E A900          LP14  LDA #S00
0350 8D00A0        STA $A000          ;OPEN RELAY R1
0353 20D603        JSR TIM64
0356 A901          LDA #S01
0358 8D00A0        STA $A000          ;CLOSE RELAY R1
035B 20BC03        JSR TIM36
035E 88            DEY
035F D0ED          BNE LP14
0361 E8            INX
0362 4C2903        JMP LP11
0365 A9FF          DONE  LDA #SFF
0367 8D00A0        STA $A000          ;OPEN RELAY R2
036A A204          LDX #S04
036C 207C03        JSR MSGSUB
036F 203CE9        JSR READ
0372 C959          CMP #'Y'
0374 D003          BNE REDO
0376 4CE902        JMP DIALIT
0379 4C1002        REDO  JMP GO
037C              ;
037C              ;** SUBS **
037C              ;
037C 2013EA        MSGSUB JSR CRLOW
037F BD4104        LDA MSGTBO,X
0382 8504          STA MSGPTR
0384 BD4704        LDA MSGTB1,X
0387 8505          STA MSGPTR+1
0389 A000          LDY #S00
038B B104          MSLP  LDA (MSGPTR),Y
038D C93B          CMP #' ';
038F F006          BEQ MSOUT
0391 207AE9        JSR OUTPUT
0394 C8            INY
0395 D0F4          BNE MSLP
0397 60            MSOUT RTS
0398              ;
0398 18            INCPTR CLC
0399 D8            CLD
039A A500          LDA PNTR
039C 6901          ADC #S01
039E 8500          STA PNTR
03A0 8D0002        STA $200
03A3 A501          LDA PNTR+1
03A5 6900          ADC #S00
03A7 8501          STA PNTR+1

```

```

03A9 8D0102          STA $201
03AC C503            CMP BTMPTR+1
03AE 900A            BCC OK0
03B0 D006            BNE NOTOK
03B2 A500            LDA PNTR
03B4 C502            CMP BTMPTR
03B6 9002            BCC OK0
03B8 38              NOTOK SEC
03B9 60              RTS
03BA 18              OK0 CLC
03BB 60              RTS
03BC                  ;
03BC A9A0            TIM36 LDA $SA0          ; 36 MS
03BE 8D08A0          STA $A008
03C1 A98C            LDA $S8C
03C3 8D09A0          STA $A009
03C6 4CE003          JMP TIMOUT
03C9                  ;
03C9 A950            TIM50 LDA $$50          ; 50 MS
03CB 8D08A0          STA $A008
03CE A9C3            LDA $C3
03D0 8D09A0          STA $A009
03D3 4CE003          JMP TIMOUT
03D6                  ;
03D6 A900            TIM64 LDA $$00          ; 64 MS
03D8 8D08A0          STA $A008
03DB A9FF            LDA $FFF
03DD 8D09A0          STA $A009
03E0                  ;
03E0 AD0DA0          TIMOUT LDA $A00D
03E3 2920            AND $S20
03E5 F0F9            BEQ TIMOUT
03E7 60              RTS
03E8                  ;
03E8                  ;** TABLES **
03E8                  ;
03E8 444941          M0      ASC 'DIAL(D) OR ENTER(E)?;'
03EB 4C2844
03EE 29204F
03F1 522045
03F4 4E5445
03F7 522845
03FA 293F3B
03FD 4E4557          M1      ASC 'NEW(N) OR ADD(A)?;'
0400 284E29
0403 204F52
0406 204144
0409 442841
040C 293F3B
040F 4F5554          M2      ASC 'OUT OF MEMORY.;'
0412 204F46
0415 204D45
0418 4D4F52
041B 592E3B
041E 4E414D          M3      ASC 'NAME?;'
0421 453F3B
0424 524544          M4      ASC 'REDIAL?;'
0427 49414C
042A 3F3B
042C 43414E          M5      ASC 'CAN'T FIND THAT NAME;'
042F 275420
0432 46494E
0435 442054
0438 484154
043B 204E41
043E 4D453B
0441                  ;
0441 E8              MSGTBO BYT M0
0442 FD              BYT M1
0443 0F              BYT M2
0444 1E              BYT M3
0445 24              BYT M4
0446 2C              BYT M5
0447                  ;
0447 03              MSGTB1 HBY M0
0448 03              HBY M1
0449 04              HBY M2
044A 04              HBY M3
044B 04              HBY M4
044C 04              HBY M5

```

## New Publications

(Continued from page 25)

### Graphics

**IEEE Computer Graphics and Applications**, a new quarterly which began in January 1981, is published by the IEEE Computer Society [10662 Los Vaqueros Circle, Los Alamitos, California 90720]. It is edited for designers and users in all computer graphics application areas such as business graphics; test and measurement; process control and instrumentation; navigation and guidance; consumer electronics; military electronics; patient care; petrochemicals; communication; transportation; CAD/CAM; VLSI design; education. An annual subscription is \$8.00 plus society member dues [\$14.00] or \$23.00 for nonmembers.

**Computer Graphics News** is a bimonthly tabloid to begin in September in conjunction with the annual meeting of the National Computer Graphics Association in Baltimore. The newspaper will be sponsored by the association and published by Scherago Associates, Inc. (1515 Broadway, New York, New York 10036). The publisher plans an initial controlled circulation of 25,000 to individuals interested in computer graphics.

### Biomedical

**Computers in Psychiatry/Psychology** is a 16-page bimonthly newsletter founded in 1978, devoted to the field of mental health. It covers such subjects as the computerization of the professional office and computer-based diagnosis. An annual subscription is \$25.00 from Computers in Psychiatry/Psychology, 26 Trumbull Street, New Haven, Connecticut 06511.

**National Report on Computers and Health** is an 8-page, biweekly newsletter edited for health professionals and the information processing industry — vendors, users, consultants, associations, and government. It covers scientific developments, market intelligence, new products, government regulatory activities, and new initiatives in university medical centers, in the National Center for Health Services Research, and among consultants. An annual subscription is \$192.00 for 25 issues from National Report, P.O. Box 40838, Washington, D.C. 20016.

(Continued on page 101)

# VIGIL

## INTERACTIVE GRAPHICS/GAME LANGUAGE FOR THE PET/CBM



VIGIL is an exciting new interactive language for your PET/CBM micro. VIGIL - Video Interactive Game Interpretive Language - is an easy to learn graphics and game language that lets you quickly create interactive applications.

- More than 60 powerful commands permit you to easily manipulate graphics figures on the screen
- Double density graphics give you 80 X 50 plot positions on your 40 column PET/CBM
- Large number display capability, access to two event timers and tone generation (if you have ext. speaker)
- Load and save your VIGIL programs to cassette or diskette
- Nine interactive programs demonstrate the power of VIGIL - Breakout, SpaceWar, AntiAircraft, U.F.O., SpaceBattle, Concentration, Maze, Kaleidoscope & Fortune
- Comprehensive user's manual with complete listings of enclosed programs

VIGIL comes on cassette, or diskette ready to run on any 40 column PET/CBM micro with at least 8K of memory. Specify ROM-set when ordering. 6502 listing of the VIGIL Interpreter available separately.

	US & Canada	Foreign
VIGIL FOR Pet/CBM on Cassette or Diskette (w/9 programs)	\$35	\$40
VIGIL User's Manual (refundable with software)	\$10	\$12
VIGIL Interpreter listing (6502 Assembly language)	\$25	\$30
PET MACHINE LANGUAGE GUIDE	\$8	\$10



**ABACUS SOFTWARE**  
P. O. Box 7211  
Grand Rapids, Michigan 49510



Prices include postage. Michigan residents include 4% sales tax. Orders must be prepaid or via bankcard (Mastercard, VISA, Eurocard, Access, etc.). Include card number and expiration date.

(C) 1981 by Roy Wainwright

## Apple II Shape Table Editor makes shape table construction and editing SIMPLE

11 editing commands allow user to create shapes, modify existing shapes, save & retrieve shape tables for use with the DRAW, XDRAW and SHLOAD commands of APPLE II BASIC. Runs under firmware Applesoft Floating point BASIC w/ 32 K RAM

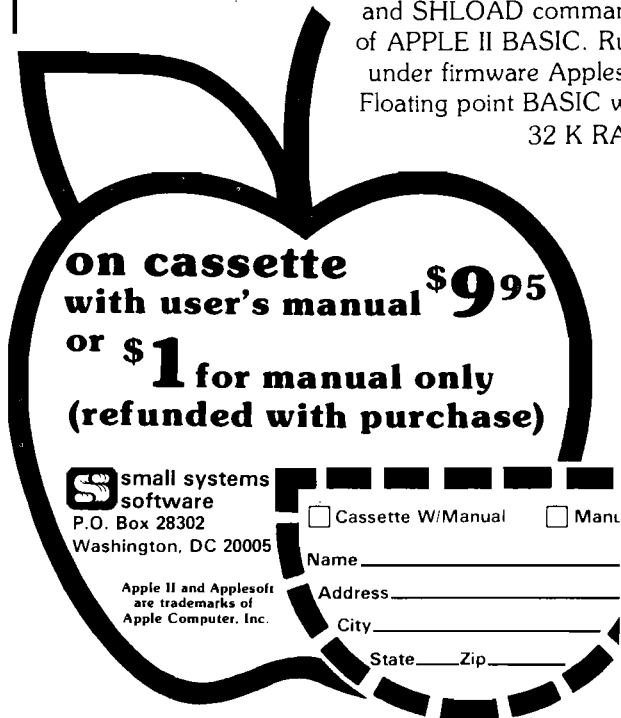

on cassette with user's manual \$9.95  
or \$1 for manual only (refunded with purchase)

**S** small systems software  
P.O. Box 28302  
Washington, DC 20005

Cassette W/Manual     Manual

Name \_\_\_\_\_

Address \_\_\_\_\_

City \_\_\_\_\_

State \_\_\_\_\_ Zip \_\_\_\_\_

Apple II and Applesoft are trademarks of Apple Computer, Inc.

# Apple Computer 48K \$1199 Axiom IMP 2 Printer \$659 with full graphics and interface

Call for prices on: *Peachtree Software*  
*BPI Software*  
*Atari*  
*Apple*  
*California Computer*  
*Mountain Computer*  
*Epson*  
*D.C. Hayes*



Call for special Atari prices.

**P M COMPUTERS (404) 860-9711**  
P.O. Box 6525, Mobile, Alabama 36660



# Apple II

# sensational software

**creative computing software**

## Haunted House

Cassette CS-4005  
\$11.95  
Requires 16K

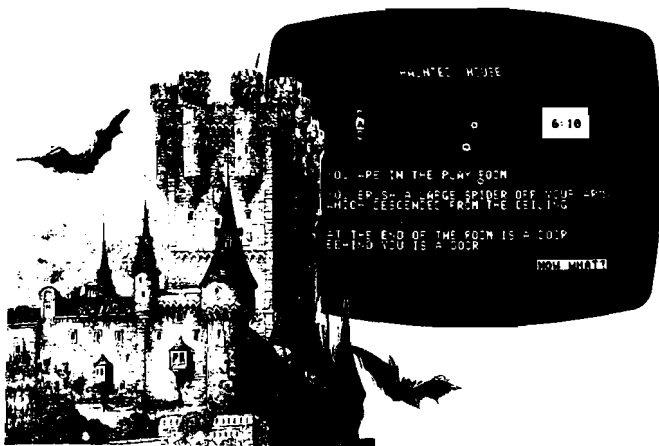

It's 6:00 pm and you have until midnight to find the secret passageway out of a large rambling HAUNTED HOUSE. During your search you'll encounter skeleton keys, charms, friendly ghosts, and evil spirits. Sound effects add to the eeriness. The layout changes in every game.

## Super Invasion

Cassette CS-4006 \$19.95  
Requires 16K Apple II or Apple II Plus

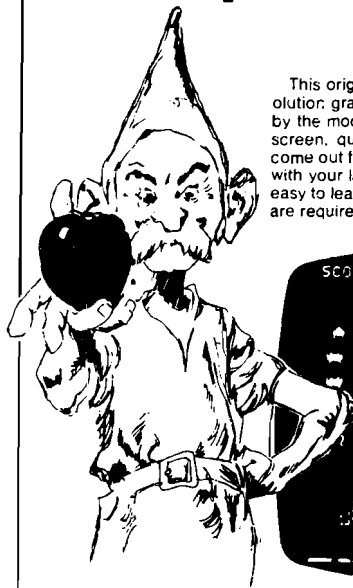

This original invasion game features superb high resolution graphics, nail biting tension and hilarious antics by the moon creatures. Fifty-five aliens whiz across the screen, quickening their descent, challenging you to come out from behind your blockades and pick them off with your lasers. A self-running "attract mode" makes it easy to learn and demonstrate the game. Game paddies are required.

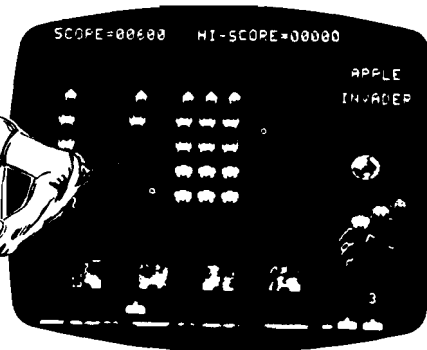

## Outdoor Games

Cassette CS-4010 \$14.95 4 Programs Requires 16K Apple II or Apple II Plus



**Forest Fire.** Use chemical retardants and backfires to control raging forest fires.

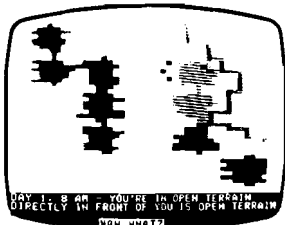

**Treasure Island I.** Your map shows buried treasure but unfortunately you don't know where you are. Try to find the treasure while moving about and observing your surroundings. You have a 3-day supply of food and water. You may find useful objects (compass, weapons, a horse) but watch out for hazards (robot guards, pirates, caves, crocodiles, mountain lions and more).

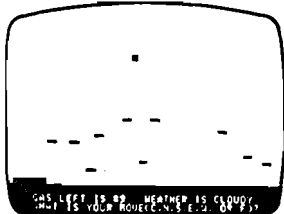

**Fishing Trip.** Try to catch flounder and salmon while avoiding logs, sharks, bad weather and running out of fuel.

**Treasure Island II.** Same game except you have to use a metal detector to find the treasure.

## Space War

Cassette CS-4009 \$14.95  
Requires 16K  
Apple II or Apple II Plus

Take command in Space War. Select from five game modes, including reverse gravity, and the battle begins. Challenge your opponent with missile fire, force him to collide with the sun or to explode upon re-entry from hyperspace. Be wary... He may circle out of sight and re-appear on the opposite side of the galaxy. (This is the classic MIT game redesigned especially for the Apple.)



### Outdoor Games and Haunted House

Disk 4504, \$24.95  
Requires 32K Apple II or Apple II Plus

This disk contains all five programs from cassettes CS-4005 and CS-4010.

### Super Invasion Space War

Disk CS-4508 \$29.95  
Requires 48K Apple II or Apple II Plus

### Order Today

To order any of these software packages, send payment plus \$2.00 postage and handling per order to Creative Computing Morris Plains, NJ 07950. Visa, MasterCard and American Express orders may be called in toll-free

Order today at no risk. If you are not completely satisfied, your money will be promptly and courteously refunded.

**Attn: Doreen**  
Creative Computing Software  
Morris Plains, NJ 07950  
Toll-free 800-631-8112  
In NJ 201-540-0445

**creative computing software**

Apple is the registered trademark of Apple Computer, Inc.

**Hot pursuit  
through space  
and the  
vortices  
of time!**



RAITHLARE PRESENTS...

# Time Lord

The fallen Time Lord, who presumptuously calls-himself The Master, is at large. The elders of Waldrom have supplied you with the hyperspace-worthy vessel Tardus, and commissioned you to eliminate the evil "Master". Your resources include clones who will fight for you, the formidable CRASER weapons of the Tardus, and magic weapons such as Fusion Grenades and Borelian Matrix Crystals.

Traveling through hyperspace in search of the evil one, you will encounter Time Eaters, Neutron Storms, and other alien creatures and phenomena. Entering real space to search planets, you will encounter still other dangers. You will enter native settlements to buy food and supplies — or to fight for survival.

And once you find The Master can you destroy him?

  
**TSE HARDWARE**  
6 South St., Milford, NH 03055 (603) 673-5144  
TOLL FREE OUT-OF-STATE 1-800-258-1790

Based on Dr. Who of PBS fame.  
Apple Integer Basic,  
Disk, 48K ... \$29.95





## TSE-HARDSIDE HAS IT ALL IN ONE!

How many times have you wished that there was a single source for your personal computer needs? Well look no further, TSE-HARDSIDE, located in pleasant New Hampshire, has virtually every conceivable item for your micro. Whether you're shopping for your Apple, Pet, TRS-80™ or Atari, TSE-HARDSIDE has it all. We stock hardware, software, books, magazines and specialty items for all of the popular machines. So the next time you're out shopping for your system don't be surprised, be satisfied. Remember the name TSE-HARDSIDE as your choice for quality, service and reliability.



**TSE-HARDSIDE**  
 6 South St. Milford, NH 03055 (603) 673-5144  
 TOLL FREE OUT-OF-STATE 1-800-258-1790



# Save \$2.00

If you or a friend would like to receive our TSE/HARDSIDE Complete Computer Catalog, simply send \$1.00 and receive a \$2.00 certificate good toward your first purchase of software, hardware, books or specialty items from TSE/HARDSIDE. I have a (check one)  ATARI  PET.  TRS-80,  APPLE

A photocopy of this coupon will be accepted.

Name \_\_\_\_\_  
 Address \_\_\_\_\_  
 City \_\_\_\_\_ State \_\_\_\_\_ Zip \_\_\_\_\_ NIBB \_\_\_\_\_

MAIL TO: TSE/HARDSIDE  
 6 South Street  
 Milford, NH 03055

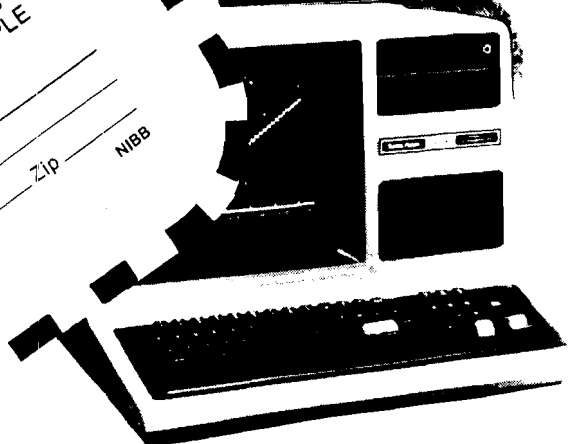

# "NIBBLE<sup>®</sup> IS TERRIFIC" (For Your Apple)



**NIBBLE IS:** *The Reference for Apple computing!*

**NIBBLE IS:** One of the Fastest Growing new Magazines in the Personal Computing Field.

**NIBBLE IS:** Providing Comprehensive, Useful and Instructive Programs for the Home, Small Business, and Entertainment.

**NIBBLE IS:** A Reference to Graphics, Games, Systems Programming Tips, Product News and Reviews, Hardware Construction Projects, and a host of other features.

**NIBBLE IS:** A magazine suitable for both the Beginner and the Advanced Programmer.

Each issue of NIBBLE features significant new Programs of Commercial Quality. Here's what some of our Readers say:

- "Certainly the best magazine on the Apple II"
- "Programs remarkably easy to enter"
- "Stimulating and Informative; So much so that this is the first computer magazine I've subscribed to!"
- "Impressed with the quality and content."
- "NIBBLE IS TERRIFIC!"

*In coming issues, look for:*

- Stocks and Commodities Charting
- Assembly Language Programming Column
- Pascal Programming Column
- Data Base Programs for Home and Business
- Personal Investment Analysis
- Electronic Secretary for Time Management
- The GIZMO Business Simulation Game

And many many more!

NIBBLE is focused completely on the Apple Computer systems.

Buy NIBBLE through your local Apple Dealer or subscribe now with the coupon below.

**Try a NIBBLE!**

**nibble**

Box 325, Lincoln, MA. 01773 (617) 259-9710

**I'll try nibble!**

**Enclosed is my \$17.50 (for one year).  
(Outside U.S., see special rates on this page.)**

**check**     **money order**

Your subscription will begin with the next issue published after receipt of your check/money order.

Name \_\_\_\_\_

Address \_\_\_\_\_

City \_\_\_\_\_

State \_\_\_\_\_ Zip \_\_\_\_\_

**NOTE**

First Class or Air Mail is required for all APO, FPO and all foreign addresses with the following additional amounts.

- Europe \$32.00
- Mexico and Central America \$21.00
- South America \$32.00
- Middle East \$35.00
- Africa: North \$32.00
- Central \$43.00
- South \$43.00
- Far East, Australia \$43.00
- Canada \$18.00

All payments must be in U.S. funds drawn on a U.S. bank.  
© 1980 by MICRO-SPARC, INC., Lincoln, Mass. 01773. All rights reserved.  
\*Apple II is a registered trademark of Apple Computer Company



# Macros for Micros

## An introduction to the MACRO assembler.

John Figueras  
65 Steele Rd.  
Victor, New York 14564

Macro definition is a common feature of the advanced assemblers available on large computers. To my knowledge, the only 6502-based assembler with this capability is the ASSM/TED 6502 Macro Assembler sold by Carl Moser.<sup>1</sup> I will describe practical applications of macros to programming an Apple II computer, and show how to set up a macro library that can be stored on disk, and which may be used as a subroutine generator to supply utilities that will simplify machine language programming.

A macro definition is a predefined block of assembler code that is assembled into the machine language program wherever the macro is called. An example of a macro definition is shown in figure 1. [All examples use the notation of ASSM/TED and were written for the Apple II computer.] The three exclamation marks designate the subsequent name, KEYB, as the name of a macro definition. It is by this name that the macro is called in the program. The pseudo op-codes, .MD and .ME define, respectively, the beginning and end of the macro definition. The statement(s) falling between these comprise the *body* of the definition. The macro in figure 1 doesn't do much—it simply calls the Apple keyboard routine. You might wonder "Why all the fuss for *this*?" But consider that we may now replace a call to the hexadecimal address \$FD67 of a keyboard subroutine with the mnemonic, KEYB. Then, in creating a source program, to call the keyboard I simply use KEYB, which is much easier to remember than JSR \$FD67. Essentially, macros allow you to create your own convenient programming symbols.

A macro is called in an assembly language program by using the macro name as an opcode. (Examples will be shown later.) When the program is assembled, code contained in the body of the macro definition will be inserted in place of the macro name wherever it occurs. For example, wherever I use the name KEYB, as defined in figure 1, the assembler will substitute the machine code equivalent, a JSR \$FD67. If the body of this macro definition contained twenty assembly language instructions, then all twenty statements would be assembled into the program. This can be a problem, since indiscriminate use of macros can lead to undesirable inflation in the amount of memory required for the program.

It may be difficult for beginning machine language programmers to grasp the difference between a macro and a subroutine (at least, I had this difficulty). There is a superficial resemblance between the two, since each is a block of statements that is called in a program. But the resemblance ends there. A subroutine is a block of code that occurs only once in a program and is called by a branch instruction, which diverts the program flow to the subroutine. Provision is made for a return to the calling program by storing a return address when the subroutine is called. A macro, on the other hand, produces in-line code during assembly each time the macro is called. While they use more memory space, macros are more efficient because they do not require subroutine branch and return instructions.

## Application to Utilities Storage

One problem facing the machine language programmer is that of handling utility routines, particularly those for input/output operations. The Apple monitor contains a large number of these utilities, which may be called by the user's programs, with a JSR. The task of finding and interpreting these

Figure 1: Example of a Macro Definition

```
>PR
;READ KEYBOARD. # CHAR IN NCHAR
!!!KEYBRD .MD
        JSR $FD67
        STX NCHAR
        .ME
;
;DISPLAY BUFFER ON CRT
!!!DISPLAY .MD
```

Figure 2: Macro Library of I/O Utilities

```
>PR
;READ KEYBOARD. # CHAR IN NCHAR
!!!KEYBRD .MD
        JSR $FD67
        STX NCHAR
        .ME

;
;DISPLAY BUFFER ON CRT
!!!DISPLAY .MD
        SEC
        LDX #S00
...LOOP1 LDA BUFFER,X
        ORA #S80
        JSR $PDF0
        INX
        CPX NCHAR
        BCC ...LOOP1
        .ME

;
;ASSIGN FIXED ADDRESSES
!!!INIT .MD
        .OS
        .ES
NCHAR .DS 01
BUFFER .DE $0200
ZPAGE .DE $4A
        .ME
//
```

Figure 3: Example of Keyboard/CRT I/O

```
;SAMPLE PROGRAM 1
;READ & DISPLAY KEYBOARD ENTRY
        .BA $5000
        INIT
;DEFINE SUBROUTINES
VIDEO .DISPLAY
RTS
KEYIN .KEYBRD
RTS
TRIAL .JSR KEYIN
        .JSR VIDEO
RTS
        .EN
```

utilities has been considerably eased by the publication of *The Apple II Monitor Peeled*<sup>2</sup>, which describes the functions and locations of a large number of important routines. These include reading the keyboard, sending characters to a CRT, defining the location of the input buffer, cursor manipulation and many others. Until this volume was released, it was difficult to know how to use the monitor routines that Apple kindly listed in their reference manual<sup>3</sup>, without any explanation.

Though the information for applying the monitor routines is now available, one still needs to know a number of memory addresses to use them. Casual programmers, like myself, have to look these up repeatedly because we forget the addresses from one programming session to another. Moreover, many of the routines require small drivers to run them, and I find that I can't remember how I wrote the driver last time any better than I can remember the addresses! It would be convenient, therefore, to pre-program the most-needed utilities, store them on disk, and call them from disk for insertion into a program. One would then have a *subroutine library*, like those used to support programming on large computers. Or, (and this is the direction I chose), one could store the same information in a *macro library*.

The tendency of macros to use up memory can be overcome by calling the macro inside a subroutine. The macro library is loaded into the ASSM/TED text buffer; the required subroutine is formed by setting up the desired subroutine name, calling the appropriate macro out of the library into the subroutine, and closing with an RTS. The macro is assembled only once and may now be used repeatedly by means of subroutine calls, without direct use of macro calls. One can use macro calls directly, without subroutine calls. If the macro block appears only once in a program, or if it is very short, this avoids the overhead of subroutine calls. However, if the macro block is long, and is used more than once, then putting the macro call in a subroutine is more efficient.

### Sample Application: I/O Utilities

Leaving these abstract considerations, let's look at some implementations. Figure 2 is a listing of a small macro library comprising three modules. The first one, KEYBRD, allows the Apple keyboard to be read by means of a call to a monitor subroutine at \$FD67. The monitor routine loads

keyboard input into a text buffer located at \$0200 and stores the character count in the X register. In the macro definition, this character count is transferred for later use to a memory location NCHAR. This memory location must be assigned before the macro is called. This is taken care of by another macro, INIT, which will be discussed later.

The second macro definition, DISPLAY, sends the contents of the Apple text buffer, character by character, to the CRT, by a call to a monitor subroutine at \$FDF0. Note that the text buffer is addressed by a name, BUFFER, which is assigned in the macro, INIT. The character count, NCHAR, is required to control the number of characters sent to the CRT. This is the same count created in KEYBRD. The internal loop, ...LOOP1, is named with three opening dots, in accordance with Moser's requirements in ASSM/TED. This convention permits the macro definition to be used several times within a program. Each use will generate a new label to replace LOOP1, otherwise location conflicts for the label would occur. If the macro definition is used only once, this precaution is not necessary; I invoked it to allow greater freedom of use of the macro.

The third macro definition, INIT, initializes several assembler parameters and assigns storage for variables. The .OS pseudo-op must be included in every source program to enable compilation of machine code. The pseudo-op .ES enables the listing of the machine code derived from expansion of macros. If it is not present, the machine code due to macros will not appear in the output listing. Since I want .OS and .ES to appear in the programs I write, I include them in INIT, and avoid the need to remember them. Also included in INIT is the assignment of storage for NCHAR (.DS 01 reserves one byte of storage), assignment of the address of the input buffer, \$0200, to the label BUFFER, and definition of a zero page address, ZPAGE. Note that the three macros taken together have eliminated the need to remember four addresses, and have given me by-name access to two variables, NCHAR and BUFFER. Because of its function, INIT must be the first statement in a program after definition of program origin, since it defines locations of variables needed by other macros.

Figure 3 illustrates the use of macros in subroutine generation. The program, TRIAL, reads the keyboard

Figure 4: Example Using Direct Macro Calls

```

      .BA $5000
      INIT
      KEYBRD
      DISPLAY
      RTS
      .EN

```

Figure 5: Display a Message from Memory

```

>
>;SAMPLE PROGRAM 2
>;DISPLAY MESSAGE IN MEMORY
      .BA $500
      INIT
;DEFINE SUBROUTINE
VIDEO  DISPLAY
      RTS
MSG    .BY 'MESSAGE 1'
TEMP   .BY 09
TRIAL  LDA TEMP
      STA NCHAR
      LDX #500
LOOP   LDA MSG,X
      STA BUFFER,X
      INX
      CPX NCHAR
      BNE LOOP
      JSR VIDEO
      RTS
      .EN
//

```

Figure 6: Macros for Data Transfer with Address Passing

```

;MACROS TO TRANSFER CHARS
;FROM MEM TO BUFFER
!!!PASSADR .MD (MSG CNT)
      LDA CNT
      STA NCHAR
      LDA #L,MSG
      STA ZPAGE
      LDA #H,MSG
      STA ZPAGE+01
      .ME
!!!MEMBUFF .MD
      LDY #500
LOOP2...  LDA (ZPAGE),Y
      STA BUFFER,Y
      INY
      CPY NCHAR
      BNE LOOP2
      .ME
//

```

Figure 7: Program to Display Two Messages Using Macros in Figure 6

```

;
;SAMPLE PROGRAM 3
;DISPLAY TWO MESSAGES FROM MEM
      .BA $5000
      INIT
;DEFINE SUBROUTINES
MESSAGE MEMBUFF
      RTS
VIDEO  DISPLAY
      RTS
MSG1   .BY 'FIRST MESSAGE'
      $8D
CNT1   .BY --MSG1
MSG2   .BY 'SECOND MESSAGE'
      $8D
CNT2   .BY --MSG2
TRIAL  PASSADR (MSG1 CNT1)
      JSR MESSAGE
      JSR VIDEO
      PASSADR (MSG2 CNT2)
      JSR MESSAGE
      JSR VIDEO
      RTS
      .EN
//

```

and displays the entry. (A double display will occur because the monitor routine KEYBRD also provides an echo.) The program is assigned an origin at \$5000 by the pseudo-op .BA. INIT is called to initialize variables and pseudo-ops. Two subroutines are defined. The first one, VIDEO, sends characters to the CRT and its body is loaded from the macro DISPLAY (figure 2). The second one, KEYIN, enables keyboard input; it is loaded from the macro KEYBRD (figure 2). The simple structure of these subroutines masks the complexities that may be built into the macro definitions. The program starts at the label TRIAL.

Following invocation of the two subroutines, RTS returns control to the assembler. The closing .EN defines the end of the program to the assembler. This program really does not require the use of subroutines, but is a simple example of how subroutines could be defined. Since the macros in figure 3 are used only once, the very brief program in figure 4, based on direct macro calls, is a more reasonable implementation.

The second program example, figure 5, displays a message stored in memory (that is, one written into the program). The macros defined in figure 2 are used, except for KEYBRD, since there is no keyboard input. In figure 5, the subroutine VIDEO is defined as before. The message to be displayed is stored as a character string in a location labelled MSG (.BY means "define bytes"). The number of characters in the message is stored in a location named TEMP.

Program TRIAL begins by transferring the character count stored in TEMP to NCHAR, where it can be used by DISPLAY. The loop makes a character-by-character transfer from message location MSG to the display BUFFER, which is accessed in the subroutine VIDEO.

We note in the above program that code is used to transfer data from memory into the display buffer. Since this transfer is likely to be used repeatedly as a basic operation in displaying labels and instructions, it would be desirable to turn this code into a macro definition for use in the body of a subroutine. An immediate difficulty arises from the fact that the message and character count (MSG and TEMP) occur at fixed addresses. Other messages and counts which are at different addresses are not accessible to this program. If a subroutine is set up to pass data to the display buffer from memory, we would like to be able to

pass the addresses of the message and the message count to the subroutine, so that it can be applied wherever these data fall in memory. It turns out that passing addresses to a subroutine requires a surprising amount of code [see the remarks by R.C. Vile<sup>4</sup>].

However, the macro language in ASSM/TED permits addresses to be passed to macro definitions. We would like to take advantage of this without the high memory overhead that repeated use of large macros might entail. The solution is to partition the macro into a small segment that does the address passing, and a larger segment that operates on the data in the passed addresses. Addresses passed by the small segment are stored in fixed memory locations accessible to the large segment. In programming applications, the small segment could be used without much memory overhead as a *macro*, and the large segment could be used as the body of a subroutine. An example of such a partition appears in figure 6, which contains the data transfer segment of the program in figure 5.

The first macro definition in figure 6, PASSADR, enables the passing of two addresses, MSG and CNT, of the message and message count. In ASSM/TED convention, these addresses appear as arguments in parentheses following the macro name. PASSADR uses the address of CNT, whatever that may be in the program, to transfer the count stored there to the pre-defined location NCHAR. The high and low bytes of address MSG are stored by PASSADR in zero page addresses ZPAGE and ZPAGE+01. The actual moving of data from memory location MSG to the display buffer is done in the second macro, MEMBUFF. This routine uses indirect indexed addressing based on ZPAGE for getting the data in MSG. The ZPAGE location must, of course, be defined, and this is done in the macro INIT [see figure 2]. MEMBUFF can be used to form the body of a subroutine.

An application of these two new macros for displaying two messages stored in memory appears in figure 7. The messages are stored as bytes (.BY) in addresses MSG1 and MSG2. The required character counts are calculated by using the ASSM/TED pseudo-op "=" to get the current value of the program counter, and then subtracting from it the address of the corresponding message (e.g., = - MSG1). Since the program counter is read after the definition of the message, the difference be-

tween that reading and the address of the beginning of the message must give the message length in bytes. The messages themselves are terminated by a carriage return, \$8D, to allow each message to appear on a separate line. PASSADR is used twice in the program with two different sets of addresses in parentheses. PASSADR is used as a macro in the program, while MEMBUFF is used to supply the body of a subroutine, MESSAGE.

The emphasis so far has been on the use of macro definitions as a means to create the equivalent of a subroutine library. There are other ways in which a subroutine library may be created, but I consider the use of macro definitions described here as the least troublesome and most flexible way in which to formulate such a library. Given the language resources of the Apple computer, it is also the most memory-conserving way.

## Conclusion

You may be persuaded by now that the use of macro definitions offers a very powerful programming tool to the machine language programmer. Its most interesting spin-off is that it allows you to design your own programming language at the machine code level. The examples in this article barely scratch the surface of possible applications. One area in which macros are useful is arithmetic operations. One can design macros for addition, subtraction, multiplication and division of sixteen bit numbers, and define double precision versions of these macros. The addresses of the numbers to be operated on could be passed as arguments in the macro definitions. And then there are high and low resolution graphics... and floating point arithmetic... and array definition... and....

## References

1. ASSM/TED 6502 Macro Assembler, Carl W. Moser, Eastern House Software, 3239 Linda Drive, Winston Salem, North Carolina 27106.
2. *The Apple II Monitor Peeled*, William E. Dougherty, 14349 San Jose St., Mission Hills, California 91345. (Widely available through vendors.)
3. *Apple II Reference Manual*, Apple Computer, Inc., January 1978.
4. R.C. Vile, Jr., MICRO, Issue 20, pg. 25 (January 1980).

MICRO

## WHAT IS THE COMMUNITY COMPUTERIST'S DIRECTORY ?

The Community Computerist's Directory is similar to a telephone book with these major differences: it focuses on the driving force behind the information revolution, the people and organizations who are producing, buying, using and experimenting with computers; and since lists of names alone are not useful information, each listing in the directory includes a statement of up to one thousand characters written by each participant describing their projects, interests, needs and resources, or a statement of their thoughts about the use of computers in general; the directory is also a public forum.

The Community Computerist's Directory is the most inexpensive way for people, businesses and organizations to advertise themselves, their abilities, needs, resources, products, services, applications, interests, or ideas. The directory is national in scope, local in focus and people oriented. Like a telephone book, it stays next to the computer as the one reference used most by computerists.

To aid in finding who or what you need, the Directory provides extensive cross-indexing: not only indexed by zip code and last name...but also by key words related to the text of the listing as well as the system used. Inclusion of data base ID numbers will facilitate electronic conferencing and mail between directory subscribers. Lists of clubs and user groups, publications, computerized bulletin boards and more add to its usefulness. After all, what good would phones be without phone books?!!

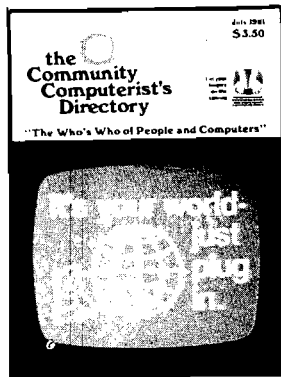

**\$3.50**

  
**the  
Community  
Computerist's  
Directory**  
**PO BOX 405**  
**FORESTVILLE, CA 95436**  
**PHONE: (707) 887-1857**

## OHIO SCIENTIFIC

**S-FORTH** — a full implementation of Fig-FORTH including editor, virtual disk sub-system, and compatibility with OS65D-3 on 5¼" or 8" disk. \$34.95.

Source listing \$24.95.  
Both for \$49.95.

**TOUCH TYPING MADE EASY** — 15 lesson set teaches you to "touch type". Now also available for the C1P. 8K. \$19.95.

**TITANIC QUEST** — a real time search where you risk your remaining supplies to find the Titanic. 8K. \$6.95.

**TEXT EDITOR** — the best screen text editor available for OSI C4P, C8P disk systems. \$19.95.

Send for our FREE 14 page software and hardware catalog. Includes photos and complete descriptions of all game, utility, and business software.

**Aurora Software Associates**  
P.O. Box 99553  
Cleveland, Ohio 44199  
(216) 221-6981



# OHIO

# SCIENTIFIC

## NEW & USED SYSTEMS

- HARDWARE
- SOFTWARE
- PARTS
- ACCESSORIES

-SERVICE AVAILABLE

**SUNSET ELECTRONICS**  
2254 TARAVAL ST.  
SAN FRANCISCO, CA 94  
(415) 665-8330

**NEW!** FROM Brøderbund Software  
**STRATEGY GAMES!** **FAST ACTION GAMES!**

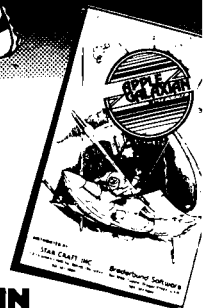
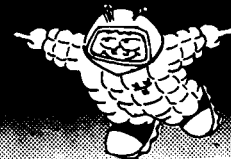

**THE SAGA CONTINUES . . .**  
**IV TAWALA'S LAST REDOUBT**

The cruel Emperor Tawala has been forced from his throne on the world of Galactica and has fled for his life to the planet of Farside, where he and a small bank of adherents prepare to make their last stand. Extreme solar conditions have isolated Farside from the rest of the galaxy, and so it remains to Benth, leader of the local insurrectionists, to press the final assault on Tawala and his minions.

**TAWALA'S LAST REDOUBT** puts you in the position of rebel leader. You must intercept and decipher Tawala's secret messages to his supporters, form alliances with local chiefs, detect Tawala's spies in your midst, separate hard intelligence from enemy disinformation, avoid Tawala's military forays against you and, finally, lead the assault against the Prince's stronghold.

Minimum Configuration:  
**TRS-80 Cassette, 16K, Level II, \$19.95**  
**TRS-80 Disk, 32K, \$24.95**  
**APPLE Disk, 48K with APPLESOFT, \$29.95**

\*Apple, Apple II Plus and Applesoft are trademarks of Apple Computer Co. TRS-80 is a trademark of Ra

**APPLE  
GALAXIAN**

Apple Galaxian — In brilliantly colored as Galaxians swoop down from all as dazzlingly swift attacks to do battle as lone defender. This faithful rendition of the popular of all bar games may drive you the bend, but think of all the quarters saving! Apple II Integer or Plus, 48K disk

How to order: Ask your dealer or send a money order for the exact retail price to

**Brøderbund Software**  
Box 3266, Eugene, Oregon 974

Call (503) 343-9024 to order. NO CHARGE FOR SHIPPING AND HANDLING!  
Visa and Mastercard accepted.

**We've got more! Send for our free catalog!**

# Create a Data Disk for DOS 3.2 and 3.2.1

**Save space on your Apple data disks by eliminating the copy of DOS.**

Glenn R. Sogge  
Fantasy Research & Development  
P.O. Box 203  
Evanston, Illinois 60204

According to the information in the DOS 3.2 manual, an initialized disk contains 403 sectors (of a total 455) that can be utilized for the storage of user information. (User information also includes some file overhead of track and sector lists.) This amounts to 103,168 bytes of memory space or 88.57% of the maximum storage capacity of the disk. (The maximum storage is  $13 * 35 * 256 = 116,480$  bytes.) This article explains how to increase the user storage to 112,640 bytes or 96.70% of the maximum—an increase of 8.13%! Given the limited storage capabilities of 5¼ inch disks to begin with, this improvement can be quite important—especially for business and data base software.

The cost of this increase in storage is the loss of the DOS on the disks. This is not too high a price, however, because we usually don't need dozens of copies of DOS floating around. In general, the user will boot the system up and use the DOS that is then residing in the machine, using the disks only for information storage and handling. Even though a program may use many different disks, the DOS that is written on each one is generally useless, but still takes up three tracks of space [9984 bytes].

One advantage of having the DOS on every disk is that any disk is bootable. The procedure outlined here will create data disks that are bootable with an overhead of only 2 sectors (512 bytes) besides the directory track [track \$11].

## A Note on Notation

In this article, tracks, sectors, and relative bytes (within the sector) will be indicated like this:

11,C,AC

The contents of such locations will be indicated like this:

(11,C,AC) = FF

or

(11,4,00) = 0 1 FD 38  
(successive bytes)

All numbers will be in hexadecimal so the '\$' should be assumed if not present.

## Beginnings

The simplest way to gain more space is to change the bitmap in the VTOC to free up the sectors occupied by the DOS. By changing the contents of the bytes at [11,0,38-43], we can de-allocate the sectors normally reserved for DOS. Several of the disk utilities commercially available have just such an "expunge" routine. The problem with this simple method is that the disk will probably hang when booted, because either new information will have been stored in the sectors that contain the secondary boot code, or portions of DOS will keep disappearing as more information is stored.

Since we want to free up this space anyway, we will begin by changing the bitmap and then worry about making the disk boot later. With one of the disk utilities available, read in the [11,0] sector and make the following changes, then rewrite it to the disk:

(11,0,38) to FF E0 00 00  
(11,0,3C) to FF F8 00 00  
(11,0,40) to FF F8 00 00

These changes free up all of the sectors of the first three tracks except for sectors 0 and 1 of track 0. These will be used to make the disk bootable.

## How a Disk Boots

When a disk boots, the first sector [0,0] is read into memory, unscrambled, and placed at \$300 - \$3FF. This code then begins reading in from sector [0,0] again and places the code into memory. The number of sectors of track zero that are to be read in, and where they are to be stored, can be easily modified. The byte at [0,0,FF] contains the highest sector value to read, times 8, and the byte at [0,0,FE] contains the page address of where to begin storing the code.

After the track 0 sectors are read in, the code jumps to the memory location where sector [0,1] has been stored and continues execution. With a normal disk, this code is the third stage of the boot, and the RWTS routines read in the rest of DOS and start it running. For example, if [0,0,FF] is \$48, sectors 0 through 9 will be read into memory [\$9 times \$8 equals \$48]. If [0,0,FE] is \$36, sector [0,0] goes at \$3600, [0,1] at \$3700, [0,2] at \$3800, and so on. After the requisite number of sectors have been read in, execution will continue at \$3700.

By changing the bytes at [0,0,FE] and [0,0,FF] and placing new code in sector [0,1], the boot routines will automatically load and execute it. (For those of you who have tried to figure out the page 3 boot code, the value of [0,0,FE] ends up at \$3CC and the value of [0,0,FF] ends up at \$3FF.)

## The Data Disk Routine

The routine on the data disk should notify the user that there is no DOS present, and then gracefully return to the user. Most expunge routines don't do this and somehow cause the routine

to abort, or require the user to press reset to gain control of his machine. If the machine has the Autostart ROM, even resetting may not work because the first part of the boot will have crashed the page 3 PWREDUP vector bytes, thus causing the ROM to think that it is the first time through the procedure. It then begins the boot process all over again by looking for a disk and starting up the boot.

This is clearly inelegant and totally unacceptable in a turnkey system. The system should trap all foreseeable user errors and handle them, without requiring the user to be a computer operator. The user should be able to put any disk in the system (even if by mistake) and not have the roof fall in. In other words, as far as the booting procedure is concerned, one sequence of actions is all the user needs to learn.

The short routine accompanying this article is an example of the kind of routine required. The routine first disconnects the I/O hooks in page zero, resets to keyboard and video mode, and clears the screen. The drive is turned off and a message notifying the user that DOS is not present is displayed. BASIC is then entered at the cold start point. (This could be changed to warm start BASIC if desired.) The user now knows what went wrong and can decide how to proceed.

You will notice that the routine to print out the error message is written in a way that is relocatable. This was done so that the code would run from any page in memory; the value of this capability is discussed in the next section.

### Putting it Together

Now that we have an understanding of the booting process and a routine to use with it, it's time to put them together. Since the ROM boot routine crashes pages 8 and 9 with its "nibble buffers," a good place to put the new code is right above them, to keep all the damage in one area. To do this, change the byte [0,0,FE] to \$0A and the byte at [0,0,FF] to \$08. This changes the boot to read in sectors [0,0] and [0,1], to place them in memory starting at \$A00, and to jump to \$B00. The error routine should be placed on the disk at [0,1] and it will end up in memory at \$B00 ready to run.

If, for some reason, pages \$A and \$B are inappropriate to your system or programs, change the value of [0,0,FE] to a

```

*****
* DOS DATA DISK CODE
*****
*
* BY GLENN R. SOGGE
* FANTASY RESEARCH
* & DEVELOPMENT
*
* P.O. BOX 203
* EVANSTON, IL
* 60204
*
* LAST REVISION
* 5/23/80
*
*****
* THIS CODE GOES
* ON TRACK ZERO,
* SECTOR 1
*
* IT WILL RUN FROM
* ANY PAGE BOUNDARY
*
*****
*
SETVID EQU $FE93
SETKBD EQU $FE89
A1 EQU $3C
COUT EQU $FDED
HOME EQU $FC58
BASIC EQU $E000
RTS1 EQU $F831
SLOT EQU $2B
MOTOFF EQU $C088
*
* ORG $B500
*OBJ $B500
*
NOBOOT JSR SETVID UNHOOK DOS
        JSR SETKBD POINTERS
        JSR HOME CLEAR SCREEN
        LDX SLOT WHO CALLED?
        STA MOTOFF,X TURN HIM OFF
        JSR RTS1 WHAT PAGE AM I ON?
        TSX
        DEX
        TXS
        PLA
        STA A1+1 POINT A1 TO
        LDA #MSG THE MESSAGE
        STA A1
        LDY #00
        PRLOOP LDA (A1),Y PRINT OUT THE
        BEQ DONE MSG TO USER
        JSR COUT
        INY
        BNE PRLOOP
        JMP BASIC GO TO LANGUAGE
*
MSG ASC "NO DOS ON THIS DISK"
      DW $B7 BELL
      DW $00
*
SYM
    
```

page that is more suitable. [The routine was made relocatable for this reason.] Pages \$8 and \$9 cannot be used because these buffers are necessary for reading in the code.

### The Master Disk

This procedure is not an unreasonable amount of work to do once or twice, but it is not something you

would want to turn into a habit. So, master data disk that can then be copied as many times as needed should be made. Note: some copy program may not copy information from, or to the normal locations that DOS occupies on a disk. If your program is of this kind, you'll have to transfer the [0,0] and [0,1] sectors manually to the new disk. The modified VTOC should be copied correctly.

The following is the general procedural outline:

1. Initialize a disk in the normal manner.
2. Delete the 'HELLO' program.
3. Change the VTOC bytes as outlined above.
4. Change the sector [0,0] bytes as outlined above.
5. Put the error routine on sector [0,1].
6. Test the disk by booting it.
7. Make a copy of the disk.
8. Boot the copy disk.

If everything is okay, you now have a master data disk (with no files on it) from which to generate more.

Notice that no change is made in the VTOC to the bits corresponding to track \$11 (the directory and the VTOC). This track is kept 'unavailable' so the directory and the VTOC will still be there for the DOS that accesses the disk.

**Extensions**

The experienced machine language hacker can extend this technique to create disks that automatically load and run machine language programs, as long as they fit completely on track 0 or if they include the RWTS routines and controlling code to read in more of the disk. If you examine the code on a normal disk at sector [0,1], you will see the type of code required.

The designers of operating systems can change or replace all or part of the Apple DOS by changing the contents of the sectors normally occupied by DOS, and letting the various boot routines bring it into memory. This generally requires using the existing RWTS code on track 0 and something similar to the third stage boot code that starts with sector [0,1], but it is not necessary. The programmer can create a whole new system if desired.

By utilizing the Apple RWTS routines that normally reside on track 0, the disks of different operating systems can be physically compatible even though the information structures may not be. There are already enough incompatible DOS's and physical formats around in the micro world; I hope that as more DOS's develop for the Apple, their underlying physical structure will remain the same. Some alternatives are needed to the Apple DOS for various users, but the media shouldn't be incompatible at all levels.

I, for example, am working on an implementation of FIG-Forth (the Forth Interest Group's definition of a minimal standard Forth) for the Apple, and plan to use the standard RWTS routines and linkages—but not the whole DOS—to allow Forth access to the disks created under 3.2 and BASIC, and *vice versa*. Different languages and operating systems allow alternative processing operations on the same information, but only if the information is physically accessible.

I hope this article can contribute to the development of such systems and would like to hear from anyone working along these lines.

**MICRO**



**MUSICAL COMPUTER I AND II**

**Learn How to Read Music!**

Written by an M.A. educator with over 20 years of music experience. This two-program cassette provides an *alternative* to music education.

- Treble & Bass Note Reading
- Telling Time
- Notes and Rests
- Sharps and Flats
- Signs and Symbols
- Tempo Definitions
- **CHALLENGING** Practice Testing Opportunities

*\$34.95 + \$1 for postage and handling  
Check or Money Order Please  
(MI residents add 4% sales tax)*

*SPECIAL one-time introductory sample price available to dealers only. Please request on your dealer letterhead.*

- Check:  Apple II 32K  
 TRS-80 Level II 16K  
 ATARI 800 32K

Name: .....

Address: .....

.....

**COMPUTER APPLICATIONS TOMORROW** P.O. Box 605  
 Birmingham MI 48012

Fast, inherently structured, programming system ready for your APPLE II or II+ (24K).

Extensive, professional, 100 page bound documentation. Cleanly interfaced to DOS 3.2 or 3.3. Files are completely compatible with DOS or BASIC.

- Control C break and continue for reasonable debugging.
- Built-in, convenient editor.
- FORTH structured assembler.
- The best blend of FORTH and the APPLE's capabilities.
- Supports games, music, I/O, graphics, disk, tape.
- Supplied on APPLE diskette.
- Excellent for applications or systems programming.
- After two years, still **\$49.95**  
 Calif. residents add \$3.00 sales tax

From your dealer or direct from:  
 SOFTAPE, Dept. f.  
 10432 Burbank Blvd.  
 North Hollywood, CA 91601  
 or Call: 1-213-985-5763

FOG 279 \$49.95

Master Charge/Visa Accepted.

Apple is a registered trademark of APPLE COMPUTER, INC.

# NIKROM TECHNICAL PRODUCTS PRESENTS A DIAGNOSTIC PACKAGE FOR THE APPLE II AND APPLE II + COMPUTER.

## "THE BRAIN SURGEON"

Apple Computer Co. has provided you with the best equipment available to date. The Diagnostic's Package was designed to check every major area of your computer, detect errors, and report any malfunctions. *The Brain Surgeon* will put your system through exhaustive, thorough procedures, testing and reporting all findings.

### *The Tests Include:*

- MOTHERBOARD ROM TEST
- APPLESOFT ROM CARD TEST
- INTEGER ROM CARD TEST
- MOTHERBOARD RAM TESTS
- DISK DRIVE SPEED CALIBRATION
- DISK DRIVE MAINTENANCE
- DC HAYES MICROMODEM II TEST (HARDWARE & EPROM)
- MONITOR & MODULATOR ROUTINES
- MONITOR SKEWING TESTS
- MONITOR TEST PATTERN
- MONITOR TEXT PAGE TEST
- MONITOR & TV YOKE ALIGNMENT
- LO-RES COLOR TESTS
- HI-RES COLOR TESTS
- RANDOM HI-RES GENERATOR
- SPEAKER FUNCTION TESTS
- SQUARE WAVE MODULATION
- PADDLE & SPEAKER TEST
- PADDLE & BUTTON TEST
- PADDLE STABILITY
- INTERNAL MAINTENANCE
- GENERAL MAINTENANCE
- ON BOARD "HELP"

**NEW!**

*The Brain Surgeon* allows you to be confident of your system. This is as critical as the operating system itself. You *must* depend on your computer 100% of it's running time. *The Brain Surgeon* will monitor and help maintain absolute peak performance.

Supplied on diskette with complete documentation and maintenance guide.

PRICE: \$49.95  
REQUIRES: 48K, FP in ROM  
1 Disk Drive, DOS 3.2 or 3.3



© **Nikrom Technical Products**  
25 PROSPECT STREET • LEOMINSTER, MA 01453

**Order Toll-Free Anytime**  
Master Charge & VISA users call: 1-800-835-2246  
Kansas Residents call: 1-800-362-2421

**Dealer Inquires Invited**

APPLE is Registered  
Trademark of Apple Computer Co.  
MICROMODEM II is Registered  
Trademark of D.C. HAYES

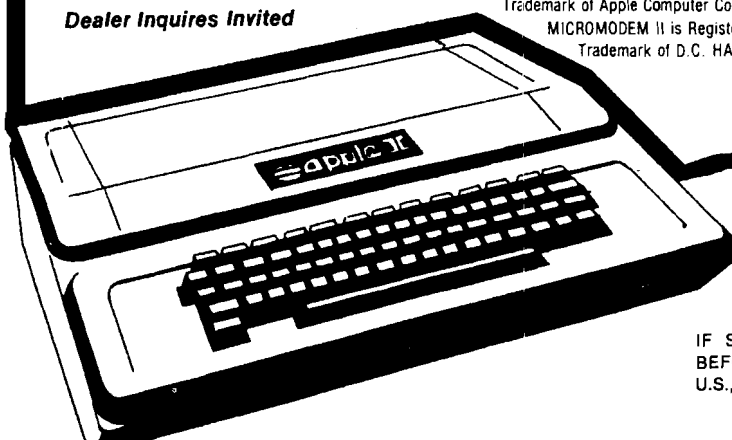

IF SERIAL NUMBER IS BELOW 20,000 OR DATED  
BEFORE 2/15/81, THEN RETURN DISKETTE PLUS \$7.00  
U.S., \$9.00 FOREIGN.



# Apple Color Filter

This short machine language subroutine will allow you to filter out any selected color from the Apple hi-resolution graphics screen.

Stephen R. Berggren  
2347 Duncan Dr. #4  
Fairborn, Ohio 45324

One of the most fascinating capabilities of the new Apple Graphics Tablet is its ability to separate the colors on the high resolution graphics screen. It can act like a color filter, removing all colors from the screen except a chosen one. This can be extremely useful in doing computer art work, drawing graphs, and, of course, in game graphics. But now you can have a similar capability without buying the graphics tablet. Just use this Apple color filter program.

The color filter is a short machine language program which can erase any selected color from the high resolution screen while leaving the other colors unaffected. To use it, simply load it into page 3 of memory, starting at decimal 768. Then POKE a number from 1 to 4 into memory location 769 and run it with a call 768. The number POKEd into 769 determines what color is erased: 1 erases green, 2 erases violet, 3 erases blue and 4 erases orange. The program takes only about one fourth of a second to filter the entire page one Hi-Res screen.

If you are using only green, violet, blue and orange, everything works fine. But the Apple also draws in white—in fact two kinds of white. This can affect the results of the filter operation. The Apple makes its two whites by combining either green and violet (HCOLOR=3) or blue and orange (HCOLOR=7). The color filter "sees" the white as a combination of the two colors rather than as a separate color.

```

;*****
;*
;* APPLE COLOR FILTER
;*
;* BY STEPHEN BERGGREN
;*
;*****
;
;PUT NUMBER FOR COLOR TO BE REMOVED IN $301
; 1 = GREEN, 2 = VIOLET, 3 = BLUE, AND 4 = ORANGE
; WHITE #3 NOT AFFECTED BY 3 OR 4
; WHITE #7 NOT AFFECTED BY 1 OR 2
;
;TO RUN, 300G FROM MONITOR OR CALL 768 FROM BASIC
;
SCRLOC EPZ $06 ;ZERO-PAGE LOC. FOR ADDRESSING SCREEN
LOSCRN EPZ $20 ;HI-BYTE OF ADDRESS OF SCREEN START
HISCRN EPZ $40 ;HI-BYTE OF SCREEN END
;
;
0300 CHG $300
0300 ;
0300 A200 LDX #$00 ;PUT COLOR VALUE IN X FOR TABLE INDEXING
0302 A000 LDY #$00 ; PUT 0 IN Y FOR INDIRECT SCREEN INDEXING
0304 A900 LEA #$00 ; SET SCREEN START ADDRESS IN SCRLOC
0306 8506 STA SCRLOC
0308 A920 LDA #LOSCRN
030A 8507 STA SCRLOC+1
030C ;
030C E106 EVNBYT LDA (SCRLOC),Y ; GET SCREEN BYTE
030E 3008 BPL DOTAB2 ; IF BIT 7 SET, USE TABLE 2
0310 3D4503 AND TAE1,X ;MASK OFF COLOR BITS USING TABLE 1
0312 9106 STA (SCRLOC),Y ;PUT BACK THE BYTE
0314 4C1D03 JMP ODDEYT ;DC THE NEXT BYTE
0316 ;
0318 3D4703 DOTAB2 AND TABLE2,X ;MASK OFF COLOR BITS USING TABLE 2
031B 9106 STA (SCRLOC),Y ;PUT BACK THE BYTE
031D ;
031D E606 ODDEYT INC SCRLOC ;SET UP FOR NEXT SCREEN BYTE
031F B106 LDA (SCRLOC),Y ;GET SCREEN BYTE
0321 3008 BPL DOTAB4 ;IF BIT 7 SET, USE TABLE 4
0323 3D4903 AND TABLE3,X ;MASK OFF COLOR BITS USING TABLE 3
0326 9106 STA (SCRLOC),Y ;PUT BACK THE BYTE
0328 4C3003 JMP INCLC ;GO INCREMENT SCRLOC
032A ;
032A 3D4B03 DOTAB4 AND TABLE4,X ;MASK OFF COLOR BITS USING TABLE 4
032E 9106 STA (SCRLOC),Y ;PUT BACK THE BYTE
0330 ;
0330 A900 INCLC LEA #$00 ;INCREMENT SCRLOC LO
0332 38 SEC
0333 6506 ADC SCRLOC
0335 8506 STA SCRLOC
0337 90D3 BCC EVNBYT ;IF NOT OVERFLOW, DO ANOTHER 2 BYTES
0339 A900 LEA #$00 ;INCREMENT SCRLOC HI
033B 38 SEC
033C 6507 ADC SCRLOC+1
033E 8507 STA SCRLOC+1
0340 C940 CF #HISCRN ;WAS THAT THE LAST PAGE?
0342 D0C8 BNE EVNBYT ;IF NOT, DO NEXT 2 BYTES
0344 60 RTS ;ALL DONE!
0345 ;
0345 00D5 TABLE1 HEX 00D5
0347 AAF7 TABLE2 HEX AAF7
0349 FFAA TABLE3 HEX FFAA
034B D5FFFF TABLE4 HEX D5FFFFD5AA
034E D5AA

```

Thus when told to erase green, it will erase all green, including the green part of any white that is made up of green and violet. This turns the white into violet. Of course, any white made up of blue and orange is left alone. So to erase white, simply erase the two colors that make it up. To avoid changing the white to another color, simply draw it in the colors that you do not plan to filter out later.

How the color filter works delves deeply into the mysteries of Apple color graphics. From what I have been able to deduce, it seems that each byte in the Hi-Res memory holds seven screen dots. Each set bit in the lower seven bits will turn on one dot. The highest bit determines whether the dots will be green and violet, or blue and orange. On even bytes, bits 0, 2, 4 and 6 create violet or blue while bits 1, 3 and 5 create green or orange. On odd bytes, this sequence is reversed. This is a very strange system but it seems to work. What the color filter does is mask out all of the bits in the Hi-Res memory area that would create a particular color. By changing all of these color bits to 0, it eliminates the color. The comments in the source program listing give more detail on how the program operates.

Two bytes of zero page memory are needed for the indirect addressing. The program uses bytes 6 and 7, but any two consecutive bytes can be used. As written, the program works only on Hi-Res page one, but by changing the values of LOSCRN to 40 and HISCRN to 60, you can make it work on Hi-Res page two. Finally, if you don't have an assembler, you can simply load the hexadecimal values listed in the table using the Apple monitor's data entry function.

I would like to offer one last note on the Apple color graphics. The colors have referred to here are the ones I get from my Apple on my television. The colors you get may be different. The best approach is to experiment with the program on your system to see what number inputs erase what colors. The Applesoft BASIC demonstration program listed here should give you a good idea of how the color filter works on your system.

```

5 REM COLOR FILTER DEMO
10 HGR : HOME : VTAB 22
20 FOR I = 1 TO 7
30 HCOLOR= I
40 HPLLOT 0,I * 10 TO 250,I * 10 + 50
50 NEXT I
55 FOR J = 1 TO 5000: NEXT J
60 FOR I = 1 TO 4
70 PRINT : PRINT : PRINT "COLOR FILTER INPUT: "I
80 POKE 769,I
90 CALL 768
100 FOR J = 1 TO 5000: NEXT J
110 NEXT I
120 TEXT
130 END
    
```

**MICRO**



**GET FREE SOFTWARE FOR YOUR APPLE!!!**



HOW? Just order any of the items below, and for every \$100 worth of merchandise order an item from the Bonus Software Section at NO COST! C.O.D. & Personal Checks accepted for all orders.

**HARDWARE BY APPLE**

APPLE II PLUS, 48k	1199
DISK DRIVE+CONTROLLER (3.3)	535
DISK DRIVE only	445
Language System w. Pascal	397
Silentype Printer & Interface	549
Integer or Applesoft Firmware Card	159
Graphics Tablet	645
Parallel Printer Interface Card	149
Hi-Speed Serial Card	155

**VIDEO MONITORS**

Leedex-Video-100 12" B&W w/Cable	139
Leedex 12" Green w/Cable	165
Leedex 13" COLOR MONITOR & cable	399

**SOFTWARE by Others**

PEACHTREE BUSINESS SOFTWARE	CALL
VISICALC	120
EZ WRITER PROF. SYSTEM	229
APPLE FORTRAN by MICROSOFT	159
APPLE BASIC COMPILER by MICROSOFT	315
APPLE COBOL by MICROSOFT	599
MUSE SUPER-TEXT II	139
PROGRAMMA APPLE PIE	119

**SOFTWARE by APPLE**

APPLE FORTRAN	159
APPLE PILOT	125

**HARDWARE by Others**

HAYES MICROMODEM II	300
VIDEX VIDEOTERM 80 W. GRAPHICS	320
MICROSOFT Z80 SOFTCARD	269
MICROSOFT 16k RAMCARD	159
CORVUS 10MB HARD DISK	CALL
SSM AIO SERIAL/PARALLEL A&T	189
MICRO-SCI Disk & Controller	495

**HARDWARE by Mountain Computer**

Clock/Calendar Card	239
A/D & D/A Interface	319
Expansion Chassis	555
ROMplus Card	135
Mark Sense Card Reader	995

**PRINTERS**

EPSON MX-80	515
EPSON MX-70 W. GRAPHICS	415
CENTRONICS 737	737
NEC SPINWRITER 5510 RO	2795
VISTA V300 DAISY WHEEL 25CPS	1750
VISTA V300 DAISY WHEEL 45CPS	2025

**BONUS SOFTWARE HERE!**

Let us acquaint you with MESSAGE-MAKING SOFTWARE. Just place the disk in the APPLE, enter the text, and colorful, dynamic messages appear on the screens of TV sets connected to the computer. Use the software to broadcast messages on TV screens in schools, hospitals, factories, store windows, exhibit booths, etc. The following program is our latest release:  
**SUPER MESSAGE:** Creates messages in full-page "chunks". Each message allows statements of mixed typesizes, typesizes and colors, in mixed upper and lower case. Styles range from regular APPLE characters, up to double-size, double-width characters with a heavy, bold font. Six colors may be used for each different typestyle. Vertical and horizontal centering are available, and word-wrap is automatic. Users can chain pages together to make multi-page messages. Pages can be advanced manually or automatically. Multi-page messages can be stored to disc or recalled instantly.  
 REQUIRES 48K & ROM APPLESOFT ..... \$ 80.

**APPLE PLOTS YOUR DATA & KEEPS YOUR RECORDS TOO**  
**APPLE DATA GRAPH 2.1:** Plots up to 3 superimposed curves on the Hi-res Screen both the X & Y axes dimensioned. Each curve consists of up to 120 pieces of data. Graphs can be stored to disc and recalled immediately for updating. Up to 100 graphs can be stored on the same disc. Great for Stock-market Charting, Business Management, and Classroom Instruction!  
 REQUIRES 48 K & ROM APPLESOFT ..... \$ 40.  
**APPLE RECORD MANAGER:** Allows complete files to be brought into memory so that record searches and manipulations are instantaneous. Records within any file can contain up to 20 fields, with user-defined headings. Information can be string or numeric. Users can browse thru files using page-forward, page-backward or random-search commands. Records can easily be searched, altered or sorted at will. Files can be stored on the same drive as the master program, or on another, if a second drive is available. Records or files can be printed, if desired.  
 Additional modules coming are a STATISTICS INTERFACE, CHECKBOOK, MAILING LIST & DATA-ENTRY.  
 REQUIRES 48K & ROM APPLESOFT ..... \$ 35.  
 \* All Software above on Disk for APPLE DOS 3.2, convertible to 3.3.



**CONNECTICUT INFORMATION SYSTEMS CO.**  
 218 Huntington Road, Bridgeport, CT 06608 (203) 579-0472



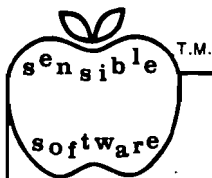

**SENSIBLE SOFTWARE, INC.** IS PLEASED TO INTRODUCE...  
OUR 1981 COLLECTION OF SUPERIOR SOFTWARE FOR THE APPLE COMPUTER...

**APPLESOFT-PLUS STRUCTURED BASIC [APLUS] \$25.00**

32K +, Disk II, ROM/RAM Applesoft, Apple II/Apple II +  
APLUS is a 4K machine language utility that adds the following structured programming commands to Applesoft basic: 1) WHEN...ELSE...FIN, 2) UNTIL, 3) WHILE, 4) UNLESS, 5) CASE, 6) SELECT (variable), and 7) (OTHERWISE). Multi-line IF...THEN statements are also supported. APLUS allows the use of "named" subroutines or "procedures". The programmer can now instruct a program to "DO CURVE-FIT" without worrying about the location of the subroutine. APLUS automatically indents "&LIST"ed programs to clarify the logic flow. The APLUS "&CONVERT" command replaces the above structured programming commands with "GOTO"s and "GOSUB"s to provide a standard Applesoft program as output. New programs can now be written using "GOTO"-less logic.

**APPLESOFT PROGRAM OPTIMIZER [AOPT] \$20.00**

32 +, Disk II, ROM/RAM APPLESOFT, Apple II/Apple II +  
AOPT is a 2.2K machine language utility that will substantially reduce the size of an Applesoft program without affecting the operation of the program. AOPT automatically: 1) Shortens variable names, 2) Removes remarks, 3) Removes unreferenced lines, 4) Appends short lines together, 5) Removes extra colons, and 6) Renumbers line numbers. AOPT will convert a verbose, well documented, development version of a program into a memory-efficient, more secure, production version of the same program. This is the ORIGINAL and the BEST optimizer on the software market today!

**DOS PLUS \$25.00**

32 +, Disk II, DOS 3.3, Apple II/Apple II +  
DOS PLUS is the software solution for living with both 13-sector (DOS 3.1, 3.2, and 3.2.1) and 16 sector (DOS 3.3) Apple diskettes, DOS PLUS adds 8 new commands to Apple DOS. Three of these are built-in and five are user definable. The built in commands include: 1) ".F" to "flip" between DOS 3.2 and 3.3 (The user need not re-boot and any program that resides in memory will not be affected by the flip. The DOS version can even be changed within a program!), 2) ".S" status command informs you what DOS version is currently active, and 3) ".B" BLOAD- analysis is also provided to inform the user of the starting address and length of the last accessed binary file. DOS PLUS also includes a DOS COMMAND CHANGER program to allow easy customization of Apple DOS commands to suit individual tastes.

**DISK ORGANIZER II —NEW— \$30.00**

48K, Disk II, Apple II/Apple II +  
DO II is the fastest and friendliest utility available today for organizing files on an Apple II diskette. DO II provides the following functions: 1) TITLING in Normal, Inverse, Flashing, Lower case, and other characters normally not available, 2) CUSTOM REORDERING of the directory, 3) ALPHABETIZING, 4) DYNAMIC DISPLAY of ALL filenames on a diskette (including deleted files), 5) RENAMING files with the same character options as TITLING, 6) UNDELETING, 7) DELETING, 8) PURGING deleted files, 9) LOCKING (all or some), 10) UNLOCKING (all or some), 11) USE of DOS sectors for increased data storage, and 12) a SIMULATED CATALOG to show the modified directory **before** it is written to the diskette. DO II is completely MENU DRIVEN and attains it's speed by altering a RAM version of the catalog. DO II uses a very powerful SMART KEY to automatically locate the next valid filename for any specified disk operation. Compatible with DOS 3.1, 3.2, 3.2.1, and 3.3 as well as MUSE DOS to allow manipulation of SUPER TEXT files! (Note: Updates available for \$5.00 and original diskette.)

**PASCAL LOWER CASE —NEW— \$25.00**

48K +, Disk II, Apple II/Apple II +, Language System  
This is the most recent commercially available LOWER CASE MOD for Pascal for the Apple II. It is the only currently available modification that is compatible with both versions of Pascal (1.0 and 1.1). The Pascal version is automatically checked prior to updating system Apple. If you have any of the hardware lower case adapters you can now input the following characters directly from the keyboard: ` ` ~ ^ \_ and \. This modification does NOT interfere with any of the "Control" character functions implemented by the Pascal environment and will "undo" any alterations made by other commercially released modifications.

**QUICKLOADER \$25.00**

48K +, Disk II, Apple II/Apple II +, (2 Disks)  
If you find yourself doing the same things over and over -- QL will help you do it faster! QL is a unique disk that lets you load DOS, a language card (optionally), and an application program of your choice extremely rapidly. QL boots as a 13 or 16 sector diskette and is easy to set up and use. To change the setup, you merely load your Apple RAM with the new data and use the "RECONFIGURE" option of QL. The next time you boot your QL disk, it will quickly load your new setup (Language Card, DOS, Application program) into your Apple! QL can reduce the time to perform these functions by up to 80%! Now that you've read this, you say "But I can already do all of that!" QL doesn't do anything new -- it just does it MORE CONVENIENTLY and FASTER! Try it, you'll like it!

**DISK RECOVERY ["THE SCANNER"] \$30.00**

48K +, Disk II, Apple II/Apple II +  
This program is long overdue. You need no longer be concerned with the problem of physically damaged disks. Just as "Apple Pascal" provides a "BAD BLOCK SCAN", DISK RECOVERY will do a complete scan of your Apple diskettes' recording surface. Damaged areas will be "marked" as used in the disk directory so that no attempts will be made to "WRITE" to a bad sector. The VTOC will be completely redone to reflect both the bad sectors and actual disk usage. A complete report is generated advising the user of all corrections. A resulting "DISK MAP" is presented for your review. The greatest advantage of this program over the other versions is that it can be used on either NEWLY INITIALIZED DISKS or disks that ALREADY CONTAIN PROGRAMS as well as the SPEED of analysis. THE SCANNER is fully compatible with both 13 and 16 sector diskettes. This is a must for all Disk II owners!

**ALSO AVAILABLE:**

- SUPER DISK COPY III ..... \$30.00**
- MULTI-DISK CATALOG III ..... \$25.00**
- THE NEW PROTECTOR ..... \$250.00**  
(Call or Write for Information)
- LUNAR LANDER II ..... \$15.00**
- MASTER MAZE ..... \$15.00**

**SENSIBLE SOFTWARE, INC.**

6619 PERHAM DRIVE / W. BLOOMFIELD, MICHIGAN 48033  
313-399-8877

VISA and MASTERCARD WELCOME  
Michigan Residents add 4% Sales Tax  
Please add \$1.00 postage & handling for each item ordered.



## ASCII EXPRESS II

by BILL BLUE

Described in INFOWORLD as "The finest program for Apple data communications..." ASCII EXPRESS II allows your Apple to communicate with virtually any computer with dial-up access.

Written in Applesoft and Machine language, Ascii Express II includes everything you'd expect in a complete communications package. It features a variety of powerful features including full support of upper/lower case, autodial and answer capabilities (when used with the Hayes Micromodem), and file oriented upload/download facilities.

A built-in line editor gives full editing functions, and programmable keyboard MACROS reduce complicated log-in procedures to a few simple keystrokes.

Downloaded files may be printed while being received, saved to disk, or printed later when offline. The copy mode allows everything shown on the screen to be saved in the large (20K) buffer.

Ascii Express II works with the Hayes Micromodem II, Apple communications card, the CCS Asynchronous Serial card, SSM-AIO Board, Lynx Telephone Linkage System, and many other communications devices.

Uses include:

- Send/receive letters/files from networks like the SOURCE, MICRONET, or other bulletin board type systems.
- Transferring program files between Apples, an Apple and a TRS-80, PET, etc.
- Use the Apple as a terminal to a mainframe at a remote location with the added advantage of being able to process data at the Apple before or after transfer.
- Minimize on-line costs by quickly transferring files and other data.

System requirements include a 48K Apple with Applesoft in ROM or the Language Card, a disk drive, and one of the above communications devices. A lower case display board is recommended, but not required.

Price: \$64.95

## COMMUNICATIONS GAP ??? WE'VE GOT YOU COVERED!!



**S.D.S. offers a complete selection of communications software to meet almost every user's need. We think you'll find the three programs described here the best available anywhere — and we back that claim with our unconditional guarantee of satisfaction or your money back.**

**To find out more about these programs, send for more information, or see your local Apple dealer.**

## ONLINE

by BILL BLUE

ONLINE is a completely secure dial-up system that allows you to call your Apple computer while you're away from home. It also provides for up to 50 optional user accounts.

ONLINE includes a versatile mail system and built-in line editor with provisions for uploading and downloading programs and files.

Its many applications include use by businesses for 24 hour answering of field representatives inquiries, taking orders or advertising for your company. It can also be used by clubs or groups for posting announcements, or transferring files.

Requires 48K Apple with Hayes Micromodem and DOS 3.3.

Price: \$89.95  
(Calif. res. add 6% ON ALL PRICES)

**SDS**  
**southwestern data systems**  
P.O. BOX 582-M • SANTEE, CA 92071  
(714) 562-3670

## Z-TERM

by BILL BLUE

The Rolls-Royce of communications software. You may find cheaper programs but you'll never find one better. Not only does it provide everything Ascii Express II does, but then some. Designed for the CP/M environment using the Z-80 Softcard, Z-TERM permits a number of features not available elsewhere.

- Receives up to 41K of data at a time. Can send files of any size.
- Auto save mode sends XOFF character when buffer is full, and resumes (with operator prompting) after save.
- Terminal emulation allows you to define the type of terminal your Apple (equipped with 80 column board) will display as.
- Entirely in machine language for maximum speed and power.
- Complete programmable keyboard macros.
- Can produce entire ASCII character set including break.

Z-TERM fully supports the Hayes Micromodem, Apple Communications card, SSM-AIO board, CCS Asynchronous Serial Card, Lynx Communications system and others! Fully supports the local Apple 40 column screen, external terminals, and all 80 column boards interchangeably and with NO configuration necessary!

If you have a Z-80 card, you owe it to yourself to check this one out before you buy any communications software. If you don't have the Z-80 Softcard, you may want to get one just to run this package!

\*Note: CP/M and Apple DOS files are not directly compatible.

Price: \$99.95

**FINANCIAL MANAGEMENT SYSTEM**

**A FAST, EASY TO USE ACCOUNTING SYSTEM DESIGNED FOR HOME AND BUSINESS**  
 Enter an entire month's CHECKING, CHARGE CARD, and CASH accounts in just a few minutes using personalized macro lists. INSTANT ERROR CORRECTION. Audit all files by Code and Month with year-to-date totals.

- \* PERFECT FOR TAX ACCOUNTING
- \* SELF PROMPTING, ERROR AVOIDING ENTRY SYSTEM with 1 to 3 KEYSTROKE ENTRIES and AUTOMATIC OATE, CODING and NUMBER SEQUENCING.
- \* Printer routines for listing disk files, balance reconcile, search, and audit reports. Configure program to match almost ANY PRINTER.
- \* Enter your own ITEM and CODE MACROS, up to 100 each.
- \* Make specific and expanded searches employing complete use of macro lists
- \* 48K with ROM APPLESOFT and DISK required, (printer optional)
- \* PRICE: \$29.95

**FINANCIAL MANAGEMENT SYSTEM II**

ALL THE ABOVE FEATURES PLUS \*

- \* NEW BUDGET MANAGER - Plan, balance, and review your budget. Then generate COMPLETE reports with summation for any 1 - 12 month period.
- \* SINGLE or DUAL DISK compatible. Configure program to either disk sytem.
- \* PRICE: \$39.95

**GROCERY LIST**

**A USEFUL HOUSEHOLD PROGRAM DESIGNED TO ORGANIZE SUPERMARKET SHOPPING**

Shoppers will INSTANTLY be able to use this easy, self-prompting program. Scan a file of up to 500 USER DEFINED ITEMS. Choose those needed with a single key-stroke. Then print a shopping list ORGANIZED BY TABLE NUMBER, SECTION, or four letter code such as "DARY", "BAKE", or "DELI".

- \* 48K APPLE with disk and printer required, (APPLESOFT)
- \* PRICE: \$19.95

D R JARVIS COMPUTING  
 1039 CADIZ DR. - SIMI, CA 93065  
 PHONE (805) 526-0151

Check, VISA or MASTER CARD accepted. DEALER INQUIRIES INVITED



**A STATISTICAL ANALYSIS AND FILE MAINTENANCE SYSTEM FOR THE APPLE II™ MICROCOMPUTER**

As a Subset Language of P-STAT™ 78...  
 A-STAT™ 79 computes:

- FREQUENCIES
- BI-VARIATE TABLES - CHI SQUARES
- CORRELATION MATRICES
- MULTIPLE REGRESSION
- RESIDUALS
- APPLE PLOT INTERFACE
- APPLE FILE CABINET INTERFACE
- FILE SORT
- AGGREGATION
- REPORT WRITING
- COMPLETE TRANSFORMATION LANGUAGE
- READS VISICALC FILES

A-STAT™ 79

Uses Standard DOS Text File and EXEC's 48K Version — All programs in Applesoft™

A-STAT™ 79 is available from:

**ROSEN GRANDON ASSOCIATES**  
 296 PETER GREEN ROAD  
 TOLLAND, CONNECTICUT 06084  
 (203) 875-3541

A-STAT™ 79 on Disk with 95-page manual... \$125.00

Apple II™ is a trademark of the Apple Computer Inc.  
 P-STAT™ 78 is a trademark of P-STAT Inc., Princeton, N.J.  
 A-STAT™ 79 is copyrighted by Gary M. Grandon, Ph.D.

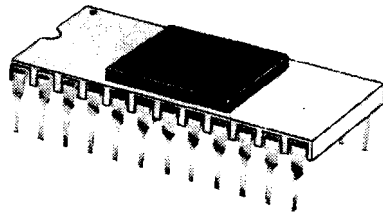

**DUAL DOS  
 IN  
 ROM  
 FOR APPLE II[\*]**

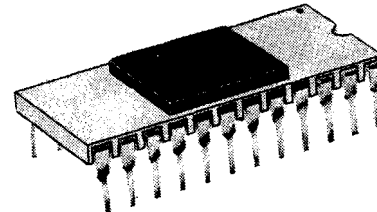

**SWITCH FROM ONE DOS (3.2 or 3.3) TO THE OTHER  
 WITHOUT BOOTING**

DUAL DOS ROMS - No gadgets or unsightly switches hanging from your disk controller, no software to run, no memory space used to store the other DOS, does not need the use of the 3.2 Proms (for those of you who purchased a disk drive with 3.3 DOS). Utilizes the standard 3.2.1 and 3.3 DOS, no special software (Muffin/Demuffin) to move your programs to and from 13 and 16 sector disks, no system pointers are changed, and is unaffected by any DOS commands. This invaluable utility is contained in two ROMs, which when plugged into MC's Romplus™ or the Andromeda ROMBoard™, will be permanently imbedded in your Apple's memory and waiting for instant access. The length of time it takes the Apple to perform a carriage return is about how fast it takes to switch from one DOS to the other. Both ROMs have their own intelligence which allows one ROM to find the other, in order for them to toggle between either DOS. Either ROM can be initialized first. If the 3.2 ROM is initialized first the Applesoft Ampersand command can be used to toggle or flip from one DOS to the other. On the otherhand, if you wish to preserve the existing Ampersand command vectors, the 3.3 ROM can be initialized first. The toggle or flip between DOS can then be accomplished by a simple CALL command from either Basic or Direct from the Monitor. Any program that is in memory will not be affected by the flip between DOS. The flexibility of toggling either DOS lends itself very easily to be done directly from within your own programs. Diskettes can be initialized from either DOS and 13 sector disks will have the faster INIT routine as part of its DOS. DUAL DOS ROMS are not recommended for use with disk drives that are configured with 3.2 Proms. Will operate with FP, INT, or LC and requires 48K, DOS 3.3, and MCs Romplus or Andromeda's ROMBoard.

(two ROM Set) **\$49.95**

**OTHER ROMS AVAILABLE:** All ROMS are compatible with MC's Romplus or Andromeda's ROM Board.)

- FP RENUMBER/MERGE ROM -Apple Computer's infamous renumber program ..... **\$35.95**
- BASICS ROM - Will boot standard, special, and dedicated 13 sector disks. .... **\$35.95**
- FP EDITROM - Global search, change, and remove. (Works jointly with PLE) ..... **\$35.95**
- COMMAND ROM - Catalog Command Menu and Disk Map. .... **\$35.95**
- DISK COPY/SPACE ROM - Duplicates 13 or 16 Sector Disks ..... **\$35.95**
- YOUR PLE ROM - Your Customized Program Line Editor in Firmware ..... **\$45.95**

ORDER 3 OR MORE (Dual DOS counts as one) AND DEDUCT 10% OF YOUR TOTAL ORDER. (Check or M.O.) Visa or MasterCard Accepted

**SOFT CTRL SYSTEMS, BOX 599, WEST MILFORD, NJ 07480**

\*REGISTERED TRADEMARK  
 ALL FIRMWARE IS COPYRIGHTED

# VersaWriter & APPLE II: The Keys to Unlimited Graphics

### DRAWING TABLET

Although VersaWriter operates on a simple principle, it produces graphics which match or exceed those of other digitizers. Rugged construction, translucent base, easy to use — plugs directly into APPLE II.

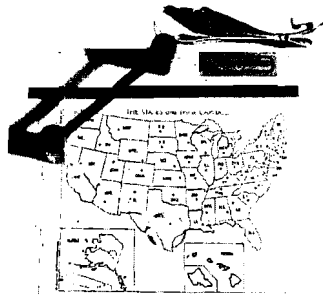
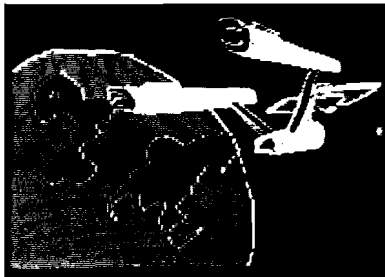

### GRAPHICS SOFTWARE

Easily the most capable and complete graphics software for the home computer available. Fast fill drawings in 100 colors. All text in five sizes, compile and display shapes, edit, move and much more!



### UNIQUE OFFER

See VersaWriter at your local dealer and pick up a copy of our demonstration disk. The complete VersaWriter hardware and software package is a real bargain at \$249. For more information call or write:

Versa Computing, Inc. • 887 Conestoga Circle • Newbury Park, CA 91320 • (805) 498-1956

**NEW**  
FOR  
**APPLE  
COMPUTERS**

## DOUBLE DOS Plus

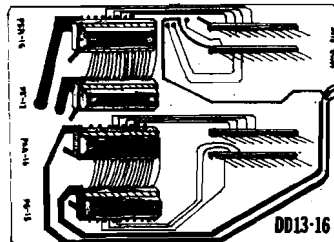

**\$39**

## MICRO-WARE

DISTRIBUTING INC.  
P. O. Box 113  
Pompton Plains, N.J. 07444

**201-839-3478**

DEALER INQUIRIES INVITED !!

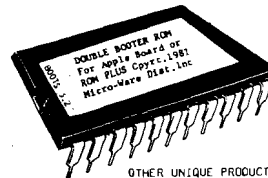

**MICRO-WARE**  
DISTRIBUTING INC.  
P. O. Box 113  
Pompton Plains, N.J. 07444

### OTHER UNIQUE PRODUCTS FROM MICRO-WARE DISTRIBUTING INC.

**THE APPLE CARD** - Two sided 100% plastic reference card for the Apple computer. Loaded with information of interest to all Apple owners.....\$3.98

**PARALLEL PRINTER CARD** - PPC-100 - A Universal Centronics type Parallel printer board complete with cable and connector. This unique board allows you to turn on and off the high bit so that you can access additional features in many printers. Use with EPSON, ANADIX, STARWRITER, NEC, SANDERS, OKI, and other with standard Centronics configuration.....\$139.00

**THE DOUBLE BOOTER ROM** - Plugs into the empty D8 Socket on the Apple motherboard or the Integer ROM Card to provide a 13 sector boot without using the Basics Disk. Doublebooter may also be used in the MOUNTAIN HARDWARE ROM PLUS board. This chip will not work in a plus machine unless it contains an Integer board or a ROM Plus board.....\$29.00

**DISK STIX** - Contains 10 dozen diskette labels with either 3.3 or 3.2 designation. Room for program names and type also.....\$3.98

### \*\*\*\*\* SOFTWARE \*\*\*\*\*

**SUPER SEA WAR** - Hires battleship type simulation...\$13.95  
**ULTIMATE XEROX** - A telephone software transfer program, uses DC Hayes Assoc. modems...\$25.00  
**ROAD RALLYE** - Hires driving game with 5 different full screen tracks...\$15.00  
**MISSILE CHALLENGER** - Hires arcade type game where you defend your cities from a falling missiles. 8 levels & writes name & high score to disk...\$19.95  
**SUPER PIX** - Hires screen dump for the EPSON MX-80, inverse or normal, larger than full page graphics in 2 orientations. Needs Tymec PPC-100 Printer board or we will upgrade your EPSON board for \$25.....\$39.95  
**GRAPH-FILL** - A hires graphing program that produces bar charts, pie charts and line graphs. Has auto scaling feature too.... \$25.00

### WHY IS DOUBLE DOS PLUS BETTER

- 1) Nothing needs to be soldered, just plug and go.
- 2) Since all four ROMs are used, all software will work even early 3.1 DOS.
- 3) Because the ROMs fit on the back of the board, it has the thinnest configuration allowing full use of slot #7.
- 4) One set of ROMs is powered up at time thereby saving power.
- 5) Full 90 day warranty

NOTE: APPLE is a registered trademark of APPLE COMPUTER INC., CUPERTINO, CALIFORNIA.  
 \*DOUBLE DOS PLUS REQUIRES APPLE DOS ROMS

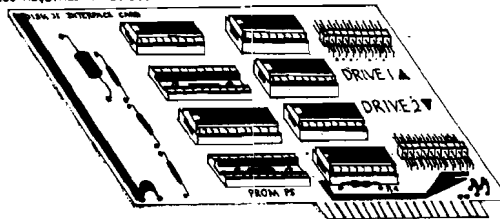

**DOUBLE DOS PLUS** - A piggyback board that plugs into the disk controller card so that you can switch select between DOS 3.2 and DOS 3.3. Works with the language system eliminating the need in many cases to boot the Basics disk. Also eliminates the chore of converting all of your 3.2 disks to 3.3.



# Serial Line Editor for the Apple

This routine is an extended line editor for the Apple, which allows inserting, deleting, and several other features.

Wes Huntress  
650 Chaparral Rd.  
Sierra Madre, California 91024

GETLN is a machine language routine which can be used to replace the standard line input routine which resides in the monitor ROM in your Apple. It is called at one entry point or another by both Applesoft and Integer BASICs for line input. The advantage of the alternate routine given here is the editing features that it contains. The Apple monitor ESC editing features are very useful for editing BASIC program lines, but are not the best for editing text. The editing features in GETLN are illustrative of serial text line editing and could form the basis of any line-oriented text processing program. GETLN also allows the input of normally forbidden characters in Applesoft, such as the comma and colon. All of this is gained at a slight disadvantage in usage. Applesoft programs must be moved up two pages in memory and a few extra program steps are required instead of a simple INPUT statement. GETLN should be used only for string input and string editing. The version given here is for Applesoft. With a few changes it can be made to work for Integer as well.

When called, GETLN prompts for input and places the characters in the keyboard buffer at \$200.2FF. All editing is done on the characters placed in the keyboard buffer. On return from GETLN it is necessary to move the characters from the keyboard buffer to the memory space that is to be occupied by the string. For Applesoft, this requires that the location in memory of the string variable's address pointer be

```

0800 *****
0801 **
0802 ** SERIAL LINE EDITOR **
0803 ** FOR APPLESOFT **
0804 **
0805 ** BY **
0806 **
0807 ** WES HUNTRESS **
0808 ** SIERRA MADRE, CA **
0809 ** (213)-355-8125 **
0810 **
0811 ** MAY 1980 **
0812 **
0813 *****
0814 ;
0815 ;EQUATES: CONSTANTS
0816 ;
0817 BS EPZ $88
0818 CR EPZ $8D
0819 CSM EPZ $9D
0820 CTL EPZ $20
0821 ESC EPZ $9B
0822 FIX EPZ $7F
0823 INV EPZ $80
0824 NAK EPZ $95
0825 BEND EPZ $FE
0826 ZERO EPZ $00
0827 BLANK EPZ $A0
0828 ;
0829 ;EQUATES: POINTERS
0830 ;
0831 CHAR# EPZ $19
0832 EDL EPZ $1A
0833 STRT EPZ $1B
0834 TEMP EPZ $1C
0835 SUBSTR EPZ $1D
0836 SUBEND EPZ $1E
0837 MODE EPZ $1F
0838 ;
0839 ;EQUATES: MONITOR ADDRESSES
0840 ;
0841 BUFFER EQU $0200
0842 KEYIN EQU $FD0C
0843 PRINT EQU $FDED
0844 BACKSP EQU $FC10
0845 ADVANC EQU $FBF4
0846 RETURN EQU $FC62
0847 CLREOF EQU $FC42
0848 BELL EQU $FF3A
0849 ;
0850 ORG $0800
0851 ;
0852 ;INITIALIZE KEYBOARD BUFFER
0853 ;
0854 GETLN LDY #BLANK ;LOAD BLANK CHARACTER
0855 CLR# STY BUFFER ;STORE IT IN KEYBOARD BUFFER
0856 INC #-2 ;FROM $0200
0857 BNE CLR# ;TO $02FF
0858 LDX #ZERO ;SET POINTERS TO ZERO:
0859 STX CHAR# ;CHARACTER NUMBER IN THE STRING
0860 STX EDL ;END OF LINE POINTER
0861 STX SUBSTR ;SUBSTRING START POINTER
0862 STX SUBEND ;SUBSTRING END POINTER
0863 STX MODE ;MAINLINE/SUBSTRING MODE FLAG
0864 ;
0865 ;MAINLINE CHARACTER ENTRY ROUTINE
0866 ;
0867 GETCHR JSR KEYIN ;GET CHAR USING MONITOR ROUTINE
0868 GETCH1 CMP #BS ;BACKSPACE?
0869 BEQ BKSPCE ;YES, GOTO BACKSPACE ROUTINE
0870 CMP #ESC ;ESCAPE KEY?
0871 BEQ ESCAPE ;YES, GOTO ESCAPE VECTOR ROUTINE
0872 CMP #NAK ;FORWARD ARROW?

```

(continued)

known. The method used to accomplish this is the same as given in CONTACT#6. A dummy variable is declared as the first variable in the program, i.e. X\$ = " ", which assigns the two-byte variable name to the first two locations in memory at the LOMEM: pointer. The third location is assigned to the string length, and the fourth and fifth locations to the address of the string in memory, low byte first.

The LOMEM: pointer is at \$69-70, so that the address of the string X\$ can now be found indirectly from the LOMEM: pointer. A separate machine language program is provided called GI which interfaces the GETLN routine with Applesoft programs by placing the address of the keyboard buffer, and the buffer string length, into the proper location for X\$ using the LOMEM: pointer.

The string X\$ is now assigned to the string in the keyboard buffer. In order to move it into the upper part of memory where Applesoft strings are normally stored, and to prevent the string from being clobbered the next time GETLN is called, the statement X\$ = MID\$(X\$,1) is used. This statement performs a memory move from the present location of X\$ (the keyboard buffer) to the next available space in high memory, and is the key to the success of the interface of GETLN with Applesoft programs.

**How to Use It**

To use GETLN with Applesoft programs, both GI and GETLN must be present in memory. To set up your program and call for input, use the following procedure:

```
5 X$ = " ":REM FIRST
  VARIABLE DECLARATION
```

```
100 CALL 834:A$ = MID$(X$,1):
  REM KEYBOARD INPUT
```

Line 100 replaces the INPUT A\$ statement. CALL 834 is to the keyboard input entry point in the GI interface routine. Three other entry points are provided in the interface routine. The call

```
100 CALL 853:X$ = MID$(X$,1):
  REM DOS INPUT
```

replaces the INPUT A\$ statement when READING text files from the disk. A separate routine from the keyboard

```
0823 F061      BEQ FORWRD      ;YES, GOTO FORWARD ARROW ROUTINE
0825 C98D      CMP #CR      ;RETURN?
0827 F063      BEQ LINEND      ;YES, GOTO EXIT ROUTINE
0829 A619      LDX CHAR#      ;NONE OF THESE, GET CURRENT CHAR#
082B 297F      AND #FIX      ;FIX NEG ASCII INPUT FOR APPLESOFT
082D 204508    JSR STRFNT      ;STORE AND PRINT CHAR
0830          ;
0830          ;POINTER UPDATING
0830          ;
0830 E619      FXPTRS INC CHAR#      ;INC POSITION-IN-STRING POINTER
0832 A619      LDX CHAR#      ;GET IT
0834 E41E      CPX SUBEND      ;AT END OF SUBSTRING OR BUFFER?
0836 F076      BEQ WHICH      ;YES, GO FIND OUT WHICH
0838 A41A      LDY EOL      ;GET END OF LINE POINTER
083A C419      CPY CHAR#      ;END OF CURRENT LINE?
083C B004      BCS FXPOUT      ;NO, SKIP EOL POINTER UPDATE
083E E61A      INC EUL      ;INCREMENT END OF LINE POINTER
0840 F05F      BEQ BUFULL      ;256 CHARS! GOTO BUFFER FULL
0842 4C1608    FXPOUT JMP GETCHR      ;DONE, GET ANOTHER CHARACTER
0845          ;
0845          ;STORE AND PRINT ROUTINE
0845          ;
0845          ;
0845 9D0002    STRPNT STA BUFFER,X      ;STORE IN CURRENT BUFFER LOC.
0848 C920      CMP #CTL      ;CONTROL CHARACTER?
084A 9002      BCC PNT      ;NO, SKIP TO PRINT
084C C980      ORA #INV      ;YES, CONVERT TO INVERSE
084E 20EDFD    PNT JSR PRINT      ;PRINT TO SCREEN
0851 60        RTS
0852          ;
0852          ;ESCAPE KEY VECTOR ROUTINE
0852          ;
0852 A41F      ESCAPE LDY MODE      ;SUBSTRING MODE?
0854 D048      BNE SBEXV      ;YES, GOTO SUBSTRING EXIT VECTOR
0856 200CFD    JSR KEYIN      ;GET ANOTHER CHARACTER
0858 C995      CMP #NAK      ;FORWARD ARROW?
085A F00F      BEQ INSV      ;YES, GOTO INSERT MODE VECTOR
085C C988      CMP #BS      ;BACKSPACE?
085E F011      BEQ DELV      ;YES, GOTO DELETE MODE VECTOR
0860 C9A0      CMP #BLANK      ;SPACE CHAR?
0862 F00A      BEQ ZMMV      ;YES, GOTO CURSOR ZOOM VECTOR
0864 C99D      CMP #CSM      ;CTRL-SHIFT-M?
0866 F00C      BEQ ZAPV      ;YES, GOTO LINE ZAP VECTOR
0868 407409    JMP CHREND      ;NONE OF THESE, GOTO CHAR FIND
086A 4C0509    INSV JMP INSERT      ;GOTO INSERT ROUTINE
086C 4C5509    ZMMV JMP ZOOM      ;GOTO CURSOR ZOOM ROUTINE
086E 4CED08    DELV JMP DELETE      ;GOTO DELETE ROUTINE
0870 4C9A09    ZAPV JMP ZAP      ;GOTO DELETE-TO-EOL ROUTINE
0872          ;
0872          ;BACKSPACE ROUTINE
0872          ;
0872 A419      BNSPCE LDY CHAR#      ;GET POSITION IN LINE
0874 C41D      CPY SUBSTRT      ;AT BEGINNING OF LINE/SUBSTRING?
0876 F005      BEQ BSOUT      ;YES, RETURN
0878 C619      DEC CHAR#      ;NO, DECREMENT POSITION IN LINE
0880 2010FC    JSR BACKSP      ;BACKSPACE CURSOR
0882 4C1608    BSOUT JMP GETCHR      ;RETURN
0884          ;
0884          ;FORWARD ARROW ROUTINE
0884          ;
0884          ;
0884 20F4FB      FORWRD JSR ADVANC      ;ADVANCE CURSOR
0886 4C3008      JMP FXPTRS      ;RETURN TO INCREMENT CHAR#
0888          ;
0888          ;EXIT ROUTINE
0888          ;
0888          ;
0888 A41F      LINEND LDY MODE      ;SUBSTRING MODE?
088A D00E      BNE SBEXV      ;YES, GOTO SUBSTRING EXIT
088C A619      LDX CHAR#      ;STORE CHARACTER COUNT
088E 861A      STX EOL      ;IN EOL POINTER
0890 9D0002    STA BUFFER,X      ;STORE CR AT END OF STRING
0892 2042FC    JSR CLREOP      ;CLEAR SCREEN TO END OF PAGE
0894 2062FC    JSR RETURN      ;PERFORM CARRIAGE RETURN
0896 60        RTS      ;EXIT TO CALLER
0898 4C3D09    SBEXV JMP SUBEXT      ;GOTO SUBSTRING EXIT
08A1          ;
08A1          ;BUFFER FULL ROUTINE
08A1          ;
08A1          ;
08A1 C61A      BUFULL DEC EOL      ;DECREMENT EOL POINTER
08A3 C619      BUFULL DEC CHAR#      ;DECREMENT CURSOR POSITION
08A5 2010FC    JSR BACKSP      ;BACKSPACE
08A7 203AFF    BELEX JSR BELL      ;SOUND BELL
08A9 4C1608    JMP GETCHR      ;RETURN
08AE          ;
08AE          ;DETERMINE MAINLINE OR SUBSTRING MODE
08AE          ;
08AE          ;
08AE A41F      WHICH LDY MODE      ;SUBSTRING MODE?
08B0 F0F1      BEQ BUFULL      ;NO, GOTO BUFFER END ROUTINE
08B2 4C1709    JMP MOVEFD      ;YES, MOVE RIGHT STRING FORWARD
08B5          ;
08B5          ;MOVE STRING BACK ROUTINE
08B5          ;
08B5          ;
08B5 A619      MOVEBK LDX CHAR#      ;GET DESTINATION START
08B7 A41B      LDY STRT      ;GET STRING START
08B9 A51A      LDA EOL      ;GET STRING END
08BB 38        SEC
08BD E51B      SBC STRT      ;SUBTRACT STRING START
08BF 18        CLC
08C1 6519      ADC CHAR#      ;ADD PRESENT CURSOR POSITION
08C3 851C      STA TEMP      ;STORE NEW EOL POINTER
08C5 B90002    MVBLEP LDA BUFFER,Y      ;GET STRING CHARACTER
```



```

08C6 204508      JSR STRPNT      ;STORE AND PRINT CHARACTER
08C9 CB         INY          ;INCREMENT THE
08CA EB         INX          ;POSITION POINTERS
08CB C41A       CPY EOL      ;END OF STRING?
08CD 90F4       BCC MVFLP     ;NO, GET ANOTHER CHARACTER
08CF 2042FC     JSR CLREOP     ;YES, CLEAR TO END OF PAGE
08D2 8A         TXA          ;STORE CURSOR POSITION
08D3 AB         TAY          ;IN Y REGISTER
08D4 A9A0       LDA #BLANK    ;GET SPACE CHARACTER
08D6 9D0002     CLRLP STA BUFFER,X ;STORE IN BUFFER BEYOND NEW EOL
08D9 EB         INX          ;INCREMENT POSITION
08DA E41A       CPX EOL      ;AT OLD END OF LINE?
08DC 90FB       BCC CLRLP     ;NO, DO IT AGAIN
08DE A61C       LDX TEMP     ;YES, GET NEW EOL
08E0 861A       STX EOL      ;STORE IT
08E2 98         TYA          ;GET CURSOR POSITION
08E3 AA         TAX          ;BACK INTO X REGISTER
08E4            ;
08E4            ;RESTORE CURSOR ROUTINE
08E4            ;
08E4 2010FC     RESTOR JSR BACKSP   ;BACKSPACE
08E7 CA         DEX          ;DECREMENT CURSOR POSITION
08E8 E419       CPX CHAR#    ;AT PRESENT CHARACTER POSITION?
08EA D0FB       BNE RESTOR   ;NO, DO IT AGAIN
08EC 60         RTS          ;YES, RETURN
08ED            ;
08ED            ;DELETE ROUTINE
08ED            ;
08ED A619       DELETE LDX CHAR# ;GET PRESENT CHARACTER POSITION
08EF EB         INX          ;INCREMENT TO NEXT CHARACTER
08F0 861E       STX STRT     ;STORE STRING START POSITION
08F2 A41A       DELELP LDY EOL ;GET END OF LINE POINTER
08F4 C419       CPY CHAR#    ;SAME AS NEXT CHARACTER POSITION?
08F6 F00A       BEQ DELOUT   ;YES, NOTHING TO DELETE!
08F8 20B508     JSR MOVEBK   ;NO, MOVE STRING BACK ONE SPACE
08FB 200CFD     JSR KEYIN    ;GET ANOTHER CHARACTER
08FE C988       CMP #BS     ;ANOTHER BACKSPACE CHARACTER?
0900 F0F0       BEQ DELELP   ;YES, DELETE ANOTHER CHARACTER
0902 4C1908     DELOUT JMP GETCH1 ;NO, BACK TO MAINLINE
0905            ;
0905            ;INSERT ROUTINE INITIALIZE
0905            ;
0905 A61A       INSERT LDX EOL  ;GET END OF LINE POINTER
0907 E0FE       CPX #BEND    ;END OF ALLOWABLE INSERTIONS?
0909 B09D       BCS BELEX    ;YES, STOP INPUT
090B A619       LDX CHAR#    ;NO, GET POSITION IN LINE
090D E41A       CPX EOL      ;AT END OF LINE?
090F F029       BEQ INOUT    ;YES, NO NEED TO INSERT!
0911 861D       STX SUBSTR   ;NO, STORE SUBSTRING START
0913 861E       STX SUBEND   ;STORE PRESENT SUBSTRING END
0915 B51F       STA MODE     ;SET SUBSTRING MODE FLAG
0917            ;
0917            ;MOVE STRING FORWARD ROUTINE
0917            ;
0917 20F4FB     MOVEFD JSR ADVANC  ;ADVANCE CURSOR
091A B00002     LDA BUFFER,X  ;GET FIRST STRING CHARACTER
091D E61A       INC EOL      ;INCREMENT EOL POINTER
091F F02E       BEQ SBOUT    ;BUFFER END! STOP INPUT
0921 EB         INX          ;POINT TO SECOND CHARACTER
0922 B00002     LDY BUFFER,X  ;GET SECOND CHARACTER
0925 204508     JSR STRPNT   ;STORE AND PRINT FIRST CHAR
0928 98         TYA          ;TRANSFER SECOND CHAR TO ACC.
0929 E41A       CPX EOL      ;END OF LINE?
092B D0F4       BNE MVFLP     ;NO, DO IT AGAIN
092D EB         INX          ;YES
092E 20E408     JSR RESTOR   ;RESTORE CURSOR
0931 98         TYA          ;GET SPACE CHAR INTO ACC.
0932 204508     JSR STRPNT   ;STORE & PRINT AT INSERT POSITION
0935 2010FC     JSR BACKSP   ;RETURN CURSOR TO INSERT POSITION
0938 E61E       INC SUBEND   ;INCREMENT SUBSTRING END POINTER
093A 4C1608     INOUT  JMP GETCHR ;GET ANOTHER CHAR
093D            ;
093D            ;SUBSTRING EXIT ROUTINE
093D            ;
093D A61E       SUBEXT LDX SUBEND ;GET SUBSTRING END POSITION
093F 861B       STX STRT     ;STORE IN STRING START POINTER
0941 20B508     JSR MOVEBK   ;MOVE RIGHT STRING BACK
0944 A200       LDX #ZERO    ;RESET THE
0946 861D       STX SUBSTR   ;SUBSTRING START,
0948 861E       STX SUBEND   ;SUBSTRING END POINTERS
094A 861F       STX MODE     ;AND MODE FLAG
094C 4C1608     JMP GETCHR   ;BACK TO MAINLINE
094F 2010FC     SBOUT  JSR BACKSP ;BACKSPACE
0952 4CA108     JMP BUFULL   ;GOTO BUFFER FULL
0955            ;
0955            ;CURSOR ZOOM ROUTINE
0955            ;
0955 A51A       ZOOM  LDA EOL  ;GET EOL POINTER
0957 F00E       BEQ ZMOUT    ;NULL LINE! RETURN
0959 AA         TAX          ;STORE EOL IN X REGISTER
095A E519       SRC CHAR#    ;CURSOR AT END OF LINE?
095C F00C       BEQ ZBEG     ;YES, ZOOM TO LINE START
095E 8619       STX CHAR#    ;STORE CURSOR POSITION (EOL)
0960 AA         TAX          ;GET ADVANCE COUNT IN X REGISTER
0961 20F4FB     ZOOMLP JSR ADVANC ;ADVANCE CURSOR
0964 CA         DEX          ;DECREMENT ADVANCE COUNT
0965 D0FA       BNE ZOOMLP   ;ADVANCE AGAIN IF NOT AT EOL

```

(continued)

input routine is required for Applesoft programs since the DOS stores and outputs all text files in negative ASCII. The call

```
100 X$=A$:CALL 800:REM
PRINT
```

can be used in place of the PRINT A\$ statement to print all control characters in inverse video. Otherwise use the PRINT A\$ statement as usual. To recall a string for further editing, use

```
100 X$=A$:CALL 807:A$=
MID$(X$,1):REM EDIT
```

The cursor will be placed on the screen at the beginning of the recalled string. Dimensioned strings can be used as well as simple strings. GETLN can also be used alone from assembly language using 800G. It will place the input string in the keyboard buffer in standard ASCII terminated by \$8D [CR].

GETLN occupies nearly two pages of memory from \$800 to \$9AF. Since Applesoft programs normally reside in this space, it is necessary to move your program up in memory to make room for GETLN. This is readily accomplished by two statements:

```
POKE 104,10:POKE 2560,0
```

This line must be executed either from immediate mode or from an EXEC file before loading the Applesoft program. The short interface routine occupies locations \$300 to \$355.

### Editing Features

The following edit commands are implemented in GETLN. Except for the usual Apple ←, → and RETURN editing keys, all commands are initiated by hitting the ESC key.

- Move cursor right, copy character
- ← Move cursor left
- RETURN Terminate line, clear to end of page
- ESC → Initiate insert mode, ESC or RET to exit
- ESC ← Delete character, recursive
- ESC sp bar Move cursor to beginning (end) of line
- ESC char Move cursor to first occurrence of char
- ESC ctrl-shift-M Delete remainder of line

The first three commands operate just as in the Apple monitor line editor. The monitor ESC functions are replaced with the five ESC functions listed above. Use ESC → to insert characters at any place in the line. Use the usual monitor → and ← keys to position the cursor over the character where you wish to insert. ESC → will push right by one character the entire string beginning

#800.9CF

```

0800- A0 A0 8C 00 02 EE 03 08
0808- D0 F8 A2 00 86 19 86 1A
0810- 86 1D 86 1E 86 1F 20 0C
0818- FD C9 88 F0 5B C9 9B F0
0820- 31 C9 95 F0 61 C9 8D F0
0828- 63 A6 19 29 7F 20 45 08
0830- E6 19 A6 19 E4 1E F0 76
0838- A4 1A C4 19 B0 04 E6 1A
0840- F0 5F 4C 16 08 9D 00 02
0848- C9 20 90 02 09 B0 20 ED
0850- FD 60 A4 1F D0 48 20 0C
0858- FD C9 95 F0 0F C9 88 F0
0860- 11 C9 A0 F0 0A C9 9D F0
0868- 0C 4C 74 09 4C 05 09 4C
0870- 55 09 4C ED 08 4C 9A 09
0878- A4 19 C4 1D F0 05 C6 19
0880- 20 10 FC 4C 16 08 20 F4
0888- FB 4C 30 08 A4 1F D0 0E
0890- A6 19 86 1A 9D 00 02 20
0898- 42 FC 20 62 FC 60 4C 3D
08A0- 09 C6 1A C6 19 20 10 FC
08A8- 20 3A FF 4C 16 08 A4 1F
08B0- F0 F1 4C 17 09 A6 19 A4
08B8- 1B A5 1A 38 E5 1B 18 65
08C0- 19 85 1C B9 00 02 20 45
08C8- 08 C8 E8 C4 1A 90 F4 20
08D0- 42 FC 8A A8 A9 A0 9D 00
08D8- 02 E8 E4 1A 90 F8 A6 1C
08E0- 86 1A 98 AA 20 10 FC CA
08E8- E4 19 D0 F8 60 A6 19 E8
08F0- 86 1B A4 1A C4 19 F0 0A
08F8- 20 B5 08 20 0C FD C9 88
0900- F0 F0 4C 19 08 A6 1A E0
0908- FE B0 9D A6 19 E4 1A F0
0910- 29 86 1D 86 1E 85 1F 20
0918- F4 FB BD 00 02 E6 1A F0
0920- 2E E8 BC 00 02 20 45 08
0928- 98 E4 1A D0 F4 E8 20 E4
0930- 08 98 20 45 08 20 10 FC
0938- E6 1E 4C 16 08 A6 1E 86
0940- 1B 20 B5 08 A2 00 86 1D
0948- 86 1E 86 1F 4C 16 08 20
0950- 10 FC 4C A1 08 A5 1A F0
0958- 0E AA E5 19 F0 0C 86 19
0960- AA 20 F4 FB CA D0 FA 4C
0968- 16 08 20 10 FC CA D0 FA
0970- 86 19 F0 F3 29 7F 85 1B
0978- A6 19 E8 20 F4 FB E4 19
0980- F0 0D E4 1A B0 0C BD 00
0988- 02 C5 1B D0 ED 86 19 4C
0990- 16 08 20 10 FC CA D0 FA
0998- F0 E4 A6 19 A9 A0 20 45
09A0- 08 E8 E4 1A 90 F8 20 E4
09A8- 08 4C 16 08 A2 FF E8 20
09B0- 0C FD 9D 00 02 C9 8D D0
09B8- F5 86 1A E8 BD FF 01 29
09C0- 7F 9D FF 01 CA D0 F5 A6
09C8- 1A 60 00 00 00 00 00
    
```

```

0967 4C1608 ZMOUT JMP GETCHR ;BACK TO MAINLINE
096A 2010FC ZBEG JSR BACKSP ;BACKSPACE
096D CA DEX ;DECREMENT POSITION IN LINE
096E D0FA BNE ZBEG ;DO IT AGAIN IF NOT AT LINE START
0970 8619 STX CHAR# ;STORE CURSOR POSITION
0972 F0F3 BEQ ZMOUT ;BACK TO MAINLINE
0974 ;
0974 ;CHARACTER SEARCH ROUTINE
0974 ;
0974 297F CHRFLD AND #FIX ;CONVERT NEG ASCII INPUT
0976 B51E STA STRT ;STORE KEY CHARACTER
0978 A619 LDX CHAR# ;GET PRESENT CURSOR POSITION
097A EB CHRFLP INX ;INCREMENT CURSOR POINTER
097B 20F4FB JSR ADVANC ;ADVANCE CURSOR
097E E419 CHRFLP CPX CHAR# ;AT OLD CURSOR POSITION?
0980 F00D BEQ CHFOUT ;YES, CHARACTER NOT FOUND
0982 E41A CPX EOL ;END OF LINE?
0984 B00C BCS SBEG ;YES, START AGAIN AT LINE START
0986 BD0002 LDA BUFFER,X ;GET CHARACTER AT THIS POSITION
0989 C51E CMP STRT ;SAME AS KEY?
098B D0ED BNE CHRFLP ;NO, TRY AGAIN
098D B619 STX CHAR# ;YES, STORE CURSOR POSITION
098F 4C1608 CHFOUT JMP GETCHR ;BACK TO MAINLINE
0992 2010FC SBEG JSR BACKSP ;BACKSPACE
0995 CA DEX ;BEGINNING OF LINE?
0996 D0FA BNE SBEG ;NO, BACKSPACE AGAIN
0998 F0E4 BEQ CHRFL ;YES, CONTINUE SEARCH
099A ;
099A ;ZAP (DELETE TO END OF LINE) ROUTINE
099A ;
099A A619 ZAP LDX CHAR# ;GET CURSOR POSITION
099C A9A0 LDA #BLANK ;LOAD ACC. WITH SPACE CHAR
099E 204508 ZAPLP JSR STRPNT ;STORE AND PRINT IT
09A1 EB INX ;NEXT POSITION
09A2 E41A CPX EOL ;END OF LINE?
09A4 90F8 BCC ZAPLP ;NO, DO IT AGAIN
09A6 20E408 JSR RESTOR ;YES, RESTORE CURSOR
09A7 4C1608 JMP GETCHR ;BACK TO MAINLINE
09AC ;
09AC ;DISK INPUT ROUTINE
09AC ;
09AC A2FF DISKIN LDX #ZERO-$1 ;INITIATE THE
09AE EB DISK1 INX ;CHAR# POINTER
09AF 200CFD JSR KEYIN ;GET A CHARACTER
09B2 9D0032 STA BUFFER,X ;STORE IN BUFFER
09B5 C98D CMP #CR ;CARRIAGE RETURN?
09B7 D0F5 BNE DISK1 ;NO, GET ANOTHER CHARACTER
09B9 B61A STX EOL ;YES, STORE CHARACTER COUNT
09BB EB INX ;INIT FOR ASCII CONVERSION
09BC B0FF01 DISK2 LDA BUFFER-$1,X ;GET BUFFER CHARACTER
09BF 297F AND #FIX ;CONVERT FOR APPLESOFT
09C1 9DFF01 STA BUFFER-$1,X ;PUT IT BACK
09C4 CA DEX ;COUNT BACK TO ZERO
09C5 D0F5 BNE DISK2 ;LOOP IF NOT FINISHED
09C7 A61A LDX EOL ;CHAR COUNT IN X REG.
09C9 60 RTS ;EXIT TO CALLER
    
```

```

0800 *****
0800 ;* *
0800 ;* INTERFACE CODE *
0800 ;* FP - GETLN *
0800 ;* *
0800 ;* BY *
0800 ;* *
0800 ;* WES HUNTRESS *
0800 ;* SIERRA MADRE, CA *
0800 ;* (213)-355-8125 *
0800 ;* *
0800 ;* MAY 1980 *
0800 ;* *
0800 *****
0800 ;
0800 ;EQUATES: CONSTANTS & ZERO PAGE
0800 ;
0800 CURS EPZ $19
0800 ZERO EPZ $00
0800 BLANK EPZ $A0
0800 LENLOC EPZ $02
0800 STADRL EPZ $08
0800 STADRH EPZ $09
0800 STRLEN EPZ $1A
0800 VARPTR EPZ $09
0800 ;
0800 ;EQUATES: BUFFER & ADDRESSES
0800 ;
0800 BUFFER EQU $0200
0800 GETLN EQU $0800
0800 ENTRY EQU $0B10
    
```

```

0800 STRPNT EQU $0845
0800 DISKIN EQU $09AC
0800 BACKSP EQU $FC10
0800 RETURN EQU $FC62
0800 ;
0800 ORG $0300
0800 ;
0800 ;PRINT X$ SUBROUTINE
0800 ;
0800 A002 PSCRN LDY #LENLOC
0802 B169 LDA (VARPTR),Y ;GET X$ STRING LENGTH
0804 B51A STA STRLEN ;STORE STRING LENGTH PTR
0806 C8 INY
0807 B169 LDA (VARPTR),Y ;GET X$ ADDR LOW BYTE
0809 B508 STA STADRL ;STORE IN X$ ADDR PTR LOW
080B C8 INY
080C B169 LDA (VARPTR),Y ;GET X$ ADDR HI BYTE
080E B509 STA STADRH ;STORE IN X$ ADDR PTR HI
0810 A000 LDY #ZERO ;INITIATE THE
0812 A200 LDX #ZERO ; COUNTERS
0814 B108 PNTLF LDA (STADRL),Y ;GET MID*(X$,Y,1)
0816 204506 JSR STRPNT ;STORE & PRINT
0819 E8 INX ;INCREMENT
081A C8 INY ; COUNTERS
081B C41A CPY STRLEN ;END OF STRING?
081D 90F5 BCC PNTLF ;NO, GET ANOTHER CHAR
081F 60 RTS ;EXIT TO CALLER
0820 ;
0820 ;PRINT X$ TO SCREEN
0820 ;
0820 200003 PRINT JSR PSCRN ;PRINT X$
0823 2062FC JSR RETURN ;DO A CARRIAGE RETURN
0826 60 RTS ;EXIT TO CALLER
0827 ;
0827 ;EDIT X$
0827 ;
0827 200003 EDIT JSR PSCRN ;PRINT X$
082A A9A0 LDA #BLANK ;PUT SPACE CHAR
082C 9D0002 EDLP1 STA BUFFER,X ; INTO REMAINING
082F E8 INX ; BUFFER SPACE
0830 D0FA BNE EDLP1
0832 2010FC EDLP2 JSR BACKSP ;RESTORE CURSOR
0835 86 DEY ; TO LINE START
0836 D0FA BNE EDLP2
0838 A200 LDX #ZERO ;STORE CURSOR
083A 8619 STX CURS ; POSITION
083C 201006 JSR EENTRY ;GETLN EDIT ENTRY
083F 4C4503 JMP TOX$ ;PUT IN X$
0842 ;
0842 ;X$ KEYBOARD INPUT
0842 ;
0842 200006 KYBIN JSR GETLN ;GET A LINE
0845 A002 TOX$ LDY #LENLOC ;TRANSFER STRING
0847 8A TXA ; LENGTH FROM ADDR.
0848 9169 STA (VARPTR),Y ; TO X$
084A C8 INY
084B A900 LDA #ZERO ;STORE
084D 9169 STA (VARPTR),Y ; KEYBOARD
084F C8 INY ; BUFFER
0850 A902 LDA #LENLOC ; ADDRESS
0852 9169 STA (VARPTR),Y ; INTO X$
0854 60 RTS ;EXIT TO CALLER
0855 ;
0855 ;X$ DOS INPUT
0855 ;
0855 204C09 DOSIN JSR DISKIN ;GETLN DOS INPUT ENTRY
0858 4C4503 JMP TOX$ ;PUT INPUT IN X$

```

\*300.35F

```

0300- A0 02 B1 69 85 1A C8 B1
0308- 69 85 08 C8 B1 69 85 09
0310- A0 00 A2 00 B1 08 20 45
0318- 08 E8 C8 C4 1A 90 F5 60
0320- 20 00 03 20 62 FC 60 20
0328- 00 03 A9 A0 9D 00 02 E8
0330- D0 FA 20 10 FC 88 D0 FA
0338- A2 00 86 19 20 10 08 4C
0340- 45 03 20 00 08 A0 02 8A
0348- 91 69 C8 A9 00 91 69 C8
0350- A9 02 91 69 60 20 AC 09
0358- 4C 45 03 00 00 00 00 00

```

from the character under the cursor to the end of the line, leaving a blank under the cursor. As you type in new characters, the old right-hand string is continuously shifted right. The ← and → keys work on the inserted substring as before but will not allow editing left of the first inserted character. In the insert mode, → operates just like the space bar if keyed at the right-hand end of the substring. To terminate the insert mode, press ESC or RETURN. The old right-hand string is moved back one space for reconnection.

The ESC ← command deletes the character under the cursor and pulls left the entire string to the right of the cursor. The function is recursive, so that characters can continue to be deleted by repeated keying of the ← key. The first key pressed other than ← terminates the function.

The ESC space bar command moves the cursor to the end of the line. If the cursor is already at the end of the line, then it is moved to the beginning. This function allows rapid transport of the cursor to the beginning or end of the line.

The ESC char command moves the cursor right in the line to the first occurrence of the character key pressed after the escape key. If the character is not found before the end of the line, then the search branches to the beginning of the line. If the character is not found in the line, then the cursor is not moved.

The ESC ctrl-shift-M command deletes the entire line to the right of the cursor including the character under the cursor. This function allows excess garbage to be cleared from the line for editing readability.

Together these functions give you an intriguing and powerful text line editor. It's much more fun than the Apple monitor line input routine. Try it! You'll like it!

**MICRO**

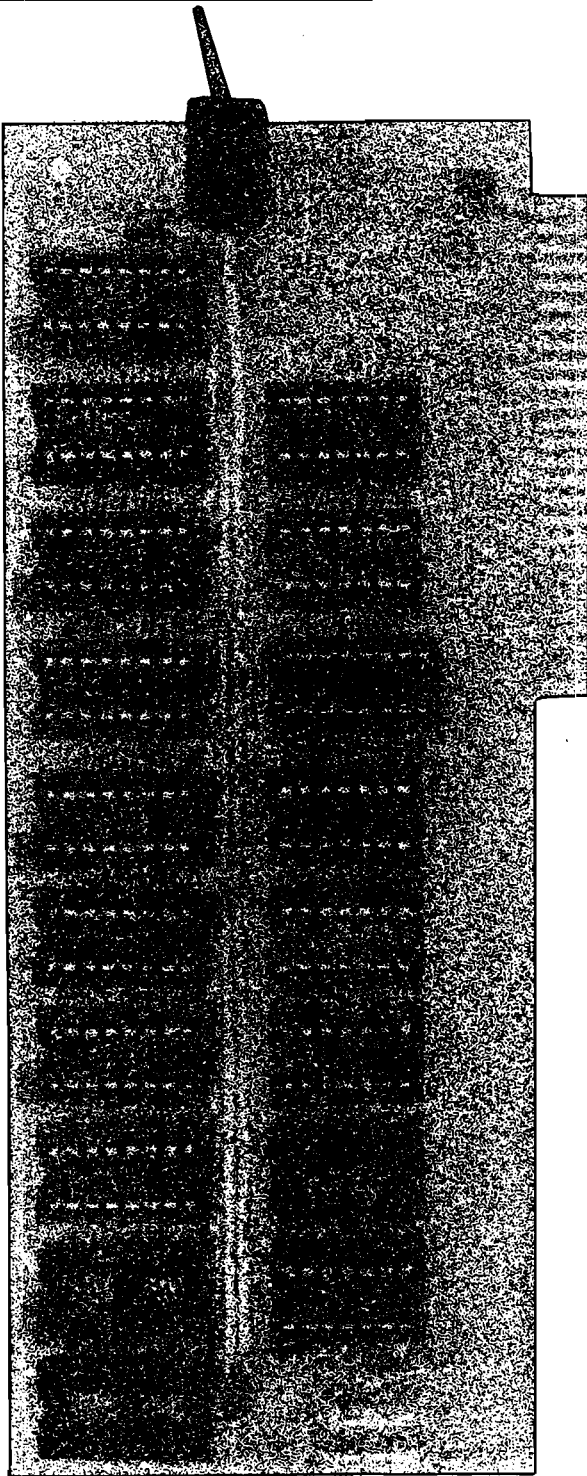

# 16K RAM Expansion Board for the Apple II\* \$195.00

- expands your 48K Apple to 64K of programmable memory
- works with Microsoft Z-80 card, Visicalc, LISA ver 2.0 and other software
- eliminates the need for an Applesoft\* or Integer Basic ROM Card
- switch selection of RAM or mother board ROM language
- includes installation and use manual
- fully assembled and tested

Distributed by Computer Data Services  
P.O. Box 469  
Lincoln, MA 01773  
(617) 259-9791

\*Apple II and Applesoft are trademarks of Apple Computer, Inc.

# ANDROMEDA



INCORPORATED\*\*

P.O. Box 19144  
Greensboro, NC 27410  
(919) 852-1482

\*\*Formerly Andromeda Computer System

# Improved KIM Communication Capabilities

**Add new I/O capabilities to your KIM with this software/hardware combination.**

Ralph Tenny  
P.O. Box 545  
Richardson, Texas 75080

## Code and Text Transfer

Unless he has a programmer, the small system owner often wonders how to program EPROMs for his system. Or, if he locates a friend with a programmer on his system, he then must figure out how to develop the program code on the KIM, test it, and then get the code into the system with the programmer. It is extremely likely that any scheme involving re-entry of the code in the second system will introduce errors, so it is desirable that the KIM produce a copy of its own code in a form usable by the second system.

First you need a program which puts out the exact memory image of the developed and debugged program.

KIMOUT is such a program, which uses a second RS-232 port added to KIM. The reason that KIM's serial port is not suitable (in many cases) is that the KIM port has a hardware echo built in. Also, in some cases, the I/O lines driving KIM's serial port are disturbed by the operating system. Thus, a second port (described later) allows you to have an unrestricted and undisturbed, echo-free serial I/O port which won't ruffle the feathers of any other computer system it may be talking to.

The chief difference between KIMOUT and any other memory dump program is that KIMOUT does no data formatting, and inserts no characters which are not part of the memory image desired in EPROM. The software shown uses the second serial I/O program which was adapted from KIM's software to drive the second serial port. All the "new" software is part of an additional 2K of EPROM added to KIM and located at C000<sub>16</sub> through C7FF<sub>16</sub>. However, these routines have been located beginning at 0200 and 0300 by making the appropriate changes in addresses.

Once the program to be ROMmed is

ready, KIMOUT is given the starting and ending addresses of the program as follows:

	Start	End
Address Low	0002	0004
Address High	0003	0005

Baud Rate	17F2 CNTL 30	17F3 CNTH 30
110		
300	E8	00
1200	35	00

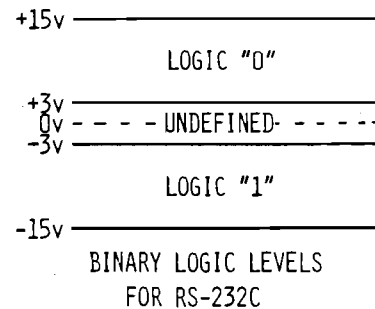

**Figure 1: RS-232 signals have a voltage "deadband" between +3V and -3V to increase the noise immunity of the equipment.**

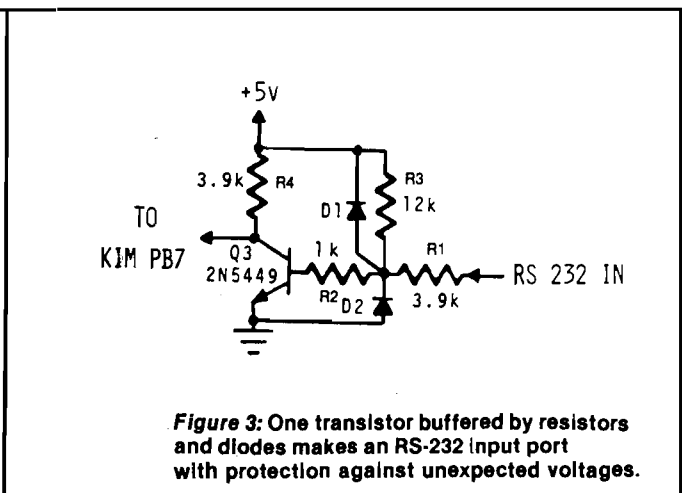
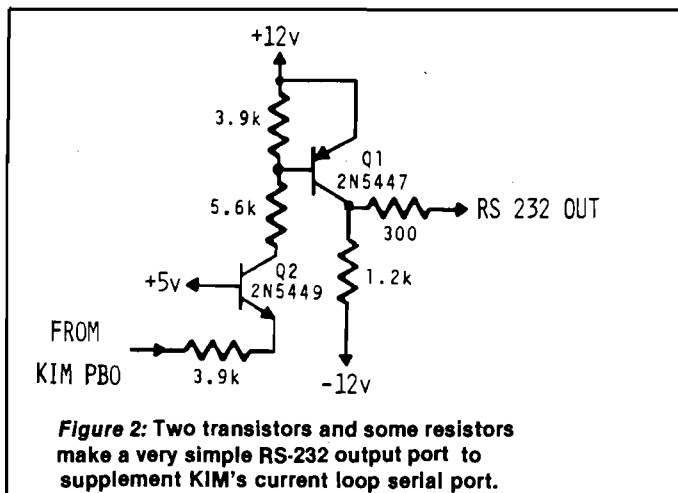

Set the timing constants in CNTL30 and CNTH30 (17F2, 17F3) for the proper data rate (see table 1), connect the two computers, start the receiving program in the other computer, then start KIMOUT. When KIMOUT has finished, it will re-light the KIM display, and you can terminate the receiving program.

In my case, the receiving program was in a TM990/189 (TI's University Board), which uses only 300 baud. Once the data has been transferred, I check starting and ending bytes, and a few representative other locations in the '189 memory, then dump the data to audio tape. [The TM990/189 will make a digital tape if a Model 733 TI terminal is available.] The '189 at work can read this audio tape and there is a programmer attached to it. About five minutes after dumping the tape, I have another EPROM for KIM!

It should be noted that some EPROM programmers [and some computers] will require that data handled in this manner be formatted into blocks with checksums. The tapes themselves use TI's tag loader format, so the actual transfer between the two University Boards is protected by checksums. So far, I have never encountered an error introduced by the process described, so maybe I've been lucky!

The program called TRANSLATE contains three smaller programs which cooperate in another type of data transfer. The Radio Shack TRS-80C™ computer has a 600 baud printer port, and the software issues only carriage returns instead of the CRLF pair issued by KIM and many other computers at the end of a line. I had no access to any 600 baud printers, and even my CRT terminal needed the line feed to present a picture of the TRS-80C output. So, the first section of TRANSLATE [SETUP] beginning at 0200 will read code or text from memory and add a line feed to any carriage return found.

The second section of TRANSLATE [RCV] beginning at 0238 will receive any continuous string of ASCII characters and place the characters in contiguous memory locations as long as there is memory left. If the string over-writes the end of the buffer (on KIM, the available buffer is 03E0-13FF), it quits listening and bounces back to the KIM monitor. Finally, the third section of TRANSLATE [CLEAR] clears memory beginning at the address specified in 0002 and 0003 [the same buffer is used for all sections of TRANSLATE] and extending through 13FF.

```

0800 ;*****
0800 ;*
0800 ;* COMMUNICATIONS SUPPORT *
0800 ;*
0800 ;* BY RALPH TENNY *
0800 ;*
0800 ;*****
0800 ;*
0800 PBD EQU $1702
0800 PBDD EQU $1703
0800 CNTL30 EQU $17F2
0800 CNTH30 EQU $17F3
0800 TIMH EQU $17F4
0800 START EQU $1C4F
0800 CRLF EQU $1E2F
0800 INITS EQU $1E88
0800 OUTCH EQU $1EA0
0800 PACK EQU $1FAC
0800 TOP EQU $1FD5
0800 ;
0800 SAL EPZ $02
0800 SAH EPZ $03
0800 EAL EPZ $04
0800 EAH EPZ $05
0800 YTMP EPZ $20
0800 TMPY EPZ $EE
0800 INL EPZ $F8
0800 TEMP EPZ $FC
0800 TMPX EPZ $FD
0800 CHAR EPZ $FE
0800 ;
0200 ;
0200 ; ORG $200
0200 ; OBJ $800
0200 ;
0200 ;*** TRANSLATE ***
0200 ;
0200 ;THIS PROGRAM RECEIVES A HEX ASCII TEXT STRING
0200 ;OVER KIM'S STANDARD SERIAL PORT AND STORES
0200 ;THE STRING IN CONTIGUOUS MEMORY LOCATIONS.
0200 ;THIS SAME TEXT STRING CAN THEN BE OUTPUT TO A
0200 ;PRINTER OR OTHER RS 232 DEVICE FOR DISPLAY.
0200 ;THIS ALLOWS KIM TO RECEIVE FROM A CPU WHICH
0200 ;HAS NO BAUD RATE SELECTION, AND TO OUTPUT
0200 ;TO A PRINTER AT ANY BAUD RATE DESIRED.
0200 ;
0200 ;THIS SECTION READS MEMORY, RESETS THE PRINTER
0200 ;(CARRIAGE RETURN-LINE FEED) IF THE CHARACTER
0200 ;IS A CARRIAGE RETURN ($0D), AND OUTPUTS
0200 ;ALL OTHER CHARACTERS.
0200 ;
0200 20881E SETUP JSR INITS ;SET UP KIM STANDARD PORTS
0203 A000 INDX LDY #$00 ;INITIALIZE Y INDEX
0205 8420 STY YTMP ;AND POINTER REGISTER
0207 A420 OUT LDY YTMP ;PICK UP POINTER VALUE
0209 B102 LDA (SAL),Y ; AND INDEX INTO TEXT BUFFER.
020B C90D CMP #$0D ;IS IT A CARRIAGE RETURN?
020D F011 BEQ RESET ;IF SO, RESET THE PRINTER.
020F 20A01E JSR OUTCH ;OTHERWISE, OUTPUT CHARACTER.
0212 E620 INC YTMP ;THEN BUMP THE POINTER.
0214 D007 BNE MORE ;TEST FOR END-OF-MEMORY PAGE.
0216 18 CLC ;IF SO, PREPARE TO ADD
0217 A503 LDA SAH ;GET PAGE POINTER
0219 6901 ADC #$01 ;AND INCREMENT IT
021B 8503 STA SAH ;RESTORE PAGE POINTER
021D 4C0702 MORE JMP OUT ;AND KEEP TRUCKIN'
0220 202F1E RESET JSR CRLF ;RESET THE PRINTER
0223 A520 LDA YTMP ;GET THE POINTER
0225 38 SEC ;FORCE A CARRY
0226 6502 ADC SAL ;TO BUMPT LO BYTE OF ADDRESS
0228 8502 STA SAL ;AND RESTORE ADDRESS
022A A503 LDA SAH ;GET THE HI BYTE
022C 6900 ADC #$00 ;ADD IN POSSIBLE CARRY
022E 8503 STA SAH ;AND PUT HI BYTE BACK
0230 C914 CMP #$14 ;END OF MEMORY?
0232 D0CF BNE INDX ;IF NOT, MOVE ON OUT
0234 4C4F1C JMP START ;OTHERWISE, RETURN TO KIM
0237 00 BRK
0238 ;
0238 ;THIS SECTION RECEIVES INCOMING HEX ASCII

```

```

0238 ;CHARACTERS AND STORES THEM IN MEMORY LOCATIONS
0238 ;DEFINED IN $02 AND $03.
0238 ;
0238 205103 RCV JSR INIT ;INITIALIZE SECOND PORT
023B A000 LDY #000 ;SET Y TO ZERO
023D 8420 STY YTMP ;ALONG WITH POINTER REGISTER
023F 201F03 IN JSR GETCHP ;READ SECOND PORT
0242 C902 CMP #02 ;VALID CHARACTER?
0244 30F9 BMI IN ;IF NOT, KEEP TRYING
0246 A420 LDY YTMP ;PUT POINTER IN Y REGISTER
0248 9102 STA (SAL),Y ;AND DEPOSIT THE BYTE
024A E620 INC YTMP ;BUMP THE POINTER,
024C D0F1 BNE IN ;TEST FOR MEMORY PAGE END
024E A503 LDA SAH ;IF SO, GET PAGE POINTER
0250 18 CLC ;PREPARE FOR ADD
0251 6901 ADC #01 ;INCREMENT PAGE POINTER
0253 8503 STA SAH ;AND PUT IT BACK
0255 C914 CMP #14 ;TEST FOR MEMORY END
0257 D0E6 BNE IN ;IF NOT, GO GET MORE DATA
0259 4C4F1C JMP START ;OTHERWISE, RETURN TO KIM
025C ;
025C ;THIS SECTION CLEARS A MEMORY BUFFER BY WRITING
025C ;00 IN EACH LOCATION
025C ;
025C A000 CLEAR LDY #000 ;CLEAR INDEX POINTER
025E 98 TYA ;AND THE ACCUMULATOR
025F 9102 WRITE STA (SAL),Y ;CLEAR MEMORY BUFFER
0261 E602 INC SAL ;BUMP THE INDEX
0263 D0FA BNE WRITE ;TEST FOR MEMORY PAGE END
0265 A503 LDA SAH ;IF SO, GET PAGE POINTER
0267 18 CLC ;PREPARE TO ADD
0268 6901 ADC #01 ;ONE TO PAGE POINTER
026A 8503 STA SAH ;AND PUT IT BACK.
026C C914 CMP #14 ;END OF MEMORY?
026E D0EC BNE CLEAR ;IF NOT, CLEAR MORE MEMORY
0270 4C4F1C JMP START ;OTHERWISE, RETURN TO KIM
0273 ;
0273 ;KIMOUT
0273 ;
0273 ;THIS PROGRAM UTILIZES A SECOND RS-232 PORT ON
0273 ;KIM TO OUTPUT A CONTINUOUS DATA STREAM
0273 ;(USUALLY TEXT OR PROGRAM DATA) TO AN EPROM
0273 ;PROGRAMMER OR PRINTER.
0273 ;
0280 ORG SETUP+$80
0280 OBJ $880
0280 ;
0280 205103 STRT JSR INIT ;SET UP POINTER STORAGE
0283 A900 ZERO LDA #000 ;SET INITIAL POINTER VALUE
0285 8520 STA YTMP ;IN A SAFE LOCATION
0287 A420 GET LDY YTMP ;LOAD POINTER INTO INDEX
0289 B102 LDA (SAL),Y ;GET A BYTE OF DATA
028B 200003 JSR PRBTBYT ;AND OUTPUT IT
028E E620 INC YTMP ;BUMP THE POINTER
0290 18 CLC ;PREPARE TO ADD
0291 A502 LDA SAL ;LO BYTE START ADDRESS
0293 6520 ADC YTMP ;TO THE POINTER
0295 8502 STA SAL ;FOR NEW START ADDRESS
0297 A503 LDA SAH ;GET HI BYTE
0299 6900 ADC #000 ;ADD IN POSSIBLE CARRY
029B 8503 STA SAH ;AND RESTORE HI BYTE
029D A502 LDA SAL ;GET LO BYTE
029F C504 CMP EAL ;AND COMPARE TO END LO BYTE
02A1 9008 BCC NEXT ;IF NOT, GO MOVE MORE DATA
02A3 A503 LDA SAH ;OTHERWISE, CHECK HI BYTE
02A5 C505 CMP EAH ;AGAINST END HI BYTE
02A7 F005 BEQ OUTK ;IF EQUAL,
02A9 1003 BPL OUTK ;OR BIGGER, STOP
02AB 4C8002 NEXT JMP STRT ;OTHERWISE DO MORE
02AE 4C4F1C OUTK JMP START ;DONE, EXIT TO KIM
02B1 00 BRK
02B2 ;
02B2 ;SERIAL I/O
02B2 ;
02B2 ;THIS PROGRAM IS A SLIGHTLY MODIFIED COPY OF
02B2 ;PORTIONS OF THE KIM-1 MONITOR FUNCTIONS;
02B2 ;WITH THE EXCEPTION OF INIT, THE LABELS HAVE BEEN
02B2 ;PRESERVED. THE MODIFICATIONS ACCOMODATE THE USE
02B2 ;OF A SEPARATE RS-232 SERIAL PORT, IMPLEMENTED IN
02B2 ;CONJUNCTION WITH THE APPLICATIONS I/O PORT OF KIM.

```

(continued)

TRANSLATE has made it possible for me to "translate" the Radio Shack computer output from 600 baud to 300 baud for a borrowed printer. Both TRANSLATE and KIMOUT will handle any type of computer data, because they deal with exact memory images of the data. I can even generate text such as this on KIM and bring it to this word processor for final editing, formatting and printing on a daisy-wheel printer!

### Add A Second RS-232 Port

One problem with the KIM port is that it has a hardware echo built in which is inappropriate in some applications. Also, since the software is all in ROM, it is impossible to modify. These problems may be simply solved by creating a second RS-232 port.

The 20 mA loop port on the KIM-1 can be converted to an RS-232 port by adding some transistors to shift the input/output levels to match RS-232 specifications. Figure 1 details the voltage levels which make up the RS-232 specification. Some RS-232 peripheral devices will work with a smaller voltage swing or other deviations from the spec, but to be sure, build the simple circuits shown in figures 2 and 3.

Figure 2 shows the output circuit. This port will swing to full RS-232 levels and should meet all drive requirements for almost any imaginable peripheral device. Q1 is the output switch, while Q2 is a non-inverting level converter which allows the full  $\pm 12v$  RS-232 swing from Q1, without requiring an open-collector stage on the port line or the UART.

The problem of matching RS-232 input levels to another port pin is solved by the circuit shown in figure 3. A single transistor with input protection can accept  $\pm 12v$  swings and convert them to a level KIM is happy with. R1, D1 and D2 form a protective network for the transistor base. Also R1 with R2 provides adequate input impedance for the incoming signal. R3 is a pull-up to hold the port's input line at a spacing level (logic 0) when there is no input signal.

The KIM provides the basic software UART routines. The routines (PRBTBYT, GETCH, OUTSP, OUTCH, and CRLF), use bit PB0 of the KIM Control Port to drive the output, and incoming data is read on PA7. We can do about the same thing, using PB0 of the Application Port for an output and PB7 for input. With those pin

**Make Your  
Reference Library  
Complete With  
The Best of MICRO**

**Volume 1**—Contains 46 articles from October/November 1977 through August/September 1978: Apple articles (16), AIM 65 (1), KIM-1 (10), PET (9), OSI (1), SYM-1 (1), and General (8). 176 pages plus 5 tear-out reference cards (Apple, KIM, PET, and 6502), 8½ x 11 inches, paperbound. \$6.00

**Volume 2**—Contains 55 articles from October/November 1978 through May 1979: Apple articles (18), AIM 65 (3), KIM-1 (6), PET (12), OSI (3), SYM-1 (4), and General (9). 224 pages, 8½ x 11 inches, paperbound. \$8.00

**Volume 3**—Contains 88 articles from June 1979 through May 1980: Apple articles (24), AIM 65 (7), KIM-1 (9), PET (15), OSI (14), SYM-1 (11), and General (8). 320 pages, 8½ x 11 inches, paperbound. \$10.00

Ask for **The Best of MICRO** at your computer store. Or, to order with VISA or Mastercard

**Call TOLL-FREE  
800-227-1617**

**Extension 564**

**In California 800-772-3545  
Extension 564**



On orders received by August 31, 1981, we pay all surface shipping charges.

**MICRO™**

P.O. Box 6502  
Chelmsford, MA 01824

```

02B2                               ;IN ADDITION, THE Y REGISTER OF THE 6502 HAS BEEN
02B2                               ;SAVED WHERE APPROPRIATE.
02B2                               ;
0300                               ORG $300
0300                               OBJ $900
0300                               ;
0300 85FC   PRTBYT STA TEMP           ;SAVE ACCUMULATOR
0302 4A     LSR                       ;SHIFT OFF LOW NIBBLE
0303 4A     LSR                       ;TO ACCESS
0304 4A     LSR                       ;THE HIGH ORDER
0305 4A     LSR                       ;NIBBLE FOR OUTPUT
0306 2011.03 JSR HEXTA                ;CONVERT TO HEX AND OUTPUT
0309 A5FC   LDA TEMP                   ;GET OTHER HALF
030B 2011.03 JSR HEXTA                ;CONVERT TO HEX AND OUTPUT
030E A5FC   LDA TEMP                   ;RESTORE BYTE IN A
0310 60     RTS                       ;AND RETURN
0311 290F   HEXTA AND #$0F             ;MASK OFF HI NIBBLE
0313 C90A   CMP #$0A                   ;TEST FOR ALPHA
0315 18     CLC                       ;PREPARE TO ADD
0316 3002   BMI HEXTA1                 ;NOT ALPHA
0318 6907   ADC #$07                   ;ALPHA, ADD MORE
031A 6930   HEXTA1 ADC #$30            ;FIX NON-ALPHA
031C 20A01E JSR OUTCH                  ;OUTPUT IT
031F 86FD   GETCHP STX TMPX            ;SAVE X REG
0321 84EE   STY TMPY                   ;AND Y REG
0323 A208   LDX #$08                   ;COUNT OF 8 BITS
0325 A901   LDA #$01                   ;MASK IN ACCUMULATOR
0327 2C0217 GET1 BIT PBD               ;TEST FOR START BIT
032A EA     NOP
032B EA     NOP
032C 30F9   BMI GET1                   ;KEEP TRYING
032E 209303 JSR DELAY                  ;DELAY ONE BIT
0331 20AA03 GET5 JSR DEHALF            ;DELAY 1/2 BIT
0334 AD0217 GET2 LDA PBD                ;GET 8 BITS
0337 2980   AND #$80                   ;MASK OFF LOW ORDER BITS
0339 46FE   LSR CHAR                   ;SHIFT CHARACTER RIGHT
033B 05FE   ORA CHAR                   ;OR IN RECEIVED BIT
033D 85FE   STA CHAR                   ;AND RESTORE CHAR
033F 209303 JSR DELAY                  ;DELAY ONE BIT TIME
0342 CA     DEX                       ;AND COUNT BIT
0343 D0EF   BNE GET2                   ;REPEAT UNTIL 8 BITS IN
0345 20AA03 JSR DEHALF                 ;THEN, DELAY 1/2 BIT
0348 A4EE   LDY TMPY                   ;RETRIEVE Y
034A A6FD   LDX TMPX                   ;AND X
034C A5FE   LDA CHAR                   ;GET THE CHARACTER
034E 2A     ROL                       ;AND SHIFT OFF THE
034F 4A     LSR                       ;PARITY BIT, THEN
0350 60     RTS                       ;RETURN
0351 A201   INIT LDX #$01              ;TURN ON ONE BIT
0353 8E0317 STX PBDD                   ;IN THE USER PORT
0356 D8     CLD                       ;SET UP BINARY MODE
0357 78     SEI                       ;INHIBIT INTERRUPTS
0358 60     RTS                       ;AND RETURN
0359 A920   OUTSP LDA #$20              ;ASCII SPACE
035B 85FE   OUTCHA STA CHAR            ;SAVE THE CHARACTER
035D 84EE   STY TMPY                   ;THE Y REG,
035F 86FD   STX TMPX                   ;AND X REG
0361 209303 JSR DELAY                  ;ONE BIT DELAY
0364 AD0217 LDA PBD                    ;READ THE PORT
0367 29FE   AND #$FE                   ;SET THE START BIT
0369 8D0217 STA PBD                    ;OUTPUT THE BIT
036C 209303 JSR DELAY                  ;WAIT ONE BIT TIME
036F A208   LDX #$08                   ;EIGHT BIT COUNT
0371 AD0217 OUT1 LDA PBD               ;GET THE OUTPUT BIT
0374 29FE   AND #$FE                   ;MASK START BIT
0376 46FE   LSR CHAR                   ;SHIFT BIT OUT OF CHAR
0378 6900   ADC #$00                   ;ADD IN CARRY BIT
037A 8D0217 STA PBD                    ;AND OUTPUT IT
037D 209303 JSR DELAY                  ;WAIT ONE BIT TIME
0380 CA     DEX                       ;COUNT THE BIT
0381 D0EE   BNE OUT1                   ;NOT DONE, GO BACK
0383 AD0217 LDA PBD                    ;LOAD THE OUTPUT BIT
0386 0901   ORA #$01                   ;SET IT HIGH
0388 8D0217 STA PBD                    ;TO OUTPUT STOP BIT
038B 209303 JSR DELAY                  ;AND WAIT AGAIN
038E A6FD   LDX TMPX                   ;REMEMBER X
0390 A4EE   LDY TMPY                   ;AND Y
0392 60     RTS                       ;AND RETURN
0393 ADF317 DELAY LDA CMTH30           ;GET HI BYTE DELAY COUNT

```



0396 8DF417		STA TIMH		;STUFF IT IN THE TIMER
0399 ADF217		LDA CNTL30		;AND GET THE LO BYTE
039C 38	DE2	SEC		;SET CARRY FOR SUBTRACT
039D E901	DE4	SBC #S01		;DECREMENT LO BYTE
039F B003		BCS DE3		;BRANCH IF NO BORROW
03A1 CEF417		DEC TIMH		;DECREMENT TIMER VALUE
03A4 ACF417	DE3	LDY TIMH		;AND STUFF IT IN Y
03A7 10F3		BPL DE2		;RETURN IF NOT NEGATIVE
03A9 60		RTS		;OTHERWISE, RETURN
03AA ADF317	DEHALF	LDA CNTH30		;DELAY 1/2 BIT TIME
03AD 8DF417		STA TIMH		;BY DOING A DOUBLE
03B0 ADF217		LDA CNTL30		;RIGHT SHIFT OF
03B3 4A		LSR		;THE COUNT VALUES
03B4 4EF417		LSR TIMH		;AND THEN
03B7 90E3		BCC DE2		;COUNTING THEM DOWN
03B9 0980		ORA #S80		;FORCE A NEGATIVE
03BB B0E0		BCS DE4		;TO FORCE A BRANCH.
03BD 00		BRK		;BLOCK SEPARATOR
03BE 201F03	GETBYT	JSR GETCHP		;GO GET A CHARACTER
03C1 20AC1F		JSR PACK		;MAKE IT A NIBBLE
03C4 201F03		JSR GETCHP		;GET ANOTHER CHARACTER
03C7 20AC1F		JSR PACK		;STUFF IT WITH THE OTHER
03CA A5F8		LDA INL		;GET THE WHOLE THING
03CC 60		RTS		;AND RETURN
03CD A207	CRLFD	LDX #S07		;SET INDEX TO SEVEN,
03CF BDD51F	PRTST	LDA TOP,X		;OUTPUT CR, LF AND
03D2 20A01E		JSR OUTCH		;NULLS
03D5 CA		DEX		;COUNT THE CHARACTERS
03D6 10F7		BPL PRTST		;LOOP UNTIL DONE
03D8 60		RTS		;AND RETURN
03D9 00		BRK		

assignments and a program based on the KIM routines, we can minimize the effort needed to build and program a new serial port. The program in listing 1 is basically a copy of the KIM software UART. Note that your choice of input pin will allow you to use these same routines to cause the input from the terminal or a keyboard to generate an interrupt if you so choose. This may be implemented following instructions in the *KIM User Manual* (Appendix H) for using PB7 to cause an interrupt.

Any routine which calls this serial I/O program should first call INIT - ([SR INIT]), the normal KIM-1 power-up initialization routine which configures the B Application Port as output on PBO. If you use the remaining five pins of Port B for other purposes, you must override the pin assignments or change the value loaded in X by the statement at 0251<sub>16</sub> to accommodate the needs of your other hardware. Once the new port has been initialized, you can use any of the routines in this program in exactly the same manner as you have previously used the similar routines from the KIM-1 monitor.

**MICRO**

## 32 K BYTE MEMORY RELIABLE AND COST EFFECTIVE RAM FOR 6502 & 6800 BASED MICROCOMPUTERS

**AIM 65-\*KIM\*SYM  
PET\*S44-BUS**

- \* PLUG COMPATIBLE WITH THE AIM-65/SYM EXPANSION CONNECTOR BY USING A RIGHT ANGLE CONNECTOR (SUPPLIED) MOUNTED ON THE BACK OF THE MEMORY BOARD.
- \* MEMORY BOARD EDGE CONNECTOR PLUGS INTO THE 6800 S 44 BUS.
- \* CONNECTS TO PET OR KIM USING AN ADAPTOR CABLE.
- \* RELIABLE—DYNAMIC RAM WITH ON BOARD INVISIBLE REFRESH—LOOKS LIKE STATIC MEMORY BUT AT LOWER COST AND A FRACTION OF THE POWER REQUIRED FOR STATIC BOARDS.
- \* USES +5V ONLY, SUPPLIED FROM HOST COMPUTER.
- \* FULL DOCUMENTATION, ASSEMBLED AND TESTED BOARDS ARE GUARANTEED FOR ONE YEAR AND PURCHASE PRICE IS FULLY REFUNDABLE IF BOARD IS RETURNED UNDAMAGED WITHIN 14 DAYS.

ASSEMBLED WITH 32K RAM	.....	\$349.00
& WITH 16K RAM	.....	\$329.00
TESTED WITHOUT RAM CHIPS	.....	\$309.00
HARD TO GET PARTS (NO RAM CHIPS)	.....	\$ 99.00
WITH BOARD AND MANUAL	.....	\$ 49.00
BARE BOARD & MANUAL	.....	\$ 49.00

PET INTERFACING ADAPTERS THE 32K RAM BOARD TO THE PET SYSTEM USING THE INTERFACING CABLE BOARD STANDARD BOARD SUPPLY MODIFICATION KIT AND COMPLETE INSTRUCTIONS \$49.00

U.S. PRICES ONLY

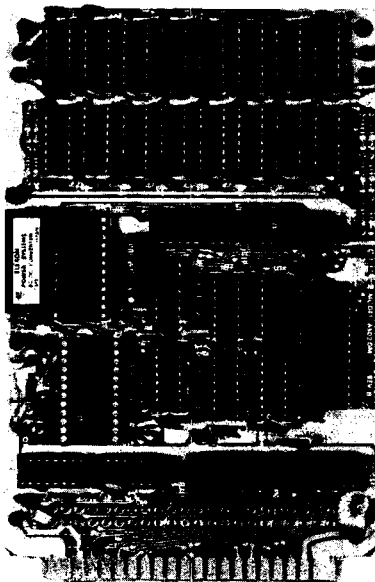

## 16K MEMORY EXPANSION KIT ONLY \$29

FOR APPLE, TRS-80 KEYBOARD, EXIDY, AND ALL OTHER 16K DYNAMIC SYSTEMS USING MK4116-3 OR EQUIVALENT DEVICES.

- \* 200 NSEC ACCESS, 375 NSEC CYCLE
- \* BURNED-IN AND FULLY TESTED
- \* 1 YR. PARTS REPLACEMENT GUARANTEE
- \* QTY. DISCOUNTS AVAILABLE

**ALL ASSEMBLED BOARDS AND  
MEMORY CHIPS CARRY A FULL ONE  
YEAR REPLACEMENT WARRANTY**

**BETA**  
COMPUTERS

1230 W. COLLINS AVE.  
ORANGE, CA 92668  
(714) 633-7280

Each product purchased from Beta Computers, Inc. is warranted for one year against defects in materials and workmanship. This warranty is void if the product is used for any purpose other than that intended by the manufacturer. Beta Computers, Inc. is not responsible for any damage to data or equipment caused by the use of its products.



**Asteron** - The definitive hi-res implementation of the Asteroids arcade game. Features: Ship movement, hyperspace, alien saucers, sound effects, graphic routines allowing up to 25 objects to be displayed with real time response. Played from paddles or keyboard. **\$27.50**



**Star Avenger** - High speed guerrilla warfare in space pitting you against your Apple. Featuring a new universe each game and varying skill levels. Universe consists of 16 hi-res screens with instantaneous crossover. **\$27.50**



**Shooting Gallery** - A real time simulation of a midway arcade. Features: row targets, pop targets, different skill levels, and bonus time. May be played using either game paddles or joy sticks. **\$22.50**



**NORAD**: A high-speed, real-time simulation of a nuclear conflict between a "non-imperialist" aggressor nation and his controlled "sphere-of-influence" and the United States of America. As the American player, you must protect your cities and A.B.M. sites and survive their continuous onslaught. **\$27.50**

**MultiBoot™ Upgrade**

Have you not wished that your Basic software would work in both DOS 3.2 and 3.3? Tired of spending hours "Muffin"ing your old programmes? Well, your problems are solved. This lets you take a 3.2 diskette and upgrade it so that it can be booted on a 3.3 (or 3.2) machine while maintaining a 3.2 environment. This means your 3.2 programmes never need to be modified for 3.3 machine use. **\$50.00**

All Western MicroData game software is written in assembly language for maximum speed. All programmes require 48K and DISK DRIVE and will work on standard Apple II, Apple II plus, and Pascal systems, with either DOS 3.2 or DOS 3.3.

**Western MicroData Enterprises Ltd.**

P.O. Box G33, Postal Station G  
Calgary, Alberta  
Canada T3A 2G1  
1-403-247-1621

Prices subject to change without notice.

For U.S. and foreign orders, prices are in U.S. dollars. For Canadian orders, prices are in Canadian dollars. Send Certified Cheque, Postal Money Order, or International Money Order only. Allow 3-4 weeks for cheque to clear. If not certified and allow up to 4 weeks for delivery.

Dealer and Computer Club enquiries invited.

Apple is a registered trademark of Apple Computer Inc.  
Disk II is a registered trademark of Apple Computer Inc.

**THE PERFORMANCE SLICE**  
**SBCS**

**GENERAL LEDGER**  
This package features 31 character account names, 6 digit account numbers, and 10 levels of subtotals for more detailed income statements and balance sheets. Up to 2000 entries can be processed per session.

**ACCOUNTS RECEIVABLE**  
This package allows entry of invoices at any time, credit and debit memos, full or partial invoice payment, invoice aging, and printing of statements. Amounts billed this year and year previous, total payments, and progress billing information are maintained.

**ACCOUNTS PAYABLE COMING SOON!**

- ★ Complete your accounting system with the soon to be released A/P package, featuring automatic application of credit and debit memos, open or closed item listing, full invoice aging, and multiple reports that provide a complete transaction review.
- ★ Your bookkeeping doesn't have to be a bulky, complicated process. The SBCS Accounting System is designed for flexibility and high performance with a cost effectiveness sure to benefit your business!

**YOU NEED EXPERIENCE WORKING FOR YOU**  
★ Packages available at your local Apple dealer.

**SMALL BUSINESS COMPUTER SYSTEMS**  
4140 Greenwood, Lincoln, NE 68504 (402) 467-1878

**KIM SYM TIM**

**END FRUSTRATION!**

**FROM CASSETTE FAILURES  
PERRY PERIPHERALS HAS  
THE HDE SOLUTION  
OMNIDISK SYSTEMS (5" and 8")  
ACCLAIMED HDE SOFTWARE**

- Assembler, Dynamic Debugging Tool, Text Output Processor, Comprehensive Memory Test
- HDE DISK BASIC NOW AVAILABLE  
PERRY PERIPHERALS S-100 PACKAGE

**Adds Omnidisk (5") to  
Your KIM/S-100 System**

- Construction Manual—No Parts
- FODS & TED Diskette
- \$20. +\$2. postage & handling. (NY residents add 7% tax) (specify for 1 or 2 drive system)

**Place your order with:  
PERRY PERIPHERALS  
P.O. Box 924  
Miller Place, N.Y. 11764  
(516) 744-6462**

**Your Full-Line HDE Distributor/Exporter**

# Amper Search for the Apple

High speed machine language search routine finds character strings in BASIC arrays.

Alan G. Hill  
12092 Deerhorn Dr.  
Cincinnati, Ohio 45240

The July, 1979 issue of MICRO included my article entitled "Amper-Sort" which described and utilized the "&" command of Applesoft BASIC to pass parameters to a machine language sort routine. Now comes Amper-Search, a program which, besides being a useful addition to your Amper-library, demonstrates how parameters can be passed bi-directionally.

Amper-Search is a high-speed character search routine that will find and return the subscripts of all occurrences of a specified character string in a target string array. A search of a 2000 element array will take less than 1 second compared to about 90 seconds for an equivalent BASIC routine. Parameters are used to name the target string array, define the character string, define the bounds of the search, and name the variables to receive the subscripts and number of matches. An added bonus in the Amper-Search code is another routine called &DEALLOC. Its function is to give your BASIC program the ability to de-allocate a string array or integer array when it's no longer needed. &DEALLOC can be used with any Applesoft BASIC program.

Let's look at the parameters and how they are passed between the Applesoft program and Amper-Search. The general form is:

```
&S[SEARCH](NA$,L,H,ST$,PL,PH,  
I%,N%)
```

## Listing 1

```
1 HIMEM: 9 * 4096 + 2 * 256
2 D$ = CHR$(4): PRINT D$"NOMONC,I,0"
3 PRINT D$"BLOAD B.AMPER-SEARCH(48K)
4 POKE 1013,76: POKE 1014,0: POKE 1015,146: REM 3F5: JMP $9200
5 DIM NA$(10),IX(10)
20 NA$(0) = "APPLE CORE"
21 NA$(1) = "CRAB APPLE"
22 NA$(2) = "APPLE&ORANGE"
23 NA$(3) = "APPLE/ORANGE"
24 LIST 5,23
100 REM FIND ALL OCCURRENCES OF 'APPLE'
101 NZ = 0:ST$ = "APPLE"
102 & SEARCH(NA$,0,10,ST$,1,255,IX,NZ)
103 LIST 100,102: GOSUB 2000: GOSUB 3000
200 REM FIND 'APPLE' IN NA$(0) -> NA$(1) COLUMNS 1 -> 5
201 NZ = 0:ST$ = "APPLE"
202 & SEARCH(NA$,0,1,ST$,1,5,IX,NZ)
203 LIST 200,202: GOSUB 2000: GOSUB 3000
300 REM FIND 'APPLE ORANGE'
301 NZ = 0:ST$ = "APPLE" + CHR$(14) + "ORANGE"
302 & SEARCH(NA$,0,3,ST$,1,255,IX,NZ)
303 LIST 300,302: GOSUB 2000: GOSUB 3000
400 REM FIND 1ST 'ORANGE'
401 NZ = -1:ST$ = "ORANGE"
402 & SEARCH(NA$,0,3,ST$,1,255,IX,NZ)
403 LIST 400,402: GOSUB 2000: GOSUB 3000
490 ST$ = "CRAB"
492 REM DYNAMICALLY ALLOCATE/DEALLOCATE MZ
495 FOR J = 1 TO 2
500 NZ = 0:KX = 0
501 & SEARCH(NA$,0,3,ST$,1,255,KX,NZ)
502 DIM MZ(NZ):NZ = 0
503 & SEARCH(NA$,0,3,ST$,1,255,MZ,NZ)
504 LIST 490,530: GOSUB 2100: GOSUB 3000
510 & DEALLOC(MZ)
520 ST$ = "APPLE"
530 NEXT J
600 REM FIND 'E' IN COLUMN 10
601 NZ = 0:ST$ = "E"
602 & SEARCH(NA$,0,3,ST$,10,10,IX,NZ)
603 LIST 600,602: GOSUB 2000
700 END
2000 IF NZ = 0 THEN PRINT "NONE FOUND": RETURN
2005 FOR I = 0 TO NZ - 1
2010 HTAB 4: PRINT NA$(IX(I))
2020 NEXT I
2030 PRINT: RETURN
2100 IF NZ = 0 THEN PRINT "NONE FOUND": RETURN
2105 PRINT
2110 FOR I = 0 TO NZ - 1
2120 HTAB 4: PRINT NA$(MZ(I))
2130 NEXT I
2140 PRINT: RETURN
3000 FOR I = 1 TO 5000: NEXT I: RETURN
```

(continued)

where:

[ ] bracket optional characters. The "&S" are required characters.

NA\$ is the variable name of the single-dimensional string array to be searched.

L is a variable, constant, or expression specifying the value of the subscript of NA\$ where the search is to begin, i.e. NA\${L}.

H is a variable, constant, or expression specifying the value of the subscript of NA\$ where the search is to end, i.e. NA\${H}.

ST\$ is the variable name of the simple string containing the "search" characters. A special case exists if the string contains a Control N character. See note 4.

PL is a variable, constant, or expression specifying the character position in the NA\${I} string where the search is to begin.

PH is a variable, constant, or expression specifying the character position in the NA\${I} string where the search is to end. PL and PH are equivalent to the MID\$ statement of the form: MID\$(NA\${I}, PL, PH - PL + 1).

I% is the name of the single-dimensional integer array into which the subscripts of NA\$ will be placed when a "match" is found. The first occurrence will be placed in I%(0). A special case exists if I% is a simple variable rather than an array variable. See note 5.

N% is the name of the simple integer variable into which the number of "matches" will be placed by Amper-Search. N% should be set to zero each time before Amper-Search is invoked. Setting N% < 0 is a special case. See note 6.

After Amper-Search is invoked, the elements of NA\$ which match the ST\$ string may be listed with the statement: FOR I=0 TO N% - 1: PRINT NA\$(I%(I)): NEXT I.

## Notes

1. A match is defined as the consecutive occurrence of all characters in ST\$ with those in NA\${L} through NA\${H} and within the PL and PH character positions of NA\${I}. A Control N character in the ST\$ string is a wild card. It

Run from Listing 1

```
5 DIM NA$(10),IX(10)
20 NA$(0) = "APPLE CORE"
21 NA$(1) = "CRAB APPLE"
22 NA$(2) = "APPLE&ORANGE"
23 NA$(3) = "APPLE/ORANGE"
```

```
100 REM FIND ALL OCCURRENCES OF 'APPLE'
101 NZ = 0:ST$ = "APPLE"
102 & SEARCH(NA$,0,10,ST$,1,255,IX,NZ)
```

```
APPLE CORE
CRAB APPLE
APPLE&ORANGE
APPLE/ORANGE
```

```
200 REM FIND 'APPLE' IN NA$(0) -> NA$(1) COLUMNS 1 -> 5
201 NZ = 0:ST$ = "APPLE"
202 & SEARCH(NA$,0,1,ST$,1,5,IX,NZ)
```

```
APPLE CORE
```

```
300 REM FIND 'APPLE ORANGE'
301 NZ = 0:ST$ = "APPLE" + CHR$(14) + "ORANGE"
302 & SEARCH(NA$,0,3,ST$,1,255,IX,NZ)
```

```
APPLE&ORANGE
APPLE/ORANGE
```

```
400 REM FIND 1ST 'ORANGE'
401 NZ = - 1:ST$ = "ORANGE"
402 & SEARCH(NA$,0,3,ST$,1,255,IX,NZ)
```

```
APPLE&ORANGE
```

```
490 ST$ = "CRAB"
492 REM DYNAMICALLY ALLOCATE/DEALLOCATE MZ
495 FOR J = 1 TO 2
500 NZ = 0:KZ = 0
501 & SEARCH(NA$,0,3,ST$,1,255,KZ,NZ)
502 DIM MZ(NZ):NZ = 0
503 & SEARCH(NA$,0,3,ST$,1,255,MZ,NZ)
504 LIST 490,530: GOSUB 2100: GOSUB 3000
510 & DEALLOC(MZ)
520 ST$ = "APPLE"
530 NEXT J
```

```
CRAB APPLE
```

```
490 ST$ = "CRAB"
492 REM DYNAMICALLY ALLOCATE/DEALLOCATE MZ
495 FOR J = 1 TO 2
500 NZ = 0:KZ = 0
501 & SEARCH(NA$,0,3,ST$,1,255,KZ,NZ)
502 DIM MZ(NZ):NZ = 0
503 & SEARCH(NA$,0,3,ST$,1,255,MZ,NZ)
504 LIST 490,530: GOSUB 2100: GOSUB 3000
510 & DEALLOC(MZ)
520 ST$ = "APPLE"
530 NEXT J
```

```
APPLE CORE
CRAB APPLE
APPLE&ORANGE
APPLE/ORANGE
```

```
600 REM FIND 'E' IN COLUMN 10
601 NZ = 0:ST$ = "E"
602 & SEARCH(NA$,0,3,ST$,10,10,IX,NZ)
```

```
APPLE CORE
CRAB APPLE
```

## Listing 2

```

0 REM AMPER-SEARCH DEMO
1 REM BY ALAN G. HILL
1000 GOSUB 10000
1010 POKE 32,20: POKE 33,19: HOME : VTAB 5: PRINT "DO YOU WANT TO": PRINT
"SPECIFY SEARCH": PRINT "LIMITS(Y/N)? "; GET A$: PRINT
1020 IF A$ < > "Y" THEN 1080
1030 VTAB 10: CALL - 868: INPUT "LOWER SUBSCRIPT:":L: IF L < 0 OR L > 21
THEN PRINT B$: GOTO 1030
1040 VTAB 12: CALL - 868: INPUT "UPPER SUBSCRIPT:":H: IF H < 0 OR H > 21
OR H < L THEN PRINT B$: GOTO 1040
1050 VTAB 14: CALL - 868: INPUT "LOWER COLUMN:":PL: IF PL < 1 OR PL > 25
5 THEN PRINT B$: GOTO 1050
1060 VTAB 16: CALL - 868: INPUT "UPPER COLUMN:":PH: IF PH < 1 OR PH > 25
5 OR PH < PL THEN PRINT B$: GOTO 1060
1065 VTAB 18: CALL - 868: INPUT "FIRST/ALL?": GET A$: PRINT : IF A$ = "
F" THEN FX = - 1
1070 GOTO 1120
1080 L = 0: REM START AT NA$(0)
1090 H = 1: REM SEARCH ALL
1100 PL = 1: REM START WITH 1ST COLUMN
1110 PH = 255: REM MAXIMUM COLUMNS
1115 FX = 0: REM FIND ALL
1120 POKE 32,0: POKE 33,39: VTAB 23: CALL - 868
1130 INVERSE : PRINT "STRING:": NORMAL : INPUT " "; ST$
1140 IF LEN (ST$) = 0 THEN END
1150 NZ = FX: REM INIT COUNTER
1160 REM INVOKE 'AMPER-SEARCH'
1170 & SEARCH(NA$,L,H,ST$,PL,PH,IZ,NX)
1180 REM LIST FOUND STRINGS
1190 POKE 32,20: POKE 33,19: HOME
1200 IF NZ < = 0 THEN PRINT "NONE FOUND": GOTO 1120
1210 FOR I = 0 TO NZ - 1
1220 VTAB IZ(I) + 1: PRINT NA$(IZ(I))
1230 NEXT I
1240 GOTO 1120
10000 REM HOUSEKEEPING
10010 HIMEM: 9 * 4096 + 2 * 256
10015 POKE 235,0
10020 D$ = CHR$(4)
10030 B$ = CHR$(7)
10040 PRINT D$"NOMONC,1,0"
10050 POKE 1013,76: POKE 1014,0: POKE 1015,146: REM SETUP 'S' VECTOR AT
$3F5 TO JMP $9200
10060 TEXT : HOME : VTAB 10: HTAB 12: PRINT "AMPER-SEARCH DEMO"
10070 HTAB 19: PRINT "BY": HTAB 14: PRINT "ALAN G. HILL"
10080 PRINT D$"BLOAD B,AMPER-SEARCH(48K)"
10090 FOR I = 1 TO 1000: NEXT I
10100 DIM NA$(22), IZ(22)
10110 I = 0
10120 REM INITIALIZE STRING ARRAY
10130 READ NA$(I)
10140 IF NA$(I) = "END" THEN 10160
10150 I = I + 1: GOTO 10130
10160 I = I - 1
10170 HOME
10180 FOR K = 0 TO I
10190 PRINT K; TAB(4); NA$(K)
10200 NEXT K
10210 RETURN
11000 REM SAMPLE STRINGS
11010 REM NOTE: THIS DEMO IS SCREEN ORIENTED. DON'T PUT MORE THAN 22 ITEM
S IN THE DATA STATEMENT LIST.

11020 DATA APPLE II,APPLE SIDER,APPLE CIDER,APFLEVENTION,APPLE PI,APPLES
AUCE,APPLE TREE,APFLE ORCHARD
11030 DATA APPLE II PLUS,APPLES & ORANGES,APPLE BLOSSOM,CANDIED APPLES,AP
PLE/ORANGE,APPLESOFT,APPLEODIAN,APFLEVISION
11040 DATA APPLE STEM,APPLE CORE,APPLE-A-DAY,APPLE PIE,APPLE PEEL,APPLE-
OF-MY-EYE

```

will match any character in its corresponding NA\$(I) position.

2. Any valid variable name may be used as a parameter.

3.  $0 \leq L \leq H \leq$  maximum number of elements in NA\$. Elements of NA\$ can be null strings.

4.  $1 \leq PL \leq PH \leq 255$ . A  $PH > LEN(NA$(I))$  is allowed and will ensure that the entire NA\$(I) string is searched.

5. I% must be dimensioned large enough to hold all matches; i.e. DIM I%(N%). Since you don't know the number of matches before Amper-Search is invoked, you have two alternatives. I% can be dimensioned the same size as NA\$, thus assuring enough space to accommodate a complete match. This may waste memory or require more memory than is available. A second alternative is to first define I% as a *simple* variable before in-

voking Amper-Search. In this special case, Amper-Search will return the number of matches *only*. Your program can then DIM I%(N%), set N%=0, and re-invoke Amper-Search to return the subscripts. Its speed makes this option practical even for large arrays and will conserve memory by not allocating unused I% elements.

6. N% should be  $\leq 0$  prior to invoking Amper-Search. Set N%=0 if you want all matches. If N%=0 upon return, there were no matches. Set N%=-1 if you only want the *first* occurrence of a match. In this special case, N% will be -1 if there were no matches, or +1 if a match were found. The subscript of the matching NA\$ element will be found in I%(0).

Note 5 described a method for allocating the minimum size for I% that is large enough to hold the maximum number of matches. You could ask, "What if I use &SEARCH iteratively with a different ST\$ string each time that has more matches than I% can hold? Won't that cause a BAD SUBSCRIPT ERROR?" Yes it will. Ideally, one would like to de-allocate I% and re-DIMension it at the new minimum size. The CLEAR command won't do the job because it will clear all variables. Now you should see the utility of yet another Amper-library routine called &DEALLOC which performs the needed function. The general form is:

&D[EALLOC](A,B,N)

where A,B,N are the named variables of the integer and string arrays to be de-allocated.

[ ] bracket optional characters. "&D" are required.

For example: &D(I%) will de-allocate the I% integer array, &D(XY\$,K%) will de-allocate the XY\$ string array and the K% integer array.

In order to complete the de-allocation process, your program must follow the &D(XY\$) statement with an X=FRE(0) housekeeping statement to regain the memory from character strings referred to only by the de-allocated string array. &DEALLOC cannot be used to increase the size of an array while preserving the current contents of the array.

Now let's look at some simple examples created by running the program in listing 1.

Listing 2 is a general BASIC demo with which you can experiment to learn how Amper-Search can be used.

Some of the routines in Amper-Search can be adapted for use in other Amper-library machine language routines. In addition to the Apple routines described in the July Amper-Sort article, the following routines may also be useful:

**GNAME** retrieves the string or integer variable name from the "&" parameter list and places it in the NAME buffer in your machine language program. The A-Reg is returned with a "\$" or "%" character.

**INTE** converts the positive ASCII variable name in NAME to Applesoft's 2-character

negative ASCII naming convention for integer variable names. If the A-Reg does not contain a "%" upon entry, the carry flag will be set upon return.

**STRING** performs the same function for string variable names as INTE does for integer variables. The A-Reg must contain a "\$" upon entry.

**FARRAY** will search variable space for the array variable name contained in the NAME buffer. If found, its address will be returned in the X and Y Regs. If not found, the carry flag will be set.

**FSIMPL** performs the same function for simple variables as FARRAY does for array variables.

&DEALLOC also uses several of the

above routines. Similar routines reside somewhere in the Applesoft interpreter, and if they are known, these routines can be adapted.

Amper-Search was assembled using the Microproducts 6 Character Label Editor/Assembler. The Link command makes it very easy to put the above routines in your subroutine library for recall, when needed, by the assembler. Anyone desiring a tape cassette containing the Demo program, the object code assembled at \$5200, a copy at \$9200 (all for Applesoft ROM), and the source code in Microproducts 6 Character Label Editor/Assembler format may send \$6.00 to me at the above address.

My thanks to Bob Kovacs who challenged me to write Amper-Search.

**MICRO**

**Listing 3**

```

*****
; *****
; AMPER-SEARCH *
; AND DEALLOCATE *
; BY *
; ALAN G. HILL *
; *
; COMMERCIAL *
; RIGHTS *
; RESERVED *
; *
*****
; FEBRUARY *
; 1980 *
; *
*****
; DEFINE ADDRESSES *
;
NAPTR EQU 00D0
SAFTR EQU 00D2
JAFTR EQU 00D4
NPT EQU 00D6
L EQU 00D8
H EQU 00DA
PL EQU 00DC
PH EQU 00DD
TEM6X EQU 00DE
NAPTH EQU 00E0
CNAFTR EQU 00E2
CSAPTR EQU 00E4
SAVEY EQU 00E6
PS EQU 00E7
LENNA EQU 00E8
LENSA EQU 00E9
SWITCH EQU 00EA
SIZE EQU 00EB
OFFSET EQU 00D2
A1 EQU 00D4
Z50 EQU 0050
CHRGOT EQU 00B7
CHRGOT EQU 00B1
COUT EQU FBED
;
; ROM RAM
GETBYT EQU E6F8 ; 1EEF
SYNERR EQU DEC9 ; 16CC
FRNUM EQU DD67 ; 156A
GETADR EQU E752 ; 1F49
;
; ORG 9200
; OBJ 9200
;
; PROCESS &
BEGIN PHA
9200 48
9201 203195 JSR SAVEZF ; SAVE ZERO FG
9204 68 PLA
9205 A202 LDX ##02
9207 CA CHRFSN DEX
9208 3053 BMI ERRX
920A DDA395 CMP CHRTBL,X ; 'S' OR 'D'
920D D0F8 BNE CHRFSN ; TRY AGAIN
920F BA TXA
9210 0A ASL ; TIMES 2
9211 AA TAX
9212 20B100 SR02 JSR CHRGET ; NEXT CHAR
9215 F046 BEQ ERRX
9217 C928 CMP ##28 ; (
9219 D0F7 BNE SR02
921B BDA095 LDA LOC+01,X ; JMP TO
921E 48 PHA ; ROUTINE
921F BD9F95 LDA LOC,X ; VIA
9222 48 PHA ; RTS
9223 60 RTS
;
; AMPER-SEARCH
;
SEARCH JSR GNAME ; GET NAME
JSR STRING ; CONVERT
JSR FARRAY ; FIND NAME
BCS ERV ; NA#
STX NAPTR+01
JSR CHRGET
JSR FRNUM
JSR GETADR
LDA Z50
STA L ; LOWER SUBSC
LDA Z50+01
STA L+01
JSR CHRGET
JSR FRNUM
JSR GETADR
LDA Z50
STA H ; UPPER SUBSC
LDA Z50+01
STA H+01
JSR GNAME
JSR STRING
BCC SR20
;
; ERROR *
;
ERRX JSR RSZF
JMP SYNERR
;
; VARIABLE NOT FOUND MSG *
;
ERRV LDX ##00
9224 201E94
9227 205D94
922A 207494
922D B034
922F 86D0
9231 84D1
9233 20B100
9236 2067DD
9239 2052E7
923C A550
923E 85D8
9240 A551
9242 85D9
9244 20B100
9247 2067DD
924A 2052E7
924D A550
924F 85DA
9251 A551
9253 85DB
9255 201E94
9258 205D94
925B 901D
925D 205495
9260 4CC9DE
9263 A200

```

```

9265 BDA595 SR18 LDA MSG1,X ; ERROR MSG
9268 C9C0 CMP ##C0 ; @ DELIMITER
926A F0F1 BEQ ERRX
926C 0980 ORA ##80
926E 20EDFD JSR COUT
9271 E00C CPX ##0C
9273 D002 BNE SR19
9275 A219 LDX ##19
9277 EB SR19 INX
9278 D0EB BNE SR18 ; ALWAYS
;
927A 20AE94 SR20 JSR FSIMPL ; FIND NAME
927D B0E4 BCS ERRV
927F B6D2 STX SAPTR ; ST#
9281 B4D3 STY SAPTR+01
9283 20B100 JSR CHRGET
9286 20FBE6 JSR GETBYT
9289 B6DC STX PL ;FIRST POSITION
928B 20B100 JSR CHRGET
928E 20FBE6 JSR GETBYT
9291 B6DD STX PH ; LAST POSITION
9293 201E94 JSR GNAME
9296 203D94 JSR INTE
9299 B0C2 BCS ERRX
929B 207494 JSR FARRAY
929E 9009 BCC SR21
92A0 20AE94 JSR FSIMPL
92A3 B0BE BCS ERRV
92A5 A9FF LDA ##FF
92A7 B5E8 STA SIZE ; # OF HITS ONLY
92A9 B6D4 STX JAPTR ; IX
92AB B4D5 STY JAPTR+01
92AD 201E94 JSR GNAME
92B0 203D94 JSR INTE
92B3 B0A8 BCS ERRX
92B5 20AE94 JSR FSIMPL
92B8 B0A9 BCS ERRV
92BA B6D6 STX NPT ; NZ
92BC B4D7 STY NPT+01
92BE 20B100 JSR CHRGET
92C1 D09A BNE ERRX
; FINISHED PARAMETERS *
;
; SET UP POINTERS *
;
92C3 18 CLC
92C4 A5D4 LDA JAPTR
92C6 6907 ADC ##07
92C8 B5D4 STA JAPTR ; IX
92CA A5D5 LDA JAPTR+01
92CC 6900 ADC ##00
92CE B5D5 STA JAPTR+01
92D0 A5DA LDA H
92D2 B550 STA Z50
92D4 A5DB LDA H+01
92D6 B551 STA Z50+01
92D8 A903 LDA ##03
92DA B554 STA #54
92DC A900 LDA ##00
92DE B555 STA #55
92E0 20E594 JSR MPLY
92E3 B6E0 STX NAPTH ; NA*(H)
92E5 B4E1 STY NAPTH+01
92E7 A5DB LDA L
92E9 B550 STA Z50
92EB A5D9 LDA L+01
92ED B551 STA Z50+01
92EF 20E594 JSR MPLY
92F2 B6D0 STX NAPTR ; NA*(L)
92F4 B4D1 STY NAPTR+01
;
92F6 18 CLC
92F7 A5D2 LDA SAPTR
92F9 6902 ADC ##02
92FB B5D2 STA SAPTR ; ST#
92FD A5D3 LDA SAPTR+01
92FF 6900 ADC ##00
9301 B5D3 STA SAPTR+01
9303 A000 LDY ##00
9305 B1D2 LDA (SAPTR),Y
9307 D003 BNE SR22
9309 4C1A94 JMP RETURN ; NULL
930C B5E9 SR22 STA LENA
930E C8 INY
930F B1D2 LDA (SAPTR),Y; SAVE
9311 B5E4 STA CSAPTR ; ADDRESS
9313 C8 INY
9314 B1D2 LDA (SAPTR),Y
9316 B5E5 STA CSAPTR+01
;
; START SEARCH *
;

```

```

9318 A000 NEXT LDY ##00
931A B1D0 LDA (NAPTR),Y
931C F04A BEQ NEXTNA ; NULL
931E B5E8 STA LENA ; LEN(NA*( ))
9320 C8 INY
9322 B1D0 LDA (NAPTR),Y
9324 B5E2 STA CNAPTR
9326 C8 INY
9328 B1D0 LDA (NAPTR),Y
932A B5E3 STA CNAPTR+01
932C A4DC LDY PL
932E B8 DEY
9330 C4E8 CPY LENA
9332 B037 BCS NEXTNA
9334 A900 NXTNAC LDA ##00
9336 B5E7 STA PS ;CURRENT POSITIO
9338 B5EA STA SWITCH
9340 B1E2 CONT LDA (CNAPTR),Y
9342 C8 INY
9344 B4E6 STY SAVEY
9346 A4E7 LDY PS
9348 D1E4 CMP (CSAPTR),Y
934A F006 BEQ SR25 ; POSSIBLE MATCH
934C B1E4 LDA (CSAPTR),Y
934E C90E CMP ##0E ; CNTL N
9350 D011 BNE SR26 ; NOT WILD CARD
;
; POSSIBLE MATCH *
;
9352 SR25 LDA ##FF
9354 B5EA STA SWITCH
9356 C8 INY
9358 C4E9 CPY LENA ; AT END?
935A F038 BEQ MATCH ; IT'S A MATCH!
935C E6E7 INC PS
935E F013 BEQ NEXTNA
9360 A4E6 LDY SAVEY
9362 D0DE BNE CONT ; ALWAYS
9364 A4E6 SR26 LDY SAVEY
9366 24EA BIT SWITCH
9368 1001 BPL SR28
936A B8 DEY
936C C4E8 SR28 CPY LENA ; AT END?
936E B004 BCS NEXTNA ; BR YES
9370 C4DD CPY PH ; LAST POSITION
9372 90C9 BCC NXTNAC ; NEXT CHAR
9374 18 CLC ; NEXT NA*(I)
9376 A5D0 NEXTNA LDA NAPTR
9378 6903 ADC ##03
937A B5D0 STA NAPTR
937C A5D1 LDA NAPTR+01
937E 6900 ADC ##00
9380 B5D1 STA NAPTR+01
9382 E6D8 INC L
9384 D002 BNE SR33
9386 E6D9 INC L+01
9388 B8 SEC
938A A5E0 LDA NAPTH
938C E5D0 SRC NAPTR
938E A5E1 LDA NAPTH+01
9390 E5D1 SRC NAPTR+01
9392 B092 BCS NEXT
9394 4C1A94 JMP RETURN ; AT NA*(H)
;
; FOUND A MATCH *
;
9396 MATCH BIT SIZE
9398 B108 BMI SZONLY ; # MATCHES ONLY
939A A000 LDY ##00
939C A5D9 LDA L+01 ; SUBSCRIPT
939E 91D4 STA (JAPTR),Y
93A0 C8 INY
93A2 A5DB LDA L
93A4 91D4 STA (JAPTR),Y
93A6 18 CLC
93A8 A5D4 LDA JAPTR
93AA 6902 ADC ##02
93AC B5D4 STA JAPTR
93AE A5D5 LDA JAPTR+01
93B0 6900 ADC ##00
93B2 B5D5 STA JAPTR+01
93B4 A003 SZONLY LDY ##03
93B6 18 CLC
93B8 B1D6 LDA (NPT),Y
93BA 6901 ADC ##01 ; NZ=NZ+1
93BC 91D6 STA (NPT),Y
93BE B8 DEY
93C0 B1D6 LDA (NPT),Y
93C2 B108 BMI ONLY1 ;1ST OCCURRENCE
93C4 6900 ADC ##00
93C6 91D6 STA (NPT),Y
93C8 4C6893 JMP NEXTNA

```

(continued)

```

93BA A900 ONLY1 LDA ##00
93BC 91D6 STA (NPT),Y
93BE CB INY
93BF A901 LDA ##01 ; NZ=1
93C1 91D6 STA (NPT),Y
;
; FINISHED AMPER-SEARCH *
;
93C3 4C1A94 JMP RETURN
;
93C6 4C5D92 ERRXX JMP ERRX
93C9 4C6392 ERRVX JMP ERRV
;
; DEALLOCATE *
;
93CC 201E94 DEALLO JSR GNAME ; GET NAME
93CF C924 CMP ##24 ; $
93D1 F005 BEQ RE50
93D3 203D94 JSR INTE ; %
93D6 D003 BNE RE55 ; ALWAYS
93D8 205D94 RE50 JSR STRING
93DB B0E9 RE55 BCS ERRXX
93DD 207494 JSR FARRAY
93E0 B0E7 BCS ERRVX
93E2 86D0 STX NAPTR ; NA#
93E4 84D1 STY NAPTR+01
93E6 A002 LDY ##02
93E8 B1D0 LDA (NAPTR),Y
93EA 85D2 STA OFFSET
93EC CB INY
93ED B1D0 LDA (NAPTR),Y
93EF 85D3 STA OFFSET+01
93F1 18 CLC
93F2 A5D2 LDA OFFSET
93F4 65D0 ADC NAPTR
93F6 85D4 STA A1
93F8 A5D3 LDA OFFSET+01
93FA 65D1 ADC NAPTR+01
93FC 85D5 STA A1+01
93FE 201495 JSR MOVE ; MOVE VARIABLES
9401 38 SEC
9402 A56D LDA $6D
9404 E5D2 SBC OFFSET
9406 856D STA $6D
9408 A56E LDA $6E
940A E5D3 SBC OFFSET+01
940C 856E STA $6E
940E 20B700 JSR CHRGET
9411 C929 CMP ##29 ; )
9413 D0B7 BNE DEALLO ; NEXT VAR
9415 20B100 JSR CHRGET
9418 D0AC BNE ERRXX
;
; FINISHED *
;
941A 205495 RETURN JSR RSZP ; RESTORE PAGE#
941D 60 RTS
;
;*****
; SUBROUTINES *
;*****
; GET VARIABLE NAME *
941E A200 GNAME LDX ##00
9420 20B100 GR01 JSR CHRGET
9423 C92C CMP ##2C ; ,
9425 F011 BEQ GR03
9427 C929 CMP ##29 ; )
9429 F00D BEQ GR03
942B 9DAF95 STA NAME,X ; SAVE NAME
942E EB INX
942F E010 CPX ##10 ; 16 IS ENOUGH
9431 D0ED BNE GR01
9433 68 PLA
9434 68 PLA ; POP STACK
9435 4C5D92 JMP ERRX
9438 CA GR03 DEX
9439 BDAF95 LDA NAME,X ; $ OR %
943C 60 RTS
;
; INTEGER NAME *
;
943D C925 INTE CMP ##25 ; %
943F D01A BNE ERRI ; NOT %
9441 BDB195 STA NAME+02 ; SAVE
9444 E001 CFX ##01 ; NAME
9446 D004 BNE GR10 ; IN
9448 A980 LDA ##80 ; APPLESOFT
944A D007 BNE GR14 ; FORMAT
944C A201 GR10 LDX ##01
944E A980 GR12 LDA ##80
9450 1DAF95 ORA NAME,X

```

```

9453 9DAF95 GR14 STA NAME,X
9456 CA DEX
9457 10F5 BPL GR12
9459 18 CLC ; CLEAR ERR
945A 60 RTS
945B 38 ERRI SEC ; SET ERR
945C 60 RTS
;
; STRING NAME *
;
945D C924 STRING CMP ##24 ; $
945F D011 BNE ERRS
9461 BDB195 STA NAME+02
9464 A980 LDA ##80
9466 E001 CFX ##01 ; SAVE
9468 F003 BEQ GR18 ; NAME
946A 0DB095 STA NAME+01
946D 0DB095 GR18 ORA NAME+01
9470 18 CLC
9471 60 RTS
9472 38 ERRS SEC ; SET ERR
9473 60 RTS
;
; FIND ARRAY NAME *
; IN VARIABLE SPACE *
;
9474 A56B FARRAY LDA $6B
9476 85DE STA TEM6X
9478 A56C LDA $6C
947A 85DF STA TEM6X+01
947C A000 F02 LDY ##00
947E B1DE LDA (TEM6X),Y
9480 CDAF95 CMP NAME ; 1ST CHAR
9483 D008 BNE F04
9485 CB INY
9486 B1DE LDA (TEM6X),Y
9488 CDB095 CMP NAME+01 ; 2ND CHAR
948B F01B BEQ FOUND
948D 18 F04 CLC ; LOOK AT
948E A002 LDY ##02 ; NEXT NAME
9490 B1DE LDA (TEM6X),Y
9492 65DE ADC TEM6X
9494 48 PHA
9495 CB INY
9496 B1DE LDA (TEM6X),Y
9498 65DF ADC TEM6X+01
949A 85DF STA TEM6X+01
949C 68 PLA
949D 85DE STA TEM6X
949F C56D CMP $6D
94A1 A5DF LDA TEM6X+01
94A3 E56E SBC $6E
94A5 90D5 BCC F02 ; TRY NEXT ONE
94A7 60 RTS ; NOT FOUND
;
; FOUND LDX TEM6X ; RTN WITH
LDY TEM6X+01 ; ADDRESS
CLC
RTS
;
; FIND SIMPLE NAME *
; IN VARIABLE SPACE *
;
94AE A569 FSIMPL LDA $69
94B0 85DE STA TEM6X
94B2 A56A LDA $6A
94B4 85DF STA TEM6X+01
94B6 A000 FS2 LDY ##00
94B8 B1DE LDA (TEM6X),Y
94BA CDAF95 CMP NAME ; 1ST CHAR
94BD D008 BNE FS4
94BF CB INY
94C0 B1DE LDA (TEM6X),Y
94C2 CDB095 CMP NAME+01 ; 2ND CHAR
94C5 F018 BEQ FOUNDS
94C7 18 FS4 CLC ; TRY NEXT ONE
94C8 A5DE LDA TEM6X
94CA 6907 ADC ##07 ; DISPLACEMENT
94CC 85DE STA TEM6X
94CE A5DF LDA TEM6X+01
94D0 6900 ADC ##00
94D2 85DF STA TEM6X+01
94D4 A5DE LDA TEM6X
94D6 C56D CMP $6D ; AT END?
94D8 A5DF LDA TEM6X+01
94DA E56E SRC $6E
94DC 90D8 BCC FS2 ; NEXT ONE
94DE 60 RTS ; NOT FOUND
;
; FOUNDS LDX TEM6X ; RTN WITH
LDY TEM6X+01 ; ADDRESS
CLC
RTS

```



```

;
; MULTIFLY ROUTINE *
;
94E5 18      MPLY  CLC
94E6 ASD0   LDA  NAPTR
94E8 6907   ADC  #007
94EA 8552   STA  $52
94EC ASD1   LDA  NAPTR+01
94EE 6900   ADC  #000
94F0 8553   STA  $53

;
; FROM 'RED' MANUAL *
;
94F2 A010   LDY  ##10
94F4 A550   MUL2  LDA  $50
94F6 4A     LSR
94F7 900C   BCC  MUL4
94F9 18     CLC
94FA A2FE   LDX  ##FE
94FC B554   MUL3  LDA  $54,X
94FE 7556   ADC  $56,X
9500 9554   STA  $54,X
9502 EB     INX
9503 D0F7   BNE  MUL3
9505 A203   MUL4  LDX  ##03
9507 7650   MUL5  ROR  $50,X
9509 CA     DEX
950A 10FB   BPL  MUL5
950C 88     DEY
950D D0E5   BNE  MUL2
950F A650   LDX  Z50
9511 A451   LDY  Z50+01
9513 60     RTS

;
; MOVE VARIABLES *
;
9514 A000   MOVE  LDY  ##00
9516 B1D4   MV01  LDA  (A1),Y
9518 91D0   STA  (NAPTR),Y
951A E6D0   INC  NAPTR
951C D002   BNE  NXTA1
951E E6D1   INC  NAPTR+01
9520 ASD4   NXTA1 LDA  A1
9522 C54D   CMP  $6D
9524 ASD5   LDA  A1+01
9526 E56E   SBC  $6E
9528 E6D4   INC  A1
952A D002   BNE  MV02
952C E6D5   INC  A1+01
952E 90E6   MV02  BCC  MV01 ;NEXT ONE
9530 60     RTS

;
; SAVE ZERO *
; PAGE SPACE *

9531 A200   SAVEZP LDX  ##00
9533 B5D0   SV02  LDA  NAPTR,X
9535 9DD095 STA  ZPSV,X
9538 EB     INX
9539 E020   CFX  ##20 ; SAVE
953B D0F6   BNE  SV02 ; 32 SPOTS
953D A200   LDX  ##00
953F B550   SV04  LDA  $50,X ; ALSO $50,$55
9541 9DCA95 STA  SV50,X
9544 EB     INX
9545 E006   CFX  ##06
9547 D0F6   BNE  SV04
9549 A20F   LDX  ##0F
954B A920   LDA  ##20 ; CLEAR
954D 9DAF95 CLEAR STA  NAME,X ; NAME AREA
9550 CA     DEX
9551 10FA   BPL  CLEAR
9553 60     RTS

;
; RESTORE ZERO *
; PAGE SPACE *
;
9554 A200   RSZP  LDX  ##00
9556 BDD095 RS02  LDA  ZPSV,X
9559 95D0   STA  NAPTR,X
955B EB     INX
955C E020   CFX  ##20
955E D0F6   BNE  RS02
9560 A200   LDX  ##00
9562 BDCA95 RS04  LDA  SV50,X
9565 9550   STA  $50,X
9567 EB     INX
9568 E006   CFX  ##06
956A D0F6   BNE  RS04
956C 60     RTS

;
; DATA STORAGE *
;
956D C1CDD0C5D2ADD3C5C1D2C3C8
9579 C1CCC1CEA0C7AEA0C8C9CCCC
9585 C3CFDCDC5D2C3C9C1CCA0D2C9C7C8D4D3A0
9597 D2C5D3C5D2D6C5C4
959F CB93   LOC   DFD  CB93 ; DEALLOC-1
95A1 2392   DFD  2392 ; SEARCH-1
95A3 44     CHRTEL DFD  44 ; D
95A4 53     DFD  53 ; S
95A5 8D     MSG1  DFD  8D
95A6 D6C1D2C9C1C2CCC5A0
95AF A0A0A0A0A0A0A0A0A0A0A0A0A0A0A0A0A0
95BF 8D     DFD  8D
95C0 CECFD4A0C6CFD5CEC4
95C9 C0     DFD  "e"
95CA A0A0A0A0A0A0 -ZPSV DFD  " " ; $20 SPACES
95D0 A0

```

Send for **FREE**  
Control Page  
Also Available soon on Atari

# EDIT 6502 T.M. LJK

Two Pass Assembler, Disassembler, and Editor Single Load Program  
DOS 3.3., 40/80 Columns, for Apple II or Apple II Plus\*

A MUST FOR THE MACHINE LANGUAGE PROGRAMMER. Edit 6502\* is a two pass Assembler, Disassembler and text editor for the Apple computer. It is a single load program that only occupies 7K of memory. You can move freely between assembling and disassembling. Editing is both character and line orientated, the two pass disassemblies create editable source files. The program is so written so as to encompass combined disassemblies of 6502 Code, ASCII text, hex data and Sweet 16 code. Edit 6502 makes the user feel he has never left the environment of basic. It encompasses a large number of pseudo opcodes, allows linked assemblies, software stacking (single and multiple page) and complete control of printer (paganation and tab setting). User is free to move source, object and symbol table anywhere in memory. Requirements: 48K of RAM, and ONE DISK DRIVE. Optional use of 80 column M&R board, or lower case available with Paymar Lower Case Generator.

LOOK AT THESE KEY BOARD FUNCTIONS: Copy to the end of line and exit: Go to the beginning of the line: abort operation: delete a character at cursor location: go to end of line: find character after cursor location: non destructive backspace: insert a character at cursor location: shift lock: shift release: forward copy: delete line number: prefix special print characters. Complete cursor control: home and clear. right, left down up. Scroll a line at a time. **Never type a line number again.**

All this and much much more — Send for **FREE** Information.  
**Introductory Price \$50.00.**

TAKE A LOOK AT JUST SOME OF THE EDITING COMMAND FEATURES. Insert at line # n Delete a character Insert a character Delete a line # n List line # n1, n2 to line # n3 Change line # n1 to n2 "stringl" Search line # n1 to n2 "stringl".

LJK Enterprises Inc. P.O. Box 10827 St. Louis, MO 63129 (314)846-6124  
\*Edit 6502 T.M. of LJK Ent. Inc. — \*Apple T.M. of Apple Computer Inc.

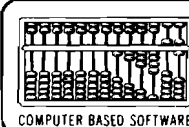

# DATA CAPTURE 4.0<sup>©</sup>

The most advanced and easiest to use telecommunications program for use with the MICROMODEM II<sup>™</sup> or the Apple COMMUNICATIONS CARD<sup>™</sup>

- Q. Will DATA CAPTURE 4.0 work with my Communications Card<sup>™</sup> and a modem?**  
A. It makes using the Comm. Card almost as easy as using the Micromodem II.
- Q. Do I need an extra editor to prepare text for transmission to another computer?**  
A. No. DATA CAPTURE 4.0 gives you control of the text buffer. You can use DATA CAPTURE 4.0 to create text.
- Q. Can I edit the text I have prepared?**  
A. Yes. You can insert lines or delete any lines from the text.
- Q. How about text I have captured. Can I edit that?**  
A. As easily as the text you have prepared yourself. You can delete any lines you don't want to print or save to a disk file. You can also insert lines into the text.
- Q. Just how much text can I capture with DATA CAPTURE 4.0?**  
A. If the system with which you are communicating accepts a stop character, most use a Control S, you can capture an unlimited amount of text.
- Q. How does that work? And do I have to keep an eye on how much I have already captured?**  
A. When the text buffer is full the stop character is output to the other system. Then DATA CAPTURE 4.0 writes what has been captured up to that point to a disk file. This is done automatically.
- Q. Then what happens?**  
A. Control is returned to you and you can send the start character to the other system. This generally requires pressing any key, the RETURN key or a Control Q.
- Q. Are upper and lower case supported if I have a Lower Case Adapter?**  
A. Yes. If you don't have the adapter an upper case only version is also provided on the diskette.
- Q. Do I need to have my printer card or Micromodem II<sup>™</sup> or Communications Card<sup>™</sup> in any special slot?**  
A. No. All this is taken care of when you first run a short program to configure DATA CAPTURE 4.0 to your system. Then you don't have to be concerned with it again. If you move your cards around later you can reconfigure DATA CAPTURE 4.0.
- Q. Do I have to build a file on the other system to get it sent to my Apple?**  
A. No. If the other system can list it you can capture it.
- Q. How easy is it to transmit text or data to another system?**  
A. You can load the text or data into DATA CAPTURE 4.0 from the disk and transmit it. Or you can transmit what you have typed into DATA CAPTURE 4.0.
- Q. How can I be sure the other system receives what I send it?**  
A. If the other system works in Full Duplex, it 'echoes' what you send it, then DATA CAPTURE 4.0 adjusts its sending speed to the other system and won't send the next character until it is sure the present one has been received. We call that 'Dynamic Sending Speed Adjustment'.
- Q. What if the other system works only in Half Duplex.**  
A. A different sending routine is provided for use with Half Duplex systems.
- Q. What if I want to transmit a program to the other system?**  
A. No problem. You make the program into a text file with a program that is provided with DATA CAPTURE 4.0, load it into DATA CAPTURE 4.0 and transmit it.

- Q. What type files can I read and save with DATA CAPTURE 4.0?**  
A. Any Apple DOS sequential text file. You can create and edit EXEC files, send or receive VISICALC<sup>®</sup> data files, send or receive text files created with any editor that uses text files.
- Q. Can I leave DATA CAPTURE 4.0 running on my Apple at home and use it from another system?**  
A. Yes. If you are using the Micromodem II<sup>™</sup> you can call DATA CAPTURE 4.0 from another system. This is handy if you are at work and want to transmit something to your unattended Apple at home.
- Q. Where can I buy DATA CAPTURE 4.0?**  
A. Your local Apple dealer. If he doesn't have it ask him to order it. Or if you can't wait order it directly from Southeastern Software. The price is \$65.00. To order the Dan Paymar Lower Case Adapter add \$64.95 and include the serial number of your Apple.
- Q. If I order it directly how can I pay for it?**  
A. We accept Master Charge, Visa or your personal check. You will get your order shipped within 3 working days of when we receive it no matter how you pay for it. Send your order to us at the address shown or call either of the numbers in this advertisement. You can call anytime of day, evening or Saturdays.
- Q. I bought DATA CAPTURE 3.0 and DATA CAPTURE 4.0 sounds so good I want this version. What do I do to upgrade?**  
A. Send us your original DATA CAPTURE 3.0 diskette and documentation, the \$35.00 price difference and \$2.50 for postage and handling. We will send you DATA CAPTURE 4.0 within 3 working days of receiving your order.
- Q. What kind of support can I expect after I buy it?**  
A. If you have bought from Southeastern Software in the past you know we are always ready to answer any questions about our products or how to use them.

**Requires DISK II<sup>™</sup>, Applesoft II<sup>™</sup> and 48K of Memory**

## DATA CAPTURE 4.0<sup>©</sup>

Copyright © 1980-Southeastern Software

\* Apple<sup>®</sup>, Apple II Plus<sup>®</sup>, Disk II<sup>®</sup> and APPLESOFT II<sup>®</sup> are trademarks of Apple Computer Company.

\* Micromodem II<sup>™</sup> is a trademark of D.C. Hayes Associates, Inc.

\* Visicalc<sup>®</sup>-Copyright by Software Arts, Inc.



We welcome your personal check. We also accept Visa and Master Charge.

# Southeastern Software

Dept. MK

6414 Derbyshire Drive • New Orleans, LA 70126  
504/246-8438 504/246-7937

# Memory Expansion for the Superboard

**A less expensive way to add memory to the Superboard using the OSI 527 memory expansion board.**

Fred Boness  
11703 60th St.  
Kenosha, Wisconsin 53142

The greatest disadvantage of owning a single board computer is its limited memory. The Superboard has space for only 8K of memory, although Ohio Scientific offers the 610 expansion board, which can add 24K to the Superboard. However, a 610 with only 8K of memory costs more than the Superboard itself. There is more on the 610 than memory, like a floppy disk controller, but all I want is a little more memory.

OSI offers a variety of memory boards for their 48-line bus. Adapting

one of these to the Superboard means finding the necessary address, data, and control signals on the Superboard's 40-pin expansion socket, and matching them to the 48-line bus. Fortunately, OSI has designed a simple and straightforward system. Figure 1 shows the expansion socket and corresponding bus lines. Only 27 lines are used. Note that +5 volts is not available at the expansion socket. The user's manual for the Superboard includes a complete description of the 48-line bus.

## Building the 527

I decided to use the OSI 527 memory board because it is the most like the 610. It is a 24K board which uses 2114 chips. One of the nice things OSI does for experimenters is to sell bare printed circuit boards for many of its products. (OSI sells a fully populated 527 as a CM-9.)

Most of the control and memory decoding logic functions are shown in figure 2. The six high address lines are decoded by four 74LS138 three-to-

eight-line decoders. Jumpers W1, W2, and W3 at F9 determine the starting addresses of three independent 8K blocks of memory on 8K boundaries. No changes are made here or at W4, which selects the memory management option. Parts C10, C11, and SW11 are also for memory management and will not be needed.

C9, D9, and E9 select pairs of 2114's beginning at A1 and B1 with the active low chip enable lines CEO to CE23.

F10 and E11 are 74LS04 hex inverters used as address line buffers. There are jumpers across each inverter that must be cut before the sockets for the 74LS04's are soldered in place. These jumpers are not shown on the schematics provided by OSI. Jumper W5 at D10 must be changed in two places to buffer address line A6.

While the Superboard documentation uses the name O2 throughout, the 48-line bus has both O2, B39, and

	1	IRQ	40	GND	
	2	NMI	39	GND	
B4	3	Data direction	38	GND	
B5	4	DO	37	GND	
B6	5	D1	B9	36	D4
B7	6	D2	B10	35	D5
B8	7	D3	B11	34	D6
	8	GND	B12	33	D7
	9	GND	B40	32	R/W
	10	GND	B42	31	O2
	11	—		30	GND
B35	12	A2		29	GND
B34	13	A1		28	GND
B38	14	A0	B48	27	A15
B36	15	A3	B47	26	A14
B37	16	A4	B46	25	A13
B31	17	A5	B45	24	A12
B29	18	A6	B44	23	A11
B30	19	A7	B43	22	A10
B32	20	A8	B33	21	A9

Figure 1: Pinouts for the 40-pin socket and corresponding bus (Bxx) lines.

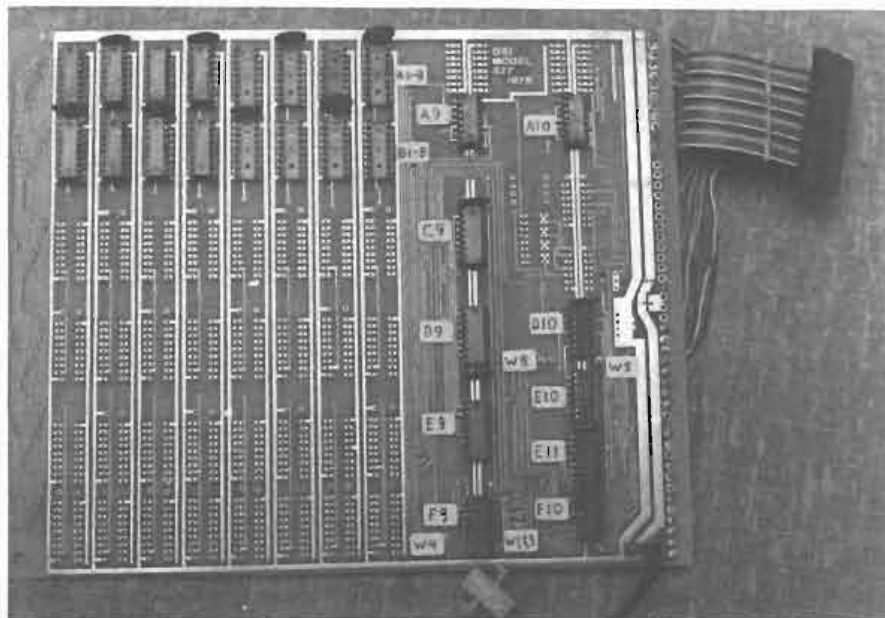

02VMA, B42. Use 02VMA for this board. VMA is actually a 6800 signal, Valid Memory Address.

The data direction signal, DD, is generated by the memory board and controls the direction of the two 8T26 bus driver/receivers on the board and two 8T28 bus driver/receivers on the Superboard. The 8T28's are the only extra parts needed by the Superboard. They are placed in the sockets between the expansion connector and the 6502.

I considered several ways of positioning the memory board. I wanted it to be accessible for servicing and convenient in use. It now sits behind the keyboard on nylon standoffs, component side up, with the bus on the left and a 40-conductor ribbon cable running under the board to the expansion socket.

There is a provision in the corner of the 527 board to bring in power and ground. This makes it easy to power the memory board with a short jumper from the fuse on the Superboard. Ground is to a wide trace near the fuse.

The ribbon cable can be soldered into the plated-through holes intended for Molex connectors. Bending hairpins in the tinned wire ends will help since these holes are large. All the wires were first threaded through the holes and checked for correct connection. Then the assembly was checked for fit on the Superboard before the wires were cut to length and soldered.

### Testing

The Superboard does its own memory test and I used that for the first sign of success. What I got was the first indication of failure. Further testing using POKE and PEEK showed that no part of the 4K on the board was working.

It was several days later that I found the last of seven trace bridges on the board. One such bridge had been repaired by OSI. Perseverance was rewarded with the simple line "11519 BYTES FREE".

### Conclusion

I never liked the idea that the Superboard was a "weak sister" of limited capability. Now it looks as though any board offered for OSI's main line of computers can be adapted to the Superboard. How would you like 16 lines of analog I/O or a Votrax? With a little extra work you could add a backplane. Take your choice.

**MICRO**

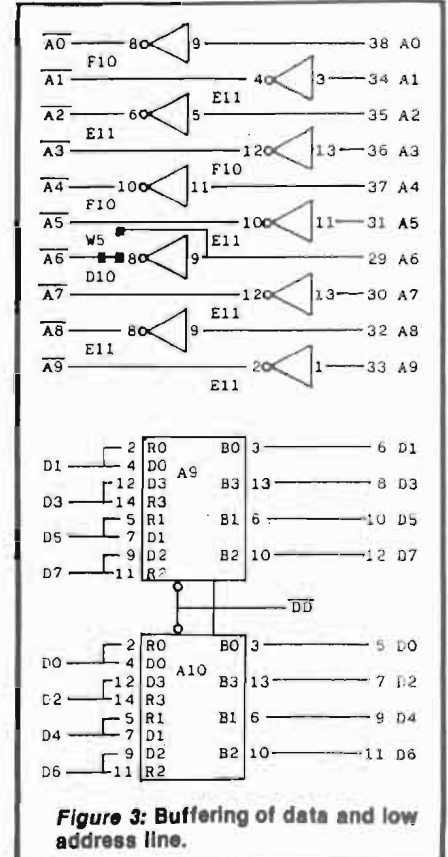
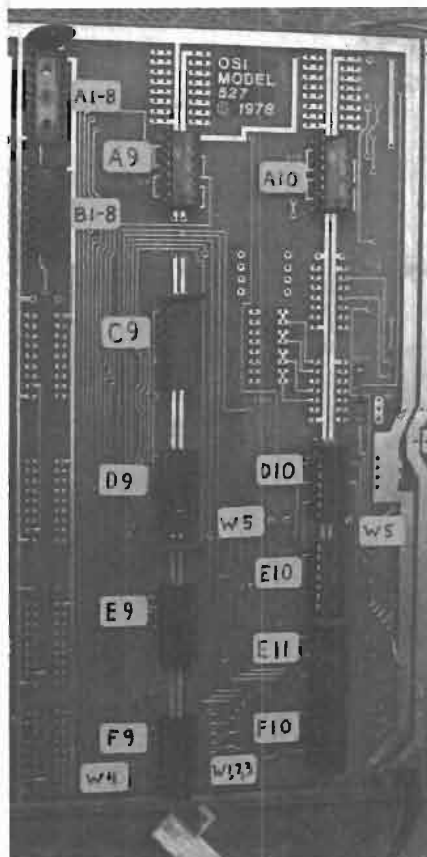
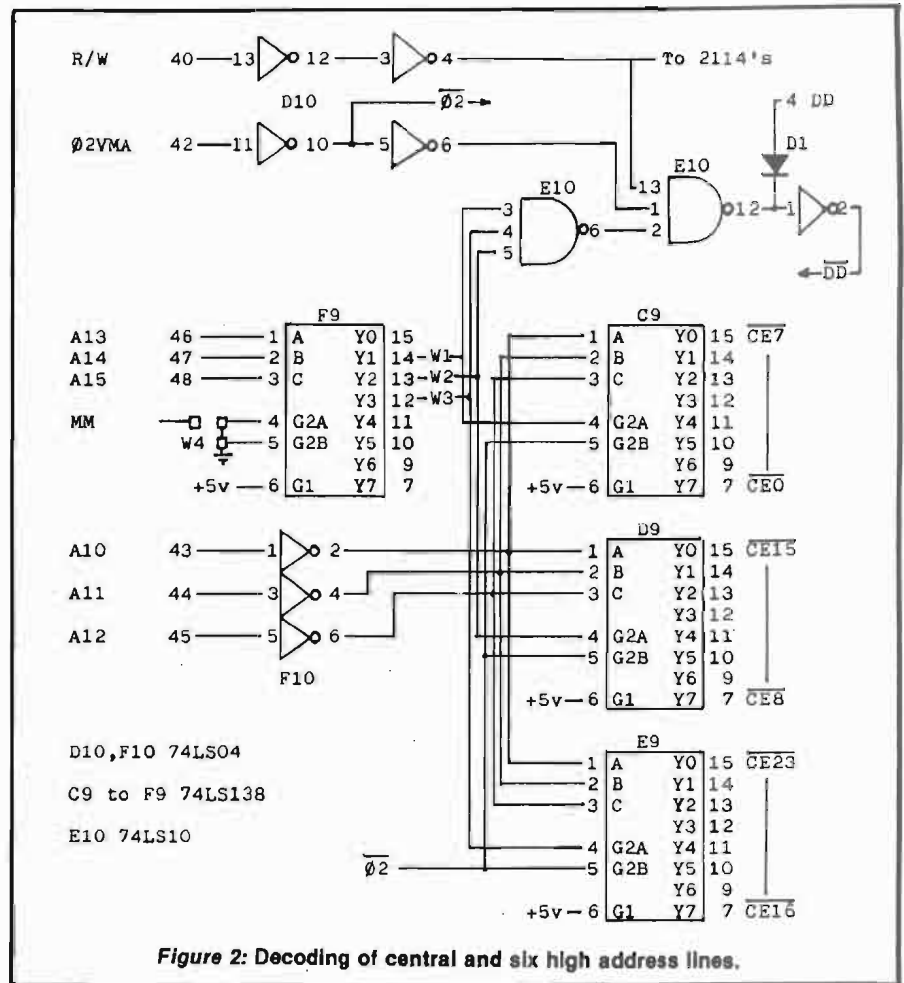

# Horizontal Screen Scrolling On the CBM/PET

Horizontal scrolling is a convenient method of displaying graphic functions that are too wide to fit on a PET screen. Using only the standard character set, a dramatic increase in resolution is possible.

John E. Girard  
676 Alma St. #202  
Oakland, California 94610

Long ago I stopped complaining about PET graphic resolution. In most cases it is adequate, and when it isn't adequate, there are always the lines (8 per cell), quarter-boxes and scroll plotting. That's right... *scroll plotting*. If I have left you in the dark, then consider this: If a graph, for example, is cramped and unreadable, then scale it much larger and let it roll past you, like a program listing. The only problem is one of orientation. We expect events to occur from side to side; the built-in scroll feature causes them to occur from down to up at a 90 degree rotation! I chose to solve this problem.

The result was a simple machine language program which moves the contents of the screen, 1 column to the left, whenever called by SYS 826. The program owes its brevity to the use of these "extended ASCII" cursor movement characters.

ASCII Value	Function
\$13	cursor home
\$1D	cursor right
\$14	cursor delete
\$0D	carriage return/line feed

The PET routine, called through \$FFD2, prints the ASCII character of the accumulator value at current cursor position.

```

100 REM HORIZONTAL SCROLLER/PLOTTER
110 REM WRITTEN BY JOHN GIRARD
120 FORI= 826 TO 856 :READDC:POKEI,DC:NEXT
130 FORI=1T04:READPD:P(I)=PD:NEXTI
140 FORI=1T09:READL:PH(I)=L:NEXT
150 DATA169,19,32,210,255,170,169,29
160 DATA32,210,255,169,20,32,210,255
170 DATA169,13,32,210,255,202,224,0,208
180 DATA236,96,0,76,58,3
190 REM PLOTTING CHARACTER DATA
200 DATA 123,126,108,124
210 DATA100,100,82,70,64,67,68,69,99
220 PRINT"Q"
230 PRINT"SHOULD YOU WISH QUARTER BOX OR"
240 PRINT"NON-HORIZONTAL LINE PLOTTING CHARACTER?"
250 GETQ$:IFQ$="Q"THENQ=1:GOTO260
260 IFQ$<>"H"THEN230
270 Q=2
280 PRINT"Q":SYS826:PRINT
290 FORI=1T039:PRINT"-";:NEXT:PRINT:PRINTTAB(
15)" / \ "
300 PRINT"FUNCTION = SIN(W/2) * COS(W/18)
310 Y=9*(1-((SIN(M/2)*COS(M/18)))):Y2=Y
320 Y2=-1*SIN(M/2)*COS(M/18)
330 M=M+1:IFM>55THENM=0
340 ONGOSUB390,460:SYS826
350 M$=STR$(M):IFM=0THENM$=" 0"
360 PRINT"MM / \ "
370 IFSGN(Y2)=-1THENPRINT"W="M$,"AMP="STR
$(INT((Y2*100)+.5)/100):GOTO310
380 PRINT"W="M$,"AMP="INT((Y2*100)+.5)/100
:GOTO310
390 REM Q BOX PLOT SUBROUTINE
400 IFY-INT(Y)>.5THENC=2
410 IFY-INT(Y)<=.5THENC=1
420 IFSGN(Y-OY)=1THENC=C+2
430 POKE33526-INT(Y)*40,P(C)
440 OY=Y
450 RETURN
460 REM HORIZ LINE PLOT SUBROUTINE
470 LL=1+INT(9*(Y-INT(Y)))
480 POKE33526-INT(Y)*40,PH(LL)
490 OY=Y
500 RETURN

```

### HORIZONTAL SCROLLER

```

033A A913      LDA #13
033C 20D2FF    JSR FFD2 :CURSOR HOME
033F AA        TAX          :PUT 19 IN X REG
0340 A91D      LDA #1D
0342 20D2FF    JSR FFD2 :CURSOR RIGHT
0345 A914      LDA #14
0347 20D2FF    JSR FFD2 :CURSOR DELETE
034A A90D      LDA #0D
034C 20D2FF    JSR FFD2 :CRLF
034F CA        DEX
0350 E000      CPX #00 :DONE 19 TIMES?
0352 D0EC      BNE 0340 :NO...DO AGAIN
0354 60        RTS          :RETURN TO BASIC
0355 00        BRK
0356 4C3A03    JMP 033A
    
```

The program starts by sending the cursor *home*. Next, the cursor is moved to the second column, top line. A *delete* is performed; this shifts the top line display to the left by one column. The cursor moves down to the next line, and the process is repeated 18 more times. The bottom 6 lines are untouched and may be used as a text window. The demonstration program, as written, will run on old and upgraded ROM CBM/PETs. I have included the option to plot either horizontal lines or the quarter-boxes. All plotting is done in the 37th column, thus the plotting subroutines are short, simple, and extremely *fast*.

As research associates in Lecture Demonstrations, John Girard and Loren Wright (MICRO's PET Vet) developed more than two dozen college-level physics programs at Berkeley. Mr. Girard is now training for systems analysis on the Burroughs 7800 system at Pacific Telephone Headquarters, San Francisco.

MICRO

## Decision Systems

Decision Systems  
P.O. Box 73006  
Denton, TX 76203

### SOFTWARE FOR THE APPLE II\*

**ISAM-DS** is an integrated set of Applesoft routines that gives indexed file capabilities to your BASIC programs. Retrieve by key, partial key or sequentially. Space from deleted records is automatically reused. Capabilities and performance that match products costing twice as much.  
\$50 Disk, Applesoft.

**PBASIC-DS** is a sophisticated preprocessor for structured BASIC. Use advanced logic constructs such as IF...ELSE..., CASE, SELECT, and many more. Develop programs for Integer or Applesoft. Enjoy the power of structured logic at a fraction of the cost of PASCAL.  
\$35. Disk, Applesoft (48K, ROM or Language Card).

**DSA-DS** is a dis-assembler for 6502 code. Now you can easily dis-assemble any machine language program for the Apple and use the dis-assembled code directly as input to your assembler. Dis-assembles instructions and data. Produces code compatible with the S-C Assembler (version 4.0), Apple's Toolkit assembler and others.  
\$25 Disk, Applesoft (32K, ROM or Language Card).

**FORM-DS** is a complete system for the definition of input and output forms. **FORM-DS** supplies the automatic checking of numeric input for acceptable range of values automatic formatting of numeric output, and many more features.  
\$25 Disk, Applesoft (32K, ROM or Language Card)

**UTIL-DS** is a set of routines for use with Applesoft to format numeric output, select clear variables (Applesoft's CLEAR gets everything), improve error handling and interface machine language with Applesoft programs. Includes a special load routine for placing machine language routines underneath Applesoft programs.  
\$25 Disk, Applesoft.

**SPEED-DS** is a routine to modify the statement linkage in an Applesoft program to speed its execution. Improvements of 5-20% are common. As a bonus, **SPEED-DS** includes machine language routines to speed string handling and reduce the need for garbage clean-up. Author: Lee Meador.  
\$15 Disk, Applesoft (32K, ROM or Language Card).

(Add \$4.00 for Foreign Mail)

\*Apple II is a registered trademark of the Apple Computer Co.

Singing the file transfer blues? Then...

## Get B.I.T.S.!

Use your Micromodem (1), A 10<sup>2</sup> Card, or Apple Comm Card<sup>3</sup> to:

**Send data files, BASIC programs, even machine code**

to most computers over phone lines.

**Copy anything you see**

into a 31K buffer then save it on disk and/or print it under your complete control.

**Many more features!**

**See it at your favorite computer store today.**

Trademarks held by:

1 - Hayes Microcomputer Products Inc  
2 - SSM

3 - Apple Computer Inc.

B.I.T.S. is a trademark of:

**MicroSoftware Systems**  
7927 Jones Branch Dr. Suite 400  
McLean, Virginia 22102  
(703) 385-2944

# Integer Flash for the Apple

It is possible to produce flashing characters in Integer BASIC, but you will need to understand some underlying mechanisms.

Richard C. Vile, Jr.  
3467 Yellowstone Dr.  
Ann Arbor, Michigan 48105

Have you ever been irked by the lack of an Apple II Integer BASIC FLASH statement? Have you ever wondered why the Integer BASIC manual tells you how to produce inverse video [POKE 50,63], but balks at similar instructions for flashing video? Have you ever experimented, trying to find a POKE 50,V which would "work", but been forced to give up in frustration? Well, despair no more! Read on for the solution to the Integer BASIC FLASH problem.

## Apple II Character Representation

The Apple II allows for 64 different characters to be displayed in TEXT mode. The representation of 64 distinct characters only requires 6 bits, but obviously 8 bits are used to store each character in memory. Thus, one could imagine up to four different "flavors" of characters, depending on what value (0-3) the 2 high order bits of the character byte happen to take on. The Apple II Reference Manual, #A2L0001A, contains a table on page 15 which shows the assignment of 8-bit "codes" to actual displaying characters. It turns out that there are only three visually distinguishable modes: NORMAL, FLASHING, and INVERSE.

The codes \$80 through \$9F are reserved for the control characters (and display as blanks), thus preventing a fourth mode, such as LOW INTENSITY. The distribution of values is shown in table 1.

Table 1

\$00 - \$1f	INVERSE MODE	@ through _ (underscore)
\$20 - \$3F	INVERSE MODE	space through ?
\$40 - \$5F	FLASHING MODE	@ through _
\$60 - \$7F	FLASHING MODE	space through ?
\$80 - \$9F	BASIC Control Characters (No Display)	
\$A0 - \$BF	NORMAL MODE	space through ?
\$C0 - \$DF	NORMAL MODE	@ through _
\$E0 - \$FF	Extra codes: Normally will not occur in BASIC. If they are fed to COUT, they display as NORMAL MODE characters space through ?.	

Listing 1

```

5 GOSUB 1000
10 TEXT : CALL -936
15 VTAB 8: TAB 1
20 FOR I=0 TO 255
25 POKE 0,I
30 CALL 1
35 NEXT I
99 END
1000 REM POKE IN THE COUT
1001 REM INTERFACE SUBROUTINE
1002 REM
1005 POKE 1,165
1006 POKE 2,0
1007 POKE 3,32
1008 POKE 4,237
1009 POKE 5,253
1010 POKE 6,96
1019 RETURN
    
```

Listing 2

```

5 KBD=-16384:CLR=-16368:WAIT=500:SHOWIT=100
10 REM TEST POKE 50,VALUE
11 REM FOR DIFFERENT VALUES
12 REM OF "VALUE"!!!
13 REM
14 REM !"#%&'()*
15 REM @ABCDEFGHI
16 REM 0123456789
17 REM
20 FOR I=0 TO 255 STEP 8
25 POKE 50,I: GOSUB SHOWIT
30 GOSUB WAIT
35 NEXT I
90 POKE 50,255: LIST
99 END
100 LIST : RETURN
500 KEY= PEEK (KBD)
505 IF KEY<128 THEN RETURN
510 POKE CLR,0
515 KEY= PEEK (KBD): IF KEY<128 THEN 515
520 POKE CLR,0: RETURN
    
```

The curious individual who wishes to "verify" this table may seek a way to display all the codes from 0 to 255 on the screen. The Apple II Monitor contains the routine COUT, which will place the value of the *code* in the 6502 accumulator onto the next available screen location. The trick is to use a machine language interface routine, which guarantees that a given value will be in the accumulator. This may be accomplished as follows: First POKE the following routine into memory (I have used PAGE 0):

```
LDA $00
JSR COUT ($FDED)
RTS
```

Then use the Integer BASIC statements:

```
POKE 0,1
CALL 1 (assuming you POKED
starting at location 1)
```

to display the value I. Listing 1 illustrates the application of this approach to produce the desired display of all possible character codes in the order 0 to 255. Run the program to verify the Apple Reference Manual's description.

### Quirks in the Character Assignments

In the "normal" ASCII code, the character codes for space through ? precede the character codes for @ through \_. This relationship is maintained in the NORMAL mode of the Apple II display. However, for both the INVERSE mode and the FLASHING mode, this relationship is *reversed*: the codes for INVERSE space through INVERSE ? follow rather than precede the codes for INVERSE @ through INVERSE \_. The same relationship holds for the FLASHING mode. Let's see what we may discover about the implications this may hold for the use of location 50 in Integer BASIC.

Page 32 of the Apple II Reference Manual tells us how location 50, the so-called Normal/Inverse Mask location, is used by COUT. Except for control characters, a logical AND is performed between the outgoing character and the value in location 50. If the outgoing character "came from" BASIC, it will be a character with code between \$A0 and \$DF. Using the value 255 as a mask will preserve all bits of the original code, whereas using the

value 63 as a mask will "strip off" the 2 high order bits of the original code. Codes between \$A0 and \$DF will be transformed to codes between \$00 and \$3F. But, let's look at that a little more carefully! The values between \$A0 and \$BF are taken into the values between \$20 and \$3F, not the values between \$00 and \$1F. Thus @ through \_ become INVERSE @ through INVERSE \_, and " " (space) through ? become INVERSE " " through INVERSE ?. Figure 1 illustrates this transformation.

Now suppose location 50 contains the number 127. Performing a logical AND of this value with a character code will remove only the *most significant* bit. This will produce exactly the same result as before for the codes \$A0 through \$BF; consequently, space through ? will be displayed in INVERSE mode. However, for the codes \$C0 through \$DF the resulting values will now be \$40 through \$5F. That means that @ through \_ will be displayed in FLASHING mode.

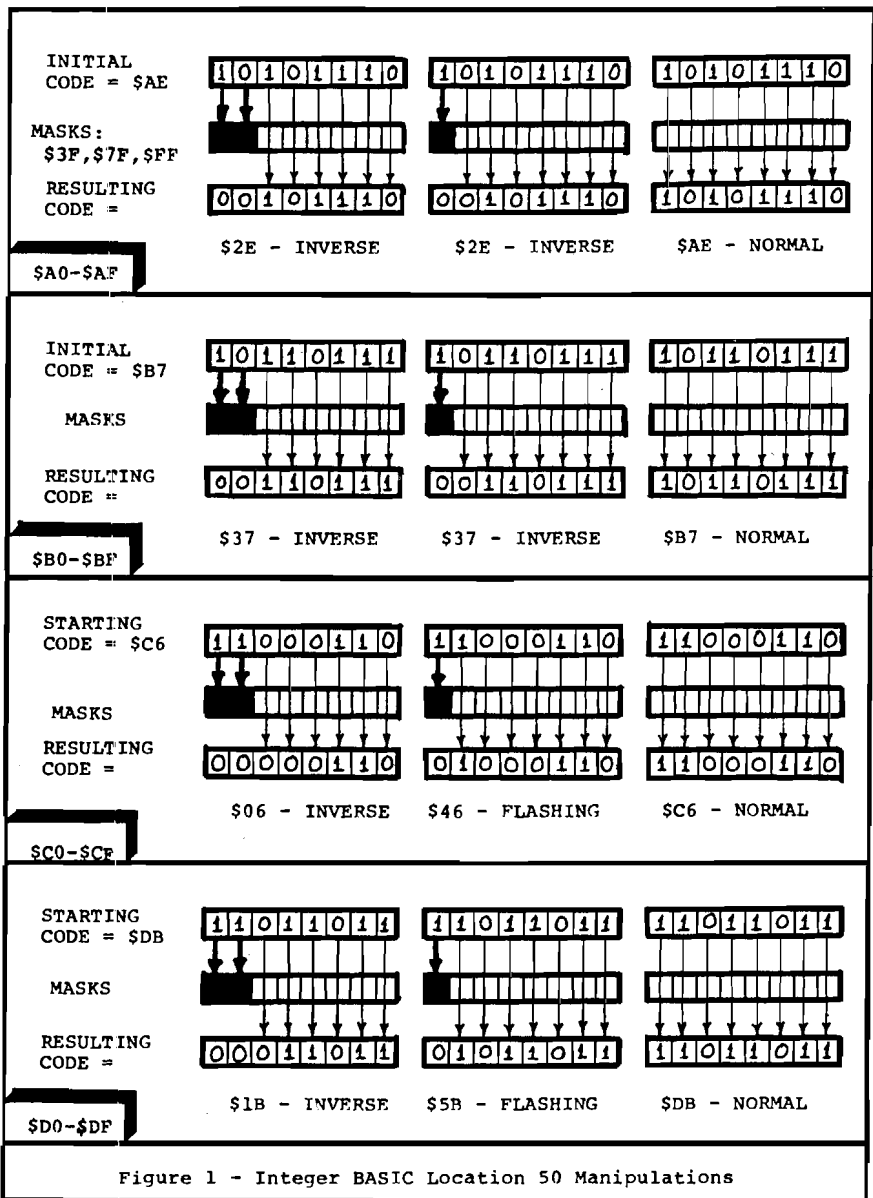

Figure 1 - Integer BASIC Location 50 Manipulations

### Listing 3

```
2000 REM PRINT A FLASHING CHARACTER
2001 REM
2005 IF ASC(CH$) <= ASC("?") THEN POKE 0, ASC(CH$)-64
2010 IF ASC(CH$) > ASC("?") THEN POKE 0, ASC(CH$)-128
2015 CALL 1
2019 RETURN
```



#### Listing 4

```

0800 ;*****
0800 ;*
0800 ;* FLASH SUBROUTINE *
0800 ;*
0800 ;* BY RICARD VILE *
0800 ;*
0800 ;*****
0800 ;*
0800 COUT1 EQU $FDF0
0800 ;
0001 ORC $1
0001 OBJ $800
0001 ;
0001 C9A0 FLASH CMP #$A0 ;CHECK FOR CONTROL CHARACTERS
0003 B003 BCS $08 ;GO ON IF NOT
0005 4CF0FD JMP COUT1 ;OTHERWISE GOTO COUT1 RIGHT AWAY
0008 C9C0 CMP #$C0 ;IS IT BIGGER THAN @?
000A B006 BCS $12 ;YES
000C 38 SEC ;NO
000D E940 SBC #$40 ;CONVERT BY SUBTRACTING 64
000F 4CF0FD JMP COUT1
0012 E980 SBC #$80 ;CONVERT BY SUBTRACTING 128
0014 4CF0FD JMP COUT1
END

```

#### Listing 5

```

10 GOSUB 1000
15 GOSUB FLASH: PRINT "HI"
20 GOSUB REGULAR: PRINT "HI"
99 END
1000 REM POKE IN THE FLASHIT
1001 REM SUBROUTINE
1002 REM
1005 POKE 1,201
1006 POKE 2,141
1007 POKE 3,208
1008 POKE 4,3
1009 POKE 5,76
1010 POKE 6,240
1011 POKE 7,253
1012 POKE 8,201
1013 POKE 9,192
1014 POKE 10,176
1015 POKE 11,6
1016 POKE 12,56
1017 POKE 13,233
1018 POKE 14,64
1019 POKE 15,76
1020 POKE 16,240
1021 POKE 17,253
1022 POKE 18,233
1023 POKE 19,128
1024 POKE 20,76
1025 POKE 21,240
1026 POKE 22,253
1030 FLASH=1050:REGULAR=1075
1049 RETURN
1050 POKE 54,1: POKE 55,0: RETURN
1075 POKE 54,189: POKE 55,158: RETURN
1099 RETURN

```

#### Listing 6

```

5 DIM MSG$(40)
6 DOSCMD=500
10 DS="": REM CONTROL-D
15 TEXT : CALL -936
20 INPUT "STARTING LINE NUMBER FOR POKES ",SPOKE
25 PRINT "STARTING LINE NUMBER FOR FLASH"
26 INPUT "SUBROUTINE ",SELASH
30 MSG$="OPEN INTEGER FLASH": GOSUB DOSCMD
35 MSG$="WRITE INTEGER FLASH": GOSUB DOSCMD
40 PRINT SPOKE;" REM POKE IN THE FLASHIT"
41 PRINT SPOKE+1;" REM SUBROUTINE"
42 PRINT SPOKE+2;" REM"
45 PRINT SPOKE+5;" POKE 1,165"
46 PRINT SPOKE+6;" POKE 2,0"
47 PRINT SPOKE+7;" POKE 3,32"
48 PRINT SPOKE+8;" POKE 4,237"

```

(continued)

Placing values other than 63, 127, or 255 into location 50 will cause some of the significant bits of the character code itself to be dropped by COUT before display. The results can be amusing. Try the program in listing 2, for example, or do a POKE 50,254 on an unsuspecting friend's Apple (be sure to stay around to undo the chaos, or you may lose a friend!).

#### Conversion Factors — Normal to Flashing

Now that we see that location 50 cannot be used to solve the problem, we shall have to find another way. We already have a machine language interface to the COUT routine, as suggested above. What we need now is an Integer BASIC routine to POKE the correct values into location 0 for each character we might wish to print. An inefficient way to do this would be to create a translation table, i.e., an array with one entry for each normal mode character (codes \$A0 to \$DF). The value stored in each array location would be the code for the corresponding flashing character. Thus, if we name the array FLASH, FLASH[1] would contain 32, FLASH[2] would contain 33, ... ,FLASH[33] would contain 64, FLASH[34] would contain 65, and so on. There is a much easier way, however.

It is based on the observation that the set of 64 characters comes in two 32 character "chunks"—space through ? and @ through \_\_. There is a fixed relationship between normal characters and their corresponding flashing equivalents in each chunk. We can deduce this relationship by comparing the codes for the first character in each chunk:

```

FLASHING space = 32
NORMAL space = 160
160 - 32 = 128
FLASHING @ = 64
NORMAL @ = 128
128 - 64 = 64

```

This tells us that the common conversion factor for space through ? is 128 and for @ through \_\_ it is 64. The code for the conversion routine then almost writes itself. Just pick off one character at a time from any string we wish to convert and feed it to the conversion factors! This is exemplified in listing 3.

To use the techniques presented so far in an Integer BASIC program, you should include the two subroutines to POKE the machine language interface (starting at line 1000 of listing 1) and to

decimate character strings [listing 3]. GOSUB 1000 should be used to initialize the interface and code such as the following:

```
MSG$ = "THIS IS A
MESSAGE!!"
GOSUB 2000
```

should be used to produce inverse messages.

### A Faster Technique — Using CSW

The Apple II Monitor kindly provides a way to augment or to totally replace the COUT (Character OUT) subroutine. The COUT subroutine begins with the instruction:

```
JMP (CSWL)
```

This indicates an indirect jump to the address stored in the Page Zero locations CSWL and CSWH [\$36,\$37]. When the Apple II is in normal screen mode, these locations contain the address of the instruction immediately following the JMP instruction itself. This means that COUT normally continues by jumping to its own code. However, since CSWL and CSWH are locations in RAM instead of ROM, any running program may replace their values at its convenience (we hope not at its peril!). This occurs, for example, when a PR#1 statement is used to select a printer for output. It also occurs each time the Apple II DOS transfers a character to the disk.

The Integer BASIC PRINT statement causes a character at a time to arrive at the portals of the COUT subroutine carried by the 6502 AC. Thus, we may assume that the accumulator is already "set up" when the JMP (CSWL) instruction is executed. How can we make use of this? We simply write a routine which checks the value of the incoming character to see if it is smaller than or larger than the @ character (code = \$C0) and convert it accordingly (as did the Integer BASIC subroutine presented earlier). One small detail—we shall have to check first for control characters, since those should not be translated. The machine language code is shown in the assembly language program of listing 4.

By POKEing this routine instead of our original one, the need is removed for the second Integer BASIC subroutine. To turn on the FLASH mode, use the statements:

```
POKE 54,1 : POKE 55,0
```

### Listing 6 (continued)

```
49 PRINT SPOKE+9;" POKE 5,253"
50 PRINT SPOKE+10;" POKE 6,96"
59 PRINT SPOKE+19;" RETURN"
100 PRINT SFLASH;" REM PRINT A FLASHING CHARACTER"
101 PRINT SFLASH+1;" REM"
105 PRINT SFLASH+5;" IF ASC(CH$)<=191 THEN POKE 0,ASC(CH$)-64"
110 PRINT SFLASH+10;" IF ASC(CH$)>191 THEN POKE 0,ASC(CH$)-128"
115 PRINT SFLASH+15;" CALL 1"
119 PRINT SFLASH+19;" RETURN"
120 MSG$="CLOSE INTEGER FLASH": GOSUB DOSCMD
125 END
500 PRINT D$;MSG$: RETURN
```

### Listing 7

```
5 DIM MSG$(40)
6 DOSCMD=500
10 D$="": REM CONTROL-D
15 TEXT : CALL -936
20 INPUT "STARTING LINE NUMBER FOR POKES ",SPOKE
30 MSG$="OPEN INTEGER FLASH2": GOSUB DOSCMD
35 MSG$="WRITE INTEGER FLASH2": GOSUB DOSCMD
40 PRINT SPOKE;" REM POKE IN THE FLASHIT"
41 PRINT SPOKE+1;" REM SUBROUTINE"
42 PRINT SPOKE+2;" REM"
45 PRINT SPOKE+5;" POKE 1,201"
46 PRINT SPOKE+6;" POKE 2,160"
47 PRINT SPOKE+7;" POKE 3,176"
48 PRINT SPOKE+8;" POKE 4,3"
49 PRINT SPOKE+9;" POKE 5,76"
50 PRINT SPOKE+10;" POKE 6,240"
51 PRINT SPOKE+11;" POKE 7,253"
52 PRINT SPOKE+12;" POKE 8,201"
53 PRINT SPOKE+13;" POKE 9,192"
54 PRINT SPOKE+14;" POKE 10,176"
55 PRINT SPOKE+15;" POKE 11,6"
56 PRINT SPOKE+16;" POKE 12,56"
57 PRINT SPOKE+17;" POKE 13,233"
58 PRINT SPOKE+18;" POKE 14,64"
59 PRINT SPOKE+19;" POKE 15,76"
60 PRINT SPOKE+20;" POKE 16,240"
61 PRINT SPOKE+21;" POKE 17,253"
62 PRINT SPOKE+22;" POKE 18,233"
63 PRINT SPOKE+23;" POKE 19,128"
64 PRINT SPOKE+24;" POKE 20,76"
65 PRINT SPOKE+25;" POKE 21,240"
66 PRINT SPOKE+26;" POKE 22,253"
67 PRINT SPOKE+30;" FLASH=";SPOKE+50;" :REGULAR=";SPOKE+75
68 PRINT SPOKE+49;" RETURN"
69 PRINT SPOKE+50;" POKE 54,1:POKE 55,0:RETURN"
70 PRINT SPOKE+75;" POKE 54,189:POKE 55,158: RETURN"
120 MSG$="CLOSE INTEGER FLASH2": GOSUB DOSCMD
125 END
500 PRINT D$;MSG$: RETURN
```

### Listing 8

```
10 TEXT : CALL -936
15 GOSUB 1000: GOSUB FLASH
20 VTAB 8
25 TAB 14: GOSUB 100
26 TAB 14: GOSUB 110
27 TAB 14: GOSUB 110
28 TAB 14: GOSUB 120
29 TAB 14: GOSUB 110
30 TAB 14: GOSUB 110
31 TAB 14: GOSUB 100
90 GOSUB REGULAR
99 END
100 GOSUB FLASH: PRINT " ";
101 GOSUB REGULAR: PRINT " ";
102 GOSUB FLASH: PRINT " ";
103 GOSUB REGULAR: PRINT " ";
104 GOSUB FLASH: PRINT " "
109 RETURN
110 GOSUB FLASH: PRINT " ";
111 GOSUB REGULAR: PRINT " ";
112 GOSUB FLASH: PRINT " ";
113 GOSUB REGULAR: PRINT " ";
```

```

114 GOSUB FLASH: PRINT " "
119 RETURN
120 GOSUB FLASH: PRINT " ";
121 GOSUB REGULAR: PRINT " ";
122 GOSUB FLASH: PRINT " "
129 RETURN
1000 REM POKE IN THE FLASHIT
1001 REM SUBROUTINE
1002 REM
1005 POKE 1,201
1006 POKE 2,160
1007 POKE 3,176
1008 POKE 4,3
1009 POKE 5,76
1010 POKE 6,240
1011 POKE 7,253
1012 POKE 8,201
1013 POKE 9,192
1014 POKE 10,176
1015 POKE 11,6
1016 POKE 12,56
1017 POKE 13,233
1018 POKE 14,64
1019 POKE 15,76
1020 POKE 16,240
1021 POKE 17,253
1022 POKE 18,233
1023 POKE 19,128
1024 POKE 20,76
1025 POKE 21,240
1026 POKE 22,253
1030 FLASH=1050:REGULAR=1075
1049 RETURN
1050 POKE 54,1: POKE 55,0: RETURN
1075 POKE 54,189: POKE 55,158: RETURN

```

#### Listing 8-B

```

10 GOSUB 1000: REM ESTABLISH FLASH COMMAND
15 GOSUB FLASH: REM TURN IT ON
18 CALL -936
19 N=1
20 FOR I=1 TO N
25 FOR I=0 TO N
30 R= RND (23)+1:C= RND (39)+1: VTAB R: TAB C: PRINT " ";
35 NEXT I
40 CALL -936
45 N=N+1: IF N=1000 THEN END
50 GOTO 20
1000 REM POKE IN THE FLASHIT
1001 REM SUBROUTINE
1002 REM
1005 POKE 1,201
1006 POKE 2,160
1007 POKE 3,176
1008 POKE 4,3
1009 POKE 5,76
1010 POKE 6,240
1011 POKE 7,253
1012 POKE 8,201
1013 POKE 9,192
1014 POKE 10,176
1015 POKE 11,6
1016 POKE 12,56
1017 POKE 13,233
1018 POKE 14,64
1019 POKE 15,76
1020 POKE 16,240
1021 POKE 17,253
1022 POKE 18,233
1023 POKE 19,128
1024 POKE 20,76
1025 POKE 21,240
1026 POKE 22,253
1030 FLASH=1050:REGULAR=1075
1049 RETURN
1050 POKE 54,1: POKE 55,0: RETURN
1075 POKE 54,189: POKE 55,158: RETURN

```

To turn it off (return to NORMAL mode), use the statements:

```
POKE 54,189 : POKE 55,158
```

Listing 5 shows the new POKE routine, together with two subroutines implementing the above switching processes. Now to turn on FLASH mode, simply say:

```
GOSUB FLASH
```

and to turn it back off, say:

```
GOSUB REGULAR
```

(Integer BASIC will not allow us to say NORMAL=1075, since the identifier NORMAL contains the reserved word OR!).

#### Putting FLASH to Work

Now that you know *how* to FLASH, you certainly will want to use it. One slightly annoying feature of this is that you must key in the subroutines before using them. The line numbers I have chosen to use, may clash with those in your program. If you have a DISK system, you can use the EXEC facility to ease the load.

Listings 6 and 7 show programs that will create textfiles containing the subroutines presented. These programs will prompt you for the desired STARTING LINE NUMBERS of the subroutines. When they finish, you should have a file called either INTEGER FLASH or INTEGER FLASH2, depending on which technique you choose to employ. To include the subroutine(s) in your program, you simply use the EXEC command. For example,

```
> LOAD MYPROGRAM
> EXEC INTEGER FLASH2
```

The EXEC command will not overwrite the program you loaded with the LOAD MYPROGRAM command, but rather add in the lines it contains, just as if you had typed them from the keyboard yourself. It's a great time saver! By this approach you are not always limited to using the same line numbers for the FLASH subroutines. Simply rerun the textfile-creating program and specify new line numbers.

#### Using the FLASH Feature in Your Programs

No doubt you already have many useful applications of the FLASH mode in titles and prompts. For your extra enlightenment, try the program of listing 8 and enjoy!

**MICRO**

# Polled Keyboard for C1P/Superboard

By continuously interrogating the keyboard it is possible to generate both upper and lower case characters on OSI's C1P/Superboard microcomputer.

Michael J. Alport  
5 Woodland Mounds Rd.  
Iowa City, Iowa 52240

I was pleased to find, in a recent issue of MICRO (22:17), an article by Edward H. Carlson describing a program which would enable the OSI keyboard to operate as an ordinary typewriter. I had been thinking of writing such a program, to be used in conjunction with a word processor, for some time, and the prospect of having a debugged program which only had to be keyed in looked attractive. My joy was short-lived, however, when I realized that Edward Carlson's program had been written for the 542 board and would not work with the 600 board found in the C1P/Superboard microcomputer. The difference between the two boards is quite simple. Instead of polling the rows/columns with a byte consisting of a combination of seven 0's and a 1, the 600 board uses a combination of seven 1's and a 0. I suspect that a simple fix would be to replace all Mr. Carlson's

STA \$DF00

and

LDA \$DF00

instructions with

JSR \$FCBE

and

JSR \$FCCF

respectively. These are monitor routines which use an EOR #\$FF to invert the bit pattern, replacing 1's with 0's and vice versa. However, it is

10	DF00=	KYPORT	=\$DF00	
20	7E00		*\$7E00	
30	7E01	XREG	**+1	
40	7E02	CTRL	**+1	
50	7E03	LOC	**+1	
60	7E03	20167E	ENTER	JSR KEYBRD
70	7E05	8D027E		STA LOC
80	7E09	202DBF		JSR \$BF2D
90	7E0C	20027F		JSR DELAY
100	7E0F	20F07E		JSR KYDONE
110	7E12	20027F		JSR DELAY
120	7E15	4C037E	LOOP	JMP ENTER
130	7E18	D8	KEYBRD	CLD
140	7E19	A2FE		LDX #254
150	7E1B	8E00DF		STX KYPORT
160	7E1E	AE00DF		LDX KYPORT
170	7E21	8E017E		STX CTRL
180	7E24	E0FE		CPX #254
190	7E26	D004		BNE CONT
200	7E28	20EDFE		JSR \$FEED
210	7E2E	60		RTS
220	7E2C	E07F	CONT	CPX #127
230	7E2E	D004		BNE NREP
240	7E30	AD027E		LDA LOC
250	7E33	60		RTS
260	7E34	E0DF	NREP	CPX #223
270	7E36	D003		BNE CHAR
280	7E38	A91B		LDA #1B
290	7E3A	60		RTS
300	7E3B	A007	CHAR	LDY #7
310	7E3D	88	ROW	DEY
320	7E3E	30D8		BMI KEYBRD
330	7E40	A207		LDX #7
340	7E42	CA	COL	DEX
350	7E43	30F8		BMI ROW
360	7E45	B9E97E		LDA MASK,Y
370	7E48	8D00DF		STA KYPORT
380	7E4B	AD00DF		LDA KYPORT
390	7E4E	DDE97E		CMP MASK,X
400	7E51	F003		BEQ CALC
410	7E53	4C427E		JMP COL
420	7E56	8E007E	CALC	STX XREG
430	7E59	A900		LDA #0
440	7E5B	18		CLC
450	7E5C	88	AGAIN	DEY
460	7E5D	3005		BMI ADDX
470	7E5F	6907		ADC #7
480	7E61	4C5C7E		JMP AGAIN
490	7E64	6D007E	ADDX	ADC XREG
500	7E67	AA		TAX
510	7E68	AD017E		LDA CTRL
520	7E6B	2906		AND #6
530	7E6D	C906		CMP #6
540	7E6F	F005		BEQ NSHIFT
550	7E71	18		CLC
560	7E72	8A		TXA
570	7E73	6931		ADC #49
580	7E75	AA		TAX
590	7E76	BD877E	NSHIFT	LDA CHARTB,X
600	7E79	AA		TAX
610	7E7A	AD017E		LDA CTRL
620	7E7D	2940		AND #40
630	7E7F	D004		BNE NCTRL
640	7E81	8A		TXA
650	7E82	0980		ORA #80

MAIN ROUTINE  
SAVE FOR RPT KEY  
PRINT CHARACTER

KEY DEPRESSED?

CHECK CTRL ROW

SAVE UNTIL LATER  
SHIFT LOCK?  
UP, CONTINUE  
DOWN

REPEAT?

NO  
RETURN WITH LAST CHARACTER

ESC?  
YES, RETURN WITH \$1B

SET UP ROW COUNT  
BEGIN ROW SEARCH  
NO CHARACTER, TRY AGAIN  
SET UP COL. COUNT  
BEGIN COLUMN SEARCH

LOAD MASK BYTE

COMPARE WITH MASK BYTE  
MATCH FOUND

SAVE COL. COUNT  
CALC. CHAR. POSITION

CHECK FOR SHIFT

NOT SHIFT  
SHIFT-ADD 49 TO CHAR. POINTER

LOOK UP CHAR. TABLE

CTRL?

NO

YES, SET BIT 7

sometimes easier to rewrite a complete program than to attempt to modify someone else's. So while I was rewriting the program, I took the opportunity to add a number of features which were not included in the original program.

The program itself should be self-explanatory, especially when read in conjunction with Mr. Carlson's article. I will, however, make a few comments about the additional features included in my program.

The shift-lock key is continually polled to determine whether it is in the up or down position. If it is in the down position, control is transferred to the normal monitor keyboard routine beginning at \$FEED. If the shift-lock is up, the new keyboard routine is executed. This makes it possible to use the new keyboard routine in conjunction with BASIC by placing the address of this keyboard routine in BASIC's input vector location.

I found it necessary to add a delay routine (in addition to the original KYDONE routine) to eliminate excessive contact bounce found on my keyboard. It may be possible to omit this routine on other keyboards.

Michael J. Alport's interest in microcomputing began about two years ago and since then he has been spending half his spare time designing a super I/O board, writing graphics software, and discovering the tremendous potential of FORTH, and the other half trying to decide why he finds microcomputing so exciting. His professional interest lies in plasma physics.

**MICRO**

```

660 7E84 60
670 7E85 8A NCTRL TXA
680 7E86 60 RTS
690 7E87 31 CHARTB .BYTE '1234567890:-','$7F,' .lo','$0A,$0D,'
690 7E88 32 690 7E92 2D
690 7E89 33 690 7E93 7F
690 7E8A 34 690 7E94 20
690 7E8B 35 690 7E95 2E
690 7E8C 36 690 7E96 6C
690 7E8D 37 690 7E97 6F
690 7E8E 38 690 7E98 0A
690 7E8F 39 690 7E99 0D
690 7E90 30 690 7E9A 20
690 7E91 3A 690 7E9B 20

700 7E9C 77 .BYTE 'wertyuisdfghjklxcvbnm,'
700 7E9D 65 700 7EA7 68
700 7E9E 72 700 7EA8 6A
700 7E9F 74 700 7EA9 6B
700 7EA0 79 700 7EAA 78
700 7EA1 75 700 7EAB 63
700 7EA2 69 700 7EAC 76
700 7EA3 73 700 7EAD 62
700 7EA4 64 700 7EAE 6E
700 7EA5 66 700 7EAF 6D
700 7EA6 67 700 7EB0 2C

710 7EB1 71 .BYTE 'gaz','$20,'/;p'
710 7EB2 61
710 7EB3 7A
710 7EB4 20
710 7EB5 2F
710 7EB6 3B
710 7EB7 70
720 7EB8 21 .BYTE '!'#$%&' , $27, '()0*-', $7F, ' >LO', $0A, $0D
720 7EB9 22 720 7EC2 2A
720 7EBA 23 720 7EC3 3D
720 7EBB 24 720 7EC4 7F
720 7EBC 25 720 7EC5 20
720 7EBD 26 720 7EC6 3E
720 7EBE 27 720 7EC7 4C
720 7EBF 28 720 7EC8 4F
720 7ECO 29 720 7EC9 0A
720 7EC1 30 720 7ECA 0D

730 7ECB 20 .BYTE ' WERTYUISDFGHJKXCVBNM<QAZ', $20, '?+P'
730 7ECC 20 730 7EDb 58
730 7ECD 57 730 7EDC 43
730 7ECE 45 730 7EDD 56
730 7ECF 52 730 7EDE 42
730 7ED0 54 730 7EDF 4E
730 7ED1 59 730 7EE0 4D
730 7ED2 55 730 7EE1 3C
730 7ED3 49 730 7EE2 51
730 7ED4 53 730 7EE3 41
730 7ED5 44 730 7EE4 5A
730 7ED6 46 730 7EE5 20
730 7ED7 47 730 7EE6 3F
730 7ED8 48 730 7EE7 2B
730 7ED9 4A 730 7EE8 50
730 7EDA 4B

740 7EE9 7F MASK .BYTE 127,191,223,239,247,251,253
740 7EEA BF
740 7EEB DF
740 7EEC EF
740 7EED F7
740 7EEE FB
740 7EEF FD
750 7EF0 A900 KYDONE LDA #00
760 7EF2 8D00DF STA KYPORT
770 7EF5 AD00DF LDA KYPORT
780 7EF8 C9FF CMP #FF
790 7EFA D001 BNE NEXT
800 7EFC 60 RTS
810 7EPD C9FE NEXT CMP #FE
820 7EFF D0EF BNE KYDONE
830 7F01 60 RTS
840 7F02 A2FF DELAY LDX #FF DEBOUNCE ROUTINE
850 7F04 A020 LP1 LDY #20
860 7F06 88 LP2 DEY
870 7F07 D0FD BNE LP2
880 7F09 CA DEX
890 7FOA D0F8 BNE LP1
900 7FOC 60 RTS

```

This issue of the Ohio Scientific Small System's Journal is devoted entirely to part two of last month's UCSD Pascal article.

## User-Defined Routines in UCSD Pascal

By D.R. Turnidge

Part one of this note introduced the use of the UCSD Pascal utility routine LIBRARY.CODE to install a unit of related procedures and functions in the system library. The unit presented in part one was extremely short and composed entirely of routines written in Pascal. This part presents a more extensive unit of routines which allow the utilization of the audio and color graphics capabilities of the C4P and C8P series of Ohio Scientific computers. This unit is based upon three 6502 assembler routines. The first two of these routines, POKEXT and PEEKEXT, are minor modifications of similar routines which appear in Appendix F of *Pascal Primer* by David Fox and Mitch Waite. We thank the SAMS publishing company for permission to include these two routines here. These routines function like POKE and PEEK in BASIC and provide access to the memory-mapped features of the C4P and C8P. The third routine named SCREXT fills the screen with a specified graphics character or color.

### Part Two—Assembler Subroutines

#### A. Creating the assembler text file PEEKPOKE

The use of the UCSD Adaptable Assembler is discussed in detail in Section 1.7 of [3]. Use the EDITOR to enter the following text and save it in a file named PEEKPOKE.TEXT. (Note: Labels must begin in column one of a source line.)

```
.....
.MACRO POP ; a macro to pull the return
PLA          ; address off the stack
STA %1
PLA
STA %1+1
.ENDM
```

```
.....
.MACRO PUSH ; a macro to push the return
LDA %1+1    ; address back on the stack
PHA
LDA %1
PHA
.ENDM
```

```
.....
.FUNC PEEKEXT,1 ; this function determines the
                ; contents of a specified memory
                ; location
RETURN .EQU 70 ; assigns the value 70 to the label RETURN
POP RETURN    ; saves return address in locations 70
                ; and 71
PLA           ; throw away four extraneous bytes of
PLA           ; data on the stack in order to get
```

```
PLA ; at function parameter
PLA
PLA          ; pull the parameter (an address) off the
STA 72      ; stack and place in locations 72 and 73
PLA
STA 73
LDY #0      ; retrieve the value currently stored
LDA @72,Y  ; at the specified memory address
TAY
LDA #0      ; place the function value (a two byte
PHA         ; integer) on the stack before returning
TYA        ; from function call
PHA
PUSH RETURN ; restore the return address to stack
RTS
```

```
.....
.PROC POKEXT,2 ; this procedure deposits a value in
                ; a specified memory location;
```

```
RETURN .EQU 70
POP RETURN
PLA          ; pull the second parameter off the stack
STA 76      ; (ignore high byte)-store at location 76
PLA
PLA          ; pull first parameter (an address) off the
STA 74      ; stack and store at locations 74 and 75
PLA
STA 75
LDY #0      ; deposit the value stored at location 76 in
LDA 76      ; the address stored in locations 74 and 75
STA @74,Y
PUSH RETURN
RTS
```

```
.....
.PROC SCREXT,2 ; this procedure fills screen with
                ; specified character or color
```

```
RETURN .EQU 70
SCRMEM .EQU 208.
COLMEM .EQU 224.
POP RETURN
LDA #0      ; store address of top of graphics
STA 77      ; memory in locations 77 and 78
LDA #SCRMEM
STA 78
PLA
BEQ SCREEN
COLOR      LDA #COLMEM ; if second parameter not zero change
STA 78      ; to address of top of color memory
SCREEN     PLA
PLA          ; first parameter contains character or
TAX         ; color number for screen fill
PLA        ; store this value in accumulator
TXA
LDX #0      ; enter loop to deposit value stored
LDY #0      ; in accumulator in 2048 consecutive
NEXTPT    STA @77,Y ; memory locations beginning at
INY        ; address stored in locations 77 and 78
CPY #0
BNE NEXTPT
INC 78 ; advance to next page of memory
INX
CPX #8      ; check to see if entire screen filled
BNE NEXTPT ; if not, continue
PUSH RETURN
RTS
.END
```

The next section shows how to assemble this source file. Before proceeding there are several observations which should be made.

CALL 1-800-321-6850 TOLL FREE

# SMALL SYSTEMS JOURNAL

1. The directives `.PROC` and `.FUNC` identify the beginning of assembly language procedures and functions, respectively. This file contains three routines. The stack is used to pass parameters and return function values. For a procedure call, the parameters are pushed on the stack (last in -first out) under the return address. For a function call, four extra bytes are placed on the stack above the parameters. These four bytes (which are of no value in this context) must be removed to gain access to the function parameters. The function value is returned to the host by placing it on the stack under the return address. The number 2 in the statement `.PROC POKEXT,2` specifies that the procedure `POKEXT` has 2 parameters.
2. The UCSD Adaptable Assembler supports macro definitions. This file contains two macros, `POP` and `PUSH`.
3. Page zero memory locations 50-7F (hex) are not reserved by the system and can be used in user-written assembler routines.

## B. Assembling the source file

The assembler is invoked by typing "A" in response to the system prompt line. In order for this selection to be valid, one of the disk drives must contain a disk that includes the files `SYSTEM.ASSMBLER` and `6500.OPCODES`. These files are located on the `PASCAL2:` disk for mini disk systems and on the standard `PASCAL:` disk for 8" systems. (Note: Section 4.2 of the *UCSD Supplemental User's Document* for Ohio Scientific users describes some alternate disk configurations for mini floppy disk users. The disk labeled #5 Disk 1 should include the file `6500.OPCODES`.)

The following steps will assemble `PEEKPOKE.TEXT` to the code file `PEEKPOKE.CODE`.

1. Use option `N(ew)` in the filer to make sure the workfile is clear. Like the compiler, the assembler uses the workfile (if one is present) as its input file.
2. Type "A" in response to the system prompt line and answer both of the queries "Assemble what text?" and "To what codefile?" by entering "PEEKPOKE".
3. If you wish the console to display an assembled listing of the program during assembly enter "CONSOLE:" in response to the prompt "Output file for assembled listing:". Otherwise just enter a carriage return.

## C. Using POKEXT, PEEKEXT and SCREXT in a Host Pascal program

The procedure and function declaration part of a Pascal program must include declarations for any assembly language routines which it uses. These declarations have the form of a procedure or function heading, followed by the keyword "EXTERNAL". The assembly routines in `PEEKPOKE` could be declared as follows:

```
PROCEDURE POKEXT(MEMLOC,DATA:INTEGER);
  EXTERNAL;
```

```
FUNCTION PEEKEXT(MEMLOC:INTEGER):INTEGER;
  EXTERNAL;
```

```
PROCEDURE SCREXT(DATA,OPTION:INTEGER);
  EXTERNAL;
```

These declarations identify these routines as assembly language routines and specify the parameters. In these procedures `MEMLOC` specifies a memory location for a `POKE` or a `PEEK`. This address must be expressed as a signed two's complement number between -32768 and 32767. For example, the address of the control register on the C4P and C8P at 56832 must be converted to -8704 = -(65536 - 56832). The parameter `DATA` in `POKEXT` denotes the value (in the range 0 - 255) which is to be stored at `MEMLOC`. `SCREXT` fills the entire screen with the graphics character corresponding to the value of `DATA` if `OPTION = 0`, otherwise it colors the entire screen with the color corresponding to the value of `DATA`. The C4P and C8P user's manuals include the appropriate character and color codes.

Before a Pascal program which uses `EXTERNAL` procedures and functions can be run, it must first be compiled. Then the `EXTERNAL` procedures and functions must be added to the code file with the `LINKER` (see section 1.6 of [3]).

The following section describes `UNIT SPECIALFEATURES` which adds these and other routines to the system library. As pointed out in part one, linking is automatic for routines placed in the system library.

## D. UNIT SPECIALFEATURES

This section includes the text for a large unit containing procedures which control the color graphics and audio features of the C4P and C8P. Use the `EDITOR` to enter this unit and store it in a file named `PLOTUNIT.TEXT`.

```
(* $L CONSOLE *)
UNIT SPECIALFEATURES;
INTERFACE
TYPE
  COLORS = ( YELLOW,INVYELLOW,RED,INVRED,GREEN,INVGREEN,
            OLIVE,INVOLIVE,BLUE,INVBLUE,PURPLE,INVPURPLE,
            SKYBLUE,INVSkyBLUE,BLACK,INVBLACK );
```

```
VAR OPTIONSET: SET OF (SOUND,KOLOR,VID32 x 32) ;
```

```
PROCEDURE POKE ( MEMLOC,DATA: INTEGER ) ;
FUNCTION PEEK ( MEMLOC: INTEGER ) : INTEGER;
PROCEDURE INITOPTIONS;
PROCEDURE SOUNDON;
PROCEDURE SOUNDOFF;
PROCEDURE COLORON;
PROCEDURE COLOROFF;
PROCEDURE SCR32 x 32;
PROCEDURE SCR32 x 64;
PROCEDURE PLOTCHARACTER ( CHARNUM,XCOORD,YCOORD: INTEGER );
PROCEDURE ERASECHARACTER ( XCOORD,YCOORD: INTEGER );
PROCEDURE PLOTCOLOR ( COLOR:COLORS; XCOORD,YCOORD: INTEGER );
PROCEDURE ERASECOLOR ( XCOORD,YCOORD: INTEGER );
PROCEDURE FILLGRAPHICS ( CHARNUM: INTEGER );
PROCEDURE CLEARGRAPHICS;
PROCEDURE FILLCOLOR ( COLOR:COLORS );
PROCEDURE CLEARCOLOR;
PROCEDURE TONE ( FREQUENCY: INTEGER );
```

## IMPLEMENTATION

```
CONST (* THESE ARE SPECIAL MEMORY ADDRESSES—
      INTEGER VALUES MUST BE EXPRESSED AS
      SIGNED TWO'S COMPLEMENT NUMBERS BETWEEN
      -32768 and 32767 *)
```

```
SCRTP = -12288;
COLORTOP = -8192;
CONTROLREGISTER = -8704;
AUDIOPORT = -8447;
```

```
VAR (* PRIVATE VARIABLES *)
  SCRLOC,COLORLOC,OPTIONCODE,XCOORD,YCOORD,
  AUDIOVALUE: INTEGER;
```

```
(* EXTERNALLY ASSEMBLED PROCEDURE *)
PROCEDURE POKEXT (MEMLOC1,DATA1: INTEGER);
EXTERNAL;
```

```
(* EXTERNALLY ASSEMBLED FUNCTION *)
FUNCTION PEEKEXT (MEMLOC2: INTEGER) : INTEGER;
EXTERNAL;
```

```
(* EXTERNALLY ASSEMBLED PROCEDURE *)
PROCEDURE SCREXT (OPTION,DATA1: INTEGER);
EXTERNAL;
```

```
PROCEDURE POKE; (* PUBLIC VERSION OF POKE *)
BEGIN
  POKEXT(MEMLOC,DATA);
END;
```

```
FUNCTION PEEK; (* PUBLIC VERSION OF PEEK *)
BEGIN
  PEEK := PEEKEXT(MEMLOC);
END;
```

```
PROCEDURE SETOPTIONS; (* PRIVATE PROCEDURE TO SET
      OPTIONS BASED UPON CURRENT
      VALUE OF OPTIONSET *)
```

```
BEGIN
  OPTIONCODE := 1;
  IF VID32 x 32 IN OPTIONSET THEN
    OPTIONCODE := OPTIONCODE - 1;
  IF SOUND IN OPTIONSET THEN
    BEGIN
      OPTIONCODE := OPTIONCODE + 2;
      POKEXT(AUDIOPORT,1);
    END;
  IF KOLOR IN OPTIONSET THEN
    OPTIONCODE := OPTIONCODE + 4;
    POKEXT(CONTROLREGISTER,OPTIONCODE);
  END;
```

```
PROCEDURE INITOPTIONS; (* PUBLIC PROCEDURE, TURNS COLOR
      OFF, SOUND OFF, AND SELECTS
      32 x 64 DISPLAY MODE *)
```

```
BEGIN
  OPTIONSET := [ ];
  SETOPTIONS;
END;
```

```
PROCEDURE SOUNDON;
BEGIN
  OPTIONSET := OPTIONSET + [SOUND];
  SETOPTIONS;
END;
```

```
PROCEDURE SOUNDOFF;
BEGIN
  OPTIONSET := OPTIONSET - [SOUND];
  SETOPTIONS;
END;
```

```
PROCEDURE COLORON;
BEGIN
  OPTIONSET := OPTIONSET + [KOLOR];
  SETOPTIONS;
END;
```

```
PROCEDURE COLOROFF;
BEGIN
  OPTIONSET := OPTIONSET - [KOLOR];
  SETOPTIONS;
END;
```

```
PROCEDURE SCR32 x 32;
BEGIN
  OPTIONSET := OPTIONSET + [VID32 x 32];
  SETOPTIONS;
END;
```

```
PROCEDURE SCR32 x 64;
BEGIN
  OPTIONSET := OPTIONSET - [VID32 x 64];
  SETOPTIONS;
END;
```

```
PROCEDURE PLOTCHARACTER; (* PUBLIC PROCEDURE, PLOTS
      SPECIFIED GRAPHICS CHAR-
      ACTER AT GIVEN SCREEN
      LOCATION *)
```

```
BEGIN
  SCRLOC := SCRTP + (31 - YCOORD)*64 + XCOORD;
  POKEXT(SCRLOC,CHARNUM);
END;
```

```
PROCEDURE ERASECHARACTER;
BEGIN
  PLOTCHARACTER(32,XCOORD,YCOORD);
END;
```

```
PROCEDURE PLOTCOLOR; (* PUBLIC PROCEDURE, PLOTS
      SPECIFIED COLOR AT GIVEN
      SCREEN LOCATION *)
```

```
BEGIN
  COLORLOC := COLORTOP + (31 - YCOORD)*64 + XCOORD;
  POKEXT(COLORLOC,ORD(COLOR));
END;
```

```
PROCEDURE ERASECOLOR;
BEGIN
  PLOTCOLOR(BLACK,XCOORD,YCOORD);
END;
```

```
PROCEDURE FILLGRAPHICS; (* PUBLIC PROCEDURE, FILLS
      ENTIRE GRAPHICS DISPLAY WITH
      SPECIFIED GRAPHICS CHARACTER *)
```

```
BEGIN
  SCREXT(CHARNUM,0);
END;
```

```
PROCEDURE CLEARGRAPHICS; (* PUBLIC PROCEDURE, CLEARS
      ENTIRE GRAPHICS DISPLAY
      AREA *)
```

```
BEGIN
  SCREXT(32,0);
END;
```

```
PROCEDURE FILLCOLOR; (* PUBLIC PROCEDURE, FILLS ENTIRE
      COLOR DISPLAY WITH SPECIFIED
      COLOR *)
```

```
BEGIN
  SCREXT(ORD(COLOR),1);
END;
```

```
PROCEDURE CLEARCOLOR; (* PUBLIC PROCEDURE, CLEARS ENTIRE
      COLOR DISPLAY AREA *)
```

```
BEGIN
  SCREXT(ORD(BLACK),1);
END;
```

```
PROCEDURE TONE; (* PUBLIC PROCEDURE, GENERATES SPECIFIED
      FREQUENCY USING TONE GENERATOR *)
```

```
BEGIN
  AUDIOVALUE :=
    (24576 + FREQUENCY DIV 4) DIV (FREQUENCY DIV 2);
  IF AUDIOVALUE > 255 THEN AUDIOVALUE := 255;
  POKE(AUDIOPORT,AUDIOVALUE);
END;
```

CALL 1-800-321-6850 TOLL FREE



# SMALL SYSTEMS JOURNAL

The following is a brief description of each of the public procedures in this unit:

1. PROCEDURE POKE (MEMLOC,DATA: INTEGER); This procedure is essentially just the assembly procedure POKEXT described above, except that POKE is a "Pascal" program while POKEXT is an assembly routine.
2. FUNCTION PEEK(MEMLOC:INTEGER): INTEGER; Same as above for PEEKEXT.
3. PROCEDURE INITOPTIONS: Initializes the options on the C4P and C8P, turns the color and sound off, and selects the 32 x 64 display mode.
4. PROCEDURE SOUNDON; PROCEDURE SOUNDOFF; Turn the sound option on and off.
5. PROCEDURE COLORON; PROCEDURE COLOROFF; Turn the color option on and off.
6. PROCEDURE SCR32 x 32; PROCEDURE SCR32 x 64; Alternate between the 32 x 32 and 32 x 64 display mode.
7. PROCEDURE PLOTCHARACTER (CHARNUM,XCOORD,YCOORD:INTEGER); Plots the graphics character corresponding to the value of CHARNUM at the screen location with coordinates (XCOORD,YCOORD) relative to the lower left hand corner of the screen.
8. PROCEDURE ERASECHARACTER (XCOORD,YCOORD); Erases the graphics character currently stored at screen location (XCOORD,YCOORD).
9. PROCEDURE PLOTCOLOR(COLOR: COLORS;XCOORD,YCOORD:INTEGER); Plots the specified COLOR at screen location (XCOORD,YCOORD). (Note: Type COLORS is an enumerated type containing the names of all the colors available on the C4P and C8P. COLOR can have values such as YELLOW, INVYELLOW, RED, etc.)
10. PROCEDURE ERASECOLOR (XCOORD, YCOORD); Erases the color currently stored at screen location (XCOORD, YCOORD).
11. PROCEDURE FILLGRAPHICS (CHARNUM:INTEGER); PROCEDURE CLEARGRAPHICS; Allow the graphics display to be filled with the graphics character corresponding to CHARNUM or to be cleared.
12. PROCEDURE FILLCOLOR(COLOR: COLORS); PROCEDURE CLEARCOLOR; Allow the entire screen to be colored the specified COLOR or changed to BLACK.
13. PROCEDURE TONE (FREQUENCY: INTEGER); Uses the tone generator to generate a tone of the specified FREQUENCY.

## E. Adding UNIT SPECIALFEATURES to the system library.

Before this unit can be added to the system library it must be compiled. This unit is fairly long and will not compile in the 48K of memory available on the C4P and C8P computers with the standard memory configuration. Section 5 of [4] describes techniques which can be used to free up more memory space. The SPECIALFEATURES unit can be compiled if the soft buffer handlers and the screen handlers are changed from memory resident to disk resident. To do this type "S" for S(ystem State in response to the command prompt line. Then enter the sequence "B","D","C","D","Q". Keyboard response following these changes is extremely sluggish, but larger programs can be compiled. (The original system state can be restored by selecting "S" and then entering the sequence "B","M","C", "M","Q".) Make these changes and then compile the contents of PLOTUNIT.TEXT to the codefile PLOTUNIT.CODE.

The utility program LIBRARY.CODE should now be used as described in part one to create a NEW.LIBRARY. This will include the contents of the current SYSTEM.LIBRARY, PLOTUNIT.CODE and PEEKPOKE.CODE. Once the NEW.LIBRARY has been created, the old SYSTEM.LIBRARY should be renamed OLD.LIBRARY, and the NEW.LIBRARY should be designated as SYSTEM.LIBRARY.

*(To be continued)*

ARE YOU STILL USING  
THE 'TIME WILL TELL'  
APPROACH TO  
SOFTWARE EVALUATION

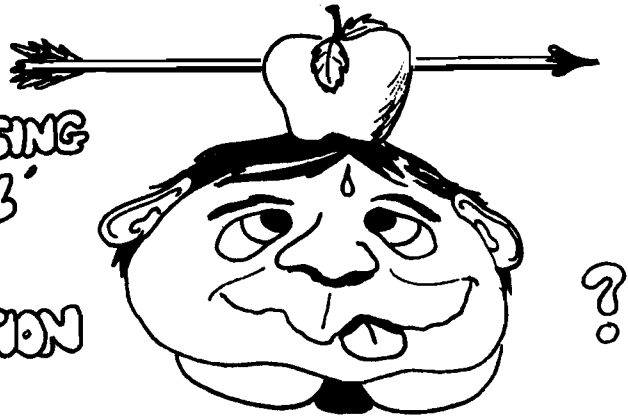

DID YOU KNOW THAT PEELINGS II...

- is devoted exclusively to reviewing software for the APPLE II ?
- contains reviews of all types of software offerings ?
- contains about 20 valuable reviews per issue ?



A mere \$15 for six issues/year\*

DEALERS INQUIRIES INVITED

\* Foreign orders add \$15 for Air Mail

## PEELINGS II

945 Brook Circle Dept. M  
Las Cruces, NM 88001  
Tel. 505 / 526-8364 · Evenings

# APPLE & PET

## MAE

The Most Powerful Disk-Based  
Macro Assembler/Text Editor  
Available at ANY Price

Now includes the Simplified Text Processor (STP)

For 32K PET, disk 3.0 or 4.0 ROMS or 8032 (specify) — OR — 48K APPLE II or APPLE II+ and DISK II

### MAE FEATURES

- Control Files for Assembling Multiple named source files from disk
- Sorted Symbol table — Up to 31 chars./label
- 27 Commands, 26 Pseudo-ops, 39 Error Codes
- Macros, Conditional Assembly, and a new feature we developed called Interactive Assembly
- Relocatable Object Code
- String search and replace, move, copy, automatic line numbering, etc.

### STP FEATURES

- 17 text processing macros
- Right and left justification
- Variable page lengths and widths
- Document size limited only by disk capacity
- Software lower case provision for APPLE II without lower case modification

### ALSO INCLUDED

- Relocating Loader
- Sweet 16 macro library for APPLE and PET
- Machine Language macro library
- Sample files for Assembly and text processing
- Separate manuals for both APPLE and PET

### PRICE

- MAE, STP, Relocating Loader, Library files, 50-page manual, diskette — \$169.95

SEND FOR FREE DETAILED SPEC SHEET

EASTERN HOUSE SOFTWARE  
3239 LINDA DRIVE  
WINSTON-SALEM, N. C. 27106

(919) 924-2889

(919) 748-8446

IF  
YOU'VE  
GOT

# OSI

NOW, GET THE

## OS-65D V3.2 DISASSEMBLY MANUAL

- 50 pages of Disassembly listings in standard Assembler format
  - Fully commented code — Not another useless program listing
  - All routines included
- PLUS,
- 10 pages of Cross Reference listings — A complete, computer-generated concordance

We have lots of other great products too, all for OSI users. Write or call today for our complete catalog. Dealer inquiries welcome.



\$24.95

7053 Rose Trail  
Memphis, TN 38134  
901/377-3503

# MICRO

## Challenges

By Paul Geffen

### OS-65D V3.2 Disassembly Manual

Software Consultants of Memphis, Tennessee, has produced one of the most useful pieces of documentation available for OSI floppy disk systems. Two perennial problems with Ohio Scientific small systems have been a poor disk operating system and poor documentation. This makes most assembly language programming very difficult. The user's manuals provide some information on how to use the DOS, but this material is scattered and sketchy, and does not give the assembler programmer what he really needs, which is a listing of the programs.

Software Consultants produces system software for OSI computers and so had to solve these problems. The result is a sixty-page book which contains a complete source for the kernel of OS-65D [not disk BASIC or the Assembler-Editor-Debugger]. They claim to have spent 500 hours disassembling and studying this program, and the results were worth the effort. This disassembly is well commented and includes a cross-referenced symbol table.

Now a programmer can interface his own software directly to the DOS without having to spend weeks searching and deciphering the often mysterious techniques used in OS-65D. I feel that the availability of this information enhances the value of OSI small systems by allowing more powerful and efficient software to be written for these machines. This book is not, and does not claim to be, a guide to the DOS or an overview of it. It is only a listing of the source code for the program.

Software Consultants markets the following software for OSI disk systems: a cross-reference utility for BASIC programs, a Spooler/Despooler utility, a FIG Forth and a video routine. All run under OS-65D and/or other operating systems, and source code is available for all products.

### Extended Monitor ROM for Superboard and C1P

The system monitor which OSI provides with the 600 board is a "glass teletype" program which doesn't even backspace. This seems out of place on a video-based machine where it would be nice to be able to move the cursor around and edit lines. And the machine level support is limited to five commands [Address mode, Data mode, Increment address, Load from tape and Go]. This is only a little more useful than a programmer's panel consisting of lights and switches. Of the various alternatives available from independent sources, the only one I have tried is the BUSTEK Extended Monitor.

This is a 2K ROM which provides enhanced machine level support as well as a screen editor. The eleven machine level commands include Save to tape, Load from tape, Output (sets the save flag), Input (sets the load flag), Go, Register display, a block move, commands to display a block of memory on the screen, and load memory from the screen, and a hexadecimal calculator.

The screen editor provides a window, which allows portions of the screen to be protected from being overwritten or scrolled. The shift keys work normally as does the RUBOUT key. The REPEAT key allows data to be read from the screen into the BASIC input buffer. ESCAPE codes provide cursor up, down, left, right and home as well as clear to end of line and clear to end of screen.

Control characters move the cursor to the beginning or end of a line, insert or delete characters, cancel line and provide a graphics mode, a find character function and a pause during output.

The program does have a few problems. The most serious is the fact that there is no disk bootstrap. It was left out to make room for the extended monitor functions. This ROM can be used only on cassette-based systems. Also, the delete character function assumes a 72-character line and is meant to be used only on the last line of the display. And the insert character key can overflow the input buffer and cause the system to crash. These problems are all due to lack of space — the ROM is entirely filled with code.

The documentation for this product is very good. The 19-page user's manual contains complete operating

instructions with numerous examples. In addition, it includes the addresses of 22 subroutines within the monitor and a map of the memory it uses. A complete source listing is available at extra charge. This listing has few comments and no cross-reference table.

Other monitor ROMs with improved features include the C1E and C1S ROMs from Aardvark, as well as a monitor ROM by David Anear which is available from OMEGA, an OSI user's group in Australia.

OMEGA publishes a newsletter with much hardware and software advice as well as short programs. The 81/1 issue contained OS65D notes, a single drive copier in BASIC, a batch mode program which puts a series of commands in memory and then executes them, and a program to allow named cassette files. Subscriptions are \$6/year surface and \$12 air mail. For more information, contact:

Geoff Cohen  
72 Spofforth St.  
Holt, ACT, 2615  
Australia

The following user's groups have recently sent me newsletters and other information.

The Boston Computer Society has an *OSI User's Group* which meets on the third Thursday of each month at the Polaroid cafeteria in Cambridge, near MIT. Their newsletter is now five issues old and appears monthly. Write to Len Magerman, Dept. 761, 565 Tech Square - 5A, Cambridge, MA 02139 for more information.

About a year old, the *OSI North Coast User's Group*, OSINC, based in the greater Cleveland area, has formal ties with Ohio Scientific. The second issue of their newsletter contains a short "dumb" terminal program for the C4P by Aurora Software Associates. Contact President Lel Somogyi, OSINC, Three King James South, Suite 140, 24600 Center Ridge Road, Westlake, Ohio 44145. Membership is \$20 for one year.

*Ohio Scientific Users of New York* (OSUNY) publishes OSI-tems, now in its fourth year, and one of the largest OSI newsletters. Their recent special hardware issue ran thirty pages. Write to Tom Cheng, 26 Madison St., Apt. 41, New York, New York 10038 for more information.

# consumer computers

formerly Computers 'R' Us

We accept these major credit cards:



# mail order

TELEX 695-000 Ans. "Beta" Attn. "COMO"

**OPEN EVERY DAY 9 to 6 PST**

California, Alaska & Foreign orders  
Shipping Information or Backorders call  
Service Center and for Technical Information

(714) 698-8088  
(714) 698-0260  
(714) 460-6502

**ORDER TOLL FREE**  
**800-854-6654**



ALL EQUIPMENT IS  
FCC APPROVED



APPLE II PLUS 16K ..... 1049  
APPLE II PLUS 48K  
(APPLE Memory) ..... 1189  
APPLE II Standart Models... CALL  
DISK II DRIVE & CONTROLLER. 529  
This model includes DOS 3.3 16 sector

**TOP FIVE SELLERS**

Language System W/Pascal ..... 425  
Silentype Printer W/Interface ..... 549  
Hayes Micromodem II ..... 319  
Videx Videoterm 80 w/graphics ..... 335  
Z-80 Microsoft Card ..... 299

**APPLE COMPUTER INC.**

Disk II Drive Only ..... 445  
Integer or Applesoft II Firmware Card ..... 155  
Graphics Tablet ..... 649  
Parallel Printer Interface Card ..... 155  
Hi-Speed Serial Interface Card ..... 155  
Smarterm 80 Column Video Card ..... 335

**MOUNTAIN COMPUTER INC.**

Music System (16 Voices) ..... 479  
A/D + D/A Interface ..... 319  
Expansion Chassis ..... 555  
Introl/X-10 System ..... 249  
Clock/Calendar Card ..... 239  
Supertalker SD-200 ..... 249  
Romplus+ Card ..... 135  
Romwriter Card ..... 155

**CALIFORNIA COMPUTER SYSTEMS**

Clock/Calendar Module ..... 109  
GPiB IEEE-488 Card ..... 259  
Asynchronous Serial Interface Card ..... 129  
Centronics Parallel Interface Card ..... 99  
We carry all CCS hardware. Please call

**MISC. APPLE HARDWARE**

16K Ram Card Microsoft ..... 189  
ADT Numeric Keypad (old or new hybrid) ..... 115  
ALF 3 Voice Music Card ..... 229  
Alpha Synkain Keyboard System ..... 1399  
Corvus 10MB Hard Disk ..... CALL  
Lazer Lower Case Plus ..... 50  
Micro-Sci Disk Drives ..... CALL  
SSM AIO Serial/Parallel Card AGT ..... 189  
Sup-R-Terminal 80 Col. Card ..... 339  
SVA 8 inch Floppy Disk Controller ..... 345  
Versawriter Digitizer Pad ..... 229

**WE HAVE MANY MORE ACCESSORIES  
FOR THE APPLE II IN STOCK—  
PLEASE CALL OR WRITE FOR A PRICE LIST.**



ATARI

MODEL  
**800 16K**  
**\$799**



Atari 400 16K ..... 499  
810 Disk Drive ..... 499  
410 Program Recorder ..... 69  
850 Interface Module ..... 175  
822 Thermal Printer (40 col) ..... 369  
825 Printer (80 col) ..... 795  
Atari 16K Ram Module ..... 155  
Atari Light Pen ..... 65

**We stock all Atari accessories &  
software, please call for more info.**

## PRINTERS

Anadex DP-9500 W/2k Buffer ..... 1375  
Anadex DP-9501 W/2K Buffer ..... 1450  
C. Itah Stowriter 25 CPS ..... 1750  
C. Itah Stowriter 45 CPS ..... 2450  
Centronics 737 ..... 825  
Epson MX-70 W/Graphics ..... 449  
Epson MX-30 132 Col. ..... 620  
Paper Tiger IDS-445 W/Dat Plat. .... 749  
Paper Tiger IDS-460 W/Dat Plat. .... 1195  
Paper Tiger IDS-560 W/Dat Plat. .... 1495  
Qume Sprint 5/45 Daisywheel ..... 2550  
Silentype w/Interface for Apple II ..... 549  
Watrobe Digiplat ..... 1295

## VIDEO MONITORS

Amdex/Leedex Video-100 12" BGW ..... 139  
Hitachi 13" Color ..... 389  
NEC 12" P31 Green Phosphor ..... CALL  
Panacolor 10" Color ..... 375  
Sonya 9" IGW ..... 179  
Sonya 12" BGW ..... 255  
Sonya 12" P31 Green Phosphor ..... 295  
Sonya 13" Color ..... 445

## OHIO SCIENTIFIC

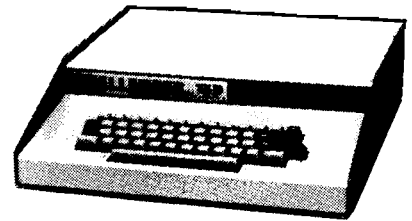

Challenger 4P ..... 699  
C4PMF (Mini Floppy System) ..... 1599  
CIP Model II ..... 449  
Sargon II (Disk or Cassette) ..... 35  
Fig Forth (Disk Only) ..... 69

## APPLE SOFTWARE

DOS Toolkit ..... 65  
Appletot ..... 60  
Tax Planner ..... 99  
Apple Writer ..... 65  
Apple Past ..... 45  
D.J. Portfolio Evaluator ..... 45  
D.J. News & Quotes Reporter ..... 85  
Apple Fartran ..... 165  
Apple Pilot ..... 129  
DOS 3.3 Upgrade ..... 49  
Music Theory ..... 45  
The Controller Bus Sys ..... 519

**MISC. APPLICATIONS PACKAGES**

Visicalc ..... 125  
Desktop Plan II ..... 169  
CCA Data Management DMS ..... 85  
Easywriter Word Processor ..... 225  
ASCII Express ..... 65  
Super Text II ..... 139  
Programma Apple Pie ..... 119  
The Landlord Apt. Mgmt. Pkg. .... 649  
Peachtree Business Software ..... CALL  
Tax Preparer by HowardSoft ..... 89  
Applebug Assem/Disasm/Editor ..... 75  
3-D Graphics by Bill Dudge ..... 53

**GAMES**

Flight Simulator ..... 34  
The Wizard and The Princess ..... 32  
Cosmos Mission (Space Invaders) ..... 24  
Sargon II Chess ..... 32  
Hi-Res Football ..... 39  
Adventure by Microsoft ..... 27  
Phantoms Five ..... 39  
Reversal (Orthello) ..... 34

**PLEASE CALL OR WRITE  
FOR A COMPLETE  
SOFTWARE LIST.**

ORDERING INFORMATION: Phone Orders invited using VISA, MASTERCARD, AMERICAN EXPRESS, DINERS CLUB, CARTE BLANCHE, or bank wire transfer. Credit cards subject to service charge: 2% for VISA & MC, 5% for AE, DC & CB. Mail Orders may send credit card account number (include expiration date), cashiers or certified check, money order, or personal check (allow 10 days to clear). Please include a telephone number with all orders. Foreign orders (excluding Military PO's) add 10% for shipping all funds must be in U.S. dollars. Shipping, handling and insurance in U.S. add 3% (minimum \$4.00). California residents add 6% sales tax. We accept COD's under \$500. OEM's, Institutions & Corporations please send for written quotation. All equipment is subject to price change and availability without notice. All equipment is new and complete with manufacturer warranty (usually 90 days) We cannot guarantee merchantability of any products. We ship most orders within 2 days.

**WE ARE A MEMBER OF THE BETTER BUSINESS BUREAU AND THE CHAMBER OF COMMERCE  
SHOWROOM PRICES MAY DIFFER FROM MAIL ORDER PRICES.**

**PLEASE SEND ORDERS TO:**

**CONSUMER COMPUTERS MAIL ORDER 8314 PARKWAY DRIVE, GROSSMONT SHOPPING CENTER NORTH LA MESA CALIF. 92041**

# AIM 65 RS-232 Interface

An optoisolated full duplex 20mA to RS-232 interface board is available, which can easily be installed with the addition of a  $\pm 12$  VDC source. Electrical connection to/from a standard RS-232 connector is shown, and several hardware and software possible problem areas are discussed.

James Guilbeau  
6644 Louis XIV Street  
New Orleans, Louisiana 70124

The AIM 65 computer can easily be adapted to add an RS-232 data interface at the 20 mA teletype connections. This will allow two-way data communication (without handshaking signals) for a total cost of about \$25. A  $\pm 12$  VDC supply is required as well as four wires to the application connector J1. If the AIM already has  $\pm 12$  VDC, and if a 20 mA teletype would never be used, the data interface board (1½ inches square) can be mounted internally with seven wires soldered directly to the computer board.

A duplex RS-232 interface (data in/out only) can be added to the J1 application TTY connections without modification of the computer. The baud rate is selectable from as low as 110 to as high as 2400 baud. The computer can determine and save the baud rate automatically, on initialization of TTY port, with a series of delete or rubout characters.

The baud rate can also be manually set by loading hex locations \$A417 (baud rate) and \$A418 (delay) as described in the AIM 65 computer manual. However, the baud rate can be reset under program control if incoming data on the serial TTL port was also initiated by the program. At any one time both the serial TTL/RS-232 and the 20 mA TTY/RS-232 are at the same baud rate.

Table 1: Connection Table

	AIM 65	7901A	RS-232
	-J1		
-12V	22	1	-
+12V	N	2	-
Printer	U	4	-
Keyboard	T	6	-
Printer			
+5V	S	7	-
Keyboard			
+24V	R	8	-
Ground	1	10	7 return
Data in	-	9	3 receive
Data out	-	3	2 transmit

EIA standard RS-232-C provides the electronics industry with the ground rules necessary for independent manufacturers to design and produce both data terminal and data communication equipment that conforms to a common interface requirement. As a result, a data communications system can be formed by connecting an RS-232-C data terminal to an RS-232-C data communication peripheral (such as a TTY, MODEM, computer, etc.)

The RS-232-C is a hardware standard which guarantees the following:

1. Each device on RS-232-C will use a standard 25-pin connector which will mate to another standard 25-pin of opposite sex.
2. No matter how the cables are connected, no smoke or damage will occur.
3. The data and handshake lines will each be given a specific name.
4. The RS-232-C standard calls out the interface on one end of the cable to be designated as a "Terminal" and the interface on the other end is "Data Communication Equipment." The standard defines the data handshake signals on each pin of the con-

connector for the "Data Communication Equipment" and the "Terminal."

RS-232-C terminals and data communications equipment are not always hardware compatible. For example, the two instruments must share one of the features from each of the following characteristics:

1. Timing Format—asynchronous.
2. Transmission Mode—Simplex, (serial input) or full duplex (TTY I/O).
3. Baud Rate (bits per second)—110, 150, 300, 600, 1200.
4. Bits per character (7), bits per word (11).
5. Parity Bit—low (not used).

EIA voltage levels are: 1, mark, or OFF = -25 to -3 VDC; 0, space, or ON = +3 to +25 VDC.

In serial communications, data signals usually come from one pair of lines: additional lines sometimes provide controller handshake or busy signal—used to delay data transmission until the device can handle that data. The data and handshake lines in RS-232-C send information uni-directionally (simplex); that is, one end of a cable transmits data or handshake and the other end receives data or handshake. Care must be taken to insure that each wire in RS-232-C has the appropriate transmitter and receiver combination. Transmitters connected to transmitters, and receivers connected to receivers, provide no data communication.

To alleviate this problem, care must be taken to ensure that the RS-232-C cable is correct for the application. One of the ambiguous areas in an RS-232-C connection is the use of pin 2 for transmitted data (TD) and pin 3 for received data (RD). The confusion

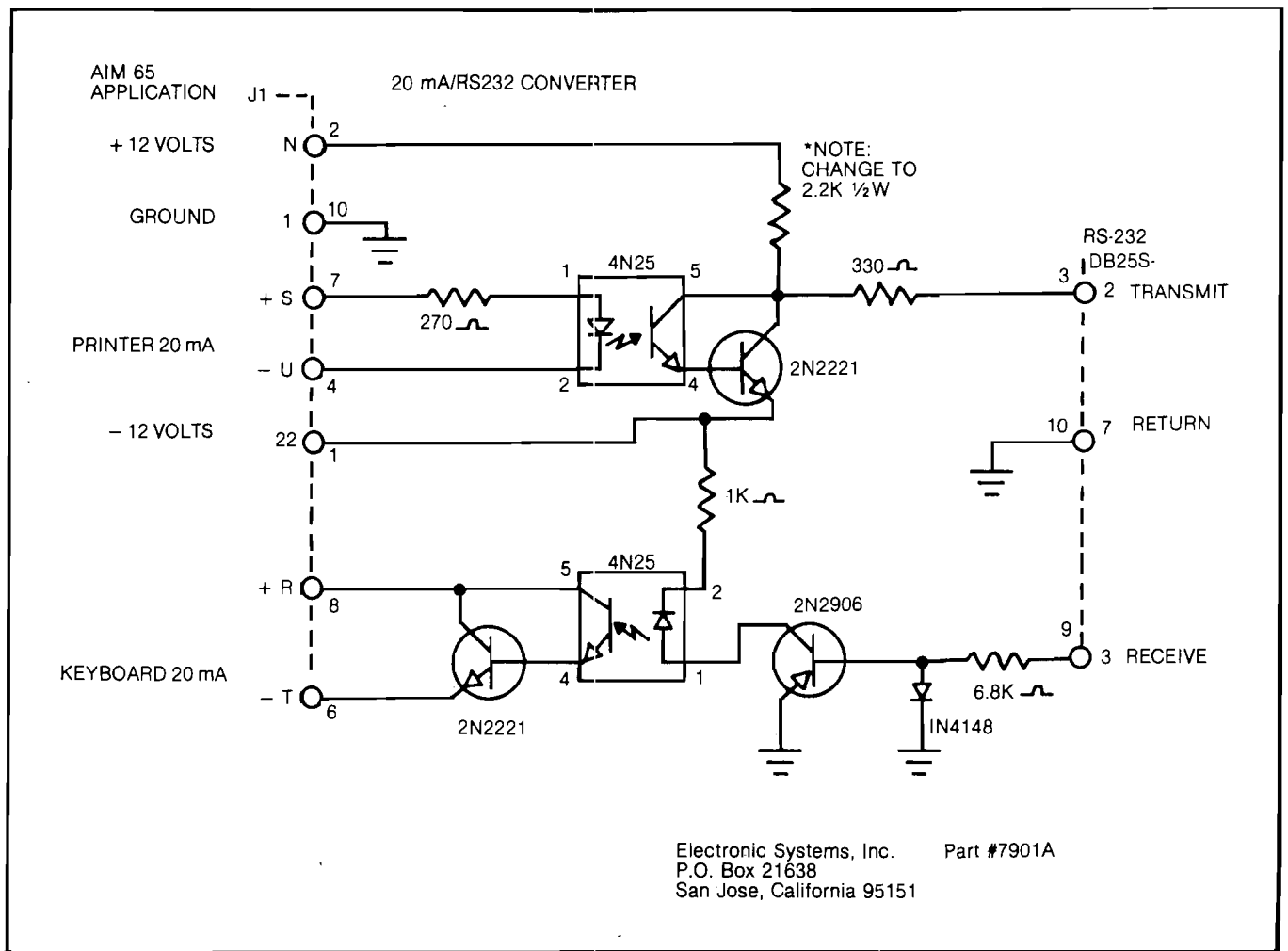

arises in a simplex or half-duplex connection, where pin 2 at one end of the line must go to pin 3 at the other end, and vice versa; this pin transposition can be handled in the cable itself or at either connector.

**RS-232-C Cable Application Compatibility Test:** Measure voltage at pins 2 and 3 with ground lead connected to pin 7.

**Perform Test With No Cables Connected:**

"TERMINAL" (AIM 65),  
pin 2 < -3V Pin 3 0 to +2V  
pin 7 GROUND.

"DATA COMMUNICATIONS DEVICE" (MODEM),  
pin 2 0 to +2V pin 3 < -3V  
pin 7 GROUND.

If the computer is going to be used with various kinds of equipment, such as a printer, a modem or another computer, a double-pole, double-throw (DPDT) switch can be installed from

pins 2 and 3 to reverse the data connections for the specific application.

This RS-232 installation has no provision for the "handshake" lines such as Clear to Send, Data Set Ready, Busy, etc. If these lines cannot be ignored or by-passed, an additional TTL/RS-232 interface can be used with a Peripheral Interface Adapter (PIA) and an assembly language routine to recognize the signals.

This works fine on paper. However, in practice, the user must be aware of the subtleties of serial binary data interchange to ensure that any two pieces of RS-232-C equipment will be compatible.

There are no software standards associated with RS-232-C. Many types of communication protocols serve RS-232-C systems. One protocol uses USASCII code STX (start of text) to precede data and ETX (end of text) to follow data transmission. Another uses USASCII ACK to acknowledge message receipt, and NAK to indicate no acknowledgement. This ACK/NAK

combination is usually found in polling computer configurations. (STX, ETX, ACK and NAK are nonprinting characters, for "handshaking" or control only.)

20 mA/RS-232 optoisolated adapter with parts costs \$15.00 (7901A) from Electronic Systems, P.O. Box 21638, San Jose, CA 95151. Not included:

- |                           |       |
|---------------------------|-------|
| 10 contact PC connector:  | Cinch |
| 50-10A-20 \$3.00 (#10P)   |       |
| 25 contact RS-232 female: | Cinch |
| DB25S \$5.50              |       |
| Locking screws (2 each):  | Cinch |
| D20418-2 60¢              |       |

For receiving RS-232 data only, a TTL/RS-232 adapter can be connected to the serial TTL input. TTL/RS-232 adapter with parts costs \$10.00 (#232 A).

Note: Portions of the above discussion were extracted from John Fluke Mfg. Co. application bulletin #B0101. Used with permission.

**MICRO**

# Real Time Clock for Superboard

By providing a brief pulse once each second to the Superboard and implementing this short program, the computer will maintain and display real time in a background mode.

James L. Mason  
34 Farmington Drive  
Jacobus, Pennsylvania 17407

After receiving a fuel oil bill for heating my home, I decided to monitor how long my furnace ran, the outside temperature, and the inside temperature. By taking the average temperature difference between inside and outside, and knowing how long the furnace ran over a 24 hour period (therefore the quantity of oil consumed), I could determine the heat loss of my house. I could then compute the cost effectiveness of different means to reduce heat loss.

I wanted the computer to monitor all these parameters and, therefore, I needed two temperature sensors with A/D converters and a real time clock by which the computer could keep track of elapsed time. My main program would run in BASIC for ease of number crunching, while the real time clock would run in the background. In order to accomplish this, the Real Time Clock [RTC] software would be interrupt driven.

My first task was to figure out how to interrupt the Superboard. OSI's documentation did not tell me how to do this, so I turned to MOS Technology's 6500 programming and hardware manuals. These books are extremely well written and I consider them essential for truly understanding how the computer works.

Applying a low true interrupt pulse to the Superboard's IRQ input is done at pin 2 of the expansion connector, J1.

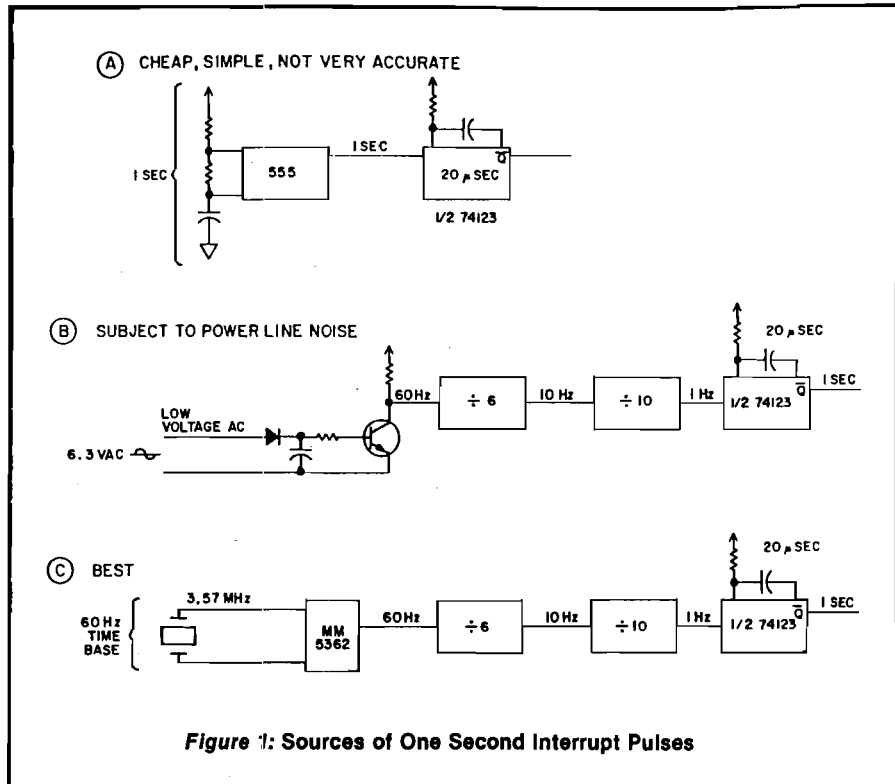

Figure 1: Sources of One Second Interrupt Pulses

The pulse must be long enough so that the processor will detect the interrupt, yet shorter than the interrupt routine so that the routine won't be executed twice for the same pulse. I chose a pulse width of 20 microseconds, which was generated by one-half of a 74123 one-shot. Ballpark values for the resistor and capacitor are 20K and .002 uf respectively. I triggered the one-shot at one second intervals. See figure 1 for possible sources.

At this point if you attempt to interrupt the processor through the IRQ input, nothing will happen. This is because after a restart (whenever the "BREAK" key is pressed), initialization of 6502 automatically masks out the IRQ pin by setting the interrupt disable bit. We must clear this bit to

use the IRQ input. This is done by executing the machine language instruction \$58 (clear interrupt disable). I did this from BASIC by means of a USR function to call the short machine language subroutine:

LOCATION	HEX CODE	MNEMONIC
0900	58	CLI
0901	60	RTS

The USR vector is defined by the contents of locations 11 and 12 (decimal), therefore location 11 was POKEd with 0 and location 12 was POKEd with 9. Now upon execution of the BASIC instruction, X = USR(X), a low pulse applied to the IRQ pin will cause an interrupt. But to where? The IRQ vector is stored in ROM and therefore could not be changed to point directly to my RTC

subroutine. However, the vector does point to a location in RAM in page one of memory that was unused according to the IP memory map. The IRQ vector points to location \$01C0, so in \$01C0, \$01C1, and \$01C2 I POKEd a machine code instruction which causes an unconditional jump to my program:

LOCATION	HEX CODE	MNEMONIC
01C0	4C	JMP
01C1	02	(lo byte)
01C2	09	(hi byte)

To use BASIC to install this:

```
POKE 448,76
POKE 449, 2
POKE 450, 9
```

Next, I wrote the machine language program which acted like a "software" counter (see figure 2). Every time the subroutine is called, a memory location representing the number of least significant seconds is incremented. If the least significant seconds' amount becomes greater than an ASCII 9 [\$39], the most significant will be incremented and tested for an ASCII 6 [\$36] and on down the line, thus forming a 24-hour software clock.

I thought it would be nice to have the time constantly displayed on the screen, but what about scrolling? If you put anything in video memory, it gets scrolled up the screen whenever a carriage return is performed. Luckily, the last line of the screen does *not* get scrolled. So I put the clock [6 digits plus 2 colons] in the last 8 locations of video memory.

Whenever entering an interrupt routine, it is good practice to save the working registers, execute the interrupt routine, restore the registers and finally return from the interrupt. I chose to push the registers [A, X, Y] on the stack. The return address and processor status are automatically saved by the 6502.

To put it all together, I used BASIC to load the machine code by reading a data file and POKeIng. To set my USR and interrupt vectors POKeIng was used again. A BASIC INPUT command was used to obtain the correct time and the hours, minutes and seconds were then POKEd into the video locations. Finally, the USR function would be executed to enable the interrupts to take effect. See figure 3.

After running the BASIC real time clock program and the time is satisfac-

Figure 2: Machine Language Routine.

```

0800 ;*****
0800 ;*
0800 ;* REAL TIME CLOCK *
0800 ;* INTERRUPT SUBROUTINE *
0800 ;* FOR OSI SUPERBOARD *
0800 ;*
0800 ;* BY JIM MASON *
0800 ;*
0800 ;*****
0800 ;*
0800 ZERO EPZ $30
0800 SIX EPZ $36
0800 COLON EPZ $3A
0800 FOUR EPZ $34
0800 TWO EPZ $32
0800 ;
0800 LSS EQU $D39B
0800 MSS EQU $D39A
0800 LSM EQU $D398
0800 MSM EQU $D397
0800 LSH EQU $D395
0800 MSH EQU $D394
0800 ;
0900 ; ORG $900
0900 ; OBJ $800
0900 ;
0900 58 ; IRQEN CLI ;CLEAR INTERRUPT DISABLE BIT
0901 60 ; RTS
0902 ;
0902 48 ; START PHA
0903 8A ; TXA
0904 48 ; PHA
0905 98 ; TYA
0906 48 ; PHA
0907 A93A ; LDA #COLON
0909 A236 ; LDX #SIX
090B A030 ; LDY #ZERO
090D EE9BD3 ; INC LSS ;INCREMENT SECONDS
0910 CD9BD3 ; CMP LSS ;TEST FOR >9
0913 D048 ; BNE RETURN
0915 8C9BD3 ; STY LSS ;SET LSS TO ZERO
0918 EE9AD3 ; INC MSS ;INCREMENT TENS/SECONDS
091B EC9AD3 ; CPX MSS ;TEST FOR =6
091E D03D ; BNE RETURN
0920 8C9AD3 ; STY MSS ;SET MSS TO ZERO
0923 EE98D3 ; INC LSM ;INCREMENT MINUTES
0926 CD98D3 ; CMP LSM ;TEST FOR >9
0929 D032 ; BNE RETURN
092B 8C98D3 ; STY LSM ;SET LSM TO ZERO
092E EE97D3 ; INC MSM ;INCREMENT TENS/MINUTES
0931 EC97D3 ; CPX MSM ;TEST FOR =6
0934 D027 ; BNE RETURN
0936 8C97D3 ; STY MSM ;SET MSM TO ZERO
0939 EE95D3 ; INC LSH ;INCREMENT HOURS
093C A234 ; LDX #FOUR
093E EC95D3 ; CPX LSH ;TEST FOR =4
0941 F00D ; BEQ HRS20
0943 CD95D3 ; HRDD CMP LSH ;TEST FOR >9
0946 D015 ; BNE RETURN
0948 8C95D3 ; STY LSH ;SET LSH TO ZERO
094B EE94D3 ; INC MSH ;INCREMENT TENS/HOURS
094E 100D ; BPL RETURN
0950 A232 ; HRS20 LDX #TWO
0952 EC94D3 ; CPX MSH ;TEST FOR =2
0955 D0EC ; BNE HRDD
0957 8C95D3 ; STY LSH ;SET LSH TO ZERO
095A 8C94D3 ; STY MSH ;SET MSH TO ZERO
095D 68 ; RETURN PLA
095E A8 ; TAY
095F 68 ; PLA
0960 AA ; TAX
0961 68 ; PLA
0962 60 ; RTS ;DONE

```

torily ticking away, you can do a "NEW" command. The RTC will remain in the background while you write or execute new BASIC programs.

I have found three distinct problems of concern when using the present configuration: First, since the machine language program is in RAM, it is possible for it to be overwritten as BASIC consumes more and more workspace. To prevent this, limit your BASIC

memory size during the cold start. Second, recall that when the "BREAK" key is pressed, the interrupt disable flag will be set and your display cleared. Therefore, if you hit BREAK you must re-enable the interrupts, as described above.

Lastly, the target of the IRQ vector (\$01C0) is in the same page of memory as the stack. I have written BASIC algorithms of such complexity that the



Figure 3: BASIC Listing of Real Time Clock Program.

```
2 REM REAL TIME CLOCK
5 REM BY JIM MASON
10 FOR X = 2304 TO 2402
20 READ A
30 POKE X,A
40 NEXT X
50 POKE 448,76: POKE 449,2: POKE 450,9
60 POKE 11,0: POKE 12,9
70 FOR X = 0 TO 32: PRINT : NEXT X
80 PRINT "ENTER TIME (24 HR. FORMAT)": PRINT
90 INPUT "HH,MM";H$,M$
100 FOR X = 0 TO 32: PRINT : NEXT X
110 POKE 54169,58: POKE 54166,58
120 H1$ = LEFT$(H$,1):H1 = ASC (H1$): POKE 54164,H1
130 H2$ = RIGHT$(H$,1):H2 = ASC (H2$): POKE 54165,H2
140 M1$ = LEFT$(M$,1):M1 = ASC (M1$): POKE 54167,M1
150 M2$ = RIGHT$(M$,1):M2 = ASC (M2$): POKE 54168,M2
160 POKE 54170,48: POKE 54171,48
170 X = USR (X)
180 END
190 DATA 88,96,72,138,72,152,72,169,58,162,54,160,48,238,155
200 DATA 211,205,155,211,208,72,140,155,211,238,154,211,236,154,211
210 DATA 208,61,140,154,211,238,152,211,205,152,211,208,50,140,152
220 DATA 211,238,151,211,236,151,211,208,39,140,151,211,238,149,211
230 DATA 162,52,236,149,211,240,13,205,149,211,208,21,140,149,211
240 DATA 238,148,211,16,13,162,50,236,148,211,208,236,140,149,211
250 DATA 140,148,211,104,168,104,170,104,64
```

stack wrote into \$01C0, resulting in a total system crash. Keep equations to a reasonable size or better yet, burn a new monitor ROM so that the IRQ vector points directly to the RTC interrupt subroutine. I have used the second approach with great success.

But on the good side, the time can be modified simply by POKEing the appropriate ASCII value into the proper video location. The time can be read by a BASIC program PEEKing the proper video locations. Cassette loads and saves are not affected since the interrupt subroutine is much shorter than one bit time at 300 baud.

The machine language program is relocatable if you wish to move it to a higher memory location or burn it into a ROM and stick it in the upper 32K as I did. Just remember to adjust your IRQ and USR vectors.

*Editor's Note:* On the AIM 65, the IRQ interrupt vector at \$A400 can be used to point to a user routine like this clock. The corresponding vector on the new PET/CBM is at \$0090, and on the old, \$0219.

James L. Mason is currently an Electronic Engineer employed by Galt Controls. At home, he is continually developing software and hardware for the Superboard II for application as a residential utility management system.

MICRO

## New Publications

(Continued from page 39)

### Software

**Computer Language Reference Guide With Keyword Dictionary** by Harry L. Helms, Jr. Howard W. Sams & Co., Inc. [4300 West 62nd Street, Indianapolis, Indiana 46268], 1980, 110 pages, 5-3/8 x 8 1/2 inches, paper-bound.

ISBN: 0-672-21786-4 \$6.95

Rather than a fast guide to learning how to program in the various computer languages, this book is a "phrase book" for the "traveler" who is outside the programming language he or she normally uses. The book assumes a working knowledge of one of the programming languages and familiarity with basic computer concepts.

CONTENTS: ALGOL (9 pages); BASIC (15); COBOL (11); FORTRAN (13); LISP (6); Pascal (11); PL/1 (11); Keyword Dictionary (21).

**Software Vendor Directory** by Micro-Serve, Inc. [250 Cedar Hill Avenue, Nyack, New York 10960], 1981, 196 pages, 8 1/4 x 11 inches in standard,

hardcover, 3-ring binder. This directory of microcomputer software companies, now in its fourth edition, contains 950 software vendors and 4,195 products indexed by 200 software and 80 hardware categories. The directory lists software vendors by name, address, and telephone number and by available software. For cross reference purposes, the editors have assigned each software and hardware vendor a number and each type of software a 3-letter code. The user of the directory can begin at either the chip or hardware level and quickly determine who produces applicable hardware, operating systems, programming software, applications software, books, and periodicals. Or he can turn to the name of a software vendor and learn what type of software the vendor offers and how to reach the vendor. Products are only listed and categorized but not otherwise described. There are no advertisements. For descriptions and purchasing information, a user must call or write the vendor. The directory is updated twice a year (completely reprinted). By itself, it sells for \$57.95. With one update, it costs \$82.95 and with two, \$100.00.

**1981 Software Writers Market: 1800 places to sell your software** by Kern Publications [190 Duck Hill Road, P.O. Box 1029, Duxbury, Massachusetts 02332], 1981, iii, 180 pages, 8 1/2 x 11 inches, cardstock cover with plastic comb binding.

\$45.00

This directory of firms which market and distribute software is designed for the independent software producer looking for a "publisher" or distributor. For each type of distributor, the editors provide information on how the distributor markets software, what kinds are wanted, and how the distributor deals with independent software producers. Where available, royalty rates and contract details are listed. Names, addresses, and telephone numbers of key decision-makers are given for each distributor, except for the final lengthy section in which computer stores are listed by state. For these, only the business name and address is provided.

CONTENTS: Service Bureaus (18 pages); Consulting Companies (16 pages); Hardware Manufacturers (34); Mail order Distributors (24); Book Publishers (14); Computer Magazines (10); Computer Stores (62).

# MICRO

## Resource Update

Dr. William R. Dial  
438 Roslyn Avenue  
Akron, Ohio 44320

Did you ever wonder just what magazines are rich sources of information on the 6502 microprocessor, 6502-based microcomputers, accessory hardware and software? For several years I have been assembling a bibliography of 6502 references related to hobby and small business systems. The accompanying list of magazines has been compiled from this bibliography. An attempt has been made to give up-to-date addresses and subscription rates for the magazines cited. Subscription rates are for the U.S. Rates to other countries are normally higher.

### GENERAL 6502

**MICRO**  
\$18.00 per year, 12 issues  
P.O. Box 6502  
Chelmsford, MA 01824

**Compute!**  
\$20.00 per year, 12 issues  
P.O. Box 5406  
Greensboro, NC 27403

**6502 Users' Group Newsletter**  
21, Argyll Ave.  
Luton, Bedfordshire, England

### GENERAL COMPUTER

**Byte**  
\$19.00 per year, 12 issues  
Byte Subscriptions  
P.O. Box 590  
Martinville, NJ 08836

**Computer Shopper**  
\$10 per year, 12 issues  
Glenn Patch, Editor  
P.O. Box F  
Titusville, FL 32780

**Computing Today**  
£ 8.00, 12 issues  
Midmags Ltd.  
145 Charing Cross Road  
London WC2 0EE  
England

**Creative Computing**  
\$20.00 per year, 12 issues  
P.O. Box 789-M  
Morristown, NJ 07960

**CSRA Computer Club Newsletter**  
\$6.00 per year  
P.O. Box 284  
Augusta, GA 30903

**Dr. Dobb's Journal**  
\$21.00 per year, 12 issues  
People's Computer Co.  
P.O. Box E  
1263 El Camino Real  
Menlo Park, CA 94025

**GIGO Newsletter**  
North London Hobby Computer Club  
Polytechnic of North London  
Holloway, London N78DB  
England  
Attn: Robin Bradbeer

**Interface Age**  
\$18.00 per year, 12 issues  
McPheters, Wolfe and Jones  
16704 Marquardt Ave.  
Cerritos, CA 90701

**KB Microcomputing**  
\$25.00 per year, 12 issues  
Wayne Green, Inc.  
80 Pine Street  
Peterborough, NH 03458

**Microcomputer Index**  
\$22.00 per year, quarterly  
Microcomputer Information Services  
2464 El Camino Real, Suite 247  
Santa Clara, CA 95051

**On Computing**  
\$8.50 per year, quarterly  
P.O. Box 307  
Martinville, NJ 08836

**Personal Computer World**  
£ 8.00, 12 issues  
Sportscene Publishers (PCW) Ltd.  
14 Rathbone Place  
London W1P 1DE  
England

**Personal Computing**  
\$14.00 per year, 12 issues  
Hayden Publishing Co.  
50 Essex Street  
Rochelle Park, NJ 07662

**Popular Computing**  
\$16.00 per year, 12 issues  
P.O. Box 272  
Calabasas, CA 91302

**Practical Computing**  
£ 6.00, 12 issues  
IPC, Electrical Electronic Press  
Dorset House, Stamford St.  
London SE1 9LH  
England

**Purser's Magazine**  
\$12.00 per year, 4 issues  
c/o Robert Purser  
P.O. Box 466  
El Dorado, CA 95623

**Recreational Computing**  
\$12.00 per year, 6 issues  
People's Computer Co.  
P.O. Box E  
1263 El Camino Real  
Menlo Park, CA 94025

**SoftSide**  
\$24.00 per year, 12 issues  
P.O. Box 68  
Milford, NH 03055

**Spreadsheet**  
\$15.00 per year  
Visigroup—Visicalc User Group  
P.O. Box 1010  
Scarsdale, NY 10583

### APPLE-RELATED PUBLICATIONS

**The Abacus II Newsletter**  
\$18.00 per year, 12 issues  
2850 Jennifer Drive  
Castro Valley, CA 94546

**Apple**  
\$2.00 per issue, quarterly  
Apple Computer Co.  
10260 Bandlely Drive  
Cupertino, CA 95014

**Apple Assembly Line**  
\$12 per year, 12 issues  
c/o Bob Sander-Cederlof  
P.O. Box 5537  
Richardson, TX 75080

**Apple Barrel**  
\$18.00 per year (membership/subs.)  
c/o Ed Seeger, Editor  
Houston Area Apple Users Group  
3609 Glenmeadow Dr.  
Rosenberg, TX 77471

**Apple Bits**  
\$15.00 per year  
\$2.00 application fee  
NEO Apple Corps  
P.O. Box 39364  
Cleveland, Ohio 44139

**Apple-Can**  
\$20.00 per year, 6 issues  
Apple Users Group of Toronto  
P.O. Box 696, Station B  
Willowdale, Ontario M2K 2P9  
Canada

**Apple-Com-Post**  
DM 50.-  
Apple User Group Europe  
Postfach 4068  
D-4320 Hattingen  
West Germany  
(Printed in German)

**Apple Cookbook**  
\$15.00 per year  
131 Highland Ave.  
Vacaville, CA 95688

**Apple-Dayton Newsletter**  
\$18.00 per year  
39 Mello Ave.  
Dayton, Ohio 45410

**The Apple-Dillo**

\$15.00 per year, 12 issues  
c/o Lenard Fein  
River City Apple Corps  
2015 Ford St.  
Austin, TX 78704

**Apple For The Teacher**

\$12.00 per year, 6 issues  
5848 Riddio Street  
Citrus Hts., CA 95610

**AppleGram**

\$12.00 per year, 12 issues  
The Apple Corps of Dallas  
P.O. Box 5537  
Richardson, TX 75080

**The Apple Orchard**

\$10.00 per year, quarterly  
International Apple Core  
P.O. Box 2227  
Seattle, WA 98111

**Apple Peel**

\$20.00 per year, 12 issues  
Chet Lambert, Editor  
Apple Corps of Birmingham  
1704 Sam Drive  
Birmingham, AL 35235

**Apple/Sass**

\$12.00 per year, 12 issues  
Honolulu Apple User's Society  
P.O. Box 91  
Honolulu, HI 96810

**Applesauce**

\$12.00 per year, 6 issues  
c/o Earl Rand, Editor  
Original Apple Corps  
Rolfe Hall 3303, UCLA  
Los Angeles, CA 90024

**AppleSeed Newsletter**

\$15.00 per year, 12 issues  
P.O. Box 12455  
San Antonio, TX 78212

**The Apple Shoppe**

\$12.00 per year, 12 issues  
12804 Magnolia  
Chino, CA 91710

**Applications**

AUS \$10 per year (plus \$10 joining fee)  
Apple Users Group  
Box 3143, G.P.O.  
Sydney 2001, Australia

**ByteLines**

\$12.00 per year, 12 issues  
Hi Desert Apple Computer Club  
P.O. Box 2702  
Lancaster, CA 93534

**Call —A.P.P.L.E.**

\$15.00 per year, 12 issues  
\$25.00 application fee  
304 Main Ave. S., Suite 300  
Renton, WA 98055

**The Cider Press**

\$15.00 per year, 12 issues  
San Fransisco Apple Core  
1515 Sloop Blvd., Suite 2  
San Fransisco, Ca 94132

**The C.I.D.E.R. Press**

\$10.00 per year  
Apple Computer Information  
and Data Exchange of Rochester  
369 Brayton Road  
Rochester, NY 14616

**From The Core**

\$12.00 per year, 12 issues  
Carolina Apple Core  
P.O. Box 31424  
Raleigh, NC 27622

**F.W.A.U.G.**

\$15.00 per year, about 9 issues  
Lee Meador, Editor  
Fort Worth Area Apple User Group  
1401 Hillcrest Drive  
Arlington, TX 76010

**The G.R.A.P.E. Vine**

\$6.00 per year, 12 issues  
Group for Religious Apple  
Programming Exchange  
c/o Stephen Lawson  
P.O. Box 283  
Port Orchard, WA 98366

**The Harvest**

\$12.00 per year, 10 issues  
N. W. Suburban Apple User Group  
1015 S. Ridge Rd.  
Arlington Heights, IL 60005

**L.A.U.G.H.S.**

\$15.00 per year  
c/o Pat Connelly  
Louisville Apple User Group  
3127 Kayelawn Dr.  
Louisville, KY 40220

**The Michigan Apple-Gram**

\$12.00 per year, 10 issues  
The Michigan Apple  
c/o Marty Burke, Editor  
P.O. Box 551  
Madison Heights, MI 48071

**Mini'App'Les Newsletter**

\$10.00 per year  
Mini'App'Les Apple  
Computer User Group  
13516 Grand Avenue South  
Burnsville, MN 55337

**Neat Notes**

New England Apple Tree  
25 Emerson Street  
Medford, MA 02155

**Newsletter**

\$10.00 per year  
Apple Bytes of Buffalo  
c/o Hank Kolk  
171 Tree Haven Road  
Buffalo, NY 14215

**Nibble**

\$17.50 per year, 8 issues  
S.P.A.R.C.  
P.O. Box 325  
Lincoln, MA 01773

**OKC Apple Times**

\$10.00 per year, 10-12 issues  
c/o Greenbriar Digital Resources  
P.O. Box 1857  
Edmond, OK 73034

**Peelings II**

\$15.00 per year, 6 issues  
The Peelings Co.  
945 Brook Circle  
Las Cruces, NM 88001

**Poke-Apple**

\$15.00 per year  
Apple-Siders  
5707 Chesapeake Way  
Fairfield, OH 45014

**Rubber Apple Newsletter**

\$12.00 per year, 10 issues  
c/o Ken Gabelman  
849 Russel Ave.  
Akron, OH 44307

**The Seed**

\$18.00 per year, 12 issues  
P.O. Box 17467  
Denver, CO 80217

**Softalk**

\$10.00 per year, 12 issues  
Softalk Publishing, Inc.  
10432 Burbank Blvd.  
North Hollywood, CA 91601

**Southeastern Software Newsletter**

\$10.00 per year, 10 issues  
c/o George McClelland, Editor  
6414 Derbyshire Drive  
New Orleans, LA 70126

**Stems From Apple**

\$9.00 per year, 11 issues  
\$2.00 application fee  
Apple Portland Program  
Library Exchange  
c/o Dick Stein  
P.O. Box 1608  
Beaverton, OR 97075

**T.A.R.T.**

\$15.00 per year, quarterly  
The Apple Resource Team  
c/o Sid Koerin, Editor  
1706 Hanover Ave.  
Richmond, VA 23220

**Washington Apple Pi**

\$18.00 per year, 12 issues  
P.O. Box 34511  
Washington, DC 20034

## AIM-RELATED

**Interactive**  
\$5.00 for 6 issues  
Newsletter Editor  
Rockwell International  
P.O. Box 3669, RC55  
Anaheim, CA 92803

**The Target**  
\$6.00 per year, 6 issues  
Donald Clem, Editor  
RR#2  
Spencerville, OH 45887

## ATARI-RELATED

**A.N.A.L.O.G. Magazine**  
\$10.00 per year, 6 issues  
P.O. Box 23  
Worcester, MA 01603

**Atari Computer Enthusiasts**  
\$8.00 per year  
c/o M.R. Dunn  
3662 Vine Maple Dr.  
Eugene, OR 97405

**Purser's Atari Magazine**  
(available thru dealers only, 2-3 issues  
per year)  
c/o Robert Purser  
P.O. Box 466  
El Dorado, CA 95623

**Iridis**  
The Code Works  
Box 550, 5578 Hollister, Suite B  
Goleta, CA 93017

## OSI-RELATED

**OSIO Newsletter**  
\$15.00 per year  
9002 Dunloggin Road  
Ellicott City, MD 21043

**OSI Users Group**  
c/o Richard Ellen  
12 Bennerley Rd.  
London SW11  
England

**OSI User's Independent Newsletter**  
\$10.00 per year, 6 issues  
c/o Charles Curley  
6061 Lime Ave. #2  
Long Beach, CA 90805

**Peek(65)**  
\$12.00 per year, 12 issues  
P.O. Box 347  
Owings Mills, MD 21117

## PET-RELATED

**Commodore PET User  
Group Newsletter**  
\$15.00 per year  
Commodore Business Machines, Inc.  
3330 Scott Blvd.  
Santa Clara, CA 95050

**Commodore PET Users Club  
Newsletter**  
£ 10.00, 5-8 issues, £ 15.00 overseas  
Commodore Information Centre  
360 Euston Rd.  
London NW1  
England

**Nieuwegein PET Users Group**  
Nijpelsplantsoen 252  
3431 SR Nieuwegein  
The Netherlands  
Attn: Hans Tammer or Louis Konings

**The Paper**  
\$15.00 per year, 10 issues  
Centerbrook Software Designs  
Long Island PET Society  
98 Emily Drive  
Centereach, NY 11720

**PET Benelux Exchange**  
Copytronics  
Burg, Van Suchtelenstraat 46  
7413 XP Deventer  
The Netherlands

**Printout**  
\$36.00 (surface mail), 10 issues  
\$45.00 (airmail)  
£ 9.50 (U.K.)  
P.O. Box 48  
Newbury RG16 OBD  
Berkshire, U.K.

**The Transactor**  
\$15.00 [Canada] per year, (6-8 issues)  
Commodore Systems  
3370 Pharmacy Ave.  
Agincourt, Ontario M1W 2K4  
Canada

## SYM-RELATED

**Sym-Physis**  
\$10.00 per year, quarterly  
\$13.50 per year, overseas  
Sym-1 Users' Group  
P.O. Box 315  
Chico, CA 95927

## NON-COMPUTER MAGAZINES

**EDN (Electronic Design News)**  
\$25.00 per year, 22 issues  
Cahners Publishing Co.  
270 St. Paul Street  
Denver, CO 80206

**Popular Electronics**  
\$14.00 per year, 12 issues  
One Park Ave.  
New York, NY 10016

**QST**  
\$18.00 per year, 12 issues  
American Radio Relay League  
225 Main Street  
Newington, CT 06111

**Radio-Electronics**  
\$13.00 per year, 12 issues  
200 Park Ave., South  
New York, NY 10003

**73 Magazine**  
\$25.00 per year, 12 issues  
P.O. Box 931  
Farmingdale, NY 11737

## Yacht Racing Programs Wanted

The United States Yacht Racing Union, the National Sports Authority for the racing sailor, has embarked on a program to develop a new *Race Management Manual* for use by race committees everywhere.

One section of the loose-leaf formatted manual (or handbook) will be devoted to various computer and calculator programs and other such aids.

Already we have received a few programs for computers such as one on the rules and several for scoring multi-class regattas, etc.

We earnestly solicit any and all programs readers might have developed relating to sailing, race scoring, handicapping, measurement rules and the like.

A library of such contributions is being maintained at the union's headquarters and contributions should be sent there: USYRU, P.O. Box 209, Newport, Rhode Island 02840.

The listing of the programs in the library will be included in the manual and its frequent up-dates, with appropriate credit to the authors and contributors.

Any questions or comments should be sent to the attention of:

Evans M. Harrell, Chairman  
USYRU Race Management Committee  
342 Sequoia Drive  
Marietta, Georgia 30060

Name: **The Labors of Hercules**  
System: SYM with BAS-1 or KIM 8K BASIC at 2000 H.  
Memory: 16K  
Language: BASIC  
Hardware: Terminal using standard serial I/O ports on SYM or KIM

Description: An adventure game in which you attempt the twelve labors of Hercules. Kill the Lernaean hydra, clean the Augean stables, and bring back the flesh-eating mare of Diomedes. Attempt these tasks and nine others just as Hercules did. You communicate with the computer using one and two word commands.

Copies: Just released  
Price: \$10.00 on cassette tape, ppd. in U.S. only.  
Author: Lee Chapel  
Available: Lee Associates  
2349 Wiggins Ave.  
Springfield, Illinois 62704

Description: Your complete birth chart read electronically by two well-known astrologers. Not a generalized reading of your sign, but the kind of horoscope a private astrologer would erect, based on your date, time and place of birth and computed to a precision within one-tenth of a degree or better. The planets, signs and houses of one particular birth are analyzed in a text of 1500 words or more, using the modern, psychological approach characteristic of the best in astrology today.

Copies: As needed  
Price: Screen version \$30.00.  
Printout version \$200.00 (includes license to reproduce textual material commercially).  
Authors: Steve Blake and Rob Hand  
Available: AGS Software  
Box 28  
Orleans, Massachusetts  
02653

Name: **5 More Great Games!**  
System: Apple II  
Memory: 48K  
Language: Applesoft, Machine  
Hardware: Apple II Plus, Disk II  
Description: Includes *Turn 'em Loose!*, *Mystery Code*, *Depth Charge!*, *The Mine Fields of Normalcy*, and *Deep Sea Treasure*. These are some of our newest and best games. Each one is great fun, Hi-Res. Best explosion sounds of any software in Applesoft. Machine language sound effects. There's enough action, suspense, and challenge to keep you going for months!

Copies: Many  
Price: \$29.95 (or \$9.95 for any one of the above games). Includes game cards, disk, instructions.  
Available: Avant-Garde Creations  
P.O. Box 30161,  
Dept. MCC  
Eugene, Oregon 97403

Name: **Wall Street**  
System: OSI C1P/Super-board/C4P  
Memory: 8K RAM  
Language: Microsoft BASIC  
Hardware: OSI C1P/C4P

Description: Game-type simulation for 1 to 6 players. Each tries to make his fortune in the stock market. Includes gains, losses, stock splits, stock market crash, etc. Great for teaching stock market theory or for just plain fun.

Copies: New  
Price: \$9.95 cassette 300 or 600 Baud  
Author: C. Powell III  
Available: Software Plus +  
1818 Ridge Avenue  
Florence, Alabama 35630

Name: **Pascal Level 1**  
System: Apple II  
Memory: 48K and ROM Applesoft (compiler); 8K min (run time)  
Language: Applesoft and machine language

Hardware: Disk II  
Description: This Pascal system consists of a subset of the standard Pascal as defined by Jensen and Wirth. It includes the structured programming features: IF-THEN-ELSE, REPEAT-UNTIL, FOR-TO/DOWNTO-DO, WHILE-DO, CASE-OF-ELSE, FUNCTION and PROCEDURE. It also includes the pseudo array MEM to allow memory PEEKs and POKEs. Now you can learn the language that is slated to become the successor to BASIC. Pascal Level 1 is a complete package that allows you to create, compile and execute programs written in Pascal. The source and object codes are automatically saved on diskette. Sample programs and a user's manual are included.

Price: \$35.00 on diskette  
Author: Hal Clark  
Available: On-Going Ideas  
RD #1, Box 810  
Starksboro, Vermont  
05487

Name: **Capital Assets Management System**

System: Apple II  
Memory: 48K  
Language: Applesoft  
Hardware: Disk II, printer of 80-columns or greater

Description: CAMS provides a simple and accurate means for the determination of asset depreciation, investment credit and investment credit recapture amounts. User may select from 8 depreciation methods and print detailed reports in either 80- or 132-column formats. Depreciation is performed on a date-to-date basis rather than just monthly. Investment credit/recapture is performed automatically by CAMS, scanning each file. User determined subtotalling is also supported, as are individual reports. An advanced editor allows trial runs on depreciation methods. Changes to all fields are possible. CAMS records 23 pieces of information on each asset, including GL account numbers and liberal notes. [CP/M version available soon.]

Price: \$99.50 (dealer inquiries invited)  
Author: Tracy Valleau  
Available: Innerface Business Systems  
P.O. Box 834  
Pacific Grove, California  
93950

Name: **ASTRO-SCOPE™: The Electronic Astrologer™**  
System: Apple II or TRS-80  
Memory: 32K for screen version, 48K for printout version.  
Language: For Apple II, Applesoft in ROM with DOS 3.2. For TRS-80, Disk BASIC 2.3.  
Hardware: For Apple II, 1 disk with screen version, 2 disks with printout version. For TRS-80, 2 disks with both versions.

DDJ



# DR. DOBB'S JOURNAL of COMPUTER Calisthenics & Orthodontia

*Running Light Without Overbyte*

Twelve Times Per Year

\$21/1 Year — \$39/2 Years

### Recent issues have included:

*ZX65: Simulating a Micro*

*EXOS-6500 Software Development Tool Kit*

*6502 Assembler—Pet 8K-32K*

*A Note on 6502 Indirect Addressing*

*The C Programming Language*

What you see is what you get.

To subscribe, send your name and address to *Dr. Dobb's Journal*,  
Department V4, Post Office Box E, Menlo Park, CA 94025.  
We'll bill you.



PCG

**Name:** PSSBC-A Power Supply  
**System:** Rockwell AIM 65  
**Description:** Designed to Rockwell's specifications for the AIM 65 single board computer, this unit supplies 5 volts at 2 amps maximum, regulated, and 24 volts at .5 amps average (2.5 amps maximum) unregulated. The 5 volt output is short-circuit-proof and an overvoltage protection (crowbar) circuit protects the circuitry of the attached computer. The supply is enclosed in an attractive all metal case with switch, pilot light and fuse on the front panel. The cable from power supply to computer is supplied.  
**Warranty:** Against defects in materials and workmanship for 90 days.  
**Price:** \$64.95 plus shipping. VISA/MC accepted.  
**Available:** CompuTech  
Box 20054  
Riverside, California  
92516

**Name:** CD-23-4 OSI to SA4008 Interface Board  
**System:** Ohio Scientific C3-C (CD-23 systems)  
**Hardware:** Hard Disk Controller to Hard Disk Interface  
**Description:** A hard disk interface board which allows users to interface from one to four Shugart SA4008 Hard Disks to one OSI Computer through the existing controller board.  
**Price:** \$845.00 list  
**Available:** TEACO, Inc.  
P.O. Box E  
2117 Ohio Street  
Michigan City, IN 46360

**Name:** MEM 4 and MEM 8  
**Description:** System Peripherals has recently announced their 4K and 8K static memory board for the AIM-65 microcomputer. This is a low power memory board that is plug-compatible with the AIM-65 expansion connector and requires no mother board or other hardware.  
**Price:** \$169.00 for MEM 8 (8K)  
\$109.00 for MEM 4 (4K)  
[Introductory prices.]  
**Available:** System Peripherals  
P.O. Box 971, Dept. M.  
Troy, Michigan, 48099

**Name:** P.I.E.-C  
**System:** PET/CBM, all versions  
**Description:** The P.I.E.-C is a Parallel Interfacing Element between the IEEE-488 port of the PET/CBM computers and any parallel-input ASCII printers. The attractive custom enclosure and direct computer mounting will make your system look professional rather than messy. Because the P.I.E.-C has parallel output with 2 handshaking lines it is compatible with the Epson printers, NEC Spinwriter, IDS 'Paper Tigers', Anadex printers, and of course all Centronics printers. There's no extra power supply because the +5v is obtained directly from the printer. The P.I.E.-C can respond to any of the IEEE-488 primary addresses of the PET/CBM computer systems by simply setting the interfacing switches. The conversion of non-standard PET/CBM codes to true ASCII codes is also switch selectable. The IEEE-488 port of the PET/CBM is extended using the same type card edge. This allows the cable that connects the floppy disks to the computer to be connected to the P.I.E.-C instead.  
**Price:** \$119.95 fully assembled with case, code converter and 6' printer cable.  
**Available:** LemData Products  
P.O. Box 1080  
Columbia, Maryland  
21044

**Name:** Micromodem II  
**System:** Apple II  
**Language:** Apple BASIC and Apple Pascal  
**Hardware:** Low speed modem  
**Description:** Complete direct connect data communications system for Apple II and Bell & Howell computers. Features 110 and 300 baud, full or half duplex, with auto dial and auto answer capabilities.  
**Price:** \$399.00  
**Available:** Hayes Microcomputer Products, Inc.  
5835A Peachtree Corners East  
Norcross, Georgia 30092  
(404) 449-8791  
[Contact address above for nearest retail dealer.]

**Name:** VOLTECTOR<sup>®</sup> Series 6  
**Hardware:** Same  
**Description:** A plug-in style transient, surge, and EMI protector.  
**Price:** \$79.50 list  
**Available:** Pilgrim Electric Company  
29 Cain Drive  
Plainview, New York  
11803

**Name:** Apple-Crate<sup>™</sup>  
**Hardware:** Apple II & II Plus  
**Description:** The "Apple-Crate" is a quality desk-top rack designed to house Apple computer components. It's finished in Hawthorne walnut that is both scratch- and stain-resistant and looks like an expensive piece of furniture.  
**Price:** \$59.95  
**Available:** Softsel  
4079 Glencoe Ave.  
Marina del Rey,  
California 90291

**Name:** SPS 1-500-24 Standby Power Supply Unit  
**Description:** Self-contained, reliable power source for use in brownout or blackout. Plug-in unit attaches to regular power source and connected to device requiring protection. Unit generates a regulated quasi sine AC wave from sealed gelled electrolyte battery in less than 25 milliseconds.  
**Price:** \$650.00  
**Available:** Welco Industries, Inc.  
9027 Shell Road  
Cincinnati, Ohio 45236

**Name:** 16 Channel, 12-bit, Data Logger Interface  
**System:** AIM 65  
**Memory:** 4K  
**Language:** BASIC  
**Hardware:** AIM 65 plus Columbus Instrument's Data Logger Interface.  
**Description:** Accurately keeps track of laboratory work in medical, industrial, and scientific fields without having to load programs from tape or disk. EPROM resident, auto-booting feature starting AIM as a data logger once the power is on.  
**Available:** Columbus Instruments Int. Corp.  
950 N. Hague  
Columbus, Ohio 43204

## 6502 Bibliography: Part XXXVII

### 952. Apple/Sass 2, No. 9 (December, 1980)

- Misevic, Bruno V., "Dice Roll," pg. 9.  
A dice roll program for the Apple.
- Misevic, Bruno V., "Low Cost Telephone Dialer and Phone Book," pg. 11.  
Hardware and software for the Apple.
- Niimi, Dennis S., "Demuffin Corrected," pg. 14-16.  
Fixes for the Demuffin program to transfer DOS 3.3 programs to DOS 3.2.1 format.
- Ward, Dennis, "Dennis Ward's Display," pg. 19.  
A special program for the Apple.

### 953. The Transactor 2, No. 8 (January/February, 1980)

- Anon., "Re-Dimensioning Arrays," pg. 1-2.  
Tips on re-defining an array on the PET.
- Anon., "Bits and Pieces," pg. 2-4.  
Dynamic loading, cursor positioning, monitors, etc. for the PET.
- Anon., "POP a Return and Your Stack Will Feel Better," pg. 10-11.  
How to jump out of a routine on the PET.
- Anon., "Supermon 1.0," pg. 15-22.  
A machine language program in RAM which links itself to the built-in PET ROM monitor.
- Garbutt, W.T., "RS-232C: An Overview," pg. 23-28.  
All about RS-232 and the PET I/O ports.
- VanDuinen, T., "Program Plus," pg. 30-36.  
Managing programs and routines on the PET.
- Anon., "Relocate and Save," pg. 37.  
A short utility for the PET.
- Brown, B., "Routines for the PET," pg. 38-40.  
Several short programs and tips.

### 954. The Transactor 2, No. 9 (March/April, 1980)

- OEI, Robert, "LIST in Lower Case," pg. 1.  
Sequence to cause PET to list in lower case/upper case.
- Anon., "Printer Tabbing," pg. 3.  
Tabbing on the PET printer.
- Gardner, L.D., "More on Printer Output," pg. 3-5.  
A routine for using Centronics printers with the PET.
- Butterfield, Jim, "Input and Output from PET Machine Language," pg. 10.  
Utility hints for the PET.
- Maclean, Bill, "An Instring Utility for the 16/32K PET," pg. 11.  
A utility to change a substring within a main string.
- Butterfield, Jim, "PET as an IEEE-488 Logic Analyzer," pg. 12-13.  
Routine and technique to show the current status of four of the GPIB control lines plus a log of the last nine characters on the bus.
- Butterfield, Jim, "Cross-Reference," pg. 18-22.  
A program to do cross-referencing of a BASIC program, on the PET.

- Berezowski, David, "Better Auto Repeat," pg. 23.  
A repeat key program for the PET.
- Hook, David A., "The 'Unwedge' — A Tape APPEND and RENUMBER Program," pg. 24-38.  
A useful utility for the PET, in BASIC and machine code.
- Barnes, Paul, "Restore Data Line Program," pg. 39.  
This routine to restore the data line pointer of the PET at a line other than the first.
- Rosslund, S. Donald, "Machine Language Case Converter," pg. 42-43.  
A PET machine language routine to convert strings to the correct upper/lower case condition for printing on CBM printers with the original ROM.

### 955. The Transactor 2, No. 10 (May/June, 1980)

- Anon., "Remainder," pg. 1.  
A special case of the MID\$ function on the PET.
- Troup, Henry, "Controlling Garbage Collections," pg. 4.  
How to force an early garbage collection, at the start of the input, on the PET.
- McDonald, John, "More on Screen Print," pg. 8.  
Stretch the 40-column PET screen to 80 columns on the printer.
- Troup, Henry, "True ASCII Output," pg. 9-11.  
Basic and machine language routines for the PET.
- Hoogstraal, J., "PET 2040 Disk Buffer I/O Routine," pg. 12-28.  
Information on PET I/O procedures.
- Dean, Sheldon H., "PET to Heathkit H14 Printer Serial Interface," pg. 29-32.  
Hardware article on the PET interface.
- Troup, Henry, "Filestatus," pg. 33.  
A short routine to check the PET file status.
- Butterfield, Jim, "BASIC 4.0 Memory Map," pg. 34-41.  
Hex and decimal locations of PET functions in BASIC 4.0.

### 956. The Transactor 2, No. 11 (July/August, 1980)

- Butterfield, Jim, "Text Editor," pg. 8-10.  
A simple line oriented editor for the PET.
- White, Don, "High Resolution Graphics for the PET," pg. 12-21.  
Adapting the "Visible Memory" to the PET.
- Hook, D., "Card Printing Utility," pg. 22-27.  
Utility for printing playing cards on the PET.
- Butterfield, Jim, "Simple 8010 Modem Program," pg. 28-29.  
A program to output the PET to an ASCII system.

### 957. OSIO Newsletter 2, No. 2 (February, 1980)

- Wallis, T.L., "Memory Map of OS65U and Location of Various Parameters," pg. 3-8.  
Hex and decimal locations of the Ohio Scientific OS65U.



**958. OSIO Newsletter 2, No. 3 (March, 1980)**

Anon., "Some C1P Routines," pg. 1-2.

Several subroutines for the C1P micro.

Schwartz, Danny, "C1P Sketchpad," pg. 3.

Drawing program for the C1P lets you see the video screen as a sketch pad.

**959. OSIO Newsletter 2, No. 4 (April, 1980)**

Boardman, J.B., "Serial Monitor ROM," pg. 4-6.

The OSI 65A monitor at FE00 disassembled.

**960. OSIO Newsletter 2, No. 6 (June, 1980)**

Popenoe, Chuck, "Message Center," pg. 4.

A message program for using a C1P as a bulletin board.

Anon., "Fitting a Format," pg. 5-7.

Tips on writing formatting routines for OSI micros.

**961. OSIO Newsletter 2, No. 7 (July, 1980)**

Brounstein, Sid, "Challenger on the Phone," pg. 2-5.

Telecommunications interface program for the OSI 550 board.

Mason, Jim, "Real Time Clock," pg. 6.

A clock program using the OSI 600 board.

Morgenstein, David, "PEEK{15908}," pg. 7.

Tips for using OS-U and a line printer.

**962. OSIO Newsletter 2, No. 8 (August, 1980)**

Kirshner, Joe, "OS-65D Notes," pg. 1-2.

A number of interesting uses for PEEK{64513}.

Morganstein, D., "Indirect ASCII Files," pg. 3-4.

A tutorial for files on the OSI systems.

Randal, John, "Program PRONLY," pg. 5-7.

How to store programs efficiently on disks.

**963. OSIO Newsletter 2, No. 9 (September, 1980)**

Callaghan, Bill and Kupperian, Jim, "Modems," pg. 5-7.

Hardware and software program for modem operation using the OSI, C1P or C2P.

**964. The Apple Orchard (Fall, 1980)**

Bishop, Bob, "Apple II Hi-Res Graphics: Resolving the Resolution Myth," pg. 7-10.

Explaining some limitations of Apple high resolution graphics.

Rowe, Pete, "The Mysterious Orange Vertical Line," pg. 11.

The orange line at the left side of the Hi-Res Apple screen is explained.

Spurlock, Loy, "Understanding Hi-Res Graphics," pg. 12-21.

How to include text in your Hi-Res graphics program on the Apple.

Crossley, John, "ASCII, EBCDIC, and the Apple," pg. 31.

Selectively convert Apple's output to EBCDIC or convert incoming EBCDIC to ASCII with this routine.

Anon., "Yes! There Is A Fix for APPEND in DOS 3.2 (and 3.2.1)!", pg. 31.

Fix up the APPEND routine on the Apple DOS with an End of File marker.

Anon., "RFI: The F.C.C. and Your Apple," pg. 32-35.

Tips on improving the suppression of spurious radiation from the Apple.

Kellner, Jo, "Pascal Operand Formats; or, The Secret Life of a Variable," pg. 38-40.

All about Pascal variables on the Apple.

Anon., "Auto-Run Apple Without DOS," pg. 42-44.

How to start up your non-disk Apple program without a disk.

Crossley, John, "Initializing Apple Peripherals with POKES," pg. 43.

Lists of the Apple POKES needed to initialize the memory locations used by various interfaces.

Anon., "AppleWriter Modification for Lower Case Display," pg. 43.

A software modification allowing AppleWriter to be used with the Paymar Lower Case Adapter.

Budge, Joseph H., "Inside Initialization," pg. 49-52.

A tutorial for the Apple user, relating to disk operation.

Kamins, Scot, "Locksmythe and the Dedicated Programmer, or - Writing User-Proof Interactive Code," pg. 54-58.

Anon., "Linking Machine Language Routines to Apple-soft Programs," pg. 61.

A technique showing how to hide a binary program that will follow the Applesoft listing but which will not appear in the listing.

Silverman, Ken, "Don't Overload Your Apple II," pg. 67-69.

Tabulation of the voltage and current requirements of various Apple interface cards and accessories.

**965. The Paper 3, Issue 6/7 (Fall, 1980)**

Breed, Alex, "PET's Not-So-Random RND," pg. 9.

A discussion of problems involved in generating random numbers.

Eisner, Gerry, "Meddling with Middle String," pg. 14-15.

A tutorial on the MID\$ function on the PET.

Bromley, J.R., "A Better Screen Copy," pg. 16-17.

A screen dump to printer program for the PET.

Sherwood, D., "Cassette Survival Hints," pg. 18-19.

Tips on using the PET cassette system including tape quality, tape storage, cassette heads and alignment, etc.

Busdiecker, Roy, "Auto Repeat Keys, Version Two," pg. 22-23.

Another program to provide repeat keys on the PET.

**966. Apple Bits 2, No. 8 (October, 1980)**

Chilton, Peter, "Pascal/Fortran," pg. 4.

A brief comparison of Pascal, Applesoft and Z-80 machines.

Kovalik, Dan, "Taking the Mystery and Magic Out of Machine Language," pg. 5-6.

A tutorial on Apple Hi-Res machine language.

Koehler, John, "BASIC Basics," pg. 8.

Program based on the implementation of Fisher's algorithm for the internal rate of return of an investment.

**967. Softside 3, No. 1 (October, 1980)**

Laurence, Matthew, "An Apple One Liner," pg. 4.

A mini program for the Apple.

**968. Apple Assembly Line 1, Issue 1 (October, 1980)**

Sander-Cederlof, Bob, "Programming Notes," pg. 2-3.

How to add and subtract one (incrementing and decrementing) on the Apple.

- Sander-Cederlof, Bob, "General Message Printing Subroutine," pg. 4-8.  
 Formatting messages in assembly language on the Apple.
- Matzinger, Bob, "Using the Paymar Lower Case Adapter with S-C Assembler II Version 4.0," pg. 4.  
 A machine language routine for the Apple.
- Sander-Cederlof, Bob, "Hardware in All 6502 Chips!," pg. 10-11.  
 A bug in the 6502 and a suggested fix.
- 969. The Apple Peel 2, No. 4 (April, 1980)**  
 Brown, Tom, "Disk File Hints," pg. 2.  
 How your disk file program can determine whether file name already exists in the Apple disk.
- 970. The Apple Peel 2, No. 5 (May, 1980)**  
 Selig, David, "Onerr Routines," pg. 5.  
 A hint on using error routines on the Apple.  
 Chipchase, Frank, "Better Use of Apple II Renummer and Merge Program," pg. 6.  
 A short tutorial on these Apple routines.
- 971. The Apple Peel 2, No. 7/8 (August, 1980)**  
 Hertzfield, Andy and Larsen, LeRoy, "Free Space Formalized," pg. 3.  
 A basic program for utilizing the free space machine language routine for the Apple.  
 Knaster, Scott, "Using the 'Old Monitor ROM' with the Language System," pg. 4.  
 A procedure for enhancing the use of your language system.  
 Anon., "APPEND Fix in DOS 3.2 and 3.2.1," pg. 6.  
 How to patch up the missing end-of-file marker in the Apple disk operating system.  
 Brown, Tom, "Fireworks," pg. 7.  
 A Hi-Res graphics program for the Apple.  
 Anon., "Soundex," pg. 9.  
 A routine to use in search routines that will give approximate matches in place of requiring exact matches.  
 Hyde, Bill, "Lo-Res Printout," pg. 10.  
 A subroutine to print out the Apple Lo-Res screen in a primitive fashion.  
 Hartley, T., "Catalog Program," pg. 13.  
 Routine to set up a catalog to hold 181 file names on the Apple disk.  
 Buchler, Dan, "Justification Routine," pg. 13-14.  
 Routine to right justify all output to the Apple screen.
- 972-A. OSIO Newsletter 2, No. 10 (October, 1980)**  
 Kirshner, Joe, "OS-65D Notes," pg. 1-2.  
 Change BEXEC on the OSI system to include a program list.  
 Anon., "65412," pg. 2.  
 How to use location 65412 in conjunction with the WAIT command on the OSI systems.  
 Versace, Mike, "True C8P OS-U Backspace," pg. 3-4.  
 A backspace working on both the Challenger III and the C8P.  
 Solntseff, Nicholas, "Right Justification Revisited," pg. 6-7.  
 A right justification routine for OSI systems.
- 972-B. OSIO Newsletter 2, No. 12 (December, 1980)**  
 Kirshner, Joe, "OS-65D Notes," pg. 3-5.  
 A tutorial on sequential files for OSI systems.
- 973. Rubber Apple Users Group 3, No. 7 (October/November/December, 1980)**  
 Gabelman, Ken, "Disk Structures IV," pg. 1-9.  
 More including a listing for "the Invisible Mailing List."
- 974. Atari Computer Enthusiasts 1, Issue 2 (Fall, 1980)**  
 Goff, S., "Electronic Christmas Card," pg. 1.  
 A graphics program for the Atari.  
 Dunn, M.R., "Edit Subroutine," pg. 2-3.  
 Copy and disk file edit for the Atari.  
 Dunn, M.R., "Typewrite," pg. 3.  
 Atari program to turn the computer into a typewriter.  
 Dunn, M.R., "Disk Utilities," pg. 3.  
 Two disk directory routines for the Atari, Disk Menu and Disk Directory Subroute.  
 Dunn, M.R., "Speak Atari," pg. 6.  
 Several uses of the Atari GOSUB function.  
 Goff, Stacy, "Listen Atari," pg. 7.  
 Connect your Atari to your stereo for fantastic sound.
- 975. Appleseed Newsletter 2, No. 4 (October-December, 1980)**  
 Wright, Don, "BASIC-RWTS Interface Bug Shot," pg. 7.  
 Fixing the minor bugs in DOS 3.3 regarding the IBSTAT parameter and the RWTS Link program, on the Apple.  
 Connelly, Pat, "Lo-Res to Hi-Res," pg. 11-13.  
 A graphics program for the Apple.  
 Anon., "Hex to Decimal Conversion," pg. 14.  
 A simple technique to use the Apple monitor for numbers conversions.  
 Pump, Mark, "Apple II DOS Internals," pg. 14-19.  
 Memory map and tutorial on the Apple DOS 3.2.
- 976. Apple Bits 2, No. 9 (November, 1980)**  
 Kvalik, Dan, "Taking the Mystery and Magic Out of Machine Language," pg. 5-6.  
 More about machine language and Hi-Res graphics with several listings for the Apple.  
 Koehler, John, "BASIC Basics," pg. 7.  
 Tips on the operation of floating-point BASIC.
- 977. Softside 3, No. 2 (November, 1980)**  
 Pelczarski, Mark, "Apple Programming Notes," pg. 8.  
 Several hints for Apple users.  
 Ward, Dennis, "One-Liner," pg. 19.  
 A one line graphics routine for the Apple.  
 Pelczarski, Mark, "Softside's Data Base: Part Three," pg. 30-31.  
 Sorting routines, Apple and Atari.  
 Bohlke, David, "Engineer," pg. 50-51.  
 A game for the Atari.  
 Hausman, Rob, "Keyboard Organ," pg. 62-63.  
 A machine language routine for the Apple.  
 Hays, Tim, "Trench," pg. 66-67.  
 A game for the Atari.  
 Truckenbrod, Joan, "Computer Aided Drawing and Design: Rotation Techniques," pg. 74-75.  
 A tutorial and program listing for Hi-Res Appl graphics.

**INTRODUCING  
COGNIVOX Series VIO-1000  
A Revolutionary New  
Voice Input and Output Peripheral**

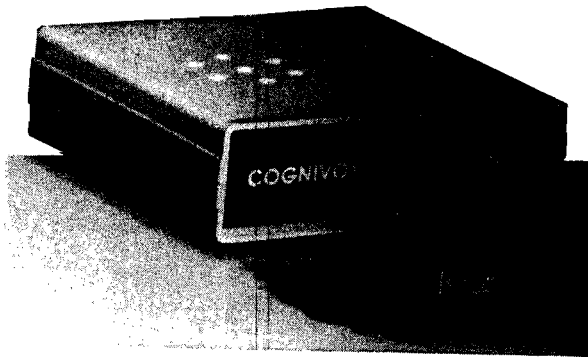

**High Fidelity Voice Response  
Industrial Quality Recognition**

**PET — AIM-65 — APPLE II**

COGNIVOX series VIO-1000 is a top-of-the-line voice I/O peripheral for business and educational applications and the demanding hobbyist.

It can be trained to recognize words or short phrases drawn from a vocabulary of 32 entries chosen by the user. It will talk back with up to 32 words or short phrases. In disk based systems, response vocabularies can be stored on the disk and brought to memory as needed, giving an effectively unlimited number of vocabulary entries. The quality of voice response is excellent, and it is far superior to that of speech synthesizers.

COGNIVOX series 1000 comes complete and ready to plug into your computer (the computer must have at least 16K of RAM). It connects to the parallel I/O port of the PET, to the game paddle connector on the Apple and to the J1 port on the AIM-65. Connectors are included as required. Also included are a microphone, cassette with software and extensive user manual. A built-in speaker/amplifier is provided as well as a jack for connecting an external speaker or amplifier.

Software supplied with COGNIVOX includes two voice operated, talking video games, VOTH and VOICETRAP. These games are absolutely captivating to play, and the only voice operated talking games that are commercially available.

Adding voice I/O to your own programs is very simple. A single statement in BASIC is all that is required to say or to recognize a word. Complete instructions on how to do it are provided in the manual.

In keeping with the VOICETEK tradition of high performance at affordable price, we have priced COGNIVOX series 1000 at the unbelievably low, introductory price of **\$249** (plus \$5 shipping in the US, CA add 6% tax. Foreign orders welcome, add 10% for handling and shipping via AIR MAIL). When ordering, please give the make and model of your computer, the amount of RAM and whether you have disks or not.

In addition to COGNIVOX series VIO-1000, VOICETEK manufactures a complete line of voice I/O peripherals for most of the popular personal computers. Speech recognition-only peripherals are available for the 8K PET and the 4K AIM.

For more information call us at 805-685-1854 or write at the address below.

Dealer Inquiries invited.

**VOICETEK** Dept E, P.O. Box 388  
Goleta, CA 93116

**ADVERTISERS' INDEX**

**JUNE 1981**

Advertiser's Name	Page
Aardvark Technical Services	31
Abacus Software	40
Andromeda, Inc.	64
Aurora Software Associates	48
Automated Simulations	2
Beta Computer Devices	69
The Book	24
Broderbund Software	48
Commodore Business Machines, Inc.	13
Community Computerist's Directory	48
Computer Applications Tomorrow	51
Computer Mail Order	34
Connecticut Information Systems, Co.	54
Consumer Computers	96
Continental Software	23
Creative Computing	41
Decision Systems	82
Dr. Dobb's Journal	106
Eastern House Software	94
Hayes Micro Computer Products, Inc.	BC
Instant Software	14-15
D.R. Jarvis Computing	57
Lazer Systems	4
LJK Enterprises	77
MICRO Classifieds	32
MICRO Ink, Inc.	6, 68, IBC
Microsoft Consumer Products	IFC
MicroSoftware Systems	82
Micro-Ware Distributing	58
Mittendorf Engineering	32
Nibble	44
Nikrom Technical Products	52
Ohio Scientific "Small Systems Journal"	90-93
Orien Software Associates	26
Peelings II	94
Perry Peripherals	70
P.M. Computers	40
Powersoft, Inc.	38
Print Out	10
Progressive Computing	26
Rainbow Computing	1
Rosen Grandon Associates	57
Sensible Software	55
Serendipity Systems, Inc.	26
Small Business Computer Systems	70
Small Systems Software	40
Soft CTRL Systems	57
Softape	51
Software Consultants	94
Southeastern Software	78
Southwestern Data Systems	56
Sunset Electronics	48
TSE-Hardside	42-43
Versa Computing	58
Voicetek	111
Western Micro Data Enterprises	70

**Why Advertise in MICRO?**

**Find Out!**

Call (617) 256-5515

Ask for Cathi Bland

- Webster, Ron, "Boing!", pg. 82-83.  
A graphics program for the Atari.
- 978. The Apple Barrel 2, No. 8 (November, 1980)**
- Kramer, Mike, "Name Swap Subroutine," pg. 5.  
Swap first and last names in your File Cabinet, for the Apple.
- Kramer, Mike, "Printer Activate/Deactivate Subroutines," pg. 6.  
Tabbing past column 40 using certain interface boards and printers.
- Anon., "Apple/Pascal Library," pg. 10-11.  
Catalog of Apple/Pascal programs on several disk volumes.
- Meador, Lee, "DOS 3.2 Disassembly," pg. 14-20.  
Part five of this series is on the Apple Disk II controller.
- 979. Apple Assembly Line 1, Issue 2 (November, 1980)**
- Sander-Cederlof, Bob, "Variable Cross Reference for Applesoft Programs," pg. 2-8.  
A useful tool when you are writing large Applesoft programs.
- Sander-Cederlof, Bob, "Assembly Source on Text Files," pg. 9-14.  
A program to allow you to save a source program on a text file so that it can be used in another editor or assembler.
- Sander-Cederlof, Bob, "A Simulated Numeric Key-Board," pg. 15-16.  
A program to turn part of your Apple keyboard into a simulated numeric key-board.
- 980. The Apple Peel 2, No. 11 (November, 1980)**
- Anon., "Addresses in the Apple II DOS," pg. 3.  
Some key addresses in Apple DOS 3.1 and 3.2.
- Brown, Tom, "POKE Salad," pg. 7-8.  
Using Applesoft ROM routines. The Ampersand and its use in calling up a number formatting code.
- 981. Peelings II 1, No. 4 (November/December, 1980)**
- Staff, "Software Reviews," 40 pgs.  
A review of a variety of Apple programs including a section which reviews and evaluates seven word processors for the Apple.
- 982. Applesauce 2, No. 2 (November/December, 1980)**
- Fisher, Bill, "Schematic for Apple Telephone Dialer," pg. 2.  
A schematic of hardware to use the I/O output port of the Apple as a telephone dialer.
- Ender, Philip B., "Recovering a Deleted Pascal File," pg. 4-5.  
A technique for recovering Pascal files like the Disk Zap or Lazarus utilities in BASIC.
- Ender, Philip B., "Double Density Disk Storage in Pascal," pg. 6.  
Double the data on a diskette by packing your Pascal variables or records.
- Rivas, Lou P., "Applewriter Patches to Support: 1) 96-Character ASCII Input 2) Dan Paymar Lower Case Mod," pg. 7-8.  
A mod for the Applewriter word processor.
- Amromin, Joel L., "Slowlist Patches," pg. 11.  
A modification to permit a slowlist routine to work on Applesoft listings.
- Anon., "Easy Hex to Decimal Conversion," pg. 11!  
A simple technique for number conversion using the Apple monitor resources.
- Campbell, Bill, "Catalog Utility," pg. 12-13.  
A quick disk-based Apple utility to provide convenient housekeeping on your disks.
- Stearns, Brian, "REM Remover," pg. 14-15.  
Make your Integer BASIC listings easier to read, for the Apple.
- Ras, Henry, "Disk Menu Program," pg. 17-20.  
Condense your Apple Disk Catalog by eliminating the sector count.
- 983. Call — Apple 3, No. 9 (November/December, 1980)**
- Golding, Val J., "Window on the World," pg. 7-9.  
A tutorial on the use of Text Screen Windows.
- Connelly, Pat, "Animation with Data Arrays," pg. 11-17.  
Create, compress and decompress Apple data array shapes.
- Lingwood, David A., "Overlaying in Applesoft," pg. 19-20.  
Too much code, too little space. Or, how to get a 20K program to run in 8K on the Apple.
- Rettke, Dick, "FNC, A Non-Flashing Cursor for Your Apple II," pg. 23-27.  
If the flashing cursor bothers you, cool it!
- Golding, Val J., "The Last Word in Hex Converters," pg. 32-33.  
Several number converters for the Apple.
- Billard, Stephen L., "DOS 3.3, the Language Card and the Apple II," pg. 37-38.  
Discussion of techniques to improve the utility of the multi-lingual Apple.
- Caloyannides, Michael A., "Fortran for the Apple Computer: Two Alternative Approaches," pg. 41-43.  
A discussion of implementing Fortran on the Apple.
- Huelsdonk, Bob, "Making BASIC Behave," pg. 43-47.  
A tutorial for the Apple, using a home inventory program example.
- Reynolds, Lee, "Applesoft Variable LIST Statement," pg. 58-59.  
A list utility for the Apple.
- Lee, Scott, "Muffin Catalog Supplement," pg. 62.  
A utility to increase the convenience of using the MUF-FIN program to convert disk files from DOS 3.2 to 3.3.
- Herzberg, Norman P., "OUTLINE: A Program to Print REMS," pg. 63-64.  
A short utility to list only the comments contained in a program.
- Sander-Cederlof, Bob, "A Problem with the VAL(A\$) Function," pg. 65.  
A fix for a bug in the VAL function in Applesoft.
- 984. The C.I.D.E.R Press (Rochester) 2, No. 6 (November/December, 1980)**
- Berube, Jim, "Disk Utilities for DOS 3.2 and 3.3," pg. 7-9.  
A series of routines for servicing the needs of Apple disks.
- Hall, John, "Locating Errors in Pascal Programs," pg. 15.  
A short tutorial for Pascal users.

# GET MORE OUT OF YOUR APPLE WITH MICRO<sup>on</sup><sub>the</sub> APPLE

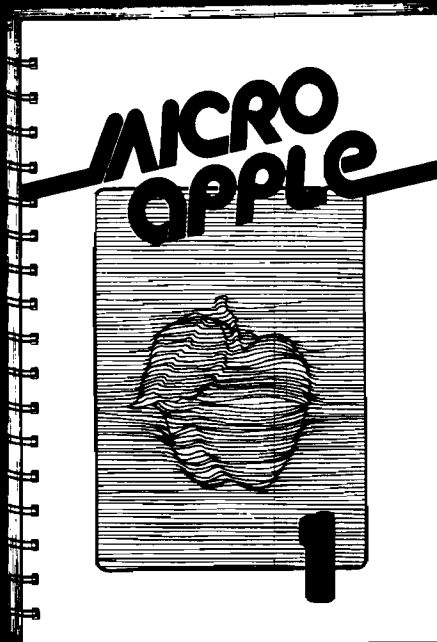

## MICRO/Apple

Over 30 Apple Programs on Diskette — For Less Than \$1.00 Apiece! No Need to Type In Hundreds of Lines of Code!

224-page book and diskette \$24.95\*

\*If ordered before July 15, MICRO pays shipping. Thereafter, add \$2.00 for surface shipping. Massachusetts residents add 5% for sales tax.

### MICRO's new book for Apple II users lets you

- Speed up programming in Applesoft and Integer BASIC!
- Add Apple II Plus editing features — at no cost!
- Round and format numbers accurately in business applications!
- Get lowercase letters and punctuation into Applesoft strings — at no cost!
- Do a shape table easily and correctly!
- Play the hit game "Spelunker"!
- And much, much more!

### With MICRO/Apple 1, the first volume in our new series, you receive

- 30 choice articles from MICRO (1977-80), complete with listings, all updated by the authors or MICRO staff,

plus

- 38 tested programs on diskette (13 sector, 3.2 DOS format, convertible to 3.3).

Ask for MICRO/Apple at your computer store or

**Call Toll-free 800-227-1617, Ext. 564**

In California, call 800-772-3545, Ext. 564

VISA and Mastercard Accepted

MICRO

P.O. Box 6502

Chelmsford, Massachusetts 01824

At Hayes, we don't believe in second best. Or planned obsolescence. We believe in taking the state of the art to the limit. Our new Smartmodem, for example, is the most sophisticated 300-baud originate answer modem you can buy. And yet, it is perhaps the easiest-to-use modem ever.

**RS-232C Compatible.** Smartmodem lets any RS-232C compatible computer or terminal communicate by phone with other computers and time-sharing systems located *anywhere in North America*. You get full and half-duplex operation with both Touch-Tone® and pulse dialing.

**Auto-Answer/Dial/Repeat.** Smartmodem can answer the phone, dial a number, receive and transmit data, and then hang up the phone—automatically! If desired, Smartmodem will even repeat the last command. You can depend on Smartmodem for completely unattended operation.

**Completely Programmable.** Smartmodem can be controlled using

# Hayes Stack™

## Microcomputer Component Systems

any programming language. Over 30 different commands can be written into your programs or entered directly from your keyboard.

Smartmodem also includes several switch-selectable features that let you tailor performance to your exact needs. You can "set it and forget it" for the ultimate in convenience.

**Built-in Audio Monitor.** Thanks to an internal speaker, you can actually listen to your connection being made. You'll know immediately if the line is busy or if you reached a wrong number—

and you don't even need a phone!

**Status at a Glance.** Seven LED's indicate Smartmodem's current operating mode: auto-answer, carrier detect, off hook, receive data, send data, terminal ready and modem ready. You're never left in the dark!

**Direct-Connect Design.** Smartmodem is FCC registered for direct connection to any modular phone jack—there's no acoustic coupler to cause signal loss and distortion.

**Smartmodem, Smart Buy.** Professional quality features. Versatile performance. A full two-year limited warranty. A suggested retail price of only \$279.

What more could you want? Perhaps the matching Hayes Stack Chronograph, an RS-232C compatible calendar/clock system.

Check out the Smartmodem wherever fine computer products are sold. And don't settle for anything less than Hayes.



Smartmodem.  
The ultimate concept in modems  
is now a reality.

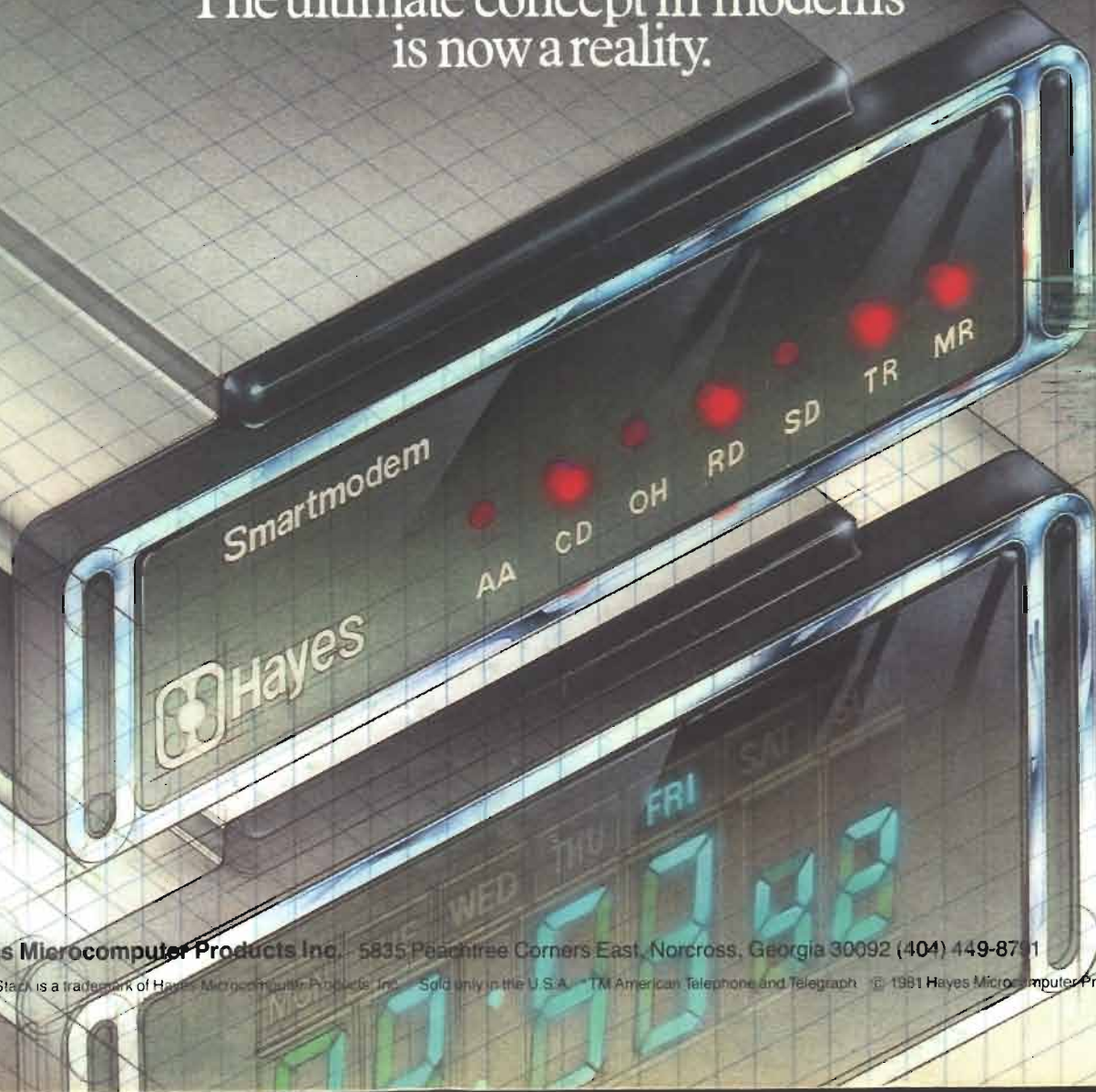

Hayes Microcomputer Products Inc., 5835 Peachtree Corners East, Norcross, Georgia 30092 (404) 449-8711

Hayes Stack is a trademark of Hayes Microcomputer Products, Inc. Sold only in the U.S.A. TM American Telephone and Telegraph © 1981 Hayes Microcomputer Products, Inc.