

MICRO™

The Magazine of the APPLE, KIM, PET
and Other 6502 Systems

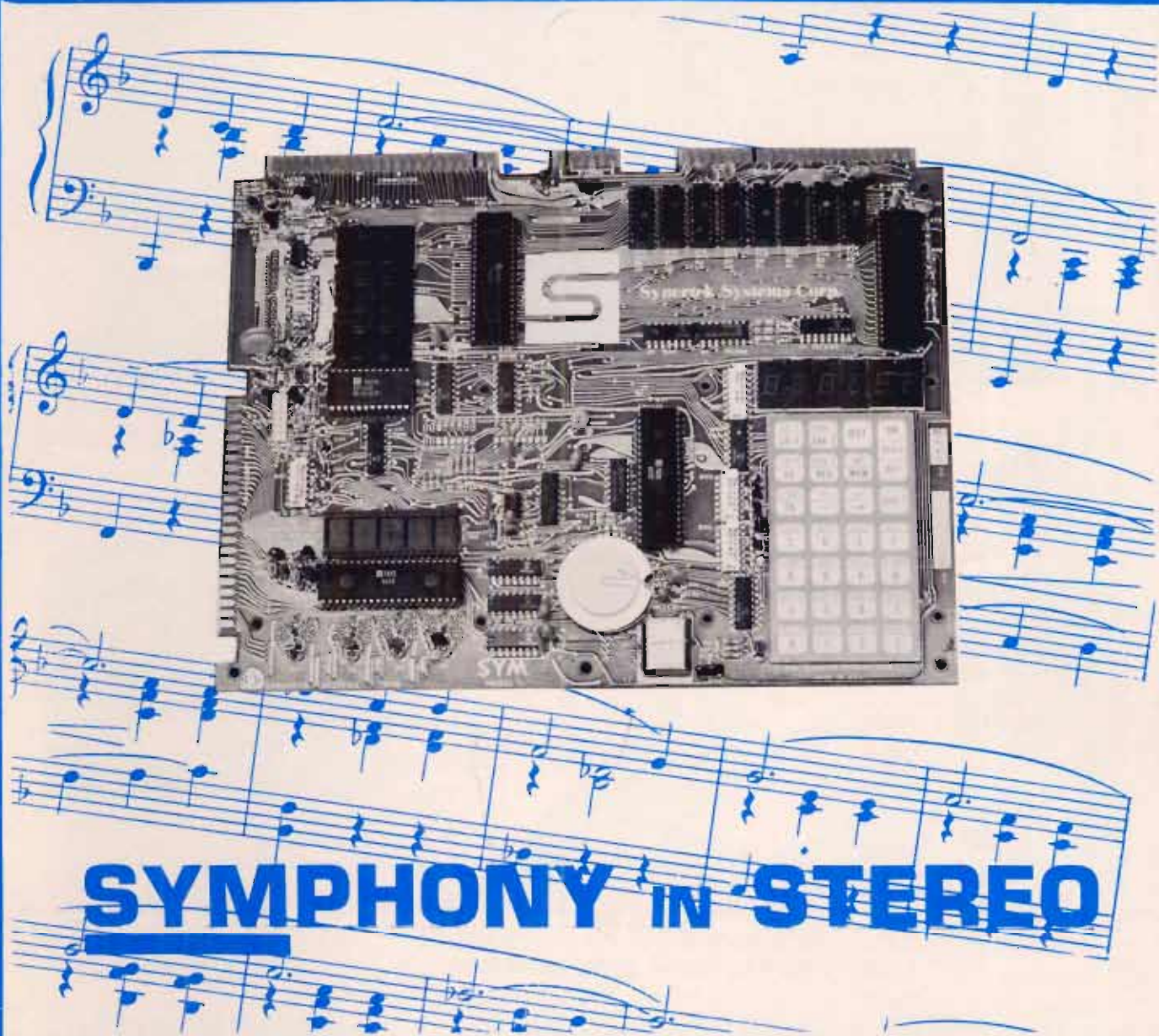

SYMPHONY IN STEREO

NO 13

June

1979

SPECIAL \$2.00 +1.50

PERFECT AIM



ATTRACTIVE FUNCTIONAL PACKAGING FOR YOUR AIM-65 MICROCOMPUTER

- Professional Appearance
- Striking Grey and Black Color Combination
- Protects Vital Components

ENGINEERED SPECIFICALLY FOR THE ROCKWELL AIM-65

- All Switches Accessible
- Integral Reset Button Actuator
- Easy Paper Tape Replacement

EASILY ASSEMBLED

- Absolutely No Alteration of AIM-65 Required
- All Fasteners Provided
- Goes Together in Minutes

MADE OF HIGH IMPACT STRENGTH THERMOFORMED PLASTIC

- Kydex 100*
- Durable
- Molded-In Color
- Non-Conductive

AVAILABLE FROM STOCK

- Allow Three to Four Weeks for Processing and Delivery
- No COD's Please
- Dealer Inquiries Invited

TO ORDER: 1. Fill in this Coupon (Print or Type Please)
2. Attach Check or Money Order and Mail to:

NAME _____

STREET _____

CITY _____

STATE _____ ZIP _____

Please Ship Prepaid _____ SAE 1-1(s)
@ \$43.50 each
California Residents Please Pay
\$46.33 (Includes Sales Tax)

**enclosures
group**

753 bush street
san francisco, california 94108

Table of Contents

Harmonic Analysis for the Apple by Charles B. Putney	5
Case of the Missing Tape Counter by William F. Pytlik	11
The Basic Morse Keyboard by William L. Taylor	13
A SYM-phony in Stereo by Phillip M. Rinard	17
Sorting with the APPLE II — Part 1 by Gary A. Foote	21
Streamlining the C2-4P by James L. Cass	28
6502 Information Resources Updated by William R. Dial	29
The Color Gun for the Apple II by Neil D. Lipson	31
ASK the Doctor — Part V Reading KIM Tapes on the AIM and SYM by Robert M. Tripp	34
Computer-Determined Parameters for Free-Radical Polymerization by L.S. Reich	38
AIM 6522 Based Frequency Counter by Marvin L. DeJong	41
KIM — The Tunesmith by Anthony R. Scarpelli	43
MICROBES	52
The MICRO Software Catalog: IX by Mike Rowe	53
SYM-1: Speak to Me by Jack Gieryic	57
Reading PET Cassettes Without a PET By David P. Kemp	61

Staff

Editor/Publisher
Robert M. Tripp

Business Manager
Maggie E. Fisher

Circulation Manager
Carol A. Stark

Distribution
Eileen M. Enos
Janet Santaguida

Micro-Systems Lab
James R. Witt, Jr.
Stephen L. Allen

Comptroller
Donna M. Tripp

Chief Gofer
Fred Davis

MICRO™ is published monthly by:
MICRO Ink, Inc.
34 Chelmsford Street
Chelmsford, Massachusetts
617/256-5515

Mailing address for all correspondence, subscriptions
and address changes is:

MICRO
P.O. Box 6502
Chelmsford, MA 01824

Application to mail at second-class postage rates
is pending at: Chelmsford, MA 01824.

Publication Number: COTR 395770

Subscription in United States:

\$15.00 per year/12 issues.

Entire contents copyright © 1979 by:
MICRO Ink, Inc.

Advertiser's Index

AB Computers	55	Microspan	27
Compas Microsystems	56	MICRO Technology Unlimited	17
Computer Components	20	Optimal Technology, Inc.	32
Computer Forum	1	P.S. Software House	55
The Computerist, Inc.	47,49,51	Plainsman Micro Systems	60
Computershop	16	Powersoft, Inc.	4
Connecticut microComputers	64	Programma International	IBC
Creative Computing	59	Progressive Software	33
Dr. Daley	10	Pygmy Programming	27
Eliam Associates	60	RNB Enterprises	37
Enclosures Group	IFC	Softouch	27
H. Geller Computer Systems	61	Speakeasy	BC
Hudson Digital Electronics	2	SYBEX	55
MICRO	35	West Side Electronics	27
Microproducts	9		

POWERSOFT, INC.

P. O. BOX 157
PITMAN, NEW JERSEY 08071
(609) 589-5500

products for the APPLE II

ADDRESS FILE GENERATOR

\$19.95

A professional piece of software which allows the user to create four different types of address files: a) Holiday File, b) Birthday File, c) Home Address File, and d) Commercial Address File. The program contains a menu of seven major commands: 1) Create a File, 2) Add to File, 3) Edit File, 4) Display File, 5) Search File, 6) Sort File, and 7) Reorganize File. Most of the major commands have subordinate commands which adds to the flexibility of this powerful software system. We doubt you could buy a better program for maintaining and printing address files. REQUIREMENTS: Disk II, Apple Printer Card, 32K of memory with Applesoft Rom Card or 48K of memory without Applesoft Rom Card.

SUPER CHECKBOOK

\$19.95

A totally new checkbook program with a unique option . . . Bar Graphs. These bar graphs, outputted to a printer or video screen, provide trend analysis data on code expense, income, expenses, or gain/loss on a month by month basis. The program contains a total of fourteen options: 1) Check/Deposit Entry & Modification, 2) Reconciliation of Checks or Deposits, 3) Sort by Check Number, 4) Sort by Code for Year, 5) Sort by Code for Month, 6) Output Year to Date, 7) Output Month Activity, 8-11) Printer/Video Plot Trend Analysis-Bar Graphs, 12) Account Status, 13) Reconciled Check Status, and 14) Quit. An excellent program for maintaining your checkbook, or that of a small business. REQUIREMENTS: Disk II, 32K of memory with Applesoft Rom Card or 48K of memory without Applesoft Rom Card.

FUNCTION GRAPHS AND TRANSFORMATIONS

\$14.95

This program uses the Apple II high resolution graphics capabilities to draw detailed graphs of mathematical functions which the user defines in Basic syntax. The graphs appear in a large rectangle whose edges are X and Y scales (with values labeled by up to 6 digits). Graphs can be superimposed, erased, drawn as dashed (rather than solid) curves, and transformed. The transformations available are reflection about an axis, stretching or compressing (change of scale), and sliding (translation). The user can alternate between the graphic display and a text display which lists the available commands and the more recent interactions between user and program. Expected users are engineers, mathematicians, and researchers in the natural and social sciences; in addition, teachers and students can use the program to approach topics in (for example) algebra, trigonometry, and analytic geometry in a visual, intuitive, and experimental way which complements the traditional, primarily symbolic orientation. REQUIREMENTS: 16K of memory with Applesoft Rom Card or 32K of memory without Applesoft Rom Card.

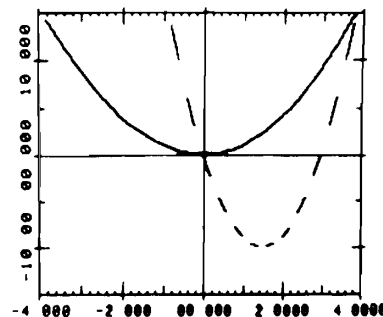

GAMES

Apple Casino	\$ 9.95
Apple Derby	9.95
Apple II Organ	19.95
Cubik	9.95
Radar Interceptor	9.95
Rocket Pilot	9.95
Saucer Invasion	9.95
Space Maze	9.95
Star War	9.95
Swarms	14.95
Wampus Hunt	9.95

APPLICATIONS

Automotive Diagnosis	\$14.95
Basic Statistics	9.95
Electrical Engineering I	9.95
Statistics I	14.95
Vector Analysis	9.95

FINANCIAL

Financial Wizard	\$ 9.95
Financial Wizard II	9.95
Financial Wizard III	9.95
Financial Wizard IV	9.95

(Programs recorded on cassette tape. Documentation included.)

SYSTEMS SOFTWARE

Memory Dump	\$ 7.45
Program Unload	7.45
File Editor	24.95
Assembler	24.95

(File Editor required for use with Assembler)

HARDWARE

Light Pen	\$34.95
---------------------	---------

(Includes Demo-Software)

Call or write for our free SOFTWARE & ACCESSORIES CATALOG

DEALER INQUIRIES INVITED

POWERSOFT, INC.

P. O. BOX 157
PITMAN, NEW JERSEY 08071
(609) 589-5500

- Master Charge and VISA orders accepted.
 - Include \$1.00 for shipping and handling.
 - New Jersey residents add 5% sales Tax.
- (Prices subject to change.)

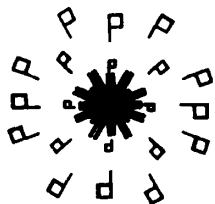

Apple II is a registered trademark of Apple Computer, Inc.

Harmonic Analysis For the Apple

Fourier Analysis is a powerful tool in many fields, but the number of calculation is requires makes it very laborious to perform by hand. A program in Applesoft Floating Point BASIC lets the APPLE II do the work.

Charles B. Putney
1085 Unguowa Road
Fairfield, CT 06430

One of the most important tools of modern technology is the oscilloscope. They can be found everywhere from your local auto repair shop to the hospital operating room and by the thousands in laboratories around the world. The people that use them know that the shape of the squiggly line which appears on the scope screen can tell whether their 'patient' is sick or well and if the former, what to do about it. Sometimes, however, simple visual study of a scope picture does not provide enough information. In this case, the modern day scientist or engineer can resort to quite sophisticated (and expensive) equipment to automatically dissect the picture and to spew out all sorts of numerical data concerning same. This effortless analysis of wave forms is a fairly recent technical development. It was not always quite so easy.

Before the advent of modern electronic computer technology, the analysis of a particular wave form was an all day or all week affair. First, one started with a graph of the function which was scaled to cycle every revolution of 360°. This was divided into equal angular steps and through careful measurements a table of x,y coordinates for each step on the curve was developed. The curve shown in Figure 1 illustrates a representative plot of data which could have been collected from the vibrations of a gasoline engine, torque variations of a synchronous motor or some other physical phenomenon.

The next step was to calculate the coefficients of the terms of a Fourier series. This calculation is a repetitive 'number crunching' exercise and was best done by two or more people armed with mechanical calculators. The team approach was advisable because, with the hundreds or even thousands of calculations required, mistakes were inevitable. At this point, numbers were available for the design of counterbalance weights for your engine, reshaping of poles of the synchronous motor, etc.

The mathematical proof of the fact that any single valued periodic function, such as the one in Figure 1, can be defined by an infinite series and the method for calculation of the coefficients for the terms of the series was developed by Jean Fourier, a French mathematician (1768-1837). The series which he investigated and which is given his name is:

$$Y = a_0 + a_1(\sin X) + b_1(\cos X) \\ + a_2(\sin 2X) + b_2(\cos 2X) \\ + a_3(\sin 3X) + b_3(\cos 3X) \\ + a_4(\sin 4X) + b_4(\cos 4X) \\ + a_5(\sin 5X) + b_5(\cos 5X) \\ + \dots \dots \dots \text{etc.}$$

It is easy to see that, if it is desired to carry a calculation for a Fourier series out to say the tenth harmonic, a lot of sines and cosines get into the action, in fact, ten of each for each point of the curve being investigated. The sheer magnitude of the pencil-pushing type calculation tasks that some of the mathematical geniuses of the past, such as Fourier, set before themselves staggers the imagination.

Fortunately, for most engineering problems, the relative significance of harmonics above the fifth are slight and most curves can be defined to sufficient accuracy by a Fourier series with a cut-off at this level. (One of my old text books describes a hydraulic penstock vibration problem involving the beat frequency between the 17th and 18th harmonics of the system!) The accompanying program, written in Applesoft II Floating Point BASIC, calculates a listing of coefficients of each term to the fifth harmonic and continues to show a calculated plot of the input data curve and all five harmonics within a couple of minutes. Admittedly, this does not match the speed of a fast Fourier transform system, but it sure beats the old way.

Harmonic analysis of the data listed for Figure 1 with this program yields the following information:

1. The curve is defined by the equation:

$$Y = 4.008 + 2.39 \sin(X) - 0.19 \cos(X) \\ - 0.49 \sin(2X) - 0.50 \cos(2X) \\ - 0.13 \sin(3X) + 0.12 \cos(3X) \\ + 0.23 \sin(4X) - 0.08 \cos(4X) \\ - 0.07 \sin(5X) + 0.07 \cos(5X)$$

2. The average of the curve is offset from zero about $Y = 4$.

If this data and results had been developed with respect to say a vibration problem, it could probably be safely assumed that if the second harmonic vibration component were taken care of, the system would be satisfactory. On the other hand, it might be desired to provide for a flexible mounting to absorb a deflection amounting to the difference between the curve average and the maximum deflection of 7.3. A vertical expansion of the plot of this curve can be obtained by subtracting 4 from the Y component of the input data. This will yield a graph balanced about the X axis as illustrated by the 'average line' in the figure.

Directions for running the program are pretty well built into the listing. After the initial instruction page, the form of the X or angular component must be inputted. (D for degrees or R for Radians followed by a RETURN) Then the data for each point of the curve being analyzed must be entered as X,Y (for example, Figure 1, Point 1 would be entered as 30,4.3 RETURN) until all points are in the computer, then enter Done, Done RETURN. If a mistake is made while entering any of the data points, the program must be restarted. Use a Control C to get out and start over with a RUN. Note, that zero degree X and the 360° X are the same from the definition of a periodic wave, so one or the other of these points should be entered but not both of them. It is not necessary to input the data points in order and any 360° span may be used (for example - 180° to + 180°). However, the plotted graph with this program will always come out starting at the zero position.

For those who don't have an APPLE, the program can be used as far as instruction 1225 without missing output of the real important results from the analysis, the term coefficients. While checking out this program, I recalculated examples from several old textbooks and without exception, I found at least one error in the answer listings in each one of them. Needless to say, this created big headaches for the students of that era.

μ

LIST

```

10 HOME : VTAB 5: HTAB 13: PRINT
  "HARMONIC ANALYSIS": PRINT
20 PRINT " THIS PROGRAM CALCULAT
  ES COEFFICIENTS OF FOURIER S
  ERIES TO THE FIFTH HARMONIC"

30 PRINT "OF PERIODIC FUNCTIONS
  F(Y)=F(X)"
40 PRINT "FUNCTIONS MUST MEET TH
  IS CRITERIA:"
50 PRINT : PRINT " (A)Y IS NO
  T INFINITE"
60 PRINT " (B)THERE IS ONLY O
  NE VALUE OF Y FOR EVERY VALU
  E OF X"
70 PRINT " (C)Y HAS ONLY A FI
  NITE NUMBER OF MAXIMA OR
  MINIMA"
100 PRINT
110 PRINT "MAKE A TABLE OF X,Y V
  ALUES PICKED FROM THE GRAPH
  FOR EACH SECTION"
120 PRINT "EVEN IF THE FIRST AND
  LAST HALVES OF THEGRAPH ARE
  SYMETRICAL, X,Y VALUES FOR
  ONEFULL CYCLE MUST BE ENTERE
  D"
122 PRINT "START DATA AT POINT #
  1 NOT POINT #0"
125 PRINT " HIT ANY KEY AND R
  ETURN TO CONTINUE": INPUT Q$

200 HOME : VTAB 2: PRINT "INPUT
  X,Y VALUES OF POINTS ON GRAP
  H UNTIL ALL INPUTTED, A
  FTER LAST ENTRY TYPE 'DON
  E,DONE'"

```

```

205 PRINT : PRINT "ARE X DATA PO
  INTS EQUAL STEPS DEGREES(D)
  OR RADIANS(R)?"
206 INPUT D$: IF D$ = "D" THEN R
  = 1
207 PRINT : PRINT " INPUT DATA A
  S X,Y"
210 INPUT X$,Y$
220 IF X$ = "DONE" THEN 1000
300 X = VAL (X$):Y = VAL (Y$)
301 REM CALCULATING SUMS OF COE
  FFICIENTS
305 A0 = Y + A0: IF R THEN X = (X
  / 360) * 6.28318
310 FOR I = 1 TO 5
320 A(I) = Y * SIN (I * X) + A(I
  )
330 B(I) = Y * COS (I * X) + B(I
  )
340 NEXT I
350 N = N + 1
360 IF T < ABS (Y) THEN T = ABS
  (Y)
390 GOTO 210
1000 A0 = (A0 / N): REM CALCULAT
  ING COEFFICIENT AVERAGES
1010 FOR I = 1 TO 5
1020 A(I) = (A(I) / N) * 2
1030 B(I) = (B(I) / N) * 2
1040 NEXT I
1100 HOME
1110 PRINT "TERMS OF THE FOURIER
  SERIES ARE:"
1120 PRINT : PRINT "TERM #1-(WIL
  L BE ZERO IF GRAPH IS": PRINT
  "SYMMETRICAL)"
1121 PRINT " ";A0
1122 PRINT "TERM #2":H = 1: GOSUB
  1200
1123 PRINT "TERM #3": GOSUB 1210
1124 PRINT "TERM #4":H = 2: GOSUB
  1200
1125 PRINT "TERM #5": GOSUB 1210
1126 PRINT "TERM #6":H = 3: GOSUB
  1200
1127 PRINT "TERM #7": GOSUB 1210
1128 PRINT "TERM #8":H = 4: GOSUB
  1200
1129 PRINT "TERM #9": GOSUB 1210

```

Tables I through IV list data points for various standard reference curves. It is interesting to go through them to see the harmonic patterns for each. For example, the triangular wave is an all odd harmonic system. The sawtooth wave, which is the basis for many electronic music generators, is the sum of all harmonics to infinity.

μ

Table I
Three Point Triangular

X°	Y
90	1
180	0
270	-1
360	0

Table II
Triangular

X°	Y
-160	-3
-140	-2
-120	-1
-100	0
-80	1
-60	2
-40	3
-20	4
0	5
20	4
40	3
60	2
80	1
100	0
120	-1
140	-2
160	-3
180	-4

Table III
Sawtooth

X°	Y
20	8
40	7
60	6
80	5
100	4
120	3
140	2
160	1
180	0
200	-1
220	-2
240	-3
260	-4
280	-5
300	-6
320	-7
340	-8
360	0

Table IV
Square

X°	Y
20	1
40	1
60	1
80	1
100	1
120	1
140	1
160	1
180	0
200	-1
220	-1
240	-1
260	-1
280	-1
300	-1
320	-1
340	-1
360	0

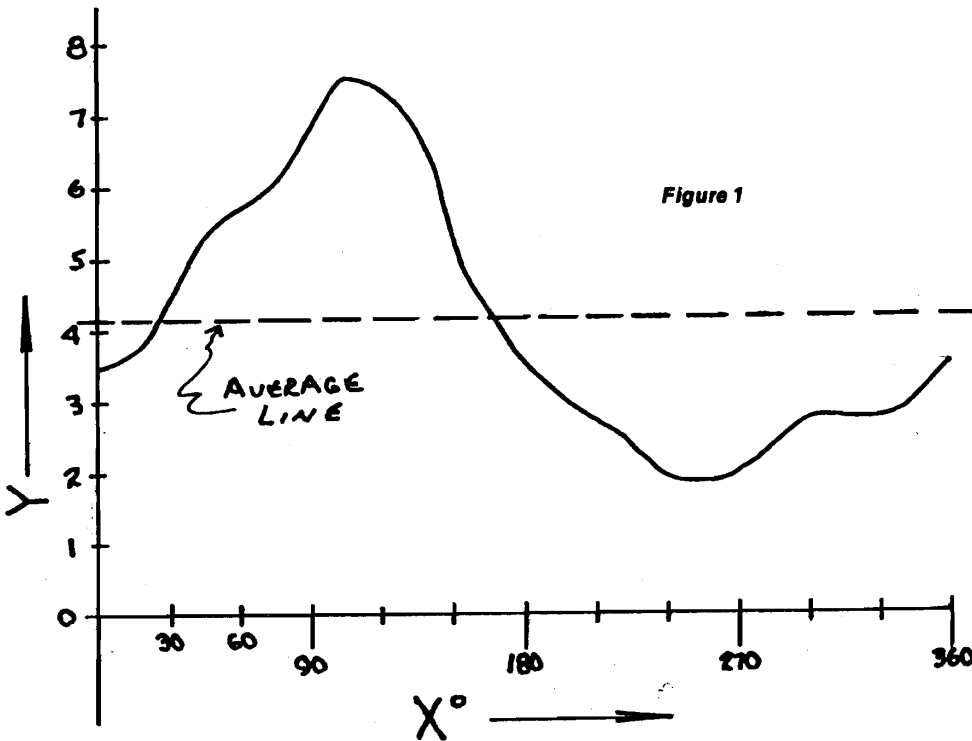

Figure 1

X°	Y	Ave Y
30	4.3	0.9
60	5.7	1.7
90	6.8	2.8
120	7.3	3.3
150	5.2	1.2
180	3.5	-0.5
210	2.7	-1.3
240	1.8	-2.2
270	1.9	-2.1
300	2.7	-1.3
330	2.7	-1.3
360	3.5	-0.5

```

1130 PRINT "TERM #10":H = 5: GOSUB
1200
1131 PRINT "TERM #11": GOSUB 121
0
1132 GOTO 1250
1200 PRINT "      ";A(H);" * SIN("
;H;"X)": RETURN
1210 PRINT "      ";B(H);" * COS("
;H;"X)": RETURN
1225 REM OK NON GRAPHICS TO HER
E ALSO CHANGE 1132 GOTO 1132

1250 INPUT "DO YOU WANT A PLOT Y
OR N? ";A$
1260 IF A$ = "N" THEN 6010
1290 S = 70:H = 0: REM SETTING I
NITIAL SCALE AND CALCULATION
CONSTANT TO ZERO

1300 PRINT : PRINT : PRINT "PLOT
OF INPUT DATA CALCULATED TO
FIFTH HARMONIC.      Y
AT 100= ";T: HGR

1301 HCOLOR= 3
1310 HPLOT 0,79 TO 279,79
1320 HPLOT 0,0 TO 0,159
1321 HPLOT 0,79 - S TO 5,79 - S
1322 HPLOT 0,79 + S TO 5,79 + S
1323 HPLOT 269,77 TO 269,81
1330 FOR K = 0 TO 269 STEP 4
1335 X = K / (.75 * 360) * 6.2831
8531
1340 Y = A0 + A(1) * SIN (X) + B
(1) * COS (X) + A(2) * SIN
(2 * X) + B(2) * COS (2 * X
) + A(3) * SIN (3 * X) + B(
3) * COS (3 * X) + A(4) * SIN
(4 * X) + B(4) * COS (4 * X
) + A(5) * SIN (5 * X) + B(
5) * COS (5 * X)
1350 Y = (1 / T) * Y * S
1355 IF ABS (Y) > 79 GOTO 6000
1360 HPLOT K,79 - Y
1390 NEXT K
1500 HCOLOR= 6
1510 PRINT : PRINT : PRINT "FIRS
T HARMONIC": GOSUB 1600
1520 PRINT : PRINT : PRINT "SECO
ND HARMONIC": GOSUB 1600
1530 PRINT : PRINT : PRINT "THIR
D HARMONIC": GOSUB 1600
1540 PRINT : PRINT : PRINT "FOUR
TH HARMONIC": GOSUB 1600
1550 PRINT : PRINT : PRINT "FIFT
H HARMONIC": GOSUB 1600
1580 GOTO 2000

1600 H = H + 1: REM ROUTINE FOR
PLOTTING HARMONICS
1610 FOR K = 0 TO 269 STEP 4
1620 X = K / (.75 * 360) * 6.2831
85
1630 Y = A(H) * SIN (H * X) + B(
H) * COS (H * X)
1640 Y = (1 / T) * Y * S
1645 IF ABS (Y) > 79 THEN 6000
1650 HPLOT K,79 - Y
1660 NEXT K
1670 RETURN
2000 HOME :H = 1: REM SETTING U
P COEFFICIENT TABLE
2010 VTAB 5: PRINT "
COEFFICIENT TABLE"
2020 PRINT : PRINT : PRINT "
SINES"," COSINES"
2031 PRINT : PRINT "FIRST HARMON
IC": GOSUB 2100
2032 PRINT : PRINT "SECOND HARMO
NIC": GOSUB 2100
2033 PRINT : PRINT "THIRD HARMON
IC": GOSUB 2100
2034 PRINT : PRINT "FOURTH HARMO
NIC": GOSUB 2100
2035 PRINT : PRINT "FIFTH HARMON
IC": GOSUB 2100
2040 PRINT : PRINT "CONSTANT = "
;A0;" Y AT 100 = ";T
2045 PRINT : PRINT "HIT SPACE BA
R FOR REVIEW"
2090 H = 0: GOTO 2200
2100 PRINT A(H),B(H)
2110 H = H + 1: RETURN
2200 REM REVIEW ROUTINE
2220 IF PEEK ( - 16384) < 127 THEN
2220
2230 POKE - 16368,0
2240 POKE - 16303,0
2270 IF PEEK ( - 16384) < 127 THEN
2270
2280 POKE - 16368,0
2290 POKE - 16304,0
3300 GOTO 2220
6000 PRINT "PLOT IS OFF SCALE. T
RYING AGAIN"
6002 S = S - 10: REM SHORTEN VER
TICAL SCALE
6004 FOR K = 1 TO 1000
6006 NEXT K
6008 GOTO 1300
6010 REM C.B.PUTNEY,
FAIRFIELD,CONNECTICUT
VER 3/1/79
6020 END

```

SUPERKIM

by MICROPRODUCTS

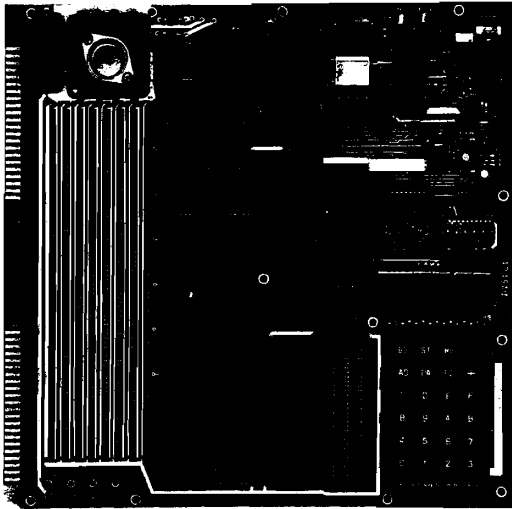

Here is a powerful microprocessor control system development tool and a complete microcomputer in one low-cost package. The Superkim singleboard computer has more features, more interface and expansion capability with a higher quality design and construction than any other in its class.

Have you got a thousand hours tied up in software for your KIM-1 BASED control system

and now your "KIM-1 is too small? The Superkim is the economical next step for expansion into more RAM, user EPROM and prototype area on one modern, compact, high density, fully assembled and integrated board. The Superkim has more software available than any other singleboard computer since it is totally compatible with KIM-1.

The Superkim has a wide range of appeal to engineers, teachers and industry.

* KIM-1 is a product of MOS Technology.

\$445.00

Add a Printer to Your Apple II

With our PC Board that interfaces with the highly popular Southwest Technical Products PR-40 Printer. Both our Printer Interface and PR-40 Printer are available at computer stores.

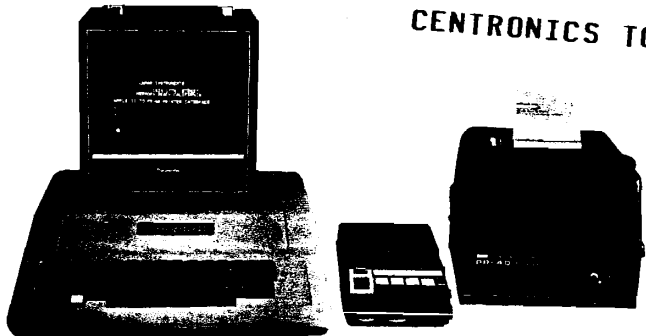

Printer Interface Apple II to PR-40

Interface is completely assembled, tested and guaranteed. Including: Interconnecting cable, software stored on audio cassette, PC Board which plugs directly into your APPLE II

FEATURES:

- Prints one line at a time when return key is pressed.
- Ideal for writing programs, as you have a complete permanent record of all changes and deletions to your program.
- While in Basic, using the list mode, printer will list the entire program without stopping as the screen scrolls up one line at a time.
- You can refer to an earlier part of your program without the necessity of relisting it on the screen.
- Printer can be called from Basic to print entire contents of video screen.
- When using assembly language mode, one line at a time will be printed in the same format as the video screen.

SPECIFICATIONS:

- Interface hardware consists of:
- an epoxy fiberglass PC Board
 - double-sided
 - plated through holes
 - silk screen printed legends
 - gold plated edge card connector.

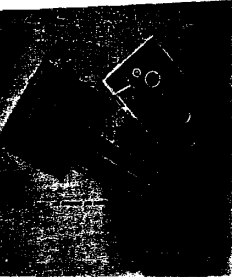

microproducts
2107 ARTESIA BOULEVARD
REDONDO BEACH, CA 90278
(213) 374-1673

\$49.95

Apple II EPROM

Expand Your ROM Software

Add capability to your system monitor or BASIC for business or other applications. Add commands to the operating system. New operating systems can be put into EPROM memory with our EPROM programmer and plugged directly into your APPLE II board with our EPROM socket adaptor. The **MICROPRODUCTS** EPROM Programmer will program INTEL 2716s, 2758s and other 5-volt replacements for 2716s.

Add to or replace existing APPLE II ROM software with operating systems of your own design. Other software systems similar to PASCAL, FORTH, LISP, APL, FORTRAN, COBOL, ALGOL, other BASIC's, etc. may be incorporated into your APPLE II ROM space.

The EPROM Programmer looks just like memory to the computer and can be configured to program memory locations from 8000 to FFFF for a total of 32K bytes. This means that the EPROMs can be used in computer applications other than the APPLE II, i.e. the **MICROPRODUCTS** Superkim, etc. This turns your APPLE II into a very low cost powerful, software development system.

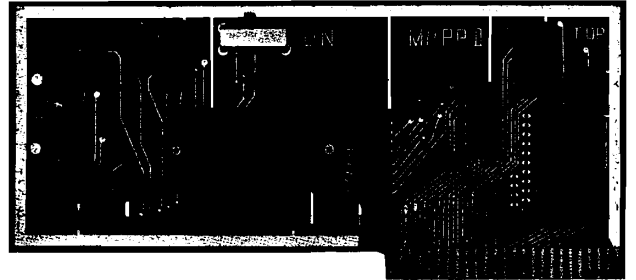

FEATURES:

- Fully assembled.
- Completely self-contained
- Textool Zero insertion force socket for EPROM
- Onboard 25 volt power supply
- Double sided plated through holes on fiberglass PC board
- Gold plated edge connector
- Fully socketed
- Latest low-power Schottky IC's
- Solder mask

ADVANTAGES:

- Put memory in two empty ROM slots in APPLE II
- Replace memory in existing APPLE II ROM slots
- Add new operating systems to APPLE II
- Programs INTEL 2716 2K byte EPROM's, 2758 1K byte EPROM's and other compatible 5 volt EPROMs
- Put peripheral drivers in permanent memory
- Use APPLE II to program EPROMs for other computers

\$99.95

MICROPRODUCTS will custom program EPROMs with your program on request!

microproducts

2107 ARTESIA BOULEVARD
REDONDO BEACH, CA 90278
(213) 374-1673

microproducts

2107 ARTESIA BOULEVARD / REDONDO BEACH / CALIFORNIA 90278 / (213) 374-1673

MICROPRODUCTS/APPLE II

PARALLEL INTERFACE BROCHURE

The MICROPRODUCTS Parallel Output card allows your Apple II* computer to communicate with the outside world.

Applications include:

- Printer Interface
- Power controller
- Tone/Music generator
- Plotter Driver
- LED/LAMP Driver
- Apple II/Superkim Communications interface

Features:

- * 8 bits output
- * 15 ma output, current sink or source (Can drive L.E.D.s directly)
- * TTL or CMOS compatible
- * Will go in any slot on the Apple II*
- * Data available strobe

General Information:

Data can be transferred to an external device by a STA, STY or STX from assembly language, or a POKE from BASIC. The 8 bits output can drive 2 7-segment L.E.D. displays, relays, SCRs, Printer, or anything which requires up to 8 bits of data.

Application notes and software to drive a Southwest Technical PR-40 printer is available for a nominal \$5.00 extra.

Included with the Parallel Interface are instructions on how to interface to a Centronics 779 printer and wiring diagrams for use as a power controller. Additional software and applications notes available.

*APPLE II is a trademark of APPLE COMPUTER, INC.

\$44.95

DR. DALEY'S SOFTWARE FOR THE PET

DR. DALEY's software continues to expand offerings. Listed below are our most popular programs. No PET owner should be without these. Dealers, you should stock them as well.

- | | | |
|--------------------|--|----------------|
| PET TREK 3 | Like STARTREK, but has several UNIQUE features. For example, the unpredictable EXPERIMENTAL RAY, who knows what it will do | \$ 7.95 |
| BACKGAMMON | It's you vs the PET with an exciting game of BACKGAMMON | \$ 7.95 |
| MASTER MIND | Plays two simultaneous games, one where you guess PET's secret code, and another where PET guesses yours | \$ 7.95 |
| RENUMBER | Will renumber your BASIC programs, including all jump statements. For a 6K source code requires less than 5 seconds | \$12.95 |
| PILOT | A BASIC coded PILOT interpreter. A second high level language for the PET. Simple to use, even a ten year old can learn to use PILOT quickly. With sample PILOT programs and documentation | \$12.95 |
| CHECKBOOK | Will balance your checkbook and save totals in 16 categories on tape. Will produce end of month and year to date summaries. Categories can easily be changed to suit your own purposes. | \$12.95 |
| MAIL LIST | Keeps a mailing list and will sort the list into sub groups using up to three search parameters | \$12.95 |

All of our programs are available on tape or for the Compu-Think disk. We charge \$5.00 for the disk and shipping, but you can subtract \$1.00 for each program which we place on the disk. Order 5 programs and you get the disk free!

- | | | |
|------------------|--|----------------|
| MAIL LIST | The above program has been modified for disk files. Will be placed on a disk by itself which you can then use for your mailing list | \$19.95 |
| FLASH! | We have just acquired the rights to distribute a linking loader for BASIC programs! This will allow you to link exclusively numbered BASIC subroutines in memory. No serious programmer should be without this useful programming tool | \$12.95 |

An ideal companion to the linking loader will be our library of useful subroutines which can be linked into your own program. Currently over 25 useful routines are included. These range from plotting utilities to a beautiful display of rolling dice. Write or call for a list or order the set for only

\$49.95

* * *

Remember that we GUARANTEE that your order will be shipped within four business days from receipt or you will receive a coupon for a discount on a future purchase.

Charge your order to
MC/VISA



DR. DALEY, 425 Grove Avenue, Berrien Springs, Michigan 49103

Phone (616) 471-5514 Sun. to Thurs. noon to 9 p.m. eastern time

Case of the Missing Tape Counter

The lack of a tape counter on the PET cassette tape unit has led to hours of frustration. The technique presented here provides a fairly automatic method of locating your files on the PET cassette.

The PET has an excellent file management system. Unfortunately, since the PET does not have a tape counter, access to any file or program other than the first requires either an uncanny "touch" to find a file by using FAST FORWARD or an infinite amount of patience waiting for the file management system to find the program at 1-7/8 inches/second. The obvious solution is to use a large number of C-10 or C-5 cassettes. Of course, this solution is costly and requires one to store a large number of tapes.

Fortunately, the PET does have a real time clock and the ability to start and stop the cassette motor via BASIC POKE commands. These two capabilities, combined with the use of constant length files, allow ready access to any program or file on a user created tape.

The use of constant length files implies that every file or program on any cassette has the same space allocated to it regardless of how long the actual program is. This means that some of the tape on the cassette will not actually be used, but the method is much cheaper to use than using C-5/C-10 cassettes for each program/data file.

After experimenting, we found that a maximum FAST FORWARD time of ten seconds is adequate to store the largest program capable to be stored in the PET 8K memory. Of course, this is at the beginning of the tape. As the tape advances, more tape is actually wasted. Still, A C-90 cassette allows approximately 13 large programs or files to be stored and accessed via this method. Access time to the last file on a C-90 cassette is approximately two minutes.

The program shown is pretty self-explanatory and easy to enter.

Usage of this method requires that the program be saved as the first program on every cassette. To use the program, press SHIFT/RUN. After the program is loaded and run, DO NOT press STOP/EJECT on the cassette drive. The program will inquire which drive you are using by displaying:

```
ENTER CASSETTE 1 OR 2
```

After you enter the number only, the program will present a catalog of all files or programs on that tape. Dummy names

will be listed for unused file locations like:

```
PROGRAM 1  
PROGRAM 2
```

Although a C-90 cassette will hold 13 programs, we have chosen to use only ten.

Next, the program will ask if you wish to read or save a program by displaying:

```
READ OR CREATE PROGRAM/FILE --  
R OR C
```

The program will then ask which file you wish to read or write by displaying:

```
WHICH PROGRAM/FILE -- I.E. 1, 2, ...
```

If you have entered a number greater than 1, the machine will display:

```
PRESS F.FWD and HIT RETURN  
WHEN READY
```

(The program will skip the previous step if you ask for program/file number 1 because the tape is already in the correct position). If you enter R to read a file/program, the program will advance the tape to the correct position, stop, and display:

```
HIT STOP/EJECT AND LOAD AS  
USUAL
```

At this point, you simply load the selected program in the usual manner.

William F. Pytlík
6828 Payne
Edwards, CA 93523

Similarly, if you entered C to create a new file/program, the tape will advance to the selected portion of the tape, stop, and display:

```
HIT STOP/EJECT  
TAPE IS NOW READY TO SAVE NEW  
PROGRAM/FILE
```

Now, you can save any program. If you wish to use descriptive names for your programs or files, just reload this program, change the names in the appropriate data statement, and resave the program as the first file on the cassette.

Since the length of a file allocation is determined by time in seconds (the number 10 in line 300 of the program), the user may change this number to accommodate any length file. Also, since each program occupies a unique well-defined location and the length allocated is for a maximum length file, there is no problem replacing one file/program with another.

We use this method on all our tapes. We also use the program as a subroutine in programs requiring access to other files, i.e., a recipe program. The use of the PET cassette drives becomes simple, quick, and enjoyable, and presents a solution to the case of the missing tape counter mystery.



```

10 REM THIS PROGRAM ALLOWS THE PET USER TO
20 REM ACCURATELY POSITION HIS CASSETTE FILES
30 REM BY USING THE FAST FORWARD FUNCTION OF
40 REM THE TAPE DRIVE.
50 REM
60 REM
70 PRINT " *** PROGRAM / FILE LOCATOR ***"
80 PRINT
90 INPUT "ENTER CASSETTE 1 OR 2";CA
100 READ X
110 DIM C$(X)
120 FOR I = 1 TO X
130 READC$(I)
140 PRINTC$(I)
150 NEXT I
160 PRINT:INPUT "READ OR CREATE PROGRAM / FILE -- R OR C";R$
170 INPUT "WHICH PROGRAM / FILE --I.E. 1,2,...";WP
180 IF WP = 1 THEN 240
190 REM STATEMENTS 200 AND 210 INITIALIZE THE MOTOR OFF
200 IF CA = 1 THEN POKE 59411,61
210 IF CA = 2 THEN POKE 59456,223
220 PRINT "PRESS F.FWD AND HIT RETURN WHEN READY"
230 REM STATEMENT 240 WAITS FOR RETURN TO BE DEPRESSED
240 GET A1$:IF A1$ = "" THEN 240
250 REM STATEMENTS 260 AND 270 TURN ON SELECTED MOTOR
260 IF CA = 1 THEN POKE 59411,53
270 IF CA = 2 THEN POKE 59456,207
280 T = TI
290 REM STATEMENT 300 WAITS FOR TAPE TO ADVANCE TO SELECTED FILE
300 IF TI<T+(10*60*(WP-1)) THEN 300
310 REM STATEMENTS 320 AND 330 TURN THE MOTOR OFF
320 IF CA = 1 THEN POKE 59411,61
330 IF CA = 2 THEN POKE 59456,223
340 PRINT
350 IF R$ = "R" THEN PRINT "HIT STOP/EJECT AND LOAD AS USUAL"
360 PRINT:IF R$ = "R" THEN 500
370 IF R$ = "C" THEN PRINT "HIT STOP/EJECT"
380 PRINT "TAPE IS NOW READY TO SAVE NEW PROGRAM/FILE"
390 REM CHANGE NUMBER IN STATEMENT 500 TO CHANGE THE MAX
400 REM NUMBER OF PROGRAMS PER CASSETTE
410 REM CHANGE NAMES IN STATEMENTS 510 THRU 600
420 REM TO YOUR PROGRAM NAMES
500 DATA 10
510 DATA "PROGRAM 1"
520 DATA "PROGRAM 2"
530 DATA "PROGRAM 3"
540 DATA "PROGRAM 4"
550 DATA "PROGRAM 5"
560 DATA "PROGRAM 6"
570 DATA "PROGRAM 7"
580 DATA "PROGRAM 8"
590 DATA "PROGRAM 9"
600 DATA "PROGRAM 10"
1000 END

```

The Basic Morse Keyboard

For the HAMs -- here is a way to use your system to make an ASCII keyboard perform as a Morse keyboard. Implemented on an OSI system, the program is in BASIC and should be readily convertible to other systems.

William L. Taylor
246 Flora Road
Leavittsburg, OH 44430

A computer, as with any appliance, should be a useful tool to aid the owner with his daily tasks, or to bring enjoyment.

Being an amateur radio operator and a computer hobbyist, I felt that the computer should aid the operator with his tasks either when operating the station or other activities. From this desire to have the computer as an assistant, I felt that one of the best uses for my computer was to aid me in sending and receiving of the Morse code. With this in mind I went to work developing a program that would allow me to use the ASCII keyboard as a "Morse Keyboard". The program and the interface information in this article will help other amateur radio operators, who own the OSI Challengers with a Model 500 CPU with the PIA port populated, get on the air with the "Morse Keyboard".

First, an explanation of my system is in order. My computer system consists of the system boards sold by Ohio Scientific Instruments. I have the Model 500 CPU with BASIC in ROM. The PIA port is populated with a 6820 PIA, and is addressed at the standard location on the 500 board. The address for the PIA is 63232 decimal or F700 hex on the 500 CPU board. The program was written to service the 6820 at this location. The BASIC program uses the B side of the 6820 as the output and PBO is the specific port. PBO of the PIA is connected to a tone oscillator board to generate the sidetone and a relay driver on the board is used to drive a 12 volt relay that keys the transmitter.

The "BASIC Morse Keyboard" program is written in MicroSoft BASIC and Assembly Language. The Assembly portion of the program is stored in DATA statements, and is entered into user memory with the READ and POKE functions of BASIC. On initialization, the DATA at line 1620 is READ and POKED into memory with the FOR NEXT loop at line 1605. This machine code store subroutine is called at line 15 at the beginning of the program. The machine code routine is stored at hex 0C00. This

machine code routine calls up the system monitor to get the ASCII code from the system keyboard. When a key is struck on the keyboard the ASCII equivalent of the letter or number is placed in the accumulator of the 6502 microprocessor. The ASCII character is then stored at hex OF00 where it will be available for the BASIC program to capture it with a PEEK statement. This PEEK statement is located at line 125 of the BASIC program.

The contents of hex OF00 will hold the present keyboard ASCII entry, and after being read with the PEEK statement the character will be stored in the A variable. The contents of variable A is now compared with the contents of a look up table to determine the offset to the Morse element table where the conversion to Morse elements are formed. The ASCII table starts at line 130. The Morse element table starts at line 1500.

The Morse equivalent of the ASCII character is loaded into the string variable A\$, and on return from the subroutine the program jumps to a subroutine at line 1000 where the elements of A\$ are separated into the dot-dash elements of Morse code. This separation is done by loading each separate element into D\$, and if the element is a 1 then a dot is generated in a subroutine at line 1200 through line 1220. If the element read into D\$ is the numeral 3 then a jump to the subroutine at line 1300 through 1320 causes a dash to be generated. After each character has been separated and sent to the PIA port the program returns to the input statement line 122. At statement line 122 a jump to the machine code subroutine is executed with the USR function of BASIC. The machine code subroutine causes a jump to the system monitor and the program will loop until a key is depressed on the keyboard.

The subroutine at line 1200 and 1300 generate the Morse elements (dots and dashes). This is done by turning on and off PBO for a duration of time. For example if a 1 was decoded in the routine at 1000 then PBO would be turned on (high) for the duration of time contained in the

loop at line 1205. This loop (FOR J = 1 TO X:NEXT J) is the dot length. The dot length time element is stored in variable X at line 106. When the loop has timed out then PBO will be brought low and a return executed. The next Morse element is identified and generated in either the subroutine at 1200 or 1300 depending if it is a dot or a dash. The dot length, dash length, and the length between characters are contained in variables at lines 102 through 109. The H variable at line 102 holds the information that identifies PBO and turns PBO on in the subroutines at 1200 and 1300. The R variable contents are used to turn PBO off. The variable at line 106 is the dot length. The variable at line 108 is the dash length. The variable at line 109 is the length between characters. This variable can be eliminated if desired. The variables X and R can be adjusted for any desired dot dash length. The routine at lines 10, 20 and 30 initialize the PIA. This initialization sets the B port as the output port. The value in variable G at 100 identifies the initial location of the PIA.

The object code subroutine for the program is stored at Hex 0C00. The object code contents are:

```
0C00 20
0C01 ED
0C02 FE
0C03 8D
0C04 00
0C05 0F
0C06 60
```

The tone oscillator board is a straight forward construction project requiring few components. The schematic in Figure 1 shows the schematic for the tone and relay driver board and the components that will be needed to construct the board. Pref board and a wire wrap socket can be used for the construction of the board or you can etch a board if you feel that would be a more desirable method. A printed circuit board layout was not included in this article because it was felt that the user could use any method that was thought best. The connections to the PIA port on the 500 CPU board can be any length of wire. I used ribbon wire and etched a small board that would mate with a Molex male 12

pin connector such as the connectors on the 480 backplane board. This male plug connects to the 500 CPU board at the B side port connector on the 500 CPU board. The power for the Tone board is taken from the computer except the 12 volt DC for the relay. This must be obtained from another source. Be sure that the external power source ground be connected to the tone board ground in order for the relay keying transistor to work correctly.

A note of warning must be given at this point. The memory size must be set to 3071 decimal when bringing up BASIC. This will be for the protection of the machine code routine that is stored above 0C00 Hex.

In conclusion, the program as written does not have any buffer so typing ahead is not possible. This leaves the program open for modifications, such as, installing the buffer. Also I have a version of the program that allows the operator to load ASCII into a memory zone and use this ASCII as preloaded message text. The program and the sidetone keyer works well on the OSI system used at my shack and I have had many pleasurable hours using the "Morse Keyboard" on CW. I wish you the same. Good luck.

μ

Figure 1

The author wishes to give particular recognition to the article entitled:

"The Morse Master"

which appeared in the January 1979 issue of 73 Magazine, written by William A. Thornburg.

The article provided the concepts upon which this program is based, and gave a program listing for the H8 microcomputer.

Tone Oscillator and Driver Board Parts List

- 1 1N4001 Diode
- 1 Pref board .100 by .100 hole centers
- 1 555 Timer IC
- 1 8 Pin wire wrap socket (or 14 pin)
- 1 .1 MF Disc capacitor
- 1 50 MF Electrolytic capacitor
- 3 10K ½ Watt Resistors
- 1 2N2222 NPN Transistor
- 1 8 Ohm speaker
- 1 12 Volt DC relay
- 1 Male Molex 12 Pin plug KK156
- 1 Wire wrap wire 32 Gauge (if used)
- 1 Hand wire wrap tool (if used)

Radio Shack 276-1394
Radio Shack 276-1723

Radio Shack 40-245
Radio Shack 275-003

Misc. Wire for connection to computer and external 12 volt power supply. Solder

Note: A 14 pin IC socket can be used for the 555. Only use 8 of the pins. I used a Sigma #62R23-2600 relay for RY1.

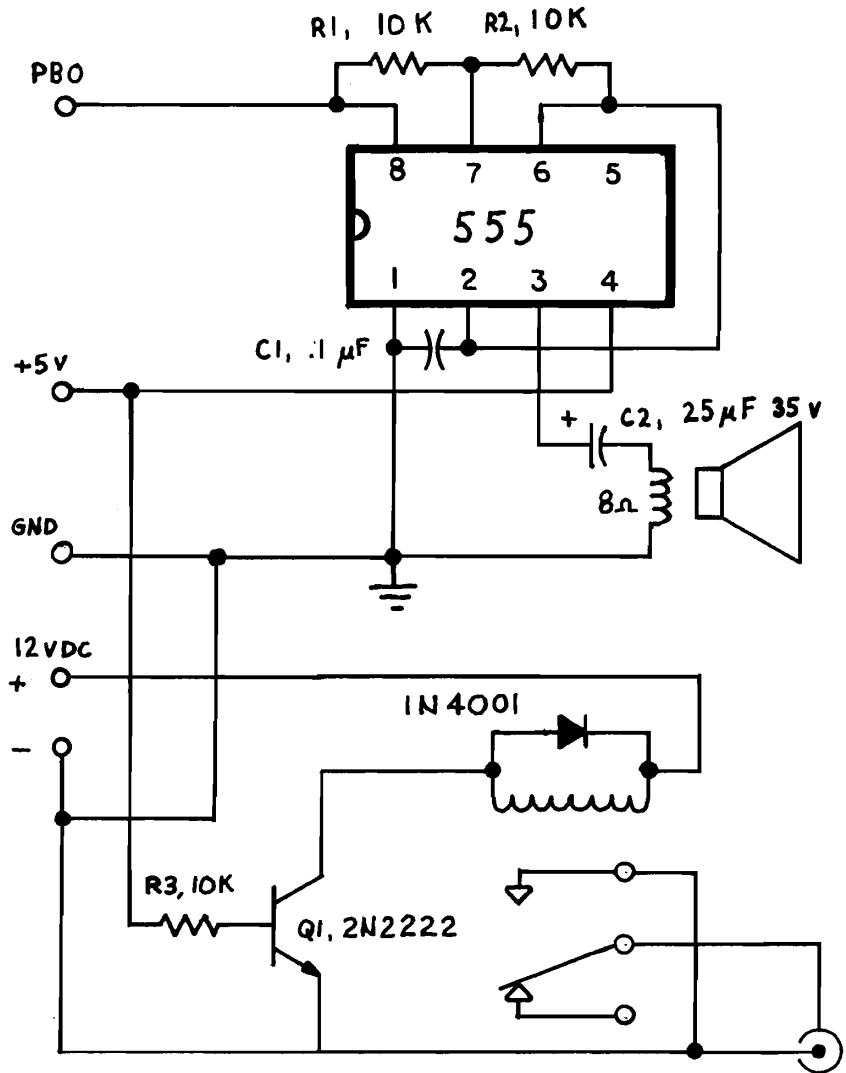

```

1 REM MORSE KEYBOARD FEB 1979
2 PRINT" MORSE CODE KEYBOARD"
3 PRINT:PRINT:PRINT:PRINT
5 " *****READY*****"
10 X=63232
15 GOSUB 1600
20 POKE X+1,0:POKE X+3,0: POKE X,0:POKE X+2,255
30 POKE X+1,04:POKE X+3,04
100 G=63232
102 H=1
104 R=0
106 X=25
108 T=100
109 F=150
110 POKE 11,0:POKE 12,12
122 X=USR(X)
125 A=PEEK(3840)
130 IF A= 65 THEN GOSUB 1500
131 IF A= 66 THEN GOSUB 1501
132 IF A= 67 THEN GOSUB 1502
133 IF A= 68 THEN GOSUB 1503
134 IF A= 69 THEN GOSUB 1504
135 IF A= 70 THEN GOSUB 1505
136 IF A= 71 THEN GOSUB 1506
137 IF A= 72 THEN GOSUB 1507
138 IF A= 73 THEN GOSUB 1508
139 IF A= 74 THEN GOSUB 1509
140 IF A= 75 THEN GOSUB 1510
141 IF A= 76 THEN GOSUB 1511
142 IF A= 77 THEN GOSUB 1512
143 IF A= 78 THEN GOSUB 1513
144 IF A= 79 THEN GOSUB 1514
145 IF A= 80 THEN GOSUB 1515
146 IF A= 81 THEN GOSUB 1516
147 IF A= 82 THEN GOSUB 1517
148 IF A= 83 THEN GOSUB 1518
149 IF A= 84 THEN GOSUB 1519
150 IF A= 85 THEN GOSUB 1520
151 IF A= 86 THEN GOSUB 1521
152 IF A= 87 THEN GOSUB 1522
153 IF A= 88 THEN GOSUB 1523
154 IF A= 89 THEN GOSUB 1524
155 IF A= 90 THEN GOSUB 1525
156 IF A= 48 THEN GOSUB 1526
157 IF A= 49 THEN GOSUB 1527
158 IF A= 50 THEN GOSUB 1528
159 IF A= 51 THEN GOSUB 1529
160 IF A= 52 THEN GOSUB 1530
161 IF A= 53 THEN GOSUB 1531
162 IF A= 54 THEN GOSUB 1532
163 IF A= 55 THEN GOSUB 1533
164 IF A= 56 THEN GOSUB 1534
165 IF A= 57 THEN GOSUB 1535
166 IF A= 46 THEN GOSUB 1536
167 IF A= 63 THEN GOSUB 1537
168 IF A= 64 THEN GOSUB 1538
169 IF A= 47 THEN GOSUB 1539
170 IF A= 44 THEN GOSUB 1540
172 GOSUB 1000
175 FOR I= 1 TO F : NEXT I
180 FOR M= 1 TO G9: NEXT M
190 GOTO 122

```

```

1000 L= LEN (A$)
1005 FOR I= 1 TO L
1010 R$=MID$ (A$,I,1)
1015 IF R$= "1" THEN GOSUB 1200
1020 IF R$= "3" THEN GOSUB 1300
1025 NEXT I
1030 GOTO 1320
1200 POKE G+2,H
1205 FOR J= 1 TO X: NEXT J
1210 POKE G+2,R
1215 FOR J= 1 TO X: NEXT J
1220 RETURN
1300 POKE G+2, H
1305 FOR J= 1 TO X: NEXT J
1310 POKE G+2, R
1315 FOR J= 1 TO X: NEXT J
1320 RETURN
1500 A$= "13": RETURN
1501 A$= "3111":RETURN
1502 A$= "3131":RETURN
1503 A$= "311" :RETURN
1504 A$= "1" :RETURN
1505 A$= "1131":RETURN
1506 A$= "331" :RETURN
1507 A$= "1111":RETURN
1508 A$= "11" :RETURN
1509 A$= "1333":RETURN
1510 A$= "313" :RETURN
1511 A$= "1311":RETURN
1512 A$= "33" :RETURN
1513 A$= "31" :RETURN
1514 A$= "333" :RETURN
1515 A$= "1331":RETURN
1516 A$= "3313":RETURN
1517 A$= "131" :RETURN
1518 A$= "111" :RETURN
1519 A$= "3" :RETURN
1520 A$= "113" :RETURN
1521 A$= "1113":RETURN
1522 A$= "133" :RETURN
1523 A$= "3113":RETURN
1524 A$= "3133":RETURN
1525 A$= "311" :RETURN
1526 A$= "33333" :RETURN
1527 A$= "13333" :RETURN
1528 A$= "11333" :RETURN
1529 A$= "11133" :RETURN
1530 A$= "11113" :RETURN
1531 A$= "11111" :RETURN
1532 A$= "31111" :RETURN
1533 A$= "33111" :RETURN
1534 A$= "33311" :RETURN
1535 A$= "33331" :RETURN
1536 A$= "131313":RETURN
1537 A$= "113311":RETURN
1538 A$= "31113" :RETURN
1539 A$= "31131" :RETURN
1540 A$= "331133":RETURN
1600 FOR R= 3072 TO 3078
1605 READ Q: POKE R,Q: NEXT R
1610 RETURN
1620 DATA 32,237,254,141,0,15,96

```

“ \$995

FOR A FLOPPY DISK BASED
COMPUTER ? ”

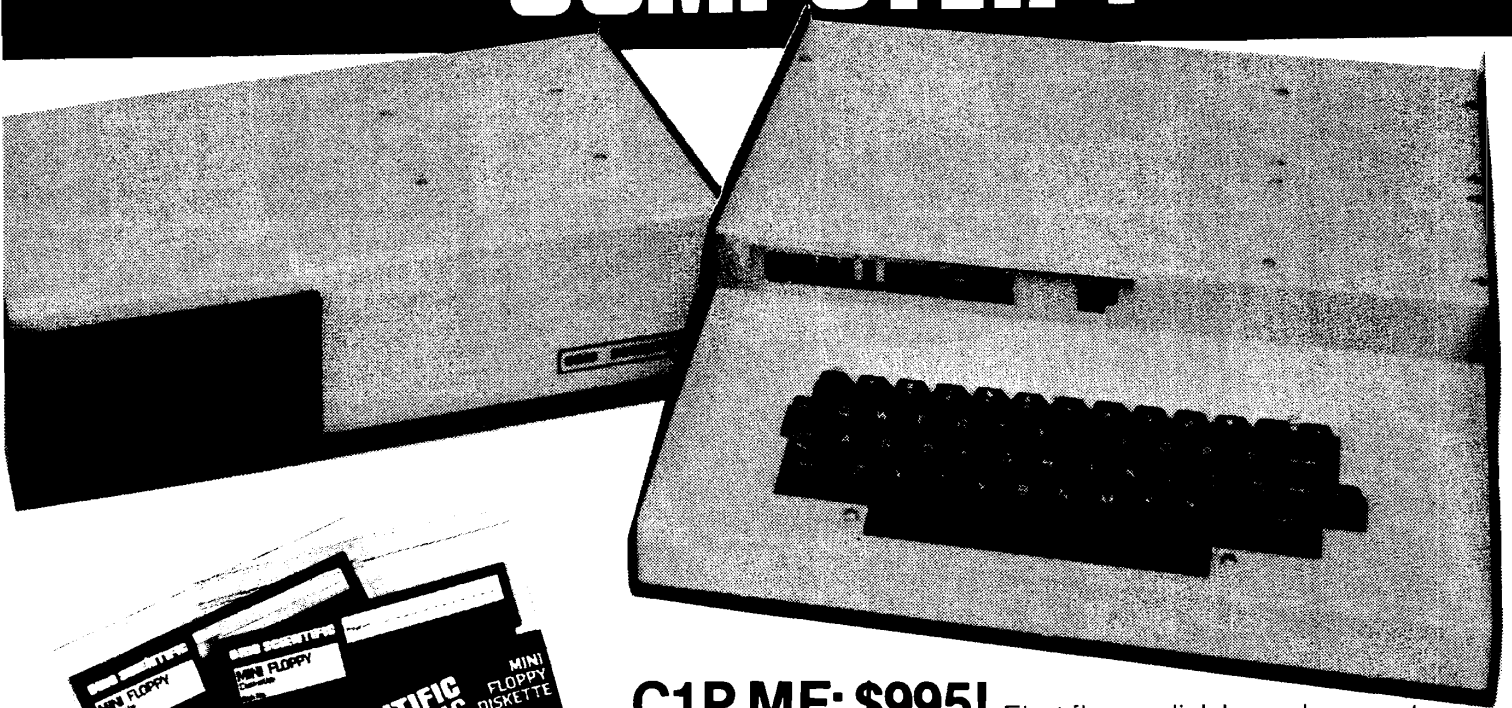

C1P MF: \$995! First floppy disk based computer for under \$1000! A dramatic breakthrough in price and performance. Features OSI's ultra-fast BASIC-in-ROM, full graphics display capability, and large library of software on disk, including entertainment programs, personal finance, small business, and home applications. It's a complete programmable computer system ready to go. Just plug-in a video monitor or TV through an RF converter, and be up and running.

Can be expanded to 32K static RAM and a second mini-floppy. It also supports a printer, modem, real time clock, and AC remote interface, as well as OS-65D V3.0 development disk operating system.

VISA AND MASTER-
CHARGE ORDERS ARE
BOTH ACCEPTED.

COMPUTERSHOP

288 Norfolk St. (Cor. Hampshire St.)
Cambridge, Mass. 02139
617-661-2670

590 Commonwealth Ave.
Boston, Mass. 02215
617-247-0700

Route 16B
Union, N.H. 03887
603-473-2323

A SYM-phony in Stereo

All you Symmers who are frustrated because you can not play the music from Star Wars on your systems -- take heart. Here is a program that not only plays music, but plays it in STEREO!

Phillip M. Rinard
2019 Park Ave.
Emporia, KS 66801

Excellent tune player programs for computers abound, but some features of the SYM-1 make it easy to generate stereo music and may be of interest to SYM-1 owners. Such a program also illustrates some of the uses of the on-board UART's (a SY6532 and two SY6522's) and some of the SUPERMON monitor routines. The listing explains the procedures of the program, but a few comments here may be helpful. With no attempt at making use of the memory at the greatest efficiency, each stereo note consists of five bytes: the duration is given by the first byte, then two bytes give the frequency for each of the two stereo tones having that duration. For the program given, the duration is in multiples of about 0.01 second and is timed by counting down in the 6532. The frequency bytes are placed into the latches of the 6522's for use in the timer 1, free-running mode. The 6522's timers generate square-wave outputs with a frequency based on the contents of the latches. The 6532 timer computes when the next 5 bytes should be

read and new values placed in the latches.

Two subroutines allow for repeating all or part of the tune. A duration byte of \$FF causes a return to the beginning of the tune for a single repeat of the tune up to that point. Upon reading the \$FF a second time, the repeat is ignored and the rest of the tune played. If the duration is \$00, the tune is over, but immediately begun again as if for the first time. The output port AA used by the 6522 #3 is buffered and thus can drive a speaker after putting about a 200 Ohm resistor between two points of the rightmost buffer's PC holes. As shown on page 4-12 of the SYM Reference Manual, these are points 4 and the one between and below points C and 7. The A port can be buffered by one of the three remaining on-board buffers (or one of your own off the board). Place another 200 Ohm resistor in another set of PC board holes and place the input signal from port A on the exposed wire of the

on-board resistor immediately above the transistor. The outputs to both speakers are then available from port AA (see page 4-11 of the SYM Reference Manual for exact pin numbers).

As an illustration of the stereo player, a listing of data for the "Star Wars" music is given. The "notes" of zero frequency provide brief intervals of silence between notes to more realistically imitate a musical instrument. This program and data fit into the 1K of on-board memory provided from the factory. Sockets for 3K more memory are present, as is a socket for a third 6522. If more of this memory is used for extended tunes, then additional programming is necessary similar to that in locations 1B through 21 where "starting" addresses are changed so that as the Y register increments up to 255 the proper note is retrieved. Obviously, an enthusiast could expand on this type of program with the SYM-1 capabilities. μ

KIM/SYM/AIM ACCESSORIES BY MTU

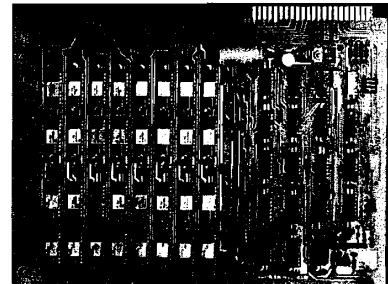
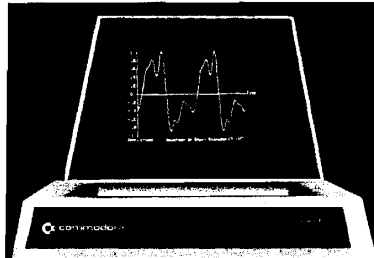
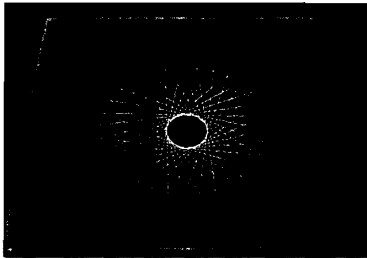

REAL GRAPHICS FROM OUR VISIBLE MEMORY

Over the last year and a half we have delivered hundreds of our Visible Memory graphic display boards and customers are still finding novel uses for them. The Visible Memory is an 8K byte memory board that is directly compatible with the KIM/SYM/AIM computers and functions just like an 8K memory expansion. Its content however is also displayed on a standard video monitor as a 320 by 200 dot array with each dot corresponding to a bit in memory. Since each dot is individually controllable, any kind of image, even text (22 lines, 53 characters) with subscripts/superscripts is possible. Our assembly language graphics/text software package makes programming the Visible Memory easy. Microsoft 9-digit BASIC users now have access to the graphics and text routines through our just released BASIC Patches Package. In fact, the images above were created entirely with SIMPLE BASIC programs.

K-1008A VISIBLE MEMORY \$240.00 OTHER ITEMS

KIM Power supply \$35.00 AIM Power supply \$80.00
Enclosed card file for 4 boards KIM \$75 SYM \$80 AIM \$95
8-bit audio system DAC-Filter-Amp. KIM/SYM/AIM \$40 PET \$50
PET to MTU style KIM/SYM/AIM bus adaptor \$79
Prototyping board, fits in card file, 2 regulators \$42
We have sophisticated music and graphics software too!

PLEASE REQUEST OUR NEW, EXPANDED SPRING 1979 CATALOG

MICRO TECHNOLOGY UNLIMITED, 841 Galaxy Way, Box 4596, Manchester, NH 03103 (603) 627-1464

16K LOW POWER MEMORY

Do you want more memory for your KIM/SYM/AIM but don't have a 5 amp power supply or fan to cool it? Our 16K low power dynamic RAM board is designed for these processors and draws a mere 200MA from 8 volts unregulated and 200MA max (75 MA typical) from +16 volts unregulated. Our little K-1000 power supply can in fact run 64K of these boards plus a KIM easily.

K-1016A 16K RAM \$340.00

We now have available a multifunction system board for the KIM/SYM/AIM processors. It has a PROM capacity of 12K using the industry standard 2708 PROM or 14K using the readily available TI 2716. Also included is a 2708/2716 PROM programmer, 4 parallel ports, and a bidirectional serial port. Low power: +8 at 350MA, +16 250MA.

K-1012A PROM/10 \$237.00

SYM-1 STEREO TUNE PLAYER

BY PHILLIP M. RINARD
MAY 1979

MODIFIED BY MIKE ROWE

SUPERMON REFERENCES

ACCESS * \$8B86 ACCESS SUBROUTINE
 OUTBYT * \$82FA OUTPUT BYTE SUBROUTINE
 OUTCHR * \$8A47 OUTPUT CHARACTER TO DISPLAY
 ACR * \$A00B AUXILIARY CONTROL REGISTER
 ACRX * \$AC0B ACR DIFFERENT VIA
 IER * \$A00E INTERRUPT ENABLE REGISTER
 IERX * \$AC0E IER DIFFERENT VIA
 TOL * \$A006 TIMER LATCH
 TOC * \$A005 COUNTER
 TOLX * \$AC06 TIMER LATCH
 TOCX * \$AC05 COUNTER
 STIME * \$A41E 6532 TIMERS
 RTIME * \$A404

D
U
R
A
T
I
O
N
F
R
E
Q
F
R
E
Q
ONE TWO

J000

ORG \$0000

0000 00 LOW = \$00 LOW POINTER
 0001 00 HIGH = \$00 HIGH POINTER
 0002 00 REPEAT = \$00 REPEAT COUNTER

TUNE TABLE POINTERS

0003 00 TUNES = \$00 OFFSET FOR FIRST TUNE
 0004 70 FIRST = \$70 FIRST TUNE LOW
 0005 02 = \$02 FIRST TUNE HIGH 0270
 0006 70 SECOND = \$2F SECOND LOW
 0007 03 = \$03 SECOND HIGH 032F
 0008 FF END = \$FF END OF TUNE TABLE

MAIN PROGRAM

0200

ORG \$0200

0200 20 86 8B MAIN JSR ACCESS ALLOW WRITING TO SYSTEM RAM
 0203 A9 C0 LDAIM \$C0 SET ACR6,7 = 1
 0205 8D 0B A0 STA ACR FOR TIME 1, FREE RUNNING
 0208 8D 0B AC STA ACRX WITH OUTPUT ENABLED
 020B A9 7F LDAIM \$7F DISABLE IRQ
 020D 8D 0E A0 STA IER WITH

270 05 00 00 00 00
 275 60 BC 03 DA 0B
 27A 05 00 00 00 00
 27F 30 FC 04 F7 09
 284 05 00 00 00 00
 289 07 ED 05 DA 0B
 28E 05 00 00 00 00
 293 07 A7 06 4C 0D
 298 05 00 00 00 00
 29D 07 77 07 EE 0E
 2A2 07 00 00 00 00
 2A7 60 BC 03 DA 0B
 2AC 05 00 00 00 00
 2B1 30 FC 04 F7 09
 2B6 05 00 00 00 00
 2BB 07 ED 05 DA 0B
 2C0 05 00 00 00 00
 2C5 07 A7 06 4C 0D
 2CA 05 00 00 00 00
 2CF 07 77 07 EE 0E
 2D4 07 09 00 00 00
 2D9 60 BC 03 DA 0B
 2DE 05 00 00 00 00
 2E3 30 FC 04 F7 09
 2E8 05 00 00 00 00
 2ED 07 98 05 E1 08
 2F2 05 00 00 00 00
 2F7 07 ED 05 E9 07
 2FC 05 00 00 00 00
 301 07 98 05 E1 08
 306 05 00 00 00 00
 30B 60 A7 06 F7 09
 310 20 00 00 00 00
 315 07 FC 04 00 00
 31A 05 00 00 00 00
 31F 07 FC 04 00 00
 324 05 00 00 00 00
 329 07 F7 09 F7 09
 32E FF



PET™

We have the Most Complete Stock of APPLE and PET Software in Southern California. (Send for our Catalog — \$1.00)

**16K RAM CHIP SET FOR APPLE II
ONLY (Tested & Burned In) \$95⁰⁰**

WORKSHOPS: Call for details.

- PET—3rd Saturday of the Month
- APPLE—4th Saturday of the Month

CLASSES: Apple Topics

We offer a series of classes on Apple II to acquaint owners with some of the unique features and capabilities of their system. Topics covered are Apple Sounds, Low Res. Graphics, Hi Res. Graphics, Disk Basics, and How to Use Your Reference Material. Sessions are held every Thursday Night at 7:00 p.m.

Reference Books For APPLE and PET Owners

- Programming the 6502 9.95
- PET User Manual (New from Commodore) 9.95
- First Book of KIM 8.95
- MOS Tech Programming Manual (6502) 12.00
- MOS Tech Hardware Manual 12.00

HARDWARE

APPLE II HARDWARE:

- **Upper & Lower Case Board**
Now you can display both upper and lower case characters on your video with the Apple II. Includes assembled circuit board and sample software \$49.95
- **Programmer Aide** \$50.00

PRINTER SPECIALS FOR APPLE AND PET

- **TRENDCOM 100** with interface for Apple or PET \$450.00

LIMITED QUANTITY

Refurbished Selectric typewriters serially interfaced for plug in to APPLE II \$1000.00
All orders must be prepaid. Delivery in 4 to 8 weeks ARO or full refund.

- **Anadex DP-8000** with tractor
8" paper width and Apple interface \$1050
- **Centronics 779-2 for Apple II**
With parallel interface \$1245.00

**JOIN THE APPLE COMMUNICATION NETWORK
(APPLE COM-NET)**

Computer Components of Orange County is initiating a communication network for all APPLE OWNERS. We need the help of dedicated Apple users. Become a CHARTER MEMBER of this APPLE TEAM by helping us set up this network. Contact Dave Smith or Dwain Graham 714-891-2584.

****COMPLETE COMMUNICATION HARDWARE**
FOR YOUR APPLE ****\$379.00******

**See if you qualify for a CCI of OC P/F Card
and get great discounts on selected
purchases for your Apple and PET.**

PET HARDWARE

- **PET 2001-8 Computer** Standard PET with integral cassette and calculator type keyboard 8K bytes of memory (7167 net) \$795.00
- **PET 2001-16N Computer** PET with 16K bytes of memory and large keyboard with separate numeric pad and graphics on keys. External cassette optional. (15,359 net) \$995.00
- **PET 2001-16B Computer** As above but has standard type-writer keyboard. No graphic keys \$995.00
- **PET 2001-32N Computer** Identical to 2001-16N with 32K bytes of memory. (31,743 net) \$1,195.00
- **PET 2001-32B Computer** Identical to 2001-32N with 32K bytes of memory. (31,743 net) \$1,195.00

PERIPHERALS

- **PET 2021 Printer** 80 column dot matrix electrostatic printer with full PET graphics capability \$549.00
- **PET 2022 Printer** 80 column dot matrix printer with plain paper or forms handling tractor feed. Has full PET graphics \$995.00
- **PET 2023 Printer** 80 column dot matrix printer. Plain paper printer with full PET graphics \$849.00
- **PET 2040 Dual Drive Mini Floppy Disk*** Dual drive intelligent mini floppy system. 343K net user storage capacity \$1,095.00
- **PET 2041 Single Drive Floppy Disk** Single drive intelligent mini floppy 171.5K net user storage \$595.00
- **PET External Cassette** Cassette player/recorder to use with PET 2001/8/16/32 \$95.00
- **PET User Manual** 160 page expanded user manual covering all facets of user operation, programming and I/O for PET computers \$9.95

*Retrofit kit required for operation with PET 2001-8.

WHY SHOULD YOU BUY FROM US?

Because we can help you solve your problems and answer your questions. We don't claim to know everything, but we try to help our customers to the full extent of our resources.

—Prices subject to change.—

COMPUTER COMPONENTS OF ORANGE COUNTY

6791 Westminster Ave., Westminster, CA 92683 714-891-2584

Hours: Tues-Fri 11:00 AM to 8:00 PM—Sat 10:00 AM to 6:00 PM (Closed Sun, Mon)

Master Charge, Visa, B of A are accepted. No COD. Allow 2 weeks for personal check to clear.

Add \$1.50 for handling and postage. For computer systems please add \$10.00 for shipping, handling and insurance. California residents add 6% Sales Tax.

Sorting with the APPLE II

Part I

The first of a series of articles which will deal with sorting in general and on the APPLE II in particular. This installment presents some background material, a comparison of three sorting techniques, and a program for implementing the Shell-Metzner sort.

Gary A. Foote
127 Mt. Spring Road
Tolland, CT 06084

Whether you are maintaining complex data bases, compiling mailing lists, or simply keeping track of your checkbook, at some time you will need to sort records. There are a multitude of sorts available — from the agonizingly slow one in the APPLE CHECKBOOK program, through the relatively fast BASIC sort, to my exceedingly fast (by a factor of 200) machine language sort. What makes a sort fast, and which sort is the fastest? These are the questions I will cover in my series on exploring sorting with the APPLE II.

Background

There have been many magazine articles written on sorting. The ones I based my initial investigation on were those in the Nov-Dec 1976 issue of CREATIVE COMPUTING covering the SHELL-METZNER, bubble, delayed replacement, and heapsorts, and the JAN-FEB 1978 issue of the same magazine on the Butterfly-Hart sort. The first article found the Shell-Metzner and heapsorts to be a vast improvement over the bubble and delayed replacement sorts. The second article found the Butterfly-Hart to be even faster. The Shell-Metzner and heapsort are replacement-type sorts; that is, the records are compared to one another and replace each other according to some unique algorithm. They are relatively small in size and don't rely on much extra storage for their processing. The Butterfly-Hart is a linked list sort. A tree structure is built from the records and broken down into several smaller sorted lists. These lists are then merged to form the final result. This sort is much faster for large numbers of records, but is quite complex and requires extra storage to hold the lists and tree structure. For more details on how these sorts operate, I leave you to refer to the original articles.

I programmed each of these sorts in INTEGER BASIC and compared them by sorting various numbers of random ten character strings. Below were the results.

Table I — Sorting in BASIC

	SORTED WORDS			
SORT	10	100	500	1000
SHELL-METZNER	1	34	268	647
BUTTERFLY-HART	2	38	266	606
HEAPSORT	1	35	261	600

(All sorting times in seconds)

For further exploration, I decided to use the Shell-Metzner sort because it was easiest to program and most compact. Many things had to be taken into account before implementing this sort in INTEGER BASIC. Because of the limited string support in this BASIC, it is easier to store records to be sorted in memory between the upper end of the data variables and the lower end of the program area, accessing them with PEEK's and POKE's. At first, as I sorted these records, I exchanged the actual records in memory when necessary. This becomes very time consuming because for exchanging two 10 character records, you must move 30 bytes (10 to a work area, 10 from one record to the other, and 10 from the work area back to the other record). A much more elegant technique is to store the address of each record as a member of an array. When an exchange is necessary, you need only exchange the addresses in the array, a total move of 6 bytes (2 + 2 + 2) for any size record. When the sort is complete, the addresses of the sorted records can be found sequentially in the array. The first member of the array will point to the lowest sorted record, and the last member to the highest sorted one. The records can be read out in the proper order quite simply, and can easily be sorted in reverse order simply by reading the array backwards. The beauty of this method is that the records have never actually moved and can be read in the original order as simply as the sorted order. This reduction alone increases the

speed of the sort by a factor of three for a 100 record sort, and exponentially above that.

My BASIC version is divided into several parts. The first part generates random character strings in memory, depending on the record size and count entered. This is for benchmark tests and can be replaced with your own I/O routine for your application. Line 140 actually puts the random characters in memory, so replacing this line with a REM after your first run allows you to test other sorting methods while using the same records. The second part merely initializes the memory pointer array and prints the unsorted strings. This can also be included in your I/O routine. The third part is the actual SHELL-METZNER sort. The routine can be easily changed if you wish to sort numbers in an array instead of strings in memory. Finally, there is a routine to print the results, and a handy routine from CALL-APPLE for finding the address of a variable in the data area.

SWEET-16 for Size

Never being satisfied, I decided to continue another step and try to program the sort routine in SWEET-16 (as all you APPLE people know, a 16 bit interpreter implemented in ROM). An excellent article in the NOV 1977 issue of BYTE (or the BEST OF BYTE VOL 1) was my source for SWEET-16 information. SWEET-16 was 4 to 9 times faster than the BASIC sort, and very compact due

to the powerful instruction set. But due to difficulty in implementing, and because the machine language routine was several orders of magnitude faster, I am not including this material. Don't feel bad. Because I know of no SWEET-16 assembler, writing this program was actually harder than the machine language version.

Machine Language for Speed

The machine language implementation of SHELL-METZNER was not difficult, because I was almost translating directly from each BASIC statement into equivalent functions in machine code. As you can see by the listing in Figure 2, I made extensive use of PAGE ZERO addressing, both to cut down on code and increase speed. I left in BASIC all the I/O routines and setup necessary to prepare the sort, since this is quite easy in BASIC and I already had the program written from the first problem. The actual sort algorithm is the only part I programmed in machine code. Thus we get the benefit of BASIC for I/O, printing, etc. in 1% of the execution, and the machine code speed for the repetitive looping in 99% of the execution. Using this machine language sort is relatively easy. The BASIC routine in Figure

3 sets up the variables needed by the sort and calls the machine language routine. It can be substituted for the sort routine in the BASIC version in Figure 1 (lines 1000-1900). The sort routine itself (in Figure 2) is loaded at address 300-3C2. This routine is easily relocatable to any other address (say 800 if you are using 300 for another routine). All you need to do is load it where desired and change the last two instructions (2 JMP commands) to reflect your new location. You must, of course, change the CALL in your BASIC program also. Below is a comparison of my three different implementations of the Shell-Metzner sort.

The maximum number of records you can sort is easily determined by taking the memory size between data high and program low and dividing it by the record size + 2 (the size of the array element needed to hold the pointer to the record). I find with a 32K machine running DOS, I have 18K free. More memory is available if you want to lose DOS of course. Machine language routines may be more trouble to implement, but with an increase in speed over BASIC by a factor of 200, you cannot ignore them. In Part II I will continue my investigation by exploring sorting APPLESORT character strings with multiple keys. Until then, happy sorting!

μ

Table II — Comparison of Three Methods

METHOD	SORTED WORDS X WORD LENGTH		
	500 X 10	1000 X 10	3600 X 3
BASIC	268	746	4200 (70 min)
SWEET-16	46	158	—
MACHINE	1	3	21

(All sorting times in seconds)

Figure 1

```

10 REM *****
20 REM * SHELL-METZNER SORT *
30 REM * BY GARY FOOTE *
40 REM *****
50 CALL -936: PRINT : PRINT "SHELL-METZNER SORT": PRINT
60 INPUT "ENTER RECORD COUNT AND LENGTH",NUM,LEN
70 DIM A$(255),A(NUM)
80 I=J=K=L=M=X=T=Z=LL=II=LM=HM=ADDR=W: REM SAVE SPACE FOR VARIABLES
90 LM=PEEK(204)+PEEK(205)*256:HM=PEEK(202)+PEEK(203)*256
95 REM
100 REM ***** FILL MEMORY WITH DATA *****
105 REM
110 PRINT : PRINT "CREATING RANDOM STRINGS"
120 IF LM+LEN*NUM<HM THEN 140
130 PRINT "TOO MUCH DATA!!": END
140 FOR X=1 TO LEN*NUM: POKE LM+X, RND(26)+193: NEXT X
150 REM
200 REM ***** INITIALIZE MEMORY POINTER ARRAY *****
205 REM
210 A$="A$": GOSUB 4000
220 FOR X=1 TO NUM:A(X)=(X-1)*LEN+LM+1
230 T=A(X): GOSUB 3000
240 NEXT X
250 REM

```

```

1000 REM ***** SORT ROUTINE *****
1010 REM
1100 PRINT : PRINT "STARTING SORT"
1200 N=NUM:M=N
1300 M=M/2: IF M=0 THEN 1900:K=N-M:J=1
1400 I=J
1500 L=I+M:II=A(I):LL=A(L)
1600 FOR X=0 TO LEN-1:W=PEEK (II+X)-PEEK (LL+X): IF W<0 THEN 1800: IF
W>0 THEN 1700: NEXT X: GOTO 1800
1700 T=A(I):A(I)=A(L):A(L)=T:I=I-M: IF I>=1 THEN 1500
1800 J=J+1: IF J>K THEN 1300: GOTO 1400
1900 PRINT : PRINT "ENDING SORT"
1910 REM
2000 REM ***** PRINT RESULTS *****
2005 REM
2010 A$="A$": GOSUB 4000
2020 FOR X=1 TO NUM
2030 T=A(X): GOSUB 3000
2040 NEXT X
2050 END
2060 REM
3000 REM ***** STRING PRINT ROUTINE *****
3005 REM
3010 FOR Z=0 TO LEN-1
3020 POKE ADDR+Z, PEEK (T+Z): REM ARRAY A$
3030 NEXT Z: POKE ADDR+Z,30
3040 PRINT X,A$
3050 RETURN
3060 REM
4000 REM ***** FIND VARIABLE'S ADDRESS
4005 REM
4010 ADDR=PEEK (74)+PEEK (75)*256-1:K=LEN(A$):J=PEEK (204)+PEEK (205
)*256-1:L=0: IF A$(K,K)="#" THEN 4020:K=K-1:L=1
4020 FOR I=1 TO K: IF ASC(A$(I))#PEEK (ADDR+I) THEN 4040: NEXT I
4030 IF PEEK (ADDR+I+L)>1 THEN 4040:ADDR=ADDR+K+4+L: RETURN
4040 FOR I=1 TO 100: IF PEEK (I+ADDR)>1 THEN NEXT I:I=ADDR+I+1:ADDR=PEEK
(I)+PEEK (I+1)*256-1
4050 IF ADDR<J THEN 4020: PRINT "VARIABLE ";A$;" NOT FOUND": END

```

Figure 2

```

1000 REM ***** SORT ROUTINE *****
1010 REM
1100 PRINT : PRINT "STARTING SORT"
1200 A$="A": GOSUB 4000
1300 POKE 0,ADDR MOD 256: POKE 1,ADDR/256: REM STORE ARRAY ADDRESS
1400 POKE 2,LEN: REM STORE RECORD LENGTH (MUST BE < 256)
1500 POKE 4,NUM MOD 256: POKE 5,NUM/256: POKE 6,NUM MOD 256: POKE 7,NUM/
256: REM STORE NUMBER OF RECORDS
1600 CALL 768: REM CALL SORT ROUTINE
1700 PRINT : PRINT "ENDING SORT"

```

Figure 3

```

1000 *-----*
1010 *      SHELL-METZNER SORT      *
1020 *      BY GARY A. FOOTE      *
1030 *      COPYRIGHT 1979        *
1040 *      COMMERCIAL RIGHTS RESERVED *
1050 *-----*
1060 *
1070 *      VARIABLES AND CONSTANTS
1080 *
1090 * ALL VARIABLES ARE TWO BYTES.
1100 * THE LISTED NAME IS THE LOW ORDER BYTE.
1110 * THE NAME+1 IS THE HIGH ORDER BYTE.
1120 * EX.  I   = LOW ORDER BYTE
1130 *      I+1 = HIGH ORDER BYTE
1140 *
1150 ADRA .EQ $00      ARRAY A ADDRESS
1160 LEN  .EQ $02      RECORD LENGTH
1170 N    .EQ $04      NUM OF RECORDS
1180 M    .EQ $06      M
1190 I    .EQ $08      I (RECORD I)
1200 L    .EQ $0A      L (RECORD L)
1210 J    .EQ $0C      J
1220 K    .EQ $0E      K
1230 PTRI .EQ $10      PTR TO ADDR OF A(I)
1240 PTRL .EQ $12      PTR TO ADDR OF A(L)
1250 ADRI .EQ $14      ADDR OF REC A(I)
1260 ADRL .EQ $16      ADDR OF REC A(L)
1270 *
1280 *      SORT ROUTINE
1290 *
1300      .OR $300
0300 = 46 07 1310 SORT LSR M+1      M = M / 2
0302 = 66 06 1320      ROR M
0304 = D0 05 1330      BNE SRT1      IF M = 0
0306 = A5 07 1340      LDA M+1
0308 = D0 01 1350      BNE SRT1      THEN
030A = 60      1360      RTS          DONE!
030B = 38      1370 SRT1 SEC
030C = A5 04 1380      LDA N          K = N - M
030E = E5 06 1390      SBC M
0310 = 85 0E 1400      STA K
0312 = A5 05 1410      LDA N+1
0314 = E5 07 1420      SBC M+1
0316 = 85 0F 1430      STA K+1
0318 = A9 01 1440      LDA #1      J = 1
031A = 85 0C 1450      STA J
031C = A9 00 1460      LDA #0
031E = 85 0D 1470      STA J+1
0320 = A5 0C 1480 SRT2 LDA J      I = J
0322 = 85 0B 1490      STA I
0324 = A5 0D 1500      LDA J+1
0326 = 85 09 1510      STA I+1

```

0328- 18	1520	SRT3	CLC	
0329- A5 08	1530		LDA I	L = I + M
032B- 65 06	1540		ADC M	
032D- 85 0A	1550		STA L	
032F- A5 09	1560		LDA I+1	
0331- 65 07	1570		ADC M+1	
0333- 85 0B	1580		STA L+1	
0335- A5 00	1590		LDA ADRA	INITIALIZE PTRS
0337- 85 10	1600		STA PTRI	TO ARRAY A
0339- 85 12	1610		STA PTRL	ADDRESS
033B- A5 01	1620		LDA ADRA+1	
033D- 85 11	1630		STA PTRI+1	
033F- 85 13	1640		STA PTRL+1	
0341- A0 02	1650		LDY #2	
0343- 18	1660	SRT4	CLC	
0344- A5 10	1670		LDA PTRI	PTR TO A(I) =
0346- 65 08	1680		ADC I	ADDR ARRAY A +
0348- 85 10	1690		STA PTRI	2 * I
034A- A5 11	1700		LDA PTRI+1	
034C- 65 09	1710		ADC I+1	
034E- 85 11	1720		STA PTRI+1	
0350- 18	1730		CLC	
0351- A5 12	1740		LDA PTRL	PTR TO A(L) =
0353- 65 0A	1750		ADC L	ADDR ARRAY A +
0355- 85 12	1760		STA PTRL	2 * L
0357- A5 13	1770		LDA PTRL+1	
0359- 65 0B	1780		ADC L+1	
035B- 85 13	1790		STA PTRL+1	
035D- 88	1800		DEY	DO 2 TIMES
035E- D0 E3	1810		BNE SRT4	(PTR DISP IS 2 BYTES)
0360- B1 10	1820		LDA (PTRI),Y	II = A(I)
0362- 85 14	1830		STA ADRI	
0364- B1 12	1840		LDA (PTRL),Y	
0366- 85 16	1850		STA ADRL	
0368- C8	1860		INY	
0369- B1 10	1870		LDA (PTRI),Y	LL = A(L)
036B- 85 15	1880		STA ADRI+1	
036D- B1 12	1890		LDA (PTRL),Y	
036F- 85 17	1900		STA ADRL+1	
0371- 88	1910		DEY	
0372- B1 14	1920	SRT5	LDA (ADRI),Y	COMPARE ONE BYTE IN
0374- D1 16	1930		CMP (ADRL),Y	RECORDS I & L
0376- 90 31	1940		BCC SRT8	I < L
0378- D0 07	1950		BNE SRT6	I > L
037A- C8	1960		INY	I = L
037B- C4 02	1970		CPY LEN	END OF RECORD?
037D- D0 F3	1980		BNE SRT5	NO, NEXT BYTE
037F- F0 28	1990		BEQ SRT8	RECORDS EQUAL
0381- A0 00	2000	SRT6	LDY #0	
0383- A5 14	2010		LDA ADRI	A(I) <-> A(L)
0385- 91 12	2020		STA (PTRL),Y	
0387- A5 16	2030		LDA ADRL	
0389- 91 10	2040		STA (PTRI),Y	
038B- C8	2050		INY	
038C- A5 15	2060		LDA ADRI+1	

```

038E- 91 12      2070      STA (PTRL),Y
0390- A5 17      2080      LDA ADRL+1
0392- 91 10      2090      STA (PTRI),Y
0394- 38         2100      SEC
0395- A5 08      2110      LDA I           I = I - M
0397- E5 06      2120      SBC M
0399- 85 08      2130      STA I
039B- A5 09      2140      LDA I+1
039D- E5 07      2150      SBC M+1
039F- 85 09      2160      STA I+1
03A1- 90 06      2170      BCC SRT8
03A3- D0 83      2180 SRT7 BNE SRT3      IF I > 0 THEN STR3
03A5- A5 08      2190      LDA I
03A7- D0 FA      2200      BNE SRT7
03A9- E6 0C      2210 SRT8 INC J           J = J + 1
03AB- D0 02      2220      BNE SRT9
03AD- E6 0D      2230      INC J+1
03AF- A5 0F      2240 SRT9 LDA K+1
03B1- C5 0D      2250      CMP J+1          IF J > K
03B3- 90 0B      2260      BCC JMP2        THEN SORT
03B5- D0 06      2270      BNE JMP1        ELSE SRT2
03B7- A5 0E      2280      LDA K
03B9- C5 0C      2290      CMP J
03BB- 90 03      2300      BCC JMP2
03BD- 4C 20 03   2310 JMP1 JMP SRT2      CHANGE IF RELOCATED
03C0- 4C 00 03   2320 JMP2 JMP SORT      CHANGE IF RELOCATED
                2330      .EN

```

:\$300.3C2

```

0300- 46 07 66 06 D0 05 A5 07
0308- D0 01 60 38 A5 04 E5 06
0310- 85 0E A5 05 E5 07 85 0F
0318- A9 01 85 0C A9 00 85 0D
0320- A5 0C 85 08 A5 0D 95 09
0328- 18 A5 08 65 06 85 0A A5
0330- 09 65 07 85 0B A5 00 85
0338- 10 85 12 A5 01 85 11 85
0340- 13 A0 02 18 A5 10 65 08
0348- 85 10 A5 11 65 09 85 11
0350- 18 A5 12 65 0A 85 12 A5
0358- 13 65 0B 85 13 88 D0 E3
0360- B1 10 85 14 B1 12 85 16
0368- C8 B1 10 85 15 B1 12 85
0370- 17 88 B1 14 D1 16 90 31
0378- D0 07 C8 C4 02 D0 F3 F0
0380- 28 A0 00 A5 14 91 12 A5
0388- 16 91 10 C8 A5 15 91 12
0390- A5 17 91 10 38 A5 08 E5
0398- 06 85 08 A5 09 E5 07 85
03A0- 09 90 06 D0 83 A5 08 D0
03A8- FA E6 0C D0 02 E6 0D A5
03B0- 0F C5 0D 90 0B D0 06 A5
03B8- 0E C5 0C 90 03 4C 20 03
03C0- 4C 00 03

```

SYMBOL TABLE

ADRA	0000	LEN	0002	N	0004
M	0006	I	0008	L	000A
J	000C	K	000E	PTRI	0010
PTRL	0012	ADRI	0014	ADRL	0016
SORT	0300	SRT1	0308	SRT2	0320
SRT3	0328	SRT4	0343	SRT5	0372
SRT6	0381	SRT7	03A3	SRT8	03A9
SRT9	03AF	JMP1	03BD	JMP2	03C0

CHANGE IF RELOCATED

SOFTOUCH



AT LAST
ENHANCE THE FULL CAPABILITIES OF YOUR DISK II

SOFTOUCH ANNOUNCES THE

" DISC MANAGEMENT SYSTEM "

EIGHT PROGRAMS ON DISK TO PROVIDE THE USER WITH A COMPLETE UNDERSTANDING OF THE DISK DRIVE COMMANDS PLUS A UTILITY PACKAGE TO INDEX AND CATEGORIZE ALL PROGRAMS WRITTEN FOR THE APPLE II COMPUTER. THE SYSTEM PROVIDES FULL SEARCH, EDITING AND DATA TRANSFER CAPABILITIES.

A TWENTY-SIX PAGE BOOKLET PROVIDES DETAILED, EDUCATIONAL TECHNIQUES GIVING A THROUGH UNDERSTANDING OF ALL DOS COMMANDS.

INCLUDED ARE SUCH TECHNIQUES AS:

- * INITIALIZATION OF TEXT FILES
- * WRITING & READING OF TEXT FILES
- * CREATING TEXT FILES
- * EDITING FILES
- * TRANSFERRING DATA TO OTHER DISKETTES
- * LISTING OF DATA FILES
- * SEARCHING DATA BY VARIOUS OPTIONS

A DOCUMENTED LISTING PROVIDES LINE CHANGES FOR ADAPTING THE SYSTEM TO PERFORM NUMEROUS OTHER APPLICATIONS.

THE BOOKLET IS WRITTEN IN A MANNER WHICH MAY BE USED BY THE NOVICE AS WELL AS THE EXPERIENCED PROGRAMMER. DOZENS OF PROGRAMMING TECHNIQUES ARE SHOWN AND FULLY DOCUMENTED. ALSO INCLUDED SEPARATELY, IS A PROGRAMMERS AID GIVING QUICK REFERENCE TO INTEGER, APPLESOFT AND DOS COMMANDS WITH ILLUSTRATIVE EXAMPLES.

SYSTEM REQUIREMENTS: DISK II & APPLESOFT TAPE OR ROM CARD

PRICE \$19.95 (PROCESSED & SHIPPED WITHIN 4 DAYS)

SEND CHECK OR MONEY ORDER TO:

SOFTOUCH
P.O. BOX 511
LEOMINSTER, MASS. 01453

APPLE II® OWNERS:

West Side Electronics introduces the
APPLETIME™, a Real Time Clock for the Apple II

The Appletime (Model APT-1) is a single peripheral board which plugs directly into any I/O slot on the Apple II. Timing is done completely in hardware (ie. NOT an interrupt driven clock). Thus, the Appletime continues to operate even when the computer is turned off. Our exclusive Three Way Power System keeps the clock running via its own AC supply, the computer's, or battery backup in case of power failure. Other features include 12/24 Hour selection, AC or crystal timebase, 50/60 Hz, and BCD or ASCII data format. Fully assembled and tested, with instructions and

APT-1 Real Time Clock..... \$79.95

Proto-board for Apple II. Over 1300 holes on 0.1 inch centers for designing your own circuits.

APB-1 Prototyping Board..... \$16.95

VERBATIM 5¼" DISKETTES \$34.50

Soft sector, in plastic file case. Box of 10



WEST SIDE ELECTRONICS
P.O. Box 636
CHATSWORTH, CA. 91311



*We pay all shipping in Continental U.S.A.
Others add 10%; California residents add 6% tax.*



PYGMY PROGRAMMING

* APPLE SOFTWARE *

P.O. BOX 3078 • SCOTTSDALE, ARIZONA 85257

APPLE-SCRIBE-2 disk or cassette \$49.00
(Word processor with any length line, printing in any shape or form. Requires 16k or larger system)

APPLE-DMS 48k & disk required \$49.00
(Universal data management system)

UNLISTABLE-BASIC disk required \$39.00
(Make Integer BASIC listings unintelligible)

BCOPY disk & 16, 32 or 48k \$19.00
(Single disk drive binary file copier)

DEFLECTIONS disk or cassette \$10.00
(Real time color graphics game)

Custom programs . . . write for details!

APPLE II SOFTWARE

Special Introductory Prices

Tabular 4-Way Number Converter
Integer BASIC (8K min)..... **\$3.50**

Apple Pi Life (4K min)..... **\$5.00**

Agenda (16K min)..... **\$5.00**

HIRES Shape Encode (16K min)..... **\$5.00**

Integer BASIC Floating Point
Interface (2K Machine Code)..... **\$6.50**

Each program completely documented.
Prices include postage and handling.
Send SASE for Software List today!
Send check or money order to:

Microspan Software
2213A Lanier Drive
Austin, TX 78758

(Texas residents add 5% sales tax)

Streamlining the C2-4P

Here are three modifications you can make to your OSI C2-4P to raise its speed, increase the cassette throughput, and add reverse video to the display.

James L. Cass
19559 Tulsa Street
Northridge, CA 91326

I am concerned by the paucity of articles on OSI computers in MICRO and hope that this will reverse the trend. I feel that the Challenger 2-4P running speed and ease of modification more than offset its shortcomings. I will describe three modifications I have made, mainly, raising the CPU clock rate, raising the cassette data rate, and reversing the video presentation.

Raising the CPU Clock Rate

My computer is happily working with a clock frequency a little under 2 MHz (1.9648 actual, 1.96608 nominal) in place of half that, which is the way it was delivered. The CPU clock is taken from the video timing chain, which uses a crystal oscillator near 12 MHz, a divide by three, and then a series of binary dividers to form 15,360 and 60 Hz sync pulses. It was only necessary to move the CPU clock takeoff one stage higher in the timing chain. To do this, move the jumper wire coming from bus pin #18 off IC #E4 pin #13, and onto pin #14. If you intend to make this change, use a small, low power, preferably grounded soldering iron, as recommended for all IC work. Another word of caution: make a long, thorough shakedown run of several operational programs looking for dropped bits from memory. I did this since I have two RAM chips marked "550" (presumably not fast enough to qualify as 450 nsec.), but there was absolutely no hint of dropped bits. Instead, I have very snappy video display operation, slightly fast keyboard repeat, and, best of all, running times cut in half. A machine language LIFE program updates a full screen of 1792 cells 14 times a second!

Doubling the Bit Rate

I successfully doubled the bit rate of my cassette interface from 300 to 600 baud, after speeding up my CPU. I naturally tried 1200 baud; while it seemed to read properly, the load program seemed to choke up on very long (64 to 71 character) lines sometimes and miss the CR and next line. The 555 IC oscillator frequency is doubled from 4800 to 9600 Hz by substituting a 0.01 mfd capacitor for the 0.022 and then adjusting the trimpot.

A frequency counter is a big help, if not essential. Since the tone frequencies should remain at 1200 and 2400 Hz, an extra divider is needed. The unused half of the 7474 already in the interface works nicely, or you can install a 74163 in the convenient prototyping vacant space, and get several baud rates for printers and the like. Rate selection can be conveniently brought to a switch mounted to the left of the keyboard. Figure 1 shows the circuit using the 7474.

I have found "reversed" video to be much easier to view for extended periods. Also, the black "reversed" characters have less apparent intensity variation, that is, they look even. The reversed video connection is indicated in the schematics, but there is no provision made in the printed wiring, so that it is necessary to cut a printed conductor. The junction of R 11 and R 23 is

moved from Pin 8 to Pins 9-10-11 of the IC at D4. I installed a switch near the keyboard with short, direct small wires, but find that I could have left the wiring at "reversed" with no loss.

Conclusions

Doubling the CPU clock rate and hence the speed of the C2-4P is quite easy to do. The main risk is that some 2114 type RAM chips may be too slow. The data rate in the cassette interface can be doubled to 600 baud, but only with some effort and decrease in reliability; 1200 baud does not work. Reversing the video to display black characters on white is relatively simple and the reversed video format is preferred by everyone. Cassette speed selection and normal-reverse video are conveniently brought to switches installed near the keyboard.

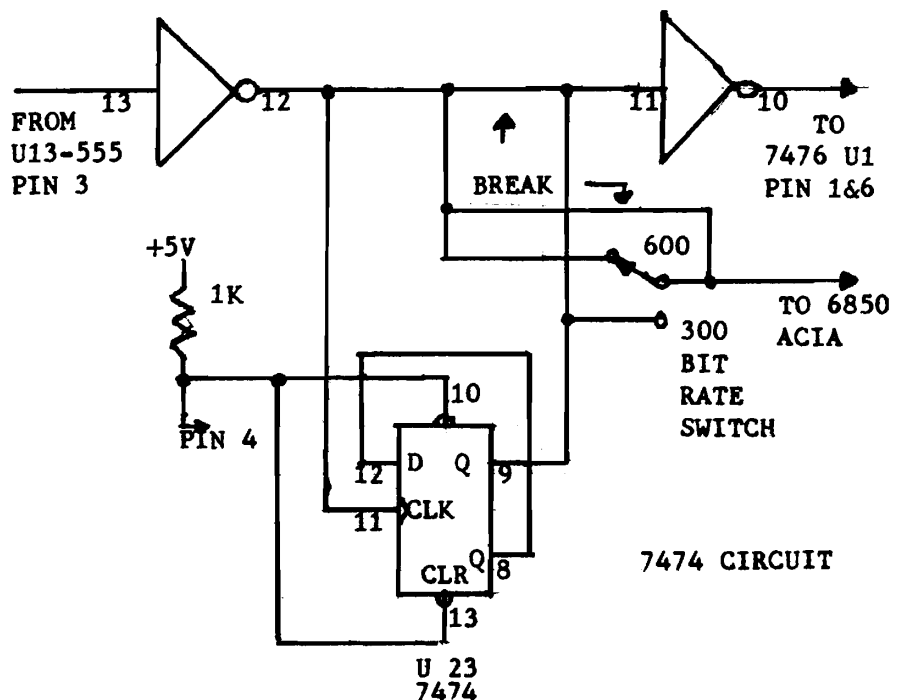

Figure 1

6502 INFORMATION RESOURCES UPDATED

A list of regular publications which have material of interest to 6502 users.

William R. Dial
438 Roslyn Ave.
Akron, OH 44320

Did you ever wonder just what magazines were the richest sources of information on the 6502 micro-processor, 6502-based microcomputers, accessory hardware and software? For several years this writer has been assembling a bibliography 6502 references related to hobby computers and small business systems. The accompanying list of magazines has been com-

plied from this bibliography. At the top of the list are several publications which specialize in 6502-related subjects. An attempt has been made to give up-to-date addresses and subscription rates for the magazines cited. Subscription rates are for U.S. Other countries normally are higher.

MICRO

\$15.00 per year

MICRO

P.O. Box 3

S. Chelmsford, MA 01824

6502 USER NOTES

\$13.00 per 6 issues

Eric Rehnke

P.O. Box 33093

Royalton, OH 44133

OHIO SCIENTIFIC — SMALL SYSTEMS JOURNAL

\$6.00 per year (6 issues)

Ohio Scientific

1333 S. Chillicothe Rd.

Aurora, OH 44202

PET GAZETTE

Free bi-monthly (Contributions Accepted)

Microcomputer Resource Center

1929 Northport Drive, Room 6

Madison, WI 53704

Robert Purser's REFERENCE LIST OF COMPUTER CASSETTES

Nov. 1978 \$2.00/Feb 1979 \$4.00

Robert Purser

P.O. Box 466

El Dorado, CA 95623

THE PAPER (PET)

\$15.00 per year (10 Issues)

The PAPER

P.O. Box 43

Audubon, PA 19407

THE CIDER PRESS (APPLE)

Scot Kamins

Box 4816

San Francisco, CA 94101

STEMS FROM APPLE

Ken Hoggatt

APPLE PORTLAND PROGRAM LIBRARY
EXCHANGE

9195 SW El Rose Court

Tigard, OR 97223

APPLE SEED

Bill Hyde

The Computer Shop

6812 San Pedro

San Antonio, TX 78216

KILOBAUD/MICROCOMPUTING

\$18.00 per year

Kilobaud Magazine

Peterborough, NH 03458

BYTE

\$18.00 per year

Byte Publications, Inc.

70 Main St.

Peterborough, NH 03458

DR. DOBB'S JOURNAL

\$15.00 per year (10 issues)

People's Computer Co.

Box E

1263 El Camino Real

Menlo Park, CA 94025

ON-LINE

\$3.75 per year (18 issues)

D. H. Beetle

24695 Santa Cruz Hwy

Los Gatos, CA 95030

RECREATIONAL COMPUTING

(formerly PEOPLE'S COMPUTERS)

\$10.00 per year (6 issues)

People's Computer Co.

1263 El Camino Real

Box E

Menlo Park, CA 94025

INTERFACE AGE

\$18.00 per year
McPheters, Wolfe & Jones
16704 Marquardt Ave.
Cerritos, CA 90701

POPULAR ELECTRONICS

\$12.00 per year
Popular Electronics
One Park Ave.
New York, NY 10016

PERSONAL COMPUTING

\$14.00 per year
Benwill Publishing Corp.
1050 Commonwealth Ave.
Boston, MA 02215

73 MAGAZINE

\$15.00 per year
73, Inc.
Peterborough, NH

CREATIVE COMPUTING

\$15.00 per year
Creative Computing
P.O. Box 789-M
Morristown, NJ 07960

SSSC INTERFACE

Southern California Computer Soc.
1702 Ashland
Santa Monica, CA 90405

EDN (Electronic Design News)

\$25.00 per year
Cahners Publishing Co.
270 St. Paul St.
Denver, CO 80206

RADIO ELECTRONICS

\$8.75 per year
Gernsback Publications, Inc.
200 Park Ave., South
New York, NY 10003

QST

\$12.00 per year
American Radio Relay League
225 Main St.
Newington, CT 06111

IEEE Computer

IEEE
345 E. 47th St.
New York, NY 10017

POLYPHONY

\$4.00 per year
PAIA Electronics, Inc.
1020 W. Wilshire Blvd.
Oklahoma City, OK 73116

RAINBOW (APPLE)

\$15.00 per year
Rick Simpson and Terry Landereau, Editors
P.O. Box 43
Audubon, PA 19407

PET USER NOTES

\$5.00 per year (6 or more issues)
PET User Group
P.O. Box 371
Montgomeryville, PA 18936

CONTACT — User Group Newsletter

Gratis to Apple owners
10260 Bandley Drive
Cupertino, CA 95014
(408) 996-1010

SOUTHEASTERN SOFTWARE NEWSLETTER

(APPLE)
10 issues \$10.00
George McClelland
Southeastern Software
7270 Culpepper Drive
New Orleans, LA 70126

COMPUTER MUSIC JOURNAL

\$14.00 per year (6 issues)
People's Computer Co.
Box E
1010 Doyle St.
Menlo Park, CA 94025

POPULAR COMPUTING

\$18.00 per year
Popular Computing
Box 272
Calabasas, CA 91302

MINI-MICRO SYSTEMS

\$18.00 per year
Modern Data Service
5 Kane Industrial Drive
Hudson, MA 01749

DIGITAL DESIGN

\$20.00 per year
Benwill Publishing Corp.
1050 Commonwealth Ave.
Boston, MA 02215

ELECTRONIC DESIGN

(26 issues per year)
Hayden Publishing Co., Inc.
50 Essex St.
Rochelle Park, NJ 07662

CALL A.P.P.L.E.

\$10.00 per year (includes dues)
Apple Puget Sound Program Library Exchange
6708 39th Ave. SW
Seattle, WA 98136

The Color Gun for the Apple II

With some quite inexpensive hardware, you can turn your APPLE II into a color detector -- a device which will automatically determine the colors of any object.

Neil D. Lipson
29 S. New Ardmore Ave.
Broomall, PA 19008

Shortly after I developed my light pen for the Apple back in May, 1978, I began thinking about other devices that could be hooked up to the paddle inputs. One idea was making a "color gun" which when pointed at an object would tell you the color. The idea is similar to that of the operation of a television transmitter. Color is broken down into three main colors, which are red, blue, and yellow. Therefore by having three inputs into the Apple, into paddle 0, paddle 1, and paddle 2, we could in effect have a device that would "see" the three color breakdown ratios of any object. By further analysing this ratio, we could see different shades of color and with high quality color filters, we could make an extremely accurate device which could even give the exact color temperature of the object. One of the interesting aspects of this device that sets it apart from any other color temperature meter, is that you can calibrate it by pointing it at a piece of white paper to adjust for differences in the light source. Therefore, the color gun will work in any type of artificial lighting within certain parameters (you could not use it under a red light for example).

Building the Color Gun

To start off with, buy three sensitive cadmium sulphide photo cells (physically between 1/4 to 1/2 inch in diameter). If the cells are not equal in sensitivity, they can be equalized easily in software. This is illustrated in the listing. Merely point the gun at a white piece of paper (or at the light source itself if its not too bright) during the calibration procedure. The construction of the gun is very simple. Mount the three cells in a triangle about 2" for each side on a piece of wood or other material. Then place three filters over the cells, with red on paddle (0) cell, blue on paddle (1) cell, and yellow on paddle (2) cell. The purer the filter, the better. Photographic filters are the best, and will give the best results. However, red, blue or yellow clear plastic will work satisfactorily in most situations. Note the use of the REM statements in the program. These are for slowing down the paddle readings just a hair in order to avoid having the readings "overlap". The wiring diagram is shown in Figure 1.

Mount the entire setup in some type of barrel or cylinder about 4 inches long, with the inside of the barrel painted white, and glue everything together and seal against light leaks. Plug it into the game paddle after the wiring is complete and you ready to go. For the pin numbers of the paddles, consult your red manual.

The Color Gun Program

Type the program into the Apple in Applesoft 2 and run. The gun will only recognize 6 colors, and when it isn't sure what the color is, it will give you two colors (one primary color and one secondary). This should not happen if the colors are absolutely pure, but most colors are not, so expect this situation more often. Notice the correction algorithm in statement 70 in the program to correct for the blue cell. The cells that I used were somewhat more sensitive to blue than the other colors (which is common of cadmium sulfide). This was noticed when the color gun kept saying "orange" (the compliment of blue). The correction

algorithm eliminates most of this problem. If the gun acts strangely, run it again until it gets a good calibration. It sometimes takes more than one run to get it working properly (usually because it is confused by a bright color nearby).

By fine tuning the software, and using more exact ratios, you can determine many other colors. Given enough ratios to choose from, you can give the color temperature of the object (with high quality cells and filters). The typical photographic filters you can use are the yellow (K2), the red (25 or 25A) and the blue (47). These may be varied if desired to meet the spectral response of the particular cell you buy. You could even use different colors in the filters as long as you adjust the software accordingly. Buy the smallest filter you can (it only has to cover about 1/2 inch diameter), but make sure there is no light leak from the sides of the cells. If you follow these instructions, the gun will work perfectly the first time around. Have fun!

μ

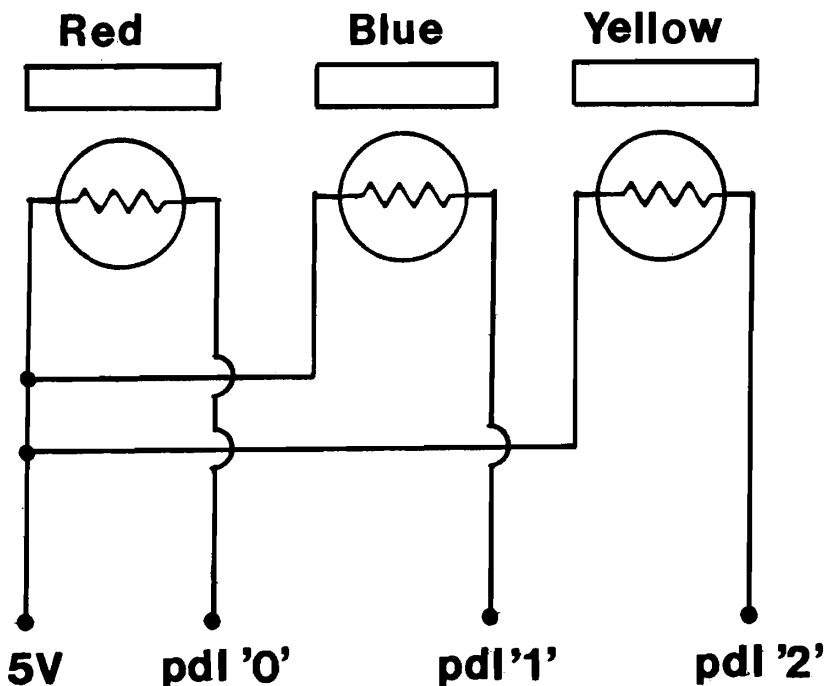

Figure 1

```

1 CALL -936
2 VTAB 10: HTAB 10: PRINT "COLOR
  GUN BY NEIL D. LIPSON"
3 HTAB 15: PRINT "COPYRIGHT 1979
  "
4 HTAB 12: PRINT "ALL RIGHTS RES
  ERVED": FOR I = 1 TO 2000: NEXT
  I
5 REM '0' RED
6 REM '1' BLUE
7 REM '2' YELLOW
10 CALL - 936
15 REM YELLOW,BLUE,RED
20 PRINT : PRINT : PRINT : PRINT

25 GOSUB 1000
30 CALL - 936: PRINT : PRINT
32 A = PDL (0)
35 REM
40 B = PDL (1)
45 REM
50 C = PDL (2)
55 REM
60 A = A * A1
61 B = B * B1
62 C = C * C1
70 B = B / 1.5
100 PRINT "RED CELL = ";A
110 PRINT "BLUE CELL = ";B
115 PRINT "YELLOW CELL = ";C
116 PRINT : PRINT
117 PRINT "THE COLOR IS:": PRINT

118 PRINT "*****
  "
121 IF C < B AND C < (A) THEN PRINT
  "YELLOW"
123 IF A < B AND A < C THEN PRINT
  "RED"
124 IF A > B AND A > C THEN PRINT
  "GREEN"
125 IF B > A AND B > C THEN PRINT
  "ORANGE"
126 IF C < A AND C > B THEN PRINT
  "PURPLE"
129 IF B < C AND B < (A) THEN PRINT
  "BLUE"
130 PRINT "*****
  "
131 FOR X = 1 TO 2300: NEXT X
140 GOTO 30
200 END

```

```

100 CALL - 936: PRINT
1010 PRINT "POINT GUN AT A WHITE
  SHEET OF PAPER"
1020 FOR I = 1 TO 1500: NEXT I
1030 A1 = PDL (0)
1035 REM
1040 B1 = PDL (1)
1045 REM
1050 C1 = PDL (2)
1055 PRINT "A1=";A1
1056 PRINT "B1=";B1
1057 PRINT "C1=";C1
1060 D1 = A1 * B1 * C1
1070 A1 = D1 / A1
1080 B1 = D1 / B1
1090 C1 = D1 / C1
1100 PRINT "CORRECTION FACTOR FO
  R RED = ";A1
1110 PRINT "CORRECTION FACTOR FO
  R BLUE= ";B1
1120 PRINT "CORRECTION FACTOR FO
  R YELLOW= ";C1
1125 FOR I = 1 TO 2000: NEXT I
1130 RETURN
10000 END

```

EPROM PROGRAMMER

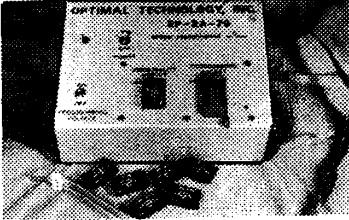

Software available for F-8, 6800, 8080, 8085, Z-80, 6502, KIM-1, 1802.

The EP-2A-79 will program the 2704, 2708, TMS 2708, 2758, 2716, TMS 2516, TMS 2716, TMS 2532, and 2732. PROM type is selected by a personality module which plugs into the front of the programmer. Power requirements are 115 VAC, 50/60 HZ at 15 watts. It is supplied with a 36-inch ribbon cable (14 pin plus) for connecting to microcomputer. Requires 1 1/2 I/O ports. Assembled and tested \$145, Plus \$15-25 for each personality module. Specify software.

OPTIMAL TECHNOLOGY, INC.
 Blue Wood 127, Eartysville, Va. 22936
 Phone 804-973-5482

PROGRESSIVE SOFTWARE

PRESENTS SOFTWARE AND HARDWARE FOR YOUR APPLE

Software:

SALES FORECAST

This program will give you the best forecast using the four most popular forecasting techniques, such as linear regression, log trend, power curve trend, and exponential smoothing. The program uses artificial intelligence to make the decision on the best fit, and displays all results for manual operation if desired. Written by Neil D. Lipson, requires 16K memory.

CURVE FIT

Will take any number of data points in any fashion, and give you the choice of having the computer choose the best curve fit, or you may choose yourself what type of fit you desire. The four given are log curve fit, exponential curve fit, least squares, and power curve fit. The results are then graphed. Written by Dave Garson, requires 16K memory.

CALENDAR

This program will perform two functions: days between dates (any two dates) or a perpetual calendar. If the calendar is chosen, it will automatically give the successive months by merely hitting the return key. May be used with or without a printer. Written by Ed Hanley, requires 16K memory.

STARWARS

The original and best starwars game, written by Bob Bishop. You fire upon the tie fighter after aligning the fighter in your crosshairs. This is a high resolution game in color that uses the paddles. Requires 16K memory.

ROCKET PILOT

This is an exciting game where you are on a planet taking off with your rocket ship, trying to fly over a mountain. The simulation of the rocket blasters actually accelerates you up, and if you are not careful, you will run out of sky. The contour of the land changes each time you play the game. Written by Bob Bishop, requires 16K memory.

SPACE MAZE

This game puts you in a maze with a rocky ship, and you try to "steer" out of it with your paddles or joystick. It's a real challenge. It is done in high resolution graphics in color, done by Bob Bishop. Requires 16K memory.

SAUCER INVASION

This program was written by Bob Bishop. You are being invaded by a flying saucer and you can shoot at it with your missile and control the position with your paddle. Requires 16K memory.

MISSILE-ANTI-MISSILE

Missile-Anti-Missile is a high resolution game. The viewer will see a target appear on the screen, followed by a 3-dimensional digital drawing of the United States. Then a small submarine appears. The submarine is controlled by hostile forces (upon pressing the space bar) which launches a pre-emptive nuclear strike upon the United States (controlled by paddle No. 1). At the time that the missile is fired from the submarine, the United States launches its own anti-missile (the anti-missile is controlled by paddle No. 0). There are many levels of play depending upon the speed. Written by Dave Moteles and Neil Lipson. Requires 16K memory.

MORSE CODE

This program allows the user to learn morse code by the user typing in letters, words or sentences in english. Then the dots and dashes are plotted on the screen. At the same time sounds are generated to match the screen's output. Several transmission speed levels are available. Written by Ed Handley. Requires 16K memory.

POLAR COORDINATE PLOT

A high resolution graphics program which provides the user with 5 primary classic polar coordinate plots and a method by which the user can insert his own equation. When the user's equation is inserted into the program it will plot on a numbered grid and then immediately after plotting, flash, in a table form, the data needed to construct such a plot on paper. The program takes 16K of memory and ROM board. Written by Dave Moteles.

UTILITY PAK 1

This is a combination of 4 programs: (by Vince Corsetti)

Integer to Applesoft Conversion - this program will convert any integer basic program to an applesoft program. After you finished, you merely correct all of those syntax errors that occur with applesoft only.

Disk Append - will append any two integer programs from a disk into one program.

Integer Basic Copy - allows you to copy an integer basic program from one disk to another by merely hitting return. Useful when copying the same program many times.

Update Applesoft - will correct Applesoft on the disk to eliminate the heading that always occurs when it is initially run.

Binary Copy - this program copies a binary file from one disk to another by merely hitting return. It automatically finds the length and starting address of the program for your convenience.

BLOCKADE

Two people try to block each other by building walls and blocking the other. An exciting game written in integer basic for 16K. Written by Vince Corsetti.

TABLE GENERATOR

Is a program which forms shape tables with ease. Shape tables are formed from directional vectors and the program also adds other information such as starting address, length and position of each shape. The table generator allows you to save the shape table in any usable location in memory. It is an applesoft program. Written by Summary Summers. Price: \$9.95

All Programs \$9.95 EACH

All Programs are 16K unless specified.

HARDWARE:

LIGHT PEN

Includes 5 programs. Light Meter, which gives you reading of light every fraction of a second from 0 to 568. The light graph will graph the value of light hitting the pen on the screen. The light pen will "draw" on the screen points which you have drawn and then connect them. It will also give the coordinates of the points if desired, drawn in lo-res. The fourth program will do the same except draw it in hi-res. The fifth program is a utility program that allows you to place any number of points on the screen for use in menu selection or in games, and when you touch this point, it will choose it. It is not confused by outside light, and uses artificial intelligence. Only the hi-res light pen requires 48K and ROM card. Written by Neil D. Lipson.

Light Pen supported by 5 programs \$34.95

Send Check or M.O. to P.O. Box 273, Ply. Mtg., PA 19462

Programs Accepted for Publication-Highest Royalty Paid

Postage and Handling - Add \$1.00 for first item then 50¢ for each add'l

PA Residents Add 6% Sales Tax

ASK the Doctor — Part V

Reading KIM Tapes on the AIM and SYM

The Doctor discusses some problems that arise in trying to load KIM format cassette tapes on the AIM or SYM, and "with a little help from his friends" presents a short routine to get by the SYM "2F" loading bug and a sub-routine which mimics the KIM SCANDS routine on the SYM.

Reading KIM Tapes with the AIM

The AIM 65 has two speeds for reading the KIM format tapes. The normal KIM tape records at about 8 1/3 characters per second. Early in KIM history, Jim Butterfield published "Hypertape", a program that permits KIM formats to be written at higher rates: 2 times, 3 times and even 6 times the normal KIM rate — and still be read by the regular KIM monitor and hardware with no changes! The AIM 65 people recognized the value of the higher speed KIM rates and made their monitor capable of loading either 1 time or 3 times KIM tapes. (The full 6 times would have been very nice, but I guess we can't have everything.) The AIM documentation is very vague about using these KIM formats. To use the KIM loader, you must first set a "user alterable" RAM location A408 as follows:

C7 for normal AIM format tapes
5A for normal KIM format tapes
5B for 3 times KIM format tapes

On power up, C7 is automatically set, so that the AIM format is the default, as one would expect. The A408 location must be set by the user manually to the correct KIM speed value before calling on the tape load or dump routines. This must be reset either manually or by a power up reset to return to the AIM format. If you do not have the correct value in A408 for what you are trying to do, it will not work and, in general, will not give you any indication that it is not working. The KIM Loader/or Dumper is invoked by specifying "K" as the I/O device.

Now that you finally understand how to use the AIM to load a KIM tape, you set A408 to 5A for a regular KIM tape which has your favorite program and run the AIM Load specifying K for the input device, the program identifier that you used when you recorded the tape as the file name, and the correct tape unit. You sit back and wait for the load to complete. But what's this! The AIM is suddenly in some strange state! It may be saying "OUT =" which does not make sense, or even worse may be dumping

reams of paper out of the printer! What happened? What happened was that your typical KIM program which uses all available memory on the KIM — locations 0000 to 03FF — has found a small problem with the AIM KIM format load program. The problem is the **STACK**. The programmers who developed the KIM monitor were super-smart in realizing that, given the very limited on-board memory of the KIM, users would often want to load ALL of the RAM, from 0000 to 03FF, right over page zero and page one — stack all. They made the KIM load and dump routines work without using page zero or page one in any way that would not interfere with data in those pages. You might want to examine this code sometime in the KIM monitor listings, as it is quite instructive. The AIM programmers were only smart about the KIM format — not super-smart. They gave the multiple speeds, but did not write the loader is such a way that it could load over the page one stack. So, the loader works fine until it hits the stack that is being used by the loader itself. Then, it **SELF DESTRUCTS!** It over-writes a return address in the stack and then returns to "never-never-land". Where it goes will depend on the byte of data that over-writes the stack. I do not know of any simple solution to this problem. You can, of course, divide your KIM program into two portions: 0000 to 01F0 (or thereabouts — I think it bombs at about 01FB but have not done any detailed testing), and 0200 and up. This assumes that you have access to a KIM. If not, my friend, I am afraid you have a real problem.

Reading KIM Tapes with the SYM

The SYM monitor bug which causes loading of KIM tapes to abort when it encounters a "2F" has been documented in previous columns, is "cured" by Skov's program, and is fixed in the new SYM SY1.1 version of the monitor. It will not be discussed here. With the "2F" bug fixed, the SYM still has problems with reading KIM format tapes. The problem is the same as discussed with the AIM above. It can **NOT** load over the end of the page one stack. The SYM has an

Robert M. Tripp, Ph.D.
The Computerist, Inc.
P.O. Box 3
So. Chelmsford, MA 01824

additional, related problem. It can not read over the last two bytes in page one either. These two bytes are used by the load routine as the indirect pointer to the next location to be loaded. Once your KIM formatted tape hits them — Good-bye! So, we have here the same problem, and the same solution. To load KIM tapes into a SYM, they must be loaded in three segments: 0000 to 00FD, 0100 to (about) 01FC, and 0200 and up. I thought I had a great idea to get around this problem. I dumped my KIM tapes with everything shifted up to start at 0200, with the intention of using a simple SYM Block-move command to relocate them down to their proper addresses. That is, the KIM tape would be set to load from 0200 to 05FF and then be moved down to 0000 to 03FF. Good idea, right? Well, it may be a good idea, but it doesn't work. Block-move has the exact same problems as the tape load: it uses the last two locations in page zero as well as subroutines which require access to the page one stack!

AIM/SYM/KIM Tape Summary

While there are obviously some problems in using the KIM format tapes on the SYM and AIM, this format is the only one which is compatible between the three machines, and should be used as a common medium of exchange for programs and data between them. To be "universal" the tapes should be written at the normal KIM speed and should start at location 0200 or above. I am sure that there will be SYM and AIM versions of Hypertape published soon, perhaps in MICRO. Maybe someone will even have the time to come up with a KIM LOAD program for the SYM and the AIM that can be tacked on the front of a tape to be exchanged — in normal speed — and which once loaded will permit the loading of KIM format programs and data into any address (except for those occupied by the loader itself which should be out-of-the-way somewhere), and at the higher speeds. Until then, keep the AIM and SYM loading problems in mind as you make plans to transfer your programs and data from one of the ASK family members to another.

μ

SYM "2F" BUG KILLER

A Solution to the SYM "2F" Bug

CODE IS COMPLETELY
RELOCATABLE.

```

20 86 8B  START  JSR   ACCESS
20 78 8C           JSR   LOADT
B0 01           BCS   TWOF
60           RTS
A9 2F           TWOF  LDAIM $2F  SUCCESSFUL LOAD
20 78 8E           JSR   CHKT   2F ERROR
A0 00           LDYIM $00
91 FE           STAIY $00FE
E6 FE           INC   $00FE  BUMP POINTERS
D0 02           BNE   OKAY
E6 FF           INC   $00FF  BUMP HIGH
A5 FC           OKAY  LDA   CHAR
20 3F 8D           JSR   $8D3F
B0 EA           BCS   TWOF
60           RTS
    
```

```

ACCESS *   $8B86
LOADT *   $8C78
CHKT *    $8E78
CHAR *    $00FC
    
```

The problem around SYM-1, with KIM-tape compatability, I solved, at first, by writing a small program, that controls the loading. When loading terminates because of a "2F" in the data stream, it can be assumed that it will result in a checksum error too. What the program does, is simply store the "2F" that was the probable cause and then reenter the tape reading as though there had not been an error.

Submitted by

Jan Skov
Majvaenget 7
DK-6000 Kolding
The Netherlands



PO Box 6502
Chelmsford, Mass 01824

Subscription: One Year = 12 Issues. Please circle the correct category and write the amount in the space provided.

Surface:
 United States \$15.00
 All Other Countries \$18.00

Air Mail:
 Central America \$27.00
 Europe/So. America \$33.00
 All Other Countries \$39.00 \$.....

"BEST of MICRO Volume 1"
 Surface \$ 7.00
 Air Mail \$10.00 \$.....

"ALL of MICRO Volume 2"
 Surface \$8.00
 Air Mail \$12.00 \$.....

No. ... Surface @ \$1.75 each = \$.....
 No. ... Air Mail @ \$2.75 each = \$.....
 No. ... Surface @ \$2.25 each = \$.....
 No. ... Air Mail @ \$3.25 each = \$.....

TOTAL \$.....

"The BEST of MICRO Volume 1" contains all of the important material from the first six issues of MICRO in book form. →

"All of MICRO Volume 2" is all six issues of Volume 2, numbers 7 to 12, at a special reduced price for a limited time only. →

Back Issues:

Issues 7 - 12:.....
 Issues 13 on:.....

All Payments must be in US dollars. Make checks payable to: MICRO. Foreign payments in International Money Order (or cash) only.

If you are a subscriber, attach label or write subscription number here: Sn

Name:.....

Address:.....

City:..... State:..... ZIP:.....

Country (if no US):

Please circle answers on questionnaire below to help us keep MICRO bringing you the type of information you want.

Microcomputers Owned/Planning to Buy: AIM SYM KIM PET APPLE OSI Other.....

Peripherals Owned/Planning to Buy: Memory Disk Video Printer Terminal Other.....

Languages Used: Assembler BASIC FORTH PASCAL Other.....

Your comments and suggestions on MICRO.....

SYM STATIC DISPLAY

SYM Static Display

SYM REFERENCES

ACCESS * \$8B86
 SCAND * \$8906
 SEGSM * \$8C29
 DISBUF * \$A63F

This program is a utility for the SYM-1 that I have found useful in adapting routines for the KIM. It loads the DISBUF from three locations, F5 to F7, corresponding to the three display locations, F9 and FB, used in the KIM monitor. It ends with a JMP SCAND, and thus can be used to replace a JSR SCANDS command as used in a KIM routine. It gives a static display.

COMPLETELY RELOCATABLE

```

20 86 8B  STATIC JSR   ACCESS ENTER HERE UNLESS ACCESS
AO 03      ALTNTR LDYIM $03  ALREADY SET.  SET UP FOR
B9 F4 00  MOVE   LDAY  $00F4 3 NUMBERS. GET NUMBER INTO A
4A         LSRA          SHIFT
4A         LSRA          LEFT
4A         LSRA          FOUR
4A         LSRA          TIMES
AA         TAX           PUT RESULT IN X
98         TYA          Y HAS NUMBER INDEX
0A         ASLA         MULTIPLY BY 2
A8         TAY          PUT BACK INTO Y
BD 29 8C  LDAX  SEGSM GET CORRECT SEGMENT CODE
99 3E A6  STAY  DISBUF -01 PUT INTO DISPLAY BUFFER
98         TYA          GET INDEX BACK
4A         LSRA         DIVIDE BY 2
A8         TAY          PUT BACK
B9 F4 00  LDAY  $00F4 NUMBER INOT A
29 0F      ANDIM $0F  MASK
AA         TAX           RESULT INTO X
98         TYA          GET INDEX
0A         ASLA         MULTIPLY BY 2
A8         TAY          PUT BACK
BD 29 8C  LDAX  SEGSM GET SEGMENT CODE
99 3F A6  STAY  DISBUF PUT INTO DISPLAY BUFFER
88         DEY          DECREMENT INDEX
88         DEY          TWICE
FO 06      BEQ   EXIT   IF HAVE LOADED 6 DIGITS, EXIT
98         TYA          NOT DONE, GET INDEX
4A         LSRA         DIVIDE INDEX BY 2
A8         TAY          PUT BACK
18         CLC          PREPARE TO GO TO MOVE
90 D3      BCC   MOVE   GO!
4C 06 89  EXIT  JMP   SCAND LIGHT UP DISPLAY AND RETURN

```

NOTES:

F7 CORRESPONDS TO KIM POINTH AT FB
 F6 CORRESPONDS TO KIM POINTL AT FA
 F5 CORRESPONDS TO KIM INH AT F9

Y KEEPS TRACK OF LOCATION IN DISBUF
 WHEN MULTIPLIED BY 2,
 AND LOCATION IN F5-F7 WHEN NOT.

Submitted by

Paul W. Zitzewitz
 Department of Natural Sciences
 University of Michigan — Dearborn
 4901 Evergreen Road
 Dearborn, MI 48128

SYM-1, 6502-BASED MICROCOMPUTER

- FULLY-ASSEMBLED AND COMPLETELY INTEGRATED SYSTEM that's ready-to-use
- ALL LSI IC'S ARE IN SOCKETS
- 28 DOUBLE-FUNCTION KEYPAD INCLUDING UP TO 24 "SPECIAL" FUNCTIONS
- EASY-TO-VIEW 6-DIGIT HEX LED DISPLAY
- KIM-1* HARDWARE COMPATIBILITY

The powerful 6502 8-Bit MICROPROCESSOR whose advanced architectural features have made it one of the largest selling "micros" on the market today.

- THREE ON-BOARD PROGRAMMABLE INTERVAL TIMERS available to the user, expandable to five on-board.
- 4K BYTE ROM RESIDENT MONITOR and Operating Programs.
- Single 5 Volt power supply is all that is required.
- 1K BYTES OF 2114 STATIC RAM onboard with sockets provided for immediate expansion to 4K bytes onboard, with total memory expansion to 65, 536 bytes.
- USER PROM/ROM: The system is equipped with 3 PROM/ROM expansion sockets for 2316/2332 ROMs or 2716 EPROMs
- ENHANCED SOFTWARE with simplified user interface
- STANDARD INTERFACES INCLUDE:
 - Audio Cassette Recorder Interface with Remote Control (Two modes: 135 Baud KIM-1* compatible, Hi-Speed 1500 Baud)
 - Full duplex 20mA Teletype Interface
 - System Expansion Bus Interface
 - TV Controller Board Interface
 - CRT Compatible Interface (RS-232)
- APPLICATION PORT: 15 Bi-directional TTL Lines for user applications with expansion capability for added lines
- EXPANSION PORT FOR ADD-ON MODULES (51 I/O Lines included in the basic system)
- SEPARATE POWER SUPPLY connector for easy disconnect of the d-c power
- AUDIBLE RESPONSE KEYPAD

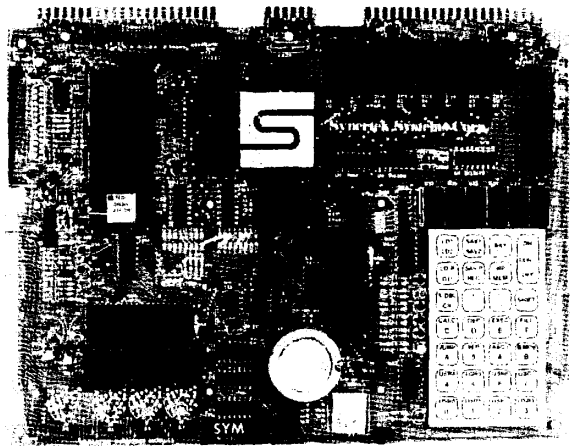

Synertek has enhanced KIM-1* software as well as the hardware. The software has simplified the user interface. The basic SYM-1 system is programmed in machine language. Monitor status is easily accessible, and the monitor gives the keypad user the same full functional capability of the TTY user. The SYM-1 has everything the KIM-1* has to offer, plus so much more that we cannot begin to tell you here. So, if you want to know more, the SYM-1 User Manual is available, separately.

SYM-1 Complete w/manuals	\$269.00
SYM-1 User Manual Only	7.00
SYM-1 Expansion Kit	75.00

Expansion includes 3K of 2114 RAM chips and 1-6522 I/O chip.

SYM-1 Manuals: The well organized documentation package is complete and easy-to-understand.

SYM-1 CAN GROW AS YOU GROW. Its the system to BUILD-ON. Expansion features that are soon to be offered:

*BAS-1 8K Basic ROM (Microsoft)	\$159.00
*KTM-2 TV Interface Board	349.00

**We do honor Synertek discount coupons*

QUALITY EXPANSION BOARDS DESIGNED SPECIFICALLY FOR KIM-1, SYM-1 & AIM 65

These boards are set up for use with a regulated power supply such as the one below, but, provisions have been made so that you can add onboard regulators for use with an unregulated power supply. But, because of unreliability, we do not recommend the use of onboard regulators. All I.C.'s are socketed for ease of maintenance. All boards carry full 90-day warranty.

All products that we manufacture are designed to meet or exceed industrial standards. All components are first quality and meet full manufacturer's specifications. All this and an extended burn-in is done to reduce the normal percentage of field failures by up to 75%. To you, this means the chance of inconvenience and lost time due to a failure is very rare; but, if it should happen, we guarantee a turn-around time of less than forty-eight hours for repair.

Our money back guarantee: If, for any reason you wish to return any board that you have purchased directly from us within ten (10) days after receipt, complete, in original condition, and in original shipping carton; we will give you a complete credit or refund less a \$10.00 restocking charge per board.

VAK-1 8-SLOT MOTHERBOARD

This motherboard uses the KIM-4* bus structure. It provides eight (8) expansion board sockets with rigid card cage. Separate jacks for audio cassette, TTY and power supply are provided. Fully buffered bus.

VAK-1 Motherboard **\$129.00**

VAK-2/4 16K STATIC RAM BOARD

This board using 2114 RAMs is configured in two (2) separately addressable 8K blocks with individual write-protect switches.

VAK-2 16K RAM Board with only 8K of RAM (1/2 populated) **\$239.00**

VAK-3 Complete set of chips to expand above board to 16K **\$175.00**

VAK-4 Fully populated 16K RAM **\$379.00**

VAK-5 2708 EPROM PROGRAMMER

This board requires a +5 VDC and ± 12 VDC, but has a DC to DC

multiplier so there is no need for an additional power supply. All software is resident in on-board ROM, and has a zero-insertion socket.

VAK-5 2708 EPROM Programmer **\$269.00**

VAK-6 EPROM BOARD

This board will hold 8K of 2708 or 2758, or 16K of 2716 or 2516 EPROMs. EPROMs not included.

VAK-6 EPROM Board **\$129.00**

VAK-7 COMPLETE FLOPPY-DISK SYSTEM (May '79)

VAK-8 PROTOTYPING BOARD

This board allows you to create your own interfaces to plug into the motherboard. Etched circuitry is provided for regulators, address and data bus drivers; with a large area for either wire-wrapped or soldered IC circuitry.

VAK-8 Prototyping Board **\$49.00**

POWER SUPPLIES

ALL POWER SUPPLIES are totally enclosed with grounded enclosures for safety, AC power cord, and carry a full 2-year warranty.

FULL SYSTEM POWER SUPPLY

This power supply will handle a microcomputer and up to 65K of our VAK-4 RAM. ADDITIONAL FEATURES ARE: Over voltage Protection on 5 volts, fused, AC on/off switch. Equivalent to units selling for \$225.00 or more.

Provides +5 VDC @ 10 Amps & ± 12 VDC @ 1 Amp
VAK-EPS Power Supply **\$125.00**

KIM-1* Custom P.S. provides 5 VDC @ 1.2 Amps and +12 VDC @ .1 Amps

KCP-1 Power Supply **\$41.50**

SYM-1 Custom P.S. provides 5 VDC @ 1.4 Amps

VCP-1 Power Supply **\$41.50**

*KIM is a product of MOS Technology

 **ENTERPRISES**
INCORPORATED

2967 W. Fairmount Avenue
Phoenix AZ 85017
(602)265-7564



Computer-Determined Parameters for Free-Radical Polymerization

Don't let the title scare you. If you are using your system for complex equation solving, the general techniques presented will be useful -- even if the particular example is not your cup of tea.

Dr. L.S. Reich
3 Wessman Drive
W. Orange, NJ 07052

During the formation of polymers by so-called free-radicals, the following lengthy and "sensitive" equation is generally valid,

$$W(R) = AZ^2RP^{A-1} + ((1-A)/Z)2^3R(R-1)P^{A-2} \quad (1)$$

where, $W(R)$ = weight-fraction of polymer possessing size R ; A and P are parameters; and, $Z = 1-P$ (A or P cannot exceed unity). Various methods have been previously attempted to solve eqn. (1) for the parameters, A and P , which are of theoretical and practical importance. Thus, approximate graphical procedures have been employed (Smith et al., *J. Polym. Sci.*, Pt. A-2, 4, 365 (1966); *J. Phys. Chem.*, 72, 216 (1968); *Ibid.*, 72, 2933 (1968)) as well as more direct approaches (Reich et al., *J. Appl. Polym. Sci.*, 17, 3709 (1973)). The purpose of this article is to present a novel trial-and-error computer program whereby parameters A and P (or Z) can be readily obtained from eqn. (1). **Although eqn. (1) applies to polymers, the solution of eqn. (1) involves mathematical procedures which are common to various scientific disciplines and the program presented should therefore be of general interest.**

Prior to running this program, $W(R)$ - R data is entered in line #200. An initial (trial) value of P (PO) is entered in line #65. Since P is generally close to unity, an arbitrary initial value of P should be selected between .995-.999 (regardless of which value is chosen, the computer will search for the correct value in order to obtain final values of A and P).

From eqn. (1), it can be readily seen that a least squares treatment of the data ($Y = A1 + A2X$) where, $Y = W(R)/(1-P)RP^{A-1}$ and $X = (R-1)/P$, will afford best values of intercept ($A1$) and slope ($A2$) where, $A1 = A$ and $A2 = (1-A)Z/2$ (the least squares procedure is given in line #'s 75-120). Then (cf. line #140),

$$Z = 2A2/(1-A1) \quad (2)$$

Under the conditions used, more than one solution for Z is possible. However, there can only be one unique physically real solution for A and for Z (or $1-P$). The physically unreal solution for Z affords

values of $A > 1$ (which is theoretically impossible). By using line #163, when $A > 1$, PO is lowered in order to achieve conditions whereby a physically real value of A may be obtained. Other limitations that must be met are: P cannot be greater than unity (see line #150); $A1$ cannot be less than zero (#170). Another condition (arbitrary) to be met is (line #156), $1-PO > = Z$. This ensures that prior to a series of iterative calculations to determine final parameter values, the initial value of P is such that $1-PO > = Z$. Then, values of P are gradually increased (line #180) until the following conditions (3) hold (line #'s 160, 168), at which time, A , Z , and the correlation coefficient (from the least squares calculation of $A1$ and $A2$) are displayed (line #168),

$$ABS(R) > .9 \quad (3a)$$

$$\text{and, } 1-P > = Z \text{ or } ABS(1-P-Z)/Z < = 4E-04 \quad (3b)$$

Since eqn. (1) is sensitive to changes in data, i.e., small changes in data can result in relatively large changes in A , there is a requirement that correlation coefficient (R) be above .9 (3a). Thus, even though (3b) is satisfied, if (3a) is not, then the screen will display the statement that the data is not accurate enough (in order to afford reasonably significant values) (line #165). In (3b), the second term involving the absolute value may not apply sometimes, but Z -trial values will generally decrease faster than Z -calculated values to that $1-P < = Z$ halts further iterations and final parameter values are displayed. Further, because of the sensitivity of eqn. (1), when A -values are between .05 and 0, then A is considered to possess a zero value (line #'s 165, 1000). Insufficiently accurate data may also cause relatively large negative $A1$ -values (#165) and endless loops (iterations) to occur. After 200 such iterations, the screen will display a statement that the data may not be accurate enough (to achieve closed parameter values) (line #155). However, it is also possible that due to an unfortunate choice of a PO value in line #65, more than 200 iterations will be required prior

to the display of final values. Hence, the additional statement in line #155 that another value of PO should be entered in line #65 (and another run attempted). If another run is made and a similar situation arises then omitting $W(R)$ - R data at low values of R and/or at very high values of R may afford closed parameter values (the former $W(R)$ - R values generally lie along the steepest part of a distribution curve and are subject to errors in $W(R)$ while the latter values lie along a relatively flat portion of the curve and are subject to errors in R). From the preceding, data in #200 must be derived from precise experimental techniques, which are available, e.g., gel permeation chromatography, due to eqn. (1) sensitivity to relatively small inaccuracies in data (which are prone to occur at the tail ends of a distribution curve).

Prior to the display of final results, values of Z (trial) and Z (calcd.) will be compared in tabular form on the screen (line #'s 68, 155) in order to apprise the viewer of the status of the iterative calculations in progress. After final parameter values have been displayed, values of $W(R)$ (obsd.) and $W(R)$ (calcd.) are compared in tabular form (line #'s 190, 500-520).

Explanatory REM statements are to be found in line #'s 9, 64, 105, 130, 152, 158 and ca. 3-3.5K bytes are required depending upon the amount of data entered (the data is limited to 19 $W(R)$ - R pairs). Applesoft II Basic in ROM was employed and a run, as given in the Program Example section, required ca. 1 min. but this can vary considerably depending upon the accuracy of the data and the initial choice of the PO value (more iterations are necessary when the PO value is further away from the true P value). Finally, it may be noted that the parameter values A and Z can be used to estimate various pertinent quantities. e.g., the so-called weight-average degree of polymerization of a polymer which is equal to $(3-A)/Z$.

Program Listing

```
5 PRINT "THIS PROGRAM ALLOWS THE PRECISE CALCULATION OF
MOLECULAR WEIGHT DISTRIBUTION PARAMETERS, 'A' & '1-P',
FOR FREE-RADICAL POLYMERIZATION. WEIGHT-FRACTION VS.
DEGREE OF POLYMERIZATION (DP) DATA IS ENTERED IN LINE
#200. ";
6 PRINT "THE INITIAL VALUE OF 'P' (ARBITRARILY CHOSEN BETWEEN
.995-.999) IS ENTERED IN LINE 65. CA. 3-3.5K BYTES ARE
REQUIRED AND EXPLANATORY 'REM' STATEMENTS ARE IN LINE #'S
9, 64, 105, 130, 152, 158.": STOP
9 REM #'S 10-60 ALLOW THE FORMATION OF THE ARRAY W(J,K) FOR
WT.-FRACTION VS. DP DATA IN LINE #200
10 DIM W(20,2)
20 FOR J = 1 TO 50
30 FOR K = 1 TO 2: READ W(J,K)
40 IF W(J,1) = 0 THEN 60
50 NEXT K,J
60 J = J-1
64 REM #65 LISTS THE INITIAL VALUE OF 'P' & #'S 70-100 ALLOW
FOR A LEAST SQUARES TREATMENT OF THE DATA
65 PO = .99745
68 PRINT; PRINT"Z-VALUES (TRIAL)"; TAB (21); "Z-VALUES (CALCD.)":
PRINT "-----"; TAB (21); "-----"
70 P = PO
75 FOR I = 1 TO J
80 Y = W(I,1)/(W(I,2)^(W(I,2) -1)*(1-- P)^2): X = (W(I,2) -1)/P
90 XY = XY + X*Y: XX = XX + X*X: SX = SX + X: SY = SY + Y:
YY = YY + Y*Y
100 NEXT
105 REM IN #'S 110, 120 ARE GIVEN THE LEAST SQUARE SLOPE (A2),
INTERCEPT (A1), & THE CORRELATION COEFF. (R)
110 A2 = (J*XY - SX*SY)/(J*XX - (SX)^2): A1 = (SY/J) - A2*(SX/J)
120 R = (XY - J*(SX/J)*(SY/J))/(SQR(XX - SX*(SX/J))*SQR(YY - SY*
(SY/J)))
130 REM #'S 140, 150 ALLOW THE CALCULATION OF Z AND THE ADJUSTMENT
OF PO IF Z<0
140 Z = 2*A2/(1 - A1)
150 IF P>1 OR Z<0 THEN PO = PO- .00001: XX = 0: SX = 0:
SY = 0: YY = 0: GOTO 70
152 REM #155 INDICATES A POSSIBLE ENDLESS LOOP & #156 LOWERS THE
INITIAL VALUE OF PO IN LINE #65 IF 1-PO<= Z
155 PRINT 1-P; TAB(21); Z: PC = PC + 1: IF PC>200 THEN PRINT:
PRINT "THE PROGRAM IS GOING THRU AN ENDLESS LOOP? THE DATA
MAY NOT BE ACCURATE ENOUGH! TRY ANOTHER VALUE OF PO IN #65
& SEE IF THERE IS ANY CHANGE!": END
156 IF 1-PO<Z OR Z<0 THEN PO = PO - .00001: XX = 0: XY = 0: YY = 0:
SX = 0: SY = 0: GOTO 70
158 REM #163 LOWERS PO VALUE IF A1>1 & #'S 160, 165, 168, 180
ALLOW FOR THE CALCULATION OF FINAL VALUES OF 'A' & '1-P' SHILE
#170 ACCOUNTS FOR VALUES OF A1<0
160 IF 1-P<=Z OR ABS(1-P-Z)/Z<= 4E-04 THEN A = A1
163 IF A1>1 THEN PO = PO - .00001: XX = 0: XY = 0: YY = 0: SX = 0:
SY = 0: GO TO 70
```

```

165 IF (ABS(R)<.9 OR A1<-.05) AND (1-P<= Z OR ABS(1-P-Z)/Z<= 4E-04)
    THEN PRINT: PRINT "DATA IS NOT ACCURATE ENOUGH": END
168 IF ABS(R)>.9 AND (1-P<= Z OR ABS(1-P-Z)/Z = 4E-04) THEN PRINT:
    PRINT "VALUES OF 'A' & '1-P' = "; : GOSUB 1000: PRINT A" AND
    "Z" ; AND, CORRELATION COEFF. = "; : PRINT CC: GOTO 190
170 IF A1<0 THEN 180
180 P = P + .00001 : XX = 0: YY = 0: SX = 0: SY = 0:
    GOTO 75
190 PRINT: PRINT " W(X),OBSD.";TAB(20); "W(X) ,CALCD.":
200 DATA 7.45E-04,400, 7.62E-04,600,7.3E-04,700,4.41E-04,
    1200,2.9E-04,1500,1.3E-04,2000,2.1E-05,3000
210 DATA 0
500 FOR I = 1 TO J
510 W = (A1 + A2*(W(I,2)-1)/P)*W(I,2)*P^(W(I,2)-1)*(1-P)^2
520 PRINT TAB(4); W(I,1); TAB(20); INT(W*1E06 + .5)/1E06:
    NEXT I: END
1000 IF A<0 AND A>-.05 THEN A = 0: A1 = 0
1010 A = INT(A*100 + .5)/100: Z = INT(Z*1E06 + .5)/1E06:
    CC = INT(R*1E04)/1E04
1020 RETURN

```

Program Example

```

COMMAND: RUN -----> STATEMENTS 5, 6, and "BREAK IN 6"
COMMAND: CONT ----->

```

<u>" Z-VALUES (TRIAL)</u>	<u>Z-VALUES (CALCD.)</u>
2.54999986E-03	2.49794192E-03
2.53999978E-03	2.49536302E-03
2.52999971E-03	2.49275496E-03
2.51999963E-03	2.49012109E-03
2.50999955E-03	2.48747276E-03
2.49999948E-03	2.48481487E-03
2.48999941E-03	2.48216115E-03
2.47999933E-03	2.47951866E-03

W(R) vs. R data for the polymer, polystyrene (from gel permeation chromatography techniques), was entered in line #200 and an arbitrary value of PO = .99745 in line #65. Then a run was carried out as follows,

VALUES OF 'A' & '1-P' = .65 AND 2.48E-03; AND,
CORRELATION COEFF. = .9999

<u>W(X),OBSD.</u>	<u>W(X),CALCD.</u>
7.45E-04	7.53E-04
7.62E-04	7.6E-04
7.3E-04	7.24E-04
4.41E-04	4.4E-04
2.9E-04	2.9E-04
1.3E-04	1.3E-04
2.1E-05	2.1E-05 "

AIM 6522 Based Frequency Counter

The AIM 65 obviously is going to find its way into the electronics laboratory. Here it is used as a frequency counter.

Marvin L. De Jong
Dept. of Math-Physics
The School of the Ozarks
Pt. Lookout, MO 65726

The program listed performs as a six-digit frequency counter. It will count at least as fast as 450 kHz, perhaps faster. A simple interface circuit is shown in Figure 1. Although the signal to be measured could be connected directly to the PB6 pulse counting pin of the 6522, I prefer not to connect strange and unknown signals directly to the computer. In any case, the signal pulses to be counted should really be shaped into the form of a square wave before they appear at PB6.

The counter uses timer T1 in a free-running mode with 50,000 clock cycles between settings of its interrupt flag. The timer T1 is not allowed to interrupt the 6502, rather its interrupt capability is disabled and the flag is "watched" by reading the interrupt flag register, IFR. With $S_{14} = 20_{16}$ intervals of 50,000 clock cycles apiece, one gets a total interval of one second. S_{14} is located in \$0000. The T1 timer is loaded with instructions starting at \$0230. Note that the number I used is less than 50,000 because my AIM 65 crystal is slow by 244 parts in one million cycles. You may wish to make adjustments with this number also, depending on your system's clock frequency.

The frequency counter works as follows. Timer T2 in its pulse counting mode is initially loaded with \$FFFF = 65535. Once it is loaded, timer T1 is started and PB0 is brought to logic 0 to allow the NAND gate to let pulses through. At the end of the timing interval, described in the preceding paragraph, the gate is closed, the timer T2 is read, the result is subtracted from \$FFFF, this number is converted from HEX to BCD, and it is added to the display locations using the ADC instruction in the decimal mode. If, at any time the T2 timer counts through zero, an interrupt request (IRQ) occurs and the display registers are incremented by 65536 = \$FFFF + 1, T2 is reloaded with \$FFFF, and counting continues. At the end of one second, the total number of counts is displayed by the display subroutine, which, by the way, is identical to the 24-hour clock display routine in the February 1979

issue of MICRO. It is a bit unfortunate that the 6522 designers did not allow the T2 timer to continue producing interrupts without reloading it, because in the time interval between the interrupt request and the reloading of the T2 timer (starting at instruction \$0296 in the interrupt routine), a few counts or pulses on PB6 might be missed. This would only be of concern at large counting rates.

The HEX to BCD conversion routine starts at address \$025D and ends at address \$028E. The 16-bit number representing the number of counts in timer T2 is stored in locations \$0010 and \$0011. If \$PQRS represents this number, then

$$\$PQRS = (P \cdot 4096_{10}) + (Q \cdot 256_{10}) + (R \cdot 16_{10}) + (S \cdot 1)$$

If the calculation on the right-hand side of the above equation is done in the decimal mode, the \$PQRS will be converted to BCD. In other words, 4096 is added to itself P times, 256 is added to

itself Q times, 16 is added to itself R times, and 1 is added to itself S times, all in the decimal mode. These results are all added together, giving a BCD number. Better routines exist, I am sure, but this one isn't too slow. Note that P, Q, R, and S are each one nibble of the 16-bit number obtained from timer T2. (Has anyone yet suggested calling 16-bit numbers "gobbles," giving nibbles, bytes, and gobbles?) The table starting at \$0300 must be loaded into memory for the HEX to BCD conversion to work.

The symbol table given may help you if you wish to modify the program or if you want to change it to run on a microcomputer other than the AIM 65. Also, I would be interested in knowing an exact upper limit for the frequency at which it will operate and in any further improvements to the rate at which it will count. Currently I do not have enough time to do this experimentation myself.

μ

Table 1
ADDRESS TABLE FOR THE AIM 65 FREQUENCY COUNTER

\$A000	=	PBD (ORB)
\$A002	=	PBDD (DDRB)
\$A004	=	T1L-L (Read)
\$A005	=	T1L-H
\$A006	=	T1L-L (Write)
\$A008	=	T2L-L
\$A009	=	T2C-H
\$A00B	=	ACR
\$A00D	=	IFR
\$A00E	=	IER
\$A404	=	IRQL
\$A405	=	IRQH
\$0000	=	Count-to-twenty register
\$0001	=	Display register, low-order byte
\$0002	=	Display register, middle-order byte
\$0003	=	Display register, high-order byte
\$0010	=	PQ = Low-order byte of count from timer T2
\$0011	=	RS = High-order byte of count from timer T2
\$0340	=	Starting address of display subroutine
\$0295	=	Starting address of IRQ routine

```

0200 A9 LDA #95
0202 8D STA A404
0205 A9 LDA #02
0207 8D STA A405
020A A9 LDA #A0
020C 8D STA A00E
020F A9 LDA #01
0211 8D STA A000
0214 8D STA A002
0217 A9 LDA #50
0219 8D STA A00B
021C A9 LDA #14
021E 85 STA 00
0220 A9 LDA #FF
0222 8D STA A008
0225 8D STA A009
0228 A9 LDA #00
022A 85 STA 01
022C 85 STA 02
022E 85 STA 03
0230 A9 LDA #42
0232 8D STA A006
0235 A9 LDA #C3
0237 8D STA A005
023A 0E DEC A000
023D AD LDA A004
0240 06 DEC 00
0242 2C BIT A00D
0245 50 BVC 0242
0247 A5 LDA 00
0249 D0 BNE 023D
024B EE INC A000
024E 38 SEC
024F A9 LDA #FF
0251 ED SBC A008
0254 85 STA 10
0256 A9 LDA #FF
0258 ED SBC A009
025B 85 STA 11
025D A2 LDX #03
025F A5 LDA 10
0261 29 AND #0F
0263 F0 BEQ 027F
0265 A8 TAY
0266 18 CLC
0267 F8 SED
0268 A5 LDA 01
026A 7D ADC 0300, X
026D 85 STA 01
026F A5 LDA 02
0271 7D ADC 0304, X
0274 85 STA 02
0276 A5 LDA 03
0278 69 ADC #06

```

```

027A 85 STA 03
027C 88 DEY
027D D0 BNE 0266
027F CA DEX
0280 30 BMI 028E
0282 A0 LDY #04
0284 46 LSR 11
0286 66 ROR 10
0288 88 DEY
0289 D0 BNE 0284
028B 4C JMP 025F
028E D8 CLD
028F 20 JSR 0340
0292 4C JMP 021C
0295 48 PHA
0296 A9 LDA #FF
0298 8D STA A009
029B F8 SED
029C 18 CLC
029D A5 LDA 01
029F 69 ADC #36
02A1 85 STA 01
02A3 A5 LDA 02
02A5 69 ADC #55
02A7 85 STA 02
02A9 A5 LDA 03
02AB 69 ADC #06
02AD 85 STA 03
02AF D8 CLD
02B0 68 PLA
02B1 40 RTI

```

```

0340 A5 LDA 01
0342 85 STA 04
0344 A5 LDA 02
0346 85 STA 05
0348 A5 LDA 03
034A 85 STA 06
034C A2 LDX #13
034E 8A TXA
034F 48 PHA
0350 A0 LDY #04
0352 A5 LDA 04
0354 29 AND #0F
0356 18 CLC
0357 69 ADC #30
0359 09 ORA #00
035B 20 JSR EF7B
035E 46 LSR 06
0360 66 ROR 05
0362 66 ROR 04
0364 88 DEY
0365 D0 BNE 035E
0367 68 PLA
0368 AA TAX
0369 CA DEX
036A E0 CPX #0E
036C B0 BCS 034E
036E 60 RTS

```

```

<M>=0300 96 56 16 01
< > 0304 40 02 00 00

```

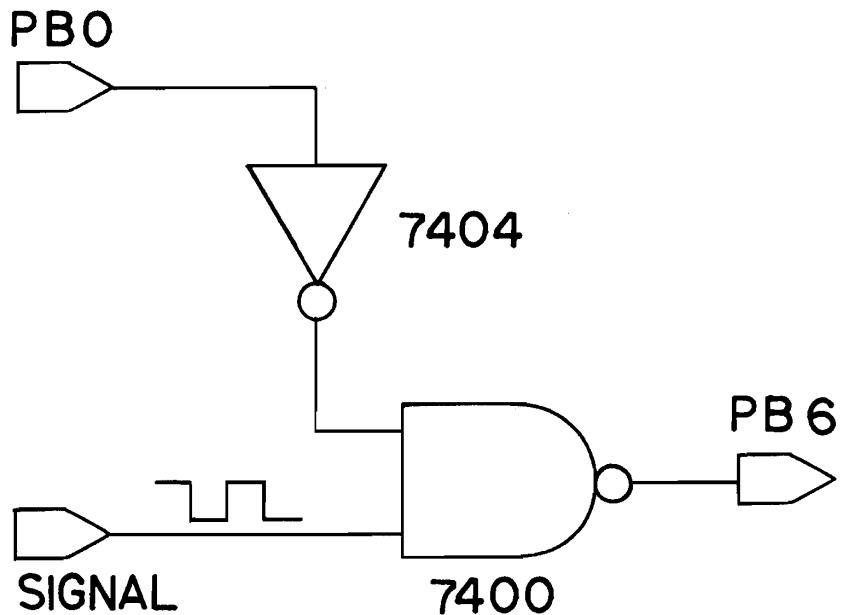

Figure 1

Interface Circuit for the AIM 65
Frequency Counter Using the 6522 VIA

KIM — The Tunessmith

A number of programs have been offered which permit you to play music on your micro. The program presented here also permits you to compose music on your KIM, as well as save it and play it back.

Anthony T. Scarpelli
RR 1, Box 426
N. Windham, ME 04062

Have you ever wanted to compose music, but knew nothing about how to go about doing it? Do you lack a musical instrument and have a tune going through your head and don't know what should go after the first few notes? Well here is a program for a basic KIM-1 that will help you compose a tune, and you don't even have to know how to read or write music.

I have really never learned how to play a musical instrument, and I never have time to practice. Yet every once in a while I want to try out a few notes going on in my head, or I just want to see how a couple of notes sound together, to see if they have any effect on me. So what I did was to develop a program that uses a basic KIM-1 and the speaker circuit shown on page 57 of the KIM-1 User Manual that plays a tune I compose one note at a time. I use the keypad as data entry to place into the program notes of two octaves, including sharp notes, with four possible lengths and a rest or no note. I used the lettered keypads as well as the 9 which looks like a small G for all the notes which are seven in number, basically A B C D E F and G.

Tunessmith Operation

Once you start the program, you press one of the note letters. It will sound the appropriate note. If you want the sharp for that note, if it has one (B and E do not), press 5. To get the upper octave of the note you want you press 7, and if you want the upper octave sharp of the note, press 5 first, then 7. The keys 1, 2, 4, and 8 will give you a whole note (1), a half note (2), a quarter note (4), and an eighth note (8). After you choose your note, you choose your length. If you don't want the note, start again, only this time the length is not automatically a half note as it would be when you first start out, you'll have to change it to what you want.

Now that you have your nice note that sounds just right, press 3. This will save the note and place it in a tune table. To know that the note is indeed saved, the display will flash a **SAVE**. You have to hold the 3 key down until the **SAVE** is seen, though. Now the chosen note will be played and you can pick another note, or a rest which is 0. The procedure is the same for a possible 72 note tune. If you like your tune and want to write it down, press the + key. The display will show you the first note of the tune, and every time you hit the 3 key, the next will be displayed. If you want to start again, press the **DA** (Do Again) key.

The Tunessmith Program

We can go over the program now. Table I is a listing of the keypad numbers and what they represent. The main program starts at 0200 and initialization goes on to 021A. From 021C to 0228 we test the keypad and 022A to 022E we test for the first time through the program. This step eliminates any noise in the speaker while choosing the first note. 0230 to 0236 gets the program to step through all the notes, and 0238 to 023D delays the program, not only to give you more time to choose a note, but also to put a space between the beginning and ending of the tune. 0242 to 0248 is for the beginning silence. 024A thru 0263 loads the note you have chosen into a temporary location. 0265 to 026E will jump to all the subroutines which we'll explain in a minute. 0271 thru 027B tests for the save key, which you press if you want that particular note. From 027B to 0283 we test for the **DA** key. 0285 to 028F will cause the program to jump to the routine which will allow us to see what notes we have so that they can be written down and saved for the "Top Ten". 0295 to 02A9 sets the save flag, resets the note counter, and because the program goes deep into the stack territory, resets the stack pointer to avoid trouble.

The Get High subroutine is the first one we come to. From 0356 to 035E we test to see if we want a high note. If we don't, we return from the subroutine. If yes, we'll first test to see if it's to be a sharp note that is to go to the next octave. If it is, then from 0366 to 036A we'll load the high sharp note into the temporary location, otherwise from 036F to 0373 we'll load just the next octave note. The Get Sharp subroutine is similar and the Get Length subroutine is simple enough.

The Play Tune subroutine is next. From 0300 to 0306 we set up the first note, then we play it. This is the unsaved note we are trying out. Then we'll test for a save flag from 0313 to 0317, and test for a note or notes in the tunetable up to 031D. If there is one or more notes in the tunetable, from 031F to 0330 we'll play them. If we had a save for the temporary note, we reset the save flag, store a rest so we don't hear the saved note twice, then load the note into the next position of the tunetable, and we'll also put our chosen length into the length table; all this from 0333 to 0345. Since we saved the note, not only do we need some indication that it was saved, we also need to indicate that our finger is on the 3 keypad long enough for the program to catch the keypad entry, so at 0347 we go to the subroutine that displays a big red "**SAVE**". At 034A we play all our notes again, and then go back to the main program to get another note, then back here again so we always hear our tune.

In the Tone subroutine, at 02DD and 02DF we set the ports to outputs; and at 02E2 and E4 we start KIM's internal timer. We load the note frequency, and when it runs down we change the output to its other state, whatever it was. If you hook a speaker circuit on the port as in the KIM manual, a note will be produced as we repeat this procedure every time the timer times out at 02EF; and if we do

this for a length of time determined by the note length at 02F9, we have just played a note in our tables or one we're testing out.

Our Save subroutine starts at 03AA where we load a number for a particular time we want to keep the SAVE letters on. Next at 03AE and 03BO we set the direction registers and since we want only 4 digits lit we load the number 4 into the X register. When we store one of six numbers, from 09 to 13 into the location SBD(1742), one of the six digits will be lit, and then if we load a particular hex number representing a letter, number or other shape into another location SAD(1740), then the seven segment display will light. We also need some delay, because if we did not, the display would light and go out in a couple of microseconds, which few of us could see. All this is taken care of from 03B3 to 03CC. And finally we want to end the tune after 72 notes so we will automatically go to the Display Notes routine from 03CE to 03D4. We want to keep count of how many notes we save so at 03D7 we increment the note count.

If we have a nice little tune running through our circuits and we say to ourselves, "Hey, that's a catchy tune that might make the top 40," then we'll need some way of finding out what notes are in the tunetable so that we can write them down. The Display Notes routine does just that. What we want this section to do is to display a lettered note, to show that it is a sharp and/or a high note, and to show what its length is. We want it to stay on the display until we're ready for the next note and we need some indication that the note has changed when we do go to the next note. Finally we want the option of starting again. So here we go.

From 0100 to 010A we test the counters to see if we've reached the end of our tune table, then we take our note and length and put them into a temporary location from 010D to 0115. From 0117 to 011D we check for a rest; if it isn't one then at 011F on we determine what note it is. What I did was to compare the unknown note to the note table and for every wrong comparison increment a count. We also have four groups of 7 notes and to determine what group, I subtract a number until I get a carry flag. This then tells me the group and also the note. The group indicates whether the note is high, sharp, or high/sharp. We load the correct shape for the display on this information. If it was just a rest, at 0180 we load a zero shape. At 018A to 0198 we test for the length and then store the length shape. Up to 01BC we display the shapes as before, only this time, as we go through a test for the next note, and "do again", we keep the

TUNESMITH

BY ANTHONY T. SCARPELLI
MAY 1979

MICRO NUMBER 13
JUNE 1979
COPYRIGHT (C) MAY 1979 BY
THE COMPUTERIST, INC.

KIM MONITOR REFERENCES

PAD *	\$1700	DATA REGISTER
PADD *	\$1701	DATA DIRECTION REGISTER
TIMER *	\$1704	SET TIMER
TTIMER *	\$1707	TEST TIMER
STIMER *	\$170F	START TIMER
SAD *	\$1740	SYSTEM DATA REGISTER A
SADD *	\$1741	SYSTEM DATA DIRECTION A REG
SBD *	\$1742	SYSTEM DATA REGISTER B
PBDD *	\$1743	SYSTEM DATA DIRECTION REG B
KEYIN *	\$1F40	KEYPAD INPUT
GETKEY *	\$1F6A	GET KEYBOARD INPUT

PAGE ZERO LOCATIONS

0000 ORG \$0000

LOW NOTE TABLE

0000 FB	NOTE =	\$FB	G
0001 DF	=	\$DF	A
0002 C6	=	\$C6	B
0003 BB	=	\$BB	C
0004 A6	=	\$A6	D
0005 93	=	\$93	E
0006 8A	=	\$8A	F

HIGH NOTE TABLE

0007 7B	HINOTE =	\$7B	G
0008 6D	=	\$6D	A
0009 61	=	\$61	B
000A 5B	=	\$5B	C
000B 51	=	\$51	D
000C 48	=	\$48	E
000D 43	=	\$43	F

LOW SHARP NOTE TABLE

000E ED	SHPNOT =	\$ED	G SHARP, A FLAT
000F D2	=	\$D2	A SHARP, B FLAT
0010 01	=	\$01	NO NOTE
0011 B0	=	\$B0	C SHARP, D FLAT
0012 9C	=	\$9C	D SHARP, E FLAT
0013 01	=	\$01	NO NOTE
0014 83	=	\$83	F SHARP, G FLAT

HIGH SHARP NOTE TABLE

0015 74	HISHRP =	\$74	G SHARP, A FLAT
0016 67	=	\$67	A SHARP, B FLAT
0017 01	=	\$01	NO NOTE
0018 56	=	\$56	C SHARP, D FLAT

0019	4C	=	\$4C	D SHARP, E FLAT
001A	01	=	\$01	NO NOTE
001B	3F	=	\$3F	F SHARP, G FLAT
001C	00	=	\$00	UNUSED
001D	00	=	\$00	
001E	00	=	\$00	
001F	00	=	\$00	
0020	02	DELTIM	= \$02	DELAY TIME
0021	00	TIMED	= \$00	
0022	00	TIMEC	= \$00	
0023	00	SAVFLG	= \$00	SAVE FLAG
0024	00	TLENTH	= \$00	TEMP. LENGTH
0025	00	NOTPTR	= \$00	NOTE POINTER
0026	00	KEYPTR	= \$00	KEY POINTER
0027	00	TNOTE	= \$00	TEMP NOTE
0028	00	HIFLG	= \$00	HIGH FLAG
0029	00	SHPFLG	= \$00	SHARP FLAG
002A	00	NOTNUM	= \$00	NOTE NUMBER
002B	00	PRMNOT	= \$00	PERMANENT NOTE
002C	00	FSTFLG	= \$00	FIRST TIME FLAG
002D	00	PLENTH	= \$00	PERM. LENGTH
002E	00	TNTNUM	= \$00	TEMP. NOTE NUMBER
002F	00	NEXNOT	= \$00	NEXT NOTE
0030	00	DELYA	= \$00	DELAY A
0031	00	DELYB	= \$00	DELAY B
0032	00	PNTPTR	= \$00	PERM. NOTE POINTER
0033	00	DELYC	= \$00	DELAYC
0034	00	TTBPTR	= \$00	TUNETABLE POINTER
0035	00	NTBPTR	= \$00	NOTE TABLE POINTER
0036	00	NOTCNT	= \$00	NOTCNT NOTE COUNT
0037	00	DNTCNT	= \$00	DISPLAY NOTE COUNT
0038	00	TEMNOT	= \$00	TEMP. NOTE
0039	00	TEMLN	= \$00	TEMP. LENGTH
003A	00	COUNT	= \$00	
003B	00	DFOUR	= \$00	
003C	00	DTHREE	= \$00	
003D	00	DTWO	= \$00	
003E	00	DONE	= \$00	
003F	00	LNTPTR	= \$00	LENGTH POINTER
		CONSTANTS		
0040	01	KEYLNT	= \$01	(1) WHOLE NOTE
0041	02		= \$02	(2) HALF NOTE
0042	04		= \$04	(4) QUARTER NOTE
0043	08		= \$08	(8) EIGHTH NOTE
0044	20	LNTH	= \$20	LENGTH
0045	10		= \$10	
0046	08		= \$08	
0047	04		= \$04	
0048	86	LNSHP	= \$86	(1) LENGTH SHAPE
0049	DB		= \$DB	(2)
004A	E6		= \$E6	(4)
004B	FF		= \$FF	(8)
004C	BD	NTSHP	= \$BD	(G) LETTER SHAPES
004D	F7		= \$F7	(A)
004E	FC		= \$FC	(B)
004F	B9		= \$B9	(C)
0050	DE		= \$DE	(D)
0051	F9		= \$F9	(E)
0052	F1		= \$F1	(F)
0053	00	LETNUM	= \$00	LETTER NUMBER

display lit. If we hit the 3 key we jump to a delay which blanks the display. This lets us know a new note has entered the circuits so that we can distinguish two or more same notes in a row. Finally we reset the stack pointer again and display the next note. If we want to start again at any time, we hit the DA key and off we go to the beginning again. By the way, the delay subroutine we go to is a good delay to get very long times. It uses the KIM-1's internal timer.

So that's it. I know it is a long program, because of all the explanation, but I want as much understanding as possible, because of the possibilities it holds. The simple tone generation can be replaced with a D/A converter, an erase note mode can be implemented, a larger scale with more lengths and other variables can be developed, and so on. There is no limit. But for a beginning, with a small computer, all you potential Bachs, here it is, go to it.

μ

Table I — Keypad Representations

A = A note
B = B note
C = C note
D = D note
E = E note
F = F note
9 = G note
0 = rest
1 = whole note
2 = 1/2 note
4 = 1/4 note
8 = 1/8 note
5 = sharp
7 = upper octave
3 = save or display next note
DA = Do Again
+ = Display notes

Classified Ads

APPLE RENUMBER/APPEND - Integer and Applesoft! Programmer's Utility Pack. \$19.95 for disk or tape. Includes many other programs as well. SASE for info or order from:

Southwestern Data Systems
Box 582-M
Santee, CA 92071
714/562-3670

Amateur Radio LOG Program for the Apple. Use for QSO's, contests, field days, DX, etc. Has 7 functions. Full info for revising to your needs. Cassette \$12.00. Order from:

Alex Massimo, A F 6 W
4041 41st Street
San Diego, CA 92105

PROFIT from your micro. Don Lancaster's outrageous new book THE INCREDIBLE SECRET MONEY MACHINE tells, shows you how. \$6.95 autographed, postpaid, guaranteed. Visa Accepted. Quest your tinaja NOW! Order from:

Synergetics MC-7
Box 1877
Thatcher, AZ 85552

COMPUTERS IN PSYCHIATRY/PSYCHOLOGY (formerly MICRO-PSYCH) Bi-monthly magazine: articles, program catalogue, bibliography, training and employment clearinghouse, calendar, more. Over 300 subscribers. Send \$12.00 for Vol 1 (1978-1979); \$15.00 for Vol 2 (1979-1980). Order from:

COMPUTERS IN PSYCHIATRY/PSYCHOLOGY
Box I
26 Trumbull Street
New Haven, CT 06511

MICRO

0054 OF = \$0F
0055 OD = \$0D
0056 OB = \$0B
0057 O9 = \$09

0058 D0 LETTER = \$00 LETTER SHAPES
0059 F9 = \$F9
005A BE = \$BE
005B F7 = \$F7
005C ED = \$ED

005D TUNTBL * \$0060 TUNE TABLE
005D LNTTBL * \$00A8 LENGTH TABLE

DISPLAY NOTE ROUTINE

```

0100                                ORG    $0100

0100 A9 01    DISNTS LDAIM $01    RESET DISPLAY NOTE COUNT
0102 85 37                                STA    DNTCNT
0104 A5 37    NXTNOT LDA    DNTCNT TEST FOR END
0106 C5 36                                CMP    NOTCNT
0108 D0 03                                BNE    BEGIN
010A 4C E1 01    JMP    DOAGNB
010D A6 37    BEGIN  LDX    DNTCNT STORE NOTE
010F B5 60                                LDAZX  TUNTBL AND LENGTH
0111 85 38                                STA    TEMNOT
0113 B5 A8                                LDAZX  LNTTBL
0115 85 39                                STA    TEMLEN
0117 A2 00                                LDXIM  $00
0119 A5 38    RPT    LDA    TEMNOT TEST FOR TEST
011B C9 01                                CMPIM  $01
011D F0 61                                BEQ    DISZER
011F D5 00                                CMPZX  NOTE TEST FOR NOTE
0121 F0 04                                BEQ    SUB
0123 E8                                INX
0124 4C 19 01    JMP    RPT
0127 38                                SUB    SEC TEST FOR FIRST
0128 8A                                TXA    GROUP
0129 E9 07                                SBCIM  $07
012B B0 0D                                BCS    NXGRPA
012D B5 4C                                LDAZX  NTSHP STORE NOTE SHAPE
012F 85 3D                                STA    DTWO
0131 A9 C0                                LDAIM  $C0
0133 85 3E                                STA    DONE
0135 85 3C                                STA    DTHREE
0137 4C 8A 01    JMP    DISLEN

013A 38                                NXGRPA SEC TEST FOR SECOND
013B 8A                                TXA    GROUP
013C E9 0E                                SBCIM  $0E
013E B0 13                                BCS    NXGRPB
0140 8A                                TXA
0141 E9 06                                SBCIM  $06 STORE NOTE SHAPE
0143 AA                                TAX
0144 B5 4C                                LDAZX  NTSHP
0146 85 3D                                STA    DTWO
0148 A9 F6                                LDAIM  $F6 STORE HI SHAPE
014A 85 3E                                STA    DONE
014C A9 C0                                LDAIM  $C0
014E 85 3C                                STA    DTHREE
0150 4C 8A 01    JMP    DISLEN
  
```

0153 38	NXGRP	SEC		TEST FOR THIRD
0154 8A		TXA		GROUP
0155 E9 15		SBCIM	\$15	
0157 B0 13		BCS	NXGRPC	
0159 8A		TXA		
015A E9 0D		SBCIM	\$0D	STORE NOTE SHAPE
015C AA		TAX		
015D B5 4C		LDAZX	NTSHP	
015F 85 3D		STA	DTWO	
0161 A9 ED		LDAIM	\$ED	
0163 85 3C		STA	DTHREE	
0165 A9 C0		LDAIM	\$C0	
0167 85 3E		STA	DONE	
0169 4C 8A 01		JMP	DISLEN	
016C 38	NXGRPC	SEC		STORE NOTE SHAPE
016D 8A		TXA		
016E E9 15		SBCIM	\$15	
0170 AA		TAX		
0171 B5 4C		LDAZX	NTSHP	
0173 85 3D		STA	DTWO	
0175 A9 ED		LDAIM	\$ED	STORE SHARP SHAPE
0177 85 3C		STA	DTHREE	
0179 A9 F6		LDAIM	\$F6	
017B 85 3E		STA	DONE	
017D 4C 8A 01		JMP	DISLEN	
0180 A9 BF	DISZER	LDAIM	\$BF	STORE ZERO SHAPE
0182 85 3D		STA	DTWO	
0184 A9 C0		LDAIM	\$C0	
0186 85 3E		STA	DONE	
0188 85 3C		STA	DTHREE	
018A A2 00	DISLEN	LDXIM	\$00	
018C A5 39	RPTB	LDA	TEMLEN	TEST FOR LENGTH
018E D5 44		CMPZX	LNTH	
0190 F0 04		BEQ	GTSHP	
0192 E8		INX		
0193 4C 8C 01		JMP	RPTB	
0196 B5 48	GTSHP	LDAZX	LNSHP	STORE LENGTH SHAPE
0198 85 3B		STA	DFOUR	
019A A9 80	DIS	LDAIM	\$80	LOAD DISPLAY
019C 85 33		STA	DELAYC	LIGHT TIME
019E A9 7F		LDAIM	\$7F	SET DIRECTION REGISTER
01A0 8D 41 17		STA	SADD	
01A3 A2 04	RPTC	LDXIM	\$04	SET UP 4 LETTERS
01A5 A0 FF	LITE	LDYIM	\$FF	AND DISPLAY
01A7 B5 53		LDAZX	LETNUM	LIGHT LETTERS
01A9 8D 42 17		STA	SBD	
01AC B5 3A		LDAZX	COUNT	
01AE 8D 40 17		STA	SAD	
01B1 88	WAIT	DEY		DELAY
01B2 D0 FD		BNE	WAIT	
01B4 CA		DEX		GET NEXT LETTER
01B5 10 EE		BPL	LITE	
01B7 A4 33		LDYZ	DELAYC	DELAY
01B9 88		DEY		
01BA 84 33		STYZ	DELAYC	
01BC D0 E5		BNE	RPTC	
01BE 20 40 1F		JSR	KEYIN	TEST FOR NEXT NOTE
01C1 20 6A 1F		JSR	GETKEY	
01C4 C9 03		CMPIM	\$03	
01C6 F0 0C		BEQ	NEXT	
01C8 20 40 1F		JSR	KEYIN	TEST FOR START AGAIN
01CB 20 6A 1F		JSR	GETKEY	
01CE C9 11		CMPIM	\$11	

MEMORY PLUS™ FOR

AIM/SYM/KIM

8K STATIC RAM LOW POWER

Sockets for 8K Eprom

6522 1/0 Port

ON BOARD REGULATORS

EPROM PROGRAMMER

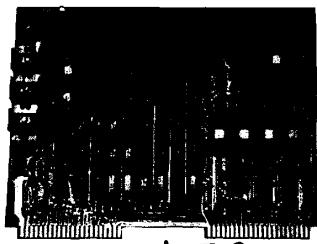

Just Reduced to \$200⁰⁰
MEMORY PLUS: ~~\$245⁰⁰~~ FULLY ASSEMBLED AND TESTED

VIDEO PLUS™ FOR

AIM/SYM/KIM

UPPER/lower case ASCII
128 Additional User Programmable
Characters: GRAPHICS-
SYMBOLS-FOREIGN CHARACTERS
Programmable Screen Format up to
80 CHARACTERS - 24 LINES

KEYBOARD and LIGHT PEN Interfaces
Up to 4K DISPLAY RAM
Provision for 2K EPROM
Provision to add 6502 for
STAND-ALONE SYSTEM

ASSEMBLED AND TESTED
WITH 2K DISPLAY RAM

VIDEO PLUS: \$245⁰⁰

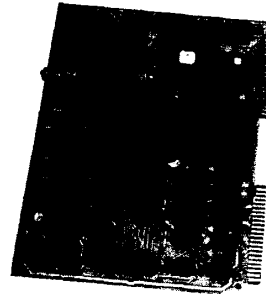

MOTHER PLUS™ FOR

AIM/SYM/KIM

ADD UP TO FIVE ADDITIONAL BOARDS

AUDIO/TTY CONNECTIONS

POWER TERMINALS

APPLICATION CONNECTORS

FULLY BUFFERED

FULLY DECODED

KIM-4 Bus Structure

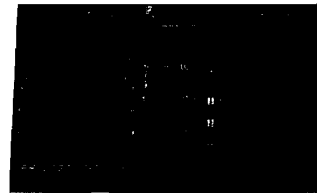

MOTHER PLUS: \$80⁰⁰

FULLY ASSEMBLED AND TESTED

PROTO PLUS™ FOR

AIM/SYM/KIM

Same SIZE and SHAPE as KIM/SYM

Professional Quality

Double Sided, Plated through Holes

Two Sets of GOLD Plated Dual 22 Fingers

Designed for WIRE WRAP or
SOLDER Connections

Provisions for 40 14/16 pin sockets
4 24/40 pin sockets
3 voltage regulators



PROTO PLUS: \$40⁰⁰

617/256-3649



PO Box 3
S Chelmsford, MA 01824

Classified Ads

FREE SAMPLE COPY - New BUY-SELL-TRADE Publication, indexed by product type, mailed monthly First Class. 3500 circ., low, low ad rates. Send for your free sample copy now! Subscription \$3.50 per year, FREE THREE LINE AD with subscription.

Order from:

LECTRONICS EMPORIUM
Dick Costello, Pub.
P.O. Box 828
Derry, NH 03038

The TARGET for users of Rockwell's AIM 65. Find out how to use the printer, keyboard and display. Reviews of upcoming Assembler and BASIC in ROMs. Six bimonthly issues for \$5.00 US and Canada (\$12.00 elsewhere). Order from:

Don Clem
RR#2
Spencerville, OH 45887

ZIPTAPE loads 8K BASIC in 15 seconds! Slower than a speeding disc? Sure, but it only costs \$22.50 plus \$1.00 S&H. \$3.00 extra for software on KIM cassette. Described in MICRO #6. SASE for info. Order from:

Lew Edwards
1451 Hamilton Ave.
Trenton, NJ 08629

New! APPLE SOFTWARE DIRECTORY has over 700 programs and sources listed alphabetically. Order Vol 1 - Business, Vol 2 - Games. Dealer program available. Each book \$4.95 at Apple dealers or order from:

WEDL Video
5325 N. Lincoln
Chicago, IL 60625

MICRO

01D0 F0 OF
01D2 D0 C6

BEQ DOAGNB
BNE DIS

01D4 20 AC 02 NEXT
01D7 E6 37
01D9 A2 FF
01DB 9A
01DC EA
01DD EA
01DE 4C 04 01

JSR DELAY
INC DNTCNT INCREMENT DISPLAY NOTE
LDXIM \$FF COUNT. RESET STACK
TXS POINTER
NOP PADDING
NOP
JMP NXTNOT

01E1 A9 00
01E3 85 36
01E5 4C 00 02

DOAGNB LDAIM \$00
STA NOTCNT
JMP NUTUNE

15 16 17

MAIN PROGRAM

0200

ORG \$0200

0200 A9 00
0202 85 23
0204 85 2A
0206 85 2C
0208 A9 01
020A 85 60
020C 85 A8
020E 85 27
0210 A9 10
0212 85 24
0214 A9 06
0216 85 25
0218 A9 0F
021A 85 26
021C 20 40 1F
021F 20 6A 1F
0222 C5 26
0224 F0 2D
0226 C9 00
0228 F0 20
022A A5 2C
022C C9 00
022E F0 12
0230 C6 26
0232 C6 25
0234 10 02
0236 30 DC

NUTUNE LDAIM \$00 INITIALIZE TUNE
STA SAVFLG
STA NOTNUM
STA FSTFLG
LDAIM \$01
STA TUNTBL
STA LNTTBL
STA TNOTE
LDAIM \$10
STA TLENTH
NUNOTE LDAIM \$06 INITIALIZE NOTE
STA NOTPTR
LDAIM \$0F
STA KEYPTR
PLAYB JSR KEYIN TEST KEYPAD FOR NOTE
JSR GETKEY
CMP KEYPTR
BEQ GTNOTE
CMPIM \$00 FOR REST
BEQ GTREST
LDA FSTFLG TEST FOR FIRST TIME
CMPIM \$00
BEQ NOPLAY
DEC KEYPTR SET UP FOR NEXT NOTE
DEC NOTPTR
BPL DELYA
BMI NUNOTE

0238 A6 30
023A CA
023B 86 30
023D D0 DD
023F 4C 65 02

DELYA LDXZ DELAYA DELAY
DEX
STXZ DELAYA
BNE PLAYB
JMP SVNOTE

0242 C6 26
0244 C6 25
0246 10 D4
0248 30 CA

NOPLAY DEC KEYPTR SET UP FOR NEXT NOTE
DEC NOTPTR
BPL PLAYB
BMI NUNOTE

024A A9 01
024C 85 2C
024E 85 27
0250 4C 65 02

GTREST LDAIM \$01 LOAD REST
STA FSTFLG
STA TNOTE
JMP SVNOTE

```

0253 A9 01      GTNOTE LDAIM $01   LOAD FIRST NOTE FLAG
0255 85 2C          STA  FSTFLG
0257 A6 25      LDXZ NOTPTR LOAD CHOSEN NOTE
0259 A9 00      LDAIM $00
025B 85 28          STA  HIFLG
025D 85 29          STA  SHPFLG
025F B5 00      LDAZX NOTE
0261 85 27          STA  TNOTE
0263 86 32          STXZ  PNTPTR
0265 20 56 03   SVNOTE JSR  GETHI   GET HIGH NOTE
0268 20 86 03   JSR  GETSRP  GET SHARP NOTE
026B 20 DA 03   JSR  GTLNTH  GET LENGTH
026E 20 00 03   JSR  PLATUN  PLAY NOTE
0271 20 40 1F   JSR  KEYIN   TEST TO SAVE NOTE
0274 20 6A 1F   JSR  GETKEY
0277 C9 03      CMPIM $03
0279 F0 16      BEQ  SAVE
027B 20 40 1F   JSR  KEYIN   TEST OFR START OVER
027E 20 6A 1F   JSR  GETKEY
0281 C9 11      CMPIM $11   DA = DO AGAIN
0283 F0 13      BEQ  DOAGN
0285 20 40 1F   JSR  KEYIN   TEST FOR DIPSLAY NOTER
0288 20 6A 1F   JSR  GETKEY
028B C9 12      CMPIM $12   = +
028D F0 15      BEQ  DNOTES
028F D0 8B      BNE  PLAYB

0291 A9 01      SAVE  LDAIM $01   SAVE NOTE
0293 85 23          STA  SAVFLG
0295 4C 14 02     JMP  NUNOTE

0298 A9 00      DOAGN LDAIM $00   RESET NOTE COUNTER
029A 85 36          STA  NOTCNT
029C A2 FF      LDXIM $FF   RESET STACK POINTER
029E 9A          TXS
029F EA          NOP          PADDING
02A0 EA          NOP
02A1 4C 00 02     JMP  NUTUNE

02A4 A2 FF      DNOTES LDXIM $FF   RESET STACK POINTER
02A6 9A          TXS
02A7 EA          NOP
02A8 EA          NOP
02A9 4C 00 01     JMP  DISNTS JUMP TO DISPLAY NOTES

```

DELAY SUBROUTINE

```

02AC A5 20      DELAY LDA  DELTIM GET DELAY VALUE
02AE 85 21          STA  TIMED
02B0 A9 FF      DELA  LDAIM $FF   LOAD TIMER
02B2 8D 04 17   STA  TIMER
02B5 2C 07 17   TEST  BIT  TTIMER TEST TIMER
02B8 10 FB      BPL  TEST  BRANCH IF NOT RUN OUT
02BA C6 22      DEC  TIMEC  REDUCE TIME VALUE
02BC D0 F2      BNE  DELA  START AGAIN
02BE C6 21      DEC  TIMED  REDUCE DELAY VALUE
02C0 D0 EE      BNE  DELA  BRANCH IF NOT DNOE
02C2 60          RTS

```

```

02DD          ORG  $02DD

```

TONE SUBROUTINE

KIM-1

by Commodore

The Original 6502 System

20 mA Current Loop TTY Interface

Audio Cassette Interface

15 User I/O lines

2 Interval Timers

1K+ RAM

2K KIM Monitor ROM

Hex Keypad/LED Display



KIM-1: \$18000

ENCLOSURE PLUS™

The Ultimate Enclosure
for the KIM-1

Protects Your KIM-1

Neat, Attractive, Professional

Full Access to the Expansion and
Application Connectors

Enhances the LED Display with a Red Lens

Room for the KIM-1 and One
Additional Board such as
MEMORY PLUS or VIDEO PLUS.

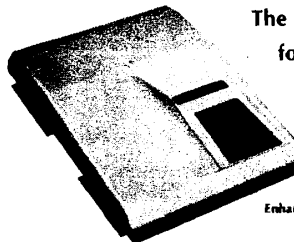

ENCLOSURE PLUS
for KIM: \$30⁰⁰

AIM 65

by Rockwell International

The Complete 6502 System

20 Column Thermal Printer

HighSpeed Audio Cassette

20 Character LED Display

Up to 4K RAM on board

Full size
Typewriter style
Keyboard

Up to 12K additional ROM

Versatile 8K ROM Monitor

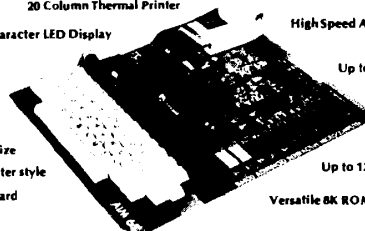

AIM 65: \$37500 1K RAM - \$42000 4K RAM

AIM PLUS™

ENCLOSURE

WITH BUILT IN

POWER SUPPLY

SPECIFICATIONS:

INPUT: 110/220 VAC 50/60 Hz

OUTPUT: +5V @ 5A

+24V @ 1A

GROUNDLED THREE-WIRE LINE CORD

ON/OFF SWITCH WITH PILOT LIGHT

Enclosure has room for the AIM and one
additional board: MEMORY PLUS or VIDEO PLUS

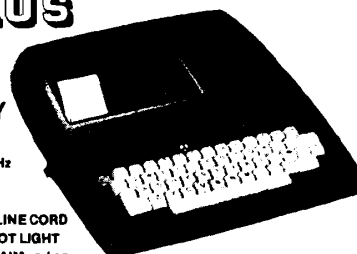

AIM PLUS: \$100⁰⁰ AIM and AIM PLUS: \$475⁰⁰

617/256-3649

THE COMPUTERIST INC

PO Box 3
S Chelmsford, MA 01824

Classified Ads

STOCK MARKET PROGRAMS FOR PET:
 Cycle Analysis of Price Time
 Series, Normal Option Values,
 Option Strategies, Option Strategy
 Charts. On tape with documentation
 \$15.00 each, or all four for
 \$50.00. Send SASE and order from:

Claud Cleeton
 2424 34th St. S.E.
 Washington, DC 20020

ADVERTISE in MICRO for a mere
 \$10.00 !!! A classified ad such
 as the ones above, may be run in
 this new Classified Ad section
 for \$10.00. Ad may not exceed
 six lines, and only one ad per
 person, company, etc. Must re-
 late to 6502 type stuff, and ad
 must be prepaid. You will reach
 over 6502 readers !!!

RESERVED

FOR

YOUR

AD

Ad Deadline:

5th of Month

Software

Hardware

Employment

Swap

Sell

Buy

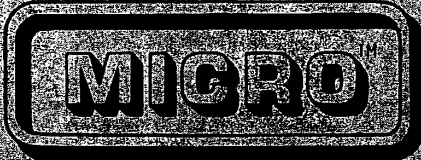

PO Box 6502
 Chelmsford, Mass 01824

MICRO

```

02DD A9 01      TONE  LDAIM $01  OPEN PORT
02DF 8D 01 17   STA  PADD
02E2 A9 20      SOUND LDAIM $20  START TIMER
02E4 8D 0F 17   STA  STIMER
02E7 A6 2B      NOTEX LDXZ  PRMNOT NOTE FREQUENCY
02E9 CA         NWAIT  DEX
02EA 0D 0D      BNE  NWAIT
02EC EE 00 17   INC  PAD    TOGGLE OUTPUT
02EF A9 80      LDAIM $80  TEST COUNTER
02F1 2C 07 17   BIT  TTIMER
02F4 30 03      BMI  TIMEOUT
02F6 4C E7 02   JMP  NOTEX
02F9 C6 2D      TIMOUT DEC  PLENTH NOTE LENGTH
02FB 0D E5      BNE  SOUND
02FD 60         RTS
    
```

PLAY TUNE SOBROUTINE

```

0300                                ORG  $0300

0300 A5 2A      PLATUN LDA  NOTNUM SET UP FIRST NOTE
0302 85 2E      STA  INTNUM
0304 A9 00      LDAIM $00
0306 85 2F      STA  NEXNOT
0308 A5 27      LDA  TNOTE  PLAY NOTE
030A 85 2B      STA  PRMNOT
030C A5 24      LDA  TLENTH
030E 85 2D      STA  PLENTH
0310 20 DD 02   JSR  TONE
0313 A5 23      LDA  SAVFLG TEST FOR SAVE
0315 C9 01      CMPIM $01
0317 F0 1A      BEQ  SAVEX
0319 A5 2A      LDA  NOTNUM TEST FOR NOTE
031B C9 00      CMPIM $00 (NOT REQUIRED)
031D F0 13      BEQ  RETURN
031F A6 2F      PLAYC LDXZ NEXNOT LOAD NEXT NOTE
0321 B5 60      LDAZX TUNTBL
0323 85 2B      STA  PRMNOT
0325 B5 A8      LDAZX LNTTBL LOAD NEXT LENGTH
0327 85 2D      STA  PLENTH
0329 20 DD 02   JSR  TONE  PLAY NOTE
032C E6 2F      INC  NEXNOT SET UP FOR
032E C6 2E      DEC  INTNUM NEXT NOTE
0330 10 ED      BPL  PLAYC
0332 60         RETURN RTS

0333 A9 00      SAVEX LDAIM $00  RESET SAVE FLAG
0335 85 23      STA  SAVFLG
0337 A9 01      LDAIM $01  NO PLAY
0339 85 27      STA  TNOTE
033B E6 2A      INC  NOTNUM LOAD NOTE INTO
033D A6 2A      LDXZ NOTNUM TUNETABLE
033F A5 2B      LDA  PRMNOT
0341 95 60      STAZX TUNTBL
0343 A5 24      LDA  TLENTH LOAD LENGTH
0345 95 A8      STAZX LNTTBL INTO LENGTH TABLE
0347 20 AA 03   JSR  DISPLY
034A 4C 00 03   JMP  PLATUN
    
```

0356

ORG \$0356

GET HIGH SUBROUTINE

```

0356 20 40 IF GETHI JSR KEYIN TEST FOR HIGH NOTE
0359 20 6A IF JSR GETKEY
035C C9 07 CMPIM $07
035E DD 15 BNE RETRNB
0360 A5 29 LDA SHPFLG TEST SHARP NOTE
0362 C9 00 CMPIM $00 (NOT REQUIRED)
0364 FD 09 BEQ LOADHI
0366 A6 32 LDXZ PNTPTR LOAD HIGH SHARP NOTE
0368 B5 15 LDAZX HISHRP
036A B5 27 STA TNOTE
036C 4C 75 03 JMP RETRNB (COULD HAVE BEEN RTS)
036F A6 32 LOADHI LDX PNTPTR LOAD HIGH NOTE
0371 B5 07 LDAZX HINOTE
0373 B5 27 STA TNOTE
0375 6D RETRNB RTS
    
```

0386 ORG \$0386

GET SHARP SUBROUTINE

```

0386 20 40 IF GETSRP JSR KEYIN TEST FOR SHARP NOTE
0389 20 6A IF JSR GETKEY
038C C9 05 CMPIM $05
038E D0 0A BNE RETRNC
0390 A9 01 LDAIM $01 LOAD SHARP FLAG
0392 B5 29 STA SHPFLG
0394 A6 32 LDXZ PNTPTR LOAD SHARP NOTE
0396 B5 0E LDAZX SHPNOT
0398 B5 27 STA TNOTE
039A 6D RETRNC RTS
    
```

03AA ORG \$03AA

DISPLAY SAVE SUBROUTINE

```

03AA A9 80 DISPLY LDAIM $80 LOAD DISPLAY
03AC B5 33 STA DELAYC LIGHT TIME
03AE A9 7F LDAIM $7F SET DIRECTION REGISTER
03B0 BD 41 17 STA SADD
03B3 A2 04 REPEAT LDXIM $04 SET UP 4 LETTERS
03B5 A0 FF LIGHT LDYIM $FF AND DELAY
03B7 B5 53 LDAZX LETNUM LIGHT LETTERS
03B9 BD 42 17 STA SBD
03BC B5 58 LDAZX LETTER
03BE BD 40 17 STA SAD
03C1 88 WAITY DEY DELAY
03C2 D0 FD BNE WAITY
03C4 CA DEX GET NEXT LETTER
03C5 10 EE BPL LIGHT
03C7 A4 33 LDY DELAYC DELAY
03C9 88 DEY
03CA 84 33 STY DELAYC
03CC D0 E5 BNE REPEAT
03CE A5 36 LDA NOTCNT TEST FOR 72 NOTES
03D0 C9 48 CMPIM $48 48 HEX = 72 DECIMAL
03D2 D0 03 BNE INCNOT
03D4 4C 00 01 JMP DISNTS
    
```

POWER PLUS™

5 SUPER 5 5/24

All include the Following Features:

- ALL METAL HEAVY DUTY CASE
- ON/OFF SWITCH and PILOT LIGHT
- 115/60Hz or 230/50Hz INPUT
- GROUNDING THREE-WIRE POWER CORD

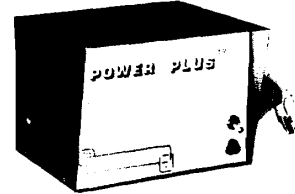

POWER PLUS 5: + 5V at 5A, ± 12V at 1A \$75⁰⁰
 POWER PLUS SUPER 5: + 5V at 10A, ± 12V at 1A \$95⁰⁰
 POWER PLUS 5/24: + 5V at 5A, + 24 at 2.5A, ± 12V at 1A \$95⁰⁰

POWER A PLUS™

SPECIFICALLY DESIGNED FOR THE AIM 65

- Small Enough to Fit Inside the AIM Enclosure
- Enough Power for the AIM 65 Fully Loaded
- Plus an Additional Board
- Works on 115V/60Hz or 230V/50Hz
- Provides Regulated + 5V at 5A and + 24V at 1A

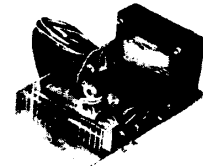

- Grounded Three-Wire Power Cord
- ON/OFF Switch and Pilot Light

POWER A PLUS: \$50⁰⁰

POWER PLUS™

ALL THE POWER A
KIM-1/SYM-1 NEEDS



- Neat, Compact, Economical
- Thousands in Use
- INPUT: 115V/60Hz
- OUTPUTS: Regulated + 5V at 1.4A
+ 12V at 1.0A
Unregulated + 8V up to 4.3A
+ 16V up to 1.0A

Will Power a KIM-1/SYM-1 and one Additional Board Such as MEMORY PLUS or VIDEO PLUS

POWER PLUS: \$40⁰⁰

CASSETTE C-190

SUPERSCOPE C-190
by Marantz

A High Quality Cassette Recorder with all of the Features Required for Microcomputer Systems:

- VU Meter Displays Recording Level
- 110V AC or 6VDC or Battery Operation
- Tape Location Counter
- Three Recording Methods
- Variable Speed Control: ± 20%
- Remote Control Leaves Electronics ON

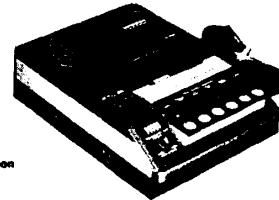

SUPERSCOPE C-190: \$90⁰⁰

THE **617/256-3649**
COMPUTERIST
 PO Box 3
 S Chelmsford, MA 01824
 INC

MICROBBS

DISASSEMBLY - MICRO II

11:10 There should be vertical characters in lines 230 to 290 similar to those in line 220. Also, each line needs a " " at the end. Line 310 should read "homeGOTO" not "home GOTO". The correct pattern for the Cheshire Cat is:

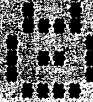

AN APPLE II PROGRAM EDIT AID

11:5 Line 32630 should read J=ASC ... not I=ASC ...

"And here is an addition to make the program run smoother: Add the following lines so that when the screen fills up with text, the Apple will pause and display an "e" in the lower right-hand corner. This will prompt you to hit any key and Apple will clear the screen and continue wherehit left off. This process will continue until until there are no more occurrences of the search item.

Change: 32690
IF PEEK(37)<18 THEN 32700

Add:
32692 VTAB 23:TAB 39:PRINT"e"
32695 KEY=PEEK(-16384): IF KEY <127 THEN 32695
32697 POKE -16368,0: CALL -936

David B. Garson
5163 Willow Wood Road
Rolling Hills Estates, CA 90274

The Ultimate PET Renumber

11:37 A few listing errors:

1F15 88 DEY was C8
1F49 A5 0A LDAZ was A9 0A
1F4B F0 2F BEQ INSF was F0 17

MICRO

03D7 E6 36 INCNOT INC NOTCNT INCREASE NOTE COUNT
03D9 60 RTS

GET LENGTH SUBROUTINE

03DA A9 03 GTLNTH LDAIM \$03 LOAD LENGTH POINTER
03DC 85 3F STA LNTPTR
03DE 20 40 IF KEYTST JSR KEYIN TEST KEYPAD FOR
03E1 20 6A IF JSR GETKEY LENGTH
03E4 A6 3F LDXZ LNTPTR
03E6 D5 40 CMPZX KEYLNT
03E8 F0 05 BEQ LODLNT
03EA C6 3F DEC LNTPTR
03EC 10 F0 BPL KEYTST
03EE 60 RTS
03EF B5 44 LODLNT LDAZX LNTH LOAD LENGTH
03F1 85 24 STA TLENTH
03F3 60 RTS

SYMBOL TABLE 2000 228E

NOTE 0000	HINOTE 0007	SHPNOT 000E	HISHRP 0015
DELTIM 0020	TIMED 0021	TIMEC 0022	SAVFLG 0023
TLENTH 0024	NOTPTR 0025	KEYPTR 0026	TNOTE 0027
HIFLG 0028	SHPFLG 0029	NOTNUM 002A	PRMNOT 002B
FSTFLG 002C	PLENTH 002D	TNTNUM 002E	NEXNOT 002F
DELAYA 0030	DELAYB 0031	PNTPTR 0032	DELAYC 0033
TTBPTR 0034	NTBPTR 0035	NOTCNT 0036	DNTCNT 0037
TEMNOT 0038	TEMLN 0039	COUNT 003A	DFOUR 003B
DTHREE 003C	DTWO 003D	DONE 003E	LNTPTR 003F
KEYLNT 0040	LNTH 0044	LNSHP 0048	NTSHP 004C
LETNUM 0053	LETTER 0058	TUNTBL 0060	LNTTBL 00A8
DISNTS 0100	NXTNOT 0104	BEGIN 010D	RPT 0119
SUB 0127	NXGRPA 013A	NXGRPB 0153	NXGRPC 016C
DISZER 0180	DISLEN 018A	RPTB 018C	GTSHP 0196
DIS 019A	RPTC 01A3	LITE 01A5	WAIT 01B1
NEXT 01D4	DOAGNB 01E1	NUTUNE 0200	NUNOTE 0214
PLAYB 021C	DELYA 0238	NOPLAY 0242	GTREST 024A
GTNOTE 0253	SVNOTE 0265	SAVE 0291	DOAGN 0298
DNOTES 02A4	DELAY 02AC	DELA 02B0	TEST 02B5
TONE 02DD	SOUND 02E2	NOTEX 02E7	NWAIT 02E9
TIMOUT 02F9	PLATUN 0300	PLAYC 031F	RETURN 0332
SAVEX 0333	GETHI 0356	LOADHI 036F	RETRNB 0375
GETSRP 0386	RETRNC 039A	DISPLY 03AA	REPEAT 03B3
LIGHT 03B5	WAITY 03C1	INCNOT 03D7	GTLNTH 03DA
KEYTST 03DE	LODLNT 03EF	PAD 1700	PADD 1701
TIMER 1704	TTIMER 1707	STIMER 170F	SAD 1740
SADD 1741	SBD 1742	PBDD 1743	KEYIN 1F40
GETKEY 1F6A			

THE MICRO SOFTWARE CATALOG: IX

Mike Rowe
P.O. Box 64
S. Chelmsford, MA 01824

Name: **MASTER CATALOG**
System: **Apple II with disk**
Memory: **32K (min)**
Language: **Applesoft II and machine language**
Hardware: **Apple II, Disk II**
Description: **MASTER CATALOG** creates a single alphabetized file and listing of each diskette catalog entry by program name, volume number, and program type. **MASTER CATALOG** will help you locate your programs. A machine language sort will speed the sort by program name or volume number.
Copies: **Just released**
Price: **\$8.00**
Includes: **Cassette and instructions**
Author: **Alan G. Hill**
Available from:
Alan G. Hill
12092 Deerhorn Dr.
Cincinnati, Ohio 45240

Name: **BASIC OPTIMIZER**
System: **Apple II**
Memory: **24K(min) Cassette version, 32K(min) Disk version**
Language: **Interger Basic**
Hardware: **STANDARD (DOS for Disk Version)**
Description: **Restructures** your basic program by eliminating all remarks, condensing code to long strings, eliminating unneeded line numbers and renaming numeric variables. In affect, the **Optimizer** creates a production program. You will get a 10% to 40% increase in the speed of execution by running your program through the **Optimizer**. Now you can write your program with all the remarks you need; give your variables meaningful names. After the program is done, let the **Optimizer** create a fast efficient production version.
Copies: **Just released**
Price: **\$19.95** for Cassette Version. **\$25.95** for Disk Version. Texas residents add 5% sales tax
Includes: **Cassette Version: Cassette and Instructions. Disk Version: Diskette with sample program and instructions.**
Author: **Bruce H. Barber**
Available from:
Bruce H. Barber
11803 Rosewood Drive
Houston, TX 77070

Name: **PET PILOT**
System: **PET**
Memory: **8K**
Language: **BASIC**
Hardware: **Student use: no extra hardware.**
Teacher use: cassette #2
Description: **Full Pilot** for **PET**, with full **BASIC** in **C** statements & programs to **80K** characters. No more memory limitation on program size: you can write real courses in this **PILOT**.
Copies: **Release date 4-15-79, 5 test sites.**
Price: **\$12.00** postpaid in US (prepaid orders only)
Includes: **Teacher's Manual Cassette, Reference Card, Licence for 1 machine.**
Order Info: **Must be prepaid and include PET serial number.**
Author: **Dave Gomberg + Martin Kamp**
Available from:
Dave Gomberg + Martin Kamp
7, Gateview Court
San Francisco, CA 94116

Name: **Series One**
System: **PET**
Memory: **8K**
Language: **Not Specified**
Hardware: **Basic 8K PET or 16/32K Full-keyboard PET**
Description: **Series One** is a collection of 25 programs for the **Commodore PET** personal computer. For less than one collar each, **Series One** contains 16 games and 9 general programs. Games include **Space Wars, Motorcycle Jump, Saucer Attack, Ping Pong, Bomb Squad, Crack the Safe, Bombs Away, Bite the Wall, Auto Race, Break Away**, and six others. Other programs include **Mortgage Loan, Perpetual Calendar, Elementary Math, Savings Account, Clock**, and more. Most programs take full advantage of the graphics capability of the **PET**.
Copies: **Not Specified**
Price: **\$24.95**
Includes: **Not Specified**
Author: **Not Specified**
Available from: **Local PET Dealers, or,**
ADP Systems
95 West 100 South
Logan, UT 84321

Name: **An 8080 Simulator for the 6502 — KIM-1 Version**
System: **KIM-1**
Memory: **1K**
Language: **Assembly language.**
Hardware: **Unexpanded KIM-1 and (optionally) 8 switches, 1 resistor**

Description: Executes the full 8080 instruction set as though KIM were an 8080-based computer. Supports single-step, trace and run modes and allows monitoring and modification of all internal 8080 registers. User definable input and output ports, breakpoints and access to 6502 subroutines directly from 8080 programs. Up to 224 bytes of 8080 programming space available on an unexpanded KIM-1. Also simulates 8080 interrupts. An excellent training aid for 8080 programming and useful for debugging 8080 code as well as for running non-time dependent 8080 application software. Can be relocated in ROM.

Copies: **90 +**

Price: **\$18.00 + \$1.50 Shipping & Handling.** California residents must add 6% sales tax.

Includes: KIM-1 format cassette tape, User Manual, Assembly Source and Object Listings and 8080 Time-Of-Day Clock Demo.

Order Info: Send check or money order.

Author: **Dann McCreary**

Available from:

Dann McCreary
Box 16435-M
San Diego, California 92116

Name: **Light Pen No. 4**
System: **Apple**
Memory: **16K and ROM Board, and Light Pen**
Language: **Apple II Soft**

Description: Program allows user to plot points on the screen in Low-Res, then converts the data to Hi-Res. Plot can be in colors.

Price: **\$34.95 + \$1.00 postage & handling (PA res. add 6% sales tax)**

Includes: Light Pen and 4 other support programs

Copies: **20**

Author: **Nell D. Lipson**

Available from:

Progressive Software
P.O. Box 273
Ply. Mtg., PA 19462

Name: **Morse Code**

System: **Apple**

Memory: **16K**

Language: **Integer Basic**

Description: Program allows user to learn morse code by typing English into computer and having morse code dots and dashes appear on the screen and hearing the beeps (audio) at the same time. Program has transmission speed control.

Copies: **10**

Price: **\$9.95 + \$1.00 postage & handling (PA residents add 6% sales tax)**

Includes: Cassette with instructions

Author: **Ed Hanley**

Available from:

Progressive Software
P.O. Box 273
Ply. Mtg., PA 19462

Name: **GRAFAX**
System: **OSI Challenger IIP**
Memory: **4k (6k optional with buffer)**
Language: **BASIC and machine language**
Hardware Required: **Challenger II(50X cpu,540 video with graphics rom, polled keyboard)**

Description: If you have OSI's rom graphics generator chip then you have been looking for GRAFAX! GRAFAX is designed to give you finger-tip control over the full OSI graphics capabilities. You no longer will need laborious poke list, BASIC string conversions, or machine language kludges just to get something on the screen. GRAFAX uses single key-stroke commands for cursor movement, character selection, 32/64 format, screen save/restore (optional, requires at least 2k ram beyond the basic 4k machine), and cassette save/load. GRAFAX is not an X-Y plotter, but rather a full screen imaging tool carefully devised to free your creative ability for drawing instead of programming.

Copies: **New, just released.**

Price: **\$10.00 + 1.00 postage (USA)**

Includes: 300 baud cassette (BASIC/machine language source, sample screens), and documentation.

Author: **Mark Bass**

Available from:

Mark Bass
269 Jamison Drive
Frankfort, Illinois 60423

Name: **Polar Coordinate Plot**
System: **Apple**
Memory: **16K and ROM Board**
Language: **Apple II Soft**

Description: A high resolution graphics program which plots polar coordinate equations (4 classic equations and user's own equation). After plot is completed, data (in cartesian and polar coordinate system) will appear on the screen in a summary table form so that the plot can be easily duplicated.

Copies: **50**

Price: **\$9.95 + \$1.00 postage and handling (PA residents add 6% sales tax)**

Includes: Cassette with instructions

Author: **T. David Moteles**

Available from:

Progressive Software
P.O. Box 273
Ply. Mtg., PA 19462

Name: **DISC COPY**
System: **Apple II**
Language: **Applesoft II**
Hardware: **Apple II, Disc II**

Description: For those Apple owners who have only one disc drive but would still like to copy discs that contain Integer Basic and Applesoft programs, this two-part program is a must. It results in an automatic system that can copy a whole discs worth of programs.

Price: **\$15**

Copies sold: **Just released**

Author: **Jules H. Gilder**

Available from:

Softsell Associates
2022-79th Street
Brooklyn, NY 11214

MORE INNOVATIONS!

FROM

P.S. SOFTWARE HOUSE

FORMERLY PESHACK

PET™ INTERFACES

NEW!

PET to CENTRONICS INTERFACE \$98.00
 PET to PARALLEL INTERFACE with 5V .8A power supply \$74.95
 PET to 2nd CASSETTE INTERFACE \$49.95

PET™ SCHEMATICS

FOR ONLY \$24.95 YOU GET:

24" X 30" schematic of the CPU board, plus oversized schematics of the Video Monitor and Tape Recorder, plus complete Parts layout - all accurately and painstakingly drawn to the minutest detail.

PET™ ROM ROUTINES

FOR ONLY \$19.95 YOU GET:

Complete Disassembly listings of all 7 ROMS, plus identified subroutine entry points; Video Monitor, Keyboard routine, Tape Record and Playback routine, Real Time Clock, etc. To entice you we are also including our own Machine Language Monitor program for your PET using the keyboard and video display. You can have the Monitor program on cassette for only \$9.95 extra.

SOFTWARE:

6502 DISASSEMBLER \$12.95
 MAILING LIST - For personal or business applications. \$9.95
 MACHINE LANGUAGE MONITOR - Write Machine Code. Save on tape \$9.95
 BUDGET - NEW - Keep track of Bills and Checks. Update as needed \$14.95
 STARTREK - All-time favorite written for the PET's special Graphics \$7.95

Send for our free SOFTWARE BROCHURE. Dealer inquiries welcome.

P.S. SOFTWARE HOUSE

P.O. Box 966

Mishawaka, IN 46544



Tel: (219) 255-3408



PET is a trademark of Commodore Business Machines

PET SPECIALS

	LIST	SALE
PET 16K	\$ 995	\$ 860
PET 32K	\$1295	\$1125
PET 8K	\$ 795	\$ 695
PET 2040 Dual Disk	\$1295	\$1125
PET 2023 Printer (pressure feed)	\$ 849	\$ 750
PET 2022 Printer (tractor feed)	\$ 995	\$ 860

KIM-1 \$159 SYM-1 \$ 229
 Memory Plus (FOR KIM SYM AIM) \$ 199
 SEA-16 New 16K Static RAM \$ 325
 Seawell Motherboard-4K RAM space \$ 99

3M "Scotch" 8" disks SALE 10/\$31.00
 Verbatim 5" diskettes SALE 10/\$28.50

2114 L 450 ns 4K Static RAM \$ 6.95
 2716 EPROM (5 volt) \$ 45
 Programming the 6502 (Zaks) \$ 9.90
 6502 Applications Book (Zaks) \$11.90
 6500 Programming Manual (MOS) \$ 6.50
 6500 Hardware Manual (MOS) \$ 6.50
 First Book of KIM \$ 8.90
 Programming a Microcomputer:6502 (Foster) \$ 8.90

Cassettes (all tapes guaranteed)

Premium quality, high output lownoise in 5 screw housing with labels:

C-10 10/5.95 50/25.00 100/48.00
 C-30 10/7.00 50/30.00 100/57.00

WRITE FOR 6502 AND S-100 PRODUCT LIST

A B Computers

115 E. Stump Road
 Montgomeryville, PA 18936
 (215) 699-8386

SYBEX

LEADER IN
 COMPUTER EDUCATION

INTRODUCES THE 6502 SERIES

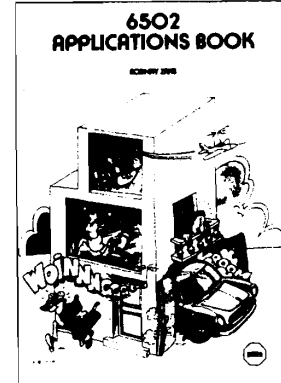

PROGRAMMING THE 6502

By Rodnay Zaks
 320 pp, ref C202 \$10.95

An introductory programming text for the 6502. Does not require any prior programming knowledge. From arithmetic to interrupt-driven input-output techniques. It has been designed as a progressive, step by step course, with exercises in the text designed to test the reader at every step.

6502 GAMES

By Rodnay Zaks
 ref G402 \$13.95

From Piano to tic tac toe, including many popular games, and how to program your own. To be published.

6502 APPLICATIONS BOOK

by Rodnay Zaks
 275 pp, ref D302 \$12.95

Presents a series of practical (hardware & software) applications for any 6502 board. Applications can be used as experiments - or implemented at minimal cost. A few examples: morse generator, electronic piano, digital clock, home alarm systems, traffic controller....and more!

TO ORDER

By phone: 415 848-8233, Visa, M.C., American Express.

By mail: include payment.

Shipping charges: add 65¢ per book
 4th class - allow 4 weeks - or \$1.50 per book for U.P.S. Overseas add \$3.00 per book.

Tax: in California add tax.

AVAILABLE AT BOOKSTORES, COMPUTER, AND
 ELECTRONIC SHOPS EVERYWHERE



2020 Milvia Street
 Berkeley, CA 94704
 Tel 415 848-8233 Telex 336311

NAME _____ POSITION _____

COMPANY _____

ADDRESS _____

CITY _____ STATE/ZIP _____

charge my: Visa M.C. American Express

C202 D302 G402

Number _____ Exp. date _____

Signature _____

MM Send Free Catalogue

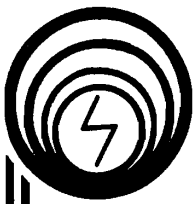

compass
microsystems

224 S. E. 16th Street
P.O. Box 687
Ames, Iowa 50010
Phone 515-232-8187

single board computers

CSB 1

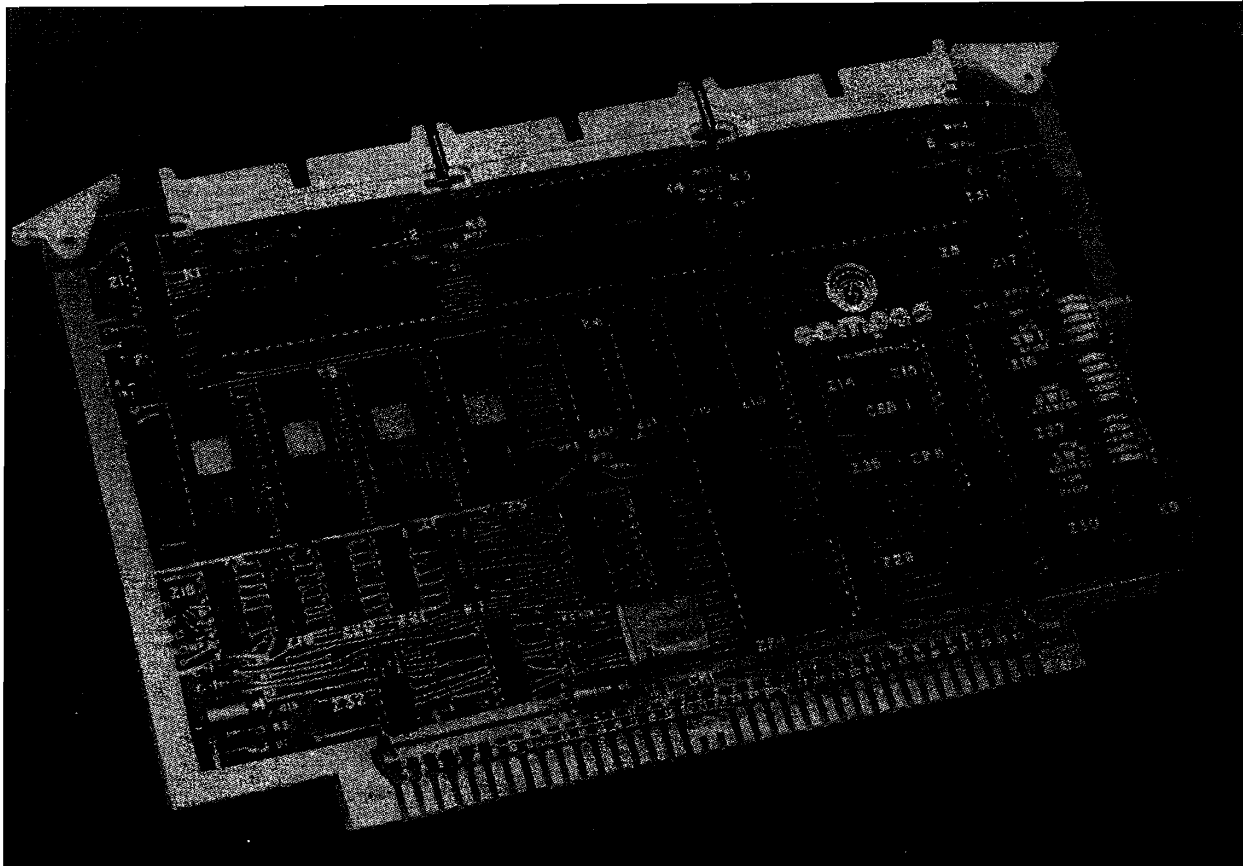

THE 6500 BASED SINGLE BOARD COMPUTER YOU HAVE BEEN LOOKING FOR

An industrial quality 6500 based single board computer produced by the company known for quality 6500 hardware and software. CSB 1 includes a 6502 processor, four ROM/EPROM sockets, 2K bytes RAM(2114), two PIA(6520) and one VIA(6522) chips. All addresses are switch selectable and a single +5 volt power supply is needed. Board size is 6 by 9.75

inches. The gold plated edge connector adheres to the SYSTEM 65 bus standard. Single quantity price is \$595 with substantial quantity discounts available. Other CSB board products are available or in design. Call us today for further information on our CSB family or any of our other 6500 support products.

Sym-1: Speak To Me

If you want your computer to carry on some snappy dialog, you are a real dreamer. But, here are some techniques to get you started with limited speech for your micro.

Jack Gieryic
2041 138th Ave. N.W.
Andover, MN 55303

In the February issue of KILBAUD I came across an interesting article by Robert Bishop. In this article the tape recorder input line was used to sample a voice signal and the tape recorder output line was set high or low depending on the sample. Hopefully the resulting square wave pattern contained enough of the voice's original fundamental to reproduce an understandable signal. A primitive form of speech synthesis indeed but this idea did start the wheels rolling in my head.

Since we are dealing with square waves and not discrete samples at various amplitudes, I thought the sampling frequency would need to be much higher than the theoretical two times the reproduceable frequency. I wrote the accompanying short program which results in slightly over 40,000 samples per second. That's about the limit of the SYM-1 and I figured that should do it for voice. I used my stereo receiver to further help as it has reasonably good amplifiers. I put my cassette deck on record-pause and plugged in a microphone. The tape deck output went to the SYM for sampling on the SYM's normal tape input line. The SYM's tape output line was connected to one of the tape recorder inputs on the stereo receiver.

At this point I began executing the program and listened to the fruits of my labor — sour as they were. The resulting sound reminded me of a small speaker driven to distortion although it was understandable. The recording level control was critical. Remember the SYM sees either a "1" or a "0". The input signal must vary enough to trip the input line. If the volume is too high then too many 1's will be "seen." If the volume is too low then nothing will be heard as the input line will remain a zero. Whistling across (not into) the microphone produced good results. Playing some of my music tapes also was interesting. Only the foreground sounds were "reproduced." The background sounds didn't have enough volume to trip the logic level.

Primitive as this is, it is good enough to use for computer — to-user communications. However, this will require enormous amounts of memory which places a damper on things. The sampling rate of my program would fill 5K of memory in about 1 second. An option would be to reduce the sampling rate. I did this but the results were very poor. Remember this method is using a square wave. At a 10,000 sample/second rate too little information remained and harmonics from the square waves interfered. Change location '225 and '231 to hex 33 and see for yourself. By changing location '234 you can vary the sampling rate. "Ed" will result in 10,000 sample/second. Try "do" and whistle into the microphone. You'll hear the unwanted harmonics so abundant in a square wave.

I had thought of plagerizing the system's tape record/playback routines in order to store the square wave on tape instead of using memory. However, in the high speed format I could only store about 1500 bits per second (185 8 bit characters per second) which is far too

low a sampling rate to be useful. Perhaps a floppy disk would have a high enough data transfer rate to be of some use. This is food for thought.

If any of you are still seriously interested then I would suggest an 8 bit analog-to-digital convertor to digitize the data. The data could then be sent through an 8 bit digital-to-analog converter to reproduce the signal. Much lower sampling rates on the order of 5,000 to 8,000 samples/second could be used for voice. However, even at 5,000 8 bit samples per second you would still consume 5K memory in one second.

The approach of recording all characteristics of speech for either recognition or future reproduction deserves a reassessment. Perhaps there is some key remaining to be discovered which will enable the computer to use speech with a very limited amount of data. Software may need a greater hardware assist in order to accomplish what seems to be a difficult task. The near future may provide the answer.



BURP!

SYM SPEAK TO ME

BY JOHN GIERYIC

MAY 1979

PAGE ZERO EQUATE

023B MASK * \$0001

SYM REGISTER EQUATES

023B VORBX * \$A000 VIA OUTPUT REGISTER B
023B VDDRB * \$A002 VIA DATA DIRECTION REGISTER B
023B ORB * \$A402 6532 OUTPUT REGISTER B
023B DDRB * \$A403 6532 DATA DIRECTION REGISTER B

0200 ORG \$0200

0200 A9 07 START LDAIM \$07 SET UP MASK
0202 85 01 STA MASK
0204 A9 00 LDAIM \$00 SET DATA DIRECTION FOR INPUT
0206 8D 02 A0 STA VDDRB IN VIA
0209 A9 BF LDAIM \$BF SET DATA DIRECTION FOR OUTPUT
020B 8D 03 A4 STA DDRB 6532
020E A9 07 LDAIM \$07 TURN BIT ON - OUTPUT
0210 8D 02 A4 STA ORB 6532

0213 AD 00 A0 LOOPA LDA VORBX SAMPLE VIA INPUT
0216 29 40 ANDIM \$40
0218 F0 0D BEQ LOOPB IF ZERO, GO CLEAR BIT
021A AD 02 A4 LDA ORB IF NOT ZERO, SET BIT
021D 29 F8 ANDIM \$F8
021F 45 01 EOR MASK
0221 8D 02 A4 STA ORB OUTPUT
0224 4C 13 02 JMP LOOPA

CHANGE ABOVE TO JMP DELAY TO CHANGE THE
SAMPLE RATE FROM 40,000 TO 10,000 CPS
LOCATION 224 = 33
ALSO CHANGE LOCATION 231.

0227 AD 02 A4 LOOPB LDA ORB CLEAR BIT
022A 29 F8 ANDIM \$F8
022C EA NOP FOR TIMING
022D 8D 02 A4 STA ORB OUTPUT
0230 4C 13 02 JMP LOOPA

CHANGE ABOVE TO JMP DELAY TO CHANGE THE
SAMPLE RATE FROM 40,000 TO 10,000 CPS
LOCATION 231 = 33
ALSO CHANGE LOCATION 224.

0233 A2 ED DELAY LDXIM \$ED 96. MICROSECOND DELAY
0235 E8 LOOPC INX
0236 D0 FD BNE LOOPC
0238 4C 13 02 JMP LOOPA

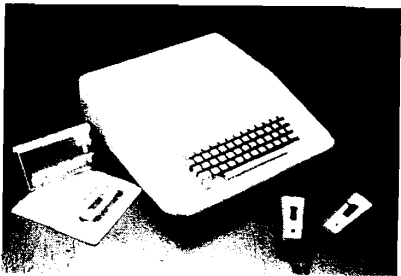

Apple II \$1195

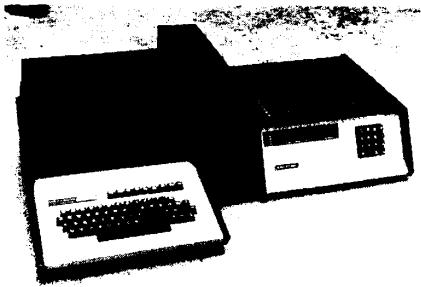

Heathkit H-8 \$375



SOL-20 \$1600



Exidy Sorcerer \$895

Which of these computers is for you?

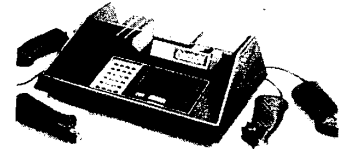

Bally Arcade \$399



Radio Shack TRS-80 \$599

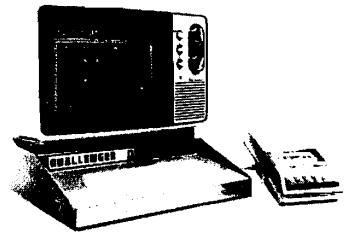

Ohio Scientific C2-4P \$598

CREATIVE COMPUTING magazine is Number 1 in hardware, software and system evaluations. In-depth, thorough evaluations give you the facts **before** you buy. **Creative Computing** was the first to review these now popular systems: Radio Shack TRS-80, Exidy Sorcerer, VideoBrain, Heath H-8, Bally Basic, OSI Challenger, and many others. More important, we also review peripherals and software from independents as well as manufacturers.

And what are you going to do with it?

CREATIVE COMPUTING has long been Number 1 in applications and software for micros, minis, and time-sharing systems for homes, schools and small businesses. Loads of applications every issue: text editing, graphics, communications, artificial intelligence, simulations, data base and file systems, music synthesis, analog control. Complete programs with sample runs. Programming techniques: sort algorithms, file structures, shuffling, etc. Coverage of electronic and video games and other related consumer electronics products, too.

Just getting started? Then turn to our technology tutorials, learning activities, short programs, and problem solving pages. No-nonsense book reviews, too. Even some fiction and foolishness.

Subscriptions: 1 year \$15, 3 years \$40. Foreign, add \$9/year surface postage, \$26/year air. Order and

payment to: Creative Computing, attn: Ellen, P.O. Box 789-M, Morristown, NJ 07960. Visa or Master Charge acceptable by mail or phone; call **800-631-8112** 9 am to 5 pm EST (in NJ call 201-540-0445).

CREATIVE COMPUTING also publishes books, games, art prints, and T-shirts for the computer enthusiast. The most popular book of computer games in the world, **Basic Computer Games** is a Creative Computing book — only \$8.50 postpaid.

And now, Creative Computing also produces and markets software for personal computers on tape cassette and floppy disk.

If your dealer does not carry the full line of Creative Computing products, write "catalog" on your order and we'd be happy to send you one free.

creative computing

P. O. Box 789-M, Morristown, NJ 07960

Writing For MICRO

If you have information you wish to pass on to the 6502 community, think of **MICRO** first. Since **MICRO** is devoted solely to 6502 material, your article will probably be read by more people than it would be in many of the "general purpose" national magazines. And, **MICRO** pays for articles. You'll never get rich, but you can get enough from an article to buy that extra memory you want. Also, our policy is to give authors additional payments if the material is reprinted. For example, authors whose work appeared in the original six issues of **MICRO** and were reprinted in "The BEST of **MICRO** Volume 1" are receiving double payment — so it can add up.

WHAT TO SUBMIT — **MICRO** is only interested in things which pertain to the 6502 microprocessor. Since **MICRO** takes the 6502 seriously, it is less interested in games than in useful material such as utility programs, tutorials, resources, interfacing techniques, and so forth. Complete "ready-to-load-and-go" programs are preferred to "think-programs". Look at what we have published in the past as a guide to what types of articles we prefer.

TEXT — All material should be typed, double-spaced on one side on white

paper. Your name and a page number should appear on each page. Try to adhere as much as possible to the format that **MICRO** uses for publication — it saves us a lot of work. Paragraphs are not indented, sub-headings are centered, figures are referenced as Figure 1 (2, 3, . . . n) and tables as Table I (II, III, IV, . . . N). You should suggest a title and may write a brief summary, although this is not necessary.

PROGRAM LISTINGS — All listings should be printed directly from your computer if possible, with a new black ribbon on plain white paper. If your listings are clean enough to print, then we do not have to typeset them, decreasing the chance for typos. Since line numbers used by your editor may be removed, please make all references to your listings by address or PC counter.

DRAWINGS and SCHEMATICS — A good drawing can add a lot of visual interest as well as information to your article. We do not have any special talents in this area, plus we may make mistakes when redrawing your work. So please, if at all possible, submit drawings in ink, ready for reproduction. Since most drawings will be reduced to fit into two columns — approximately four inches,

keep this size in mind when planning your work.

PERSONAL INFORMATION — Our readers would like to know something about the authors. If you submit a short note about yourself — your computer experience, talents, interests, plans — we will publish this along with your article. You have done the work, why not enjoy the credit!

RETURN OF MANUSCRIPTS — If you want your manuscript returned, just tell us. We will supply the stamp and envelope — its the least we can do.

PAYMENT — **MICRO** pays for all articles which we publish. You will be sent a Manuscript Release Form prior to your article being printed. By signing this and returning it to us, you certify that the work you have submitted is yours to sell, and convey all rights to the work to **MICRO** Ink, Inc. You will receive six copies of your article.

LETTERS, NOTES, ANNOUNCEMENTS, etc. — If you have short pieces of information that do not fit into the article format, **MICRO** has a number of ways of using them. They may be submitted in almost any form, even hand-written, and will be used as the Editor sees fit. There is no payment for these submissions, but full credit is given to the author.

KIM™ BUS EXPANSION!

AIM™, VIM™, (SYM)™, KIM™ OWNERS
(and any other KIM™ bus users) buy the best 8K board available anywhere:

GRAND OPENING SPECIAL!

HDE 8K RAM-\$169! 3 for \$465!

Industrial/commercial grade quality: 100 hour high temp burn-in; low power; KIM bus compatible pin for pin; super quality & reliability at below \$-100 prices (COMMERCIALY rated \$-100 boards cost 25-75% more). When you expand your system, expand with the bus optimized for 8 bit CPU's, the Commodore/Mos Technology 22/44 pin KIM bus, now supported by Synertek, MTU, Rockwell International, Problem Solver Systems, HDE, the Computerist, RNB, and others!

KIM-1 computer \$179.00; KIM-4 Motherboard \$119; power supply for KIM-1 alone—\$45; enclosure for KIM-1 alone \$29; HDE prototype board with regulator, heatsink, switch address & decoding logic included \$49.50; book "The First Book of KIM" \$9.95; book "Programming a Microcomputer: 6502" \$8.95; SPECIAL PACKAGE DEAL: KIM-1, power supply, BOTH books listed above, ALL for \$208!

HDE FILE ORIENTED DISK SYSTEM (FODS) FOR KIM BUS COMPUTERS Make your KIM (or relative) the best 6502 development system available at any price. Expand with HDE's full size floppy system with FODS/Editor/Assembler. 2 pass assembler, powerful editor compatible with ARESKO files KIM bus interface card: fast 6502 controller handles data transfer at maximum IBM single density speed for excellent reliability; power supply for 4 drives; patches to Johnson Computer/Microsoft BASIC. 45 day delivery. Single drive—\$1995 dual drive \$2750

Shipping extra unless order prepaid with cashier's check ALL items assembled, tested, guaranteed at least 90 days.

PLAINSMAN MICRO SYSTEMS (div. 5C Corporation)
P.O. Box 1712, Auburn, Al. 36830: (205)745-7735
3803 Pepperell Parkway, Opelika

[1-800-833-8724] Continental U.S. except Al.
Dealers for OSI, COMMODORE, COMPUCOLOR.

VISA

ALTOS

EA ELLIAM ASSOCIATES
24000 Bessemer Street
Woodland Hills, Ca. 91367



SHORTY C-10 CASSETTES

- Tarbell Quality
- "SCOTCH" brand high output/low noise "POSI-TRAK" back treated tape
- Spring loaded pressure pad
- 5 screw take-apart shell
- Exclusive EA label

Stock No. EAC-10 \$13.50/10 \$26.00/20

CASSETTE LABELS

5626-6	Blank	Fanfold	6 Lines/Inch	\$5.90/100
5626-8	Blank	Fanfold	8 Lines/Inch	5.90/100
CLB-R	Blank	Sheet	15/Sheet	6.20/ 90
5626-B	Blank	Pack		4.00/100
EA-EBEA	Printed	Pack	EA Label	5.50/100
CLP-R	Printed	Sheet	15/Sheet	7.50/ 90

MAILING LABELS

4815-1	2 1/2 x 15/16	Fanfold	\$4.40/1000
5615-1	3 1/2 x 15/16	Fanfold	4.40/1000

VOLUME AND DEALER DISCOUNTS AVAILABLE

STOCK NO.	QUANTITY	PRICE	TOTAL

Name _____ Cal. Tax 6% _____

Address _____

City _____ State _____ Zip _____

Exp. Date _____ Bank No. _____

Card No. _____

Signature _____

PREPAID ORDERS SHIPPED POSTPAID

Reading Pet Cassettes Without a Pet

If you have ever wanted to read a program from a cassette written for one 6502 based microcomputer on another type, here is an example which uses a SYM-1 to read a PET cassette. The concepts can be generalized to work with almost any combination of micros.

David P. Kemp
1307 Beltram Court
Odenton, MD 21113

One of the basic problems in obtaining microcomputer software is not that it doesn't exist but that it was written for a machine other than the one it is to be used on. Small programs can be typed in by hand if a hex listing is available, but larger programs are generally distributed on audio cassettes. By virtue of their popularity, the Apple II and PET have the largest pools of published software on cassette, but that doesn't mean that owners of less well established microcomputers like the SYM-1 cannot take advantage of existing programs written for these machines.

All 6502 based microcomputers except the KIM use very simple cassette interface hardware and let the processor do all the work of formatting, encoding and decoding cassette data. This approach has the dual advantages of reducing parts count and increasing flexibility and

it means that with suitable software, users of any particular machine can read cassettes written for any other machine (Apple, PET, OSI, AIM, or SYM). This particular program runs on the SYM-1 and reads cassettes written by the PET. It is quite unsophisticated, and doesn't know the difference between various block types such as Beginning of File, End of File, Program, and Data blocks, and it does not strip off countdown bytes or verify checksums. It does check byte parity and will flag any errors; it has been my experience that if there are no parity errors, then the data is OK.

Because the task of converting software from one machine to another is non-trivial, it is assumed that only experienced programmers will have occasion to use PETCAS, thus no attempt will be made to explain the program's operation or PET cassette format in detail; however

one feature of the program deserves some comment -- the tuning display. If an oscilloscope and a D/A converter are available, the display simplifies setting up the program and the recorder controls. With the program running and a PET cassette playing, the scope trace should fall into three distinct levels corresponding to the three possible time periods between active transitions on the tape. If the display is not well clustered or the routine will not work, try exchanging the instructions at locations \$6C and \$66. (In PET cassettes polarity is significant and this modification effectively reverses the audio signal polarity).

Despite its small size, the program works quite well -- it was originally written to read a third generation analog dubbing of an 8K program, and it accomplished that task in one pass without an error. μ

NOW AVAILABLE

Basic Software

For SOL-IIA and PET-8K

General Pack 1

(Checkbook Balancer, Tic Tac Toe, Metric Conversion)

\$10.95

General Pack 2

(Space Patrol, Biorhythm, Battlestar, One-Armed Bandit)

18.95

Financial Pack 1

(loans, Depreciation, Investments)

12.95

Financial Pack 2

(Mortgage & Loan Amortization, Future Projections, Risk Analysis)

12.95

Statistics Pack 1

(Mean & Deviation, Linear Correlations & Regression, Distribution, Contingency Table Analysis)

18.95

Game Pack 1

(Basketball, Object Removal, Bowling, Darts, Gopher)

22.95

Game Pack 2 -

(children - educational)
(Arithmetic God, Addition Dice, Distance = Rate X Time)

12.95

Tape Data Query

(File Management System)

50.00

PCROS - a Real-Time Operating System in 1K KIM RAM

Assembly listing

24.95

Cassette tape with user's manual

14.95

Schematic for relay control board

9.95

All programs on high-quality cassette tape.

Send self-address, stamped envelope for complete software catalogue.

Send check or money order to:

H. GELLER COMPUTER SYSTEMS

Dept. M

P.O. Box 350

New York, New York 10040

(New York residents add applicable sales tax)

PET CASSETTE READ ROUTINE FOR SYM-1

BY DAVE KEMP
 JANUARY 1979

PETCAS READS A PET FORMAT CASSETTE RECORD
 AND STORES THE DATA IN A BUFFER STARTING AT
 \$200. TO RUN IT, TYPE:

.G 0

CONTROL IS RETURNED TO SUPERMON AFTER THE
 FIRST COPY OF THE DATA HAS BEEN READ.
 LOCATIONS ADH AND ADL POINT TO THE NEXT
 FREE BUFFER LOCATION (LAST BYTE READ + 1).

0075	ADL	*	\$00F0	BUFFER POINTER
0075	ADH	*	\$00F1	
0075	TCNT	*	\$00F2	GETBIT TEMPORARY
0075	TPAR	*	\$00F3	PARITY GENERATOR TEMPORARY
0075	PECNT	*	\$00F4	PARITY ERROR COUNT
0075	PAR	*	\$00FE	PARITY ERROR MARKER VALUE ARBITRARY
0075	TAPE	*	\$A000	CASSETTE INPUT PORT (PB6)
0075	DIGANA	*	\$A001	DIGITAL TO ANALOG CONVERTER OUTPUT
0000			ORG	\$0000
0000	A9	02	PETCAS	LDAIM \$02 SET BUFFER ADDRESS TO \$0200
0002	85	F1		STA ADH
0004	85	F4		STA PECNT
0006	A9	00		LDAIM \$00
0008	85	F0		STA ADL
000A	20	2F	00	PETCA JSR GBYTE GET A BYTE
000D	30	03		BMI PETX
000F	4C	00	00	JMP PETCAS LEADER NOT STABLE YET
0012	C6	F4		PETX DEC PECNT BE SURE LEADER IS VALID
0014	D0	F4		BNE PETCA
0016	20	2F	00	PETCB JSR GBYTE GET BYTE
0019	30	FB		BMI PETCB LOOP UNTIL END OF LEADER
001B	B0	04		PETCC BCS PETCD DATA VALID ?
001D	A9	FE		LDAIM PAR NO - PARITY ERROR
001F	E6	F4		INC PECNT INCREMENT ERROR COUNT
0021	91	F0		PETCD STAIY ADL SAVE IT IN BUFFER
0023	E6	F0		INC ADL ADVANCE BUFFER POINTER
0025	D0	02		BNE PETCE
0027	E6	F1		INC ADH
0029	20	2F	00	PETCE JSR GBYTE GET ANOTHER BYTE
002C	10	ED		BPL PETCC CONTINUE IF DATA
002E	60			RTS EXIT IF SHORTS

GET A BYTE OF PET DATA

RETURN:

A = BYTE
 C = 0 IF PARITY ERROR
 N = 1 IF SHORTS
 X CLOBBBERED, Y = 0

```

002F A0 11      GBYTE  LDYIM $11  SHORTS COUNT
0031 20 63 00  GBA     JSR   GETTR  GET TRANSITION TIME
0034 E0 40      CPXIM $40  START BIT ?
0036 B0 08      BCS   GBB    YES - GO GET BYTE
0038 E0 2C      CPXIM $2C  SHORTS ?
003A B0 F3      BCS   GBYTE  NO - START COUNTING AGAIN
003C 88         DEY                    YES - DECREMENT COUNT
003D 10 F2      BPL   GBA
003F 60         RTS

0040 A0 09      GBB     LDYIM $09  BIT COUNT
0042 84 F3      STY   TPAR  INITIALIZE PARITY
0044 20 63 00  JSR   GETTR  GET OTHER HALF OF START BIT
0047 20 58 00  GBC     JSR   GETBIT GET A DATA BIT
004A 90 02      BCC   GBD
004C E6 F3      INC   TPAR  ADJUST PARITY
004E 6A         GBD     RORA                    PACK IT
004F 88         DEY                    DONE ?
0050 D0 F5      BNE   GBC    NO
0052 2A         ROLA                    YES - ADJUST DATA
0053 49 FF      EORIM $FF
0055 46 F3      LSR   TPAR  PUT PARITY IN C
0057 60         RTS

```

GET A DATA BIT

RETURN:

C = BIT
 X CLOBBBERED, A & Y UNCHANGED

```

0058 20 63 00  GETBIT JSR   GETTR  GET FIRST TRANSITION
005B 86 F2      STX   TCNT  SAVE IT
005D 20 63 00  JSR   GETTR  GET SECONT TRANSITION
0060 E4 F2      CPX   TCNT  GENERATE BIT IN C
0062 60         RTS

```

GET A TRANSITION PERIOD

RETURN:

X = PERIOD
 A & Y UNCHANGED

```

0063 A2 00      GETTR  LDXIM $00  INIT COUNTER
0065 2C 00 A0  GETA   BIT   TAPE
0068 E8         INX                    INCREMENT COUNTER
0069 70 FA      BVS   GETA  LOOP WHILE HIGH
006B 2C 00 A0  GETB   BIT   TAPE
006E E8         INX
006F 50 FA      BVC   GETB  LOOP WHILE LOW
0071 8E 01 A0  STX   DIGANA OUTPUT TO D/A FOR TUNING
0074 60         RTS

```

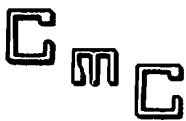

CONNECTICUT microCOMPUTER, Inc.

150 POCONO ROAD - BROOKFIELD, CONNECTICUT 06804

(203) 775-9659

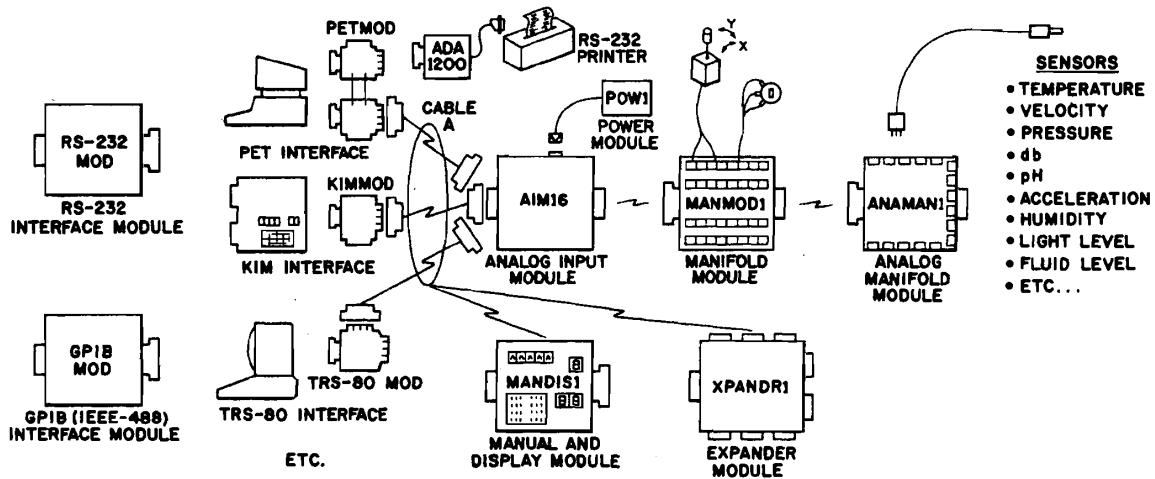

DAM SYSTEMS by CmC
A complete system of modules to let your computer listen to the real world.

DAM SYSTEMS PRICE LIST

DAM SYSTEMS components			
AIM161 - Analog Input Module	\$179.00	KIMMOD - KIM Interface Module	\$39.95
16 8-bit analog inputs - 100 microsecond conversion time - 3 state output - requires one 8-bit computer output port for control and one 8-bit computer input port for data.		Gives one application connector port and one DAM SYSTEMS interface port.	
AIM162 - Analog Input Module	\$249.00	CABLE "A" - Interconnect Cables	TBA
As above plus: greater accuracy - gold plated contacts - pilot light - switch selectable start, enable and ready polarities.		Connects computer interface to AIM16, MANDIS1, XPANDR1, etc.	
POW1 - Power Module	\$14.95	CABLE A24 - Interconnect Cable	\$19.95
Supplies power for one AIM16 module.		24 inch cable with interface connector on one end and an OCON equivalent on the other.	
ICDN - Input Connector	\$9.95	MANDIS1 - Manual and Display Module	TBA
For connecting analog inputs to the AIM16 - 20 pin card edge connector - solder eyelets.		Connects between the AIM16 and the computer interface. Allows manual or computer control of the AIM16. Displays channel number and data.	
OCON - Output Connector	\$9.95	GPIB MOD - GPIB (IEEE-488) Interface	TBA
For connecting the AIM16 to a computer - 20 pin card edge connector - solder eyelets.		Allows the DAM SYSTEMS MODULES to be used with the GPIB bus instead of a computer's other I/O ports.	
MANMOD1 - Manifold Module	\$59.95	RS232 MOD - RS232 Interface Module	TBA
Use in place of ICDN. Screw terminal barrier strips for connecting josticks, potentiometers, voltage sources, etc. Eliminates the need for soldering. Plugs into the AIM16.		Allows the DAM SYSTEMS MODULES to be used with an RS-232 port or terminal.	
ANAMAN1 - Analog Manifold Module	TBA	XPANDR1 - Expander Module	TBA
Use in place of ICDN. Connects DAM SYSTEMS SENSORS to the AIM16 without soldering - sensor cables just plug in. Plugs into the AIM16 or the MANMOD1.		Allows up to 128 8-bit analog inputs (8 AIM16 Modules) to be connected to one system.	
SENSORS	TBA	DAM SYSTEMS sets	
Sensors for temperature, pressure, flow, humidity, level, pH, motion, etc.		AIM161 Starter Set	\$189.00
COMPUTER INTERFACES	TBA	Includes one AIM161, one POW1, one ICDN and one OCON.	
For the PET, KIM, TRS-80, etc. Use in place of ICDN. Eliminates the need for soldering or special construction.		AIM162 Starter Set	\$259.00
PETMOD - PET Interface Module	\$49.95	Includes one AIM162, one POW1, one ICDN and one OCON.	
Gives two IEEE ports, one user port and one DAM SYSTEMS interface port. Saves wear and tear on the PET's printed circuit board. Also called the PETAUR.		PETSET1a	\$295.00
		Includes one PETMOD, one CABLE A24, one AIM161, one POW1 and one MANMOD1.	
		KIMSET1a	\$285.00
		Includes one KIMMOD, one CABLE A24, one AIM161, one POW1 and one MANMOD1.	

APPLE II® PROFESSIONAL SOFTWARE

PIE TEXT EDITOR

PIE (PROGRAMMA IMPROVED EDITOR) is a two-dimensional cursor-based editor designed specifically for use with memory-based and cursor-based CRT's. It is totally different from the usual line-based editors, which were originally designed for Teletypes. The keys of the system input keyboard are assigned specific PIE Editor function commands. Some of the features included in the PIE system are: Blinking Cursor; Cursor movement up, down, right, left, plus tabs; Character insert and delete; String search forwards and backwards; Page scrolling; GOTO line number, plus top or bottom of file; Line insert and delete anywhere on screen; Move and copy (single and multiple lines); Append and clear to end of line; Efficient memory usage. The following commands are available in the PIE Text Editor and each is executed by depressing the systems argument key simultaneously with the command key desired:

- [LEFT] Move cursor one position to the left
- [RGHT] Move cursor one position to the right
- [UP] Move cursor up one line
- [DOWN] Move cursor down one line
- [BHOM] Home cursor in lower left hand corner
- [HOME] Home cursor in upper left hand corner
- [-PAG] Move up (toward top of file) one "page"
- [+PAG] Move down (toward bottom of file) one "page"
- [LTAB] Move cursor left one horizontal tab
- [RTAB] Move cursor right one horizontal tab
- [GOTO] Go to top of file (line 1)
- [GOTO]n Go to line 'n'
- [GOTO] Go to bottom of file (last line + 1)
- [-SCH] Search backwards (up) into file for the next occurrence of the string specified in the last search command
- [ARG]t[-SCH] Search backwards for string 't'
- [+SCH] Search forwards (down) into the file for the next occurrence of the string specified in the last search command
- [ARG]t[+SCH] Search forward for string 't'
- [APP] Append -move cursor to last character of line +1
- [INS] Insert a blank line before the current line
- [ARG]n[INS] Insert 'n' blank lines before the current line
- [DEL] Delete the current line, saving it in the "push" buffer
- [ARG]n[DEL] Delete 'n' lines and save the first 20 in the "push" buffer
- [DBLK] Delete the current line as long as it is blank
- [PUSH] Save current line in "push" buffer
- [ARG]n[PUSH] Save 'n' lines in the "push" buffer
- [POP] Copy the contents of the "push" buffer before the current line
- [CINS] Enable character insert mode
- [CINS][CINS] Turn off character insert mode
- [BS] Backspace
- [GOB] Gobble - delete the current character and pull remainder of characters to right of cursor left one position
- [EXIT] Scroll all text off the screen and exit the editor
- [HOME] Home Line - scroll up to move current line to top of screen
- [APP][APP] Left justify cursor on current line
- [ARG][GOB] Clear to end of line

Apple PIE Cassette	16K	\$19.95
TRS-80PIE Cassette	16K	19.95
Apple PIE Disk	32K	24.95

6502FORTH · Z-80FORTH 6800 FORTH

FORTH is a unique threaded language that is ideally suited for systems and applications programming on a micro-processor system. The user may have the interactive FORTH Compiler/Interpreter system running stand-alone in 8K to 12K bytes of RAM. The system also offers a built-in incremental assembler and text editor. Since the FORTH language is vocabulary based, the user may tailor the system to resemble the needs and structure of any specific application. Programming in FORTH consists of defining new words, which draw upon the existing vocabulary, and which in turn may be used to define even more complex applications. Reverse Polish Notation and LIFO stacks are used in the FORTH system to process arithmetic expressions. Programs written in FORTH are compact and very fast.

SYSTEM FEATURES & FACILITIES

Standard Vocabulary with 200 words
Incremental Assembler
Structured Programming Constructs
Text Editor
Block I/O Buffers
Cassette Based System
User Defined Stacks
Variable Length Stacks
User Defined Dictionary
Logical Dictionary Limit
Error Detection
Buffered Input

CONFIGURATIONS

AppleFORTH Cassette 16K	\$34.95
AppleFORTH Disk 32K	49.95
PetFORTH Cassette 16K	34.95
TRS-80FORTH Cassette 16K	34.95
SWTPCFORTH Cassette 16K	34.95

LISA INTERACTIVE ASSEMBLER

LISA is a totally new concept in assembly language programming. Whereas all other assemblers use a separate or co-resident text editor to enter the assembly language program and then an assembler to assemble the source code, LISA is fully interactive and performs syntax/addressing mode checks as the source code is entered in. This is similar in operation to the Apple II Integer BASIC Interpreter. All error messages that are displayed are in plain, easy to understand English, and not simply an Error Code. Commands in LISA are structured as close as possible to those in BASIC. Commands that are included are: LIST, DELETE, INSERT, PR #n, IN #n, SAVE, LOAD, APPEND, ASM, and a special user-defineable key envisioned for use with "dumb" peripherals. LISA is DISK II based and will assemble programs with a textfile too long to fit into the Apple memory. Likewise, the code generated can also be stored on the Disk, hence freeing up memory for even larger source programs. Despite these Disk features, LISA is very fast; in fact LISA is faster than most other commercially available assemblers for the Apple II. Not only is LISA faster, but also, due to code compression techniques used LISA requires less memory space for the text file. A full source listing containing the object and source code are produced by LISA, in addition to the symbol table

Apple II 32K/Disk \$34.95

PROGRAMMA INTERNATIONAL, INC.

3400 Wilshire Blvd.
Los Angeles, CA 90010

(213) 384-0579 · 384-1116 · 384-1117

Apple II is a registered trademark of Apple Computers, Inc. These professional products are available at your local computer dealer.

ASM/65 EDITOR ASSEMBLER

ASM/65 is a powerful, 2 pass disk-based assembler for the Apple II Computer System. It is a compatible subset of the FORTRAN cross-assemblers which are available for the 6500 family of micro-processors. ASM/65 features many powerful capabilities, which are under direct control of the user. The PIE Text Editor co-resides with the ASM/65 Assembler to form a comprehensive development tool for the assembler language programmer. Following are some of the features available in the ASM/65 Editor Assembler.

- PIE Text Editor Command Repertoire
- Disk Based System
- Decimal, Hexadecimal, Octal, & Binary Constants
- ASCII Literal Constants
- One to Six character long symbols
- Location counter addressing ""
- Addition & Subtraction Operators in Expressions
- High-Byte Selection Operator
- Low-Byte Selection Operator
- Source statements of the form:
[label] [opcode] [operand]
[comment]
- 56 valid machine instruction mnemonics
- All valid addressing modes
- Equate Directive
- BYTE Directive to initialize memory locations
- WORD Directive to initialize 16-bit words
- PAGE Directive to control source listing
- SKIP Directive to control source listing
- OPT Directive to set select options
- LINK Directive to chain multiple text files
- Comments
- Source listing with object code and source statements
- Sorted symbol table listing

CONFIGURATION

Apple II	48K/Disk	\$69.95
----------	----------	---------

PROGRAMMA

Software Products

NEW HEALTH INTEREST PROGRAMS...

VitaFacts™ by Speakeasy™

**TRS-80
APPLE**

and others soon

- Heart Attacks
- Blood Pressure
- Adolescence
- Teenage Drinking & Drugs
- Birth Control
- Talking About Sex

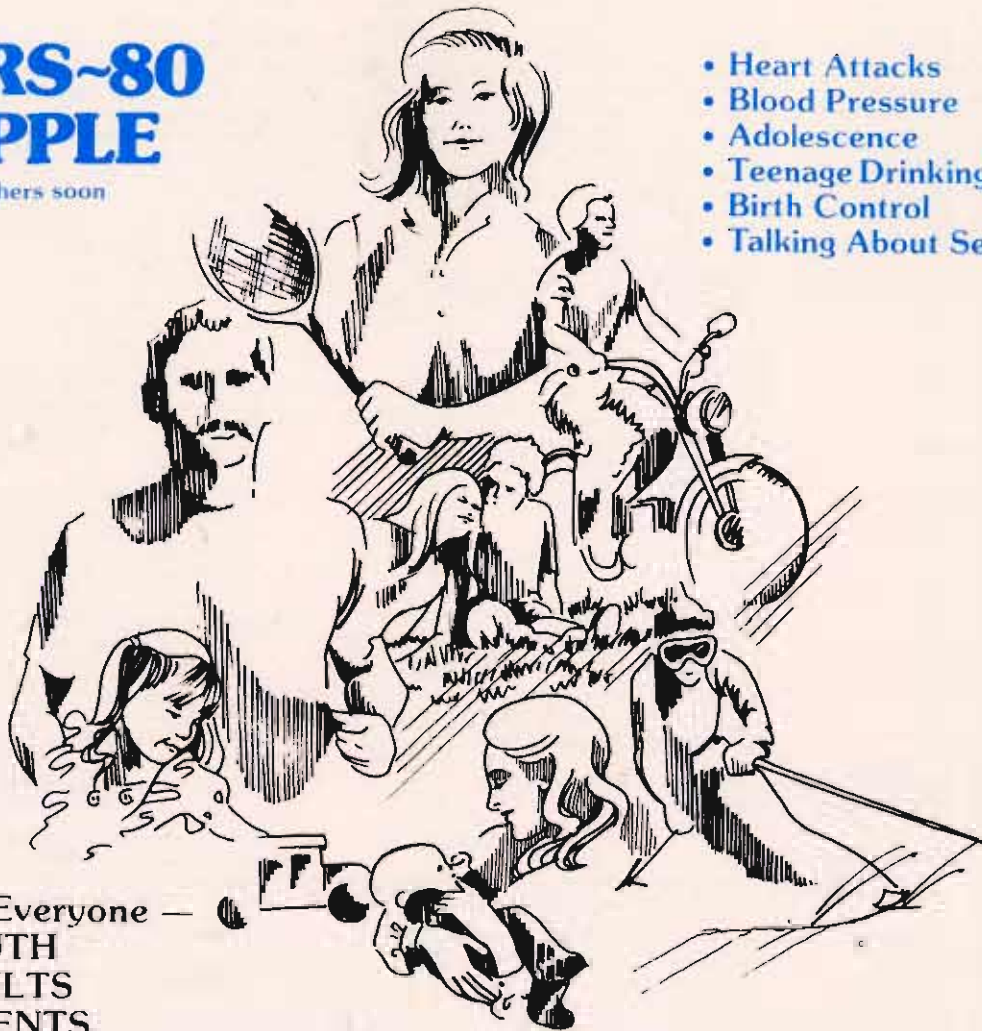

For Everyone —
**YOUTH
ADULTS
PARENTS**

Speakeasy VitaFacts programs contain up-to-date factual medical information presented in layman's terms about important aspects of your life and health needs. By participating you gain:

- improved knowledge of medical situations, contributing to an improved lifestyle, better family communication and cooperation and better health.
- awareness and appreciation of modern life's stressful situations and how to cope with them.
- a better understanding of family or friends' health problems.
- a heightened sense of the joy of learning.

Help yourself — your family — your friends to better health with the new Speakeasy VitaFacts Series learning programs!

These professionally-prepared programs include an audio cassette, a computer cassette and a booklet. They are available through hundreds of computer stores worldwide at very reasonable prices. Please check with your dealer or contact Speakeasy VitaFacts.

DEALERS: Please call us at the number below for the name of your distributor.

**MICROCOMPUTER-ASSISTED INSTRUCTION
FOR HEALTHFUL LIVING!**

VitaFacts™ by Speakeasy™

Box 909 Kemptville, Ontario, Canada K0G 1J0

(613) 258-3291