

Application Note 100



Application Note 100

Acoustics Handbook



HEWLETT-PACKARD GMBH, 703 BÖBLINGEN,
HERRENBERGER STR. 110, WEST GERMANY

HEWLETT-PACKARD COMPANY, 1501 PAGE
MILL ROAD, PALO ALTO, CALIFORNIA, USA

NOVEMBER 68

TABLE OF CONTENTS

	Page
SECTION I INTRODUCTION	
A World of Sound	7
What is Sound?	7
Why Measure Sound?	7
SECTION II PHYSICAL ACOUSTICS	
Sound Fields	11
Quantities and Definitions	11
a. Sound Pressure and Sound Pressure Level	11
b. Particle Velocity and Acoustic Impedance	12
c. Sound Intensity	12
SECTION III PHYSIO-PSYCHOLOGICAL ACOUSTICS	
The Idiosyncracies of Hearing	17
Loudness Level	17
Loudness	17
Loudness - a Function of Frequency	19
Loudness - a Function of Bandwidth	20
Subjective Pitch	22
Loudness - a Function of Proximity	23
Loudness Density	23
Masking	24
Loudness of Impulses	25
SECTION IV SURVEY OF MEASUREMENT METHODS	
Sound Level Measurements	29
Stevens' Procedure for Calculating Loudness	30
Zwicker's Procedure for Calculating Loudness	33
Kryter's Procedure for Evaluating Annoyance	34
Noise Rating Numbers	37
SECTION V INSTRUMENTATION FOR ACOUSTIC MEASUREMENTS	
MICROPHONES	43
A. TYPES OF MICROPHONES	43
1. Ceramic Microphone	43
2. High-Frequency Condenser Microphone	44
3. Condenser Microphone	44
B. CALIBRATION OF MICROPHONES	45
1. Reciprocity Calibration	45
a. Free-Field Calibration	45
b. Pressure Calibration	48
c. Differences Between Free-Field and Pressure Sensitivity	49
d. Diffuse-Field Calibration	50
2. Calibration by Substitution	51
3. Pistonphone	51
4. Electrostatic Actuator	51

SECTION V
(cont'd)

	Page
C. SOUND MEASUREMENT WITH CONDENSER MICROPHONES	57
1. Selection of a Microphone	57
2. Placement and Orientation of the Microphone	57
3. Interference	58
a. The Microphone	58
b. Supporting Structure and Instrumentation	58
4. Measurement Accuracy	59
a. Equipment Set-up	59
b. Microphone Correction Factor	59
c. Frequency Response	61
d. Type of Field and Orientation	61
e. Absence of the Observer	61
f. Overall Accuracy	63
 SOUND LEVEL METERS	
A. FREQUENCY RESPONSE	63
B. RMS DETECTION	72
C. DYNAMIC CHARACTERISTICS	76
D. OVERLOAD INDICATION	80
E. MEASUREMENTS WITH THE SOUND LEVEL METER	81
LEVEL RECORDER	83
FILTERS	85
FREQUENCY ANALYSIS	90
A. MANUAL SYSTEMS	90
B. AUTOMATIC SYSTEMS	91
1. Loudness Analysis	92
2. Spectrum Analysis	98
 APPENDIXES	
A. Table for Converting Loudness in Phons to Loudness Level in Sones	105
B. Preferred Frequencies for Acoustic Measurements	106
C. Addition and Subtraction of Levels in dB	107
D. Acoustics Terminology in Five Languages	108
E. International and US Standards	116

SECTION I
Introduction



A World of Sound

From the shriek of the alarm clock until the final curtain of the last TV show, ours is a world of sound. Indeed, we encounter sound on the streets and highways, at the office, and in the home. Our world of sound includes the throaty roar of the heavy diesel truck, belching black smoke as it labors up a hill, the mosquito-like whine of a motor bike, and the irrepressible clatter of the street repairman's air hammer. At the office we have the ring of the telephone, the staccato of typewriters, the buzz of the intercom. A machine shop provides an even wider variety of sounds: the blow of a punch press, the shrill cry of the drill press, the heavy twang of the sheet-metal shearer, and the lower-pitched grumble of the folding machine. At home, sound enables us to talk with friends and neighbors and to enjoy radio and TV. Our world is indeed a world of sound.

But what is sound? And why measure it? Let's take a little closer look.

What is Sound?

Strictly speaking, sound is an undulatory motion of air or other elastic medium, which can produce the sensation of hearing when incident upon the ear. Note that sound requires a medium for propagation; unlike electromagnetic waves, sound cannot travel through a vacuum. Thus sound at a particular point is a rapid variation in the pressure of the medium at that point around a steady-state value. In air, the steady-state pressure is atmospheric pressure. Of course, the average atmospheric pressure changes, but this change is slow enough to be considered constant compared to the rapid pressure variations of sound.

Sound is either useful or useless. Useful sound carries information which is essential or simply pleasing to us. Speech and music are two examples; the sound of an automobile horn is another. Useless sound we call noise. It carries no information, instead it tends to interfere with our ability to receive and interpret useful sound. In many cases it is difficult to decide whether a sound is information or noise. Often it is both. For example, the sound of a machine can be considered an information-carrying sound because it tells the operator whether or not his machine is functioning properly. But for his neighbor, who is operating another machine, this sound is noise — it carries no useful information.

Why Measure Sound?

Regardless of our business or profession, sound is usually involved in one way or another. Whether designing gears or office buildings, alarms or public address systems, we strive to maximize the transfer of information (or optimize the environment for such transfer) while minimizing disturbance from noise. To do so we must know the effect of various kinds of noise and establish appropriate limits and standards. But to establish appropriate evaluation techniques and to set standards, we must be able to measure sound. The purpose of this handbook is to familiarize you with some of the measurement techniques and instrumentation available today.

Before dealing directly with sound measurement, it would be well to become more familiar with physical and physiological aspects of acoustics. This we do in the

following two sections. Section IV covers measurement methods, and Section V describes acoustic instrumentation.

Vibration is closely akin to sound in that both are undulatory motions. However, we are concerned here with the complicated subjective reaction of the human hearing mechanism. Since this reaction has no bearing on the measurement of vibrations, this subject is not treated here.

SECTION II
Physical Acoustics



Sound Fields

As noted in Section I, sound is an undulatory motion in an elastic medium which can produce the sensation of hearing. While the word "medium" is used in its general sense in the above definition, we shall henceforth restrict the discussion to sound in air.

Sound in its environment can be thought of as a field, just as electromagnetic waves are fields. Three common types of sound fields are the plane sound field, the spherical sound field, and the diffuse sound field.

Sound in a homogeneous space propagates outward from a source in all directions and consequently forms a spherical field. In a spherical field, the sound pressure decreases with the square of the distance from the source.

When a microphone is relatively far away from a source, the sound field may appear to be a plane field, in which the sound pressure is constant in any plane perpendicular to the direction of propagation.

If sound is generated in a room, sound waves are reflected from the walls, and a directional sound field can only be found very close to the source. Further from the source, sound approaches any point uniformly and randomly from all directions. Thus the sound field is diffuse. Such a field would be found in a factory if the nearest machine were not too close.

It is often important to know whether the sound field in an area is approximately plane or diffuse. If it is plane, directional microphones can be used with advantage to measure it; if it is diffuse, omnidirectional microphones are needed. Often a field will be partly plane and partly diffuse. In a factory, for example, a machinist is in the directional sound field of his own machine but in the diffuse sound field of noisy machines in the distance.

The transition from a directional sound field to a diffuse sound field in a room is characterized by a critical radius, which can be estimated as follows:

$$r_G = 0.14 \sqrt{\bar{a}A}$$

where \bar{a} is the absorption coefficient of the walls and A is the surface area of the walls, floor, and ceiling. In an average factory \bar{a} is between 0.05 and 0.2. In normal rooms \bar{a} is between 0.1 and 0.3. The change from a directional or plane field to a diffuse field can be considered to occur at a distance r_G from the sound source.

In loudness measurements, two types of fields are usually considered. One is the diffuse field. The other is a plane sound field which approaches the hearer from the front, head on; this field is called a frontal sound field.

Uni-directional sound fields are also called free fields.

Quantities and Definitions

a. Sound Pressure and Sound Pressure Level.

Sound at a particular point in air is the rapid variation in the air pressure around a steady-state value. This sound pressure is measured in the same units as atmo-

spheric pressure, and since it is an alternating quantity, the term "sound pressure" usually refers to its rms value.

At a frequency of 1 kHz, a sound with an rms pressure of $2 \times 10^{-4} \mu\text{bar}^1$, or about 2×10^{-10} atmosphere, is just below the threshold of hearing for good ears, that is, a sound of this magnitude is inaudible, but slightly larger sound pressures can barely be heard. This demonstrates the amazing sensitivity of the human ear — it can detect variations in atmospheric pressure as small as a few parts in 10^{10} .

Another of the remarkable properties of the human ear is its large dynamic range. At 1 kHz, it can hear sounds as small as about $2 \times 10^{-4} \mu\text{bar}$, and at the other end of the sound-pressure scale, it can accommodate sound pressures as high as 200 μbar without becoming overloaded. Bigger sounds, say 2,000 μbar , are physically painful.

Because the dynamic range of the ear is so large, it is common practice to use a logarithmic scale for sound pressure. A reference value of $2 \times 10^{-4} \mu\text{bar}$, approximately the threshold of hearing at 1 kHz, has been agreed upon. Rms sound pressure is commonly expressed in dB above $2 \times 10^{-4} \mu\text{bar}$ and referred to as sound pressure level. Mathematically, if p is rms sound pressure and L is sound pressure level, then

$$L = 20 \log_{10} \frac{p}{p_0} \text{ dB}$$

where $p_0 = 2 \times 10^{-4} \mu\text{bar}$.

Sound pressure and sound pressure level are analogous to voltage and voltage level in the field of electricity.

b. Particle Velocity and Acoustic Impedance.

Particle velocity in a sound wave is the velocity of a given infinitesimal part of the medium, with respect to the medium as a whole, caused by the passage of a sound wave. Here again the rms value is generally used, and the units are meters per second. In any given medium, particle velocity is proportional to the sound pressure. The relationship between particle velocity and sound pressure in air is shown in Table 1. Particle velocity is analogous to electrical current.

Acoustic impedance of a sound medium is the complex quotient of the sound pressure and the particle velocity multiplied by the unit of area (square centimeter, square meter, etc). The surface of the unit area must lie on the sound wave front, i. e. the surface of the area is at all points perpendicular to the direction of sound propagation. Mathematically,

$$Z = \frac{p}{vS}$$

where p is sound pressure, v is particle velocity and S is the unit area. The unit of acoustic impedance is the acoustic ohm (100 N s/m^5 or 1 dyne s/cm^5).

c. Sound Intensity.

Sound intensity, analogous to electrical power, is the rate at which acoustic energy

¹ One μbar equals one dyne per square centimeter or 0.1 newtons per square meter. A human speaker at a distance of one meter generates a sound pressure of about one μbar .

flows through a unit area normal to the direction of propagation. It is the product of sound pressure and particle velocity. Expressed mathematically, intensity I is

$$I = pv$$

where p is sound pressure and v is particle velocity. Typical values of sound intensity are included in Table 1.

So far we have been dealing with purely physical quantities, i. e. quantities easy to measure or derive. However, as we shall see in the next section, the relationship between these quantities and the sensation of hearing is anything but simple and straightforward.

	Sound Pressure p (μbar) (N/m ²)		Intensity I (W/m ²)	Particle velocity v (m/s)	Sound pressure level L (dB)
Above threshold of pain	2000	200	100	5×10^{-1}	140
	200	20	1	5×10^{-2}	120
	20	2	10^{-2}	5×10^{-3}	100
	2	2×10^{-1}	10^{-4}	5×10^{-4}	80
	2×10^{-1}	2×10^{-2}	10^{-6}	5×10^{-5}	60
	2×10^{-2}	2×10^{-3}	10^{-8}	5×10^{-6}	40
	2×10^{-3}	2×10^{-4}	10^{-10}	5×10^{-7}	20
Reference point (approximately the threshold of hearing)	2×10^{-4}	2×10^{-5}	10^{-12}	5×10^{-8}	0

Table 1. Representative quantities in air

SECTION III
Physio-Psychological
Acoustics



The Idiosyncracies of Hearing

Unfortunately for those trying to measure and evaluate sound objectively in terms of the sensation experienced by humans, this sensation seems to involve complicated physiological and psychological mechanisms. A good loudness meter would have to imitate many unique properties of the human ear. These properties have been investigated extensively by a great number of scientists. However, we still do not have a very good understanding of the physiological processes underlying many of them; our knowledge of these properties is only empirical. We still can't make a complete model of the ear. Nevertheless, we have learned to make fairly accurate models of the loudness-sensing function of the ear. For example, we know that the sensation of loudness is a function of frequency, bandwidth, and the proximity of sounds in terms of frequency.

Loudness evaluation, then, is several orders of magnitude more complex than measuring the purely physical quantities defined in section II. The purpose of this section is to give you some insight into these complexities.

Loudness Level

Since loudness is a subjective quantity, the primary instrument for measuring it can only be a human observer. To determine whether one sound is louder, equally loud, or less loud than another, we would have to let a statistically significant number of people compare the sounds and then average their opinions. Similarly, to determine how loud a sound is, we would have to choose a standard sound and have a significant number of people compare the unknown with the standard.

In acoustics the accepted standard is a pure 1 kHz tone or narrow-band noise centered at 1 kHz. The loudness level of any sound is defined as the sound pressure level of a standard sound which appears to a significant number of observers to be as loud as the unknown. Loudness level is measured in phons, the loudness level of any sound in phons being equal to the sound pressure level in dB of an equally loud standard sound. Thus a sound which is judged to be as loud as a 40 dB 1 kHz tone has a loudness level $L_s = 40$ phons.

Loudness

Although the logarithmic phon scale covers the large dynamic range of the ear (120 dB) conveniently, it does not fit a subjective loudness scale. A factor of two in loudness does not correspond to double the number of phons. Over most of the audible range, that is, for loudness levels of 40 phons and greater, the corresponding increment is 10 phons. This is an empirical fact; why loudness should be different from physical quantities like voltage, for which a factor of two corresponds to 6 dB, is not fully understood.

It is also difficult to add loudnesses in phons. If, for instance, we produce one tone at 200 Hz with a loudness level of 70 phons, and another at 4 kHz with the same loudness level, it would be convenient if both tones together would yield a loudness level of 140 phons. Unfortunately, this doesn't happen. The two tones actually are perceived as a loudness level of 80 phons.

In an effort to obtain a quantity proportional to the intensity of the loudness sensation, a loudness scale was defined in which the unit of loudness is called a

sones. One sone corresponds to a loudness level of 40 phons. For loudness levels of 40 phons or greater, the relationship between the numerical values of loudness level L_S (in phons) and loudness S (in 'sones) is given by

$$S = 2^{(L_S - 40) / 10} \quad (1)$$

(ISO Recommendation R 131).

Table 2 compares the loudnesses (sones) and loudness levels (phons) of several common sounds². Notice that the loudness scale in sones corresponds fairly closely to our subjective sensation of loudness. We feel, as a matter of experience, that a speaker in an auditorium speaks about four times as loudly as someone who talks quietly with us in normal conversation. It is more meaningful to state that a jet aircraft at takeoff is about 50 times as loud as our conversation than to state that the jet aircraft generates 120 phons in contrast to 60 phons generated in ordinary conversation.

² A table for converting phons to sones is given in Appendix A.

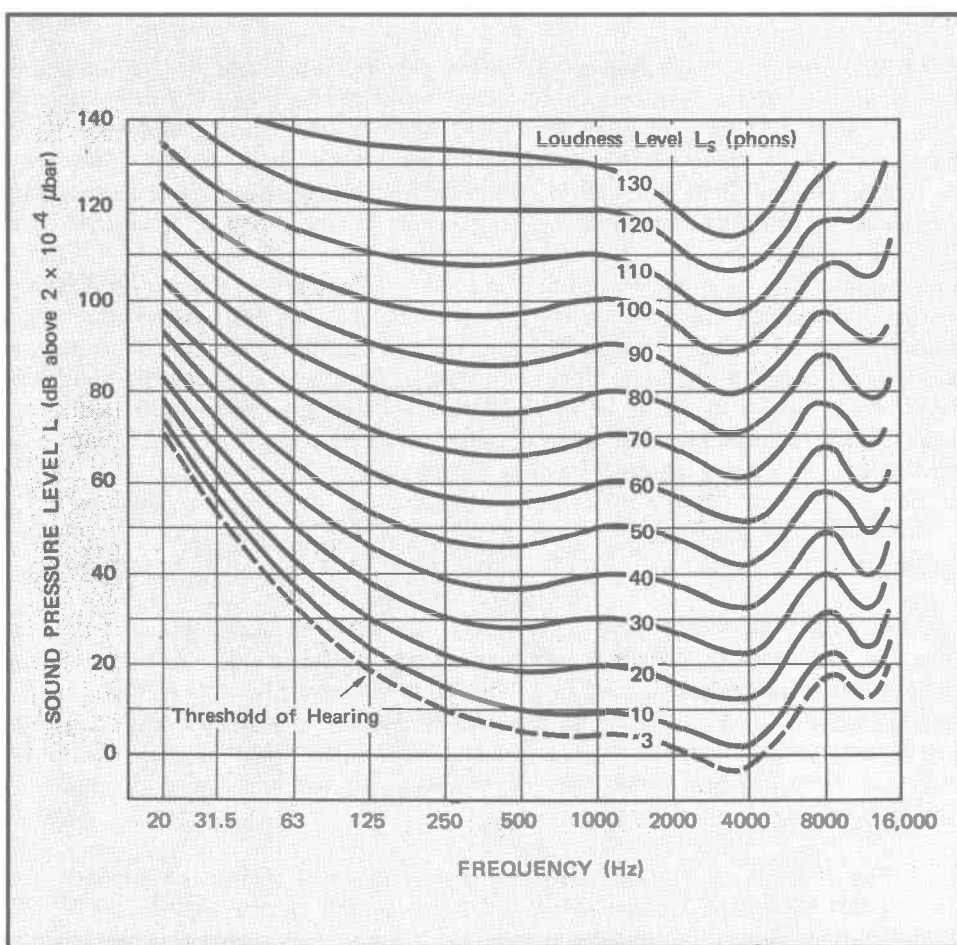

Figure 1. Curves of equal loudness level for pure tones in frontal sound field, according to ISO Recommendation 226. These curves show how frequency response of the human ear varies with loudness level.

Loudness Level (phons)		Loudness (sones)
140	Threshold of pain	1024
120	Jet aircraft	256
100	Truck	64
80	Orator	16
60	Low conversation	4
40	Quiet room	1
20	Rustling of leaves	
3	Hearing threshold	

Table 2. Representative values of loudness level and loudness

Loudness – a Function of Frequency

The loudness level of a 1 kHz tone is the same as its sound pressure level. This would also be true of pure tones of other frequencies if perception were constant with frequency. However, it is not. The loudness level of any other sound (in phons) is not, in general, equal to its sound pressure level (in dB). For example, if a large number of observers compare a 100 Hz tone with a 1 kHz tone, they will judge the two to be equally loud only when the 100 Hz tone has a higher sound pressure level than the 1 kHz tone. The frequency response of the ear is not flat.

Although the subjective sensation of loudness differs from person to person, normal ears seem to agree within a few dB, at least for the young, male subjects who have participated in most subjective tests. Hence it is possible to draw curves or contours of equal loudness level for normal ears, as shown in Figure 1.

Equal loudness level contours were first published in 1933 by Fletcher and Munson. The slightly modified form of their curves shown in Figure 1 is now universally accepted as reference data (ISO Recommendation 226).

The curves of Figure 1 are for pure tones in a frontal sound field. They show, for example, that a 40 phon 100 Hz tone has a sound pressure level of 50 dB, but an equally loud 40 phon 1 kHz tone has a sound pressure level of only 40 dB. The 3 phon curve is just above the threshold of hearing for normal ears.

Notice that the curves converge at low frequencies, but are approximately parallel between 1 and 10 kHz. This means that the ear's frequency response is a function not only of frequency but also of level. Therefore it can be simulated only with networks which are nonlinear with respect to both frequency and amplitude.

Curves of equal loudness level for a diffuse sound field can't be measured using pure tones because it is difficult to set up a diffuse field using pure tones. Pure tones are likely to bounce off walls and nearby objects and produce standing-wave patterns, whereas sound in a diffuse field is supposed to be uniform in all directions. However, diffuse-field loudness comparisons can be carried out with consistent results using frequency-modulated tones or narrow-band noise.

Differences in sound pressure levels necessary to give the same sensation of loudness in a diffuse field as in a plane field were standardized in ISO Recommendation 454. Using these differences (see Figure 2), curves of equal loudness level for the diffuse sound field can be calculated from those for the plane field.

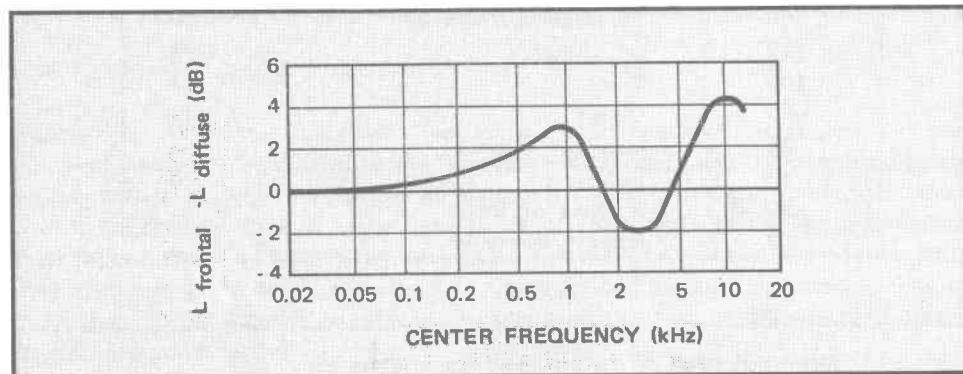

Figure 2. Difference between equal-loudness-level contours in frontal and diffuse sound fields, according to ISO Recommendation 454.

Loudness — a Function of Bandwidth

To human ears, broadband sounds, like those of jet aircraft, seem much louder than pure tones or narrow-band noise having the same sound pressure level. Figure 3 illustrates this effect for band-limited noise having a center frequency of 1 kHz.

Figure 3(a) is a series of sound intensity density spectra for bandwidths of 100 Hz, 160 Hz, and 200 Hz. All three spectra have the same area, so all three noises have the same sound intensity (sound power per unit area). This means that all three noises have the same sound pressure level. But all three noises are not equally loud.

If the loudness of the noise which has a 100 Hz bandwidth is S_0 , then the loudness of the noise which has a 160 Hz bandwidth is also S_0 . But the loudness of the noise which has a 200 Hz bandwidth is greater than S_0 .

Figure 3(b) shows what increasing bandwidth does to the loudness of noise having a center frequency of 1 kHz and a constant sound pressure level of 60 dB. Up to a critical bandwidth of 160 Hz, the subjective loudness is constant. Beyond that point, however, there is a marked increase in loudness. At a bandwidth of 2 kHz the loudness level L has increased from 60 phons to 74 phons. Loudness S has increased by a factor of 2.5.

Similar investigations, using different center frequencies, yield different critical bandwidths. At a center frequency of 200 Hz the critical bandwidth is approximately 100 Hz. At 5 kHz it is about 1 kHz.

We cannot account for the effect of bandwidth on loudness with any broadband measurement. Accurate loudness measurements can be made only by taking into account the spectral distributions of sounds being analysed. The necessary degree of resolution in the spectrum analysis is clear from Figure 3(b). We need no filter having a bandwidth narrower than a critical bandwidth, because for narrower bandwidths the spectral distribution of the sound doesn't influence loudness.

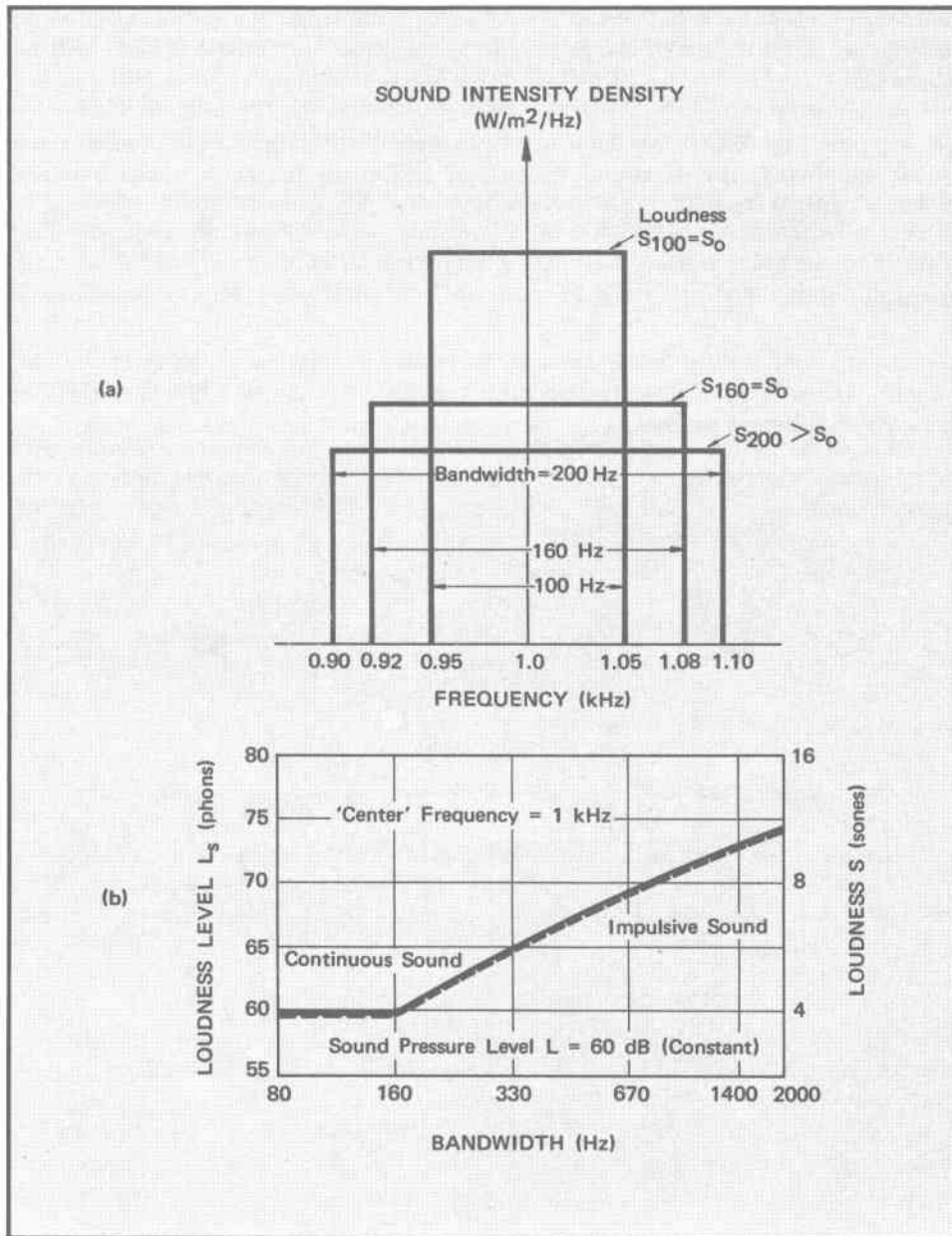

Figure 3. Effect of bandwidth on loudness is demonstrated by holding sound pressure level constant at 60 dB, keeping center frequency fixed at 1 kHz, and increasing bandwidth.

Figure 3. (a) As bandwidth increases, sound intensity density ($W/m^2/Hz$) must decrease to keep rms sound pressure constant. Area of each rectangle is sound intensity of corresponding sound, which is proportional to square of rms sound pressure. All rectangles have same area.

Figure 3. (b) As bandwidth increases, keeping sound pressure level constant as in (a), loudness level is not affected until bandwidth exceeds a critical value. Different center frequencies have different critical bandwidths. At 1 kHz, critical bandwidth is 160 Hz.

Conversely, no filter should have a bandwidth wider than the critical bandwidth corresponding to its center frequency; if it does, the measured loudness will be incorrect.

Twenty-four filters, each having a bandwidth equal to the empirically-determined critical bandwidth for its center frequency, will cover the audio range between 20 Hz and 15,500 Hz.

Subjective Pitch

The human ear's critical bands seem to be related to another property of the ear, namely, subjective pitch. Subjective pitch tells us how our ears compare the frequencies of different sounds.

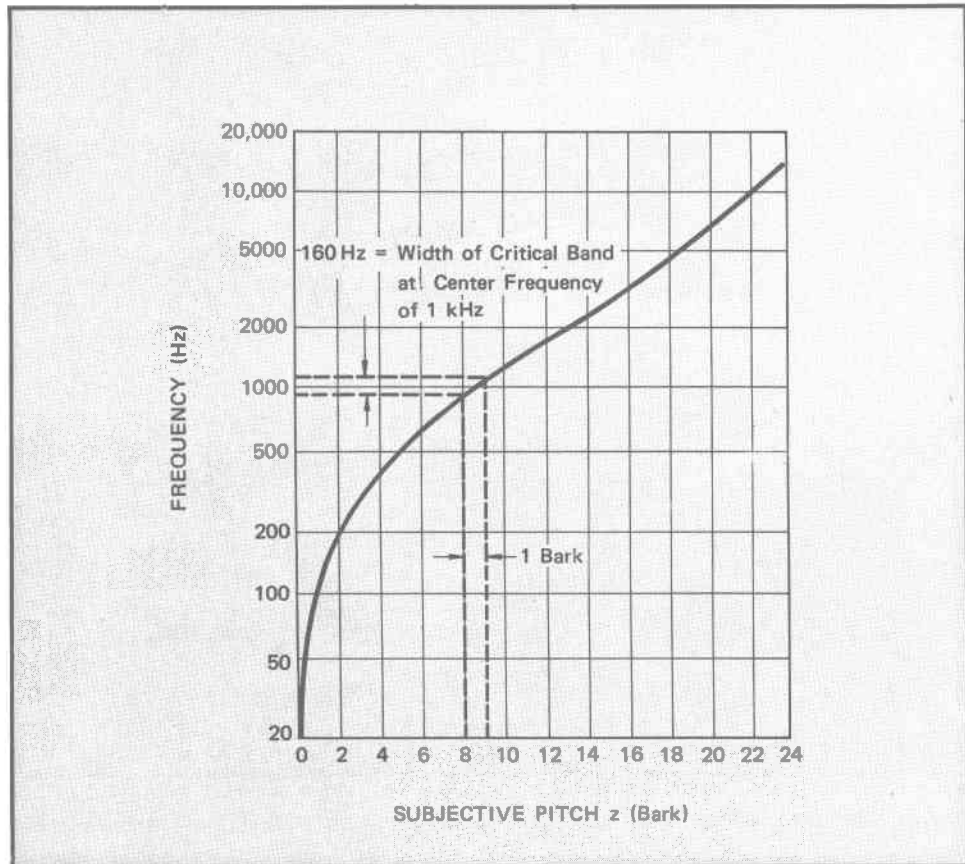

Figure 4. Subjective pitch scale versus frequency scale.

If an average untrained observer — not a musician or a piano tuner — were first allowed to listen to two tones, say a very-low-frequency tone and a 4 kHz tone, and then were asked to tune an oscillator until he heard a tone that fell exactly half way between the first two tones, he would not pick something around 2 kHz. Instead, he would pick a tone having a frequency of about 1 kHz. In subjective pitch, then, 1 kHz is halfway between 0 and 4 kHz. The unit of subjective pitch is the mel; 0 to 2400 mel span the frequency range 0 to 16 kHz.

Remarkably enough, it turns out that a subjective pitch interval of approximately 100 mel located anywhere in the audio range corresponds to the width of a critical band at that point! Probably, the same mechanism in the ear is responsible both for critical bands and for subjective pitch. However, our understanding of the ear is still not good enough to allow us to identify this mechanism.

In loudness measurements, the frequency scale most commonly used is linear in subjective pitch z . However, the mel is not used. Instead, the width of a critical band is defined as one Bark. Accordingly, the audio range comprises 24 Bark. Figure 4 shows how subjective pitch, in Bark, is related to frequency.

Loudness – a Function of Proximity

Two sounds presented to the ear simultaneously produce a sensation of loudness which is larger than that produced by either of them alone. Take for example a 200 Hz tone having a loudness level of 70 phons and a 4 kHz tone, also having a loudness of 70 phons. If two sounds are as widely separated in frequency as these two, their partial loudnesses simply add to form the total loudness. The loudness corresponding to a loudness level of 70 phons is 8 sones. If two partial loudnesses of 8 sones each occur simultaneously the total loudness is 16 sones, and the loudness level is 80 phons.

This simple summation of partial loudnesses can only be carried out if the individual sounds are separated widely in frequency. The closer they are in frequency the more they influence each other, and total loudness may not be quite so large as the sum of the partial loudnesses. This effect is called partial masking. In the extreme case, partial masking becomes total masking, wherein a strong sound renders a lower-level sound completely inaudible. When total masking occurs, low-level sound components cannot be heard at all and do not contribute to loudness.

The partial masking of tones cannot be understood in terms of level and frequency because pure tones represented by spectral lines cannot influence each other. Investigations on the ear have shown, however, that even pure tones or narrow-band noise excite nerves in the ear that correspond to a wide range of frequencies. Masking occurs because the ear treats sounds in an "OR" fashion – when two sounds excite the same nerves, the ear hears only the larger sound in that frequency range.

Loudness Density

The manner in which pure tones or narrow-band sounds excite nerves in the ear corresponding to many frequencies can be expressed quantitatively in terms of a parameter called loudness density. Loudness density is defined as a function of subjective pitch; when loudness density is integrated over subjective pitch, the result is total loudness. If integration over subjective pitch is to yield total loudness, then loudness density must be the differential quotient of loudness S over subjective pitch z , i. e. dS/dz .

Loudness density dS/dz has the dimensions of sones_G per Bark. The subscript G indicates that this loudness is calculated in terms of critical bands, not subjectively measured.

Loudness density versus subjective pitch for a 1 kHz tone at a sound level of 77 dB is shown in Figure 5 as a dashed curve. This function has been established in many masking experiments. The area under the curve, that is

$$S = \int_{z=0}^{z=24 \text{ Bark}} \frac{dS}{dz} dz$$

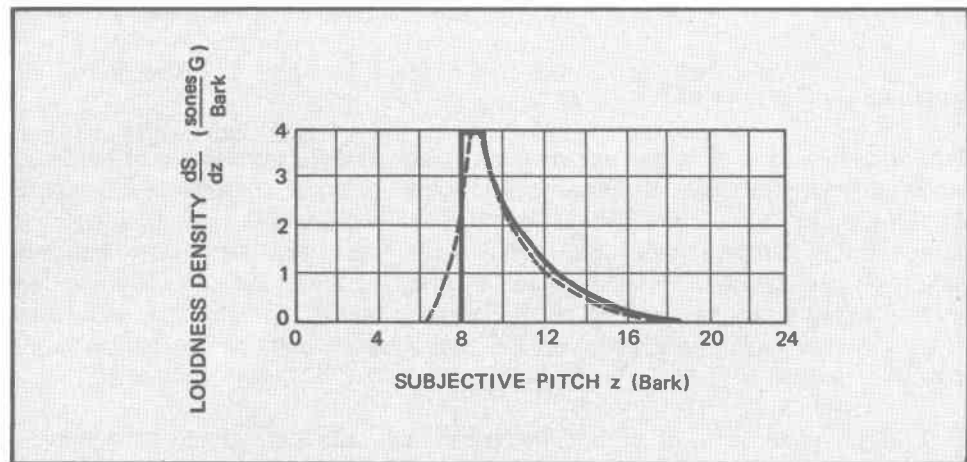

Figure 5. Masking curve (dashed line) for a pure 1 kHz tone which has a loudness of 13 sones_G. The solid curve is an approximation which has been found to give good results in loudness measurements. The area under each curve is 13 sones_G.

is 13 sones_G. This was to be expected because according to equation (1), 77 phons corresponds to 13 sones.

For most applications, especially for calculating loudness, it is sufficient to approximate the dashed curve by the solid curve shown in Figure 5.

The horizontal portion at the top of the solid curve has a width of 1 Bark. The height of this horizontal portion can be called the band loudness density. Band loudness densities and the shapes of the tails of the approximate curves have been determined empirically for various sound pressure levels and frequency bands.

Masking

Mutual partial masking of two tones can be represented and explained very effectively in terms of loudness density. The three examples in Figure 6 show the loudness density function of two 77-phon tones in different relationships. In Figure 6(a) the distance between the tones is larger than 10 critical bands. In Figure 6(b) it is larger than two critical bands, and in Figure 6(c) it is less than one critical band. In the first case, total loudness is the sum of the individual loudnesses, that is, 26 sones_G. When the loudness density curves overlap, as in Figure 6(b), we get a total area which is smaller than the sum of the individual areas. This is partial masking. In our example, the two sounds now have a loudness of only about 19 sones_G.

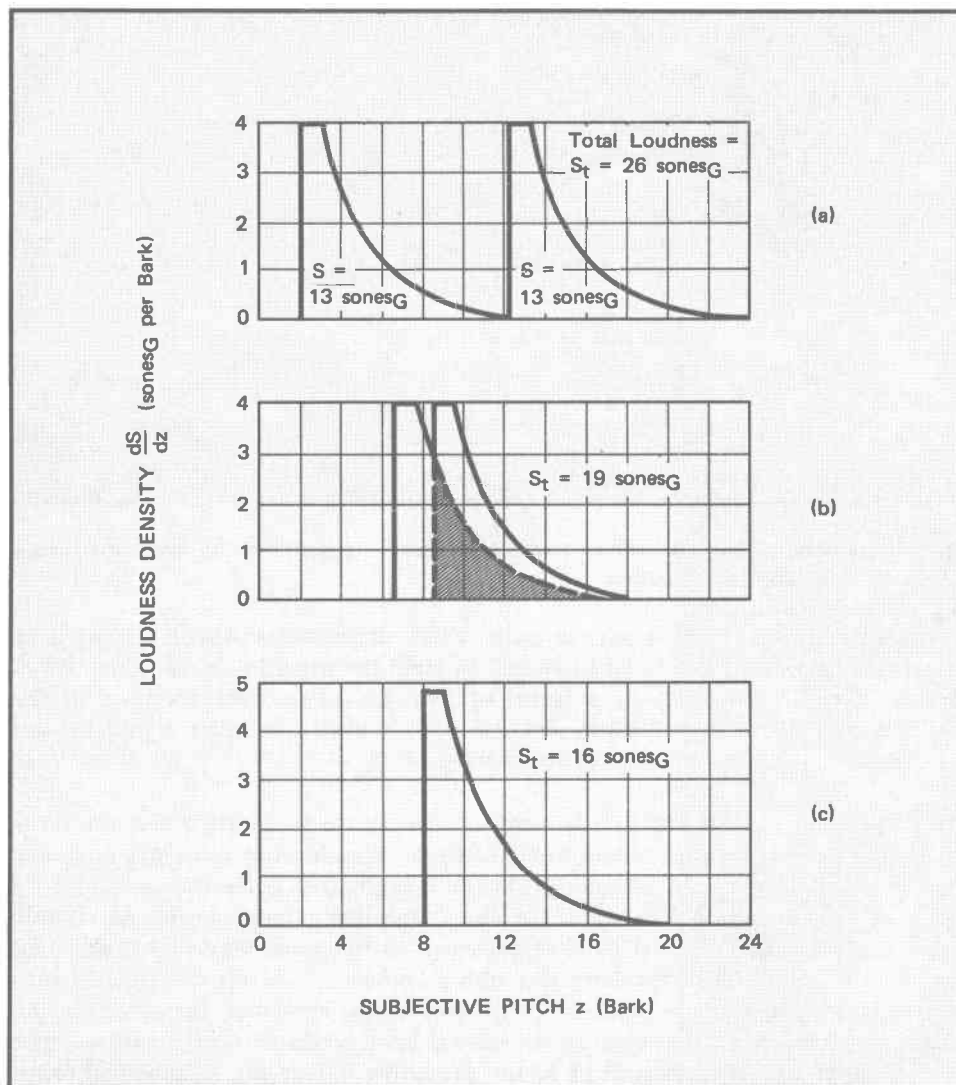

Figure 6. Effect of masking when two sounds are widely spaced in frequency (a), when their masking curves overlap (b), and when both sounds fall in the same critical band but are incoherent (c).

When both tones fall into the same critical band, Figures 6(c), and yet are of different frequencies, the sound pressure level in that band increases by 3 dB to 80 dB. The area under the loudness density curve increases by an amount which corresponds to an increase in loudness level by 3 phons, that is, by roughly 20%. Thus the total loudness is only 16 sones_G.

Loudness of Impulses

The sounds heard in everyday life are not all uniform. Many, like bangs and rattling sounds, change rapidly with time. The dependence of the loudness of a sound on its duration can be represented by a curve of equal loudness as a function of pulse width (Figure 7). Subjective measurements have yielded similar results for short bursts of pure tones (dotted line in Figure 7) and for short bursts of broadband noise (solid line in Figure 7). Loudness is independent of duration for

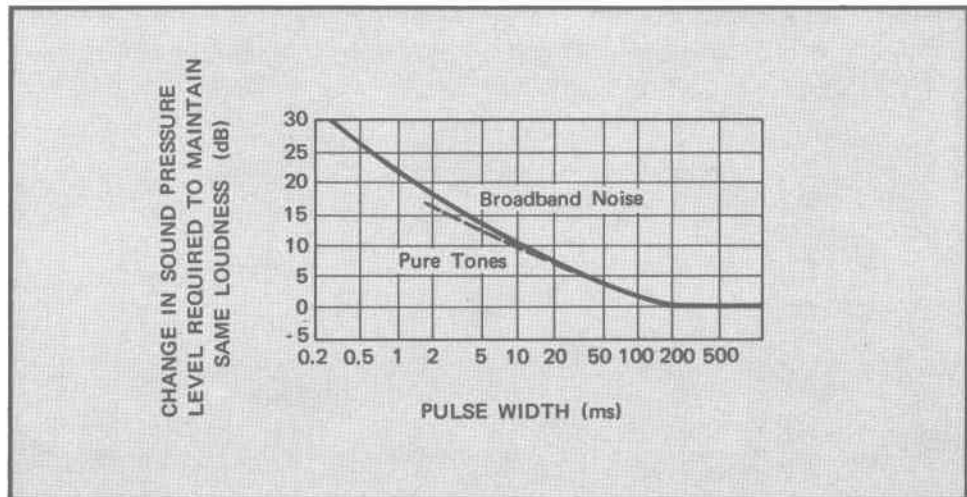

Figure 7. As duration (pulse width) of a sound decreases, its sound pressure level must increase to maintain same loudness.

large pulse widths. Only when the pulse width drops below about 100 ms does the level of a pulse have to be increased to yield the same loudness. Then, when the pulse width decreases by a factor of two, the sound pressure level of the impulse must increase by 3 dB to give the same loudness. In other words, the ear appears to have a time constant of about 100 ms³.

The dependence of loudness on bandwidth was shown in Figure 3. But are these laws also valid for short sounds, i. e., for sound impulses? It turns out that they are. The dashed curve in Figure 3(b) is for band-limited noise impulses of 5 ms duration. The loudness level of these short impulses increases with bandwidth once the width of a critical band is exceeded in the same way that it does for continuous sound. Thus the laws describing loudness in terms of critical bands and loudness density are valid for impulsive noise. However, for arbitrary impulses and time-dependent sounds, the critical-band levels must be measured with the temporal weighting described in the preceding paragraph. In practical terms this means that the band levels should be measured with rms detectors having integration times of about 100 ms.

³ The test method affects the measured value of the ear's time constant. The total spread is about 3 to 1 from about 35 to 100 milliseconds.

SECTION IV
Survey of Measurement
Methods



Sound Level Measurements

The first attempt at measuring loudness was made quite some time ago in the form of the sound level meter. In this instrument, sound pressure is transformed into voltage by a microphone, a weighting network shapes the voltage to account for the frequency response of the ear, and a quasi-rms voltmeter with a logarithmic scale indicates the weighted sound pressure level.

Until recently, sound level meters had three possible weighting curves. These are called A, B, and C and are specified in IEC Recommendations 123 and 179 and in US Standard S 1.4-1961. Measurement results are given in dB (A), dB (B), or dB (C).

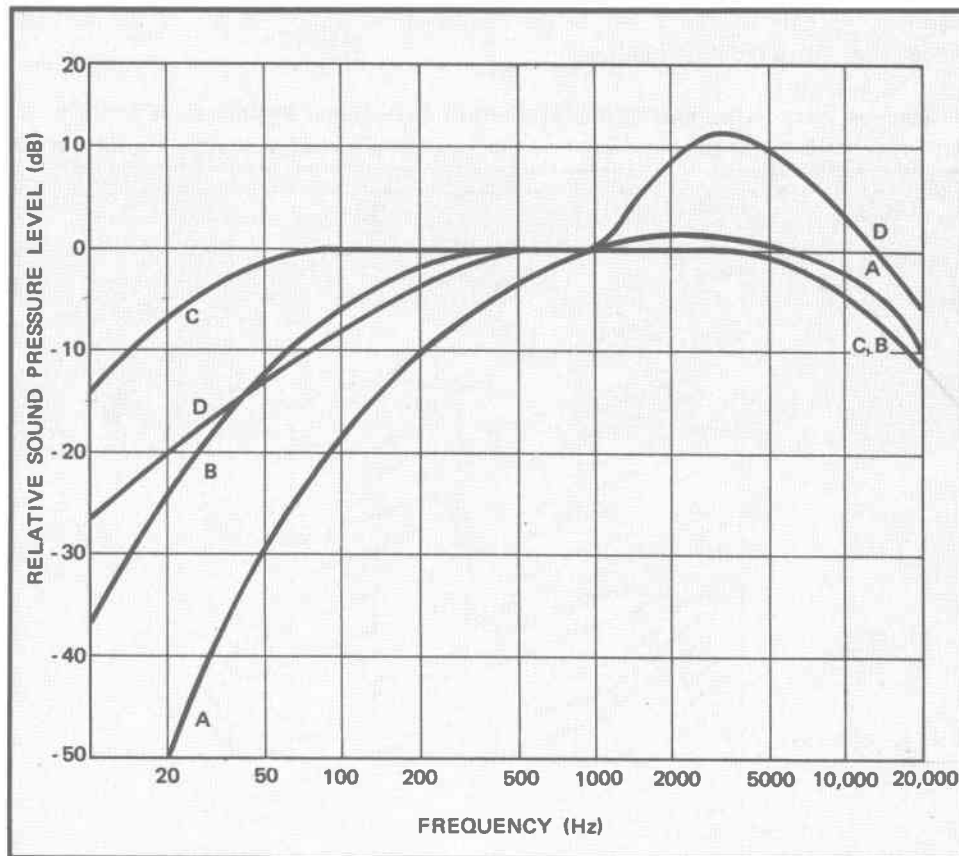

Figure 8. International standard A, B, and C weighting curves for sound level meters. Also shown is the proposed D weighting curve for monitoring jet aircraft noise.

Recently, a new weighting curve, the D curve, has been proposed for measuring jet aircraft noise. The D curve seems to be gaining some support among acoustics experts and at this point is being considered by the IEC committee. Figure 8 shows the four weighting curves.

Sound level meters have the advantage of simplicity, but begin to give us problems when we expose them to more than one tone at a time. As we have seen, one broadband network cannot weight a high-level low-frequency tone and a low-level high-frequency tone properly at the same time. In one typical case, for example,

a sound level meter gave a reading of 110 dB (A) for a 1 kHz tone, and the same reading for a broadband signal consisting of an unsymmetrical square wave plus a sine wave. The actual loudnesses, computed by the more accurate Zwicker method (described later in this section), were 128 sones_G for the pure tone and 340 sones_G for the broadband signal. Corresponding loudness levels are 110 phons_G and 124 phons_G respectively. The difference of 14 phons_G represents an error in the dB (A) reading. Sound level meters are also unable to account for masking and, with the exception of the HP 8052A and 8062A Impulse Sound Level Meters, are not useful for measuring the loudness of impulsive sounds.

Stevens' Procedure for Calculating Loudness

Addition of partial loudnesses is the fundamental notion in all of the known procedures for calculating loudness.

In Stevens' procedure, partial loudnesses are determined by means of families of curves (Figure 9) from sound levels which are measured in octave, 1/2-octave, or

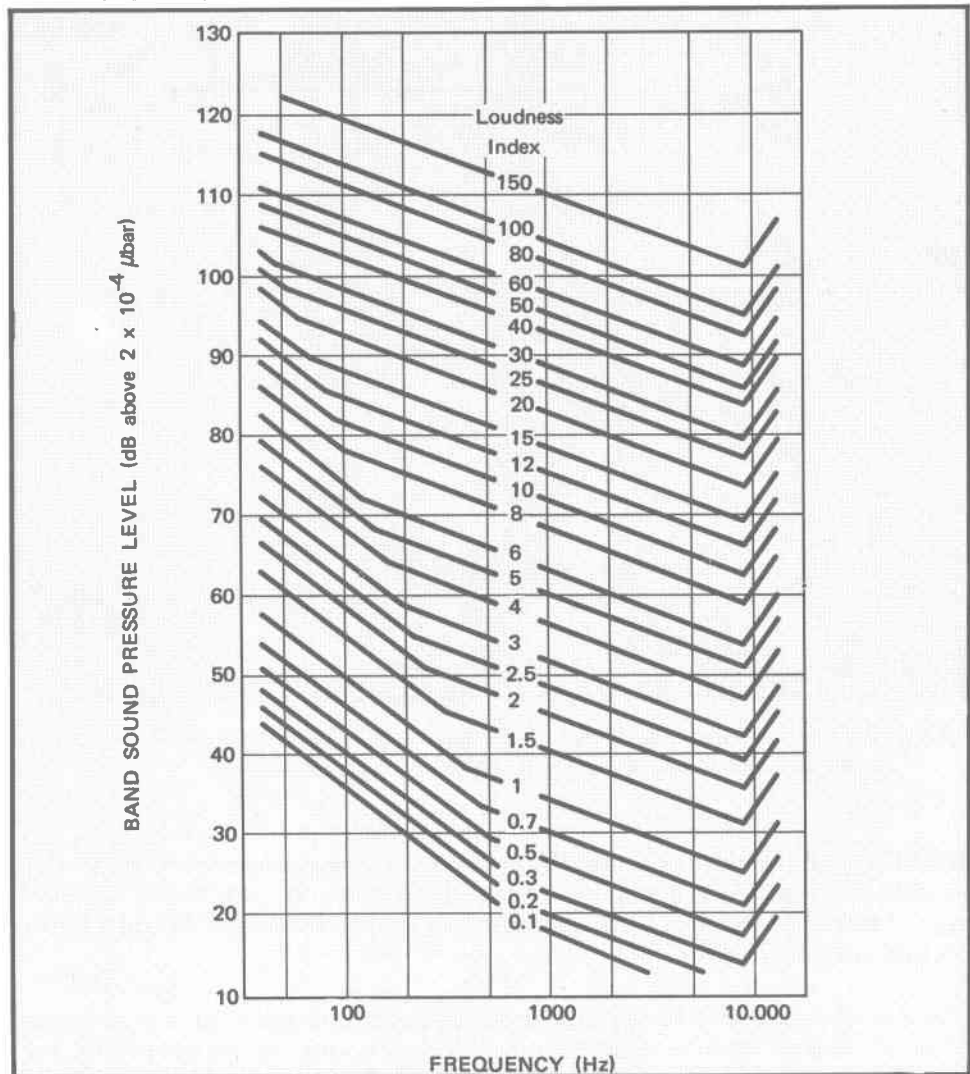

Figure 9. Curves for determining loudness indexes used in Stevens' method of calculating loudness.

$1/3$ -octave frequency bands. These partial loudnesses are called indexes. Partial masking is taken into account very generally by multiplying all loudness indexes, except the one with the largest number, by a factor smaller than 1. The partial loudnesses produced in such a way are added to the largest partial loudness to give total loudness. Total loudness is given by the formula:

$$S = s_m + F (\Sigma s - s_m)$$

where s_m is the maximum loudness index and Σs is the sum of all loudness indexes. F is the factor which takes masking into account. Its value is 0.3 for octave, 0.2 for $1/2$ -octave, and 0.15 for $1/3$ -octave frequency bands.

The family of curves in Figure 9 was derived from Table 3 following these rules:

1. The value of the loudness index is constant on a contour having a slope of -3 dB/octave except as modified by rules 2 and 3.
2. Above 9 kHz, all contours have a slope of $+12$ dB/octave.
3. Below a certain frequency, each contour has a slope of -6 dB/octave; the frequency at which the slope changes lies on a line which has a slope of -21 dB/octave and passes through the point determined by 1 kHz and 10 dB band pressure level. Stevens' procedure is standardized in ISO R 532, Method A.

Table 3. Loudness index at 1 kHz.

Band pressure level dB	Loudness index	Band pressure level dB	Loudness index	Band pressure level dB	Loudness index
15		50	2.68	85	23.0
16		51	2.84	86	24.7
17		52	3.0	87	26.5
18	0.10	53	3.2	88	28.5
19	0.14	54	3.4	89	30.5
20	0.18	55	3.6	90	33.0
21	0.22	56	3.8	91	35.3
22	0.26	57	4.1	92	38.0
23	0.30	58	4.3	93	41.0
24	0.35	59	4.6	94	44.0
25	0.40	60	4.9	95	48
26	0.45	61	5.2	96	52
27	0.50	62	5.5	97	56
28	0.55	63	5.8	98	61
29	0.61	64	6.2	99	66
30	0.67	65	6.6	100	71
31	0.73	66	7.0	101	77
32	0.80	67	7.4	102	83
33	0.87	68	7.8	103	90
34	0.94	69	8.3	104	97
35	1.02	70	8.8	105	105
36	1.10	71	9.3	106	113
37	1.18	72	9.9	107	121
38	1.27	73	10.5	108	130
39	1.35	74	11.1	109	139
40	1.44	75	11.8	110	149
41	1.54	76	12.6	111	160
42	1.64	77	13.5	112	171
43	1.75	78	14.4	113	184
44	1.87	79	15.3	114	197
45	1.99	80	16.4	115	211
46	2.11	81	17.5	116	226
47	2.24	82	18.7	117	242
48	2.38	83	20.0	118	260
49	2.53	84	21.4	119	278
				120	298

Zwicker's Procedure for Calculating Loudness

In Zwicker's procedure (ISO R 532, Method B), the frequency range between 45 Hz and 14 kHz is divided into bands which approximate critical bands. Filters are used to break the sound into its components, and the sound pressure level in each band is measured. The partial loudnesses are then plotted on a diagram which automatically accounts for partial masking (Figure 10).

Because filters with the widths of critical bands are not normally available, the procedure has been modified to use $1/3$ -octave filters. Practically speaking, this doesn't introduce any inaccuracy into the results. Subjective measurements often disagree with each other by $\pm 20\%$ or more, and this is much greater than the amount by which $1/3$ -octave analyses differ from critical-band analyses. Actually, between 280 Hz and 14 kHz, the widths of critical bands are quite close to $1/3$ octaves.

Below 280 Hz, ISO R 532 requires that sounds be grouped into two octave-wide bands and one $2/3$ -octave band. Thus the audio range is spanned by 20 filters, two having octave bandwidths, one having $2/3$ -octave bandwidth, and 17 having $1/3$ -octave bandwidths. The differences in band loudness densities which result from using $1/3$ -octave filters instead of critical-band filters are taken into account by small changes in the scales on the Zwicker diagram.

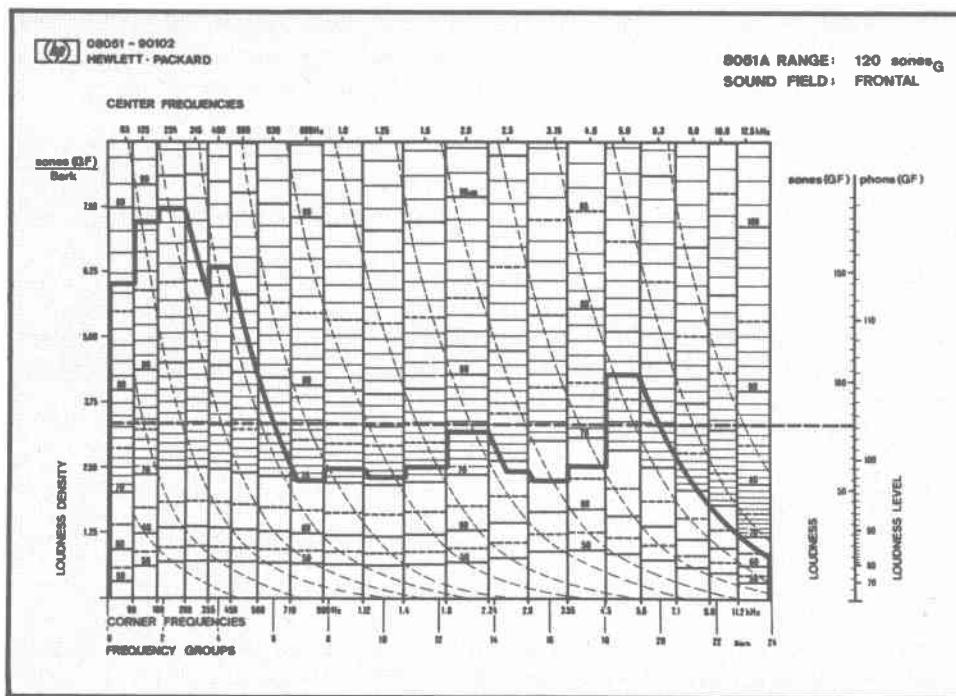

Figure 10. Zwicker diagram with curve representing analysis of a sound. Total loudness is given by area under curve (dashed line).

There are eight different Zwicker diagrams, four for frontal sound fields of different maximum sound pressure levels, and four for diffuse fields of different levels. Once the proper diagram has been chosen, measured $1/3$ -octave sound pressure levels are placed on the diagram as horizontal lines between the frequency limits of the appropriate bands. In the same way, the levels calculated from $1/3$ -octave levels in the three lowest bands are entered. This gives 20 horizontal lines on the

diagram. At the high-frequency limit of each band, other lines are drawn, parallel to the dashed auxiliary lines contained in the diagram. Thus we get a loudness density-subjective pitch diagram, the total area of which gives total loudness. An example is given in Figure 10. The loudness of the sound shown in Figure 10 has been calculated by this procedure to be:

$$S_{GF} = 79 \text{ sones}_{GF} \text{ or } L_{SGF} = 103 \text{ phons}_{GF}.$$

(The subscript GF indicates a critical-band analysis and a frontal sound field.)

Zwicker's procedure is as valid for impulsive sounds as it is for uniform sounds. If an rms voltmeter is used to indicate the critical-band levels or the $1/3$ -octave levels for impulsive sounds, it will have to have a high crest-factor capability and an integration time of approximately 100 ms. This is roughly the time constant of the ear.

Kryter's Procedure for Evaluating Annoyance

Kryter's procedure approximates subjectively perceived noisiness rather than loudness. In this procedure the perceived noise level of a given sound is numerically equal to the sound pressure level of a reference sound that is judged by listeners to be as annoying as the given sound. The reference sound is a band of random noise, one octave wide and centered on 1 kHz. Compared to the Stevens method, this one recognizes the increased contribution of the higher frequencies to the annoyance of a sound, and weights higher frequencies more heavily.

Instead of the Stevens loudness index, we have here perceived noisiness n with the unit noy. The numerical value of the perceived noisiness n of a sound within a given third-octave band is related to the sound pressure level L within that band by the equation

$$n = 10^{m(L-L_0)}$$

where m and L_0 depend on the band center frequency and the range of L . Table 4 lists the coefficients m and L_0 , and Figure 11 shows the family of curves of equal perceived noisiness. Note that the D-weighting curve shown in Figure 8 is the inverse of the 40-noy curve of Figure 11.

The Kryter method accounts for masking in the same way as the Stevens method. Thus total perceived noisiness PN is calculated as

$$PN = n_m + 0.15 (\sum n - n_m)$$

where n_m is the maximum value of perceived noisiness measured in the various bands and $\sum n$ is the sum of the values of perceived noisiness in all bands. Total perceived noisiness PN is related to perceived noise level L_{PN} by

$$PN = 2^{(L_{PN}-40)/10}$$

Perceived noise level L_{PN} is commonly expressed in PNdB.

Subjective tests have shown that the perceived noise level is greater for sounds made up of more or less random noise and some relatively intense steady-state tones or narrow-band energy than it is for sounds made up only of noise even

Table 4. Perceived noisiness coefficients.

Band center frequency (Hz)	Lower range of L			Upper range of L		
	L	n	L _o	L	n	L _o
50	64-91	0.04348	64	92-150	0.03010	52
63	60-85	0.04057	60	86-150	0.03010	51
80	56-85	0.03683	56	86-150	0.03010	49
100	53-79	0.03683	53	80-150	0.03010	47
125	51-79	0.03534	51	80-150	0.03010	46
160	48-75	0.03333	48	76-150	0.03010	45
200	46-73	0.03333	46	74-150	0.03010	43
250	44-74	0.03205	44	75-150	0.03010	42
315	42-94	0.03068	42	95-150	0.03010	41
Full range of L						
400				40-150	0.03010	40
500				40-150	0.03010	40
630				40-150	0.03010	40
800				40-150	0.03010	40
1000				40-150	0.03010	40
1250				38-148	0.03010	38
1600				34-144	0.02996	34
2000				32-142	0.02996	32
2500				30-140	0.02996	30
3150				29-139	0.02996	29
4000				29-139	0.02996	29
5000				30-140	0.02996	30
6300				31-141	0.02996	31
	Lower range of L			Upper range of L		
8000	38-47	0.04229	38	48-144	0.02996	34
10000	41-50	0.04229	41	51-147	0.02996	37

though the overall energy level of the two sounds is the same. We must therefore add a tone correction C to the perceived noise level L_{PN} to get the tone-corrected perceived noise level L_{TPN} for a sound having tonal components. The tone correction, which can be as high as 7 dB, is determined through an evaluation of all the third-octave band levels in the range from 80 Hz to 10 kHz.

The total subjective effect of a sound event such as an aircraft flyover, depends not only on the maximum tone-corrected perceived noise level $L_{TPN_{max}}$ during the event but also on the time history of the noise. To account for the influence of

time, we have the effective tone-corrected perceived noise level L_{ETPN} . This is defined as

$$L_{ETPN} = 10 \log \frac{1}{T_0} \int_{-\infty}^{+\infty} 10^{L_{TPN}/10} dt \text{ dB}$$

where L_{TPN} is the instantaneous tone-corrected perceived noise level and T_0 is a normalizing constant (10 seconds for aircraft noise measurements). For practical

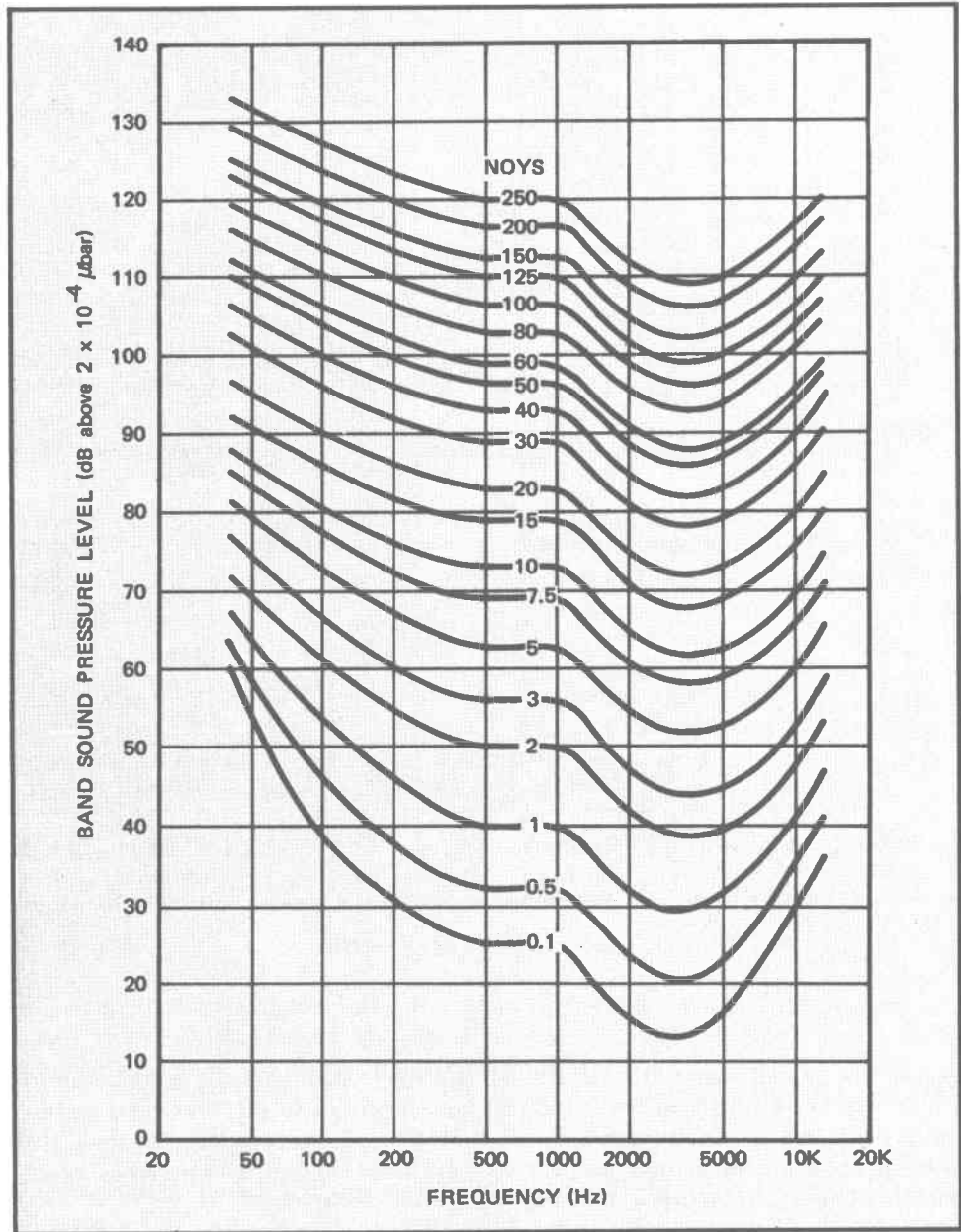

Figure 11. Curves for determining noisiness of bands of sound used in Kryter's method of calculating perceived noisiness.

purposes the effective tone-corrected perceived noise level of an aircraft flyover can be determined by the equation

$$L_{ETPN} = 10 \log \frac{1}{20} \sum_i 10^{L_{TPNi}/10} \text{ dB}$$

where L_{TPNi} is the instantaneous tone-corrected perceived noise level in the time intervals i , and i are 0.5-second intervals during which L_{TPN} is above a certain value below the maximum tone-corrected perceived noise level.

This "certain value" is dependent upon the measuring equipment. However, in no case should it be less than 10 dB below the maximum tone-corrected perceived noise level. On the other hand, there is no need to set the limit more than 20 dB down, for at that point the difference between the two above equations becomes negligible.

The latter procedure for calculating effective tone-corrected perceived noise level requires an automatic data processing system. For daily, routine measurements a simpler method can be used, provided that tone corrections can be disregarded. In this case an acceptable approximation of perceived noise level L_{PN} can be obtained using

$$L_{PN} \approx L_D + 7 \text{ dB}$$

where L_D is the D-weighted sound level in dB.

The approximation of effective perceived noise level L_{EPN} can be obtained using

$$L_{EPN} \approx L_{Dmax} + 7 \text{ dB} + (10 \log [(t_2 - t_1)/T_0]) \text{ dB}$$

where L_{Dmax} is the maximum D-weighted sound level during an aircraft flyover and T_0 is a normalizing constant having the dimensions of time.

For this approximation $(t_2 - t_1)$ is the time interval during which L_D is within 10 dB of its maximum value and T_0 is 15 seconds.

These methods are described in ISO Recommendation 507 and its newest amendments (April 1968).

Noise Rating Numbers

Single-figure sound level measurement is the simplest method of rating noise associated with machines, construction, aircraft, traffic, etc. Noise rating numbers provide us with a guide to such noises with respect to interference with speech communication and annoyance. A frequency analysis of a noise helps with its rating; such analysis is essential if steps taken to reduce the noise are to be evaluated effectively. At present there are methods which call for frequency analysis in terms of both octaves and third octaves.

One method requires the use of noise rating curves, shown in Figure 12. The measured noise spectrum is compared against the curves so that the particular frequency band contributing the most can be identified. This particular procedure requires an analysis of the noise in octave bands. The noise rating number N of the noise is the number of the curve lying just above the spectrum. From Figure 12 we see that for the octave band centered at 1 kHz, the noise rating number N is

equal to the octave band sound pressure level in dB. For other octave bands N can be calculated from

$$L = a + bN$$

where L is the octave band sound pressure level of the octave band in question and a and b are coefficients given in Table 5.

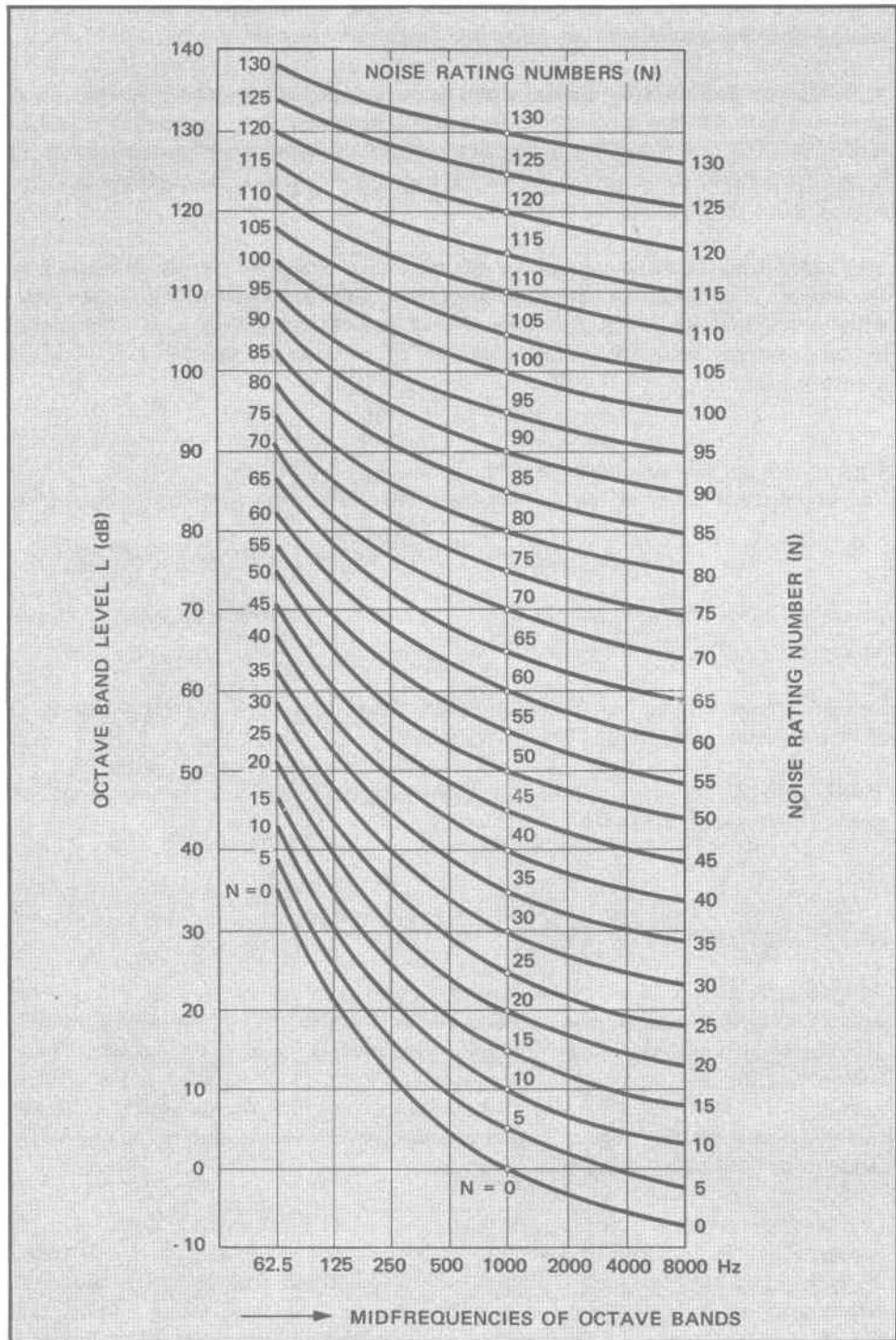

Figure 12. Noise rating curves.

Table 5. The coefficients a and b of the equation $L = a + bN$ as a function of the mid-frequencies of the octave bands.

MIDFREQUENCY OF OCTAVE BAND (Hz)	a (dB)	b (dB)
63	35.5	0.790
125	22.0	0.870
250	12.0	0.930
500	4.8	0.974
1000	0	1.000
2000	-3.5	1.015
4000	-6.1	1.025
8000	-8.0	1.030

SECTION V
Instrumentation for
Acoustic Measurements



MICROPHONES

Acoustical measurements start with the transducer (microphone) which converts audio sound pressure into an electrical signal. Ideally, the microphone distorts neither the sound field by its very presence in the field nor the electrical signal due to any inherent nonlinearities. The ideal microphone, including any required preamplifier, must therefore satisfy the following requirements:

- a) Cause negligible diffraction of the sound field, i. e. its dimensions must be small compared to the shortest wavelength of interest.
- b) Have a high acoustic impedance (more correctly, acoustic driving-point impedance) compared to the medium to which it is coupled (usually air) and so absorb no acoustic energy.
- c) Have a flat frequency response.
- d) Introduce zero phase shift (or a phase shift which varies linearly with frequency) between the sound pressure signal and the electrical output.
- e) Have a pressure response independent of the pressure level.
- f) Have a 0-dB noise figure.
- g) Be independent of the environment, i. e. stable with respect to time, temperature, humidity, static air pressure, etc.

While no microphone can meet these requirements, they do form a basis against which to evaluate microphone performance. Specifications have been established for laboratory standard microphones and are described in USA Standard SI. 12-1967.

A. TYPES OF MICROPHONES

As there are a variety of jobs for microphones to do, there are a variety of microphones. For example, for intelligible voice communication by telephone, a microphone of only limited frequency range is required; however, it must be rugged and sensitive — require no preamplifier. The carbon granule microphone more than fulfills these requirements. The broadcast industry, on the other hand, needs microphones which not only have a broad frequency range for good fidelity but also are highly directional to reduce interference from unwanted sounds. The ribbon microphone handles this job well. While microphones such as these play important roles in their specific areas and do indeed convert sound pressure to voltage, their relatively loose operating characteristics make them unsuitable for accurate sound measurements.

1. Ceramic Microphone

The three most widely used microphones for sound measurements are the ceramic, high-frequency condenser, and condenser microphones. The ceramic microphone gets its name from its ceramic cartridge, which exhibits piezoelectric properties. Thus the cartridge produces a voltage as a result of strain caused by sound pressure. Unlike the high-frequency condenser and condenser microphones described

below, the ceramic microphone requires no polarization voltage, an advantage when designing circuits for portable operation. However, the ceramic microphone has some disadvantages as well. Its upper frequency range is somewhat limited, about 10 to 12 kHz; its frequency response, ± 8 dB for frontal field and ± 4 dB for random and parallel fields, is not as good as that of the condenser microphone, although most of the variation occurs above about 8 kHz; and it is about 14 dB less sensitive than a condenser microphone of the same dimensions.

2. High-Frequency Condenser Microphone

The high-frequency condenser microphone gets its name because 1) it utilizes a condenser (capacitor) as the transducer and 2) the condenser forms part of the frequency-determining network of a high-frequency (about 10 MHz) oscillator. The diaphragm of the microphone is one plate of the condenser, so the sound pressure varies the spacing of the condenser plates and thus the capacitance. As a result, the oscillator frequency is modulated by the sound, and the audio is recovered by detecting the fm signal. The high-frequency condenser microphone has somewhat better characteristics than the ceramic microphone. Its biggest advantage is that its low-frequency limit can be extended to 0 Hz. However, compared to the condenser microphone discussed below, the typical high-frequency condenser microphone is 10 dB less sensitive and its frequency response (± 6 dB for frontal field) is not as good. The high-frequency condenser microphone requires only a low polarization voltage.

3. Condenser Microphone

This brings us to the condenser microphone. Its flat frequency response (± 1 dB from 20 Hz to 20 kHz for the $\frac{1}{2}$ -inch configuration) and high sensitivity (1.58 mV/ μ bar for the $\frac{1}{2}$ -inch, 5 mV/ μ bar for the 1-inch) are advantages which more than outweigh its one disadvantage: high polarization voltage (200 volts).

The condenser microphone also gets its name because it utilizes a condenser to convert sound pressure to voltage. The general physical construction of a condenser microphone is shown in Figure 13. The membrane (diaphragm) is one plate of the condenser or capacitor; the polarization electrode, the other. The membrane is attached to the housing, which is at ground potential, while the 200 V polarization voltage is applied to the polarization electrode through a gold-plated contact. A quartz insulator supports the polarization electrode as well as insulates it from the housing. With the polarization voltage applied, the spacing between the membrane and polarization electrode is about 0.6 mm. Air holes in the polarization electrode relieve the air which would otherwise be trapped behind the membrane. These holes lower the resonant frequency of the microphone cartridge, increase its sensitivity, and improve its frequency response. Not shown is a small capillary hole through the housing which allows some air flow so that the static pressure within the capsule always equals the ambient atmospheric pressure. However, the hole is small enough so that it permits only long-term pressure equalization. Thus the acoustic loading is the same on both sides of the membrane even at frequencies well below 20 Hz. On Hewlett-Packard microphones, a perforated cap both protects the delicate microphone membrane and serves as an electrostatic actuator for calibration purposes (see below).

(Thus far the term microphone has been used rather loosely, sometimes meaning

the entire microphone assembly, including the associated preamplifier electronics, and sometimes just the microphone cartridge. Henceforth, the term microphone will mean the entire assembly; microphone cartridge and preamplifier will be used where necessary to distinguish these from the assembly. This definition of terms has no bearing on the above discussion because microphone characteristics are determined primarily by the cartridge.)

The condenser microphone cartridge generates a voltage because the voltage across a capacitor having a given charge is proportional to the distance between the plates. The charge is supplied by the polarization voltage. If the polarization voltage source has an impedance high enough to prevent significant current flow even at the lowest frequency, then the charge on the condenser can be considered constant. Since one plate of the condenser is the microphone membrane and the displacement of the membrane from its rest position is proportional to sound pressure, the generated voltage is also proportional to sound pressure.

Because the transducer is a condenser or capacitor, its impedance is frequency dependent. In the HP 15119A $\frac{1}{2}$ -in. Microphone, the value of capacitance is 27 pF; in the 15109B 1-in. Microphone, 68 pF. At 20 Hz, the source impedances of these microphones are approximately 300 megohms and 120 megohms respectively. Thus it is important that these condensers be connected to as high a load resistance as possible. On the other hand, the capacitance shunting the load resistance must be as small as possible to avoid attenuating the output from the cartridge. These factors require that the microphone cartridge be connected directly to an impedance converter or preamplifier. Now, the preamplifier must not interfere with the sound field; to do so would degrade the accuracy of the measurements. For this reason, most preamplifiers are designed to fit into a cylindrical housing the same diameter as the cartridge. (US standards recommend that the preamplifier be long compared to cartridge diameter.) Both the housing and cartridge are threaded for convenience in attaching and removing the cartridge.

Hewlett-Packard preamplifiers meet all the requirements noted above and, in addition, are all solid state for high reliability and low microphonics. Input resistance is in the order of 1000 megohms shunted by less than 2 picofarads. The characteristics of the entire microphone assembly therefore are determined by the cartridge itself. HP microphones are shown in Figure 14.

B. CALIBRATION OF MICROPHONES

Before we can make sound measurements, we must know the sensitivity of the microphone over the frequency range of interest. That is, we need to know the sound pressure to voltage conversion factor. At present the most widely used method for absolute calibration of microphones is the so-called reciprocity method. This method is described in detail, for example, in US Standard Sl. 10-1966. Generally, the reciprocity method is used to calibrate only the cartridge, but since the cartridge is the primary factor in determining the characteristics of the microphone assembly, for all practical purposes the entire assembly is also calibrated.

1. Reciprocity Calibration

a. Free-field Calibration

The free-field reciprocity calibration of microphones requires two microphones

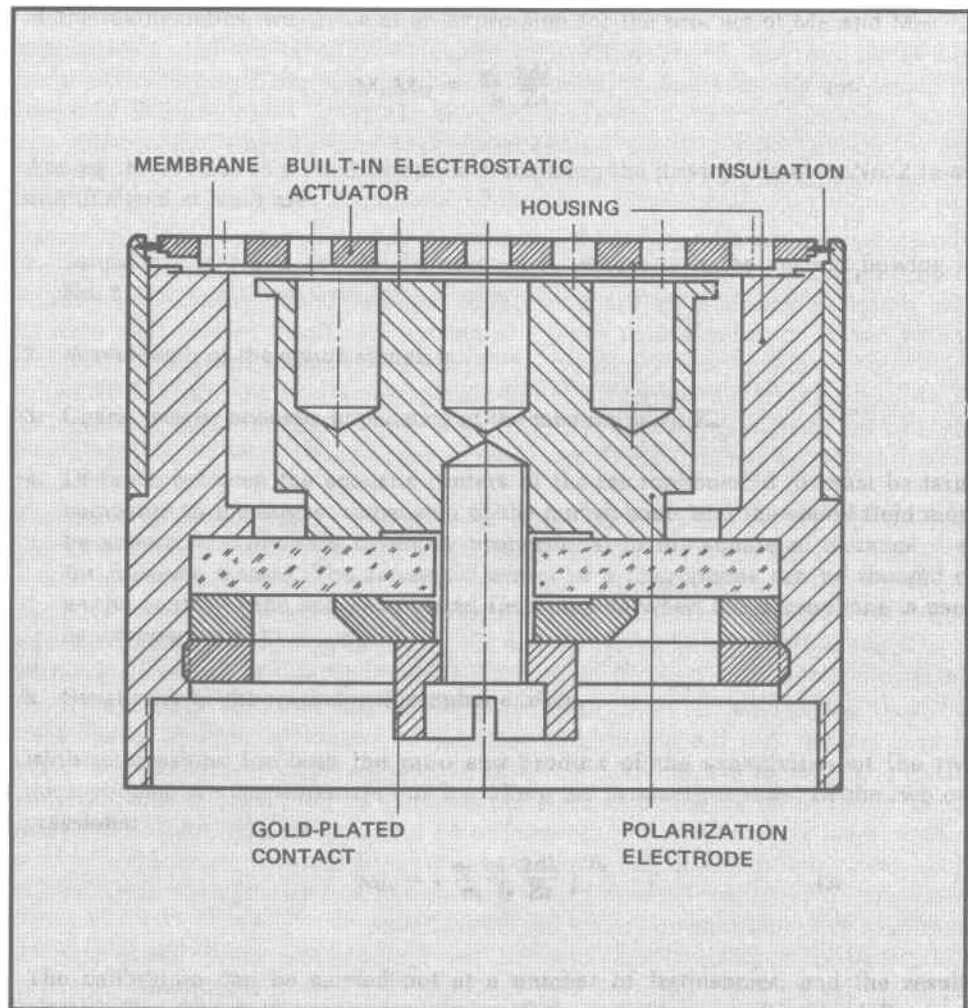

Figure 13. Condenser microphone cartridge.

and an independent sound source. In addition, one of the microphones must be reciprocal, i. e. must be able to function both as a loudspeaker and as a microphone. (Condenser microphones are reciprocal.) The actual calibration procedure is so arranged that unknown or unmeasurable quantities cancel each other out, and only physical constants and electrical quantities are left. Calibration is further simplified if both microphones are the same type, and they are considered to be so here. Free-field by definition is uni-directional, that is, the sound energy travels in only one direction. Free-field calibration, then, requires the use of an anechoic chamber or room.

Although the angle between the plane of the microphone diaphragm and that of the sound wave can be set arbitrarily, 0° is usually chosen. (By definition, this angle is that between the direction of sound travel and the axis of symmetry of the microphone. For HP microphones, this axis is perpendicular to the diaphragm and passes through its geometrical center. For microphones having no axis of symmetry, two angles must be specified.)

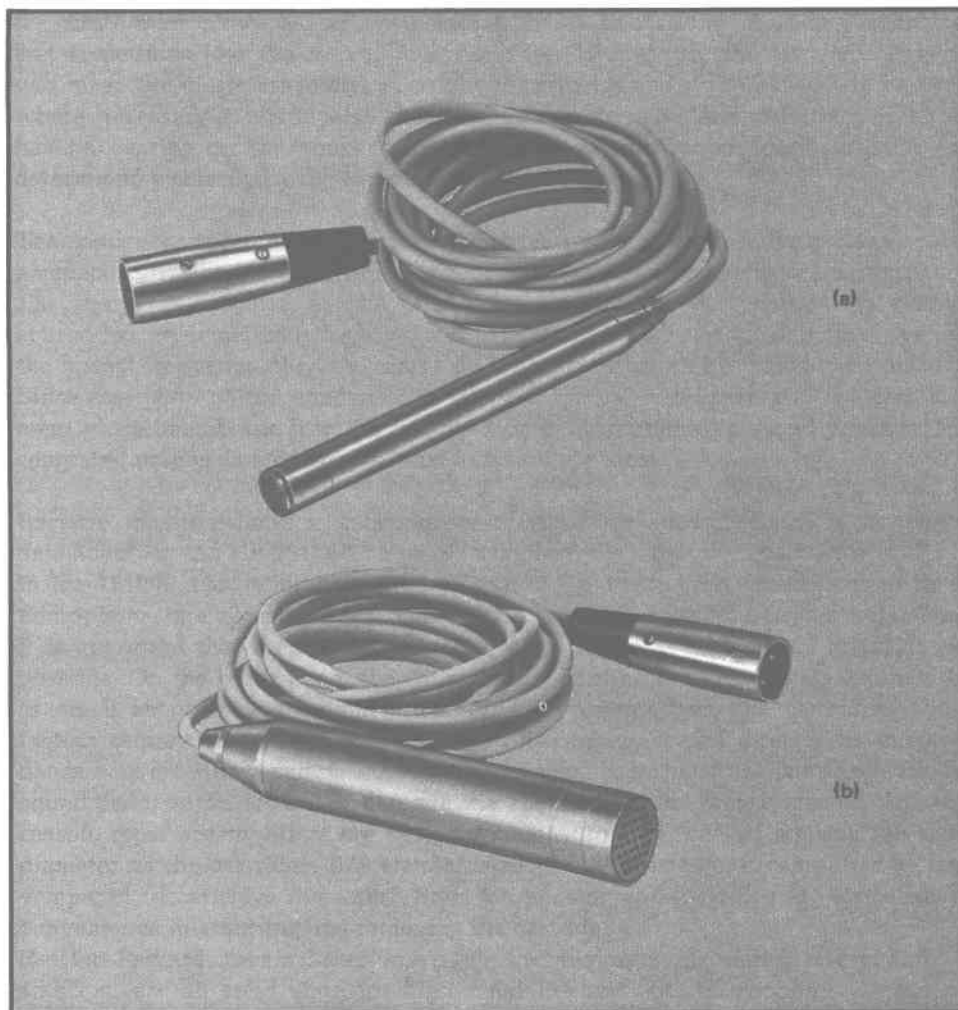

Figure 14. HP 15119A 1/2-in. microphone (a), 15109B 1-in. microphone (b).

In the first step of the calibration, the independent sound source is turned on, and first one and then the other microphone is placed in the sound field. The open-circuit voltage of each is measured. Now, the expression for free-field sensitivity M_f is $M_f = e/p_f$, where e is the open-circuit voltage and p_f is the sound pressure. Since we don't know the value of p_f , we eliminate it by taking the ratio of M_f for the two microphones. (Note: In this discussion, we shall ignore phase and consider only magnitude.) Therefore,

$$\frac{M_{f1}}{M_{f2}} = \frac{e_1/p_f}{e_2/p_f} = \frac{e_1}{e_2} \quad (1)$$

which is simply the ratio of electrical quantities.

The second step of the calibration eliminates one of the sensitivity factors, M_{f1} or M_{f2} . In this step, one of the microphones, say number 2, is operated as a loud-speaker by driving it with a known electrical signal. With appropriate manipulation

of the mathematics, we arrive at an expression for the product of M_{f1} and M_{f2} :

$$M_{f1}M_{f2} = \frac{e'_1}{i_2} \frac{2d\lambda}{Z_0} \quad (2)$$

Among the factors to be considered in translating the driving signal to No. 2 to an output signal at No. 1 are:

1. Sensitivity of No. 2 as a loudspeaker: p/i_2 , where i_2 is the current flowing in No. 2.
2. Wavelength of the sound signal: λ .
3. Characteristic acoustic impedance of the medium (air): Z_0 .
4. Distance between the acoustic centers of the microphones: d (d must be large compared to the largest dimension of the microphone, and the sound field must be spherical — pressure inversely proportional to the square of distance — at the distance d used. The acoustical center of a microphone can be thought of as the center of the spherical sound field created when the microphone is used as a loudspeaker.)
5. Sensitivity of the receiving microphone: e'_1/p .

With expressions for both the ratio and product of the sensitivities of the two microphones, we can eliminate one by taking the product (or ratio) of the two expressions:

$$M_{f1}^2 = \left(\frac{e_1}{e_2} \frac{e'_1}{i_2} \frac{2d\lambda}{Z_0} \right)^{1/2} \quad (3)$$

The calibration can be carried out at a number of frequencies, and the results plotted. The free-field sensitivity curves of the cartridges used in the HP microphone assemblies are shown in Figure 15. Note that the sensitivity decreases at higher frequencies (at which the microphone dimensions are less than a wavelength) as the angle of incidence of the sound is changed from 0° . This decrease is due to changes in the distribution of pressure over the diaphragm.

b. Pressure Calibration

Because free-field calibration requires an anechoic chamber, bulky and expensive at best, it is not the most convenient method. Pressure calibration, which employs a small, enclosed cavity is much simpler. Otherwise, the two methods are quite similar. A typical chamber is shown in Figure 16. As in the free-field method, two microphones and an independent sound source are required⁴, and the procedure is so arranged that only physical constants and electrical quantities are required. Again, we assume that both microphones are the same type.

In the first step, the independent sound source is inserted in one opening of the cavity. The condenser microphones are alternately placed in the second opening and their open-circuit output voltages measured with the sound source turned on.

⁴ General Radio Company manufactures a Microphone Reciprocity Calibrator Type 1559-B in which the cavity walls are piezoelectric. The cavity itself is then the independent sound source. A built-in mechanical analog computer greatly simplifies operation. This calibration, however, is a diffuse field calibration.

The pressure sensitivity of a microphone is $M_p = e/p$. Again, we eliminate p by taking the ratio

$$\frac{M_{p1}}{M_{p2}} = \frac{e_1}{e_2} \quad (4)$$

As before, the second step eliminates one of the sensitivity factors. A microphone is inserted in each opening of the cavity, and the number 2 microphone is operated as a loudspeaker by driving it with a known electrical signal. This time the expression for the product of M_{p1} and M_{p2} is

$$M_{p1} M_{p2} = \frac{e'_1}{i_2} \frac{\omega V_c}{\gamma P_0} \quad (5)$$

Among the factors to be considered in translating the driving signal to no. 2 into an output signal at no. 1 are

1. Sensitivity of no. 2 as a loudspeaker: p/i

2. Acoustic impedance of the cavity: $Z = \frac{\gamma P_0}{\omega V_c}$

where γ is the ratio of specific heat of the gas in the cavity at constant pressure to its specific heat at constant volume (1.403 at 0 ° C and 1 atmosphere for air)

P_0 is atmospheric pressure

ω is 2π times the frequency of the sound signal

V_c is the volume of the cavity (generally between 10 and 20 cm³).

3. Pressure sensitivity of the receiving microphone: e_1/p .

Taking the product of equations (4) and (5) eliminates M_{p2} , leaving only M_{p1} :

$$M_{p1} = \left(\frac{e_1}{e_2} \frac{e'_1}{i_2} \frac{\omega V_c}{\gamma P_0} \right)^{1/2} \quad (6)$$

In making a pressure calibration using a cavity, it is important that the pressure be uniform throughout the cavity, that is, that there be no wave motion in the cavity. Therefore, the wavelength of the sound at the chosen frequency must be long compared with the cavity dimensions. To increase the upper frequency limit at which wave motion can be neglected, gases other than air are often introduced into the cavity. Hydrogen, in which the velocity of sound is three times that in air, is one such gas. In the cavity shown in Figure 16, the upper frequency at which wave motion affects accuracy by no more than 0.1 dB is about 2.6 kHz for air, 10 kHz for Hydrogen. There are other factors to be considered as well; however, since their effect is generally small, they are beyond the scope of this handbook.

c. Differences Between Free-field and Pressure Sensitivity.

Pressure sensitivity curves for HP Microphones are shown in Figure 17. Note that these curves do not agree with the free-field sensitivity curves in Figure 15 at higher frequencies. The differences are accounted for by the conditions under which the calibrations are performed. In free-field calibration, the microphone being calibrated is a reflecting body. At higher frequencies, at which the dimensions of the microphone become a significant part of a wavelength, the reflected

sound adds to the incident sound, creating a pressure-doubling effect. This effect is maximum at 0° incidence, zero at 90° incidence. The design of the cartridge takes this effect into account to provide a frontal free-field frequency response as flat as possible over as wide a range as possible. Pressure response, which by definition does not permit pressure doubling, therefore falls off at higher frequencies.

The difference between free-field and pressure sensitivity is dependent solely on microphone geometry. Thus only one type of calibration need be performed; the data is easily converted by means of charts. Figure 18 shows the differences between free-field and pressure sensitivity for HP 1-in. and $\frac{1}{2}$ -in. Microphones.

d. Diffuse-field Calibration.

Because in a diffuse field sound comes from all directions equally (with random phase relationships), the directional characteristics of a microphone come into play. Ideal conditions for calibration are difficult to construct, but fortunately standards have been established and the diffuse-field calibration can be calculated from the free-field characteristics. As we might expect, the diffuse-field characteristics lie between the extremes of the free-field curves of Figure 15 b. Diffuse-field curves for HP 1-in. and $\frac{1}{2}$ -in. Microphones are shown in Figure 19. These are shown in the form of correction curves for the free-field response.

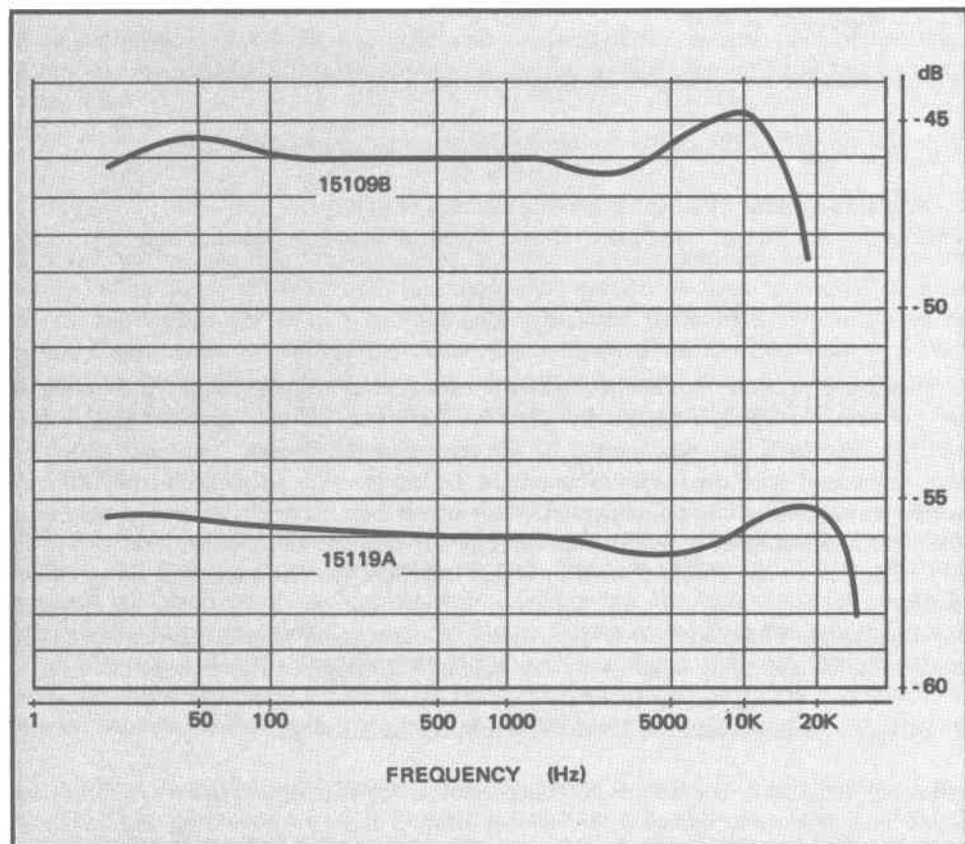

Figure 15.a. Typical free-field sensitivity of HP microphones for frontal (0°) incidence referred to $1 \text{ V}/\mu\text{bar}$.

2. Calibration by Substitution.

Microphones can also be calibrated by the substitution method, one that works equally well for both free-field and pressure calibration. The first step is the measurement of sound pressure with a microphone that has been calibrated previously (preferably by the reciprocity method). Then the unknown microphone is substituted and the results noted. Generally the sound pressure is measured a second time with the calibrated microphone to be sure nothing has changed in the process of substitution. Because there is some transfer error in comparing the unknown with the standard microphone, this is a secondary level of calibration. It is interesting to note that for purposes of comparison, the Weston Type 640AA has gained universal acceptance as the Standard Microphone.

3. Pistonphone

The reciprocity method provides absolute, primary-standard level of calibration of microphones. For field calibration, where secondary-standard level is certainly acceptable, the pistonphone and electrostatic actuator (described below) offer a convenient yet highly accurate alternative ⁵.

Calibration using a pistonphone is similar to pressure calibration in that it involves the use of a rigid cavity. The microphone to be calibrated is inserted in one wall of the cavity, and a moveable piston in the other. The piston may be driven by a coil similar to the type used in loudspeakers (or by a rotating cam as in the Bruel & Kjaer Type 4220). The moving piston varies the volume of the cavity and thus the pressure. As long as the volume described by the rms amplitude of the motion of the piston and the cross-sectional area of the piston is small compared to the total volume of the cavity, the pressure is directly proportional to piston displacement. The pistonphone is limited to low frequencies because of inertial and other problems. However, when used in conjunction with the electrostatic actuator, the pistonphone need be used at only one frequency. The frequency chosen can be some mid-range frequency, say 500 Hz, at which correction factors are negligible.

The piston can be replaced with a loudspeaker (as in the Neumann Model DK2a), although the physical displacement of the loudspeaker diaphragm is much more difficult to measure than that of a piston. For this reason, a calibrator using a loudspeaker is generally itself calibrated with a standard microphone. However, with a high-quality loudspeaker operated at a single frequency and driven by a stable signal source, such a calibrator makes a highly reliable secondary standard which is both convenient to use and inexpensive.

4. Electrostatic Actuator.

The electrostatic actuator is a slotted metallic plate brought into close proximity of the diaphragm of a condenser microphone. A dc potential plus a superimposed ac voltage is then applied between the actuator and diaphragm. The result is a force or pressure on the diaphragm which is proportional to the instantaneous electrostatic field. Since the pressure is nearly uniform over the entire diaphragm, the calibration is analogous to pressure calibration. The advantage of the electrostatic actuator is that the pressure is independent of frequency, and none of the correc-

⁵ It should be noted that before the advent of the reciprocity method of calibration, the pistonphone was used as a primary standard of calibration at low frequencies.

Figure 15.b. Change in microphone sensitivity with angle of incidence.

15119A

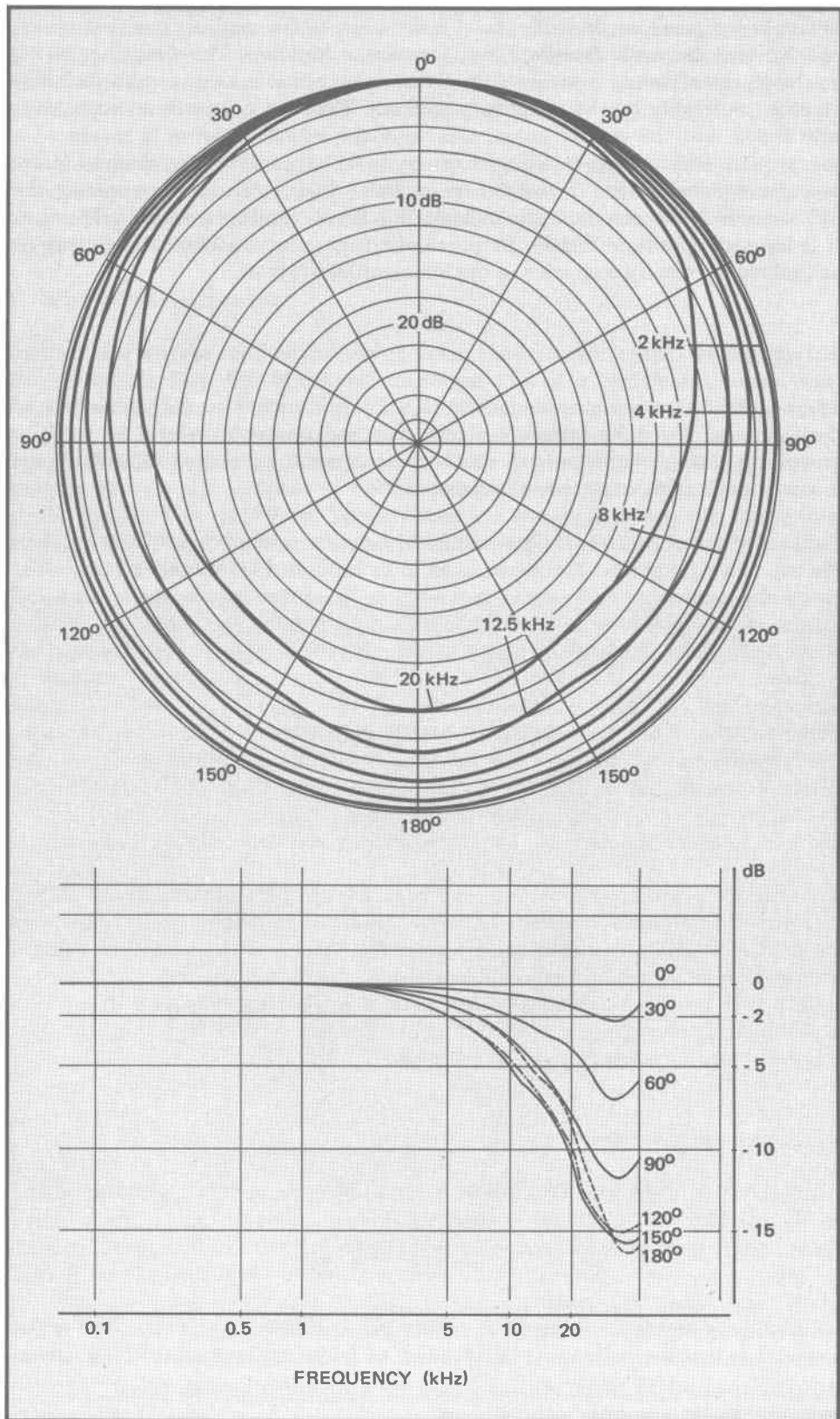

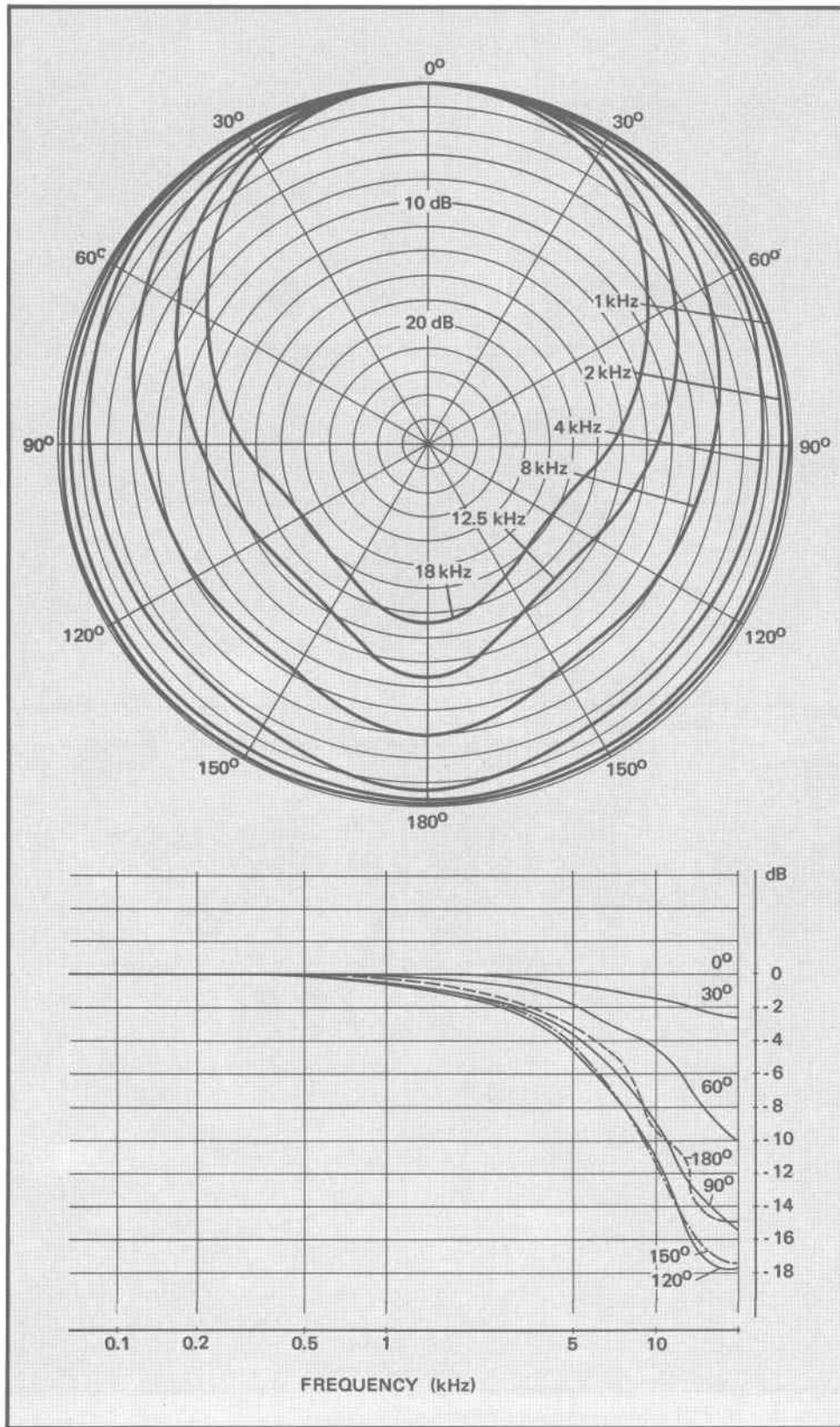

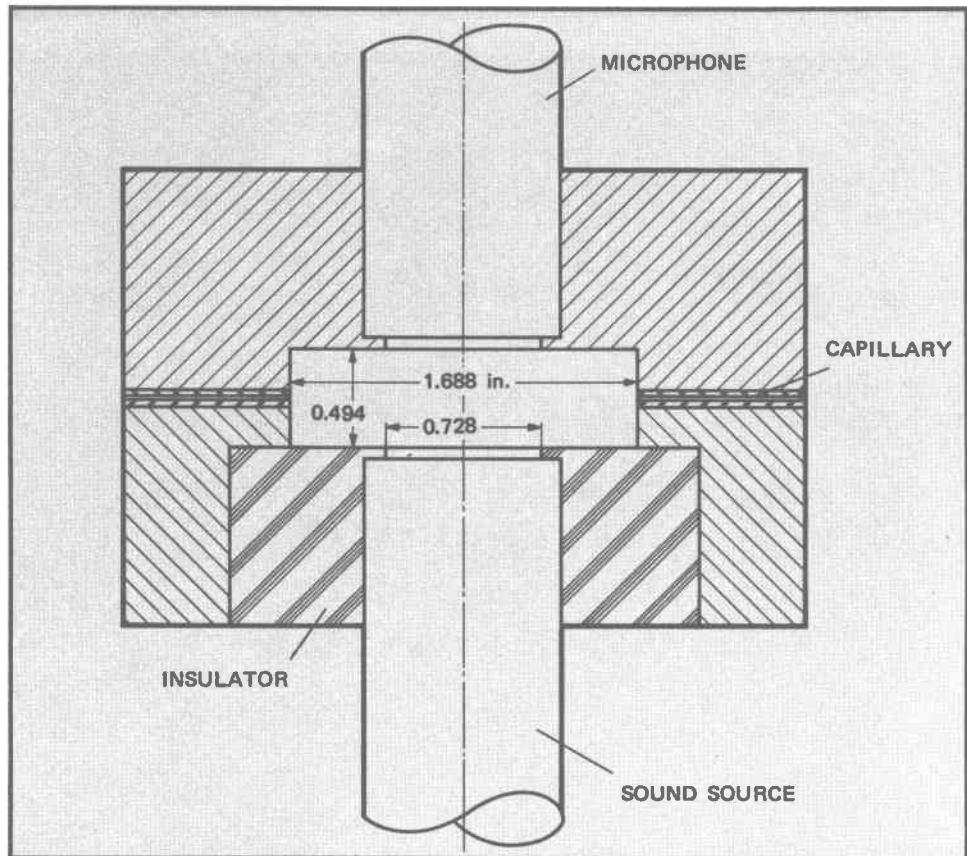

Figure 16. Typical chamber for pressure calibration using the reciprocity method.

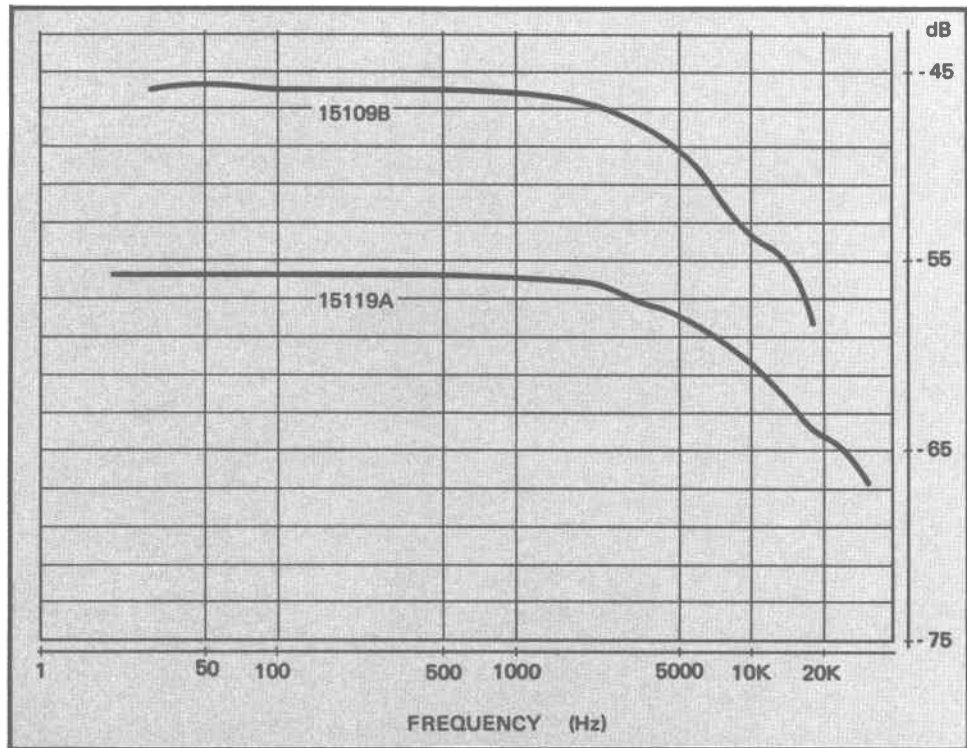

Figure 17. Typical pressure sensitivity of HP microphones.

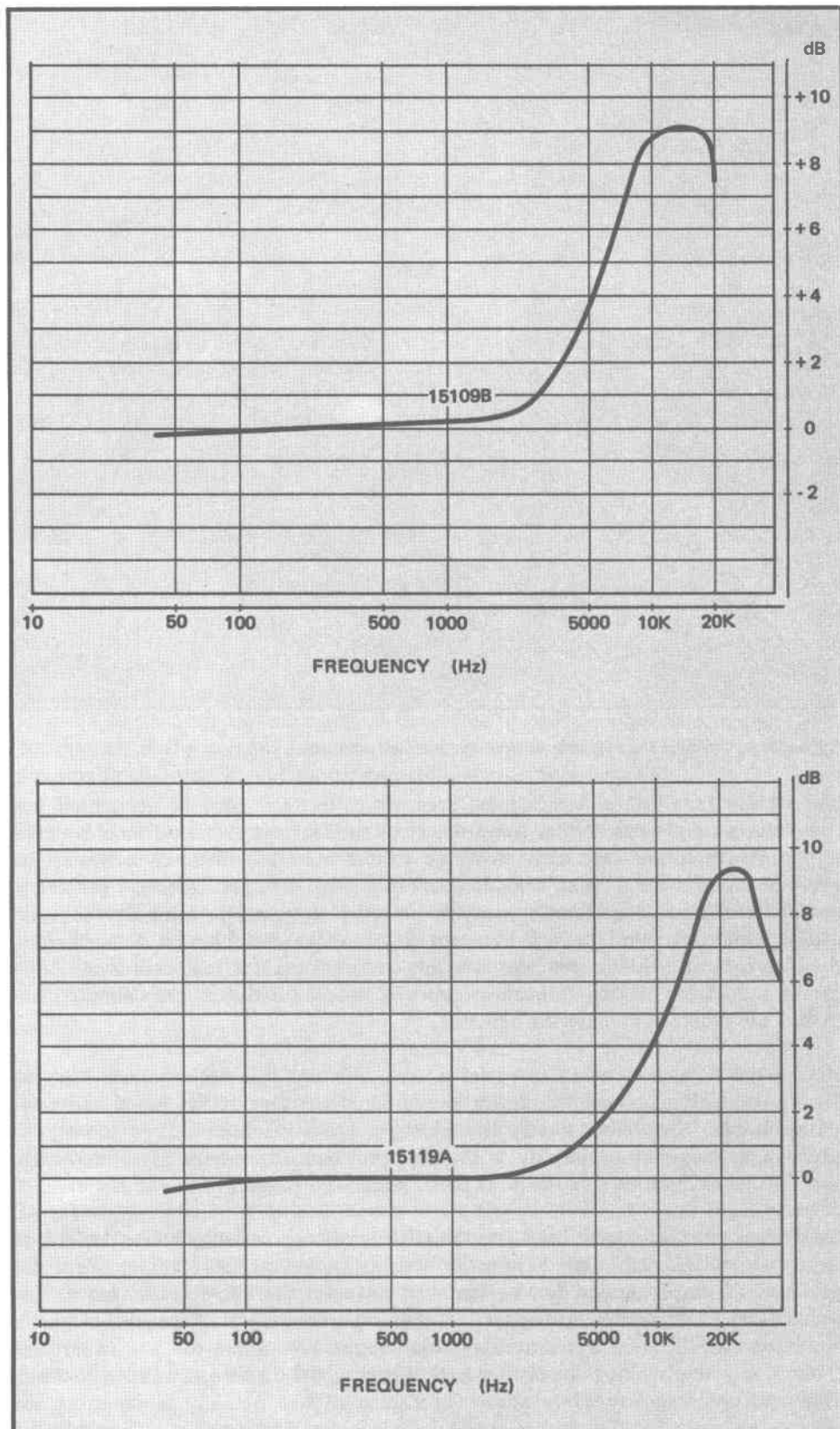

Figure 18. Difference between pressure and 0° free-field sensitivity.

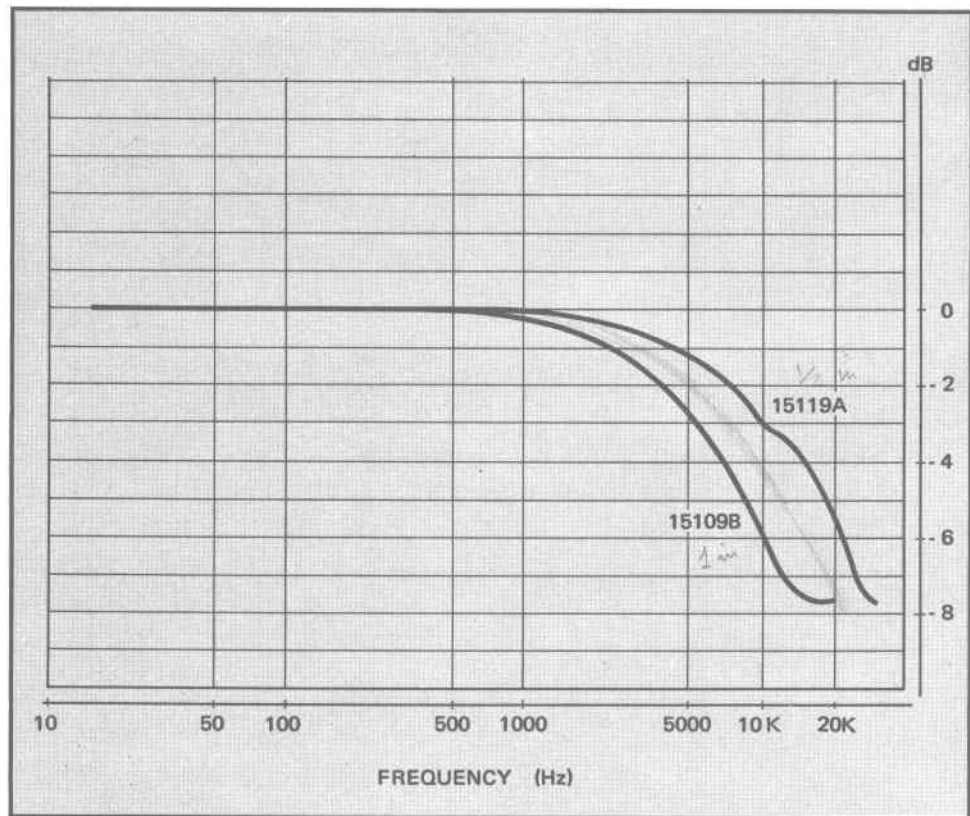

Figure 19. Diffuse-field response relative to free-field response.

tion factors involved in a reciprocal pressure calibration need be accounted for. However, absolute calibration using the electrostatic actuator is difficult because the measurement is extremely sensitive to the effective distance between the actuator and the diaphragm. This distance is dependent upon cartridge geometry, number and size of perforations in the actuator (required to minimize acoustic loading), and the actual distance between the actuator and diaphragm. Nevertheless, the electrostatic actuator provides a highly accurate relative calibration and so is ideally suited for making frequency-response tests. In addition, only simple electronics are required to drive the actuator.

Note that a dc as well as an ac signal is used, although it is not required. Without the dc, the output signal frequency would be twice that of the input and non-sinusoidal in form (more nearly resembling a full-wave rectified waveform). In addition, microphone sensitivity to the ac signal increases as the dc is increased, and distortion decreases as the dc is made large with respect to the ac signal.

An electrostatic actuator is built into the HP microphone cartridges. The perforated face plate, which is insulated from the housing, serves as the actuator. Thus the protective face plate need not be removed to insert the microphone into an external actuator. Considering the fact that the diaphragm of a condenser microphone is extremely delicate and that accidents do happen even under the best of circumstances, any step which reduces the need to expose the diaphragm is a positive one. The pressure response curve shown in Figure 17 was actually made using the electrostatic actuator. This curve can be labelled "pressure sensitivity" because the reciprocity method was used to establish absolute pressure calibration.

C. SOUND MEASUREMENT WITH CONDENSER MICROPHONES

1. Selection of a Microphone.

The choice of a microphone is based on many parameters. These include size, frequency response, sensitivity, and directional characteristics. Fortunately, the quality of present-day microphones simplifies the selection. The Hewlett-Packard 15119A 1/2-in. Microphone Assembly is particularly well suited to general measurements in both diffuse and free fields. Its 1/2-in. configuration ensures a minimum disturbance of the sound field (at 20 kHz one wave length is about 1/2 inch in air); it covers a wide range (30 to 150 dB of sound pressure level, A-weighted, or in other words, a quiet room to beyond the threshold of pain); it has an essentially flat frequency response over the entire audio range, and its directional characteristics are quite good (meets the requirements of IEC 179). Where sensitivity is the prime parameter, the HP 15109B 1-in. Microphone Assembly should be the choice. The 15109B is a full 10 dB more sensitive than the 15119A and so can measure down to the threshold of hearing. In other respects the 15119A is superior.

2. Placement and Orientation of the Microphone.

In this handbook we are primarily concerned with measuring sound in terms of our subjective reaction to it, that is, we would like to be able to correlate the results of our measurements directly to our sense of hearing. It is important then, that we measure the sound that the listener would have heard, had he been present. This condition requires that the microphone be placed at the normal location of the listener's head. Thus the microphone should be located at a height of about 4 feet (1,2 meters) if the listener is normally sitting, 5 1/2 feet (1,7 meters) if the listener is normally standing, and at an appropriate distance from the source.

The orientation of the microphone is immaterial in a diffuse field. However, even omni-directional microphones exhibit some directional qualities, so orientation is important in a field which is wholly or partly directional. In this case the microphone should be oriented so that the directional part of the field is frontally incident because microphone frequency response is flattest for such incidence. As noted in Section II, the transition from a directional sound field to a diffuse field in a room can be estimated from the formula

$$r_G = 0.14 \sqrt{\bar{a}A} \quad (7)$$

where r_G is the distance from the source at which the sound field changes from directional to diffuse, \bar{a} is the absorption coefficient of the walls, and A is the surface area of the walls, floor, and ceiling.

For a factory room $30 \times 40 \times 5$ meters ($98 \times 130 \times 16$ feet), r_G is about 2,5 meters or 8 feet. In some special measurement situations, the microphone may be located very close to the sound source. If the sound includes very high frequencies, there may be standing waves between the microphone and source, greatly influencing the measurement results. In such situations, the microphone should be oriented at some small angle, say 5° , with respect to the direction of the sound. This angle has virtually no effect on microphone frequency response.

Many measurement procedures are standardized, and many others are in the recommendation stage. In both instances the location and orientation of the micro-

phone is specified, and of course, the instructions should be followed to obtain meaningful results. Examples include measurement of aircraft and motor vehicle noise, determination of characteristics of loudspeakers and hearing aids, measurement of noise emitted by machines, and determination of noise rating numbers with respect to conservation of hearing, speech communication, and annoyance.

3. Interference.

Interference can be defined as those factors which are not normally associated with a sound field and affect the accuracy of its measurement. For the most part then, interference is caused by objects introduced into a sound field in order to measure it. Such objects include the microphone, its supporting structure, associated measuring instruments, and even the observer himself. Furniture, machines, walls, etc., although they do indeed affect the sound field, are not considered interference factors because they are permanent structures in the field. Outdoor measurements can be complicated further by wind, temperature, humidity, etc., so these factors must be accounted for when they differ from the norm for the area.

In general, a diffuse field is affected much less by interfering objects than a free field. However, it is often difficult to judge whether a field is directional or diffuse, even with the aid of equation (7) above. As a rule of thumb for such cases, treat indoor measurements as diffuse-field measurements, outdoor measurements as free-field measurements. Let's put some numbers on these interference factors, bearing in mind that they apply primarily to free-field measurements.

a. The Microphone.

As the transducer, the microphone is the only part of the measuring system which must actually be located in the sound field, and since its dimensions are often significant compared to the wavelength of the sound signal being measured, it does indeed affect the nature of the field. However, as noted above, the design characteristics of a microphone are usually such that they account for the interference, and the output of the microphone very closely approximates that of an ideal microphone.

b. Supporting Structure and Instrumentation

A microphone can be supported in a number of ways. Because of its small size and light weight, it can easily be mounted on a tripod or held in the hand. Sometimes it is an integral part of the indicating equipment. Let's look at the tripod first.

A tripod generally includes, in addition to the legs, a vertical cylindrical rod to which the microphone is attached. Let's assume this rod is 1 inch in diameter and the microphone is suspended 6 inches (150 mm) from it, between it and the sound source (the HP microphone assemblies with their tripod mounting adapters are about 6 inches long). The maximum free-field measurement error under such circumstances exceeds 2 dB above 4 kHz, diminishing with frequency below 4 kHz as the dimensions of the rod become less significant with respect to the wavelength of the sound signal. In reality, the microphone is "suspended" at one end of the rod, which diminishes its effect somewhat. However, the legs of the tripod add additional reflected signals which add vectorially to that of the vertical support. The net effect is a maximum expected error of about 2 dB for frequencies of 4 kHz and above.

In the case of the hand-held microphone, the observer himself is a reflecting object which affects the sound field. The degree to which a measurement is affected cannot be stated with any precision because of the unpredictability of the observer's size and dress. Nevertheless, a measurement error greater than 3 dB is a virtual certainty, 4 or 5 dB quite likely.

When the microphone is an integral part of the indicating instrument, the effect of the instrument must be considered. In some cases the instrument is square; in others, tapered. If we consider the instrument case to be a sphere 6 inches in diameter and the microphone to be suspended 6 inches from the sphere between it and the sound source, the maximum error would be about ± 2 dB at frequencies of 1 kHz and above. The instrument with a tapered case behind the microphone reduces this figure somewhat. The square case certainly does not. To improve the situation, microphones associated with square-case instruments are often on an arm which is pivoted where it connects to the instrument. The microphone can then be suspended above the instrument rather than between its flat front surface and the source. Although the disturbance of the field is less at this point, the angle of incidence is 90° , so the directional characteristics of the microphone must then be taken into account. Of course, any additional supporting structure must also be considered.

From the above we can see that it is best if the observer and the measuring equipment are some distance from the microphone. This is particularly true when larger instruments such as the HP 8051A Loudness Analyzer are used. For such an instrument, which measures $16 \times 12 \times 24$ inches ($425 \times 306 \times 708$ mm), the smallest dimension is one wavelength at 1 kHz. HP microphones are equipped with 10-foot (3 m) cables. Even longer cables can be used without additional amplifiers if some reduction in maximum output and/or high frequency response can be tolerated (see Figure 20). Where both full performance and long cables are required, the HP 15127A Cable Amplifier can be used. This amplifier drives more than 330 feet (100 meters) of cable.

4. Measurement Accuracy.

There are a number of factors in addition to interference which affect measurement accuracy. Let's put them together and see what kind of overall measurement accuracy we can expect.

a. Equipment Setup.

The first, and perhaps most important, step toward accurate sound measurements is the proper setup of the equipment. As we have seen, both the measuring instruments and the observer can have considerable effect on free-field measurements, and while the effect is much less for diffuse-field measurements, good practice dictates the use of care here as well. Assuming then that we have the indicating instruments well out of the way, we need consider only the microphone support. In the case of a tripod, measurement accuracy is affected by less than 2 dB for free-field measurements, negligibly for diffuse-field measurements.

b. Microphone Correction Factor.

Acoustic measuring equipment is calibrated on the basis of the nominal sensitivity of a given size microphone, e. g. 5 mV/ μ bar for 1-in. condenser microphones,

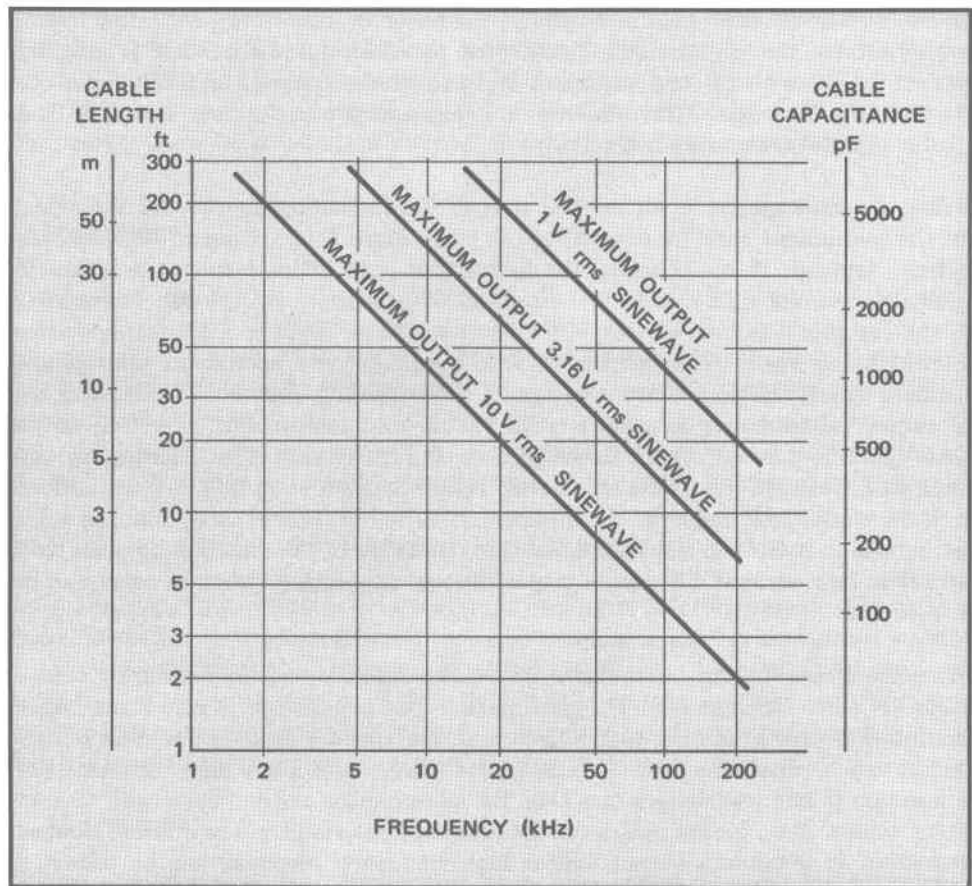

Figure 20. Cable length versus frequency and output level for HP microphones.

1.58 mV/ μ bar for $\frac{1}{2}$ -in. condenser microphones. However, due to manufacturing tolerances of the cartridge itself plus the attenuating effect of the input capacitance of the associated preamplifier (small compared to the manufacturing tolerances), the sensitivity of the microphone assembly is seldom the same as the nominal sensitivity. Deviation from nominal sensitivity ranges from +1 to -4.5 dB. Fortunately, this deviation is independent of frequency. Each HP microphone is calibrated at 250 Hz, and the deviation is noted in a calibration report which is furnished with the microphone. The figure in the report is called the microphone correction factor and carries a polarity sign opposite to that of the actual deviation from nominal sensitivity. Thus the microphone correction factor indicates the actual correction which must be made to the measurement.

Calibration of HP microphones is accurate within ± 0.2 dB at the calibrating frequency. However, it is inconvenient to have to add the correction to each and every measurement, so HP has added a microphone correction factor switch to its various acoustic instruments. This switch permits you to change instrument calibration in 0.5-dB steps from -1 to +4.5 dB. The indicating instrument thus remains calibrated and its readings can be used directly. In the worst possible case, instrument indication (excluding instrument error, which is discussed later) is off only 0.45 dB. In practice, the error is usually much lower, typically less than 0.2 dB. We shall use this figure for the purpose of determining overall accuracy.

c. Frequency Response.

Frequency response curves, as well as the microphone correction factor are supplied with each microphone assembly. Two response curves are furnished: pressure response and frontal free-field response. The pressure response curve is plotted automatically using the electrostatic actuator. Since the measurement is relative rather than absolute, the only errors involved are the repeatability of the measurement and the resolution of the graph. Quality instrumentation virtually eliminates the repeatability error, while the scale factor of the graph ensures a resolution error no greater than 0.2 dB.

The frontal free-field curve is hand-drawn. The curve is derived from the pressure curve and known correction data for the particular microphone configuration. The error here then is the sum of the pressure-curve error and any error in drawing the free-field curve. Again it's a question of resolution. Thus where the two curves are identical, the maximum total error is 0.2 dB; where they differ, 0.4 dB.

Use of these curves implies a knowledge of the frequency distribution of the sound being measured either because of its limited frequency range or because of the use of filters. For broad-band measurements the full variation of microphone response must be considered. For the HP 15119A $\frac{1}{2}$ -in. Microphone Assembly, this variation is only ± 1 dB from 20 Hz to 20 kHz; for the HP 15109B 1-in. Microphone Assembly, ± 1.5 dB from 20 Hz to 16 kHz, $+ 0, - 3$ dB from 16 to 18 kHz.

d. Type of Field and Orientation.

The above discussion of frequency response deals only with frontal free-field measurements. However, many measurements, particularly those indoors, are in diffuse fields, and not all free-field measurements are with frontal incidence. As we have seen, even omni-directional microphones exhibit some directional qualities at higher frequencies, so we must account for these in our measurements. Curves for the HP microphones are shown in Figure 19. Note that these data are given as corrections to the frontal free-field response, so we must again add an error for chart resolution. However, there are additional factors. For free-field measurements, it is often difficult to determine the exact angle of incidence. Since the rectangular presentation cannot show every angle and the polar plots cannot show every frequency, there is also the problem of interpolation. In the case of diffuse-field measurements, the problem is that the field is seldom ideally diffuse, and estimating the degree of diffuseness and making an appropriate correction is virtually impossible. At frequencies where corrections are required then, the best accuracy that we can expect is about ± 2 dB. Again, this applies to single-frequency or narrow-band measurements. For broad-band measurements, the error can be up to the full value of the correction indicated by the curves.

e. Absence of the Observer.

We have noted the effect an observer has on a sound field and have strongly recommended that he remove himself from the vicinity of the microphone while measurements are being made. Yet we are trying to measure the sound an observer would hear if he were present. This sounds paradoxical, and it is. On the other hand, it is important that measurements be repeatable, that is, similar equipment should give similar results under similar conditions. The problem of the observer is that there is no guarantee that any two will be similar; there is no standard observer. Therefore, measurements are made with the observer absent, and the

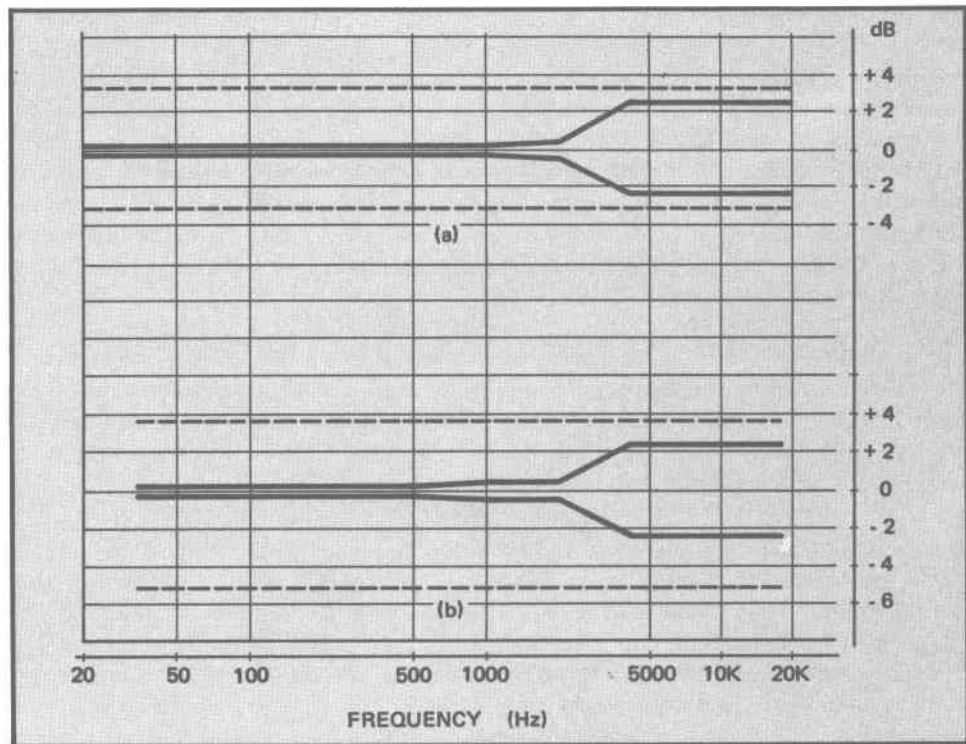

Figure 21. Accuracy of microphone output for free-field measurements using 15119A (a) and 15109B (b) on a tripod. Solid lines show narrow-band accuracy; dashed lines, broad-band accuracy.

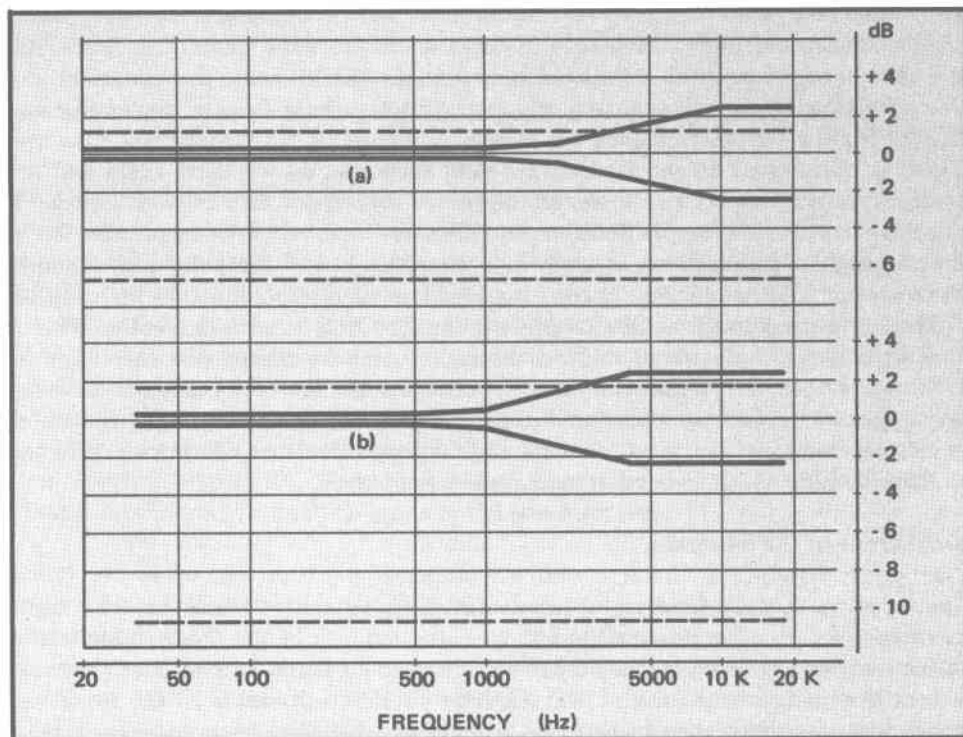

Figure 22. Accuracy of microphone output for diffuse-field measurements, using 15119A (a) and 15109B (b) on a tripod. Solid lines show narrow-band accuracy; dashed lines, broad-band accuracy.

results are equated to what an average observer would hear. This is done automatically with weighting curves and correction factors designed into the indicating equipment and is discussed below along with the instrumentation.

f. Overall Accuracy.

Figures 21 and 22 sum up the various factors discussed above and show the accuracy which we can expect from HP microphones for frontal free-field and diffuse-field measurements. The figures do not include instrumentation error. They do show that a series of narrow-band measurements provides much greater accuracy than a single broad-band measurement. In addition, narrow-band measurements better enable us to equate the measured sound to our subjective sensation of hearing. Of course, broad-band measurements may be made for reasons of simplicity, convenience, or economy. In any event, the observer should be aware of the nature and degree of any errors to properly evaluate his measurements.

SOUND LEVEL METERS

Now that the sound signal is in electrical form, we need to process it in a meaningful way. As noted in Section IV, the sound level meter was among the first instruments developed to provide any correlation between an objective measurement and the subjective sensation of hearing, and so we shall start with the sound level meter here.

A. FREQUENCY RESPONSE.

The sound level meter is basically an audio rms voltmeter. In measuring the electrical signal from the microphone, then, it provides a measure of a physical quantity: sound pressure. This fact is important in evaluating the sound level meter. The sound level meter differs from a voltmeter in that the frequency response of a voltmeter is made as flat as possible, while that of the sound level meter is deliberately altered by weighting networks to account, to a first-order approximation, for the frequency response of the ear. Actually, three frequency-response curves have been standardized because the response of the ear depends upon pressure level as well as frequency. These are the so-called A, B, and C curves and approximate the inverse of the 40-, 70-, and 100-phon equal loudness curves of Figure 1 in Section III.

The three most widely used standards describing sound level meters are IEC Publication 123, "Recommendation for Sound Level Meters", IEC Publication 179, "Precision Sound Level Meter", and USA Standard S1.4-1961, "Specification for General-Purpose Sound Level Meters". It might be well to take a look at these standards and note their similarities and differences.

All three standards specify virtually the same A, B, and C curves, and all three state that the tolerances for the curves relate to the entire system, i. e. microphone, attenuator, amplifier, weighting networks, and indicator (meter). All three are also fairly imprecise regarding the effects of extraneous factors such as temperature, humidity, EMI, etc. In general, the standards require the manufacturer to state the range for such factors over which instrument accuracy is not adversely affected. IEC 179 is best in this regard.

At this point the standards diverge. The curves and tolerances in IEC 123 specify

performance in absolute terms, i. e. with respect to a true sound pressure level. The curves in IEC 179 and S1.4-1961 are simple frequency response curves providing only relative data. In addition, the A and B curves in S1.4-1961 are relative to the C curve, so the tolerances specified for the A and B curves must be added to those of the C curve. Table 6 lists values and tolerances for all three standards. (The tolerances for the A and B curves under S1.4-1961 are the total tolerances.)

The problem now is to get from these data to a set of figures for absolute accuracy. Both IEC 179 and S1.4-1961 allow a ± 1 dB tolerance for absolute calibration at a reference frequency. All three standards provide tolerances for making measurements at sound pressure levels different from the calibration level. Included are range errors in the attenuator and meter (indicator) calibration and resolution errors. Table 7 summarizes these factors. The total additional tolerance shown in Table 7 must be added to the tolerances of Table 6 to obtain overall performance. We must remember that these curves show the worst possible case and that even instruments with relatively loose specification yield better accuracy most of the time. Nevertheless, in evaluating the standards, we must allow for the worst case.

In looking at the level of performance required by the standards, we can see that IEC 179 does indeed specify tighter tolerances than IEC 123. Comparing these with S1.4-1961 is a little trickier because in S1.4-1961 the tolerances are different for each curve and because S1.4-1961 specifies diffuse-field response while the IEC standards specify free-field response. Strictly on the basis of tolerances, it appears that S1.4-1961 falls somewhere between IEC 123 and 179. While it is true that S1.4-1961 has tighter specifications at the low-frequency end of the B and C curves, these specifications are fairly easy to meet here. Microphone frequency response is no problem at low frequencies, and the small slope of the curves does not demand particularly stringent circuit parameters. The A curve is another matter, and here IEC 179 demands equal or better performance over the entire range except at 25 Hz. The IEC 179 standard also requires a wider frequency range: 12.5 kHz vs 10 kHz for S1.4-1961. On the other hand, S1.4-1961 requires that the sound level meter include all three weighting networks, while both IEC standards require only one. (It is interesting to note at this point that many of the new measurement specifications under consideration — e. g. vehicle noise measurement — require only a single weighted response, and the A response is usually the one which is chosen.)

When we include the type of sound field in our comparison of S1.4-1961 and IEC 179, things get a little tougher. Perhaps it is best to see if an instrument can meet both specifications. If we start with an instrument that meets IEC 179 (and includes all three weighting networks), it looks like the only problem is the diffuse-field characteristics of the microphone. (We are assuming that if an instrument meets the A-curve tolerances of IEC 179 it also meets the B- and C-curve tolerances of S1.4-1961 as discussed above.) As shown in Figure 19, the diffuse-field characteristics come into play only at the higher frequencies; this fact undoubtedly accounts for the relatively loose tolerances in S1.4-1961 above 2 kHz. To see if our IEC 179 instrument also meets S1.4-1961, we need only add the diffuse-field data for the microphone to the IEC frequency-response data and see if the total remains within the S1.4-1961 limits. If our precision sound level meter includes the HP 15119A $\frac{1}{2}$ -in. Condenser Microphone, it does meet the S1.4-1961 standard; with the HP 15109B 1-in. Condenser Microphone, it does not. Going the other way, we cannot state categorically that a sound level meter that meets the requirements of S1.4-1961 also meets IEC 179. Even allowing that the free-field response of a microphone is much flatter than the diffuse-field response (eliminat-

Frequency (Hz)	IEC 123 (dB)			IEC 179 (dB)			S1.4 - 1961 (dB)		
	Curve A (dB)	Curve B (dB)	Curve C (dB)	Curve A (dB)	Curve B (dB)	Curve C (dB)	Curve A (dB)	Curve B (dB)	Curve C (dB)
20	-50.5	-24.2	-6.2	±5	±5	±5	-	-	+3, -∞
25	-44.7	-20.4	-4.4	±5	±5	±5	+4, -4.5	+3, -3.5	+2, -2.5
31.5	-39.4	-17.1	-3.0	±5	±3	±3	+3.5, -4	+2.5, -3	+1.5, -2
40	-34.6	-14.2	-2.0	±4.5	±3	±3	+3, -3.5	+2, -2.5	+1, -1.5
50	-30.2	-11.6	-1.3	±4	±3	±3	±3	±2	±1
63	-26.2	-9.3	-0.8	±4	±3	±3	±3	±2	±1
80	-22.5	-7.4	-0.5	±3.5	±2	±2	±3	±2	±1
100	-19.1	-5.6	-0.3	±3.5	±1	±1	±2.5	±2	±1
125	-16.1	-4.2	-0.2	±3	±1	±1	±2.5	±2	±1
160	-13.4	-3.0	-0.1	±3	±1	±1	±2.5	±1.5	±1
200	-10.9	-2.0	0	±3	±1	±1	±2.5	±1.5	±1
250	-8.6	-1.3	0	±3	±1	±1	±2.5	±1.5	±1
315	-6.6	-0.8	0	±3	±1	±1	±2	±1.5	±1
400	-4.8	-0.5	0	±3	±1	±1	±2	±1.5	±1
500	-3.2	-0.3	0	±3	±1	±1	±2	±1.5	±1
630	-1.9	-0.1	0	±3	±1	±1	±2	±1.5	±1
800	-0.8	0	0	±2.5	±1	±1	±1.5	±1.5	±1
1000	0	0	0	±2	±1	±1	±2	±2	±1.5
1250	0.6	0	0	±2.5	±1	±1	±2	±2	±1.5
1600	1.0	0	-0.1	±3	±1	±1	±2.5	±2.5	±2
2000	1.2	-0.1	-0.2	±3	±1	±1	±3	±3	±2.5
2500	1.3	-0.2	-0.3	+4, -3	±1	±1	+4, -3.5	+4, -3.5	+3.5, -3
3150	1.2	-0.4	-0.5	+5, -3.5	±1	±1	+5, -4	+5, -4	+4.5, -3.5
4000	1.0	-0.7	-0.8	+5.5, -4	±1	±1	+5.5, -4.5	+5.5, -4.5	+5, -4
5000	0.5	-1.2	-1.3	+5, -4.5	±1.5	±1.5	+6, -5	+6, -5	+5.5, -4.5
6300	-0.1	-1.9	-2.0	+6, -5	±1.5, -2	±1.5, -2	+6.5, -5.5	+6.5, -5.5	+6, -5
8000	-1.1	-2.9	-3.0	±6	+1.5, -3	+1.5, -3	±6.5	±6.5	±6
10 000	-2.5	-4.3	-4.4	+6, -∞	+2, -4	+2, -4	-	-	+6, -∞
12 500	-4.3	-6.1	-6.2	+6, -∞	+3, -6	+3, -6	-	-	-

Table 6. Responses and associated tolerances.

	IEC 123	IEC 179	S1.4-1961
Frequency Range (Hz)	31.5 to 8000	20 to 12 500	20 to 10 000
Frequency Response	One network required (A, B, or C)	One network required (A, B, or C)	Three networks required (A, B, and C)
Frequency Response Calibration	Absolute (free field)	Relative (free field)	Relative (diffuse field)
Tolerance for Absolute Calibration	---	± 1 dB	± 1 dB
Preferred Calibrating Frequency	---	1 kHz	400 Hz
Additional Tolerance for Range Change	± 1 dB	± 0.5 dB	± 1 dB (± 0.5 dB between adjacent ranges)
Additional Tolerance for Meter Accuracy and Resolution	± 1 dB	± 0.4 dB	± 0.5 dB
Total Additional Tolerance for Absolute Accuracy	± 2 dB	± 1.9 dB	± 2.5 dB

Table 7. Summary of standards requirements.

ing the broad tolerances at the high-frequency end), the mid-frequency tolerances of S1.4-1961 are too broad for the A and B curves. In summary, we can say that IEC 123 is a loose standard, IEC 179 somewhat tighter, and S1.4-1961 in between.

All three standards recognize that sound level measurements with the specified instruments are at best first-order approximations of our sense of hearing. Nevertheless, these standards have established limitations within which we can compare measurements made at different times, in different places, with different equipment. As instrumentation improves, the standards will undoubtedly reduce the tolerances, so accuracy in a sound level meter is indeed important.

The standards specify performance for the whole system: microphone and preamplifier, attenuator, weighting networks, amplifier, and indicator (meter). However, in practice the microphone is not always an integral part of the sound level meter but is connected to the rest of the system with a cable. We have seen that this is desirable, particularly in free-field measurements, in order to remove the indicating unit from the sound field. In such cases, the microphone usually can be detached from the indicating unit, so a variety of microphone-meter combinations can be used. For this reason it is desirable to specify the performance of the microphone and indicating unit separately. (Henceforth the term "sound level meter" or "precision sound level meter" means the attenuator, weighting networks, amplifier, and indicator but not the microphone.) Let's then take a look at a sound level meter and see what sort of performance is available.

The Hewlett-Packard 8052A Impulse Sound Level Meter, shown in Figure 23, includes all three weighting networks (plus provision for connecting an external filter). Although IEC 179 requires only one, it stipulates that where more than one network is present, all must conform. Figure 24 is a drawing of an actual recording of the overall frequency response of a typical 8052A using the C network. (The signal for the logarithmic recorder was taken from the 8052A dc output, which is proportional to meter deflection.) Comparing this curve with the standard curve shows agreement within 0.1 dB over the mid-range and within 0.3 dB at higher and lower frequencies except 0.5 dB below about 40 Hz. Recordings of all three weighting networks are shown in Figure 25, and although the scale is compressed, disagreement with the standard curves is never more than 0.5 dB and is considerably less at mid-frequencies.

As a matter of interest, we might add the microphone response to these curves and see what we get. Figure 26 a shows both the 8052A C response curve and the C-weighted pressure response of an HP 15119A 1/2-in. Condenser Microphone attached to the 8052A. The electrostatic actuator was used to drive the microphone. In Figure 26 b, the pressure response is corrected to show the C-weighted frontal free-field and diffuse-field responses as well as the standard C curve. These curves show that this microphone-meter combination satisfies the frequency-response requirements of both IEC 179 and S1.4-1961.

The 8052A is a high-quality audio voltmeter as well as a precision sound level meter. As a voltmeter, its overall accuracy is 0.5 dB, a significant fact because this figure is the sum of the tolerances for the attenuator, amplifier, and indicator (meter). The standards, as we have seen, allow considerably more latitude: 0.9 dB for IEC 179 and 1.5 dB for S1.4-1961. If we can then provide absolute calibration of the system in the field with an error of less than ± 0.5 dB (not at all unreasonable with today's pistonphones and sound level calibrators), instrumentation errors can be held to about ± 1 dB at any frequency.

Figure 23. HP Impulse Sound Level Meters. The two are similar except that the 8062A can be operated from internal batteries as well as from the power line.

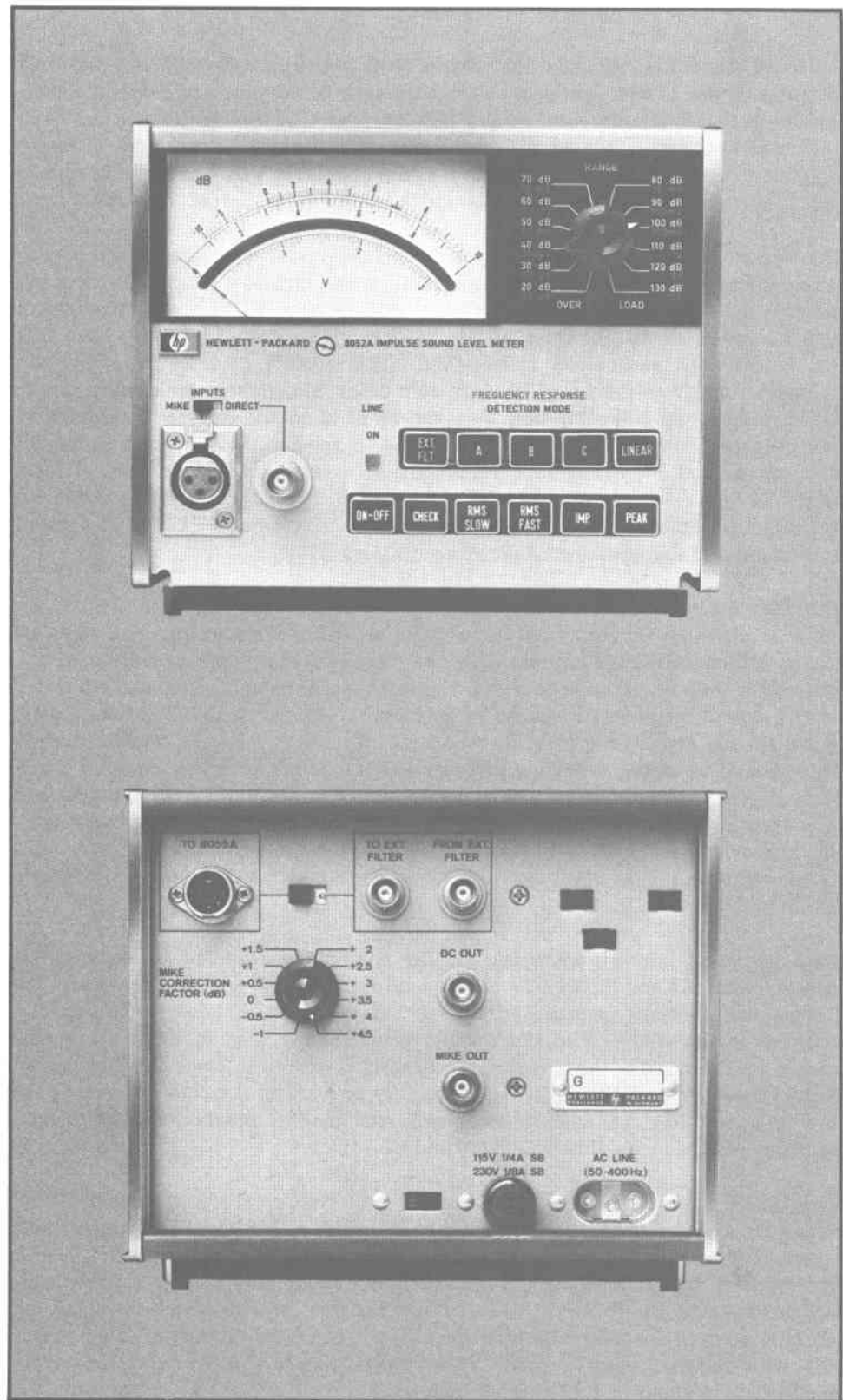

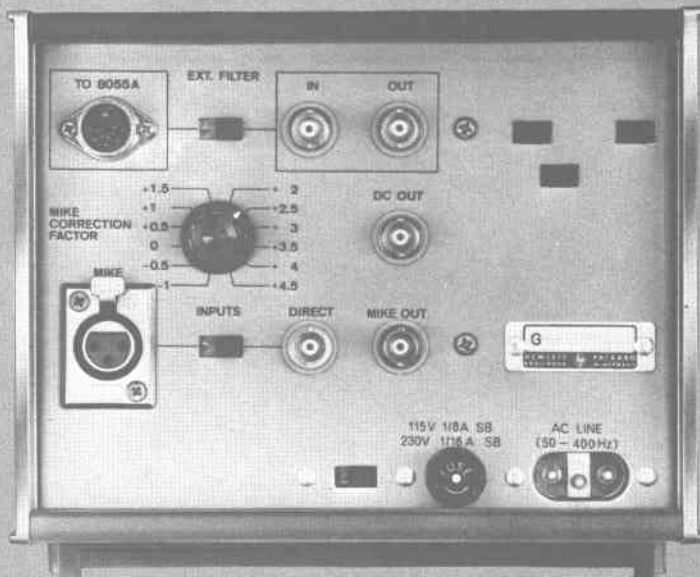
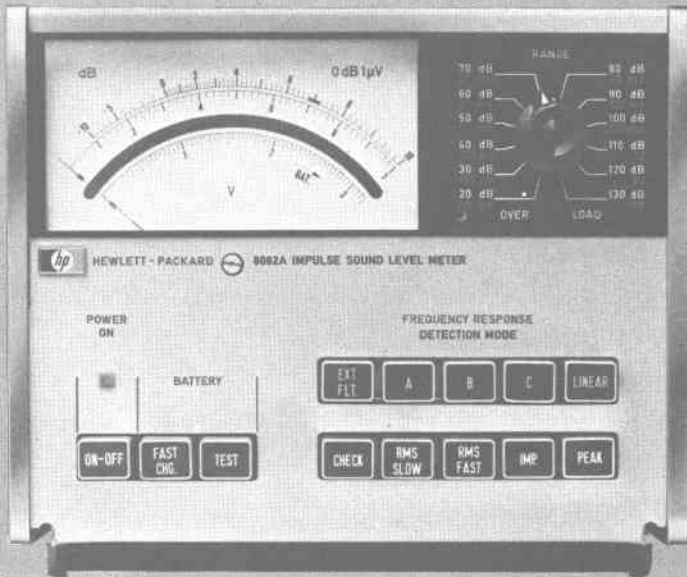

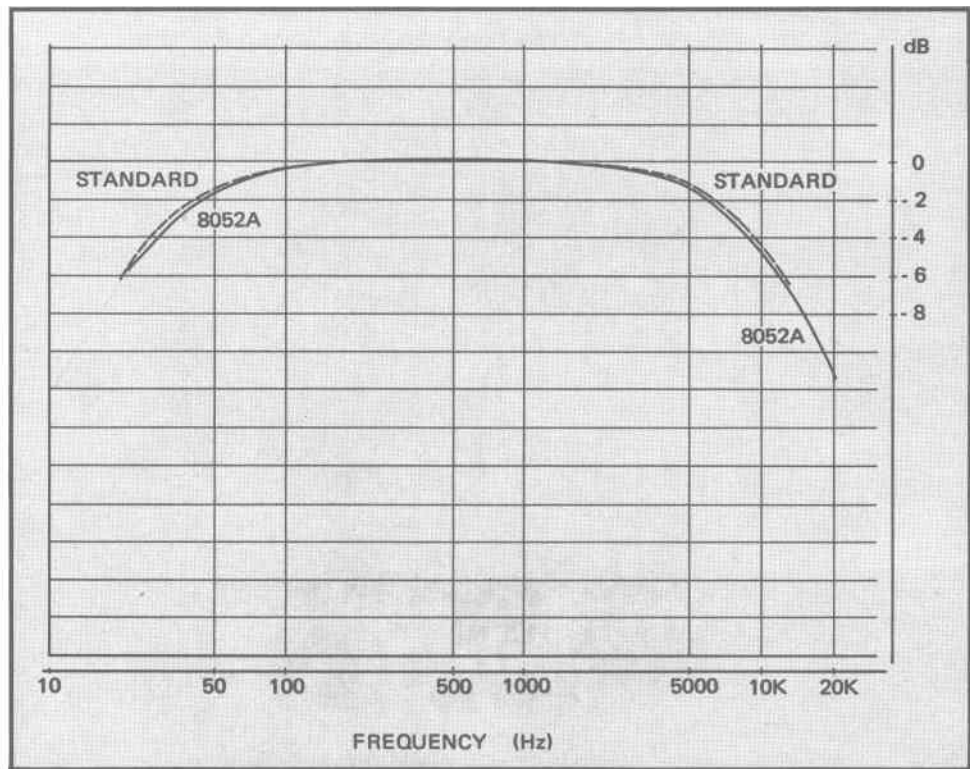

Figure 24. Overall frequency response of a typical HP 8052A using the C weighting network.

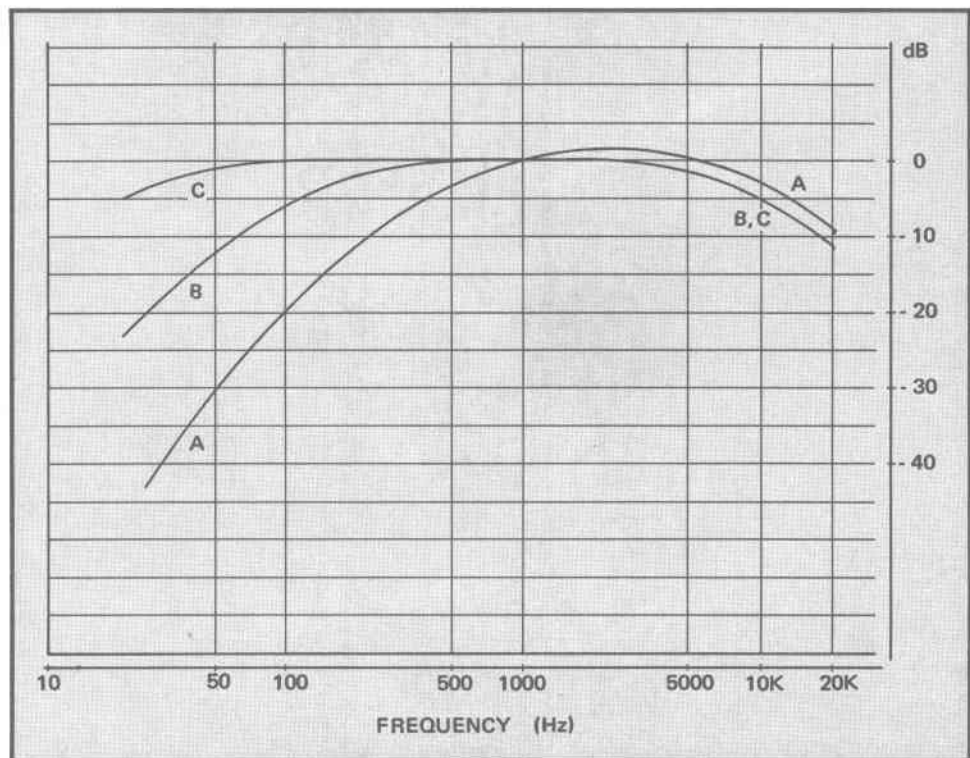

Figure 25. Frequency response of A, B, and C weighting networks typical of HP 8052A.

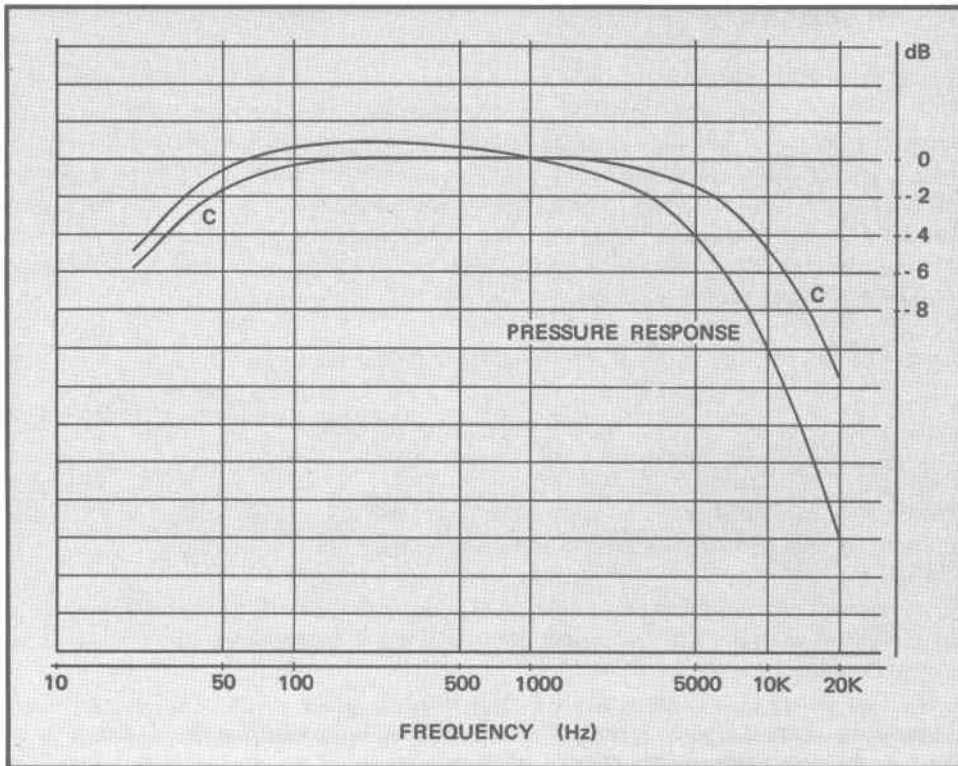

Figure 26.a. C-weighted pressure response of HP 15119A 1/2-in. Microphone attached to 8052A Impulse Sound Level Meter and typical C curve of 8052A alone.

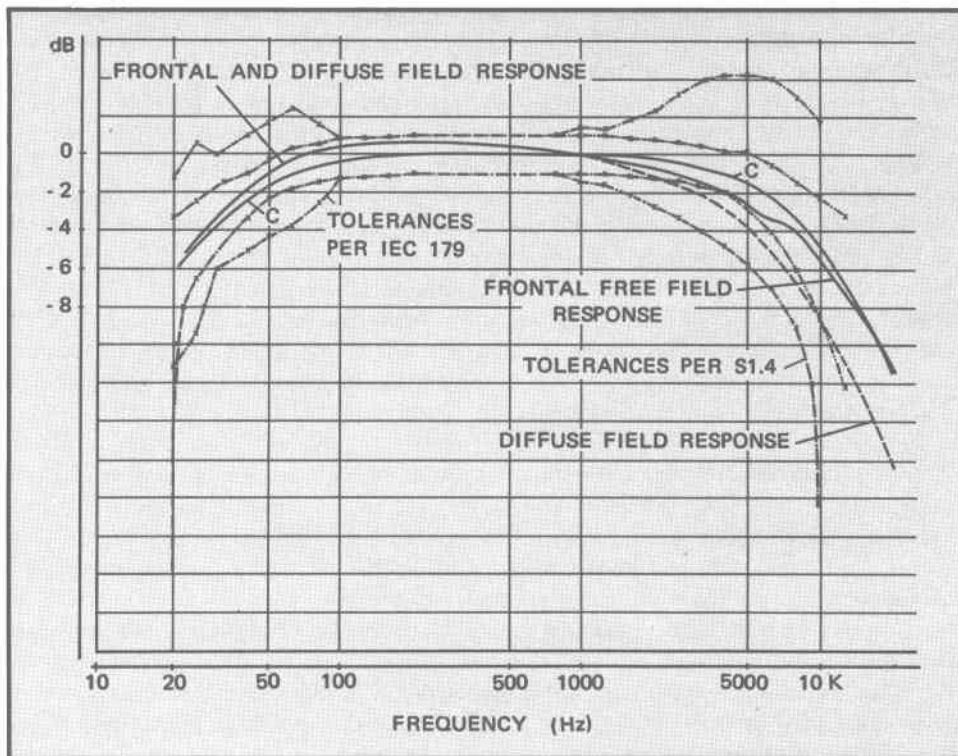

Figure 26.b. Frontal free-field and diffuse-field response of same combination and typical 8052A C curve.

B. RMS DETECTION.

There is more to accurate acoustic measurements than proper frequency response. The detection mode and the dynamic characteristics of the sound level meter are equally important. The detection mode is dictated by the manner in which we hear and measure sound. Our subjective reaction to sound is in proportion to its intensity (analogous to electrical power) while we measure sound pressure or sound pressure level (analogous to voltage). To easily equate one with the other, then, we must measure rms values to avoid errors when the sound signal deviates from a pure, continuous-wave sinusoid.

By definition, the rms value of the signal from the microphone is

$$V_{\text{rms}} = \left(\frac{1}{T} \int_0^T V^2 dt \right)^{1/2} \quad (8)$$

where V is the instantaneous value of the microphone output voltage and T is the interval of time over which the integration is carried out.

Our rms detector must therefore include a squaring circuit, an integrator, and a root extraction network. In the 8052A, all three functions are carried out in a single circuit.

Since many sound signals are non-sinusoidal, it is important for the detector to be able to handle a relatively high crest factor (ratio of peak to rms voltage). For example, Figure 27 shows waveforms with the same rms value but with different crest factors. The upper signal has a crest factor of only two; the lower, three. Now the curve of input current vs crest factor for an rms detector is a square-law function as shown in Figure 28. This means that as the instantaneous value of the input signal increases, the current into the detector must increase as the square. Many circuits have been developed to approximate the square-law function, but perhaps the most widely used circuit is the so-called quasi-rms detector shown in Figure 29. In this detector the integrating capacitor biases the rectifier so that no current flows until the absolute value of the input signal exceeds the voltage on the capacitor. Above this point, there is a linear relationship between the input signal and detector current. By appropriate selection of component values, deviation from the ideal is held within acceptable limits (usually ± 1 dB) up to a crest factor of three, as shown in Figure 30. Although neither the IEC nor the US standards directly specify the crest-factor capability of the rms detector, they do so indirectly by specifying overall operating characteristics and test methods. The quasi-rms detector more than satisfies the requirements.

Actually, both the IEC and US standards are extremely lenient in their calibration requirements. The IEC standards specify the two-tone method in which two electrical sinusoidal signals not harmonically related are applied to the sound level meter, first separately and then simultaneously. The first step permits adjustment of the two signals for identical readings on the meter. IEC 123 requires that the reading in step 2 be $3 \text{ dB} \pm 0.25 \text{ dB}$ greater than in step 1, while IEC 179 stipulates that the second reading equal the first when each signal is attenuated $3 \text{ dB} \pm 0.1 \text{ dB}$. The US standard calls for calibration using only the C network (unless otherwise indicated) and recommends a method comparing readings made first with a pure tone and then with broad-band noise. In any case, a fairly simple detector meets the requirements, and since symmetrical signals are used, the detector doesn't even need a full-wave rectifier. The best signals for testing rms detectors

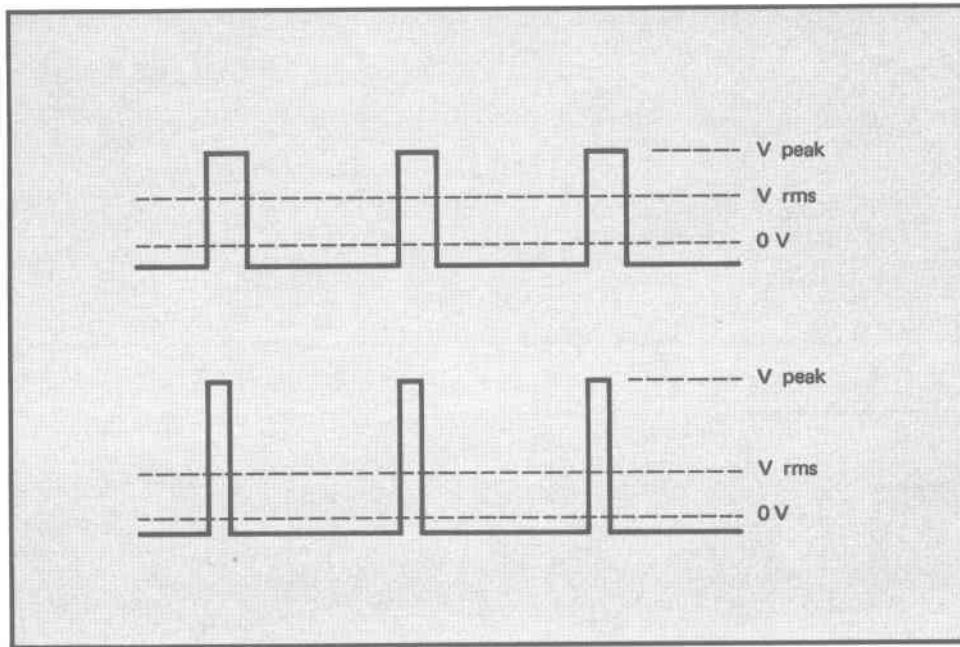

Figure 27. Pulse waveform having the same rms value but different crest factors (ac coupling makes the 0-volt level different from the baseline level for the pulse waveform). The upper waveform has a crest factor of 2, the lower of 3.

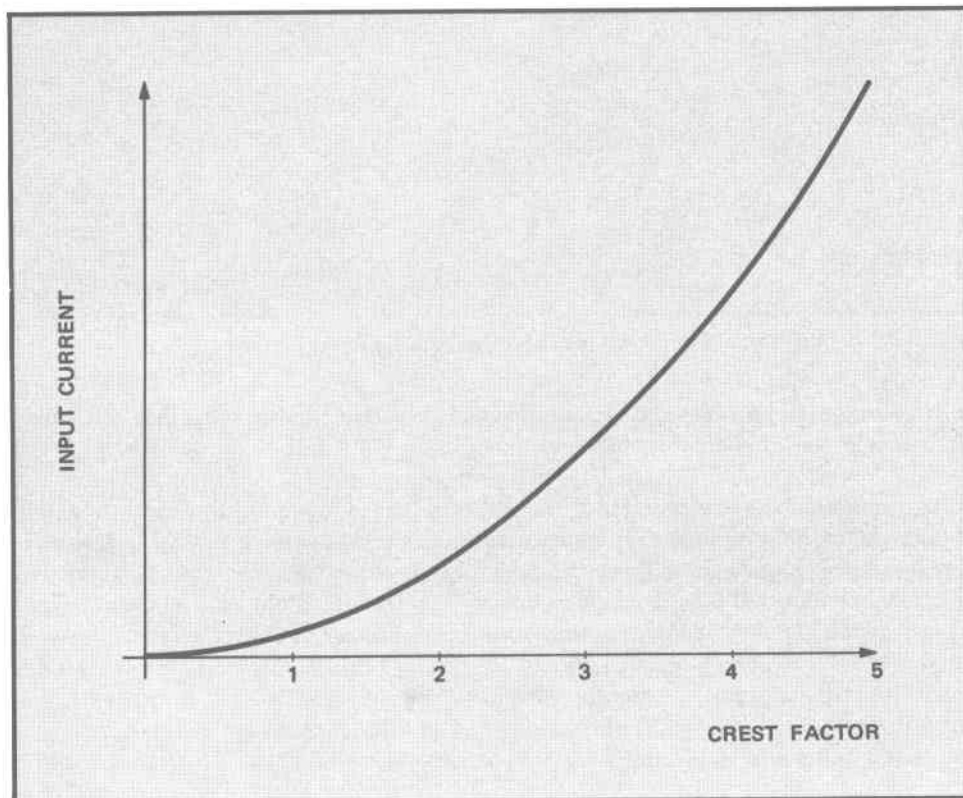

Figure 28. Input current versus crest factor for a true rms detector.

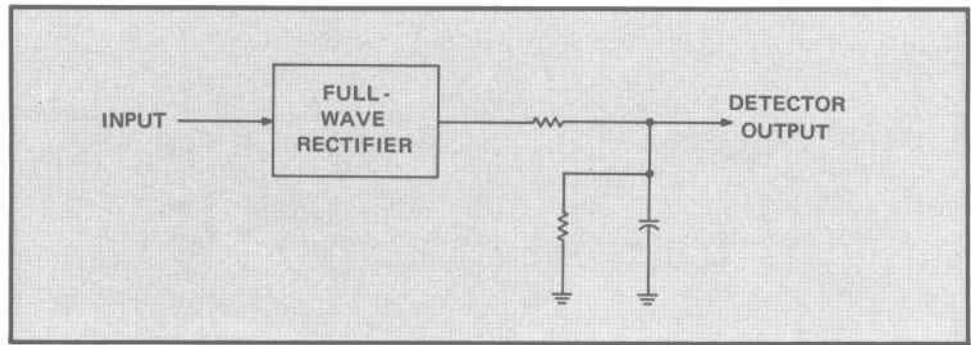

Figure 29. Quasi-rms detector.

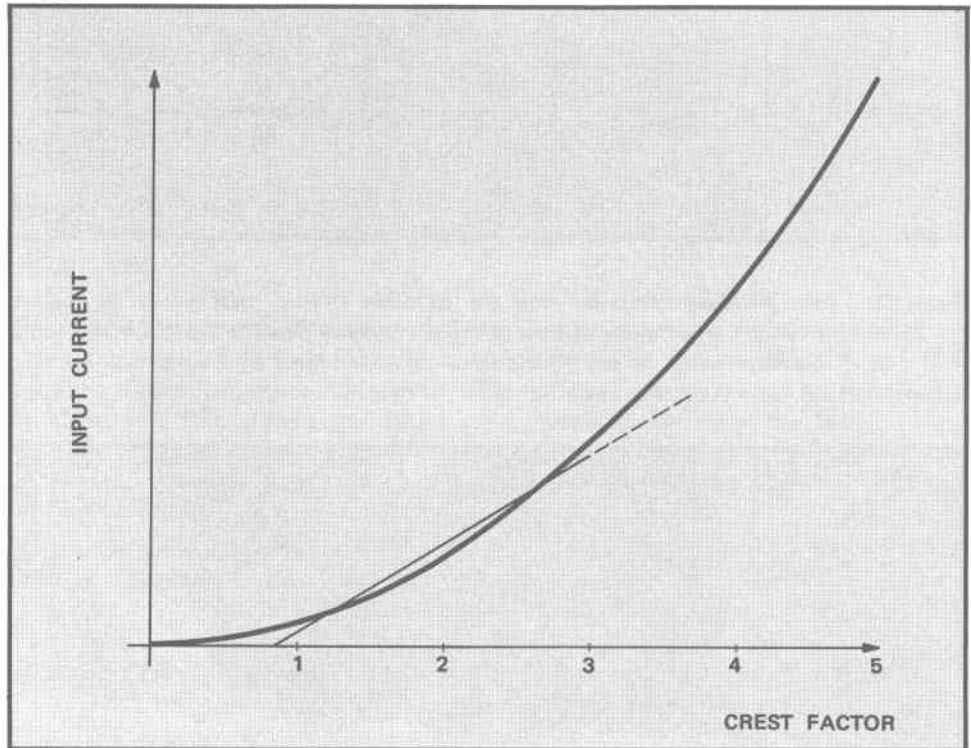

Figure 30. Comparison of true rms and quasi-rms detector characteristics.

are rectangular pulses with variable crest factor and polarity together with tone bursts with variable crest factor⁶.

Unfortunately, the simple quasi-rms detector is inadequate for today's needs. Many of the sounds presently being scrutinized are impulsive in nature and have crest factors higher than three. Such sounds include hammer blows, typewriter clatter, etc. The HP 8052A Impulse Sound Level Meter includes a more elaborate detector, shown in Figure 31, which breaks the linear function of the quasi-rms detector into four segments as shown in Figure 32. In this circuit the integrating capacitor (the capacitor in the diagram) provides a sliding bias for both the rectifier and the squaring diodes CR1 through CR3. The crest factor required to turn on the squaring diodes is determined by the resistive divider networks. As each diode

⁶ An excellent article describing methods for checking rms detectors appeared in the *Bruel & Kjaer Technical Review*, No. 1, 1963.

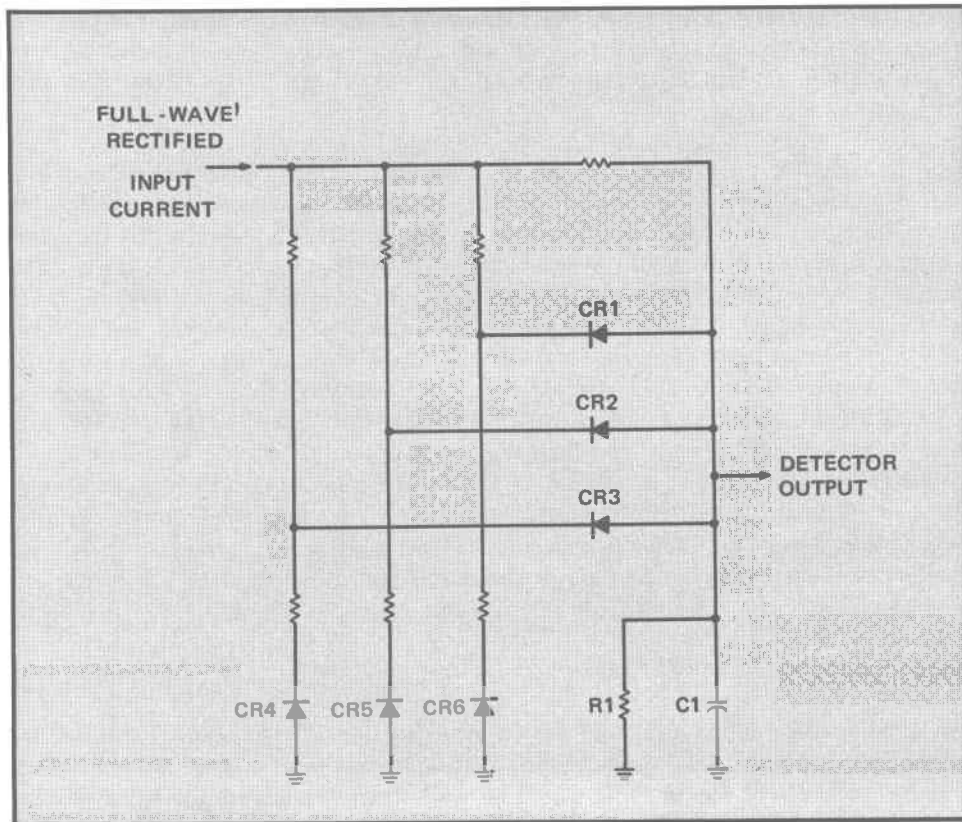

Figure 31. Squaring circuit of 8052A/8062A rms detector.

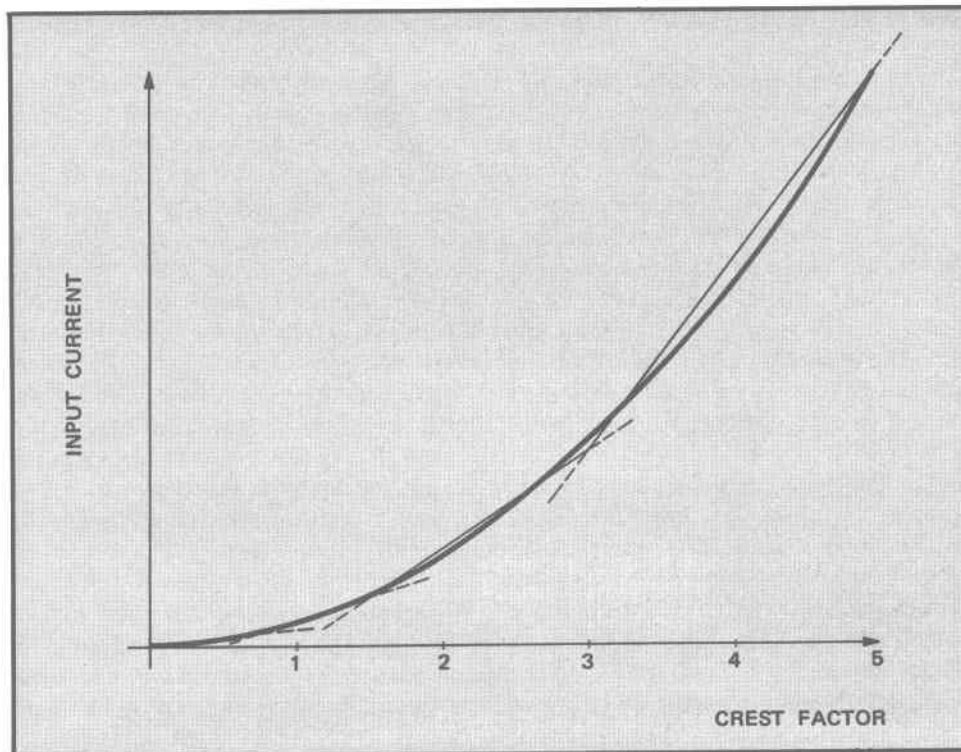

Figure 32. Comparison of true and 8052A/8062A rms detector characteristics.

turns on, the resistance between the rectifier and integrating capacitor is reduced, increasing the current into the capacitor. With such a circuit, the HP Impulse Sound Level Meters can handle crest factors up to five with accuracy affected less than ± 0.5 dB.

The linearity of the detector is also a factor in accuracy, although only at low signal levels at which the diodes become nonlinear resistances. It's possible to alter the meter scale to account for this non-linearity or to linearize the detector. In general, sound level meters have special meter scales; the HP 8052A has a linear detector. (Linearity in this sense refers to the relationship between the rms value of the input signal and the detector output, not to be confused with the square-law relationship between crest factor and detector current.) Figure 31 shows the compensation diodes in the squaring circuit of the 8052A detector. These diodes, CR4 thru CR6, make the resistive voltage dividers non-linear at low signal levels and so compensate for the non-linearity of the squaring diodes. In addition, the full-wave-rectifier diodes are incorporated in operational amplifiers and thereby behave as ideal diodes. The primary advantage of the linear detector is that the signal that drives the meter can be used to drive external devices such as level recorders, greatly simplifying their requirements (see Level Recorders below).

C. DYNAMIC CHARACTERISTICS.

So far we have called our detector an rms detector. To be more accurate, we should call it an RC averaging detector with a built-in mechanism for approximating the parabola of Figure 28. It would be well, then, to compare the RC averaging detector with an integrating detector (ignoring any consideration of rms behavior) and note the differences. For the purpose of the comparison, refer to the simplified diagrams of Figure 33.

To start the integrator in Figure 33, we close the switch S1. The output of the integrator then increases as long as there is an input signal; the shape of the signal determines the rate of increase. If the input consists of the three tone bursts shown in Figure 34 a, the integrator output looks like Figure 34 b. To stop the process, we open S1; to start again, we must first discharge the integrating capacitor with S2 and then close S1. Note that the output of the integrator only increases in value. But equation (8) includes a $1/T$ factor, which means that the integrator output should have decreased between the tone bursts and exponentially returned to zero after the last burst. Thus we must supply the $1/T$ factor by determining the time S1 is closed and providing the appropriate scale factor for the readout device. To obtain a true rms value, the integration time must be exactly one period of the signal or long compared to one period. But many signals are not periodic — e. g. the three-burst signal of Figure 34 a — and even if they are, we have no guarantee what the period will be ahead of time. So we are left with the choice of a long integrating time. How long? An extremely long integrating time, say 20 seconds, gives us only one reading every 20 seconds, hardly a continuous evaluation of the signal. In addition, we can get no idea of the character of the sound, i. e. whether it is constant, slowly varying, or impulsive. If we reduce the integrating time to 1 second, still nowhere near a continuous monitoring of the signal, we are reaching the point at which the integrating time is not sufficiently long compared to the period of a low-frequency signal (e. g. for a 10-Hz square wave, we can get a 5% error if we measure $9\frac{1}{2}$ instead of 10 periods).

Let's summarize our findings for the integrator: 1. The integrator inherently lacks

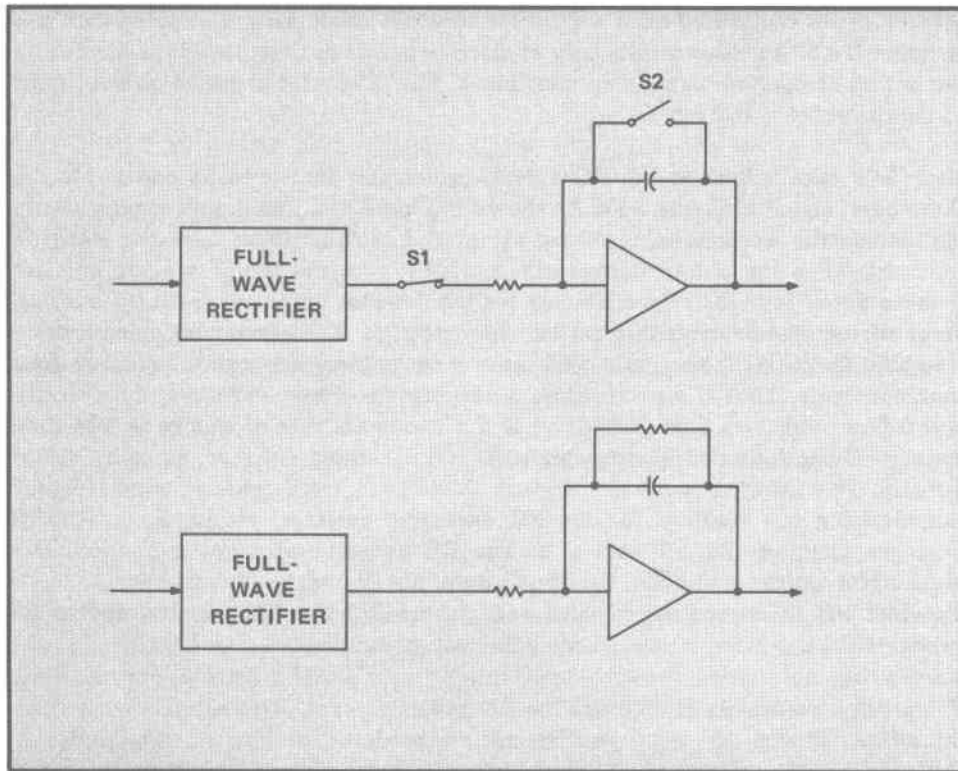

Figure 33. Simplified diagrams of integrating (upper) and RC averaging (lower) detectors.

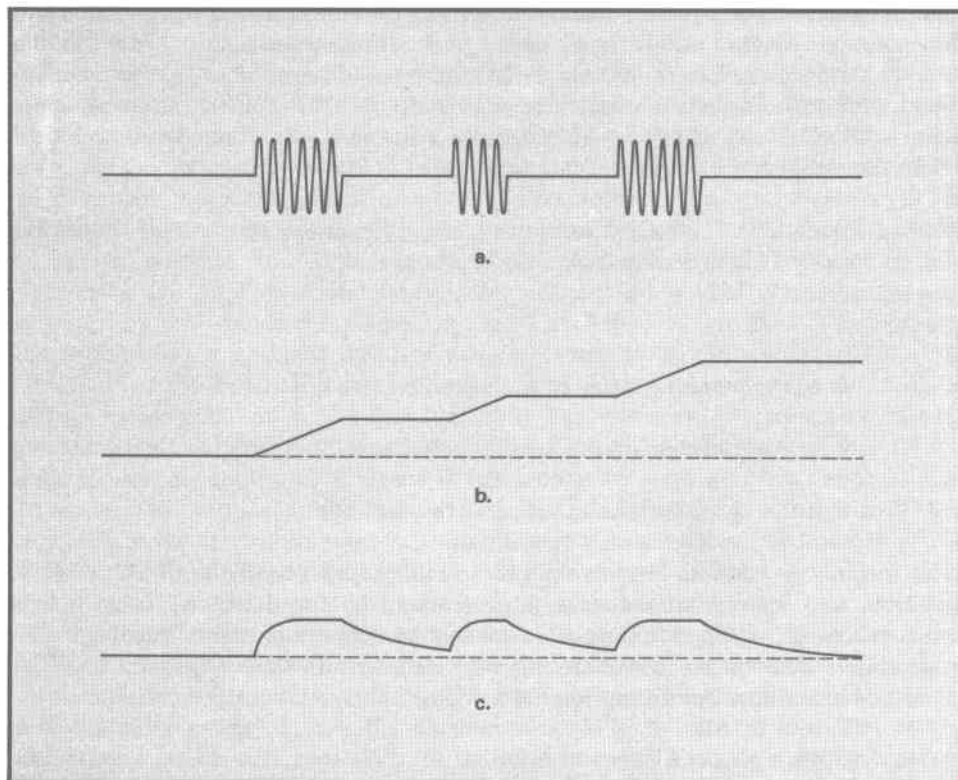

Figure 34. Input signal (a) versus output for Integrator (b) and RC averager (c).

the $1/T$ factor, which we must supply for true rms readings. 2. The integrator is a sampler, i. e. it provides results only at discrete points in time; results taken during the period of integration have no meaning. 3. The integrator provides no indication of the character of the sound.

Now let's take a look at the RC averaging detector in Figure 33 and apply the three-burst signal of Figure 34 a. As shown in Figure 34 c, the output exponentially approaches the average value of the signal and remains there until the signal is removed. Then the output decays exponentially until the signal is again applied. It takes about four RC time constants for the detector output to reach the average value of the signal. After this period, the output of the detector becomes a time-weighted function of the input with an averaging time somewhat less than four time constants. Thus if we substitute a varying signal for the bursts, the detector can follow with less than 1-dB error if the maximum rate of change is less than about 3 dB per apparent RC time constant.

Summarizing our findings for the RC averaging detector, we have: 1. The RC averager includes the $1/T$ factor. 2. The RC averager provides a continuously meaningful output provided the input does not fluctuate too rapidly. 3. If its apparent RC time constant is short enough, the RC averager can be used to investigate the character of sounds, even impulsive sounds.

Sound level meters invariably use the RC averaging type of rms detector, as does the 8052A. Indeed, the equivalent circuit of the detector shown in Figure 31 includes a squaring circuit, an RC averager, and a square-root circuit as shown in the block diagram of Figure 35. The averaging RC time constant in the equivalent circuit is equal to $1/2RC$ of Figure 31. The question, then, is the choice of apparent time constant RC. Again, the standards do not provide a direct answer. Instead, they stipulate overall sound level meter performance (designated "Fast" in the IEC standards) in response to a single 200-millisecond burst of a 1-kHz sinusoidal signal. IEC 179 requires the meter to read $1 \text{ dB} \pm 1 \text{ dB}$ below the steady-state value while IEC 123 and SI. 4-1961 require a meter reading between 0 and 4 dB below the steady-state value.

We can calculate the reduction in meter reading (from the steady-state value) for various apparent RC time constants from the formula

$$\Delta L = 10 \log (1 - e^{-t/c}) \quad (9)$$

where ΔL is the meter reading in dB below the steady-state value,

t is the duration of the tone burst, 200 milliseconds in this case, and

c is the apparent time constant of the detector.

(The formula is valid as long as the crest factor capability of the detector is not exceeded and instrument response is determined by the detector.) Table 8 lists some values of apparent time constants and corresponding meter readings. The table shows that the standards are not very definitive in their requirements. The standards also allow but do not require a "Slow" performance characteristic.

In response to a single 0.5-second burst of a 1-kHz tone, the sound level meter should indicate a nominal 4 dB below the steady-state value. IEC 179 puts a $\pm 1 \text{ dB}$ tolerance on the reading; IEC 123 and SI.4-1961, $\pm 2 \text{ dB}$. The Slow mode reduces

Time Constant c (ms)	Deviation ΔL (dB)
53	-0.1
100	-0.63
127	-1
200	-2
390	-4

Table 8. Apparent detector time constant vs meter reading below constant-tone value for single 200-millisecond tone burst.

meter jitter in measurements of rapidly varying sound fields by providing a longer averaging time. From equation 9, we get a nominal detector time constant of about 1 second.

How then do we measure truly impulsive sounds? Table 8 shows us that simply knowing that a sound level meter meets the standard is not very helpful. We must also know the detector time constant. But even then we run into trouble. Assuming that our sound level meter has a 127-millisecond time constant, we can predict performance only down to a deviation of -7 dB (30-millisecond tone burst). At this point the crest factor of the signal exceeds the tolerable limit (three) and/or the input amplifier is overloaded. The standards themselves recognize their limitations and explicitly point out that discontinuous sounds or sounds of very short duration should be measured by other means.

But sounds such as hammer blows and typewriter clatter can be as short as 5 milliseconds. It would seem that the solution is simply to determine the appropriate time constant (that of the human ear) and make it available in a sound level meter. Unfortunately, we cannot so conveniently categorize our subjective sense of hearing. The results in fact depend upon test methods and conditions, and the total spread is about three to one (35 to 100 milliseconds, approximately). The important thing is to standardize on some value that permits meaningful results when we measure impulsive sounds. A German standard (DIN 45 633 Part 2) describing the impulse sound level meter already exists. The dynamic response required by this standard is shown in Figure 36. Labeled "Impulse", this response corresponds to a nominal detector time constant of 35 milliseconds. This time constant, at the lower end of the range measured for the ear, imposes the least stringent demands upon the rms detector. For example, to measure a 5-millisecond tone burst, the detector with a 35 millisecond time constant need have a crest factor capability of 4 versus 6 for a detector with a 100-millisecond time constant. The impulse sound level meter, then, does indeed give meaningful and predictable results for sounds with intermittent bursts as short as 5 milliseconds. The HP 8052A includes Slow, Fast, and Impulse modes of operation.

The biggest problem in dealing with overall instrument response, even for a 200-millisecond tone burst, is not the detector time constant but rather the mechanical inertia of the meter movement. We can hardly expect an accurate reading if the meter pointer cannot follow the detector output. In the 8052A (per DIN 45 633, Part 2) the problem is solved by a peak detector and stretching circuit between the rms detector and the meter. The rise time of the peak detector/stretcher is short compared to the 35-millisecond time constant of the rms detector, and its

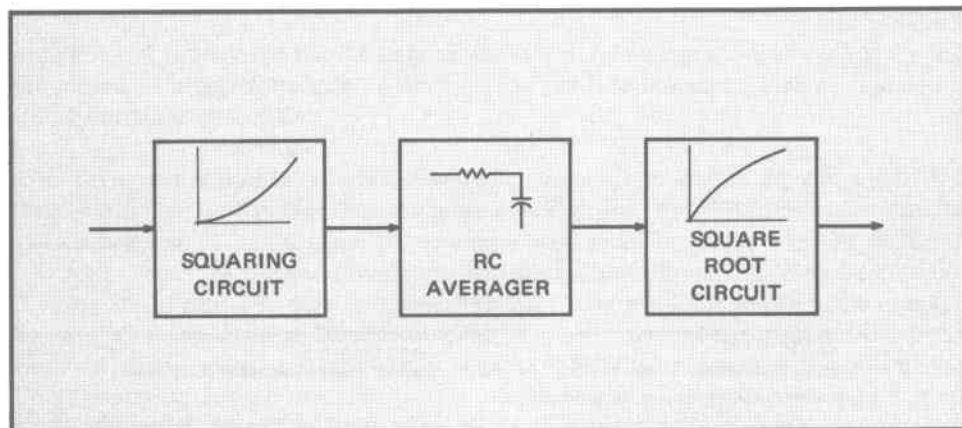

Figure 35. Equivalent-circuit block diagram of 8052A detector (Figure 31).

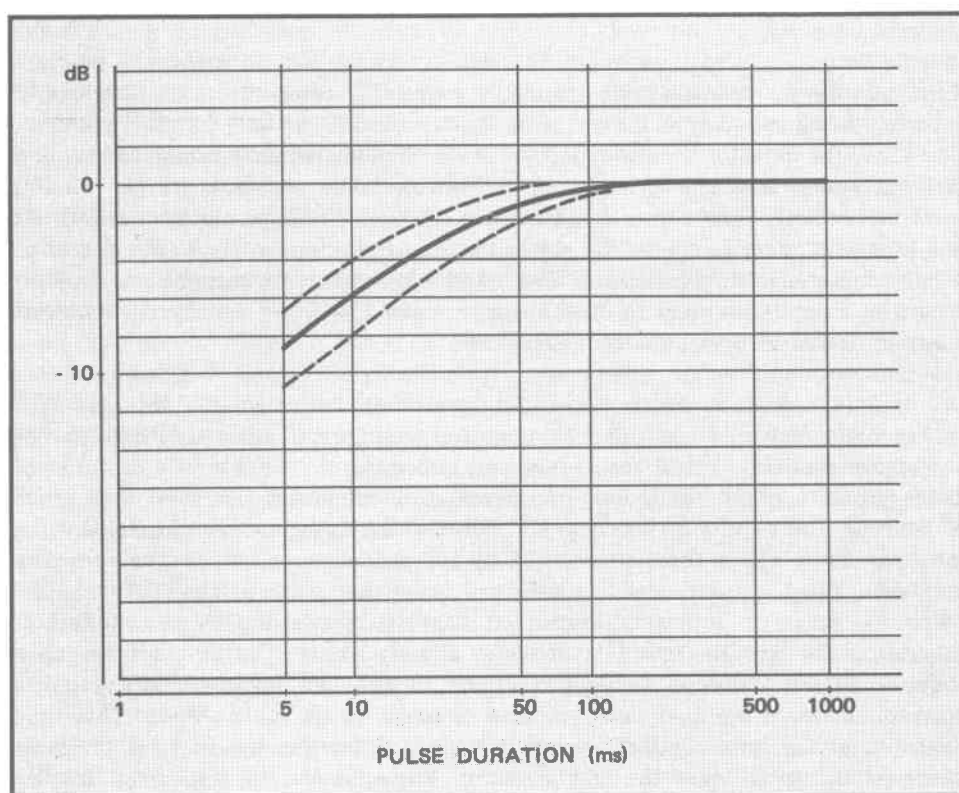

Figure 36. Deviation ΔL of meter indication from steady-state value as a function of the duration of a single tone burst per German standard DIN 45633 for "Impulse" mode.

discharging time constant (a nominal 3 seconds) is long compared to the mechanical response time of the meter movement. Thus the meter has ample time to indicate the rms value of impulsive sounds as short as 5 milliseconds.

D. OVERLOAD INDICATION.

Since we cannot assume to know more than the general nature of a sound before we measure it, our sound level meter must provide an indication of any over-

load if we are to avoid erroneous measurements. Overloads can be of two types: 1. Overloaded input amplifier. Because the weighting networks follow the input amplifier, a signal at a particular frequency might overload the amplifier even though the meter reads below full scale. 2. Excessive crest factor. The 8052A can handle crest factors of five, but signals with higher crest factors certainly occur. The 8052A provides positive indication — a flashing panel light — of both types of overload condition, even for transients as short as 100 microseconds.

E. MEASUREMENTS WITH THE SOUND LEVEL METER.

In the final analysis, what have we measured with the sound level meter? The frequency- and time-weighted rms value of sound pressure. The frequency weighting we select as dB (A), dB (B), dB (C), or dB (D) (available in lieu of dB (B) in option 01 8052A's). As noted above, these response curves make the sound level meter respond to single tones at various frequencies in approximately the same way as the human ear. As broad-band devices, however, sound level meters cannot indicate the spectral composition of a particular sound, i. e. there is no correlation between our subjective response due to this factor and meter indication. This is the main reason why there can be substantial differences — 10 dB and more — between subjectively measured loudness level in phons and sound pressure level in dB. There are other contributing factors as well. These include the inability of the sound level meter to account for masking effects and the impossibility of selecting the right weighting function for all spectral components at once.

Since there is no hope for a reasonable degree of correlation between the loudness levels of widely differing sounds and sound level meter readings anyway, usually no attempt is made to select the most appropriate weighting curve — A, B, or C — for the levels encountered. The quantity which is measured is almost always the A-weighted sound level even at levels where the high attenuation of low-frequency components would not be justified from a physiological point of view.

By itself, then, the sound level meter can be used only to compare sounds from similar sources. For example, we can compare one automobile with another, “standard” automobile, perhaps as a quality check. We cannot, however, compare the automobile with a typewriter because of the different character of the two sounds.

For time weighting we have a choice of Slow, Fast, and Impulse. Which mode should we select? For steady-state signals without an audible time structure (e.g. white noise or sine-wave signals) it doesn't matter; all three modes give the same reading. What about sounds which do have a significant time structure (e.g. white noise limited to a 20-Hz bandwidth or an idling motorcycle engine)? We can already predict a fairly steady indication in the Slow mode, at least as long as the 1-second time constant is long compared to the transient deviations from the indicated average. We must recognize, however, that this steady reading is in conflict with our subjective response. We do indeed sense the ups and downs of a sound, and a single figure certainly cannot describe our sensation. The indication in the Slow mode therefore has no physiological significance and can only be interpreted as the value of an abstract physical quantity: rms sound pressure level weighted with a 1-second time constant.

Can we utilize the Fast mode then? If we try, we can indeed see the meter pointer fluctuating, and these fluctuations seem to correspond to our reaction to the sound.

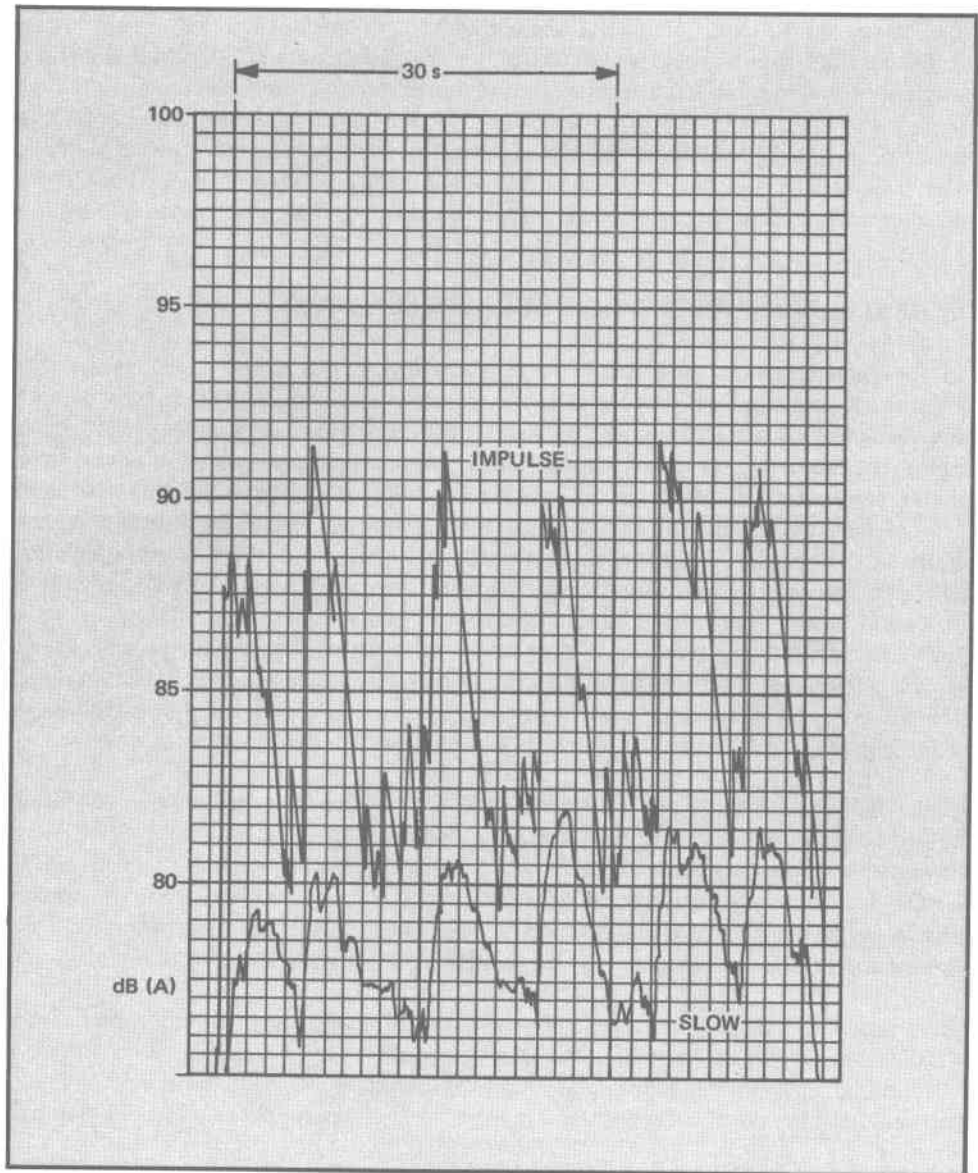

Figure 37. Typewriter noise as indicated in Impulse (upper trace) and Slow modes (lower trace).

Can we deduce any quantitative information from this? Generally speaking, no. Recalling the properties of the RC-averaging detector, we know that we have to wait a few time constants before we get a meaningful reading even when we switch from one steady-state amplitude to another. Now, in this case the circuit never reaches a steady-state condition, consequently, we cannot draw any quantitative conclusions from the excursions of the meter pointer. Nevertheless the Fast mode does offer advantages over the Slow in that in the Fast mode the meter follows faster variations in the input (although they must be slow compared to the 100-millisecond time constant) and reacts more quickly to step changes between steady-state values.

We can see that we have a real dilemma: on the one hand we would like our sound level meter to respond to changes in sound level just as we hear them, while on the other we cannot expect our detector circuits and meter movement to handle

these changes adequately. The answer provided by the Impulse mode may not be completely satisfactory, but by specifying the response to single tone bursts down to 5 milliseconds duration and by overcoming the inertial limitations of the meter movement with a stretching circuit, we can at least measure sound level maxima predictably. The behavior of the meter on the down-swing is, of course, only determined by the exponential discharge of the stretching capacitor and has nothing to do with the way in which the sound field decays. In measuring fluctuating sounds, then, the Impulse mode gives us the only physiologically meaningful data: the maximum sound pressure levels as they occur in time. The meter readings are of course higher than those taken in the Slow or Fast mode in which the averaging time is longer and typically no stretching is provided. Figure 37 shows the difference in readings for Impulse and Slow modes for typewriter noise.

To summarize time weighting, a sound level meter without the Impulse mode is useful only as long as the meter reading (in Fast) is practically constant, in other words, only as long as the sound to be measured has no significant time structure. In all other cases — and they are the rule rather than the exception — the Impulse mode is mandatory; it provides an accurate measurement of the sound level maxima occurring during the observation time.

The 8052A also has a Peak mode of operation in which the rms detector is bypassed and the signal is applied directly to the peak detector/stretcher. At the same time, the stretcher discharge time constant is increased to more than 100 seconds. In the Peak mode we can measure the true peak pressure of a sound. This pressure is especially significant in ear damage investigations. The Peak mode (the rise time of the peak detector is less than 100 microseconds) also enables us to determine the crest factor of a signal, for we can measure both the peak and rms values and calculate the ratio.

In conclusion, then, we can say that while the sound level meter has its limitations, it is nevertheless an extremely useful tool. It is inexpensive, easy to use, and highly portable. Armed with proper knowledge, we can indeed make meaningful measurements.

LEVEL RECORDER

There are many situations in which we would like a permanent record of our sound measurements. For example, we might want to measure the effectiveness of various automobile muffler designs, or we might want to monitor the noise level in an industrial plant. The level recorder has been used for this purpose for many years.

The level recorder is essentially a strip-chart recorder. However, since the detected signal in the sound level meter is non-linear, the level recorder accepts an ac signal. This signal is taken from the sound level meter at a point just ahead of the detector. The level recorder then has its own detector, in some cases increasing the flexibility of the sound level meter by providing quasi-peak and average detection as well as rms detection.

In using the level recorder, we run into the same problem discussed above for sound level meters: dynamic response. As the sound becomes more impulsive, response is controlled by the dynamic characteristics of the non-linear feedback loop that controls the movement of the stylus rather than by the detector. Most

level recorders provide selectable writing speeds, but at the higher speeds there is greater overshoot due to mechanical inertia. Depending upon writing speed and dynamic range, we can get errors up to 20 dB when recording the level of a 200-millisecond tone burst. The situation becomes even worse with shorter tone bursts.

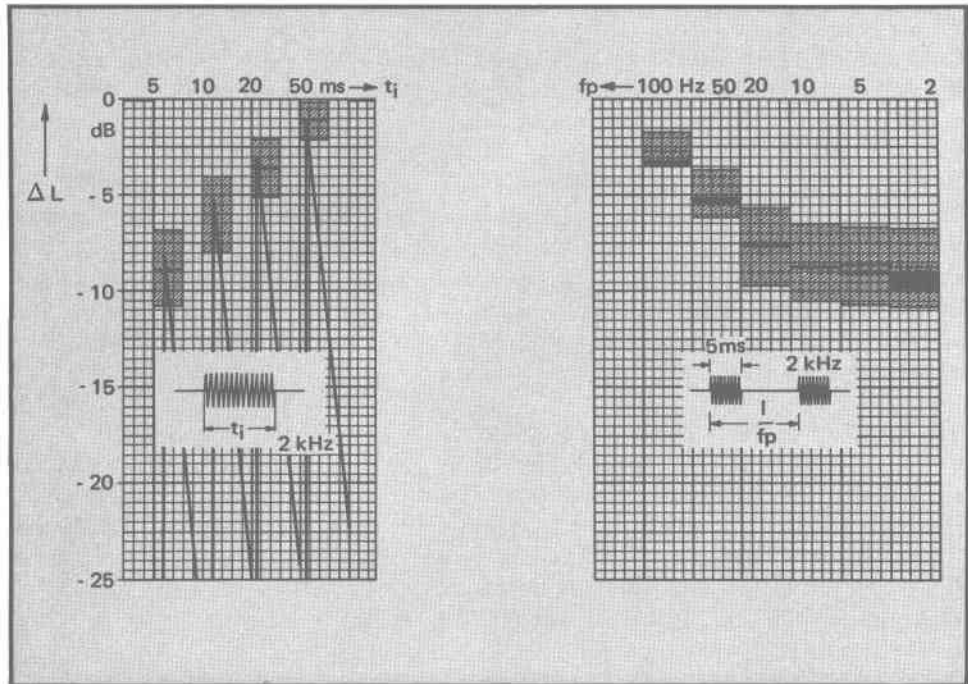

Figure 38. Impulse response of level recording system consisting of HP 8052A Impulse Sound Level Meter, 15132A Logarithmic Converter, and 680 Strip Chart Recorder. Tolerance limits are also shown.

The 8052A, on the other hand, furnishes a dc output, the same dc signal which drives the meter. Using this signal is advantageous in two ways: 1. The detection is already done, so a detector is not required in the recorder. 2. The 8052A stretcher circuit comes into play for impulse and peak measurements, so the recorder need have only moderate speed. Most commonly available strip-chart recorders such as the HP Model 680 fulfill these requirements.

The dc output of the 8052A is a linear function of sound pressure. However, in general it is more convenient to have our record linear in terms of sound pressure level in dB. A logarithmic converter with a 25-dB dynamic range such as the HP Model 15132A can be used here. Since the log converter and recorder are an extension of the sound level meter, the discussion above regarding valid readings applies equally well here, i. e. the recording is valid only when the system can follow the signal. Figure 38 shows the response of the 8052A/15132A/680 system to single tone bursts of various lengths and to 5-millisecond tone bursts of various repetition rates on the Impulse mode of the 8052A. The signals and tolerances are those specified in the German standard for impulse sound level meters, DIN 45 633, Part 2. The figure shows that the entire system easily meets the requirements and that the response of the system is determined by the 8052A itself.

FILTERS

In discussing the sound level meter we have dealt with broad-band measurements. As we have seen, such measurements permit us only to compare sounds from similar devices because we are unable to distinguish between sounds of different character simply on the basis of meter readings. Indeed, there is no guarantee that different sounds will produce different meter readings. But we can hear the difference; we know an automobile sounds different from a typewriter. To make truly quantitative measurements, then, we must break sounds up into spectral components which we can analyze individually and collectively. We must use filters.

Today there are a number of choices open to us. We can use narrow-band filters or broad-band filters. We can use a number of filters in parallel or a single tunable filter. We have not always had such a wide choice. Some years ago filters were strictly passive devices made up of capacitors and large inductors, and each filter came in a separate, big, heavy, cumbersome package. To reduce the number of individual units required, some of the filter elements were made switchable, enabling a single filter box to cover several bands. With the development of active filters, the inductor was eliminated as a filter component. The resulting ease of tuning prompted the use of continuously variable filters, while the reduced bulk meant that a warehouse was no longer required for the parallel operation of a number of filters. A little later came instruments utilizing the heterodyne technique (i. e. wave analyzers), and these were also put to work analyzing sound.

So far, we haven't mentioned resolution. Over the years many types and combinations of filters have been tried. However, in light of our present knowledge, we can narrow the choice considerably. Recalling the discussion of loudness in Section III, we see that choosing a resolution narrower than the critical bandwidth doesn't make sense because for narrower bandwidths the spectral distribution of sound does not influence loudness. We have also seen that above 280 Hz critical bandwidths are very nearly one third of an octave, so third-octave resolution is a logical choice. For sound analysis, then, we want to use filters with constant-percentage bandwidth rather than constant absolute bandwidth.

While this choice rules out the wave analyzer with its constant absolute bandwidth, it does not settle the question of sweeping or fixed filters. However, the sweeping filter has one major disadvantage: filter quality. As a constant-percentage bandwidth filter, its bandwidth must be changed continuously as it sweeps, meaning that its frequency-determining components must be continuously adjustable and properly ganged. Maintaining optimum filter characteristics under such circumstances is extremely difficult at best. Another factor, which becomes significant when we discuss automatic sound analysis, is sweep time. In the sweeping filter, we have a constantly shifting viewing "window". Since we can see only those spectral components which are within the window, we would like to sweep the frequency range of interest as rapidly as possible to catch all of the components of even short sounds. Now, assuming a detector with a 35-millisecond time constant, a third-octave filter would require more than 1.5 seconds to sweep from 50 Hz to 10 kHz (sweep time is proportional to detector time constant). Such a sweep time hardly gives us a continuous look at a spectrum.

Should we use contiguous fixed filters, we can solve the problem of filter quality by tailoring each filter individually. On the other hand, we need a lot of filters (it takes 24 third-octave filters to cover the range from 45 Hz to 11 kHz), so cost

certainly is a factor. We can reduce the cost in two ways: 1. restrict the frequency range, thereby reducing the number of filters, and 2. increase the bandwidth of the filters (e. g. to an octave), again reducing the number of filters. (We could also relax the filter tolerances to reduce the cost of each filter, but this approach tends to defeat the purpose of using filters in the first place.) Actually, we can turn these alternatives to our advantage by selecting a measurement system which is no more complex than necessary at a cost commensurate with capability.

Returning to automatic sound analysis for a moment, we have seen that the swept-filter technique is not very satisfactory because of the slow sweep rate. Fixed filters yield much better results. By providing each filter with a detector, we can then sequentially sample the output of each detector and display the results. The rate of sampling is independent of filter characteristics, so the "sweep rate" can be quite fast. As we shall see below, a sweep can be completed in milliseconds rather than seconds, providing a true real-time analysis. Of course, we could record the sound on magnetic tape and then play it back as often as necessary to view the full spectrum. This method is a valid one and is widely used. However, we can use manually (or automatically) selected fixed filters in this case, so a sweeping filter offers no particular advantage. For acoustic measurements, then, we use fixed filters ⁷.

Again, we must set standards to ensure consistent measurement results. Two standards in wide use are IEC Publication 225, "Octave, half-octave, and third-octave filters intended for the analysis of sounds and vibration", and USA Standard S 1.11-1966, "Octave, Half-Octave, and Third-Octave Band Filter Sets". The two standards are similar in that they specify the same filter center frequencies and nominal band-edge frequencies. In addition, both base effective bandwidth on the transmission of white noise (constant noise power per unit frequency), i. e. the effective bandwidth of a practical filter is equal to that of an ideal filter that passes the same white noise power (Figure 3⁹). Both standards put a $\pm 10\%$ tolerance on effective bandwidth.

The two standards differ somewhat in their definition of transmission loss characteristics. IEC 225 defines a single shape for each type of filter, while S1.11-1966 defines three filter classes, although only two apply to any one filter type. These classes describe the quality of transmission loss slope (skirt characteristics) as follows: Class I, low; Class II, moderate; and Class III, high. Octave filters fall into classes I or II; half- and third-octave filters, into classes II or III. We shall concern ourselves here only with octave and third-octave filters because half-octave filters neither have significance acoustically in terms of our subjective response nor offer much of a saving in terms of fewer filters for a given frequency range. Class II octave filters specified in S1.11-1966 are very similar to filters specified in IEC 225 as can be seen in Figure 40. The same holds true for Class II third-octave filters. However, the Class III third octave-filters of S1.11-1966 have considerably more stringent specifications, as shown in Figure 41. Note the higher signal-to-noise ratio of more than 75 dB instead of 60 dB. It is nearly impossible to fulfill these requirements with passive filters over the entire frequency range. (The Class I octave filter requirements are very loose; the minimum attenuation limit is only 9 dB at the center frequency of the adjacent filter, 45 dB at 0.1 and 10 times the center frequency.) The US standard also puts a limit on passband uniformity: maximum peak-to-valley ripple is 2 dB for octave filters, 1 dB for Class II filters (except octave filters), 0.5 dB for Class III filters.

⁷ Preferred frequencies for acoustics work are listed in Appendix B.

As noted above, S1.11-1966 Class III third-octave filters have a signal-to-noise ratio of 75 dB. This high ratio is important in many measurement situations. Because sounds are generally non-sinusoidal, the rms value of the electrical signal applied to the filter should be kept at least 10 dB below the peak handling capability of the filter to allow for crest factor. At the other end of the range, signals should be about 10 dB out of the noise so that the noise does not affect the measurement. Thus we can make rms measurements over a range of about 55 dB with S1.11-1966 Class III third-octave filters, about 40 dB with IEC 225 filters. In summary, then, filters meeting the requirements of IEC 225 and S1.11-1966 Class II are essentially equivalent. Filters meeting S1.11-1966 Class I are not nearly as good; filters meeting S1.11-1966 Class III are much better.

Among the wide variety of filters presently available are octave and third-octave filters from Hewlett-Packard. These are active, three-pole filters which meet the requirements of S1.11-1966 Class II octave filters and Class III third-octave filters respectively (and therefore IEC 225 as well). Figure 42 shows the characteristics of typical HP third-octave filters.

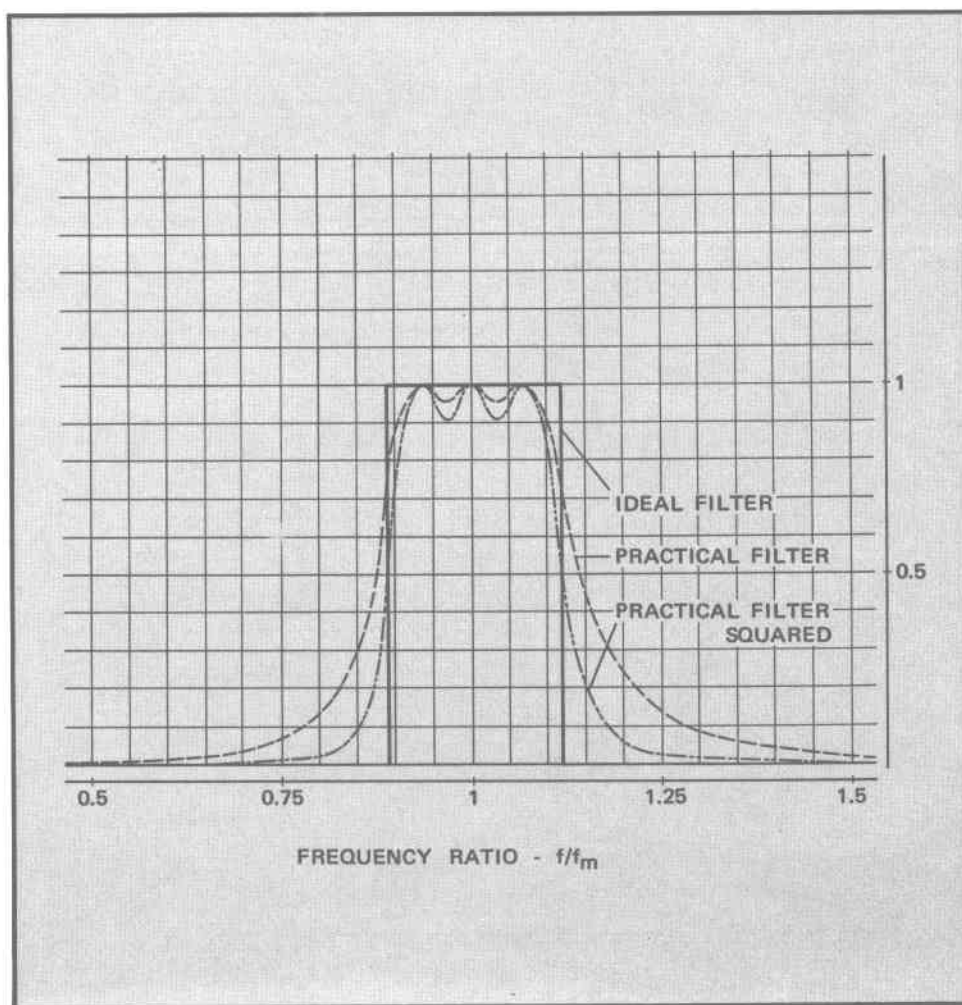

Figure 39. Determination of filter bandwidth. Areas under ideal filter and practical filter squared curves must be equal.

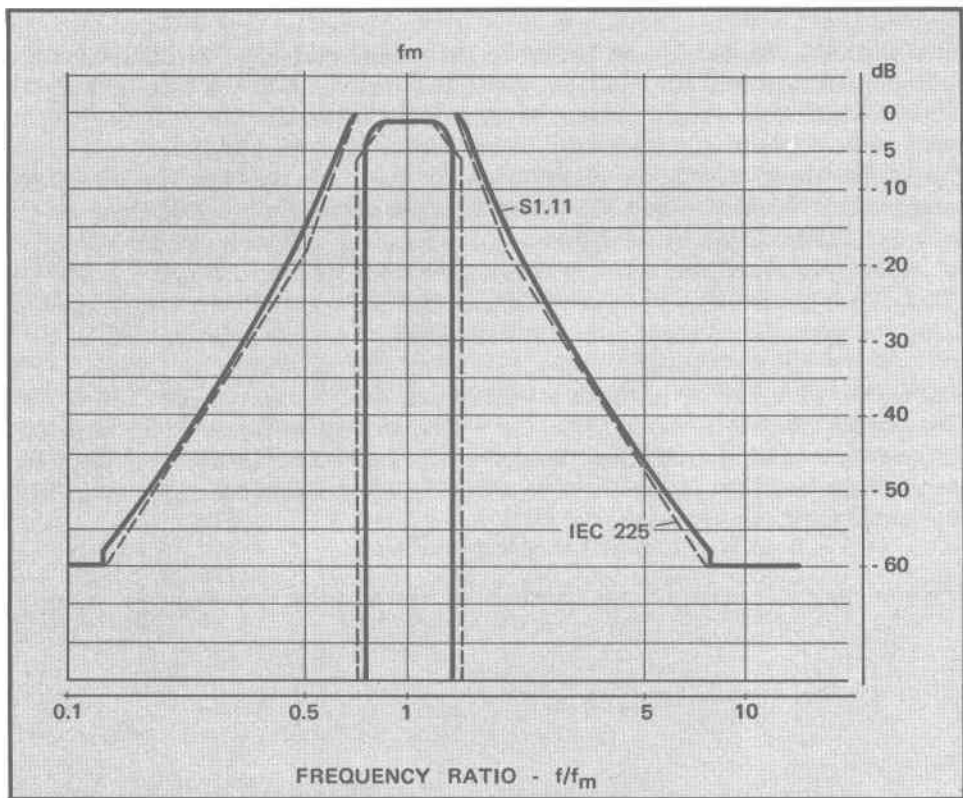

Figure 40. Class II octave filter transmission characteristics

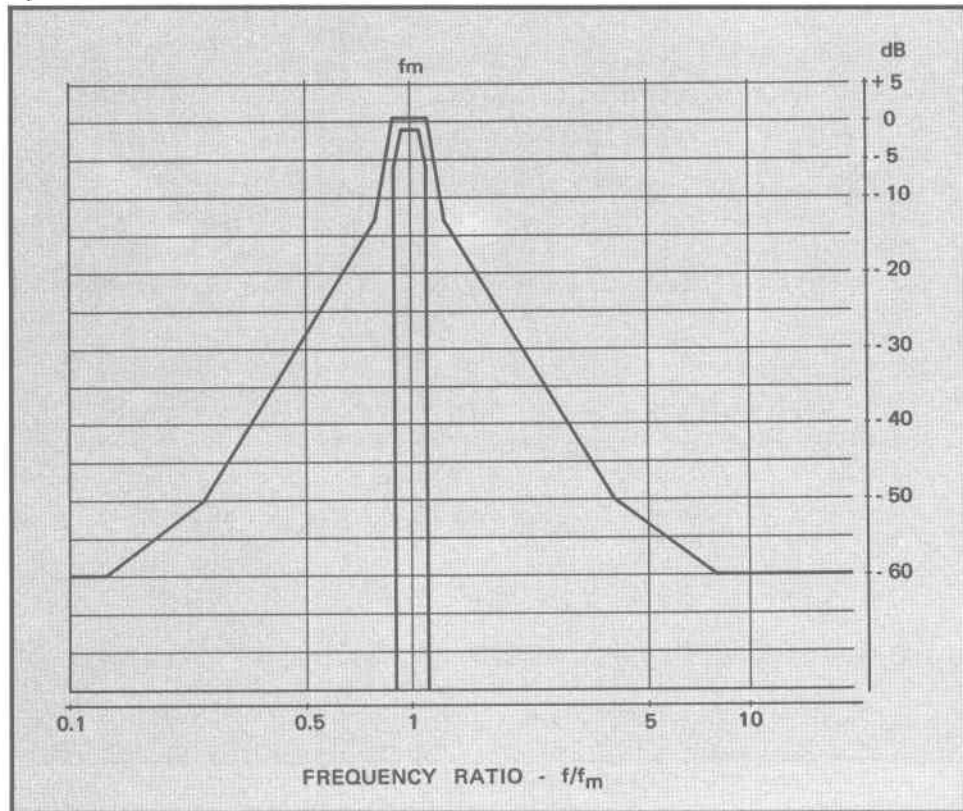

Figure 41.a. Third-octave filter transmission characteristics per IEC 225.

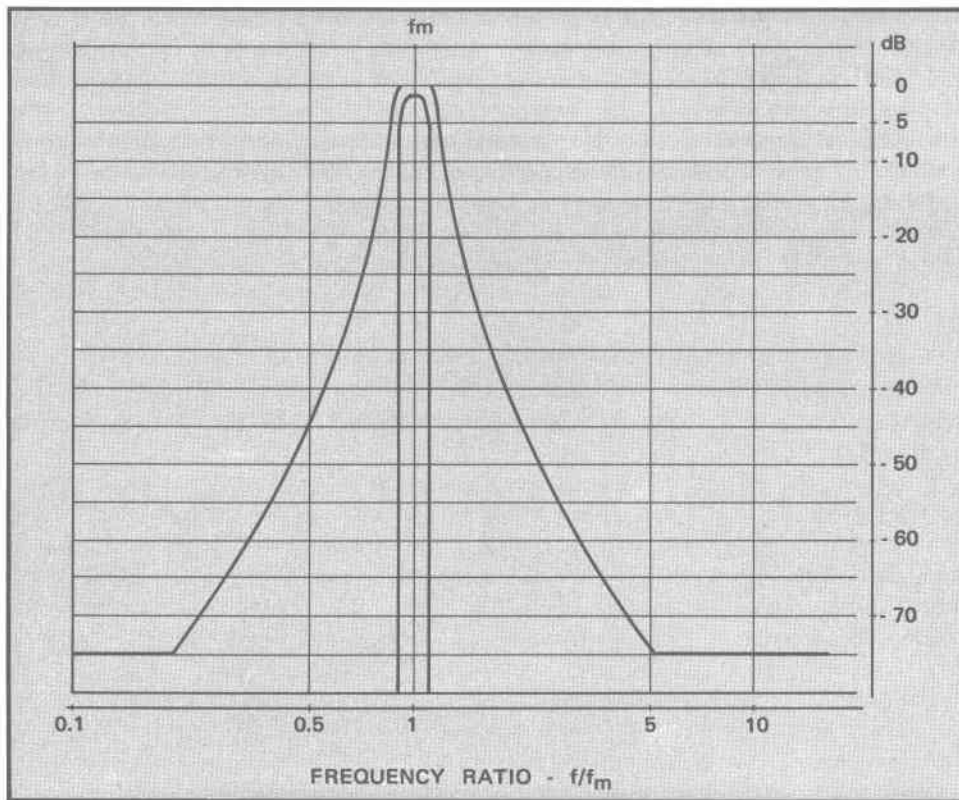

Figure 41.b. Class III third-octave filter transmission characteristics per S1.11 - 1966.

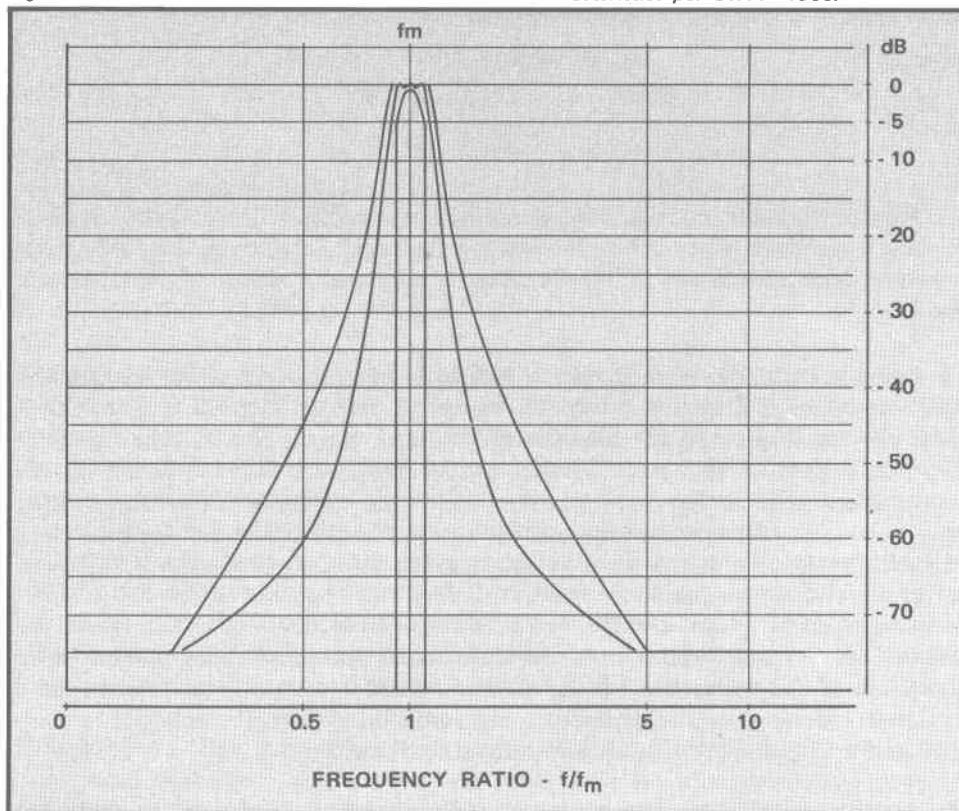

Figure 42. Typical transmission characteristics of HP third-octave filters.

FREQUENCY ANALYSIS

A. MANUAL SYSTEMS

The simplest frequency-analysis systems are manually operated, octave-band systems. In general these systems employ a sound level meter, operating in its linear mode, as the indicating device. The filters themselves are usually supplied as a set as in the HP 8055A Filter Set (Figure 43). This instrument has eight push-button selected filters with center frequencies from 63 Hz to 8 kHz. Two additional filters are available on an optional basis; these have center frequencies of 31.5 Hz and 16 kHz. When the 8055A is used with the 8052A or 8062A, all necessary connections between the instruments are made with a single, five-conductor cable supplied with the 8055A. Electrically, the filters are located between the input amplifier and rms detector of the 8052A/8062A, substituting for the internal weighting networks.

An octave-band analysis enables us to see which part of the spectrum contributes most heavily to the overall loudness. In noise abatement studies, octave-band analysis can help pin-point the true offender as well as evaluate corrective action. Noise rating numbers, described in Section IV, are determined on an octave-band basis.

The technique of sound analysis using manual systems depends somewhat upon the nature of the sound. Continuous and repetitive sounds can be evaluated on the spot; there is plenty of time to select each octave band in turn and note the meter reading. To evaluate discontinuous and transient sounds, however, we must use other methods. The tape recorder is widely used to preserve a sound in its original form; the sound can then be reproduced as often as necessary to complete the analysis. For convenience, the section of tape containing the particular sound to be evaluated is often cut out of the roll and made into a continuous loop. We can then play the tape over and over without having to stop and rewind it each time. However, in making the loop, we must be careful not to make it so short that the reproduced sound takes on the nature of a repetitive signal because the spectrum is then altered. The loop should be long enough for us to note the meter reading and change filters before the sound is repeated. Level recorders (see above) provide a convenient means of obtaining a permanent record of measurement results.

To simplify certain measurements, the 8055A has a provision for setting the gain through each filter separately. The range of gain is -20 dB to $+20$ dB (a fixed gain of 0 or $+20$ dB can also be selected for all filters). The variable-gain mode permits the precalibration of the indicating unit in terms of the measurement criteria. For example, we might want to know if the noise rating of a secretarial office with respect to annoyance exceeds a certain noise rating number, say 45. The octave-band pressure level equivalent to a noise rating number of 45 is 71 dB for the 63-Hz band, 61.1 dB for 125 Hz, 53.8 dB for 250 Hz, etc. Rather than have to remember these numbers, we can adjust the gain of each octave filter so that a meter reading of 45 dB corresponds to a noise rating number of 45 regardless of the octave band selected. The variable-gain mode can also be used to flatten the frequency response of a measurement system, for example to compensate for frequency non-linearities in the sound source.

There are many situations in which we want to combine levels. For example, we might want to convert a third-octave analysis into an octave analysis so we can

determine noise rating numbers. Or we might want to determine overall sound pressure level from either an octave or third-octave analysis. In any case, we can combine levels by converting sound pressure levels to sound pressures, summing the pressures on an energy basis, and reconvertng to sound pressure level. A simpler and more direct method involves the use of a graph to combine sound pressure levels directly. This method is outlined in Appendix C.

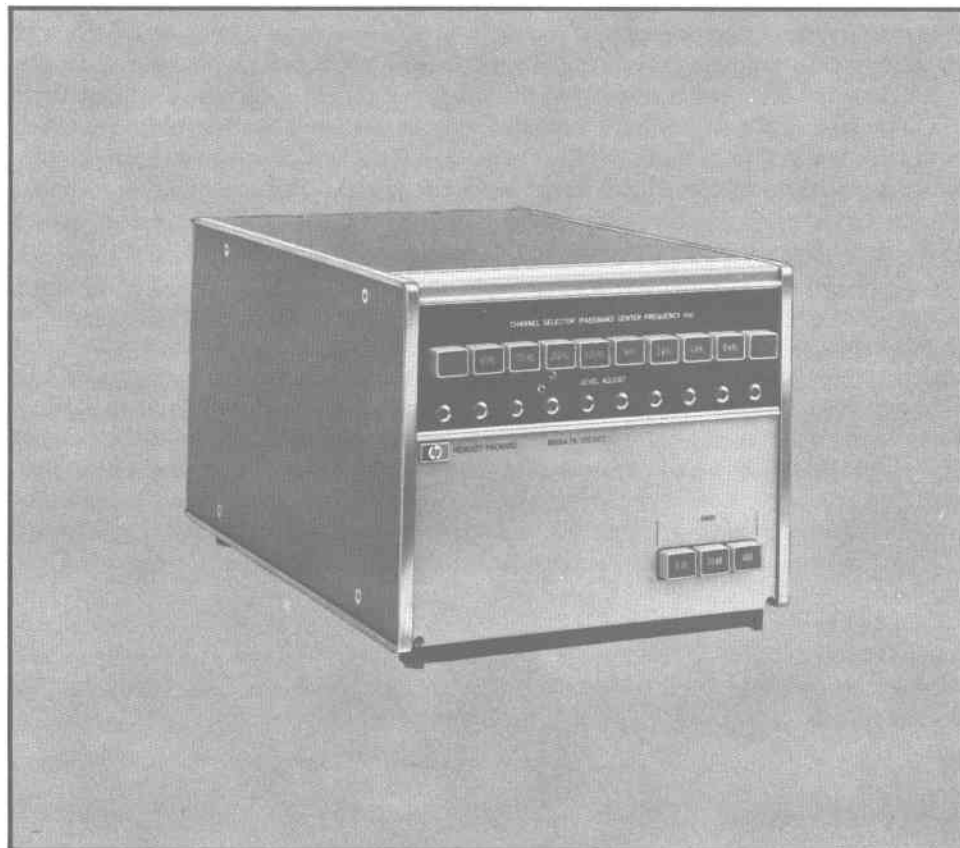

Figure 43. HP 8055A Filter Set.

B. AUTOMATIC SYSTEMS.

Manually plotting audio spectra is at best a slow process, particularly when we are faced with discontinuous and transient sounds. And once we have a spectrum, we require additional time to equate it to our subjective sense of hearing. If we then wish to determine the effect of some change in our measurement setup, we must go through the whole procedure again. Some means of automatic sound analysis is therefore highly desirable for many applications. It would also seem desirable if our analyzer automatically presented data in terms of our sense of hearing. In Section IV we discussed three methods which attempted to account for masking and other effects in our sense of hearing. The methods of Stevens and Kryter are basically similar; both differ considerably from that of Zwicker. Perhaps we should review these methods by noting their good and bad points.

First Zwicker. This method has two points in its favor: it provides a meaningful spectrum and it comes closer to the true masking effect. The spectrum is meaningful because the height of each "line" is truly proportional to its contribution to total loudness. We can see at a glance the character of the spectrum in subjective

terms; we know where to concentrate any corrective efforts. In terms of masking, the Zwicker method recognizes that a sound at one frequency primarily masks higher frequency sounds (refer to Figures 5 and 6 in Section III). However, the Zwicker method is difficult to apply with manual equipment because it is an analog method. Special graph paper is required and even then it is necessary to determine the area under an irregular curve to get total loudness.

Stevens/Kryter. These are digital methods in that the final figure is determined by simple calculations. Thus these are much easier to handle with manual equipment than the Zwicker method. On the other hand, the spectrum obtained from the Stevens and Kryter methods provides only unweighted band-level information. A simple inspection does not tell us if a high-level low-frequency signal contributes more than a lower-level high-frequency signal. Also, masking is handled on a symmetrical basis, i. e. without regard to whether the masked signal is higher or lower in frequency than the masking signal.

In the final analysis, the best method is the one which has the closest correlation to our sense of hearing. The Zwicker method is quite good in this regard, at worst tending to be 1 or 2 phons on the high side. The Stevens method is generally 3 or 4 phons low. The Kryter method, which extends the Stevens method to correct some of its deficiencies, is quite good, in general as good as the Zwicker method. The difference is the statistical spread of results for different types of sounds. The Zwicker method is very consistent; however, due in part to their handling of masking, the Stevens and Kryter methods have a much greater spread. The Zwicker method thus comes closest to duplicating our sense of hearing.

We should remember at this point that the Zwicker and Stevens methods determine loudness and that the Kryter method determines annoyance. In spite of the differences between loudness and annoyance, the close agreement between the Zwicker and Kryter methods for most sounds tends to justify their comparison.

1. Loudness Analysis

The HP 8051A Loudness Analyzer (Figure 44) is an automatic analyzer based on the Zwicker method, adhering to ISO Recommendation 532, Method B. Accepting a signal from a microphone, tape recorder, etc., the Loudness Analyzer displays the resulting Zwicker diagram (a plot of loudness density vs subjective pitch) on its crt. The spectrum of a single typewriter stroke is shown in Figure 45. In addition, the area under the displayed curve is automatically computed and indicated on a meter in sones_G. A new spectrum is plotted every 25 milliseconds, so for all intents and purposes the analyzer displays the instantaneous sound spectrum. To permit more than a fleeting glance at spectra of impulsive and transient sounds, the 8051A includes a peak mode in which the amplitude of each spectral line is only permitted to increase. The display changes only when some spectral component is higher than the one already displayed; lower level components have no effect. This mode permitted the capture of the spectrum of Figure 45. (Do not confuse this peak mode with peak detection.) The 8051A also has a hold mode in which the displayed spectrum is frozen. The frozen display can then be plotted automatically with an X-Y recorder on preprinted analysis forms to provide a detailed diagram as shown in Figure 46. The 8051A truly automates the Zwicker method of sound analysis.

It might be well to take a closer look at the 8051A. As shown in the block diagram

of Figure 47, input signals first go through an internal preamplifier. Then, if the sound field being measured is diffuse rather than a frontal free field, the signals are weighted by a network which simulates the difference between the ear's sensitivity to the two types of sound fields.

Having gone through the input circuits, the electrical signals representing the sound to be analyzed are separated into 20 channels by active bandpass filters. The filters cover the frequency range between 45 Hz and 14 kHz. Those in the two lowest-frequency channels are octave filters; channel three is a $2/3$ -octave filter; all others are third-octave filters.

Following each filter is an rms circuit which produces a dc signal proportional to the rms value of the filter output. The rms circuit has a dynamic range of 60 dB and a time constant of about 100 milliseconds. This is, as we have seen, within the range attributed to the ear. Thus the analyzer's response to sounds of short duration is similar to that of the ear. The large dynamic range is necessary for two reasons. First, the analyzer's display range is 40 dB, so the dynamic range of the rms circuit has to be at least this large. Second, to give accurate results for impulsive sounds, the rms circuit must be able to handle high crest factors. The circuit used in the analyzer handles crest factors as high as seven.



Figure 44. HP 8051A Loudness Analyzer

From the rms circuit, signals go through a chopper and then to a square-root amplifier. The chopper allows the amplifier to be ac-coupled, thereby avoiding drift problems. It operates at 15 kHz, fast enough to follow changes in the rms signal.

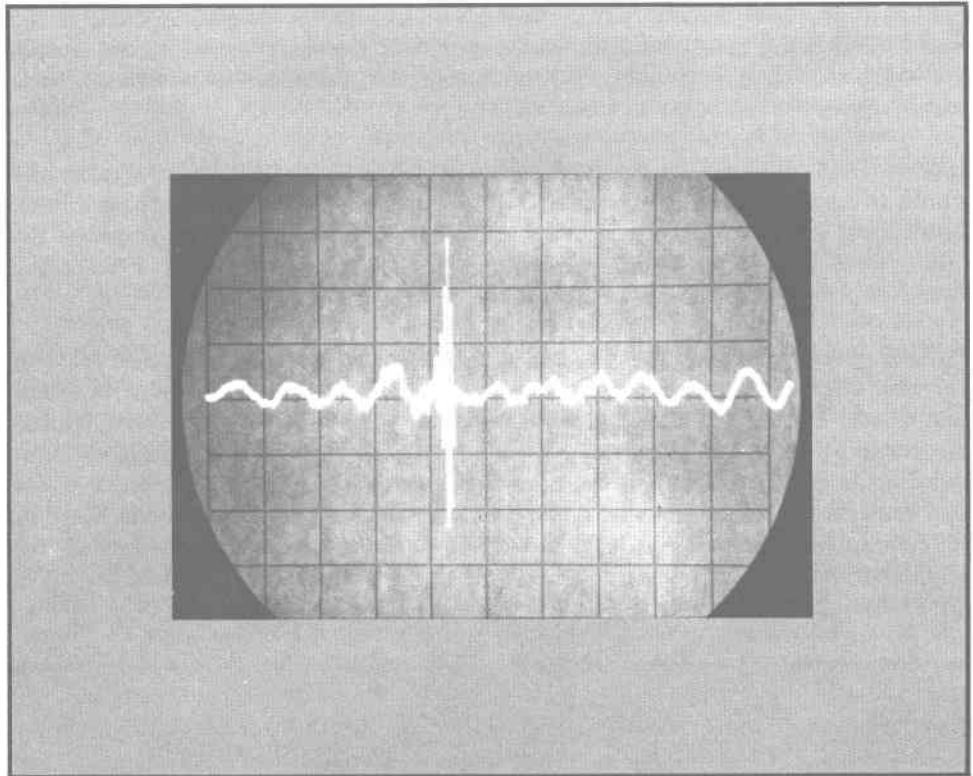

Figure 45a. Sound Pressure Waveform of single typewriter stroke.

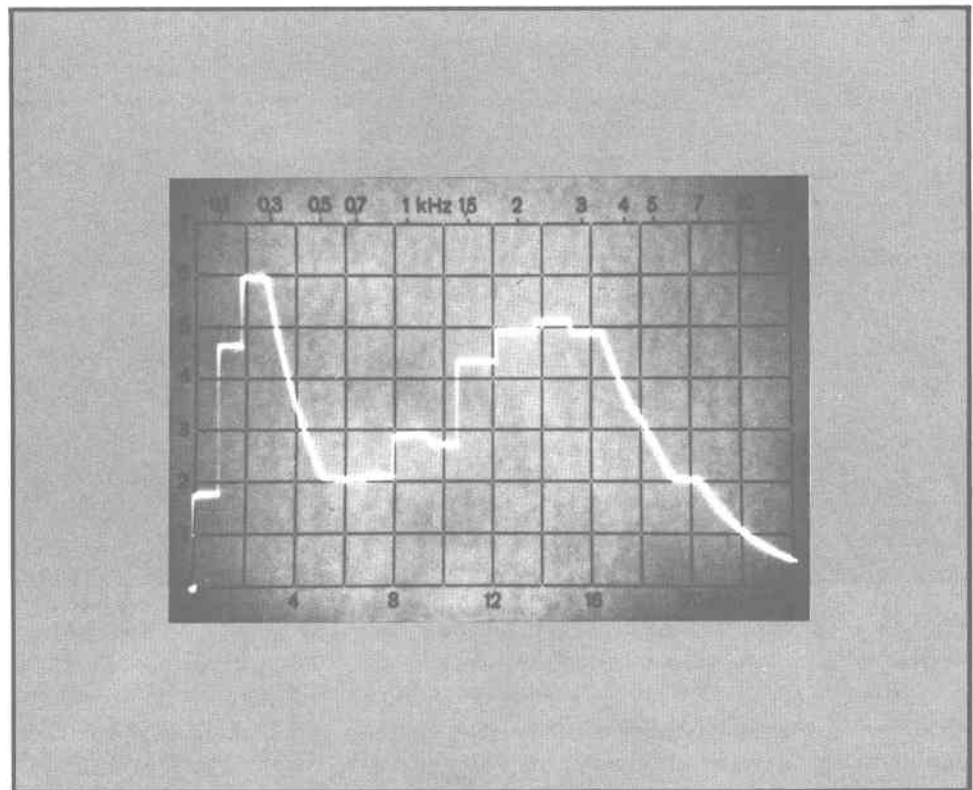

Figure 45b. Spectrum caused by Typewriter Stroke.

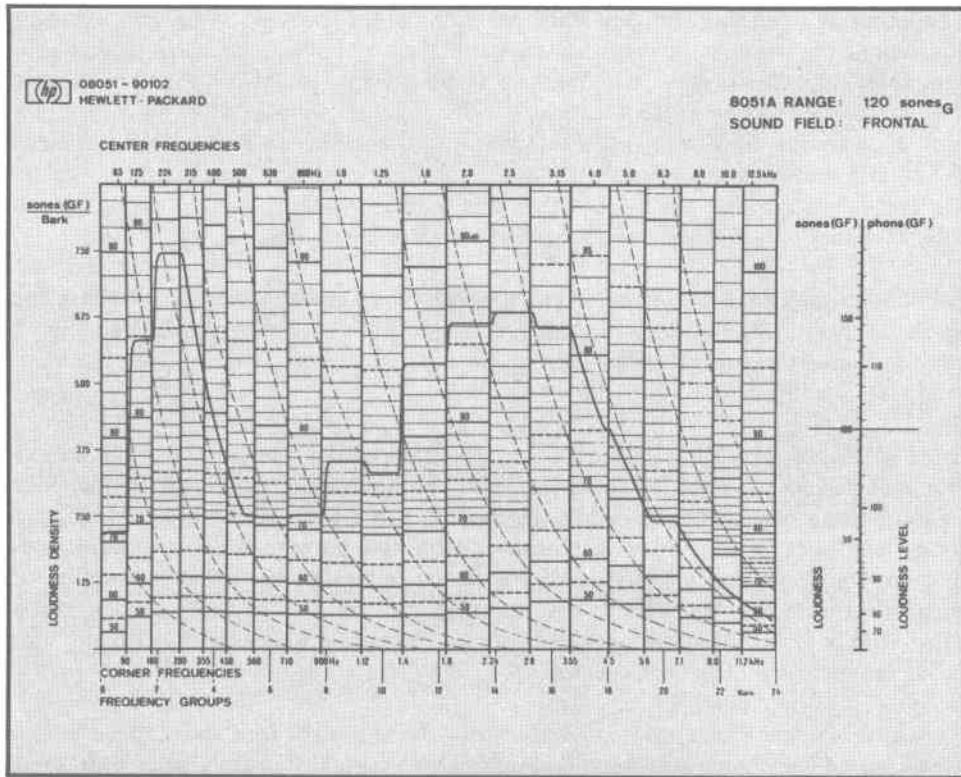

Figure 46. Loudness Analysis of a single Typewriter Stroke.

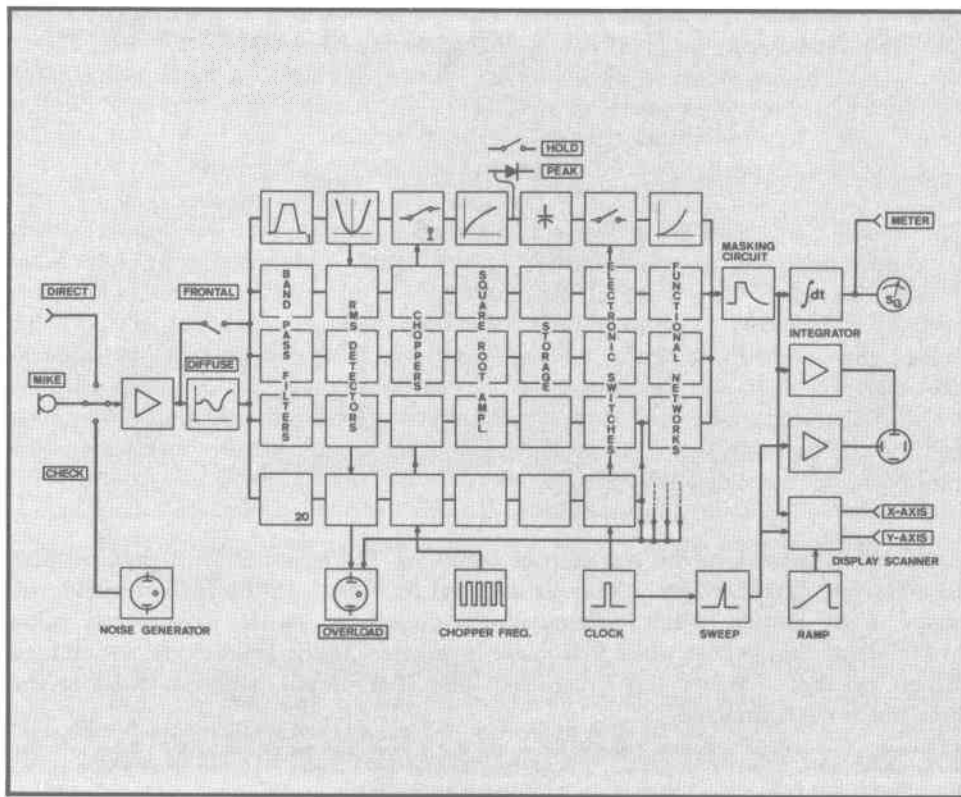

Figure 47. Block Diagram of the HP Model 8051A Loudness Analyzer

The purpose of the square-root amplifier is to begin to convert the rms value of the sound pressure in the channel to something which can be used to compute loudness. Now, Zwicker's approximation to the masking effect is a series of curves, like the one shown in Figure 48, which is for a 1 kHz tone. A masking curve is a plot of loudness density versus subjective pitch, and the area under it represents the total loudness of the sound. When the masking curves of two sounds overlap, the total area under them is less than the sum of their individual areas, so the total loudness is less than the sum of the individual loudnesses.

Masking curves have two parts, a horizontal line in the frequency band where the sound is located, and a tail which decays to zero with increasing pitch (frequency). We shall call the height of the horizontal portion of the masking curve the band loudness density.

Band loudness density is a function of the rms sound pressure and the center frequency of the channel. The shape of this function is determined by the response of the human ear, which is usually expressed in the form of equal-loudness contours (see Section III). Band loudness density can be expressed as the product of two functions, one a function of frequency only, and the other a function of pressure and frequency. The former function is simulated in the Loudness Analyzer simply by varying the gain of the rms circuits from channel to channel. The latter function is illustrated in Figure 49.

Figure 49 shows normalized band loudness density as a function of rms sound pressure and center frequency. "Normalized" means that loudness variations which are functions of frequency only are not included in the figure. The normalization is with respect to the ear's response at 1 kHz. For 1 kHz, but not for other center frequencies, the height of the horizontal portion of the masking curve can be determined from Figure 49. Taking the example of Figure 48, we have a 1 kHz tone which has a loudness of 37 sones_G, corresponding to a loudness level of 92 phons_G and a sound pressure level of 92 dB. According to Figure 49 such a sound has a band loudness density of about 9.2 sones_G per Bark⁸. This is the height of the horizontal portion of the masking curve in Figure 48.

The square-root amplifier converts rms sound pressure to a first approximation of normalized band loudness density. At high sound pressures and at high center frequencies, all of the curves of Figure 49 approach the dashed curve, which is a straight line with a slope of approximately 0.5. Translated mathematically, this means that normalized band loudness density is approximately proportional to the square root of the rms sound pressure in the channel. Actually, the slope is 0.47, so the amplifier's response is not quite a square-root function. Deviations from the dashed line at low frequencies and at low sound pressure levels are taken care of in the functional networks.

After being shaped in the square-root amplifier, the signal in each channel goes to a storage circuit, where it may or may not be stored. In the Instant mode, the signal is not stored. In the Peak mode, the circuit retains the highest rms value of the signal that occurs while that mode is selected. In the Hold mode, the storage circuit retains whatever the square-root amplifier output happens to be at the time the mode is selected.

⁸ However, if we look on a Zwicker diagram, we do not find a band loudness density of 9.2 sones_G per Bark for a sound pressure level of 92 dB and a center frequency of 1 kHz. Instead, we find about 8 sones_{G,F} per Bark (frontal free field). This is because, in its ISO-recommended form, Zwicker's procedure has been modified to use 1/3-octave filters instead of critical-band filters. The 1/3-octave filter centered at 1 kHz has a bandwidth of 220 Hz instead of the critical bandwidth of 160 Hz. The diagram accounts for this difference.

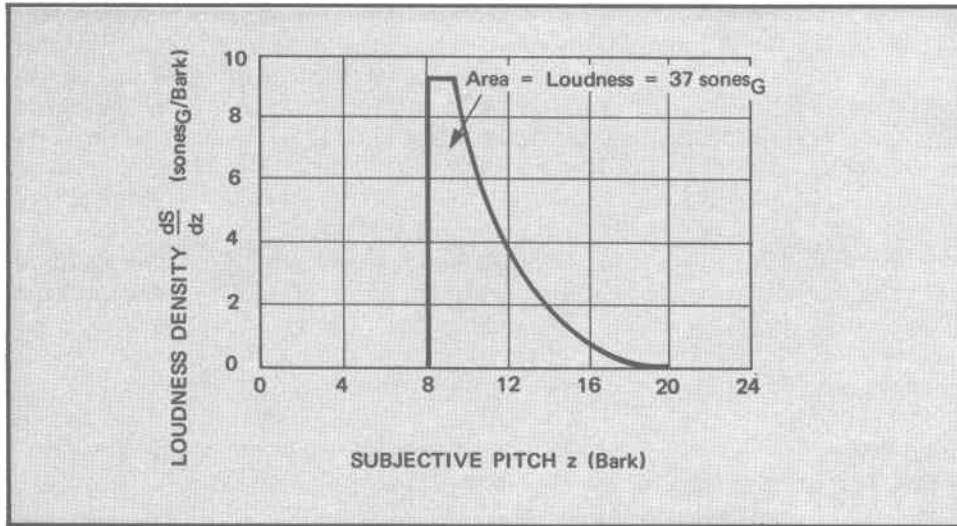

Figure 48. Masking Curve for 1 kHz Tone.

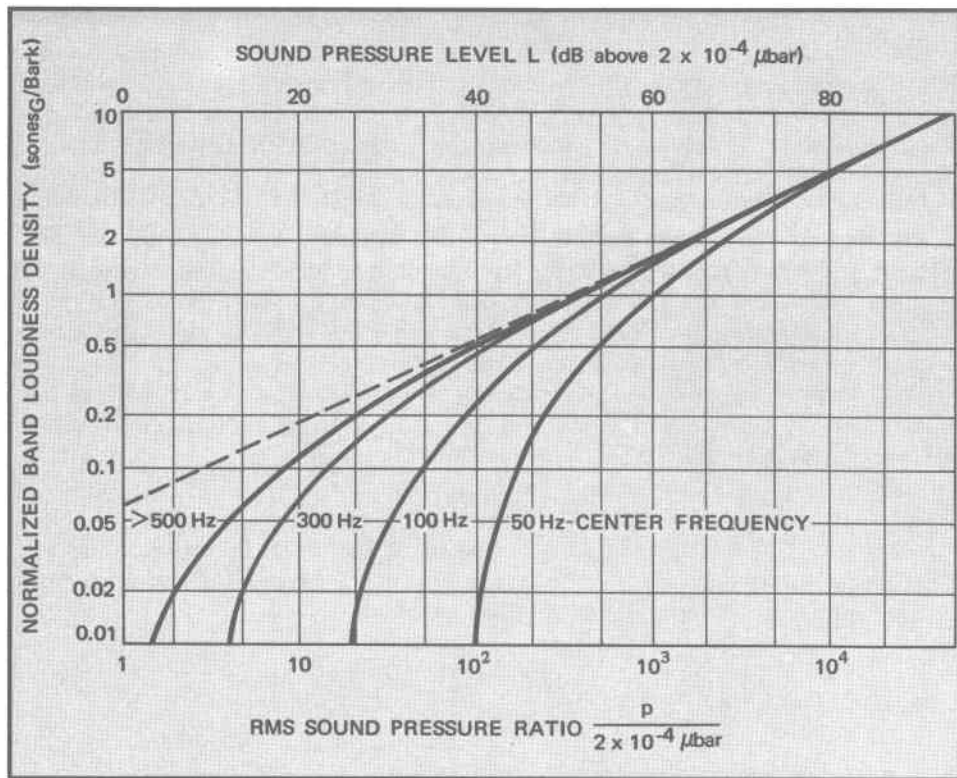

Figure 49. Normalized band loudness density as a function of rms sound pressure and center frequency.

The storage circuits are analog circuits, using capacitors as the storage elements. They have time constants of the order of one hour, long enough to ensure that the stored signal does not change by more than 5% of full scale in two minutes. Information in the storage circuits is read out 40 times per second, beginning with channel 1 and going through channel 20. The crt sweep is synchronized with the read sequence.

Each storage circuit is followed by an electronic switch which is driven by a one-shot multivibrator. A timing pulse generator triggers the channel-1 multivibrator every 25 milliseconds. The channel-1 multivibrator triggers the channel-2 multivibrator, and so on. When the multivibrator corresponding to a given channel is triggered, the storage circuit in that channel is connected to the output circuits via its electronic switch. Only one storage circuit at a time is connected to the output circuits.

The horizontal scale of the Zwicker diagram is linear in subjective pitch, which is a very nonlinear function of the logarithm of frequency. Therefore, although most of the channels are $1/3$ -octave wide, each channel has a different width on the Zwicker diagram. To give all channels the proper widths on the display, the multivibrators which drive the electronic switches all have different periods.

The 20 outputs of the electronic switches are shaped further in four nonlinear networks. These networks finish the conversion of rms sound pressure to band loudness density, i. e. the height of the horizontal portion of Zwicker's masking curve (Figure 48). Recall that the square-root amplifiers start the conversion, but leave undone some necessary shaping for low-level and low-frequency signals.

From the nonlinear networks, signals are sent to a masking circuit consisting of a peak detector, a capacitor-discharge network, and a buffer amplifier. This circuit accounts for the masking of low-level high-frequency sounds by high-level low-frequency sounds. It does this by producing an output which follows the "tails" of Zwicker's masking curves, Figure 48.

At the start of each sweep the masking-circuit capacitor is charged by the peak detector to a value proportional to the band loudness density of this channel. If the band loudness density in the next channel is higher, then when the next channel is sampled, the capacitor is charged to a voltage proportional to the higher band loudness density. If it is lower, then the capacitor is discharged until a band loudness density in one of the next channels is higher than the loudness density corresponding to the voltage remaining on the capacitor. The time constant of the discharge varies with the frequency band and the loudness density, and may change from one value to another during any particular discharge.

The output of the masking circuit is displayed on the crt. It is also supplied to a display scanner which has X and Y recorder outputs. An accurate Zwicker plot can be produced on an X-Y recorder in about 90 seconds.

2. Spectrum Analysis

Because its readout is weighted, the Loudness Analyzer is not a physical spectrum analyzer. Yet there are many applications in which the purely physical data provided by a spectrum analyzer is more useful than weighted data. These applications include measurement of acoustical properties of materials, studies of sound propagation in gases, liquids, and solids, determination of frequency response of transducers, etc. Even in subjective acoustics, we have seen that different methods of sound evaluation and the procedure for determining noise rating numbers start with physical data.

The HP 8054A Real Time Audio Spectrum Analyzer (Figure 50) divides the audio spectrum into 24 third-octave channels with center frequencies from 50 Hz to

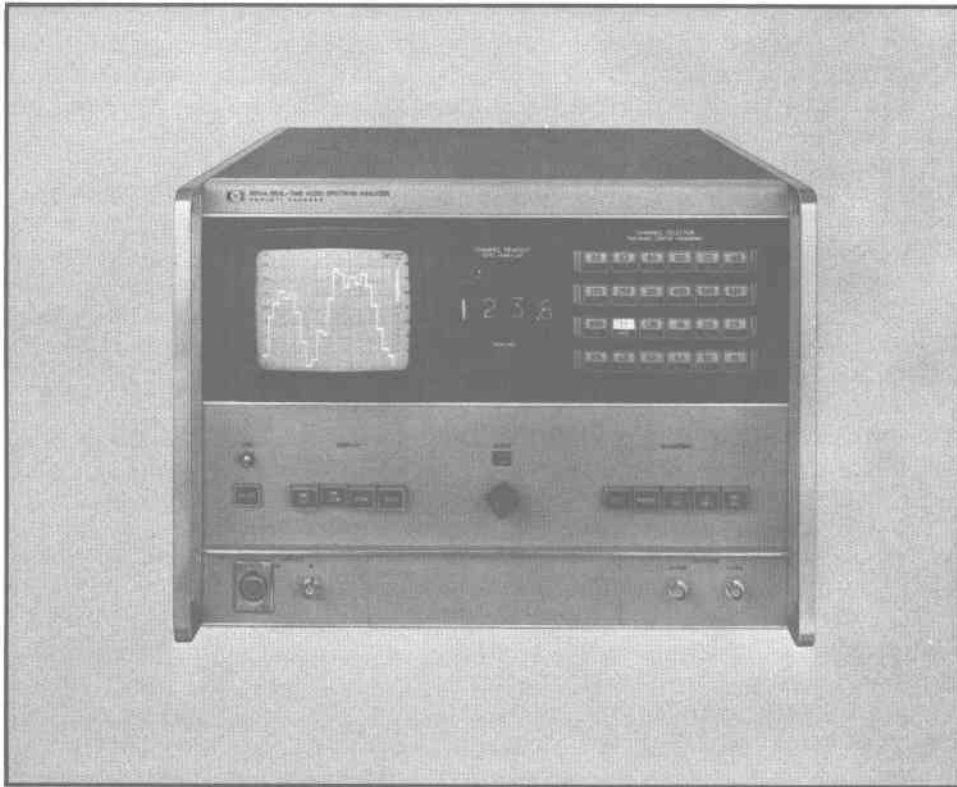

Figure 50. HP 8054A Real-Time Audio Spectrum Analyzer.

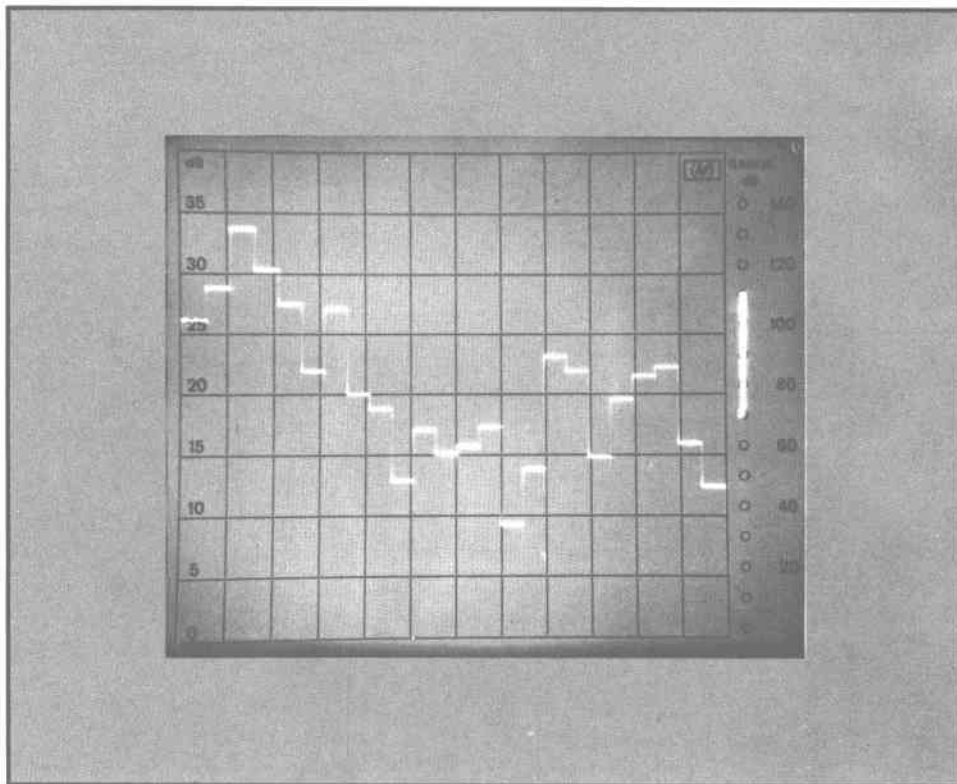

Figure 51. CRT Display of Stored Analog Outputs.

10 kHz. (Other frequencies from 2 Hz to 16 kHz are available.) Each channel has its own detector; all are scanned every 28 milliseconds, and the outputs are displayed on a crt as shown in Figure 51. Thus the data is available in essentially the same instant as the occurrence of the phenomenon itself, satisfying the definition of real-time measurements⁹.

To allow full realization of its real-time capability the 8054A has digital outputs and is remotely programmable. Therefore it can be interfaced with an instrumentation computer such as the HP 2114A. This combination is small enough to be portable, yet is sophisticated enough to handle a wide variety of tasks. Available programs include one for the direct computation of effective perceived noise level (Kryter's method — tone and time corrected) for on-the-spot evaluation of aircraft noise, another for loudness evaluation using the Stevens method.

The analyzer has four display modes: RMS Fast, RMS Slow, Peak, and Hold. The Hold mode freezes the display. The Peak mode provides true peak detection plus a semi-hold action in which a spectral line can only increase in amplitude (similar to the Peak mode of the 8051A). Maximum rms detection can be substituted for peak detection in this mode on an optional basis (making it identical with that in the 8051A).

The dynamic characteristics of the rms modes are as specified in IEC 179 (the detectors have nominal time constants of 0.1 and 1 second). We discussed the problems associated with these response modes in connection with sound level meters. Now, the 8054A has no mechanical inertia to contend with, but there is the factor of filter response (1/bandwidth). For third-octave filters, the response time is about four periods of a sinusoid at the center frequency of the filter. For the lower-frequency filters, this time becomes significant compared to the detector time constant. Thus the 8054A is not an impulse analyzer although it can be used to analyze all types of sounds (and vibrations) which have a less significant time structure.

The rms detectors in the analyzer are of the quasi-rms type. This type of detector is quite adequate in this situation; each must handle only relatively narrow-band symmetrical signals and the accuracy requirement vs crest factor is less severe than for the detector in HP sound level meters. Nevertheless, these quasi-rms detectors are more elaborate than the type discussed under sound level meters because they must be extremely linear (in terms of dc output vs rms value of the input) and have a wide dynamic range. For example, to measure toneburst signals with crest factors of 5 over a dynamic range of 40 dB with an accuracy of ± 1 dB, the detector must handle signals differing by 64 dB. With a maximum output swing of 50 volts, the minimum signal, limited by drift or diode offset voltage, is less than 30 millivolts.

A simplified diagram of the quasi-rms detector is shown in Figure 52. The input operational amplifier operates as a linear half-wave rectifier, and the output operational amplifier averages the rectified signal. Only half-wave rectification is required because the filtered signals applied to the detectors are symmetrical. The feedback operational amplifier inverts the dc output signal and so supplies the sliding bias to the rectifier. Characteristics of this detector and an average detector are compared in Figure 53. For both broad- and narrow-band noise, deviation from true rms detection is even less than 0.2 dB.

⁹ Real time: The performance of a computation during the time of a related physical process, so the results are available for controlling the physical process.

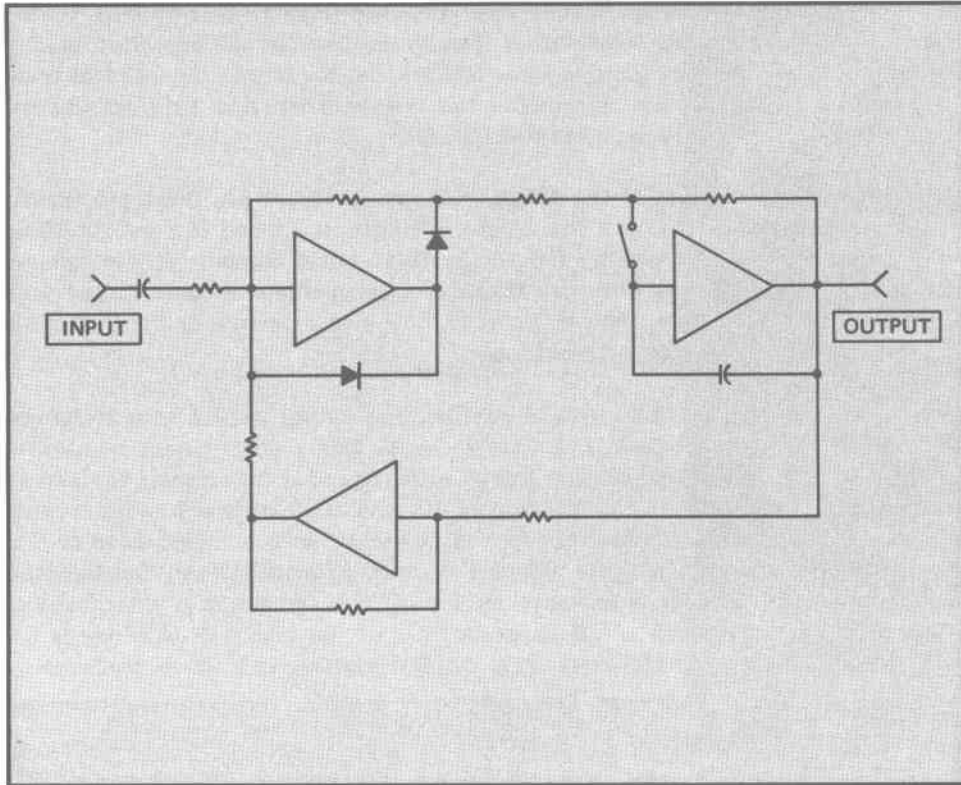

Figure 52. Quasi-rms detector of the HP 8054A

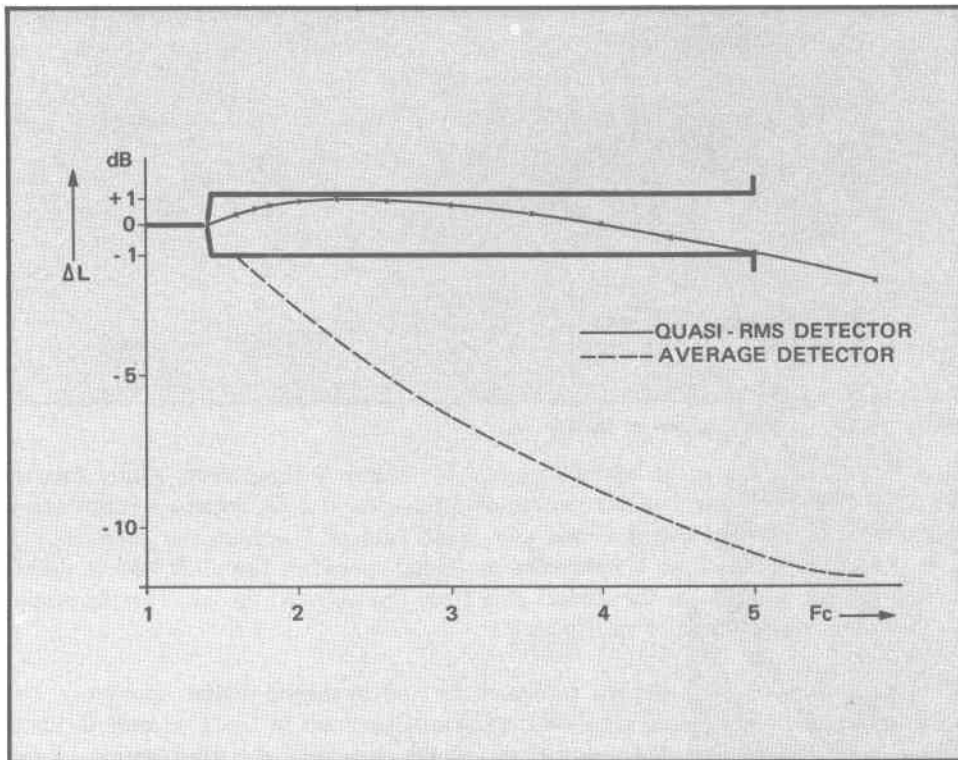

Figure 53. Deviation from true rms detection vs. crest factor for tone burst signals for 8054A quasi-rms detector and average detector

In the Hold mode, the switch in the output amplifier (Figure 52) is opened. Whatever information is on the capacitor is then stored because the capacitor has no discharge path. In practice there is some leakage, but the output changes less than 100 microvolts per second, corresponding to a change of less than 1 dB per 2 hours at full scale, less than 1 dB per minute at -40 dB.

A complete block diagram of the 8054A is shown in Figure 54. The input signal, whether from a transducer or a true electrical source, is applied to a preamplifier. The preamplifier output can be fed to the filter either directly or through an optional network. This network can take any form; perhaps a common one will be some sort of weighting network for acoustical measurements or for correcting the non-linearities of the input transducer.

The signal is applied to the filters in parallel. The output of each goes to its associated detector, rms or peak, and storage circuit. Each storage circuit is scanned by shift register I for the crt display and by shift register II for external equipment and the front-panel digital voltmeter (digital display). Shift register I operates with a clock rate of 1 kHz. It also triggers the horizontal sweep to synchronize the position of the crt beam with the selected channel. After the twenty-fourth channel is displayed, the range is indicated on the crt. This indication is a vertical bar (Figure 51) showing which 40-dB "window" out of the total 140-dB range is on display. The entire cycle, including range display, requires only 28 milliseconds.

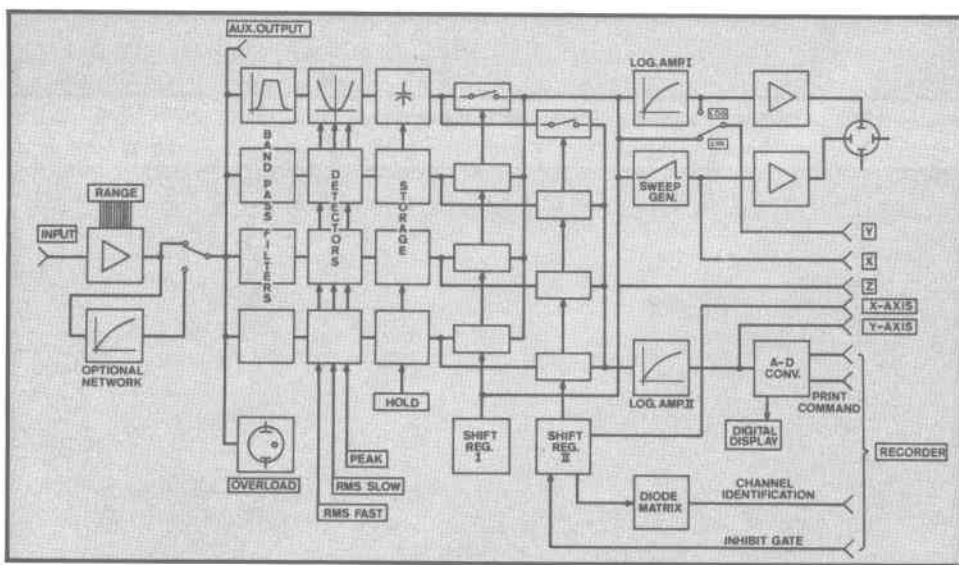

Figure 54. Block Diagram of 8054A

Shift register II scans the storage output for external equipment. When driving an X-Y recorder, this register generates an X-axis output voltage synchronized with the switching of the channels at a fixed rate of 1 second per channel. For faster equipment, such as a computer or digital recorder, the shift rate is determined by the duration of the inhibit gate from the external device. The maximum shift rate is one channel per millisecond.

The front-panel digital display is driven by the analog-to-digital converter; the display indicates the signal level of the channel selected by shift register II, identified by a brightening of a segment of the crt trace and the illumination of the corresponding channel pushbutton. The readout is in dB above 1 microvolt independent of the range selected for display on the crt.

APPENDIXES



Appendix A

Table for Converting Loudness in Phons to Loudness Level in Sones

The relationship between loudness level L_s in phons and loudness S in sones is given by

$$S = 2^{(L_s - 40)/10}$$

This relationship is tabularized below in steps of 1 phon. The value of S is found at the intersection of the units and tens values of L_s . For example, to find the number of sones corresponding to 85 phons, look under +5 opposite 80. The desired value is 22.6 sones.

Phons	Sones									
	0	+1	+2	+3	+4	+5	+6	+7	+8	+9
40	1	1.07	1.15	1.23	1.32	1.41	1.51	1.62	1.74	1.87
50	2	2.14	2.30	2.46	2.64	2.83	3.03	3.25	3.48	3.73
60	4	4.29	4.59	4.92	5.28	5.66	6.06	6.50	6.96	7.46
70	8	8.57	9.20	9.85	10.6	11.3	12.1	13.0	13.9	14.9
80	16	17.1	18.4	19.7	21.1	22.6	24.3	26.0	27.9	29.9
90	32	34.3	36.8	39.4	42.2	45.3	48.5	52.0	55.7	59.7
100	64	68.6	73.5	78.8	84.4	90.5	97.0	104	111	119
110	128	137	147	158	169	181	194	208	223	239
120	256	274	294	315	338	362	388	416	446	478
130	512	549	588	630	676	724	776	832	891	955
140	1024									

Appendix B

Preferred Frequencies for Acoustic Measurements

The preferred frequencies listed below are documented in both ISO R266 and USAS S1.6-1960. Also shown is the preferred use of these frequencies as the center frequencies for octave, half-octave, and third-octave filters.

Preferred Freq.	1 octave	1/2 octave	1/3 octave	Preferred Freq.	1 octave	1/2 octave	1/3 octave	Preferred Freq.	1 octave	1/2 octave	1/3 octave
16	x	x	x	160			x	1600			x
18				180		x		1800			
20			x	200			x	2000	x	x	x
22.4		x		224				2240			
25			x	250	x	x	x	2500			x
28				280				2800		x	
31.5	x	x	x	315			x	3150			x
35.5				355		x		3550			
40			x	400			x	4000	x	x	x
45		x		450				4500			
50			x	500	x	x	x	5000			x
56				560				5600		x	
63	x	x	x	630			x	6300			x
71				710		x		7100			
80			x	800			x	8000	x	x	x
90		x		900				9000			
100			x	1000	x	x	x	10000			x
112				1120				11200		x	
125	x	x	x	1250			x	12500			x
140				1400		x		14000			
160			x	1600			x	16000	x	x	x

NOTE: Higher and lower preferred frequencies are obtained by successive multiplication or division by 1,000.

Appendix C

Addition and Subtraction of Levels in dB

There are many instances in which we want to combine or separate sound or noise levels. The quickest and simplest method is to add or subtract the levels directly in dB using the graph below.

Addition of two levels:

- Arbitrarily call one level A, the other B.
- Find the numerical difference between A and B (i. e. $A - B$).
- Enter the graph on the abscissa at $A - B$. On the ordinate read the combined level (C) relative to B.
- Add the numerical values of B and C to obtain the true combined level D (i. e. $B + C = D$).

For example, add 77 dB and 83 dB.

- $A = 83$ dB, $B = 77$ dB.
- $A - B = 6$ dB.
- $C = 7$ dB.
- $D = B + C = 84$ dB.

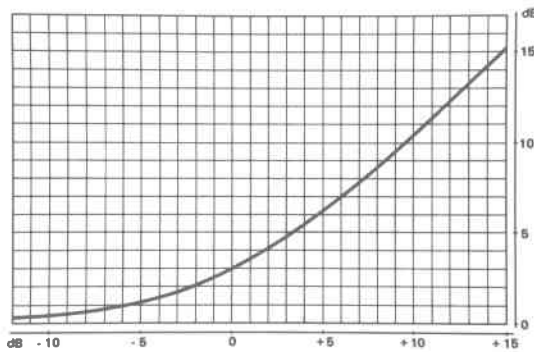

Subtraction of two levels:

- Call the higher level A, the lower B.
- Find the numerical difference between A and B (i. e. $A - B$).
- Enter the graph on the ordinate at $A - B$. On the abscissa read the numerical difference (C) between the unknown level (D) and B.
- Add the numerical values of B and C to obtain D (i. e. $B + C = D$). Be sure to retain the polarity of C.

For example, subtract 83 dB from 84 dB.

- $A = 84$ dB, $B = 83$ dB.
- $A - B = 1$ dB.
- $C = -6$ dB.
- $D = B + C = 83 + (-6) = 77$ dB.

Appendix D

ENGLISH	FRENCH	GERMAN	ITALIAN	SPANISH
Acoustic center (of a microphone)	Centre acoustique effectif	Effektives akustisches Zentrum	Centro acustico effettivo	Centro acústico efectivo
Acoustic impedance (Z)	Impédance acoustique	Akustische Impedanz	Impedenza acustica	Impedancia acústica (Z)
Acoustics	Acoustique	Akustik	Acustica	Acústica
Annoyance	Nuisance	Belästigung	Fastidio	Molestia
Atmospheric pressure	Pression atmosphérique	Luftdruck	Pressione atmosferica	Presión atmosférica
Audio range	Gamme acoustique (plage audible)	Hörbereich	Gamma di frequenze audio	Rango de audio
Band loudness density	Densité de sonie de bande	Bandlautheitsdichte	Densità di sensazione auditiva valutata in una banda critica	Densité de sonie de bande
Band pressure level	Niveau de pression acoustique dans une bande déterminée	Schalldruckpegel in einem vorgegebenen Frequenzband	Livello di pressione acustica in una banda di frequenza determinata	Nivel de presión acustica en una banda determinada
Bandwidth	Bande-passante	Bandbreite	Larghezza di banda	Ancho de banda
Broad-band noise	Bruit à large bande	Breitbandrauschen	Rumore a larga banda	Ruido de banda ancha
Center frequency	Fréquence centrale (médiane)	Mittelfrequenz	Frecuencia centrale	Frecuencia de centro
Ceramic microphone	Microphone à céramique	Keramisches Mikrophon	Microfono ceramico	Microfono de cerámica
Condenser microphone	Microphone à condensateur	Kondensator-Mikrophon	Microfono a condensatore	Microfono de condensador
Constant bandwidth filter	Filter à bande passante constante	Filter Konstanter absoluter Bandbreite	Filter a banda costante	Filtro de ancho de banda constante
Constant percentage bandwidth filter	Filter à pourcentage de bande passante constant	Filter Konstanter relativer Bandbreite	Filter a banda percentualmente costante	Filtro de porcentaje constante de ancho de banda
Contiguous filters	Filtres contigus	Angrenzende Filter	Filtri contigui	Filtro contiguo

ENGLISH	FRENCH	GERMAN	ITALIAN	SPANISH
Continuous sound	Bruit constant = bruit soutenu	Dauerschall	Suono continuo	Sonido continuo
Correction factor (of a microphone)	Facteur de correction	Korrekturfaktor (eines Mikro- phons)	Fattore de correzione (di un micro- fono)	Factor de corrección (de un micro- fono)
Crest factor	Facteur de crête	Scheitelfaktor	Fattore di cresta	Factor de cresta
Critical band	Bande critique	Frequenzgruppe	Banda critica	Banda critica
Critical bandwidth	Band passante critique	Frequenzgruppenbreite	Larghezza di banda critica	Ancho de banda critico
Detection mode	Mode de détection	Demodulationsart	Modo di rivelazione	Modo de detección
Detector	Détecteur	Demodulator	Rivelatore	Detector
Diaphragm	Diaphragme	Diaphragma	Diaframma	Diafragma
Diffuse field (diffuse sound)	Champ acoustique diffus	Diffuses Schallfeld	Suono diffuso	Campo de difusión
Diffuse field calibration	Etalonnage en champ diffus	Diffusfeld Eichung	Calibrazione per campo diffuso	Calibración de campo de difusión
Diffuse-field response (random resp)	Réponse omnidirectionnelle	Diffusfeldcharakteristik	Riposta omnidirettiva	Respuesta omnidireccional
Diffuse-field sensitivity (random sens')	Efficacité omnidirectionnelle	Empfindlichkeit im diffusen Schall- feld	Sensibilità omnidirettiva	Rendimiento omnidireccional
Directional microphone	Microphone directionnel	Mikrophon mit Richtwirkung	Microfono direttivo	Microfono direccional
Directional response pattern (directional characteristics)	Diagramme directionnel	Richtcharakteristik	Diagramma direttivo	Diagrama direccional
Distortion	Distorsion	Verzerrung	Distorsione	Distorsión
Effective perceived noise level L _{EPN}	Niveau de bruit perçu effectif	Effektiver Lästigkeitspegel	Livello re rumore effettivamente percepito	Nivel efectivo de ruido percibido
Effective perceived noisiness	Bruyance perçue effectif	Effektive Lästigkeit	Fastidio, provocato dal rumore, effettivamente percepito	Sonido efectivo percibido

ENGLISH	FRENCH	GERMAN	ITALIAN	SPANISH
Effective tone-corrected perceived noise level <small>LEPN</small>	Niveau de bruit perçu effectif du ton corrigé	Effektiver tonkorrigierter Lärmpegel	Livello del rumore effettivamente percepito, corretto per un tono	Nivel sonoro efectivo percibido de tono corregido percibido
Electrostatic actuator	Excitateur électrostatique	Elektrode für elektrostatische Eichung	Excitatore elettrostatico	Excitador electrostático
Equal loudness level contours	Courbes d'isotonie = lignes isotoniques normales	Kurven gleichen Lautstärkepegels	Curvo di equal livello di sensazione auditiva	Contorno de niveles sonoros iguales
Face plate (of a microphone)	Grille microphonique plate	Frontplatte (Mikrophon)	Piano frontale (di un microfono)	Placa protectora
Filter	Filter	Filter	Filtro	Filtro
Free (sound) field	Champ acoustique libre	Freies Schallfeld	Campo acustico libero	Campo acústico libre
Free-field calibration (of a microphone)	Etalonnage en champ libre (d'un microphone)	Freifeld Eichung	Calibrazione per campo libero (di un microfono)	Calibración de campo libre (de un micrófono)
Free-field response	Réponse en tension en champ libre	Frequenzgang im freien Schallfeld	Risposta in campo libero	Rendimiento en tensión en campo libre
Free-field sensitivity	Efficacité en tension en champ libre	Feldübertragungsfaktor	Sensibilità in campo libero	Sensibilidad de tensión en espacio libre
Frequency	Fréquence	Frequenz	Frequenza	Frecuencia
Frequency response	Courbe de réponse = réponse en fréquence	Frequenzgang	Risposta in frequenza	Respuesta de frecuencia
Frontal sound field	Champ libre à incidence normale	Frontales Schallfeld	Campo sonoro frontale	Campo frontal de sonido
Half octave	Demi octave	Halb-Oktave	Mezza ottava	Media octava
Impulse sound level meter	Sonomètre d'impulsions	Impuls-Schallpegelmesser	Misuratore del livello di suoni impulsivi	Medidor del nivel de sonido de impulso
Impulsive sound	Bruit (son) impulsif	Impulschall	Suono impulsivo	Sonido impulsivo
Interference	Interférence	Interferenz	Interferenza	Interferencia

ENGLISH	FRENCH	GERMAN	ITALIAN	SPANISH
Integration	Intégration	Integration	Integrazione	Integración
Integration time	Temps d'intégration	Integrationszeit	Tempo di integrazione	Tiempo de integración
Integrator	Intégrateur	Integrator	Integratore	Integrador
Level recorder	Enregistreur de niveau	Pegelschreiber	Registratore del livello	Grabador de nivel
Linearity	Linéarité	Linearität	Linearità	Linealidad
Loudness (S)	Sonie	Lautheit	Sensazione auditiva	Sonoridad
Loudness Analyzer	Analyseur de sonie	Lautheitsanalysator	Analizzatore di sensazione auditiva	Analizador de sonoridad
Loudness density (dS/dz)	Densité de sonie	Lautheitsdichte	Densità di sensazione auditiva	Densidad de sonido
Loudness index	Indice de sonie	Lautheitsindex	Indice di sensazione auditiva	Indice de sonido
Loudness Level (L _w)	Niveau d'isonomie	Lautstärkepegel	Livello di sensazione auditiva	Nivel de sonido
Loudspeaker	Haut-parleur	Lautsprecher	Altoparlante	Altavoz, Altoparlante
Masking	masque	Verdeckung	Mascheramento	Encubrir
Masking effect	Effet de masque	Verdeckungseffekt	Effetto di mascheramento	Efecto de encubrir
Mechanical inertia	Inertie mécanique	Mechanische Trägheit	Inerzia meccanica	Inercia mecánica
Membrane	Membrane	Membrane	Membrana	Membrana
Microphone	Microphone	Mikrophon	Microfono	Microfono
Microphone cartridge	Cartouche microphonique	Mikrophon-Kapsel	Capsula microfonica	Cartucho de micrófono
Narrow-band noise	Bruit à bande étroite	Schmalbandrauschen	Rumore a banda stretta	Ruido de banda angosta
Noise	Bruit	Geräusch, Lärm	Rumore	Ruido

ENGLISH	FRENCH	GERMAN	ITALIAN	SPANISH
Noise figure	Facteur de bruit	Rauschzahl	Cifra di rumore	Cifra indicativa de ruido
Noise rating numbers	Valeurs de bruit spécifiées	Geräuschbewertungszahlen	Valori limiti per il rumore	Cifra apreciativa de ruido
Octave	Octave	Oktave	Oktava	Octava
Omnidirectional microphone	Microphone omnidirectionnel	Mikrophon mit Kugelcharakteristik	Microfono omnidirettivo	Microfono omnidireccional
Overload	Surcharge	Übersteuerung	Sovraccarico	Sobrecarga
Particle velocity (sound particle velocity)	Vitesse d'une particule, (vitesse acoustique)	Teilchengeschwindigkeit, Schallschnelle	Velocità di una particella	Velocidad de partícula, velocidad acústica
Peak detector	Detecteur de crête	Spitzenmodulator	Rivelatore di picco	Detector de pico
Perceived noise level (L _{PN})	Niveau de bruit perçu	Lästigkeitspegel	Livello di rumore percepito	Nivel de ruido percibido
Perceived noisiness PN	Bruyance perçue	Lästigkeit	Fastidio, provocato del rumore, percepito	Ruidos percibidos
Phase shift	Glissement de phase	Phasendrehung	Sfasamento	Corrida de fase
Piezoelectric effect	Effet piézo-électrique	Piezoelektrischer Effekt	Effetto piezoelettrico	Efecto Piezoelectrico
Pistonphone	Pistonphone	Pistonphon	Pistonofono	Pistófono
Pitch	Hauteur sonore	Tonheit	Valutazione di toni	Frecuencia tonal
Plane sound field	Ondes planes progressives libres	Ebenes Schallfeld	Campo sonoro piano	Campo sonoro de plano
Polarization electrode	Electrode de polarisation	Polarisations-Elektrode	Elettrodo di polarizzazione	Electrodo de polarización
Polarization voltage	Tension de polarisation	Polarisations-Spannung	Tensione di polarizzazione	Voltaje de polarización
Precision sound level meter	Sonometre de précision	Präzisions-Schallpegelmesser	Misuratore di precisione di livello sonoro	Indicador de nivel de sonido de precisión
Pressure response	Courbe de réponse en pression	Frequenzgang des Druckübertragungsfaktors	Risposta in funzione della pressione	Respuesta de presión

ENGLISH	FRENCH	GERMAN	ITALIAN	SPANISH
Pressure calibration (microphone)	Etalonnage en pression	Druckeichung	Calibrazione in pressione	Calibración por presión (microfono)
Pressure sensitivity	Efficacité en pression	Druckübertragungsfaktor	Sensibilità di pressione	Rendimiento en presión
Pure sound	Son pur	Reiner Ton	Suono puro	Sonido puro
Pure tone	Son pur	Reiner Ton	Tono puro	Tono puro
Quasi - rms detector	Détecteur semi-quadratique	Quasi-Effektivwertmesser	Rivelatore a quasi-valore efficace	Detector de quasi-rms
Random noise	Bruit aléatoire	Statistisches Rauschen	Rumore casuale	Ruido al azar
RC averaging detector	Détecteur RC à réponse moyenne	RC Mittelwertmesser	Rivelatore a valore medio RC	Detector de promedio RC
RC time constant	Constante de temps RC	RC Zeitkonstante	Costante di tempo RC	Constante de tiempo RC
Reciprocity calibration (microphone)	Etalonnage réciproque	Reziprozitäts-Eichung	Calibrazione di reciprocità	Calibración por reciprocidad
RMS detector	Détecteur quadratique	Effektivwertmesser	Rivelatore a valore efficace	Selector de RMS
Root extraction network	Réseau d'extraction de racine	Radizierendes Netzwerk	Circuito per l'estrazione della radice	Circuito extractor de raíz
Sensitivity	Efficacité	Empfindlichkeit	Sensibilità	Rendimiento
Sensitivity factor	Facteur de sensibilité	Empfindlichkeitsfaktor	Fattore de sensibilità	Factor de sensibilidad
Sound	Son	Schall	Suono	Sonido
Sound field	Champ acoustique	Schallfeld	Campo acustico	Campo acústico, Campo de sonido
Sound intensity	Intensité (acoustique) sonore	Schallintensität	Intensità (acustica)	Intensidad de sonido
Sound intensity density (W/m ² /Hz)	Densité d'intensité sonore	Schalllichte	Densità di intensità sonora	Densidad de intensidad de sonido
Sound level calibrator	Calibrateur de niveau de bruit	Schallpegelrichtgerät	Calibratore del livello sonoro	Calibrador de nivel sonoro

ENGLISH	FRENCH	GERMAN	ITALIAN	SPANISH
Sound level meter	Sonomètre	Schallpegelmesser	Misuratore di livello sonoro, sonometro normalizzato	Indicador de nivel sonoro
Sound pressure	Pression acoustique	Schalldruck	Pressione sonora	Presión de sonido
Sound pressure level	Niveau de pression acoustique	Schalldruckpegel	Livello di pressione acustica	Nivel de presión de sonido
Spectral component	Composante spectrale	Spektralkomponente	Componente dello spettro	Componente espectral
Spectral composition	Composition spectrale	Spektrale Zusammensetzung	Composizione dello spettro	Composición espectral
Spectral distribution	Répartition spectrale	Spektralverteilung	Distribuzione spettrale	Distribución espectral
Spectrum (sound)	Spectre (acoustique)	Schallspektrum	Spettro (acustico)	Espectro (de sonido)
Spectrum analyzer	Analyseur de spectre	Spektrumanalysator	Analizzatore di spettro	Analizador de espectro
Spherical field	Champ acoustique sphérique	Sphärisches Feld, Kugelfeld	Campo sferico	Sonido esférico
Square-law function	Fonction quadratique	Quadratische Funktion	Funzione quadratica	Función de ley del cuadrado
Squaring circuit	Circuit éleveur au carré	Quadrirschaltung	Circuito squadratore	Circuito de cuadración
Strip-chart recorder	Enregistreur à déroulement	Streifenschreiber	Registatore a carta mobile	Inscriptor
Subjective pitch	Hauteur sonore subjective	Subjektive Tonheit	Valutazione soggettiva di toni	Frecuencia tonal subjetiva
Third octave	Tiers d'octave	Terz, Dritteoktave	Terzo di ottava	Tercera octava
Threshold of hearing	Seuil d'audition (de perception)	Hörschwelle	Soglia di udibilità	Umbral de sonido
Threshold of pain	Seuil de la douleur	Schmerzschwelle	Soglia di dolore	Umbral de dolor
Tone burst	Impulsion sonore	Tonimpuls	Breve suono improvviso, monotono	Explosión tonal
Tone - corrected perceived noise level (L _{TPN})	Niveau de bruit perçu du ton corrigé	Tonkorrigierter Lästigkeitspegel	Livello di rumore percepito, corretto per un tono	Nivel sonoro de tono corregido percibido

ENGLISH	FRENCH	GERMAN	ITALIAN	SPANISH
Total perceived noisiness (N)	Bruyance perçue totale	Gesamte Lästigkeit	Totale fastidio, provocato dal rumore, percepito	Total de ruidos percibidos
Transducer	Capteur, transducteur	Wandler	Trasduttore	Sensor
Transmission loss (of a filter)	Perte de transmission	Übertragungsverlust	Perdita di trasmissione	Pérdida de transmisión
Wave analyzer	Analyseur d'ondes	Frequenzanalysator	Analizzatore d'onda	Analizador de ondas
Wave length	Longueur d'onde	Wellenlänge	Lunghezza d'onda	Carga de onda
Weighting curve	Courbe de pondération	Bewertungskurve	Curva di pesatura	Curva formada
Weighting network	Réseau de pondération	Bewertungsnetzwerk	Rete di pesatura	Circuito formativo
White noise	Bruit blanc	Weisses Rauschen	Rumore bianco, suono bianco	Ruido blanco
X-Y recorder	Enregistreur X - Y = table tracante	X-Y-Schreiber	Registatore X-Y	Inscriptor X-Y

Appendix E

International and US Standards

International

IEC 50(08)	International Electrotechnical Vocabulary, (Group 08) Electro-Acoustics (2nd edition — 1960)
IEC 123	Recommendation for sound level meters
IEC 179	Specification for precision sound level meters
ISO R131	Expression of the physical and subjective magnitudes of sound or noise.
ISO R226	Normal equal loudness contours for pure tones and normal threshold of hearing under free-field listening conditions.
ISO R266	Preferred frequencies for acoustic measurements
ISO R357	Expression of the power and intensity levels of sound or noise
ISO R362	Methods of measurement of noise emitted by vehicles
ISO R454	Relation between the loudness of narrow bands of noise in diffuse-field and in a frontally incident free-field
ISO R495	General requirements for the preparation of test codes for measuring the noise emitted by machines
ISO R507	Procedure for describing noise around an airport
ISO R532	Procedure for calculating loudness level

U.S.

S1.1—1960	Acoustical Terminology (Including Mechanical Shock and Vibration)
S1.2—1962	Method for Physical Measurement of Sound
S1.4—1961	Specification for General-Purpose Sound Level Meters
S1.5—1963	Practices for Loudspeaker Measurements
S1.6—1960	Preferred Frequencies for Acoustical Measurements
S1.10—1966	Method for the Calibration of Microphones
S1.11—1966	Specification for Octave, Half-Octave, and Third-Octave Band Filter Sets
S1.12—1967	Specifications for Laboratory Standard Microphones
S3.4	Procedure for the Computation of the Loudness of Noise (Proposed)
Y10—11—1953	Letter Symbols for Acoustics
Z24.24—1957	Procedures for Calibration of Electroacoustic Transducers (Particularly those for Use in Water)

International standards can be obtained from:

International Organization for Standardization
1 Rue de Narembé
Geneva, Switzerland

U.S. standards can be obtained from:

United States of America Standards Institute
10 East 40th Street
New York, N. Y. 10016

