

**GERNSBACK'S EDUCATIONAL LIBRARY. No. 2**

**HOW TO MAKE THE  
MOST POPULAR  
ALL WAVE  
1 and 2 TUBE RECEIVERS**

**10  
CENTS**

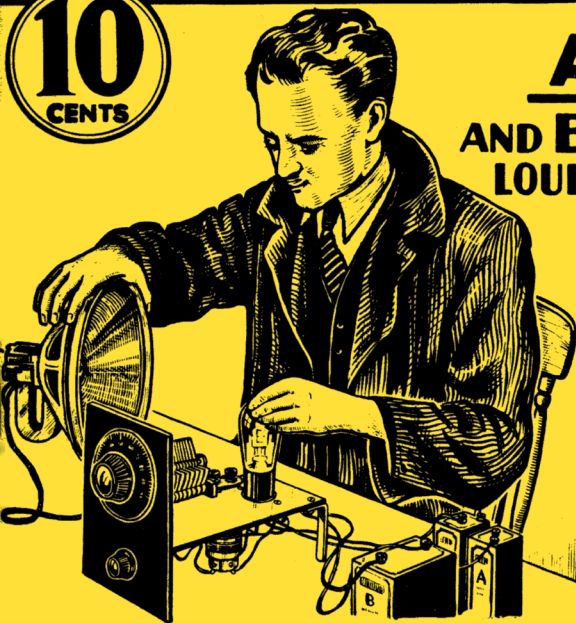

**A.C.  
AND BATTERY  
LOUDSPEAKER  
SETS**

**RADIO PUBLICATIONS, 25 W. BROADWAY; NEW YORK, N.Y.**

## The "Megadyne" One-Tube Loudspeaker Set

By Hugo Gernsback

**I**N this article, the author describes the first practical one-tube loudspeaker set using a pentode tube. The set has been tested experimentally in a number of locations in the metropolitan New York district by several independent experimenters. In all instances, its performance was astonishing; not only did it bring in all locals on the loudspeaker with sufficient volume to fill a large room comfortably, but distant stations as well.

Such stations as KDKA Pittsburgh, WTAM Cleveland, WBZ Springfield, WTIC Hartford, Conn., and many others were received with fair loudspeaker strength.

Experimenters and fans who have looked forward to a REAL one-tube set now have their wish fulfilled.

**T**HE advent of the new and more efficient tubes has made it possible to build radio sets which were not dreamed of five years ago. I have often stated editorially, that the radio art is headed in a direction where in the near future, it will be possible to obtain as much volume from a single one-tube set as we formerly obtained with a seven or ten-tube set.

### Development of the Megadyne

Some time ago, I started to experiment with the idea of producing a one-tube loudspeaker set that would actually work and could not be classed

as "tricky". I thought that the efficiency of the screen-grid and pentode

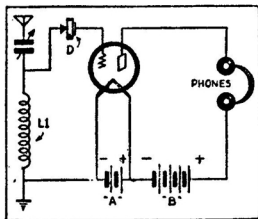

Fig. 1—Showing "Interflex" Circuit

tubes would make this possible. A few of them were tried in all sorts of circuits, but it was found that no matter how good the usual circuit arrangements were, the volume that could be obtained from a loudspeaker was not sufficient to call it loudspeaker volume.

I then resurrected my old *Interflex* idea, a circuit that I devised in 1925. This circuit was exceedingly popular at the time and several hundred thousand receivers using this circuit were built all over the world. To

those who have forgotten the circuit, and to those who were not in radio at the time, I outline the circuit herewith in its fundamentals.

Figure 1 shows how the crystal detector is connected directly into the grid of a tube. The circuit is not of the reflex type, nor is there regeneration in any form. The crystal in the grid circuit acts as the *detector*, while the vacuum tube acts as an *amplifier*. The amplification obtained, depending upon the sensitivity of the crystal, is from 10 to 20, and may be

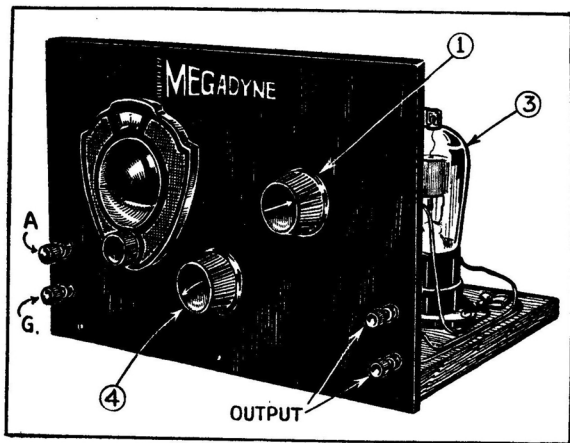

Fig. A.—Front View of 1-Tube "Megadyne."

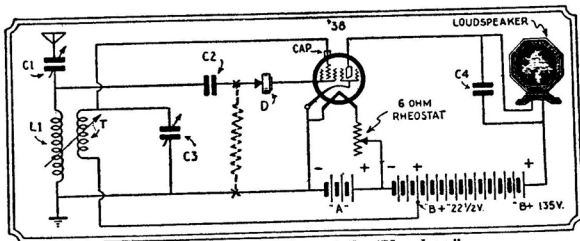

Fig. 2.—Schematic Diagram of the "Megadyne."

greater in some cases. In other words, by using a crystal detector, the addition of the tube will give real amplification. The circuit is remarkable in that there is no distortion and the reception of the signal is clearer than when the tube is used alone; it being well known by radio engineers that the present vacuum tubes are poor detectors, whereas, due to the perfect rectification possible, there is nothing better than a crystal detector for clarity.

The Interflex system is made use of in the Megadyne (*me-gas*, the Greek for great; *dyne* from the Greek for power) and the results are astonishing. The final circuit of the one-tube loudspeaker set is illustrated in Fig. 2. It will be seen immediately that an entirely new circuit is used and, as a matter of fact, it will be noted that the tube works "backwards." The positions of the screen-grid and the control-grid have been reversed; the writer found that in practice this combination gave far greater amplification than the straight circuit. The

reason for this is probably to be found in the better utilization of the space charge.

When building the Megadyne set, be sure to follow the circuit exactly, and for best results use the parts specified. Fig. A and B clearly show the layout of the components on the panel and base board.

Referring again to the circuit, we first have condenser C1, which is used to tune the antenna. Its capacity is .00032-mf. C2 is a small molded bypass condenser .00025-mf. It is a new addition to the *Interflex* idea, and is quite necessary in this circuit. It will be found that the circuit does not operate well without the condenser at this point. Remember that all connections between C1 and the screen grid of the tube should be just as short as possible. They cannot be too short.

As to the crystal detector, in the *Interflex* circuit, I recommend the use of a Carborundum detector. It is still perhaps the best detector for this purpose, but unfortunately it is



no longer manufactured. I therefore substituted a fixed crystal detector which is of the iron pyrite variety and which works very well in this particular circuit. I do not recommend a galena detector as it is not stable enough. Next to carborundum, iron pyrites is the best.

*Note that, in this circuit, the crystal detector works best in only one direction.* Try reversing its connections, and you will quickly find out which is best. It is not possible to do this on locals as the circuit will be found to work even without the crystal for strong locals. It is only on distant stations when the necessity and superiority of the crystal detector becomes apparent. When trying to ascertain which is the best position for the crystal, tune in a DX or weak station and then find out which way it works best.

Regarding the tube, the circuit will be found to work well with such tubes as the 6SJ7, 42, 38, 1N5G. I found, however, that the best results are obtained with a 38 tube.

Condenser C4 may be .00025-mf. to .0005-mf. The best one is ascertained by experiment. Condenser C3 is of the variable compression type, obtainable on the market, the value being from .0003-mf. to .001-mf. *This condenser, while adjustable, is not used as a variable, and once adjusted remains in that position.*

As to the loudspeaker, remember, we have not any too much volume, and for that reason only a good magnetic loudspeaker will perform well. I have used successfully the better magnetic types which are available now.

Regarding batteries, the '38 tube uses 6.3 volts; the current consumption is low, i.e., .3-ampere. You can

### Most Popular All-Wave Receivers

either use a 6-volt storage battery, or otherwise five new dry cells.

"B" Voltage: I recommend the use of 135 volts, though the set will be found to work well with only 90 volts.

The novelty of operation lies in the fact that the so-called screen-grid voltage connects to the control-grid — the cap of the tube.

And here is where some caution is necessary. If you use 135 volts, take a tap of 22½ volts figured from the *negative end of the "B" battery*. This tap goes to one side of the tickler as shown.

The three circuit tuner as used in this circuit may be any good type as long as it follows specifications. The secondary is wound on a bakelite or ordinary cardboard tube 2½ inches high. The tube is wound full 1¾ inches with No. 30 D.C.C. wire. There are 68 turns all together. The tickler measures 1½ inches in diameter and about 1¼ inches wide. It is wound with the same size and kind of wire as the secondary, and there are 32 turns all together. The three circuit tuner specified has the usual primary. In this set it is not used and no connections are made to it.

### Additional Notes

**CAUTION.** The tap on the "B" battery should not be more than 22½ volts, counting from the — B side. Considerably louder signals may be obtained by increasing this voltage to 45 volts, and here is where you *have to be careful*. Certain types of tubes if used with a voltage higher than 22½ will "cherry" the grid, that is — due to the extra current flowing — the grid becomes overtaxed. If you find that the grid gets red hot, disconnect the extra voltage immediately

and go back to  $22\frac{1}{2}$  volts, as otherwise you will damage the tube; but this does not apply to all tubes. Certain tubes as, for instance RCA, 38 are not affected in this manner, and they will take as high as  $67\frac{1}{2}$  volts on the control grid without cherrying. Therefore, always be sure to watch

the grid and see that it is not overloaded. I may add that I have not found any tubes that give better results (louder signals) when a voltage higher than 45 is used on the control grid.

Condenser C3 is important because it adds to the volume of the signal.

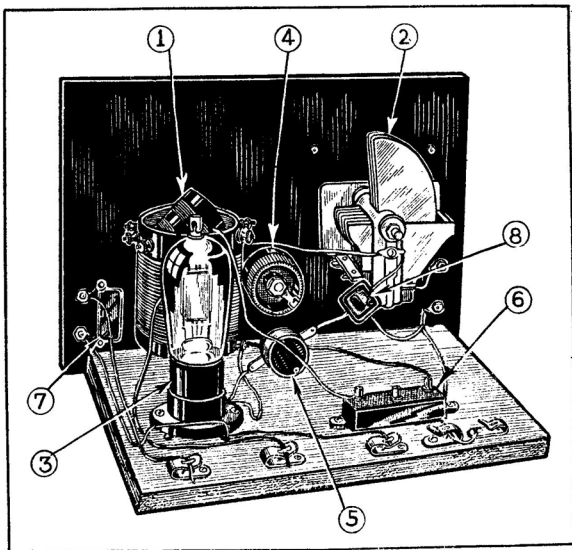

**Fig. B.—Rear View, Showing Placement of Parts.**

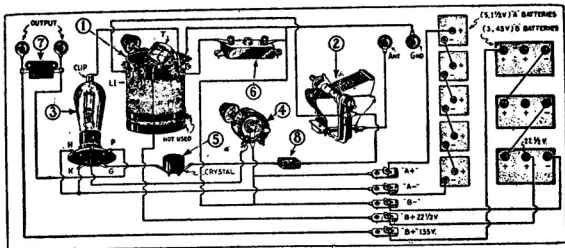

Complete Pictorial Layout and Electrical Connections for the "Megadyne."  
Designating numbers correspond with those on Fig. B.

It is critical and should be adjusted to the lower waveband (higher frequencies). Select a station between 200 and 250 meters. The signal should not be too loud. Then with a screwdriver, which should be insulated, begin *slowly* to adjust the adjustable condenser. You will find that adjusting this condenser also affects the tuning somewhat. It will, therefore, also be necessary to adjust the tuning condenser C1 slightly until you reach a point in your adjustment of C3 where the signal comes in loudest. Some tubes have a tendency to "motorboat" — a sort of clucking, puttering noise is heard in the loud speaker: condenser C3 corrects this condition to a great extent. When the best adjustment has been found for the lower waveband, leave the condenser and do not touch it thereafter. Do not use too much regeneration because you will then get distortion although the signal will be louder. Best results will be obtained when the set

oscillates slightly, or is just below the oscillating (whistling) point.

If, in rare instances, you find you cannot get the set to oscillate, try increasing the capacity of condenser C4. A large condenser here sometimes helps. If the set still refuses to oscillate, it will then be necessary to use a higher voltage on the control grid. Try 45 volts with a series resistance so as to keep the grid from getting red.

Sometimes reversing the polarity of the tube heater or tickler leads helps.

If the set tends to "choke up", indicating that the signal grid is "blocking" it may be necessary to shunt 25 to 7 megohm gridleak across the signal grid (screen-grid of the tube) and cathode. This is indicated on the schematic diagram at the points marked "X". It might be well to use a variable gridleak.

Outside of this, the set will probably not be found to be tricky.

Of course, the set may also be used with headphones substituted for the loudspeaker, and in this manner it will be able to get more stations because naturally stations several thousand miles away are not received on the loudspeaker except under unusual conditions. The set is really remarkable for DX work.

One word as to aerial and ground. The specifications given here presuppose an aerial about 125 feet long including lead-in. On shorter or longer aerials, changes should be made in the secondary winding of the coil, although it may be corrected to some extent by using a small series condenser in series with the antenna or ground.

**List of Parts**

- One tuner (for .00032-mf. tuning condenser);
- One Hammarlund 320 mmf. variable condenser;

- One Type '38 pentode tube;
- One Carter 6-ohm rheostat;
- One BMS fixed crystal detector;
- One Padder Condenser, .0003- to .001-mf.;
- One .00025- (or, .0005-) mf., mica fixed condenser;
- One Aerovox .00025-mf. fixed condenser;
- One 5-prong tube socket;
- Four Eby binding posts;
- Five Fahnestock clips;
- One roll hookup wire;
- Two Kurz-Kasch, 1½ in. knobs;
- One Kurz-Kasch vernier dial (scale 0-100, reading clockwise);
- One bakelite panel, size 7 x 10 x 3/16-in.;
- One baseboard, 5-ply size 7 x 10 x ½-in.

Note: Parts of different manufacture may be used, *but* their electrical specifications must be the same as those specified above.

## Electrifying the Megadyne for 110 Volts A.C. or D.C.

By Hugo Gernsback

**I**N the preceding article in this book was described a battery-model "Megadyne", the loudspeaker set that requires only one tube—a pentode, and a crystal. In the following description will be found all the details for operating this remarkable receiver from the house current, thus entirely eliminating batteries.

The only fundamental difference between the battery set and the electric set, is the use of a simple "B" eliminator. The original set was designed to use a "uni-potential cathode" type of tube, the '38, which possesses two outstanding advantages: First, the rugged filament may be operated with full efficiency under wide fluctuation in the filament voltage supply which may be either A.C. or D.C. Second: the thermal lag of the heater, and the uni-potential characteristic of the cathode, prevent the

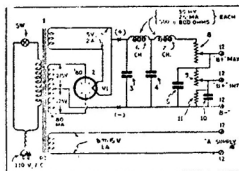

Fig. 2.—Schematic Diagram

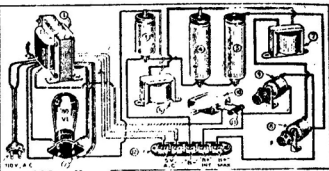

Fig. 1.—Pictorial Layout of Power Unit

reproduction of hum when the filament is supplied with raw A.C.

This essential unit for electrifying the Megadyne, the "B" eliminator, is illustrated in Fig. A; Fig. 1 gives a pictorial diagram of connections and the schematic circuit is shown in Fig. 2.

Although this unit has been built up in "breadboard" style, for convenience in illustrating, the experienced constructor will have no difficulty in making a more compact arrangement. Inexperienced constructors are cautioned to observe a few fundamental rules, should they desire to rework the parts layout to suit a particular condition.

An important point, and the one to which particular attention *must* be paid, is the adjustment of variable resistor 9 which controls the voltage at terminal B-PLUS INT.—the potential for the control-grid (cap lead) of the '38. *If this potential is permitted to exceed a certain critical value the grid will be seen, in a darkened room, to glow cherry-red, and continued application of this voltage, which is considerably beyond the setting for*

best operation, *will result in the destruction of the pentode.*

A full-wave type 80 rectifier tube is employed for smooth D.C. output; the power transformer must be designed to deliver secondary potentials of 6.3 volts for the filament of the '38 pentode; 5 volts for the filament of the 80 rectifier tube and 275 volts on each side of the center tap of the secondary.

Residents of D.C. districts may be interested to note that by breaking the leads of this power unit at X, to eliminate the power transformer and rectifier, and connecting the two wires to the 110 V., D.C. power-line leads having the polarities indicated, (reversing the plug in the socket will check this condition), D.C. plate supply will then be available; the final step, to obtain filament current from a D.C. power circuit, is to connect the filament terminals to the light-line, with a 35- or 40-watt lamp in series. Fuses rated at 2 Amperes *must* be connected in both sides of the power line; a ground is not necessary, a .01-mf. fixed condenser should be connected in series with the aerial of the receiver when used with the D. C. power pack.

**Caution:** The electrolytic condensers should be of the *unpolarized* type if the pack is to be operated on D.C. or else the fuses will blow.

Due to the design of this power unit, it is possible, whether operated from 110 volts D. C. or A. C. to secure very flexible control of the output potentials, by adjustment of resistors 8 and 9. Electrolytic by-pass condenser 5 is particularly effective as resistor 8, in ad-

dition to acting as a voltage-limiting unit, also functions as a part of the filter system.

In the "breadboard" model, a common "can" connection for the three electrolytic condensers is obtained by mounting them on a strip of aluminum, about  $\frac{3}{4}$  x  $5\frac{1}{2}$  x  $\frac{3}{32}$ -in. thick, supported,  $\frac{3}{4}$ -in. from the base-board by means of two metal brackets. The new electrolytic condensers in

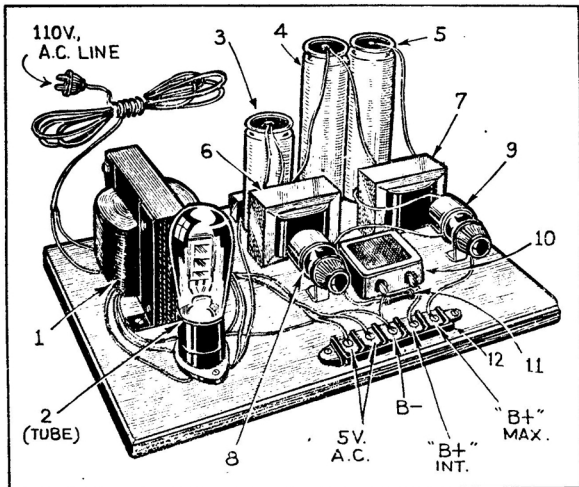

Fig. A.—Completely assembled Power Unit. Numbers correspond with Figs. 1 and 2

cardboard containers may be used too, in place of those in cans, if so desired. Resistors, 8 and 9 are rheostats mounted on brackets.

Exceptional care has been taken in the design of this unit to reduce the hum level at the output potential terminals to the lowest possible point; however, the fields of the power transformer and the filter chokes are very strong, and if they are permitted to interact with the receiver equipment, hum from the reproducer will be heard. It is good policy to keep the power pack as far from the receiver as space permits—three feet at least.

Resistors 8 and 9 are adjusted so that stations come in loudest. The adjustments are then left in position and should not be touched thereafter.

Tuning and operating the Megadyne remains as before.

#### List of Parts

- One power transformer, having one 6.3 volt winding rated at 2 amperes or more; one 5-volt winding at 2 amperes; one center-tapped winding at 275 to 350 volts either side of the center tap;
- Two filter chokes, each 30 henries, 25 ma. 500 to 800 ohms 6, 7;
- One unpolarized electrolytic condenser, 4 mf., 400 volts, 3;
- Two electrolytic condensers, 8 mf., 400 volts, 4, 5;
- Two Clarostat variable rheostats, type CS, 0 to 5 megohm range, 20 watts 8, 9;
- One 1-mf., 200-volt condenser, 10;
- One fixed resistor, 10,000 ohms, 1 watt, 11;
- One binding post strip, 12;
- One tube socket, UX-type, for V1,2;
- One power cable, with plug;
- One wood baseboard, 7½ x 11½ x ½-in.

## A Beginners' "All-Electric" 1-Tube A.C. - D.C. Set

By F. R. Harris

**T**HE first really one-tube ALL-ELECTRIC Set using VACUUM-TUBE rectification. Operates on any 110-volt line, any current and frequency. The ideal Beginner Set.

**T**HIS set was the first really 1-tube all-electric receiver ever to be built. There have since been others, but none before! There have been sets which were

technically, of the 1-tube variety, obtaining their power from copper-oxide rectifier stacks and similar expedients; but the complication and expense of these methods greatly overbalanced the advantages gained through the elimination of the separate rectifier tube. It was the introduction of the 12A7 tube which made this set possible;—the very first tube which combined a power output pentode and a half-wave rectifier in the same glass envelope.

The receiver worked very well and is highly recommended to all experimenters and radio fans.

The completed set is shown in Figs. A and B. The schematic circuit is in Fig. 1.

### The 12A7 Tube

The tube is the heart of this circuit — without it, the circuit would be impossible. Its characteristics combine those of two regular tubes. The glass envelope, of the standard size known as ST12, is the same size and shape as that used for type 58 and 77 tubes and others; it contains a pentode section practically identical with the type 38 tube, and in addition, a half-wave rectifier element. Each has its own cathode and its own separate base pins. The base is of the small 7 pin type and the control-grid of the pentode is connected to the tube cap. Base connections for the tube are given in Fig. 1.

### Construction

As will be seen from the illustration, the set is laid out on an aluminum chassis. The complete layout for the two chassis pieces is given in Figs. 2 and 3. If other than the specified parts are used the layout will, of course, have to be changed accordingly.

The tuning condenser is mounted on the front panel through the medium of two No. 6-32 bolts. Several small washers or other form of spacer are placed over each screw between the panel and frame of the condenser to hold it parallel to the front panel.

The filament resistor, R5, is mounted upright through a single

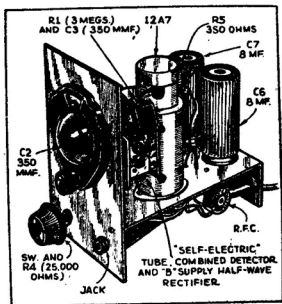

Fig. A.—Set Ready for Operation

hole in the sub-panel by means of one of the screws that will be found holding the brackets. A cardboard tube is generally packed around the resistor on which are marked lines indicating one-eighth of the total resistance; if you do not have available a voltmeter to set the filament voltage across the tube to its proper value it can be arrived at approximately by setting one end sliding contact opposite the first of these marks. This filament resistor becomes quite hot in operation so do not fail to remove the cardboard tube and keep all insulated wires well clear of this resistance.

In mounting the jack for the phone plug be sure that the frame and lock nut are well insulated from the chassis. Otherwise you will have a direct short across the power supply which will probably ruin the rectifier section



of the 12A7 tube. Also be sure that the center arm of the potentiometer R4 is not grounded to the chassis or it will be impossible to control oscillation.

When you are absolutely sure that all wiring is correct, you may insert the line plug and turn on the switch. After a few seconds a bright point of light will be seen inside the cathodes of the tube and they will gradually heat up to a dull red glow. The circuit is then ready to operate. If D.C. is being used, it may be necessary to reverse the plug.

Warning: The post marked "Gnd" on the diagram is not to be connected to a ground unless it is absolutely necessary to do so to secure quiet operation and then only after a 0.5-

mf. paper condenser has been inserted between the ground wire and the "Gnd" post on the set. Do not permit the ground wire to touch the metal chassis.

Attach the antenna, and plug in the headphones. Screw the adjusting screw on C1 almost all the way in and turn R4 all the way to the right. Now, on turning the tuning dial from one end to the other a series of squeals should be heard. If this does not occur it indicates that the circuit is not oscillating. Turn back the screw on C1 slightly and try again. Keep trying this until oscillation occurs all over the dial with C1 screwed in as tightly as possible.

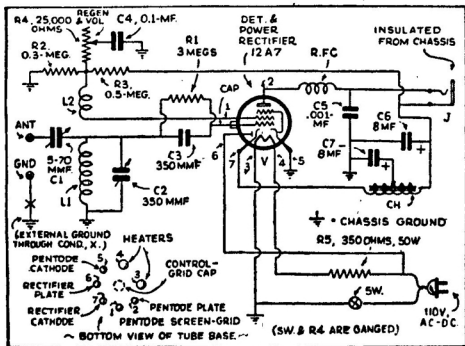

Fig. 1.— Complete schematic diagram of the 1-Tube All-Electric Set. When using an external ground be sure to use a series condenser at the point in the diagram marked with an "X"

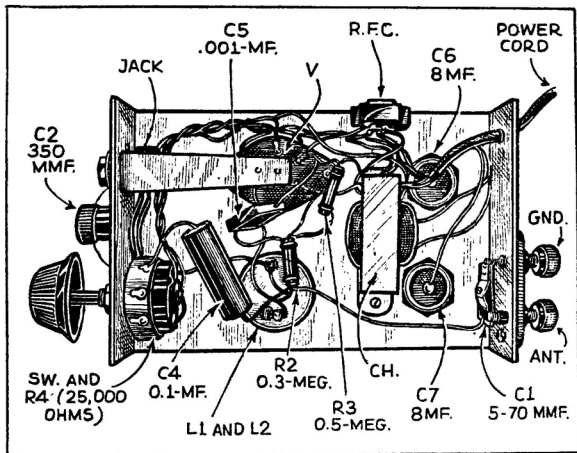

Fig. B.—Underside View Showing Layout of Parts

The position of C1 will depend greatly on the aerial used, the longer the aerial the looser C1 will probably have to be since a long aerial loads the circuit and keeps it from oscillation. However, a long aerial is necessary for proper pickup and for any DX work. About 75 feet, as high as possible and well insulated would be about right.

Once the proper position for C1 is found it may be left alone and the only controls necessary will be the tuning dial and R4 for feed back.

Like any oscillating circuit, the most sensitive point will be found just outside the zone of oscillation. Slow, careful tuning and skillful handling of the oscillation will result in some rather remarkable DX records for such a simple set.

### Theory

There is nothing remarkably new in any single feature of the set, the novelty results from the combination of features in a single unit. The signal, picked up by the antenna is fed



This had better be adjusted by means of a voltmeter to the proper value if possible.

### Troubles

#### No Oscillation:

Reverse connections to L2.

Be sure condenser C4 is non-inductive type.

Be sure choke RFC is effective.

Raise screen-grid voltage by decreasing value of R3.

As a last resort increase turns of L2.

Be sure R4 is connected in the right direction: so that when the line switch is off the resistance is all in.

#### Uncontrollable Oscillation:

Decrease screen voltage by increasing value of R3.

Decrease value of C4.

Remove choke RFC, if this completely stops oscillation decrease value of C5.

Check circuit for unwanted sources of feed-back.

As a last resort decrease turns on L2.

#### Fringe Howl on "Pop":

This is controlled largely by the value of R2; the smaller this value the more smoothly oscillation occurs down to the point where control through R4 is lost.

The voltage on the screen-grid is rather critical in this circuit. If it is too low the circuit will not oscillate and will be less sensitive generally. If it is too high it may cause an annoying 60 cycle hum in the phones. The trick is to get it as high as possible without allowing this hum to occur or causing uncontrollable oscillation. This voltage is governed by the network R2, R3, and considerable experimentation

with these two values will probably be rewarded with greatly increased sensitivity and better all-around performance.

### List of Parts

One midjet tuning condenser, 350 mmf., C2;

One Hammarlund trimmer condenser, 5-70 mmf. C1;

One pig-tail mica condenser, 350 mmf., C3;

One pig-tail mica condenser, .001-mf., C5;

One paper condenser, .1-mf., C4;

Two electrolytic condensers, 8 mf., C6, C7;

One Centralab potentiometer with line switch attached, 25,000 ohms, R4;

One carbon resistor,  $\frac{1}{2}$ -W., 0.3 meg., R2;

One carbon resistor,  $\frac{1}{2}$ -W., .5-meg., R3;

One carbon resistor,  $\frac{1}{2}$ -W., 3 mega., R1;

One wire-wound resistor, 350 ohms, 50 W., R5;

One R.F. coil, screen-grid interstage, shielded, L1, L2;

One 85 mhy. RF. choke coil, RFC.;

One midjet filter choke, 20 hy., center tapped, CH.;

One single-circuit jack and insulating bushing, J.;

One small 7 prong wafer socket;

One type 12A7 tube;

One binding post strip marked "Ant-Gnd.";

Aluminum for panels, 1/16-in. thick, wire, small hardware, line.

*Note:* These parts may be of different manufacture *but* must have the specified electrical characteristics.

## The "Four-in-Two" All-Wave All Electric 2-Tube Set

By J. T. Bernsley

**I**T WAS with the realization that short-wave set constructors preferred a set that is economical to build and operate, and employs a minimum of tubes with a maximum of efficiency, that this receiver was designed.

Before discussing the relative merits of the circuit, and the theory involved, it would undoubtedly be of greater interest to the constructor to learn, first, just what this set can do. Well, in the first place, it will operate a loudspeaker (magnetic, or permanent

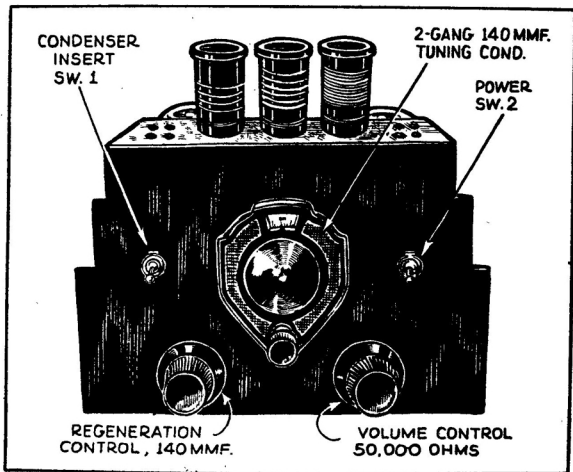
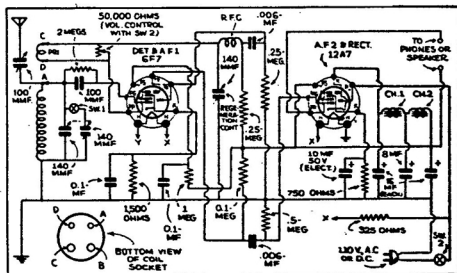

Fig. A.—Front View of Set. Note Novel Coil Rack

Fig. 1.—  
Circuit diagram  
of the  
"Four-In-Two."  
**CAUTION:**  
When using the  
external ground  
connection  
be sure to  
insert a  
.05 mf.  
condenser  
in series with  
the ground  
wire as a  
protective  
measure  
against possible  
"shorts"  
in the house  
line



magnet dynamic types) on most signals transmitted within a radius of 750 miles. On broadcast tests, conducted in a steel office building in New York City, stations 1,500 miles away were brought in with fair loudspeaker volume.

On short waves, police calls all over the country were more than comfortably heard on the loudspeaker.

Foreign broadcasts, on short waves, were received from numerous countries. At the time of these tests LSY in Argentina, South America, was heard with good loudspeaker volume. Also Caracas, Venezuela, with exceptionally good volume. DJC, in Berlin, Germany, was tuned in (on loudspeaker) consistently for several weeks. Amateur radiophone stations in abundance, to delight any ham or other interested listener, were received in the various bands assigned to amateur phone communication.

Using only two tubes, and of the

most unique types that have ever been produced, it is possible to obtain full four-tube results. The set is distinctly designed for electric operation, either 110 V. D.C., or A.C. (of any frequency), but only this combination of tubes, as will be explained later, will permit such operation—and the equivalent performance of four tubes. By using conventional plug-in coils, the complete short-wave range of from 15 to 200 meters is covered.

### Broadcast Reception, Too!

However, the necessity for ever-changing coils to cover various wavebands is reduced considerably by a special feature included within the tuning circuit. This consists of a tandem 140 mmf. two-condenser gang, one section of which is constantly in the tuning circuit—the other section inserted at will (in parallel, to increase the total effective-tuning capacity) from the front panel by means

of a toggle switch mounted as shown in Fig. A. Thus, not only does this feature facilitate a wider tuning frequency range, but should the constructor desire to use this set for regular broadcast reception (using a broadcast plug-in coil from which a few secondary turns are removed) he will find that the operation is much more highly efficient and satisfactory. This may be attributed, in engineering parlance, to an "improved L/C ratio".

### Circuit Design

Referring to Fig. 1 it will be noted that the two tubes employed are the "multi-purpose" types 6F7 and 12A7. The 6F7 tube really comprises two tubes in one glass envelope, a pentode and a triode. In this receiver the pentode section is employed as the regenerative detector, and the triode section as the first audio stage. Thus, two-tube efficiency is obtained from this single tube. The 12A7 also comprises two tubes in one glass envelope, but the type of operation and arrangement of the elements within the tube are entirely different. Here we find a power pentode (whose characteristics are identical with the 38 power tube) and a half-wave rectifier all in one unit. By utilizing the power pentode section of this tube as the final *power audio stage*, and the half-wave rectifier for rectifying the alternating current, when it is operated from A.C. (on D.C. the direct current continuously passes through the tube) we obtain two-tube efficiency from this single tube. The net total, as a result of this arrangement, is *full four-tube efficiency from two tubes*. No reflexing or other tricks, just

a straightforward regenerative detector followed by two stages of resistance-coupled audio amplification, the final stage being a power audio, and a rectifier or "B" supply—all from two tubes.

The heaters of these two tubes are wired in series, thus requiring a filament voltage of 18 V. and a current of 0.3 of an ampere (or 300 ma.). This is obtained from the power line by means of a series resistor (325 ohms), or a power cord in which this value of resistance is included. No power transformer, or any other transformer whatsoever, is employed. The 110 V. supply—A.C. or D.C.—is fed directly to the half-wave rectifier section of the 12A7 tube. The efficiency of this rectifier is such that the voltage drop through it may be considered as being almost negligible. Since resistance coupling is used in audio stages, no audio transformers are necessary.

Two low-resistance power chokes (only 100 ohms resistance, approx., each) are employed in the filter section. This design, coupled to the use of three electrolytic condensers, completes the filtering arrangements, as shown in Fig. 1, and has been found more than sufficient to remove any trace of ripple or hum.

Regeneration is obtained by inductive coupling of the "plate" winding to the secondary or "grid" winding. It is controlled, however, by a midget 140 mmf. variable condenser (mounted under the sub-base, as shown in Fig. A, which regulates the amount of R.F. energy existing in the plate circuit. Regeneration may also be controlled by the volume control which is shunted across the plate

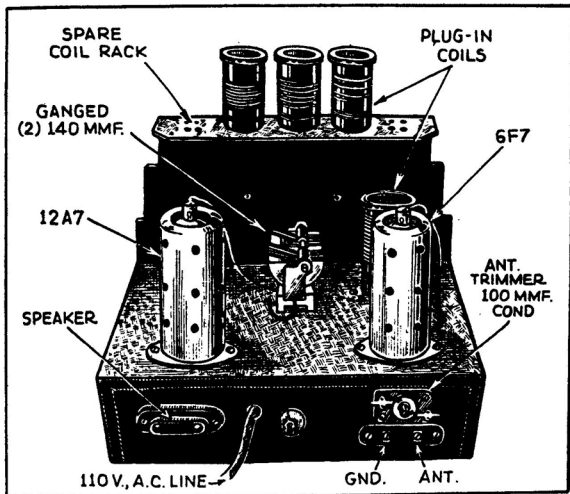

Fig. B.—Rear View Showing Layout of Main Parts

coil and thus serves as a controlled short-circuiting device to regulate volume or regeneration. For broadcast reception this control will be found considerably more effective for regeneration regulation. It is recommended that the single variable condenser be used on short-waves for this purpose, and left at maximum capacity for the broadcast band in

which case the volume control is used in its stead.

#### List of Parts

- One Hammarlund tandem, dual section, 140 mmf. (each) variable condenser gang;
- One complete set of plug-in coils (5, with broadcast coil, 4 only for complete short-wave coverage);



One single Hammarlund midget variable condenser, 140 mmf.;  
 Two General Transformer chokes 80 hy., 100 ohms each;  
 One Hammarlund R.F. choke, 85 mhy.;  
 Two Cornell-Dubilier electrolytic condensers, 16 mf., 200 V.;  
 One Cornell-Dubilier electrolytic condenser, 8 mf., 220 V.;  
 Two 7-prong wafer sockets (small) for 12A7 and 6F7 tubes;  
 One 4-prong wafer socket for plug-in coils;  
 One I.R.C. resistor, 1,500 ohms, 1 W.;  
 One I.R.C. resistor, .1-meg., 1 W.;  
 Two I.R.C. resistors, .25-meg., 1 W.;  
 One I.R.C. resistor, .5-meg., 1 W.;  
 One I.R.C. resistor, 750 ohms, 1 W.;  
 One I.R.C. resistor, 2 meg., 1 W.;  
 One I.R.C. resistor 0.1 meg., 1 W.;  
 One wire-wound resistor, 325 ohms, 40 W. size, or power cord with equivalent resistor built-in;  
 Two S.P.S.T. toggle switches;  
 One volume control, 50,000 ohms;  
 Two Cornell-Dubilier tubular condensers, .1-mf., 400 V.;

Two Cornell-Dubilier tubular condensers, .006 mf., 400 V.;  
 One Cornell-Dubilier mica condenser, .0001-mf.;  
 One Cornell-Dubilier electrolytic condenser, 10 mf., 50 V.;  
 One antenna trimmer condenser;  
 One drilled sub-base and panel unit (as shown in illustrations);  
 One type 12A7 tube;  
 One type 6F7 tube;  
 Miscellaneous supplies, such as wire, hardware, vernier dial, etc.

*Note:* These parts may be of a different manufacture *but* must have the same electrical specifications.

#### Conclusion

This receiver, if wired carefully and as per Fig. 1, should operate to the complete satisfaction of any constructor. The adjustment of the antenna trimmer condenser may be rather critical if an antenna system of relatively long dimensions is employed. For best results use a short overhead wire (about 35 ft.) placed as high as possible.

## Super-Regenerative Single-Tube Loudspeaker Set

By W. P. Chesney

**Y**EARS ago, when radio was being developed by the experimenter and the amateur, a one tube loudspeaker set was the ultimate goal of every constructor. Various types of circuit combinations and forms of receivers were tried and built, and in a good

many cases actual loudspeaker results with one tube were obtained. In favor of other fads or fancies, interest in developing maximum efficiency from a single tube waned. The constructor became caught in a maelstrom of other intriguing possibilities of radio which took his attention away

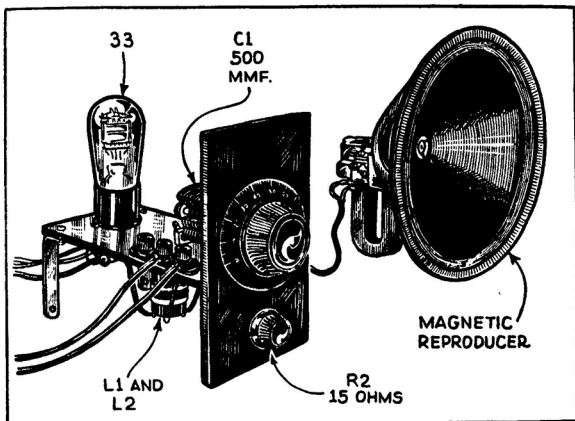

Fig. A.—Front View of Set. Note small size compared to speaker

from this most interesting and worthwhile work. But now, with interest being resumed in small receivers, as evidenced by the increasing popularity of the midget set, and since more highly developed tubes -- (from an angle of sensitivity and power output) are available, the experimenter is once more focusing his attention in this direction.

To the uninitiated, it is not desired to convey the impression that it is possible to construct a one tube set that will duplicate the efficiency of a five or six tube set. What is empha-

sized is that no machine or electrical device is anywhere near 100 per cent efficient. Particularly is this true in the case of a vacuum tube. And since there is room for improvement in this case, through careful study of the problems involved and careful construction of the receiver, it is more than possible to make one tube operate a loudspeaker (with fair sensitivity) to the satisfaction of the user.

Since only one tube is employed, its function is limited to that of detection, or rectification as some term it,



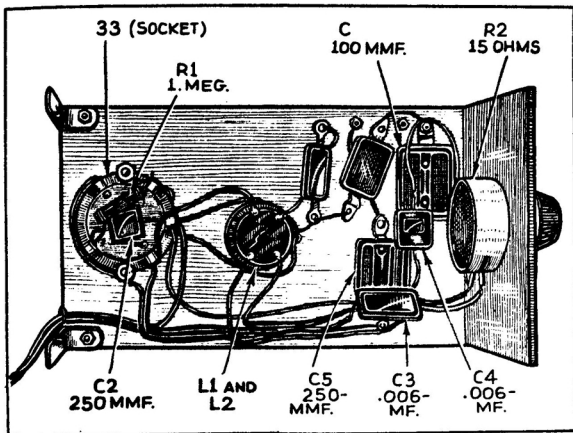

Fig. B.—Underside View Showing Placement of Parts

sults may be obtained from 90 V.

With the exception of the coil, which has two windings, all other material can readily be obtained. The coil must be especially made by the constructor, and is wound on a 1 in. diameter form, about 3 ins. long. The secondary, L1, consists of 110 turns of No. 32 enamel covered wire. The primary L2, or plate coil winding consists of 45 turns of No. 36 D.S.C. wire wound below the grounded end of the secondary. The suggested layout and construction are shown in Figs. A and B.

#### Adjustment and Tuning

If the set seems to be insensitive then the trouble is possibly due to the connections to the coil winding L2 being reversed. This winding must be in proper phase relationship to L1 or else regeneration will not take place. Fixed condensers, C3, C4, and C5, must be exactly as specified and mica-dielectric type is recommended to reduce the losses and inconsistencies that occur in the paper type. It is through these condensers that the superregenerative action is obtained. A 100 mmf. fixed condenser

may be connected across the output terminals, but will not be necessary in all cases. Its inclusion will be necessary if a persistent whistle takes place—but in some cases will also help to actually increase the volume. R2 controls the volume and stability of the receiver, by regulating the filament temperature of the tube. Stations are obtained by simply tuning the variable condenser, C1.

To obtain good loudspeaker volume, a high impedance magnetic type loudspeaker is recommended. It should preferably be of a "close" gap construction, which feature makes the unit highly sensitive, though it might tend to chatter a little on extreme volume.

Too large an antenna for this receiver should not be used. It may dampen the sensitivity of the set instead of increasing its efficiency. An approximate

### Most Popular All-Wave Receivers

total length of 75 feet will be found to be ideal.

In Fig. 1 are given optional coil winding data.

A ground is not always necessary; it should be tried, though. Connect it to the end of L1 opposite the antenna connection (or, the junction of L1, C1, C3 and C5).

#### List of Parts

- One 500 mmf. variable condenser C1;
- One mica fixed condenser, 250 mmf., C2;
- Two mica fixed condensers, .006-mf., C3, C4;
- One fixed condenser, 250 mmf., C5;
- One resistor, 1 meg., R1;
- One 15 ohm rheostat, R2;
- Miscellaneous parts, such as 5-prong socket, hardware, chassis base, binding posts, 33 tube, and magnetic type loudspeaker.

## Portable 2-Tube Battery Loudspeaker Receiver

**W**HILE formerly several tubes requiring heavy batteries of large capacity were employed in portables to obtain loudspeaker volume, now the pentode with its loudspeaker output can be used alone with a minimum of battery space and weight.

Fig. B.—Right, showing the complete portable set

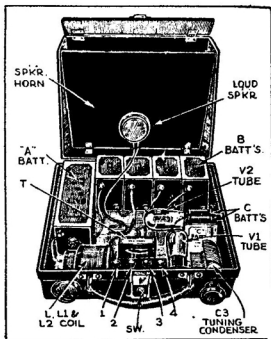

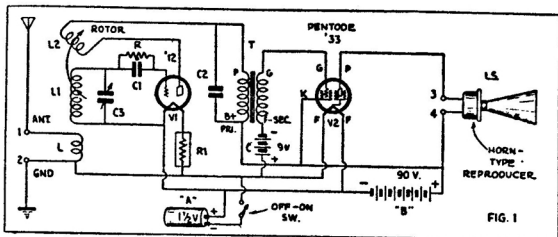

Fig. 1.—Schematic Diagram of the Battery Portable Receiver

In the set illustrated, *only two tubes are employed*; a type WX-12 ("general purpose") and a type '33 audio pentode. The reason for this particular combination will be pointed out later. The carrying case is that belonging to a small portable typewriter; but any suitable box may be employed, or one can be made especially for the purpose. The folding loudspeaker is built into the cover. One dry cell supplies the filament voltage; while four of the smallest sized 22½-volt "B" batteries provide the plate potential.

The circuit is a simple regenerative one, employing one of the small three-circuit tuners so popular a few years ago. While the tone quality is not comparable with that of the modern receiver, with dynamic reproducer and power amplifier, it is equal to that obtained from a small portable phonograph; and on locals, and for distances up to a thousand miles, the volume is loud enough for filling a large room.

The WX-12 tube was selected, not only because it is a good detector, but also because its required filament potential (1.1 volts, requiring only one "A" cell) fits in with the design of the set.

Fig. 1 shows the final schematic circuit. The three-circuit tuner (comprising the primary, secondary and tickler coils L, L1, L2, respectively has the secondary L1 tuned by the .00035-mf. midjet variable condenser C3; this covers the broadcast band. The grid condenser C1 has a capacity of .00025-mf. and is shunted by the grid leak R of 2 megohms. R1 is a fixed filament resistor of 1.5 ohms. An Amperite or filament rheostat may be used, or a fixed resistor may be used, or a fixed resistor with an adjustable contact.

The bypass condenser C2, which shunts the audio transformer T, has a capacity of .0005-mf. The "A", "B" and "C" voltages are indicated on the sketch. The loudspeaker unit L.S. is of the horn type and should have

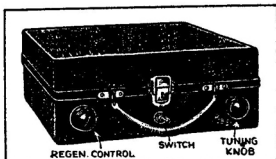

Fig. A.—Closed View of Portable

a low impedance, in the order of 7500 ohms; although any good horn unit may be used.

The illustrations Figs. A and B and Fig. 2, show the general layout. The parts are mounted directly on the case; with the tickler and tuning condenser knobs, and the filament switch, on the handle side, or top (when closed, as shown). The batteries and dry cell are securely fastened to the bottom of the case by means of a thin strip of brass bent around them and secured at each end to the case with small wood screws. The four binding posts, for aerial, ground, and loudspeaker, are mounted on a bakelite strip  $3/16$  by  $5/8$  by  $1/4$  in. which is attached to the case with two angle brackets. The tube sockets are mounted on the sides of the case as shown.

#### Novel Loud Speaker

The loudspeaker used in this set is somewhat novel. While not of the best design from an acoustical standpoint, it works very well and occupies little space. The horn structure is shown in Fig. 3. A piece of  $1/4$ -inch plywood, which will fit snugly within the cover, is hinged to it as shown. Near the hinged side is bored a hole to receive the

throat of the horn-type unit L.S. When in use, the hinged portion swings out to the position shown, forming one side of the horn. When not in use, the unit is removed and placed in a metal clamp at the bottom of the case; the hinged portion is pushed in and the cover closed, as shown in Fig. A; making a compact outfit about  $4\frac{1}{2}$  in. by 10 in. by 12 in. overall and weighing less than 12 pounds!

For the ground connection, it is necessary to provide a wire lead which, by means of a spring clip on the free end, may be attached to any large metal object or net-work, such as grounded pipes or a metallic framework.

To tune in, turn the tickler knob so that the circuit oscillates, (manifested by a rushing "noise") and then turn the tuning dial until a heterodyne squeal of the station is heard. Then slowly turn the tickler back changing the tuning slightly (if necessary) with the other hand, until the station is clear.

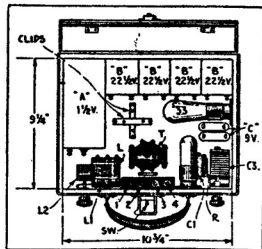

Fig. 2.—Layout of All Parts

## List of Parts

- One "Corona" typewriter carrying case, 10 $\frac{3}{4}$  x 9 $\frac{1}{4}$  x 4 inches deep (inside dimensions);  
 One Gen-Win 3-circuit tuner (L, L1, L2);  
 One Hammerlund .00035-mf. midget variable condenser (C3);  
 One Polymet .00025-mf. grid condenser (C1);  
 One Polymet .0005-mf. bypass condenser (C2);  
 One 2-meg. grid leak (R);  
 One Carter 1.5-ohm resistor (R1);  
 One "replacement"-type A.F. transformer (T);  
 Two Burgess 3-cell flashlight batteries ("C");  
 One Burgess 1.5-volt dry cell ("A");  
 Four Burgess 22 $\frac{1}{2}$ -volt batteries ("B");  
 One 4-prong socket (for V1);  
 One 5-prong socket (for V2);

- Four binding posts, with bakelite strip and brackets (1, 2, 3, 4);  
 One filament switch (Sw);  
 Miscellaneous screws, wire, soldering lugs, etc.  
 One type WX-12 tube, 1.11-volt filament (V1);  
 One type '33 pentode tube (V2);

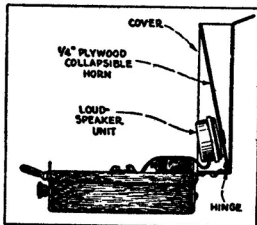

Fig. 8.—Speaker Details

## Beginners' One-Tube All-Wave Battery Set

By F. R. Harris

**B**ROADCAST wavelengths and the programs they carry are very interesting, but the *real thrill of radio lies in short wavelengths* — the higher frequencies —

on which it is possible to pick up programs of all kinds from the very ends of the earth! This receiver is designed to receive both!

Don't get the idea, though, that this means complication and difficulty.

The set we are building is the simplest and one of the best breadboard styles. It is designed for the absolute

beginner who is neither radio man nor mechanic, and yet it will equal or better the performance of many



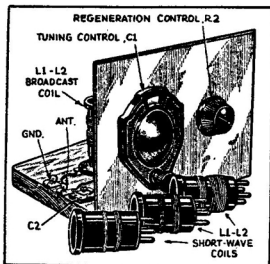

Fig. 4.—Front View of Set

more elaborate layouts. Under actual tests it received (with the broadcast coil) all local stations with comfortable room volume on the loudspeaker.

While we are on the subject of wave bands it might be well to give a list of the principal divisions and their allotted uses; the tabulation gives the frequency in kilocycles (kc.) and the equivalent approximate wavelength in meters.

Usage	Kc.	Meters
Regular Broadcast	550 to 1,500	545 to 200
Short-Wave Broadcast	6,000 to 6,150	50 to 48.7
	9,500 to 9,600	31.5 to 31.2
	11,700 to 11,900	25.6 to 25.2
	15,100 to 15,350	19.8 to 19.6
	17,750 to 17,800	16.9 to 16.8
	21,450 to 21,550	14.0 to 13.9
	25,600 to 26,600	11.7 to 11.2
Police	1,555 to 1,712	193 to 175
	2,412 to 2,508	124 to 119

### Most Popular All-Wave Receivers

Aircraft	2,300 to 3,500	130 to 85.6
Amateur	1,800 to 2,000	166 to 150
Phone	3,900 to 4,000	76.8 to 74.9
	14,150 to 14,250	21.2 to 21.1
	28,000 to 28,500	10.7 to 10.5
	56,000 to 60,008	5.3 to 4.9

The set we are building is designed to cover all of these bands from 550 to 18,000 kc. (545 to 16 meters), which should be ample to give a real introduction to the world of short waves; after which—unless we miss our guess—you will be, "rarin to go", to build a more elaborate layout with greater range.

### Construction

The first step in construction is to get together *all* the material *specified* in the List of Parts; the necessary tools; and a fairly large, firm table upon which to work. Tool requirements are simple: a medium and a small-size screw-driver; a pair of diagonal cutters; a pair of thin, long-nose pliers and a second pair of sturdier construction, wood saw; a plane; a flat file and a rat-tail file; a hand-drill and a few drills (one No. 18 and one  $\frac{1}{4}$ -in. will be enough to start); a soldering iron (preferably electric) and some resin core solder. Of course, you can use many more tools, if you have them, but those mentioned above will be enough to do the job.

Cut the baseboard to size (its dimensions accommodate all the batteries), clean it up with the plane and sandpaper, and give it a coat of shellac—always put a "Sunday dress" on your work; you've no idea how it adds to your reputation as a radio man among those to whom the technical details are just so many long words!





The other point within our control, that of tuning, is primarily a question of patience. The most sensitive point for any regenerative receiver is just at the point of circuit oscillation. Turning the tuning dial and oscillation control together, meanwhile checking for the presence of oscillation by the method explained below will give you an approximate idea of just how the two line-up on any given coil. The procedure is to keep the set adjusted just inside the oscillation point and to run the tuning dial *very slowly* until you hear a whistle; then, tune for the silent point between two whistles and "juggle" the oscillation control until you bring in the station. For broadcast and phone stations, this will be just outside the oscillation point; and for code stations, just inside. The main points to remember are: *slow tuning*; and, *careful adjustment of the oscillation control*.

### Trouble Shooting

The set is so simple in design that trouble is not likely to occur; the foremost possibility, however, is lack of circuit oscillation. If the circuit will not oscillate, the first thing to do is to reverse the connections to P and F1 on the coil socket. The grid leak, R1, is also a factor in producing oscillation. Values from 1 to 10 megs. may be tried in this position. It may be necessary, particularly in the smallest coil, to add a turn or two to the tickler (the coil between the P and F1 socket terminals). Since the tube *must* be a good one—a poor tube will not oscillate—before going into the business of adding turns it might be well to try another tube.

And while on the subject of tubes, heed the warning that the 2 V, series of tubes are very delicate and must be handled with extreme care. They will not stand an overload on the filaments—if this occurs, either from too much plate current or too much filament voltage—the emission from the filament is destroyed and the tube is rendered useless. In this particular circuit do not put more than  $6\frac{1}{2}$  V. of "B" battery in use (less, if possible).

### Coil Data

It is advised that the beginner purchase a set of coils already wound, but if desired he may wind coils to the data given in Fig. 3. The coils are all wound on standard short-wave plug-in forms  $1\frac{1}{4}$  ins. diameter x  $2\frac{1}{8}$  ins. long, four prong. The tuned winding is connected between the grid prong and one filament prong and the tickler between the plate and the other filament.

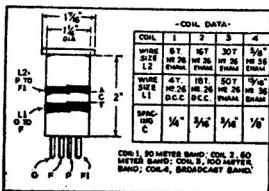

Fig. 3.—The Broadcast Coil is wound with no space between the turns and hence the turns are measured rather than counted

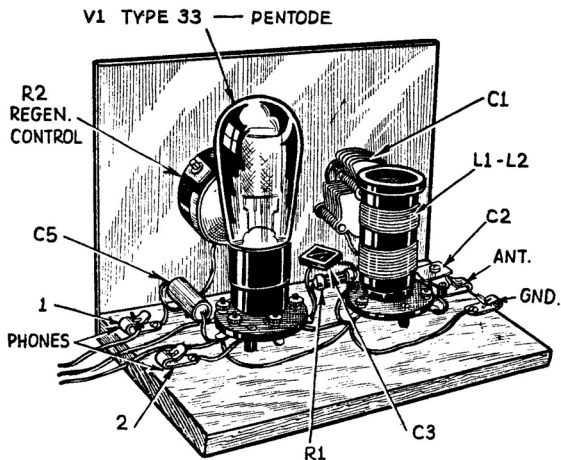

Fig. 5.—Rear View of All-Wave One-Tube Receiver

**List of Parts**

One tuning condenser, 140 mmf., C1;  
 One 5 to 70 mmf. antenna compensating condenser, C2;  
 One 350 mmf. mica grid condenser, C3;  
 One .002-mf. mica condenser, C4;  
 One .1-mf. non-inductive paper condenser, 200 V., C5;  
 One 2 meg. grid leak, R1;  
 One 50,000 ohm wire-wound potentiometer, R2;  
 One 4-prong socket for coils L1-L2;

One 5-prong spring mounted socket for the tube;  
 Four spring binding posts;  
 One wood baseboard,  $8\frac{1}{4} \times 9 \times \frac{5}{8}$ -in.;  
 One aluminum panel,  $8\frac{1}{4} \times 6 \times \frac{1}{16}$  in.;  
 One type 33 tube, V1;  
 One pair of sensitive headphones;  
 One roll of push-back hook-up wire  
 Three  $22\frac{1}{2}$  V. small "B" batteries;  
 One 2 V. storage cell;  
 Small screws;  
 Four Fahnestock clips;  
 One vernier dial.

Here Are the Ten Titles of the Famous  
**GERNSBACK'S EDUCATIONAL LIBRARY:**



No. 1  
 How To Make  
 Four Doerle  
 Short Wave Sets



No. 2  
 How To Make The  
 Most Popular All-Wave  
 1- and 2-Tube Receivers



No. 3  
 Alternating  
 Current  
 for Beginners



No. 4  
 All  
 About  
 Aerials

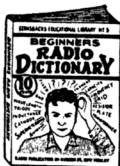

No. 5  
 Beginners'  
 Radio  
 Dictionary



No. 6  
 How To Have  
 Fun With  
 Radio



No. 7  
 How To Read  
 Radio  
 Diagrams



No. 8  
 Radio  
 For  
 Beginners

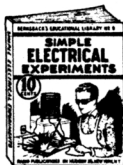

No. 9  
 Simple Electrical  
 Experiments

**10¢**

**BOOKS ARE ALL UNIFORM**  
 Every book in the GERNSBACK'S  
 EDUCATIONAL LIBRARY has  
 32 pages—with illustrations vary-  
 ing from 30 to 66 in number. Each  
 title volume contains over 15,000  
 words. **POSITIVELY THE**  
**GREATEST 10c VOLUME IN**  
**RADIO BOOKS EVER OFFERED**  
**TO THE PUBLIC.**



No. 10  
 Television

Order books by number — remit by check, money order, cash  
 or unused U. S. Postage Stamps. Books are mailed **POSTPAID.**

**RADIO PUBLICATIONS, 25 WEST B'WAY, NEW YORK 7, N. Y.**