



DLP TV

Chassis : L70A(N)_Aquamarine
Model : HL61A750A1FXZA
HL67A750A1FXZA

SERVICE Manual

DLP TV



HL61A750A1F
HL67A750A1F

CONTENTS

1. Precaution
2. Product Specification
3. Disassembly & Reassembly
4. Troubleshooting
5. Exploded View & Part List
6. Wiring Diagram
7. Schematic Diagram

Table of Contents

1. Precaution

1-1 Safety Precautions	1-1
1-2 Servicing Precautions.....	1-3
1-3 Static Electricity Precautions	1-4
1-4 Installation Precautions	1-5

2. Product Specification

2-1 Product Specification.....	2-1
2-2 Specifications Analysis	2-3
2-3 Accessories	2-4

3. Disassembly & Reassembly

3-1 Overall Disassembly & Reassembly.....	3-1
---	-----

4. Troubleshooting

4-1 Troubleshooting.....	4-1
4-2 Adjustment.....	4-6
4-3 Upgrade.....	4-30

5. Exploded View & Part List

5-1 HL61A750A1FXZA Exploded View.....	5-1
5-2 HL67A750A1FXZA Exploded View.....	5-3
5-3 HL61A750A1FXZA Service Item	5-5
5-4 HL67A750A1FXZA Service Item	5-6

6. Wiring Diagram

6-1 Overall Wiring.....	6-1
-------------------------	-----

7. Schematic Diagram

7-1 Circuit Description	7-1
7-2 K880 Engine.....	7-2
7-3 Schematic Diagram	7-3

1. Precaution

To avoid possible damage, electric shocks or exposure to radiation, follow the instructions below with regard to safety, installation, service and ESD.

1-1 Safety Precautions

1. Make sure all protective devices are properly installed including non-metallic handles and compartment covers when installing or re-installing the chassis or chassis assemblies.
2. Make sure that no gaps exist between the cabinets for children to insert their fingers in. To prevent children from being electrocuted

Errors may occur when the resistance is below $1.0M\Omega$ or over $5.2M\Omega$. In these cases, make sure that the device is repaired before sending it back to the customer.

3. Check for Electricity Leakage (Fig. 1-1)

Warning: Do not use an insulated transformer for checking the leakage. Use only those current leakage testers or mirroring systems that comply with ANSIC 101.1 and the Underwriter Laboratory's specifications (UL1410, 59.7).

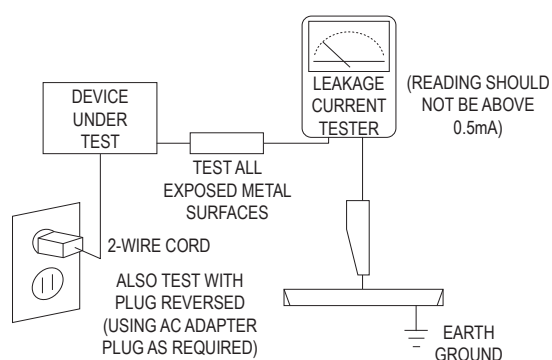

Fig. 1-1 AC Leakage Test

4. A high voltage is maintained within the specified limits using safety parts, calibration and tolerances. When voltage exceeds the specified limits, check each special part.
5. Warning for Engineering Changes:
Never make any changes or additions to the circuit design or the internal part for this product.

Ex: Do not add any audio or video accessory connectors. This might cause physical damage. Furthermore, any changes or additions to the original design/engineering will invalidate the warranty.

6. Warning - Hot Chassis:
Some TV chassis are directly connected to one end of the AC power cord for electrical reasons. Without insulated transformers, the product can only be repaired safely when the chassis is connected to the earthed end of the AC power source.

To make sure the AC power cord is properly connected, follow the instructions below. Use the voltmeter to measure the voltage between the chassis and the earthed ground. If the measurement is over 1.0V, unplug the AC power cord and change the polarity before re-inserting it. Measure the voltage between the chassis and the ground again.

7. Some TV chassis are shipped with an additional secondary grounding system. The secondary system is adjacent to the AC power line. These two grounding systems are separated in the circuit using an unbreakable/unchangeable insulation material.
8. When any parts, materials or wirings appear overheated or damaged, replace them with new regular ones immediately. When any damage or overheating is detected, correct this immediately and make a regular check of possible errors.
9. Check for the original shape of the lead, especially that of the antenna wiring, any sharp edges, the AC power and the high voltage power. Carefully check if the wiring is too tight, incorrectly placed or loose. Never change the space between the part and the printed circuit board. Check the AC power cord for possible damages. Keep the part or the lead away from any heat-emitting materials.

Precaution

10. Safety Indication:

Some electrical circuits or device related materials require special attention to their safety features, which cannot be viewed by the naked eye. If an original part is replaced with another irregular one, the safety or protective features will be lost even if the new one has a higher voltage or more watts.

Critical safety parts should be bracketed with (\triangle , \triangle). Use only regular parts for replacements (in particular, flame resistance and dielectric strength specifications). Irregular parts or materials may cause electric shock or fire.

11. Pay additional attention to the current leakage as the voltage between the power board and the ballast is 220 to 440V, i.e. very high. And also beware of possible electric shock from the primary power source.

1-2 Servicing Precautions

Warning 1: First carefully read the "Safety Instruction" in this service manual.

When there is a conflict between the service and the safety instructions, follow the safety instruction at all times.

Warning 2: Any electrolytic capacitor with the wrong polarity will explode.

1. The service instructions are printed on the cabinet, and should be followed by any service personnel.
2. Make sure to unplug the AC power cord from the power source before starting any repairs.
 - (a) Remove or re-install parts or assemblies.
 - (b) Disconnect the electric plug or connector, if any.
 - (c) Connect the test part in parallel with the electrolytic capacitor.
3. Some parts are placed at a higher position than the printed board. Insulated tubes or tapes are used for this purpose. The internal wiring is clamped using buckles to avoid contact with heat emitting parts. These parts are installed back to their original position.
4. After the repair, make sure to check if the screws, parts or cables are properly installed. Make sure no damage is caused to the repaired part and its surroundings.
5. Check for insulation between the blade of the AC plug and that of any conductive materials (i.e. the metal panel, input terminal, earphone jack, etc).
6. Insulation Check Process: Unplug the power cord from the AC source and turn the switch on. Connect the insulating resistance meter (500V) to the AC plug blade.
7. Any B+ interlock should not be damaged. If the metal heat sink is not properly installed, no connection to the AC power should be made.
8. Make sure the grounding lead of the tester is connected to the chassis ground before connecting to the positive lead. The ground lead of the tester should be removed last.
9. Beware of risks of any current leakage coming into contact with the high-capacity capacitor.
10. The sharp edges of the metal material may cause physical damage, so protect yourself by wearing gloves during the repair.

The insulating resistance between the blade of the AC plug and that of the conductive material should be more than 1 M Ω .

1-3 Static Electricity Precautions

1. Some semi-conductive ("solid state") devices are vulnerable to static electricity. These devices are known as ESD. ESD includes the integrated circuit and the field effect transistor. To avoid any materials damage from electrostatic shock, follow the instructions described below.
2. Remove any static electricity from your body by connecting the earth ground before handling any semi-conductive parts or assemblies. Alternatively, wear a dischargeable wrist-belt.
(Make sure to remove any static electricity before connecting the power source - this is a safety instruction for avoiding electric shock)
3. Remove the ESD assembly and place it on a conductive surface such as aluminum foil to prevent accumulating static electricity.
4. Do not use any Freon-based chemicals. Such chemicals will generate static electricity that causes damage to the ESD.
5. Use only grounded-tip irons for soldering purposes.
6. Use only anti-static solder removal devices.
Most solder removal devices do not support an anti-static feature. A solder removal device without an anti-static feature can store enough static electricity to cause damage to the ESD.
7. Do not remove the ESD from the protective box until the replacement is ready. Most ESD replacements are covered with lead, which will cause a short to the entire unit due to the conductive foam, aluminum foil or other conductive materials.
8. Remove the protective material from the ESD replacement lead immediately after connecting it to the chassis or circuit assembly.
9. Take extreme caution in handling any uncovered ESD replacements. Actions such as brushing clothes or lifting your leg from the carpet floor can generate enough static electricity to damage the ESD.

CAUTION

These servicing instructions are for use by qualified service personnel only.

To reduce the risk of electric shock do not perform any servicing other than that contained in the operating instructions unless you are qualified to do so.

1-4 Installation Precautions

1. For safety reasons, more than two people are required for carrying the product.

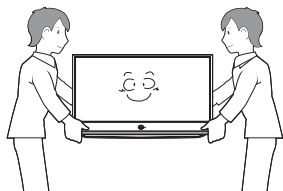

2. Keep the power cord away from any heat emitting devices, as a melted covering may cause fire or electric shock.
3. When installing the product, make sure to keep it away from the wall (more than 10cm/4 inches spacing should be around the Top, Back, and both sides of the unit) for ventilation purposes. Poor ventilation may cause an increase in the internal temperature of the product, resulting in a shortened component life and degraded performance.
4. Bend the external antenna cable when connecting it to the product. This is a measure to protect it from being exposed to moisture. Otherwise, it may cause a fire or electric shock.
5. Make sure to turn the power off and unplug the power cord from the outlet before repositioning the product. Also check the antenna cable or the external connectors if they are fully unplugged. Damage to the cord may cause fire or electric shock.
6. Keep the antenna far away from any high-voltage cables and install it firmly. Contact with the high-voltage cable or the antenna falling over may cause fire or electric shock.
7. When connecting the RF antenna, check for a DTV receiving system and install a separate DTV reception antenna for areas with no DTV signal.
8. Check the basics of the screen test.
 - Image position/size, Tilt adjustment, Actuator activation

justmanuals.com

MEMO

2. Product Specification

2-1 Product Specification

Features			
Block	Specification	Major IC	Remark
RF	Integrated HDTV Tuner (QAM NIM TUNER Embedded)	QamLink	
DMD	Panel Resolution : 1920 x 1080	xHD5 DMD Panel	
Power	Input Voltage : AC110V~120V Stand-By : under 1W	Stand-by (VIPER12A)	
Video	Component Interface : 480i/480p/720p/1080i/1080p Digital Interface : 3 HDMI In (HDMI1.3) (DVI Comfortable with adaptive jack only) DNle	BAYHILL+, MST3360CCLK	
Sound	SRS TruSurround XT, Dolby Digital	BAYHILL+ STA335BW SGTV5910	
Cabinet	K8 Design		
Specification			
Model	HL61A750A1F	HL67A750A1F	
Screen Size	61 inches (1372 x 782mm)	67 inches (1524 x 875mm)	
Dimensions (WxHxD)	54.8 x 37.7 x 15.4 inches (1391 x 957 x 392 mm)	60.7 x 41.5 x 16.5 inches (1544 x 1054 x 420.5 mm)	
Weight	74.7 lbs (33.9 Kg)	86.6 lbs (39.3 Kg)	
Voltage	AC 110 - 120V, 60Hz		
PC Resolution	Analog : 640x350, 720x400, 640x480, 800x600, 1024x768, 1152x864, 1280x960, 1280x1024, 1920x1080 HDMI3/DVI : 640x350, 720x400, 640x480, 800x600, 1024x768, 1280x1024, 1920x1080		
ANTENNA input	Antenna Input 1: Air, Cable		
VIDEO input	Composite Video Input1/2, S-Video1 Component1: 480i/480p/720p/1080i/1080p Component2: 480i/480p/720p/1080i/1080p HDMI1 : 480p/720p/1080i//1080p HDMI2 : 480p/720p/1080i//1080p HDMI3/DVI : 480p/720p/1080i//1080p * HDMI3 support DVI signal for PC input		
Video Output	No Video Output		
AUDIO input	Composite L/R Input 1/2, S-Video L/R Input 1 Component1 Input L/R, Component2 Input L/R DVI Audio L/R PC Audio Input		
Audio Output	Optical (SPDIF), Audio L/R Output		
Speaker Output	10W + 10W		
New Features	Wiselink (USB2.0), 3D Ready, Anynet+		

■ **New Features explanation**

- The Entertainment mode enables you to select the optimal display and sound for sports, cinema and games.
 - Off: Switches the Entertainment function off.
 - Sports: Provides the optimal picture and sound quality for sports.
 - Cinema: Provides the optimal picture and sound quality for movie watching.
You can experience a richer picture and enhanced sound.
 - Game: Provides the optimal picture and sound quality for games.
This mode accelerates the playing speed when using an external game console connected to the TV.
- WISELINK (USB2.0) : This function enables you to view and play photo (JPEG) and audio files (MP3) through the TV's WISELINK jack.
- 3D/Dual-View : The HLT generation of Samsung DLP HDTVs are capable of displaying future 3D games, movies and other programming vis 3D compatible glasses and hardware.
- ANYNET+ (HDMI CEC) : AV network system that enables you to control all connected Samsung AV devices with your Samsung TV's remote. The Anynet+ system can be used only with Samsung AV devices that have the Anynet+ feature. To be sure your Samsung AV device has this feature, check if there is an Anynet+ mark on it.



■ **PIP Table (1 tuner = Analog/Digital, O: PIP, X : PIP doesn't operate)**

Main \ Sub	TV digital	TV analog	Video1,2	S-Video1	COMP1,2	HDMI1,2,3	PC
TV digital	X	X	X	X	X	X	X
TV analog	X	X	X	X	X	X	X
Video1,2	X	X	X	X	X	X	X
S-Video1	X	X	X	X	X	X	X
COMP1,2	X	O	X	X	X	X	X
HDMI1,2,3	X	O	X	X	X	X	X
PC	X	O	X	X	X	X	X











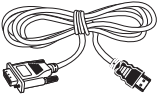

- PIP is only available in RF (TV) mode.

2-2 Specifications Analysis

※ ○ : application, × : non-application

Model		HL61A750	HL67A750	HL-T6189S
Design				
Picture	Display Device	DLP	DLP	DLP
	Built-in Tuner	Clear QAM	Clear QAM	Clear QAM
	Display Format	1080p, 1080i, 720p, 480p, 480i	1080p, 1080i, 720p, 480p, 480i	1080p, 1080i, 720p, 480p, 480i
	Screen Size	61 inch	67 inch	61 inch
	Aspect ratio	16:9	16:9	16:9
	Progressive scan	Yes	Yes	Yes
	Digital Comb Filter	3D Comb	3D Comb	3D Comb
	First Surface Mirror	Yes	Yes	Yes
	Brightness	600cd/m ²	600cd/m ²	600cd/m ²
	Contrast	10000:1	10000:1	10000:1
	Color Wheel Size/Bearing	No Color Wheel	No Color Wheel	No Color Wheel
	Anti-glare Sun Screen	No	No	No
	Screen Pitch	0.098mm	0.098mm	0.098mm
	Image enhancer	BAYHILL+	BAYHILL+	FBEx
Audio	DMD	xHD5	xHD5	xHD5
	Base/Tremble/Balance	No	No	No
	Equalizer	7 Band	7 Band	7 Band
	Auto Volume Leveler	Yes	Yes	Yes
	Surround Sound	TruSurround XT Dolby Digital	TruSurround XT Dolby Digital	TruSurround XT Dolby Digital
	Speaker system	Hidden	Hidden	Hidden
Features	Output Power	10Wx2	10Wx2	10Wx2
	Tuner	1 Input 1Tuner	1 Input 1Tuner	2 Input 1Tuner
	Split-screen Side-by-Side	Yes	Yes	Yes
	MTS with dbx Noise Reduction/SAP	Yes	Yes	Yes
	Still Picture	Yes	Yes	Yes
Connections	Wise Link	Yes	Yes	Yes
	Plug & Play	Yes	Yes	Yes
	S-Video In	Rear 1	Rear 1	Rear 2
	HDTV Component Video Input (Y, Pb, Pr) 1080p/1080i/480P /480i/720P	Rear 2	Rear 2	Rear 2
	PC	Yes	Yes	Yes
	HDMI	3	3	3
	Digital Sound	Optical 1	Optical 1	Optical 1
	LED	LED	LED	LED
BLUETOOTH	No	No	Yes	

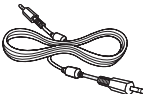

2-3 Accessories

Accessories	Item	Item code	Remark	
Supplied Accessories		Remote Control Batteries	BN59-00673A 4301-000103	Samsung Service center
		Power Cord	3903-000144	
		Owner's Instructions	BP68-00658A	
		Warranty Card Registration Card Safety Guide Manual	BN68-00872B - AA68-03242L	
		Cloth-Clean	BN63-01798A	
Accessories that can be purchased additionally		HDMI/DVI cable	-	Electronics Store/ Internal shopping mall
		HDMI Cable	-	
		S-VIDEO Cable	-	
		Antenna Cable	-	
		Component Cables (RCA)	-	
		1Stereo/2RCA Cable	-	
		PC Audio Cable	-	
		Audio/Video Cables	-	

3. Disassembly & Reassembly

3-1 Overall Disassembly & Reassembly

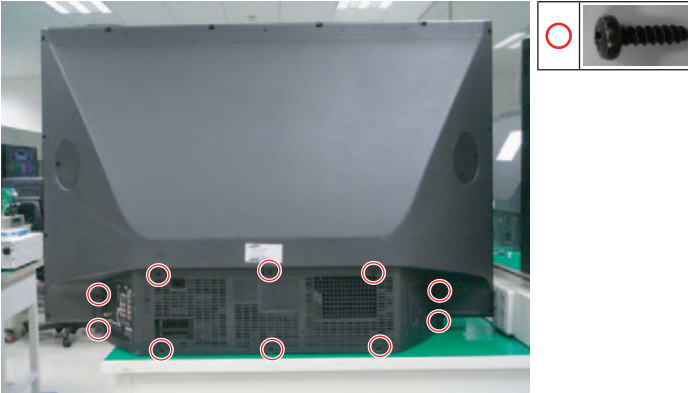
3-1-1 Separation of the back cover and the chassis (Disassembly is in reverse order of the assembly)

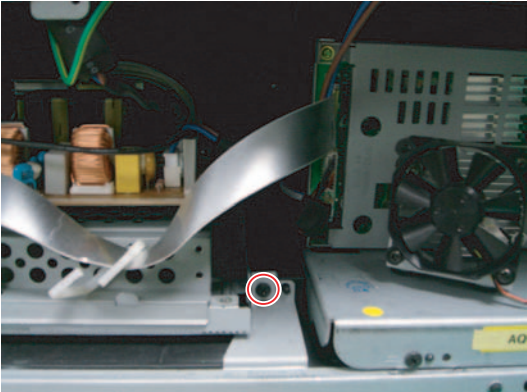
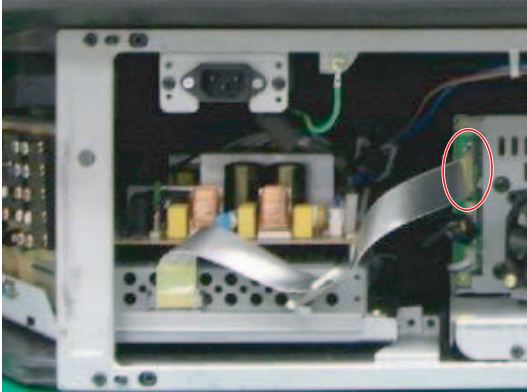
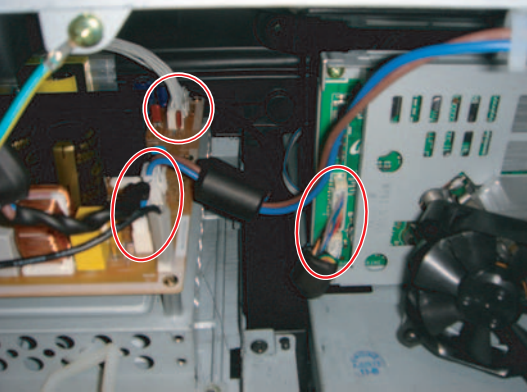
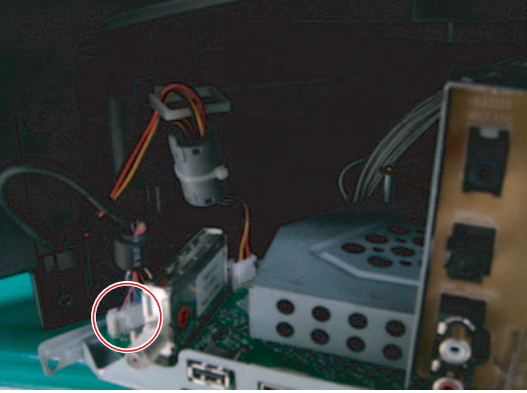

Part Name	Description	Description Photo
Back Cover	① Remove 10 screws to remove the back bottom cover. :BH,+,B,M4,L12,ZPC(BLK),SWRCH18	
Terminal Board	① Remove the Terminal Board by hands	
Holder Chassis	① Remove 1 screw at the left side of Main Assy. :BH,+,B,M4,L12,ZPC(BLK),SWRCH18	

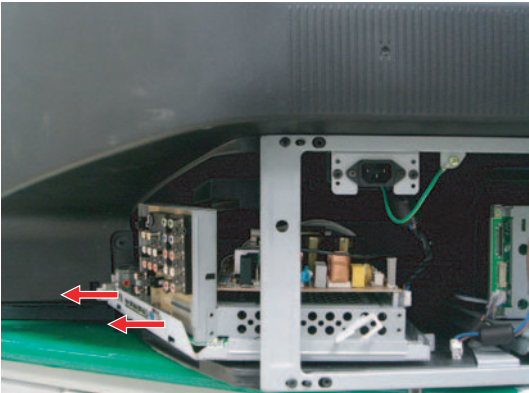
Part Name	Description	Description Photo
Holder Chassis	① Remove 1 screw at the right side of Main Assy. :BH,+,B,M4,L12,ZPC(BLK),SWRCH18	
	① Separate the LVDS Cable.	
	① Separate 10PIN DMD power cable, 2PIN Sub SMPS Wire and, 2 pin Inlet cable at the right side of Main Assy.	
	① Separate 12 pin Wire, and the Speaker wire at the left side of Main Assy.	

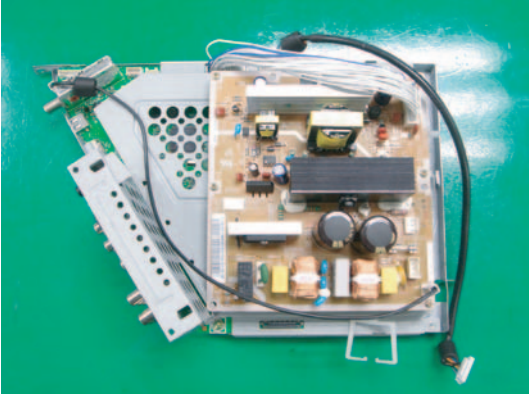
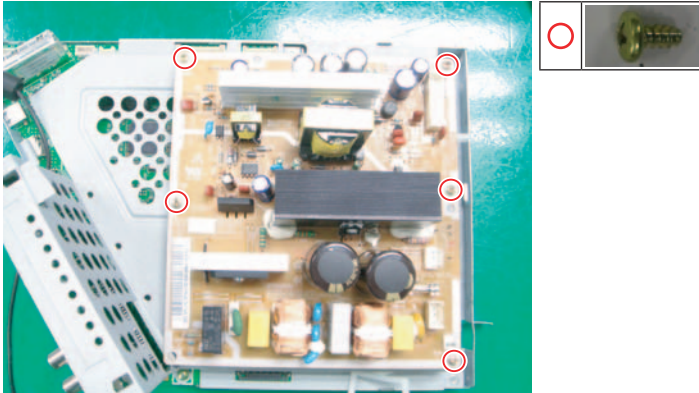

Part Name	Description	Description Photo
Holder Chassis	① Pull out the holder Chassis. Side direction.	

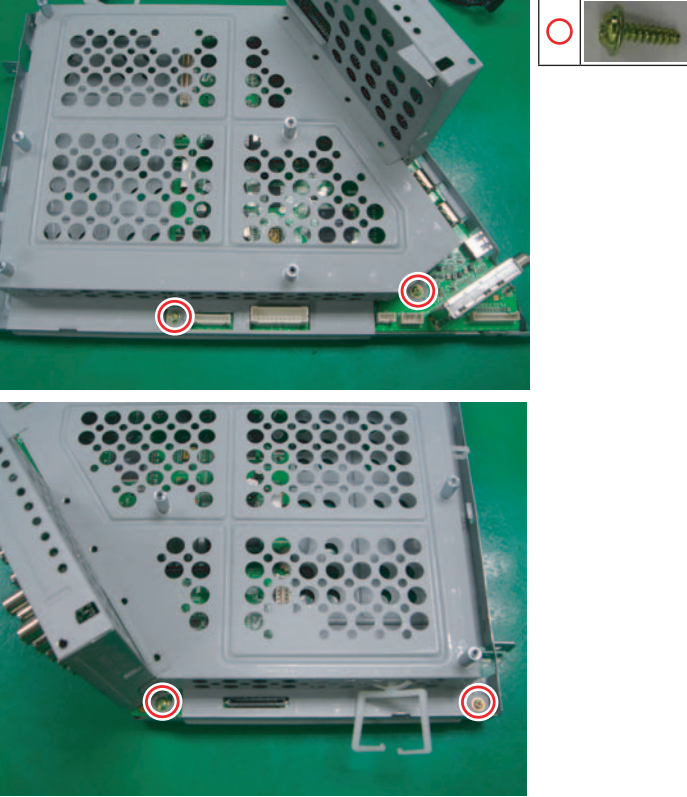
3-1-2 Separation of the Main Board and Power Board (Disassembly is in reverse order of the assembly)



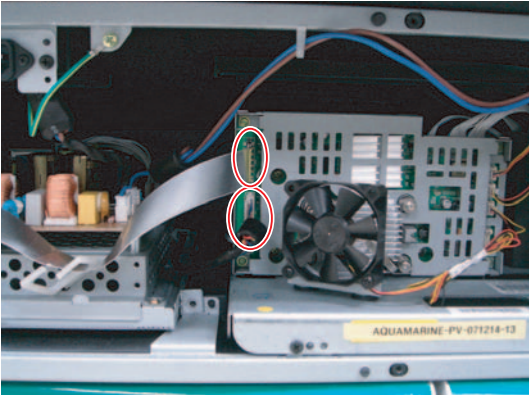
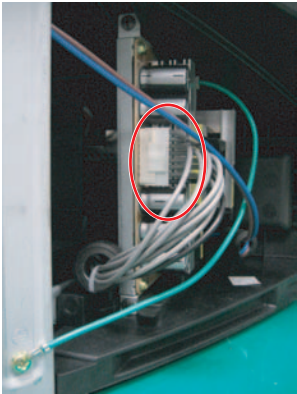
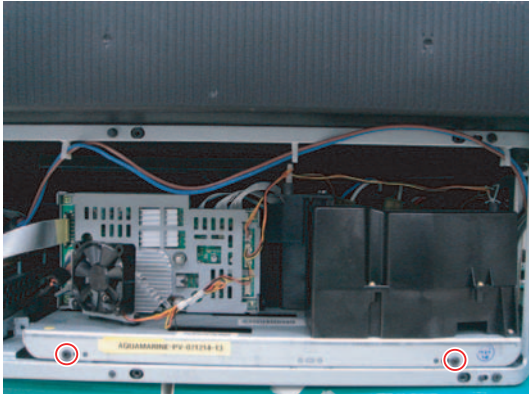

Part Name	Description	Description Photo
Main Assy	① Separate the 24PIN SMPS Wire, 1PIN GT Wire and.	
	① Remove 5 screws. :BH,+,-,S,M3,L6,ZPC(WHT), SWRCH18A ② Separate the SMPS Board.	

Part Name	Description	Description Photo
Main Assy	<p>① Remove 4 screws. :PWH,+,B,M3,L10,ZPC(YEL), SWRCH18A</p> <p>② Separate the Top Shield Case.</p>	
	<p>① Remove 1 screws. :PWH,+,B,M3,L10,ZPC(YEL), SWRCH18A</p> <p>② Separate the Bottom Shield Case.</p>	

3-1-3 Separation of the Optical Engine (Disassembly is in reverse order of the assembly)

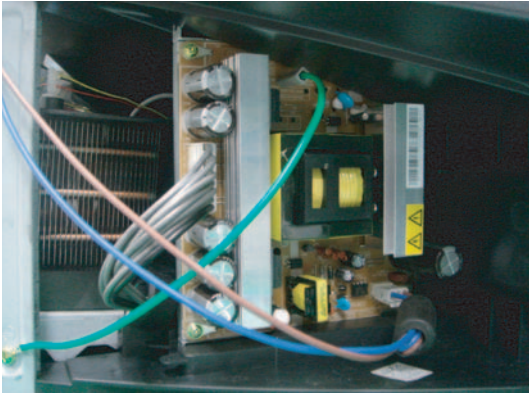
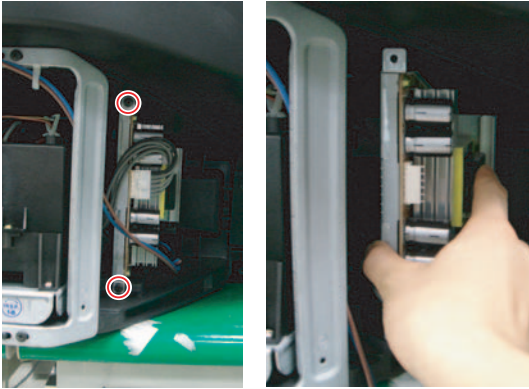
Part Name	Description	Description Photo
Optical Engine	① Remove the 10 PIN DMD Power Cable and LVDS Cable (the bottom one on the left side).	
	① Remove the 6 PIN LED Power Cable.	
	<p>① Remove the 2 screw. : BH,+,B,M4,L12,ZPC(BLK),SWRCH18</p> <p>② Remove the engine by pulling it out of the cabinet.</p> <p>⚠: Be careful when removing the Light Engine as it may get caught up by the upper cable of the case.</p>	 

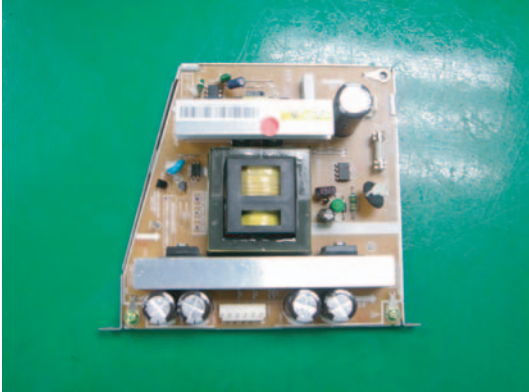
3-1-4 Separation of the Sub Power Board (Disassembly is in reverse order of the assembly)

Part Name	Description	Description Photo
Sub Power Board	<p>① Separate the 6PIN LED Power cable, 2PIN Sub SMPS Wire and 1PIN GT Wire.</p>	
	<p>① Remove 2 screws. :BH,+ ,B,M4,L12,ZPC(BLK),SWRCH18</p> <p>② Pull out the chassis.</p>	 
	<p>① Remove the screws and detach the boards from the holder chassis. :PWH,+,- ,B,M3,L10,ZPC(WHT), SWRCH18A,-</p>	 

3-1-5 Separation of the LED Driver Board (Disassembly is in reverse order of the assembly)

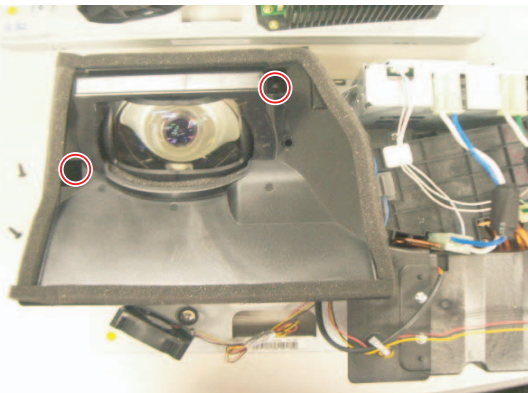
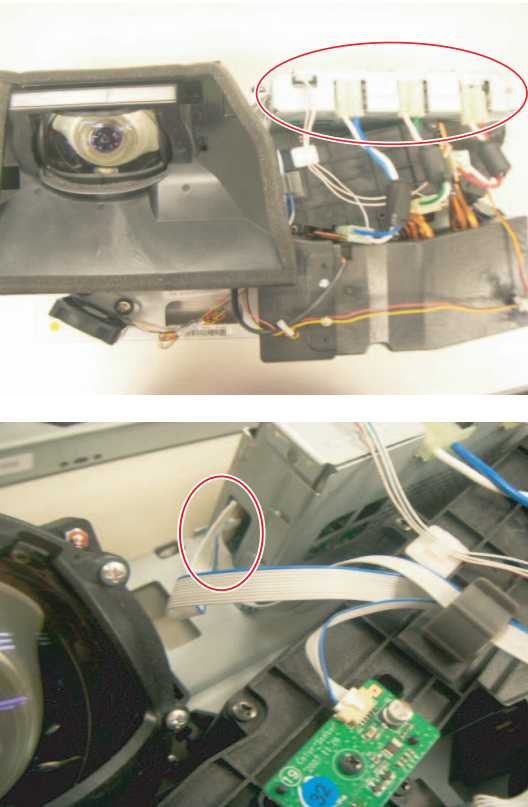
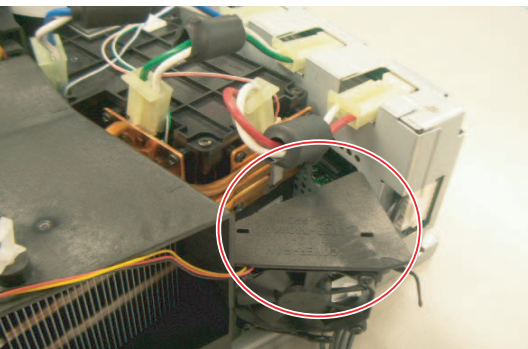
Part Name	Description	Description Photo
LED Driver Board	<ol style="list-style-type: none"> ① Separate the optical chassis from the Cabinet. ② Remove the 2 screws. :BH,+ ,B,M4,L12,ZPC(BLK),SWRCH18 ③ Remove the Cover-P/J Lens from the Optical chassis. 	
	<ol style="list-style-type: none"> ① Separate the cables. 	
	<ol style="list-style-type: none"> ① Remove the FAN. 	

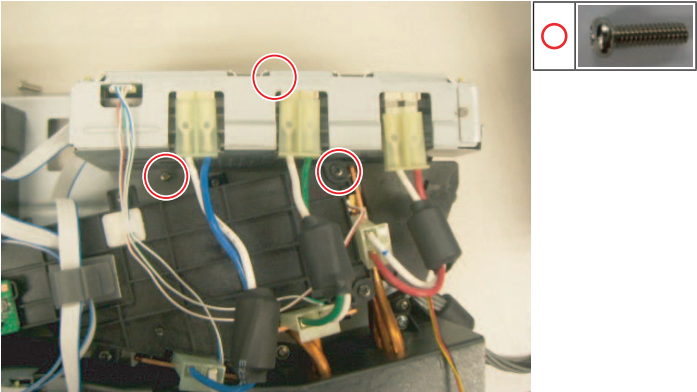
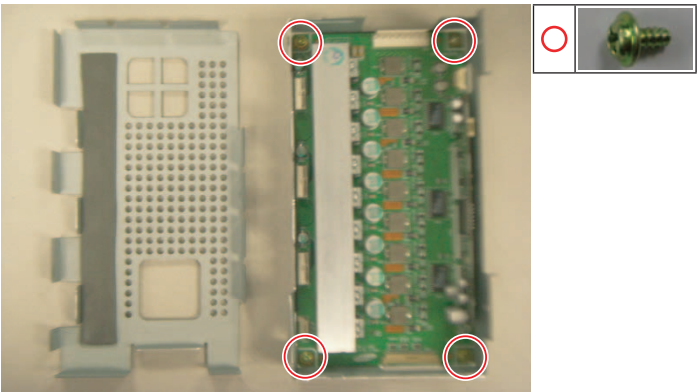
Part Name	Description	Description Photo
LED Driver Board	① Remove the 3 screws. :PH,+ ,M4,L12,NI PLT,SWRCH18A,FP,-	
	① Remove the 4 screws. :PWH,+ ,- ,B,M3,L6,ZPC(WHT), SWRCH18A,-	

3-1-6 Actuator (Smooth Picture) Replacement (Disassembly is in reverse order of the assembly)

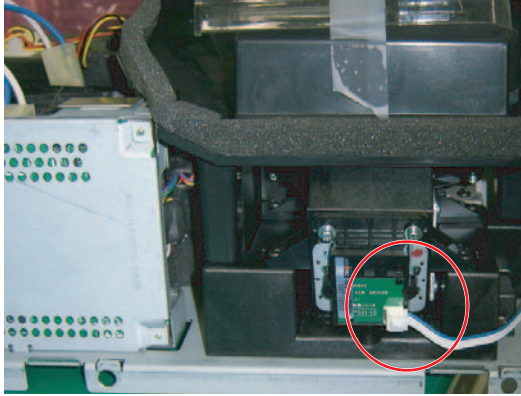
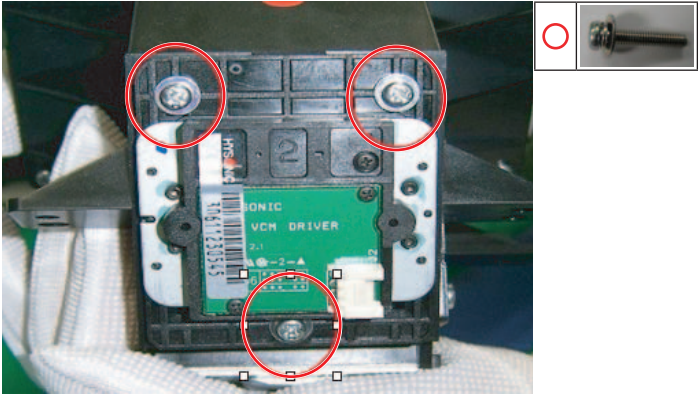
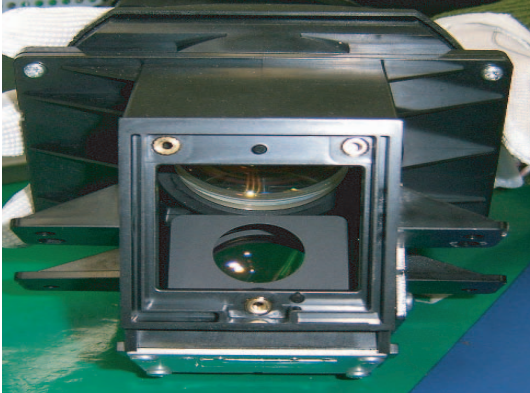
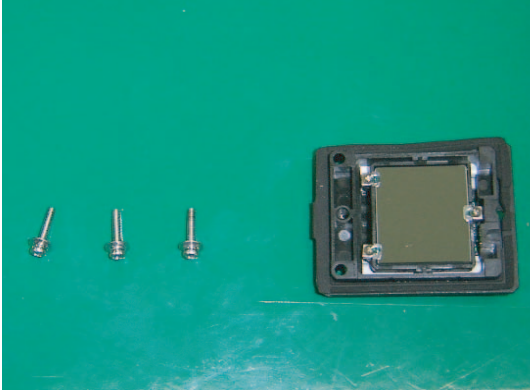

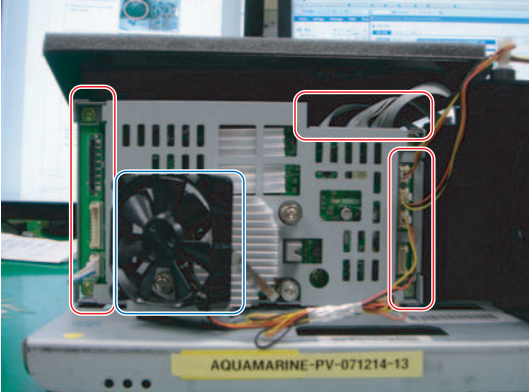
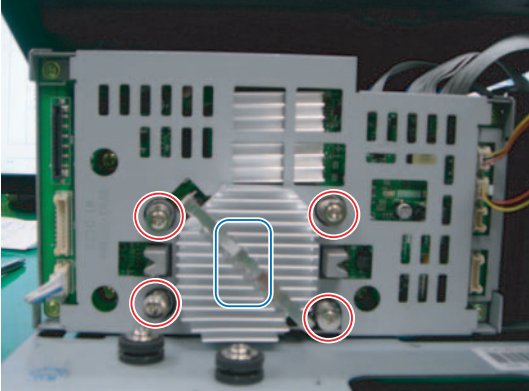
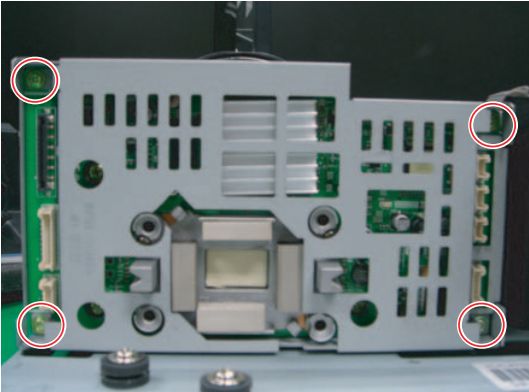

Part Name	Description	Description Photo
Actuator	① Remove the cable at the Actuator.	
	① Remove the 3 screws. :BH,+ ,WSP,M3,L16,ZPC(WHT), SWRCH18A,-,-	
	① Replace it with a new actuator.	
	① Actuator, fixing bolts.	

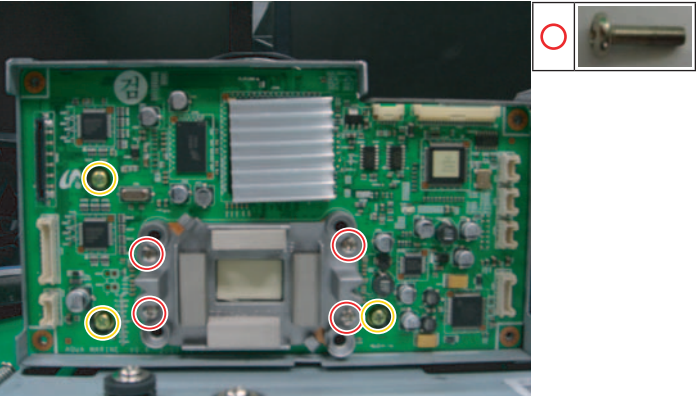
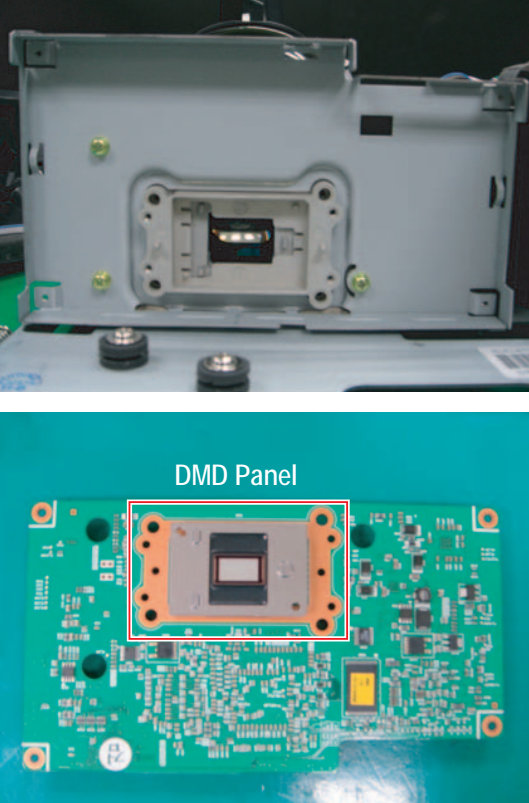
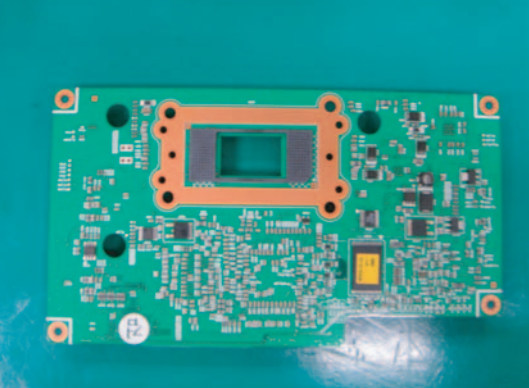
3-1-7 Separation of the DMD Board and Panel (Disassembly is in reverse order of the assembly)

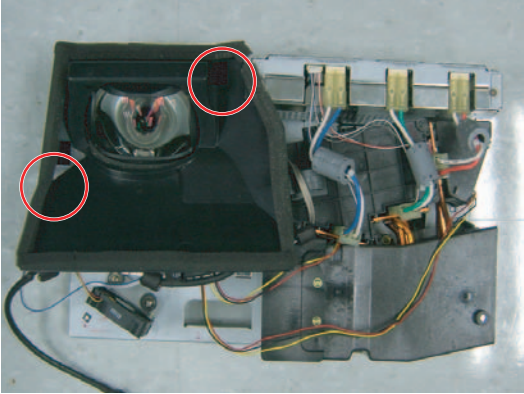

Part Name	Description	Description Photo
DMD Board	<ol style="list-style-type: none"> ① Separate the optical chassis from the Cabinet. ② Remove the 2 screws. :BH,+,B,M4,L12,ZPC(BLK),SWRCH18 ③ Remove the Cover-P/J Lens from the Optical chassis. 	
	<ol style="list-style-type: none"> ① Remove the FAN in front of the DMD Board. ② Separate the 8point Cables. 	
	<ol style="list-style-type: none"> ① Remove the 4 point screws. :PWH,+, -,M3,L30,NI PLT,SWRCH18A,UP,- ② After pushing the part of Spring_H/S DMD then separate it. 	
	<ol style="list-style-type: none"> ① Remove the 4 screws. :PWH,+, ,B,M3,L6,ZPC(WHT), SWRCH18A,- ② Remove the Shield Case-DMD(R). 	

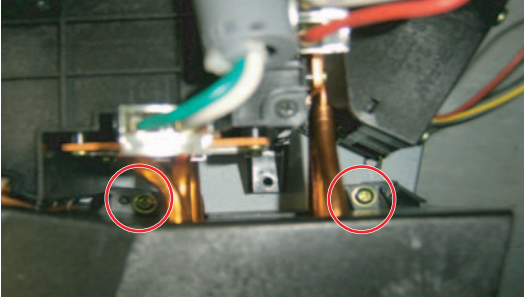
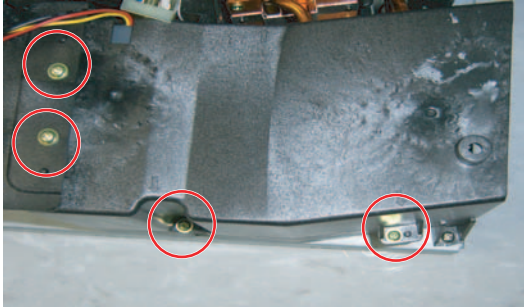
Part Name	Description	Description Photo
DMD Board	<p>① Remove the 4 point screws. :BH,+,M3,L12,NI PLT,SWRCH18A,-,-</p> <p>② Remove the Bracket.</p> <p>⚠: Don't remove the 3 Yellow point screws</p>	
	<p>① Remove the DMD Board. Separate DMD Panel.</p>	
	<p>① DMD Board</p>	

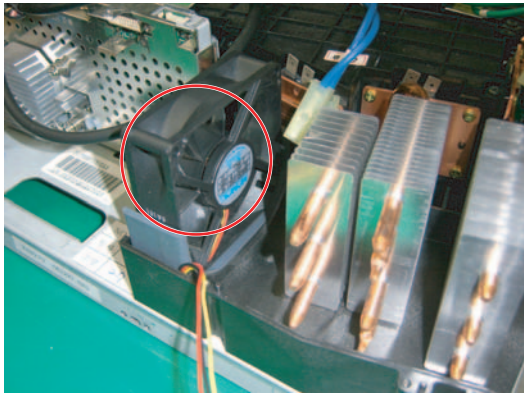
3-1-8 Separation of the LEDs (Disassembly is in reverse order of the assembly)

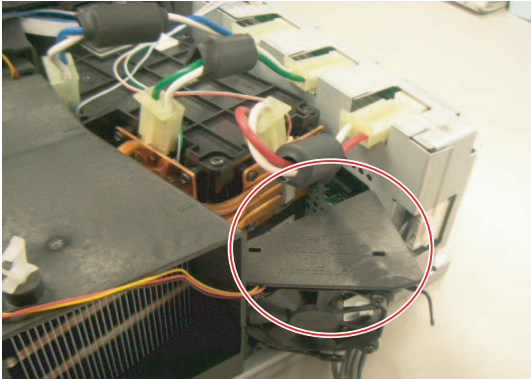
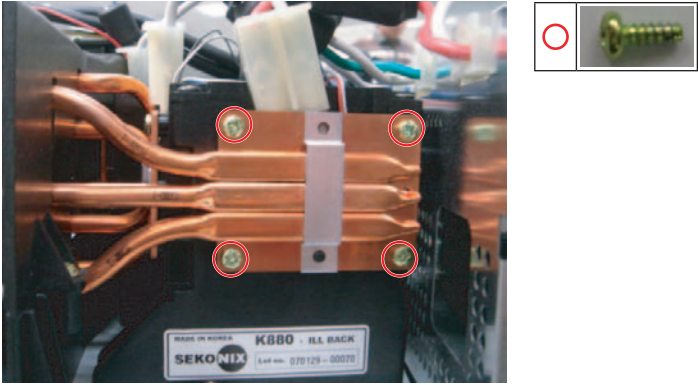
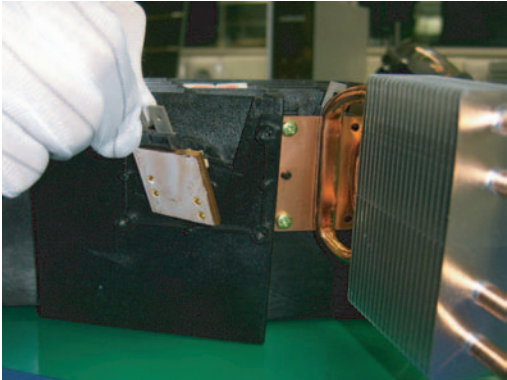
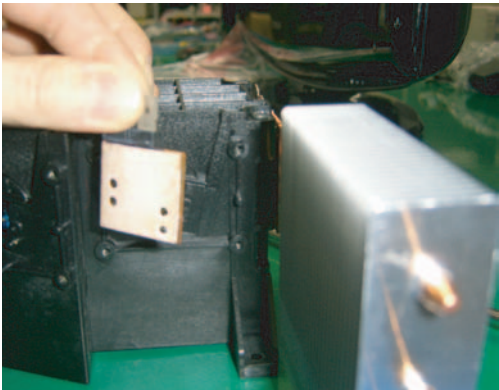

Part Name	Description	Description Photo
LED	<ol style="list-style-type: none"> ① Separate the optical chassis from the Cabinet. ② Remove the 2 screws. :BH,+ ,B,M4,L12,ZPC(BLK),SWRCH18 ③ Remove the Cover-P/J Lens from the Optical chassis. 	 
	<ol style="list-style-type: none"> ① Remove the 6 point screws. :BH,+ ,-,B,M3,L8,ZPC(BLK), SWRCH18A,- ② Separate the COVER-TOP. 	  
	<ol style="list-style-type: none"> ① Remove the FAN. 	

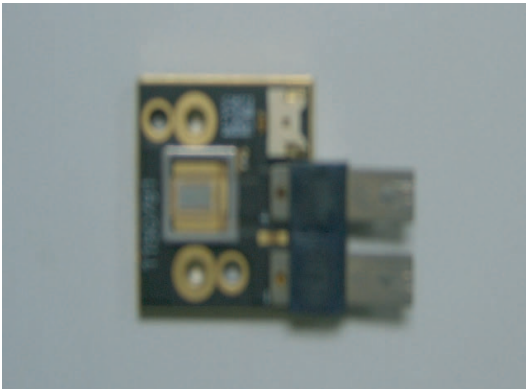

Part Name	Description	Description Photo
LED	① Remove the FAN.	
	① Remove the 4 point screws of Heat Sink-Pipe and then Remove the Heat Sink-Pipe. :	
	① Remove the BLUE LED.	
	① Remove the GREEN LED.	

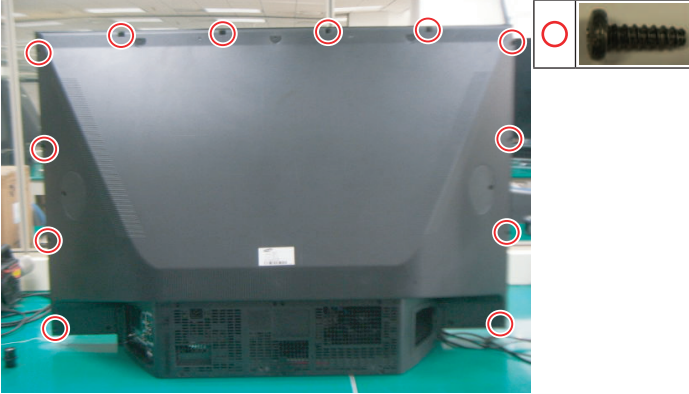
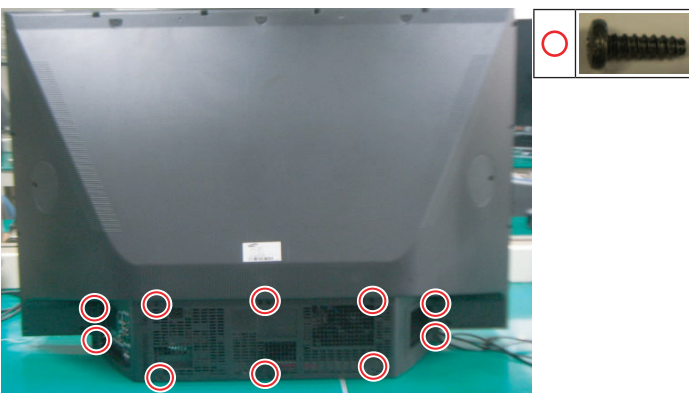
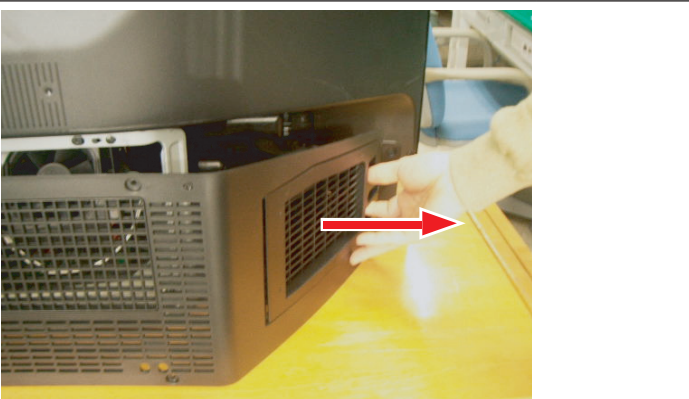
Part Name	Description	Description Photo
LED	① Remove the RED LED.	 
	① LED	

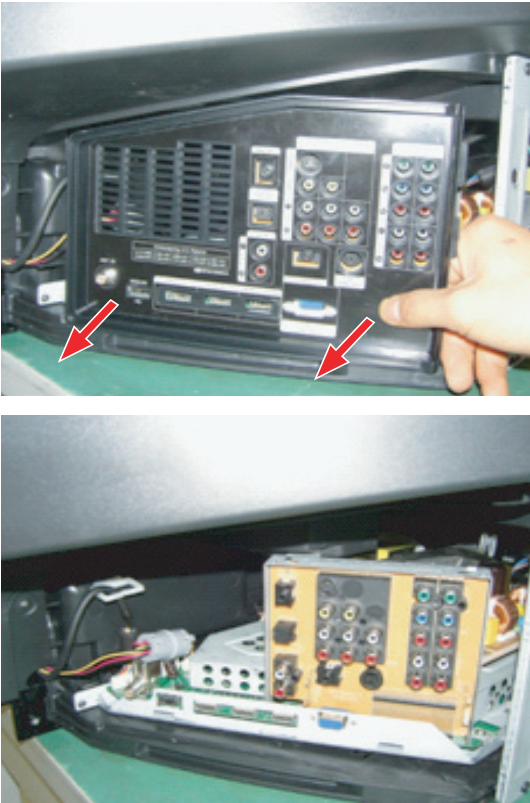
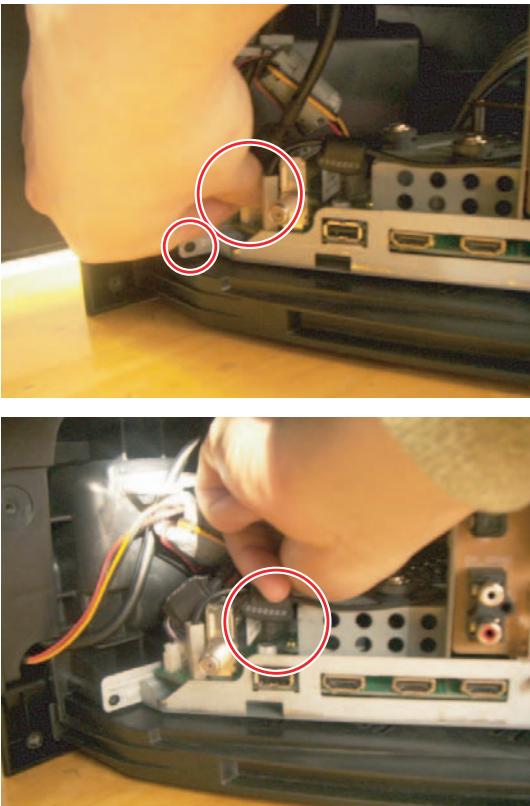
3-1-9 Separation of the SCREEN (Disassembly is in reverse order of the assembly)

Part Name	Description	Description Photo
FRONT, REAR disassembly	① Separate 12 screws for fixing COVER-REAR and COVER-FRONT. : TH, M4, L15, BLK	
	① Separate 10 screws for fixing COVER-REAR, Bottom and COVER-FRONT. : TH, M4, L15, BLK	
	① Separate Bottom and COVER-REAR pull right and then take them off.	

Part Name	Description	Description Photo
<p>HOLDER-TERMINAL disassembly</p>	<p>① After separating COVER-REAR and Bottom, separate HOLDER-TERMINAL.</p>	
<p>CONNECTOR disassembly</p>	<p>① Remove 1 Screw : TH, M4, L15, BLK</p> <p>② Separate the 2 connectors from the main board</p>	 

Part Name	Description	Description Photo
FRONT COVER disassembly	① Separate COVER-FRONT from SET. ② Separate 3 screws fixing BRKT-SCREEN : TH, M4, L12, YELLOW	
BRACKET SCREEN disassembly	① Remove the BRKT-SCREEN by pushing it toward the direction of the arrow.	

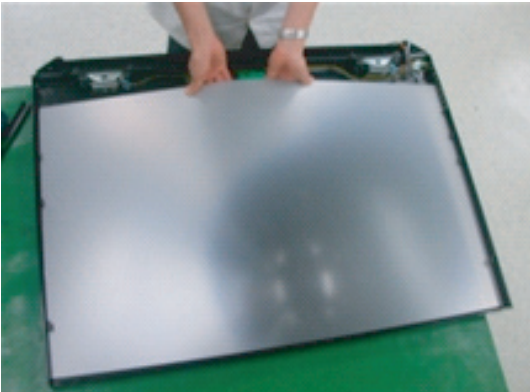
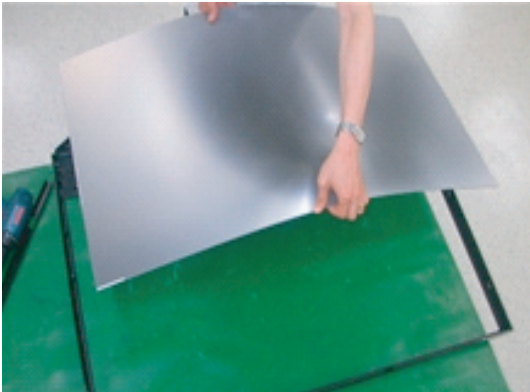

Disassembly & Reassembly

Part Name	Description	Description Photo
SCREEN disassembly	① Place your hand at the bottom center of the screen then pick it up while pulling it towards you.	
	① Separate the screen in the COVER-FRONT.	

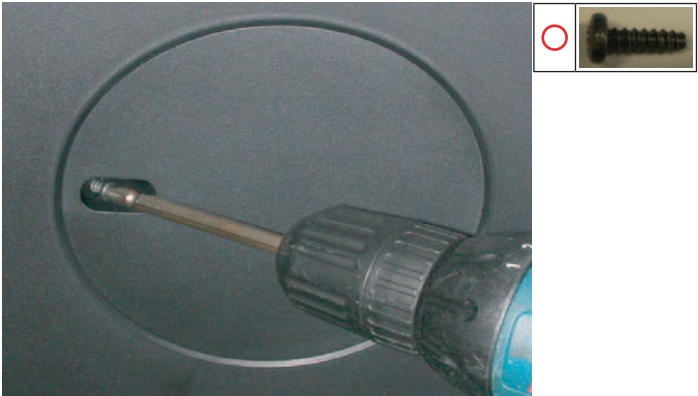
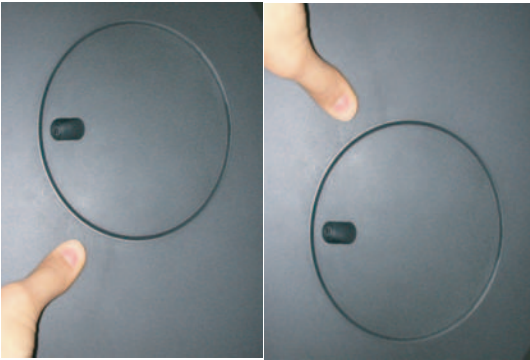
3-1-10 Separation of the COVER-DUST (Disassembly is in reverse order of the assembly)

Part Name	Description	Description Photo
COVER DUST	① COVER-DUST	
	① Separate 1 screw for fixing COVER-REAR and COVER-DUST : BH,+ ,B,M4,L12,ZPC(BLK),SWRCH18	
	② Push the indicating sign of the picture and separate SNAP of C/DUST from C/REAR. (Pushing part : the upper or lower part of jointing Screw)	

Disassembly & Reassembly

Part Name	Description	Description Photo
COVER DUST	③ Separate C/DUST with using the gap which occurs when ^pSNAP of C/DUST is separated.	
	① Separate the screen in the COVER-FRONT.	

4. Troubleshooting

4-1 Troubleshooting

4-1-1 First Checklist for Troubleshooting

■ Basics:

- The DDP3021 on the DMD board has a feature to display internal test patterns.
- The BAYHILL+ is the output of the Main. DMD is the final one.

■ Diagnosis By Module

1. Access Service Mode

(In Standby mode, press MUTE, 1, 8, 2 and POWER to turn the screen on and enter service mode)

2. Check if there is an error in the DMD board

DDP3021 → TEST PATTERN → Press the right arrow key:

Options of FULL WHITE, BLACK, RED, GREEN and BLUE PATTERN and so on are displayed on the screen.

If "Pattern" does not appear or same symptom is appeared on DDP3021 pattern, this is a DMD board error.

3. Check if there is an error in the main board.

Check for a power signal from SMPS to other board see the schematic diagram. (7-3) And check for indicated power signal.

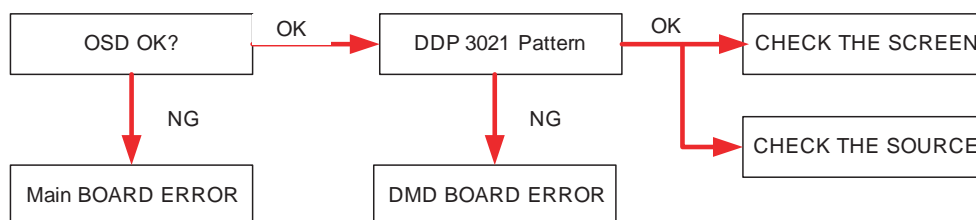
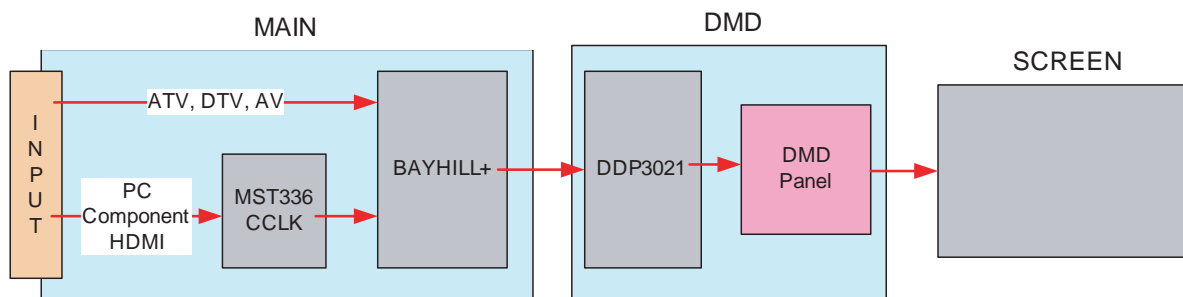

■ Flow Chart for Malfunction

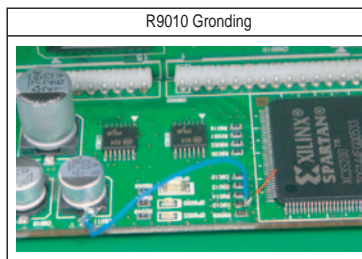
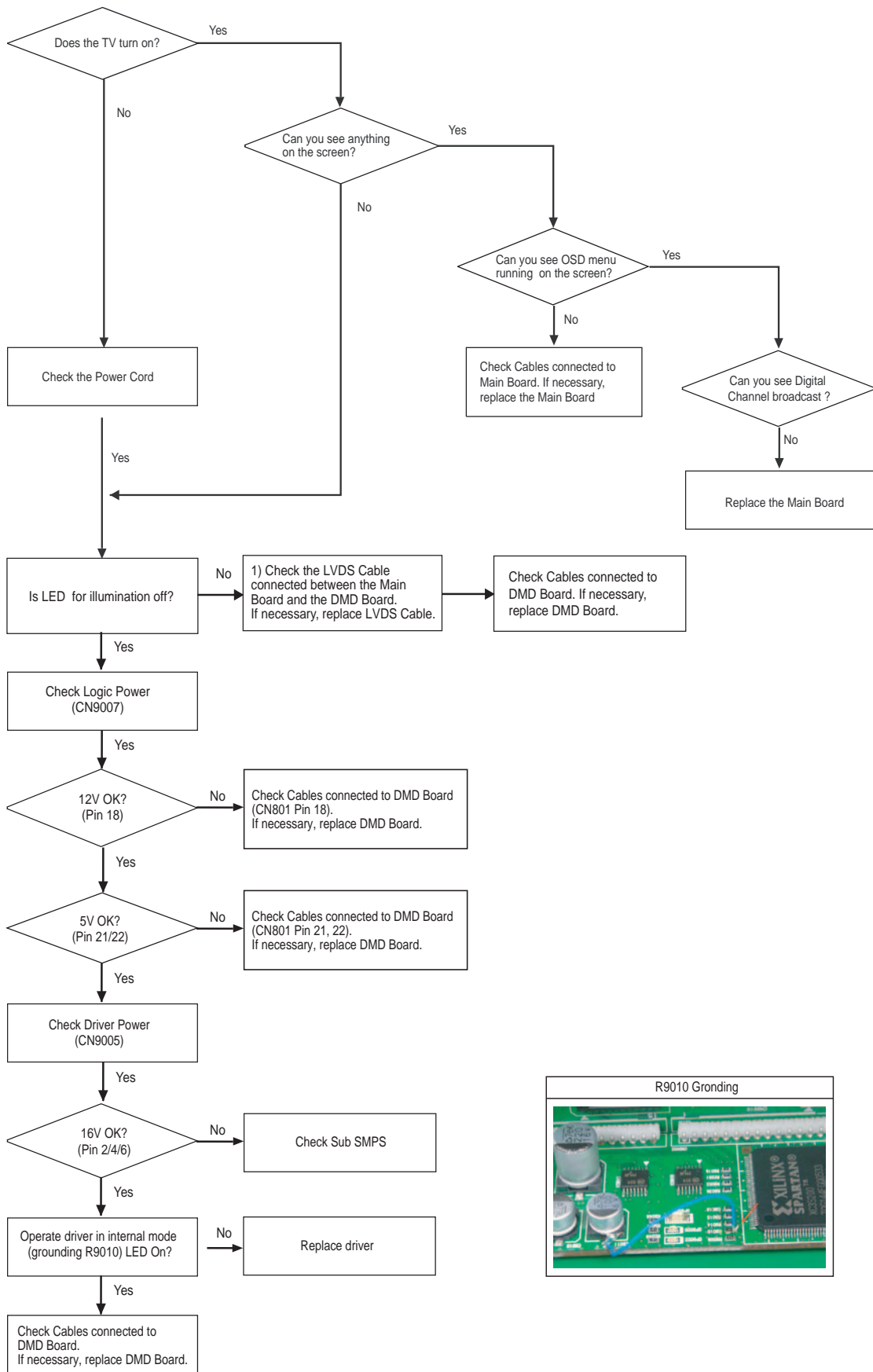

■ Installation & Connection

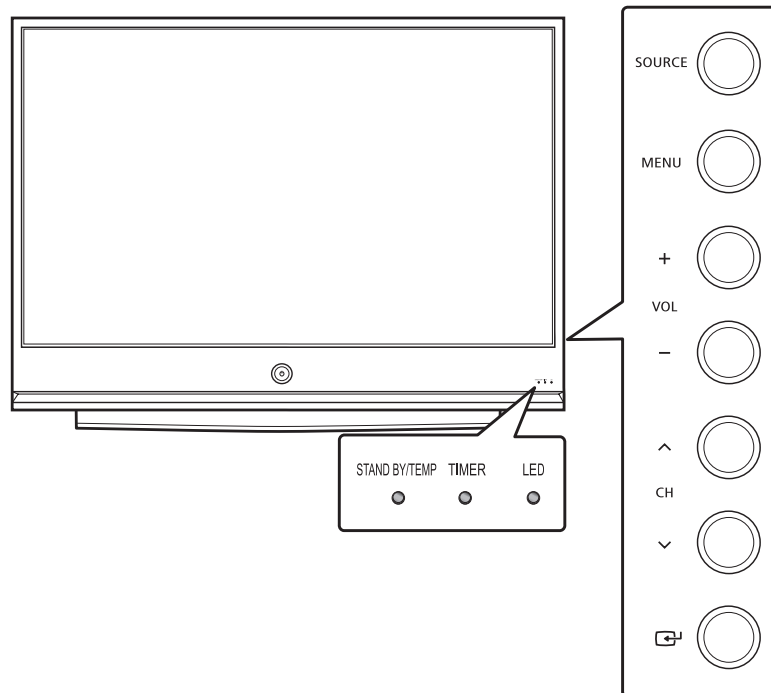



- :Light is On
- ◐:Light is Blinking
- :Light is Off

TIMER	LED	STAND BY/TEMP	Indication
●	○	○	Standby state.
○	○	◐	The picture will automatically appear in about 15 seconds.
○	●	○	Auto Timer ON/OFF has been set and the set will automatically be turned on in about 15 seconds.
◐	◐	○	A cooling fan inside the set is not operating normally.
◐	○	○	The inner Power Signal on the main board may be short or opened. Please contact a certified technician.
◐	◐	◐	LED may be defective. Please contact a certified technician.

■ Protect Status

1. Attempting to turn the LED ASSY on fails repeatedly
 If turning the LED on fails, the set automatically tries turning the LED ASSY on 3 times. If all attempts fail, all LED's on the front panel will blink. Check the LED ASSY, LED Driver and the Sub power or SMPS and replace them if necessary.

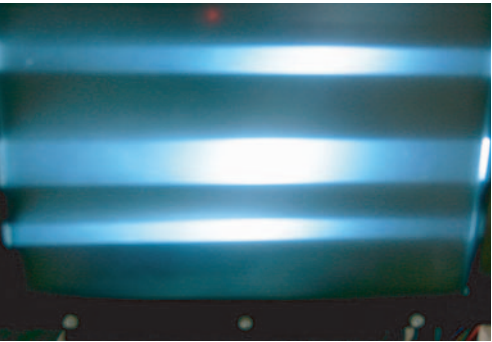
4-1-2 Faults and Corrective Actions

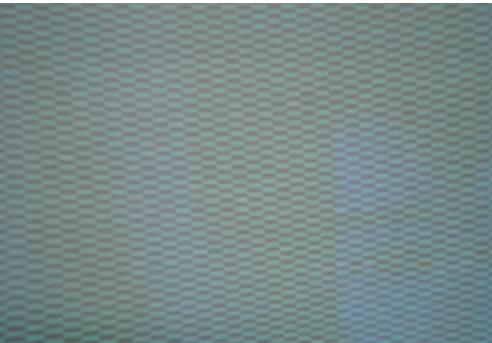
Symptom	Related Image	Causes and Countermeasures
40 Vertical lines 16 pixels wide		DDP3021 or BGA, DMD panel interference. - Replace the DMD board
Horizontal Bar or No Raster		Error in DDP3021 or the DMD panel. - Replace the DMD board
Dotted Vertical Bar		Error in Rambus Dram (IC301) or the soldering. - Replace the DMD board
Beehive mosaic patterns all over the screen		Error in the LVDS Receiver (IC101,IC102) or the soldering. The H sync signals are not transferred to DDP3021. - Replace the DMD board.

1. Noise:

Internal noise may be caused by a foreign substance on the fan or driving device.

For a DLP TV, the LED fans and DMD board fan are vulnerable to noise. Sometimes the connector wire around the lamp or DMD fan makes contact with the fan.

When irregular noise occurs for no particular reason, check the inside of the TV for any foreign substances.

The DLP projection TV may cause noise because the physical space is empty inside, causing a resonance at a particular frequency. Thus a low vibration is not a malfunction.

Any 'creaking' noise is mostly from the structure of the device itself. A short, harsh noise may occur from a distortion or malformation due to thermal expansion between the metal joints, screws and loaded parts, respectively. Any intermittent 'creaking' noise can be removed by loosening the screws.

2. Black Screen (Voice Output): Replace the DMD board**3. A black screen with the LED on :** Replace the DMD Board.**4. Line Pattern:** Regular line patterns occur vertically or horizontally: Replace the DMD board.**5. Voice Distortion:** Replace the main board.**6. Outside Light:** This is not a product malfunction, but a possible installation or human error. This occurs when the projected light from the surrounding illumination reflects onto the screen. This disappears as the TV starts operating and the TV lamp gets brighter. However, you can avoid outside light by changing the position of the TV or the installation angle. Decreasing the illumination or changing the indoor lighting may work.**7. Screen Flip-over:**

Enter Factory mode in DDP3021 and perform H-Flip (flip horizontally) and V-Flip (flip vertically).
The screen will flip over horizontally or vertically.

4-2 Adjustment

4-2-1 Service Instruction

- Check items listed after changing each

Check Items Replaced Items	S/W Version	Front LED	Actuator Gain	V-Position H-Position	LED control	Board LED	Tilt Focus
Main Board	●	●	●	●	●	●	
Main Power Board						●	
Sub Power Board						●	
Optical Engine		●	●	●	●		●
DMD Board			●	●	●	●	●
LED (R/G/B)		●			●		
Front LED Assy		●			●		
Detect Board		●				●	
LED Driver board					●	●	

1. Software version check :

After Entering the Service mode, Check the list below

*S/W Notation

"T-AQMAUSC-XXXX" indicates "AquaMarine Model US VER XXXX"

```
T-AQMAUSC-XXXX
T-AQMAUSM-XXXX
EDID SUCCESS
RFS : T-AQMAUSC-YYYYMMDD
YYYY-MM-DD
DMD XX, DSP-X-X-X
DTP-LM-XXXX
Date of Purchase : DD/MM/YYYY
```

2. Front Information Window check : See page 4-4.
3. DMD 0x00000001 indicates DMD board bit sequence program version.
4. Actuator Gain adjustment : See page 4-24.
5. Vertical / Horizontal Position adjustment : See page 4-21.
6. CCA : See page 4-22.
7. Board LED check : Check the LED is turned on.
(In the DMD Board)

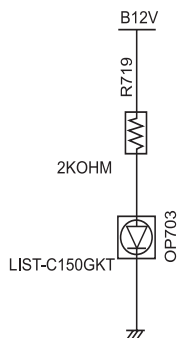

8. Tilt/Focus adjustment : See page 4-25 ~4-28.

4-2-2 How to Access Service Mode

1. Turn off the power to put the unit into the STAND-BY mode.
2. In order to enter the Service Mode, press **MUTE** → **1** → **8** → **2** → **POWER** button on the remote control.
In case entry into SERVICE MODE is unsuccessful, repeat the procedures above.
3. Initial DISPLAY State in times of Service Mode Switch overs

Option Byte
DDP3021
CCA(ON)
Cinema CCA
Desaturation(ON)
SP Actuator
WB
EPA Standard
BHP_VDEC
MST336C
BHP_DP
Sharpness
FBE3
LNA+
Expert Setting

Expert D-Setting
Expert Gray Scale
Expert C-Space
Expert Others
SOUND
EDID
ESP
CHECKSUM
SERVICE
DEFECT LOG
Font Data Viewer

T-AQMAUSC-XXXX
T-AQMAUSM-XXXX
EDID SUCCESS
RFS : T-AQMAUSC-YYYYMMDD
YYYY-MM-DD
DMD XX, DSP-X-X-X
DTP-LM-XXXX
Date of Purchase : DD/MM/YYYY

4. Buttons operations within Service Mode

MENU	Full Menu Display / Move to Parent Menu
Direction keys ▲ / ▼	Item Selection by Moving the Cursor
Direction keys ◀ / ▶	Data Increase/Decrease for the Selected Item
Source	Cycles through the active input source that are connected to the unit
Enter	Item Selection/execution

4-2-3 Factory Data ♦ The underlined are items applied during the service adjustment. None of the others should be adjusted.

1. Option Byte

No	Item	Range	Default	Remark
1	Factory Reset	OFF/ON	OFF	Clear user data and Digital to DMD.
2	WB Reset	OFF/ON	OFF	Clear WB Data When EEPROM Reset, If it is ON.
3	EEPROM Reset	OFF/ON		Clear EEPROM related with picture setting data and user data.
4	User Reset	OFF/ON		Clear EEPROM related with the informaion of user like channel, time, etc.
5	DIGITAL → DMD			Transfer CCA data from Main to DMD B'd
6	LED Clear			Clear LED Life time
7	LED Life			The time for LED On
8	Auto Power	OFF/ON	ON	The set set turns on automatically when it is plug in after the sets is plug out while the set is on
9	Mute Time[RF]	0~1000ms	600ms	Time which the screen will be black while switching
10	PROTECT	OFF/ON	OFF	Check Fan Error, Temperation, Cover detect
11	Watchdog Enable	OFF/ON	OFF	Watch Dog ON/OFF selection
12	Watchdog Count		0	Count for Watch Dog event
13	DEBUG/RS232	Debug/RS232	Debug	Toggle between RS232 and Debug Mode
14	PC Mode Ident	Auto/Enable	Auto	PC is always ident on enable Mode.
15	HDMI Hot Plug	Enable/Disable	Enable	Hot Plug is Enable on Enable Mode
16	HDMI Hot Plug Delay	0~5000ms	1500ms	Set the time of Hot Plug Delay
17	HDMI Mute Time	Not Used		Set the HDMI Mute time
18	Shop Mode	OFF/ON	OFF	Shop mode on OFF, Home mode on ON
19	DMD → DIGITAL			Transfer CCA data from DMD B'd to Main B'd
20	DDP 3D Test	OK/NG		Test the 3D ready function.
21	Expert Adj.	OFF/ON	OFF	Expert control the set by RS-232
22	SUB MICOM DOWN	OFF/ON	OFF	Enable Sub Micom download when it is on.
23	SSC ON/OFF ON	ON/OFF		Control the Spread Spectrum. Controlled by Engineer.
24	SSC MRR	0		Control the Spread Spectrum. Controlled by Engineer.
25	SSC MFR	0		Control the Spread Spectrum. Controlled by Engineer.
26	SSC QLC	0		Control the Spread Spectrum. Controlled by Engineer.
27	VISUAL TEST	Enable/Disable	Disable	OSD is semitransparent on Disable

2. DDP3021

No	Item	Range	Default	Remark
1	H/V-Position	H:0/V:0 ~:60/ V:60	H:56/V:42	Horizontal and Vertical image adjustment
2	V-FLIP	Flip/Normal	Normal	Vertical Flip Operation
3	H-FLIP	Flip/Normal	Normal	Horizontal Flip Operation
4	GAMMA			Gamma Table Selection
5	MPC	ON/OFF	ON	MPC function On/Off
6	3D GLS_TRANS	0~4000	1800	Horizontal Flip Operation
7	Calibration			Gamma Table Selection
8	Test Pattern(DDP)	0~18	0	This displays the built-in pattern of the DDP3021 chip. DDP3021 drives the DMD panel, so displaying this pattern means there is no error in the DDP3021 projection function and the panel itself.

Troubleshooting

3. CCA(ON)

No	Item	Range	Default	Remark
1	CCA Control	On/Off	On	CCA On/Off Selection
2	Sensor Status	OK/NG	OK	Color Sensor valure save
3	Red-x	0.000~0.999	703	Red-x measurement value using CA210
4	Red-y	0.000~0.999	292	Red-y measurement value using CA210
5	Red-Y	(0~65535)	80.0	Red-Y measurement value using CA210
6	Green-x	0.000~0.999	173	Green-x measurement value using CA210
7	Green-y	0.000~0.999	731	Green-y measurement value using CA210
8	Green-Y	(0~65535)	300.0	Green-Y measurement value using CA210
9	Blue-x	0.000~0.999	146	Blue-x measurement value using CA210
10	Blue-y	0.000~0.999	31	Blue-y measurement value using CA210
11	Blue-Y	(0~65535)	25.0	Blue-Y measurement value using CA210
12	Color Sensor Save	OK	-	
13	WB Spread	OK	-	
14	[COOL2] DW-X	0.000~0.999	264	
15	[COOL2] DW-Y	0.000~0.999	267	
16	[COOL1] DW-X	0.000~0.999	269	
17	[COOL1] DW-Y	0.000~0.999	274	
18	[NORMAL] DW-X	0.000~0.999	276	
19	[NORMAL] DW-Y	0.000~0.999	282	
20	[WARM1] DW-X	0.000~0.999	285	
21	[WARM1] DW-Y	0.000~0.999	293	
22	[WARM2] DW-X	0.000~0.999	300	
23	[WARM2] DW-Y	0.000~0.999	310	
24	Max Current RED	0~255	232	
25	Max Current GRN	0~255	228	
26	Max Current BLU	0~255	232	
27	Sens Red-A	-	2604	
28	Sens Green-B	-	2244	
29	Sens Blue-C	-	3238	
30	[TI - COOL2] X	0.000~0.999	264	
31	[TI - COOL2] Y	0.000~0.999	267	
32	[TI - COOL1] X	0.000~0.999	269	
33	[TI - COOL1] Y	0.000~0.999	274	
34	[TI - NORMAL] X	0.000~0.999	276	
35	[TI - NORMAL] Y	0.000~0.999	282	
36	[TI - WARM1] X	0.000~0.999	300	
37	[TI - WARM1] Y	0.000~0.999	310	
38	[TI - WARM2] X	0.000~0.999	311	
39	[TI - WARM2] Y	0.000~0.999	327	
40	TI Offset Adjust	ON/OFF	ON	

4. Cinema CCA

No	Item	Range	Default	Remark
1	[COOL2] DWhiteX	0 ~ 32766	269	Target Red X value for CCA
2	[COOL2] DWhiteY	0 ~ 32766	274	Target Red Y value for CCA
3	[COOL1] DWhiteX	0 ~ 32766	276	Target Green X value for CCA
4	[COOL1] DWhiteY	0 ~ 32766	282	Target Green Y value for CCA
5	[NORMAL] DWhiteX	0 ~ 32766	285	Target Blue X value for CCA
6	[NORMAL] DWhiteY	0 ~ 32766	293	Target Blue Y value for CCA
7	[WARM1] DWhiteX	0 ~ 32766	300	Target Cyan X value for CCA
8	[WARM1] DWhiteY	0 ~ 32766	310	Target Cyan Y value for CCA
9	[WARM2] DWhiteX	0 ~ 32766	313	Target Magenta X value for CCA
10	[WARM2] DWhiteY	0 ~ 32766	329	Target Magenta Y value for CCA

justmanuals.com

Troubleshooting

5. Desaturation(ON)

No	Item	Range	Default	Remark
1	Desaturation Control	ON/OFF	ON	
2	Desaturation Mode	Normal, Wide, RGB	0 [Normal]	
3	[NORMAL] Red-x	0 - 1000	660	
4	[NORMAL] Red-y	0 - 1000	315	
5	[NORMAL] Green-x	0 - 1000	260	
6	[NORMAL] Green-y	0 - 1000	640	
7	[NORMAL] Blue-x	0 - 1000	150	
8	[NORMAL] Blue-y	0 - 1000	50	
9	[NORMAL] Cyan-x	0 - 1000	179	
10	[NORMAL] Cyan-y	0 - 1000	293	
11	[NORMAL] Magenta-x	0 - 1000	263	
12	[NORMAL] Magenta-y	0 - 1000	108	
13	[NORMAL] Yellow-x	0 - 1000	412	
14	[NORMAL] Yellow-y	0 - 1000	518	
15	[WIDE] Red-x	0 - 1000	680	
16	[WIDE] Red-y	0 - 1000	305	
17	[WIDE] Green-x	0 - 1000	165	
18	[WIDE] Green-y	0 - 1000	700	
19	[WIDE] Blue-x	0 - 1000	150	
20	[WIDE] Blue-y	0 - 1000	38	
21	[WIDE] Cyan-x	0 - 1000	163	
22	[WIDE] Cyan-y	0 - 1000	293	
23	[WIDE] Magenta-x	0 - 1000	265	
24	[WIDE] Magenta-y	0 - 1000	95	
25	[WIDE] Yellow-x	0 - 1000	413	
26	[WIDE] Yellow-y	0 - 1000	520	
27	[sRGB] Red-x	0 - 1000	640	
28	[sRGB] Red-y	0 - 1000	330	
29	[sRGB] Green-x	0 - 1000	295	
30	[sRGB] Green-y	0 - 1000	595	
31	[sRGB] Blue-x	0 - 1000	150	
32	[sRGB] Blue-y	0 - 1000	60	
33	[sRGB] Blue-y	0 - 1000	225	
34	[sRGB] Cyan-y	0 - 1000	390	
35	[sRGB] Magenta-x	0 - 1000	365	
36	[sRGB] Magenta-y	0 - 1000	170	
37	[sRGB] Yellow-x	0 - 1000	422	
38	[sRGB] Yellow-y	0 - 1000	494	
39	Over lap	0 ~ 2	0	

6. SP Actuator

No	Item	Range	Default	Remark
1	Actu Gain [Patt1]	0~175	45	Actuator Gain adjustment
2	Actu Gain [Patt2]	0~175	45	Actuator Gain adjustment
3	Actu On/Off	0~1	ON	Actuator On/Off selection
4	DB On/Off	0~1	OFF	
5	DB Border	ON/OFF	OFF	
6	DB BP Weight	-	0	
7	DB Gain	0~3	0	
8	DB Aperture	ON/OFF	ON	
9	SB Gain	0~255	0	

7. WB (White Balance)

No	Item	Range	Default	Remark
1	Sub Brightness	0~255	128	
2	R-Offset	0~1023	512	
3	G-Offset	0~1023	512	
4	B-Offset	0~1023	512	
5	Sub Contrast	0~ 255	128	
6	R-Gain	0~1023	512	
7	G-Gain	0~1023	512	
8	B-Gain	0~1023	512	

8. EPA Standard

No	Item	Range	Default	Remark
1	Standard Contrast	0~100	95	Setting Contrast in Standard Mode
2	Standard Brightness	0~100	45	Setting Brightness in Standard Mode
3	Standard Sharpness	0~100	50	Setting Sharpness in Standard Mode
4	Standard Color	0~100	50	Setting Color in Standard Mode
5	Standard Tint	0~100	50	Setting Tint in Standard Mode
6	Standard Backlight	0~10	7	Setting Backlight in Standard Mode

Troubleshooting

9. BHP_VDEC

No	Item	Range	Default	Remark
1	agc_mode	0~1	1	
2	Y_Gain_Man	0~8184	880	
3	saturation	255	128	Saturation
4	hue	255	0	Positive range 0x0000 00 → 0x3F (brightest), Negative range 0x40 (darkest) → 0xFF
5	Y_shape_sel		13	
6	C_shape_sel		4	
7	lf_irr		0	If comp filter bypass
8	if_filt_sel		7	If comp filter selection
9	LTI_en		0	
10	LTI_filt_sel		0	Select filter response as part of LTI (0:filter response 0, 1:filter response 1)
11	LTI_level		15	Bigger value:less obvious sharpening of luma transients, 0:max transient improvement
12	CTI_en		0	CTI level
13	CTI_filt_sel		1	Select filter response as part of CTI (0:filter response 0, 1:filter response 1)
14	CTI_level		15	CTI level
15	V_Delay_adj		1	
16	U_Delay_adj		0	
17	ST_Beg_NTSC		0	
18	vs_slice_level		3	Vs slice level 00 → lowest, 11 highest
19	hs_slice_level		6	Hs slice level 00 → lowest, 11 highest
20	synctip_noise		17	Synctip noise readback
21	bl_auto_speed_control		0	1 → auto speed up/down hs pll based on input quality, 0 → don't
22	bl_force_slow		0	Hsync pll parameter
23	bl_force_fast		0	Hsync pll parameter
24	3D_DNR_en		1	
25	3D_DNR_Gain		11	Larger values give narrower bandwidth and more noise reduction but also more motion blur DNR noise bandwidth
26	allow_3d_filt_sel		0	
27	3d_comb_noise_sns		0	Larger values allow more temporal comb for noisy RF signals but may also introduce motion error
28	3d_comb_chroma_sns		8	Larger values decrease 3D comb motion detection sensitivity to chroma motion and noise
29	3d_comb_chroma_sns		8	Larger values increase 3D comb motion detection sensitivity to chroma motion and noise
30	3d_comb_luma_core		8	Larger values decrease 3D comb motion detection sensitivity to luma motion and noise
31	3d_comb_luma_sns		8	Larger values increase 3D comb motion detection sensitivity to luma motion and noise
32	cmd_gain_mts_ntsc		0	

10. MST336C

No	Item	Range	Default	Remark
1	RED CUTOFF	0~255	128	INACTIVE
2	GREEN CUTOFF	0~255	128	
3	BLUE CUTOFF	0~255	128	
4	PHASE	0~63	46	
5	RED GAIN	0~255	192	
6	GREEN GAIN	0~255	192	
7	BLUE GAIN	0~255	192	
8	SOGMID_CTRL	0~31	23	
9	SEP_THR	0~255	45	
10	PRECST	0~255	11	
11	POSTCST	0~255	11	
12	ADC_BWR	0~15	0	
13	ADC_BWG	0~15	0	
14	ADC_BWB	0~15	0	
15	SOG_BW	0~255	0	
16	D_R_offset	0~127	0	
17	D_G_offset	0~127	0	
18	D_B_offset	0~127	0	
19	D_CALDLYC	0~255	224	
20	D_SMPDLY	0~255	12	
21	D_SMPDURC	0~255	8	
22	CAL_CTRL0	0~255	157	

Troubleshooting

11. BHP_DP

No	Item	Range	Default	Remark
1	Deblock_ON	0~3	1	
2	MixTH1	0~255	110	
3	MixTH2	0~255	55	
4	NARS_ON	0~3	0	
5	SD_CSC	0~9999	7094	
6	HD_CSC	0~9999	7438	
7	M_SD_CSC	0~9999	7094	
8	M_HD_CSC	0~9999	7438	

12. Sharpness

No	Item	Range	Default	Remark
1	sharp75	0~100	75	
2	Pre_GainH1	0~15	0	
3	Pre_GainH2	0~15	2	
4	Pre_GainV1	0~15	1	
5	Pre_GainV2	0~15	7	
6	Post_GainH1	0~15	6	
7	Post_GainH2	0~15	7	
8	Post_GainH3	0~15	7	
9	Post_GainV1	0~15	3	
10	Post_GainV2	0~15	10	
11	CTI_Gain	0~15	15	
12	Pre_LTIH	0~15	2	
13	Pre_LTIV	0~15	2	
14	Post_LTIH	0~15	2	
15	Post_LTIV	0~15	2	
16	CDataCoring	0~3	2	
17	Sub Color	0~80	60	

13. FBE3

No	Item	Range	Default	Remark
1	Pattern-sel	0	0	
2	B-Slope gain	0~255	60	Black Adjust
3	B-Tilt min	0~511	30	
4	B-Tilt max	0~511	110	
5	Lfunc-basis	0~255	75	
6	Hfunc-basis	0~255	80	
7	Mean-Offset1	0~1023	30	
8	Mean-Offset2	0~1023	235	
9	Mean-Slope	0~511	112	
10	ACR-Offset	0~511	15	
11	ACR-th1	0~255	20	
12	ACR-th2	0~255	110	
13	Skin-Enable	on off	ON	
14	Skin-UV	0~255	128	
15	Sub Color	0~255	128	
16	M-Skin_UV	0~255	128	
17	M-Sub Color	0~255	128	
18	Sub Contrast	0~150	10	
19	Sub Brightness	0~511	250	

14. LNA+

No	Item	Range	Default	Remark
1	Off_NR_Gain	0~31	0	
2	db0_NR_Gain	0~31	4	
3	db1_NR_Gain	0~31	6	
4	db2_NR_Gain	0~31	8	
5	db3_NR_Gain	0~31	10	
6	Off	0~11	0	
7	Low	0~11	1	
8	Medium	0~11	2	
9	Hign	0~11	5	
10	Auto	0~11	0	
11	Still_Check	0,1	1	

Troubleshooting

15. Expert Setting

No	Item	Range	Default	Remark
1	Calibration	ON	ON	
2	P-Mode	Movie, Calibration	Calibration	
3	Color Tone	WARM1, WARM2	WARM1	
4	Backlight	0~10	5	
5	Contrast	0~100	80	
6	Brightness	0~100	45	
7	Color	0~100	50	
8	Tint	0~100	50	
9	Sharpness	0~100	20	

16. Expert D-settings

No	Item	Range	Default	Remark
1	Black adjust	off, Low, Mid, High	Off	
2	Dynamic Contrast	off, Low, Mid, High	Off	
3	Gamma	-3~3	0	
4	Flesh tone	-15~15	0	
5	Edge Enhance	off,On	Off	
6	xvYCC		...	Inactive

17. Expert Gray Scale

No	Item	Range	Default	Remark
1	R-Offset	0~50	25	
2	G-Offset	0~50	25	
3	B-Offset	0~50	25	
4	R-GAIN	0~50	25	
5	G-GAIN	0~50	25	
6	B-GAIN	0~50	25	

18. Expert C-Space

No	Item	Range	Default	Remark
1	Color Space	Wide, Auto, Custom	Wide	
2	Custom_R_red		...	
3	Custom_R_green		...	
4	Custom_R_blue		...	
5	Custom_G_red		...	
6	Custom_G_green		...	
7	Custom_G_blue		...	
8	Custom_B_red		...	
9	Custom_B_green		...	
10	Custom_B_blue		...	
11	Custom_C_red		...	
12	Custom_C_green		...	
13	Custom_C_blue		...	
14	Custom_M_red		...	
15	Custom_M_green		...	
16	Custom_M_blue		...	
17	Custom_Y_red		...	
18	Custom_Y_green		...	
19	Custom_Y_blue		...	

19. Expert Others

No	Item	Range	Default	Remark
1	Size	4:3, 16:9, just scan	Just Scan	
2	H-Position		5	
3	V-Position		5	
4	NR	off, Low, Mid, High, auto	Auto	
5	HDMI Black Level		...	
6	Film Mode	off, on	Off	
7	Auto Motion Plus	off, Low, Mid, High	Off	

Troubleshooting

20. Sound

No	Item	Range	Default	Remark
1	Delay_ATV	0~120	70	
2	Delay_DTV	0~120	60	
3	Spdif_Delay	off, on	Off	
4	AMP Volume	255	41	
5	Limiter_Attact	0~15	9	
6	Limiter_Release	0~16	15	
7	Post_Scale	0~127	94	
8	Carrie Mute	on, off	ON	
9	Hi-Deviation	on, off	OFF	
10	Speaker_EQ	on, off	ON	

21. EDID

No	Item	Range	Default	Remark
1	EDID ON/OFF	Off/On	OFF	Off : Protect EEPROM, ON : unprotect EEPROM
2	ALL EDID	Success/NG	Success	Download ALL EDID
3	PC EDID	Success/NG	Success	Download PC EDID
4	HDMI1 EDID	Success/NG	Success	Download HDMI1 EDID
5	HDMI2 EDID	Success/NG	Success	Download HDMI2 EDID
6	HDMI3 EDID	Success/NG	Success	Download HDMI3 EDID
7	EDID HDMI1 Ver	HDMI 1.3	HDMI 1.3	

22. ESP

No	Item	Range	Default	Remark
1	Dynamic Global OnOff	OFF/ ON	OFF	
2	Dynamic Local OnOff	OFF/ ON	OFF	
3	Dynamic Skin OnOff	OFF/ ON	OFF	
4	Dynamic Strength	Low/Mid/Max	Mid	
5	Dynamic Cont Gain	0~100	0	
6	Dynamic Satu	OFF/ ON	OFF	
7	Dynamic Satu Gain	0~255	128	
8	Sharp Picture	OFF/ ON	ON	
9	VLUT	0~3	TBD0	
10	Sharp Filter	0~3	HD High	
11	Sharp Picture Gain	0~255	75	

23. CHECKSUM

No	Item	Range	Default	Remark
1	MAIN			checksum

24. SERVICE

No	Item	Range	Default	Remark
1	H/V-Position	-	-	Check the check sum.
2	User Control		-	
3	CCA Control		ON	
4	DMD → DIGITAL		-	
5	DIGITAL → DMD		-	
6	LED Life	-	-	
7	LED Clear	-	-	
8	Mute Time[RF]	0~1000ms	600ms	
9	Actu Gain[Patt1]	0~175	40	
10	Actu Gain[Patt2]	0~175	40	
11	Visual TEST			

25. DEFECT LOG

No	Item	Range	Default	Remark
1	Select Log Type	DEFECT/NVRAM	DEFECT	
2	VIEW LOG		-	

26. Font Data Viewer

You can see the font in the set.

4-2-4 Service Adjustment

■ Vertical / Horizontal Position Adjustment

1. Turn off the power to put the unit into the STAND-BY mode.
2. In order to enter the Service Mode, press **MUTE** → **1** → **8** → **2** → **POWER** buttons on the remote control.
3. Select "DDP3021" on the first display of the Service mode menu.
4. Select "H/V-Position" for vertical positioning and Horizontal positioning by using ▲ / ▼ / ◀ / ▶ the buttons.
Press the (Up, Down, Left, Right) buttons to adjust the screen position.

■ **CCA Adjustment Service Methods** : CCA Adjustment is needed after changing a light engine, main board and DMD board

– CCA : In DLP TV, even the same RGB color may differ depending on the light engine. CCA (Color Coordinate Adjustment) corrects the color to achieve the color accuracy. CCA performs color correction after measuring and inputting the current light engine's data on actual color coordinates for displayed Red, Green, Blue, and White color patterns, using a color coordinate measuring equipment. At this moment, color correction is performed below.

- 1) This procedure is needed if the Main board, DMD Board, and light engine are changed.
- 2) Turn off power to put the unit into the STAND-BY mode.
- 3) In order to enter the Service Mode, press **MUTE** → **1** → **8** → **2** → **POWER** buttons on the remote control.

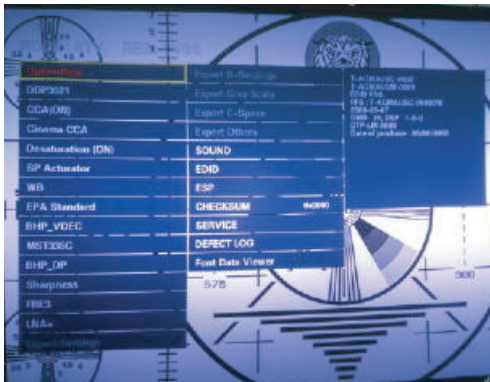

- 4) Select "Option" on the display of the Service mode menu
- 5) If either the DMD or Light Engine is changed. Press the ▼ ▲ (Up or Down) button to move to Digital → DMD, then press ENTER to select.

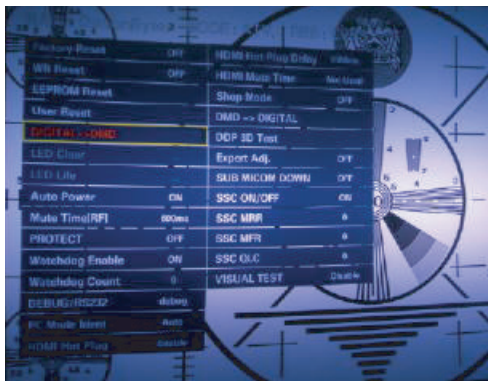

- 6) Then Press ENTER to save CCA information to the DMD board.

Troubleshooting

- 7) If the Main Board is changed, Press the ▼ ▲ (Up or Down) button to move to DMD → Digital, then press ENTER to select.

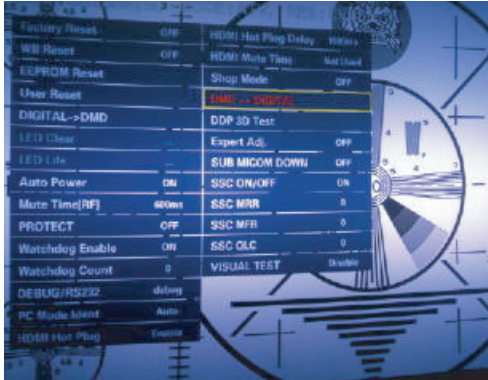

- 8) Then Press ENTER to save CCA information to the Main board

* Attention

Performing CCA is independent on current display's resolution and input signal type if you don't measure color coordinates data. Measuring color coordinates data requires specific equipment not possessed by service personnel, that makes performing manual adjustment impossible. Adjusting CCA is applied to all the signal mode. Don't change desired value because it will be harmful to the color of the SET.

■ ACTUATOR GAIN Adjustment

1. Before Adjustment

- 1) Turn off the power to put the unit into the STAND-BY mode.
- 2) In order to enter the Service Mode, press **MUTE** → **1** → **8** → **2** → **POWER** button on the remote control.
- 3) Select "Service" on the first display of the Service mode menu.
- 4) Press the ▲ ▼ (Up or Down) button to move to ACTUATOR GAIN [Patt 1], ACTUATOR GAIN [Patt 2], then press ENTER to select.
- 5) The Actuator gain setup screen will be displayed.
- 6) Press the ◀ ▶ (Left or Right) button to adjust. check the smooth picture at it's minimum and maximum values of changing, then adjust to the mean value.

- ACTUATOR GAIN [Patt 1], ACTUATOR GAIN [Patt 2]

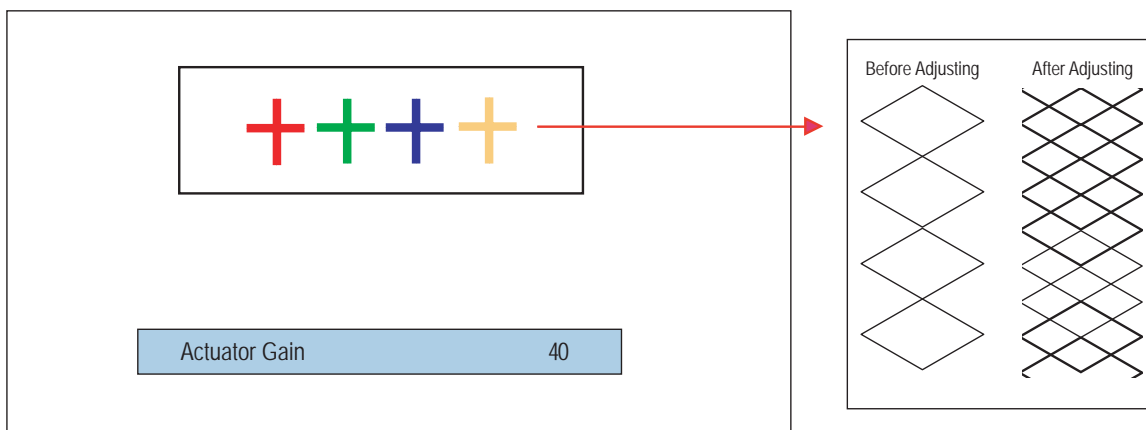

2. Making Adjustments

- 1) As shown in the picture above, change the actuator values to eliminate saw tooth shapes.
 - To fine tune, increase the data value ensuring that you get the center between the starting and ending points of the disappearing saw tooth shape.

4-2-5 Replacements & Calibration

■ Tilt the Screen

1. Remove the 14 point screws. Remove the Bottom cover.
:TH,B,M4.L15,BLK,SWRCH18A

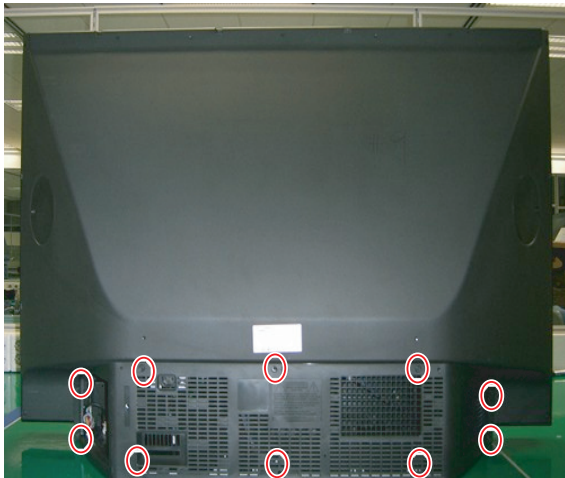

2. Loosen the 3 points screws.

* Left 2 points screws

:PWH,S,M3,L8,ZPC(YEL),SWRCH18A

* Right 1 points screw

: PWH,S,M3,L7,ZPC(YEL),SWRCH18A

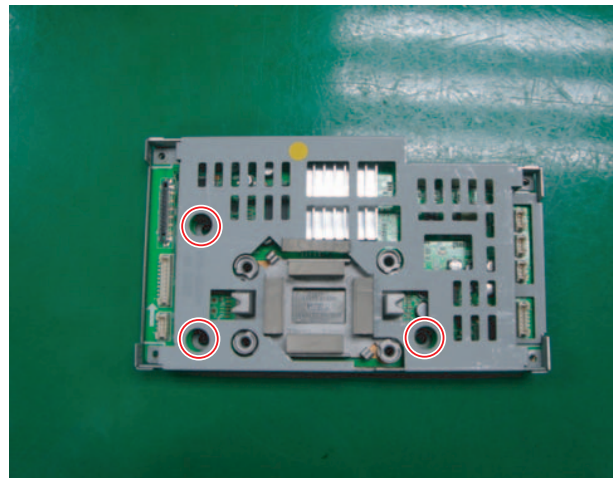

3. Turn off the power to put the unit into the STAND-BY mode. In order to enter the Service Mode, press "Mute" → "1" → "8" → "2" → "POWER" buttons on the Remote Control. Select "DDP3021 (LED)" on the first display of the Service Mode menu. Press the ▲ ▼ (Up or Down) buttons to select the test pattern option, then press ENTER to select. Press the ► (Right) button until you see the CROSSHATCH PATTERN. Then, adjust the screen position, by holding both of the upper corners of the DMD board.

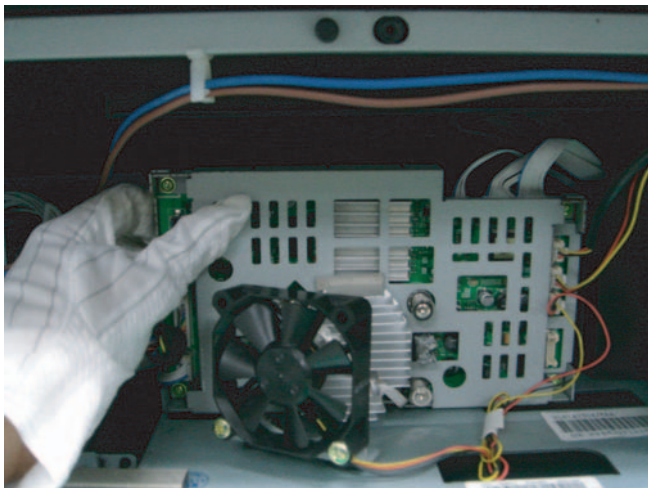

CROSSHATCH PATTERN

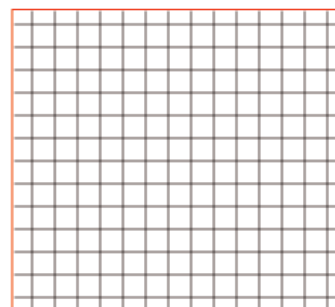

- ※ Even when those screws are loosened, the board does not separate it can be moved within the adjustable range because there are spring screws at the center holding it.
- ※ When adjusting the screen, it is better for two people to work together.
One person should adjust the picture position while the other person looks at the screen.
- ※ The movement direction of the board and the picture are opposite.
 - When the board is lifted upward, the screen descends down.
 - When it is tilted to the left, the screen tilts to the right.
- ※ When the picture adjustment is completed:
First, tighten the two screws on the left of the DMD board and then slowly tighten the one screw on the bottom right.
Be careful not to touch the board while tightening the screws.
(When using an electric-powered screwdriver, be careful that the torque is not too high.)

■ **Align the Focus**

1. Remove the 2 screws.
: TH,B,M4.L15,BLK,SWRCH18A

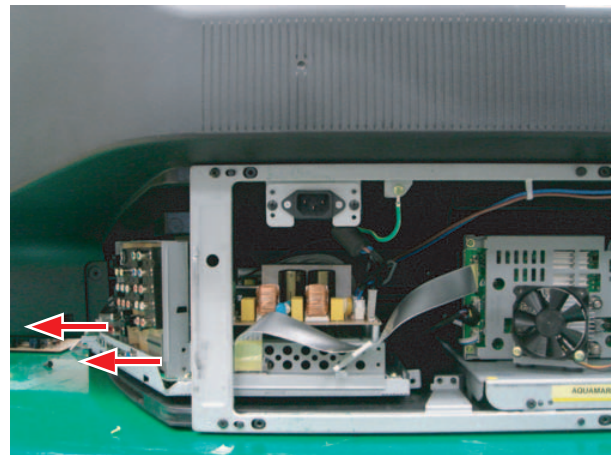
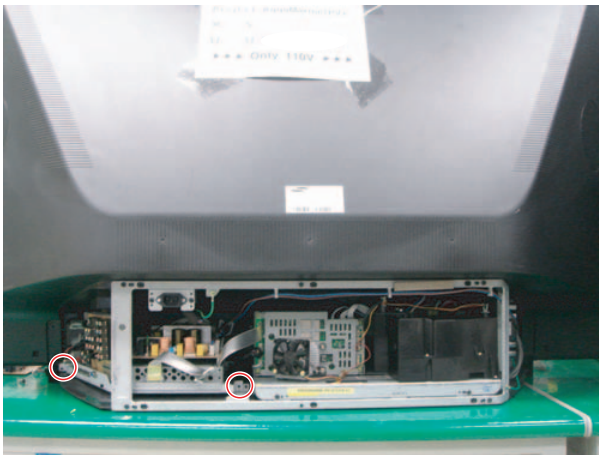

3. Adjust the Lens Focus

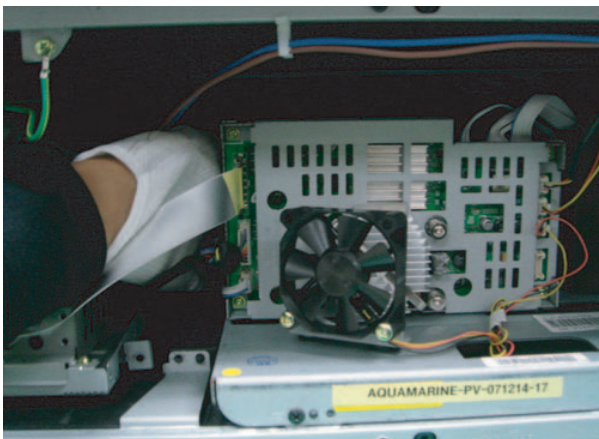

- 1) Input a Crosshatch pattern or enter service mode and use the internal generated patterns.
- 2) Insert your hand/finger into the unit as shown in the figure and adjust the focus alignment dial of the Projection Lens Clockwise or Counter Clockwise (See picture in step 4) until the picture is clear.
- 3) Since the alignment is done from the rear use a mirror or a second person to confirm the adjustment is complete or remove the side port and view the screen through the port on the side for Focus Alignment.

Troubleshooting

4. Adjust the Lens focus.

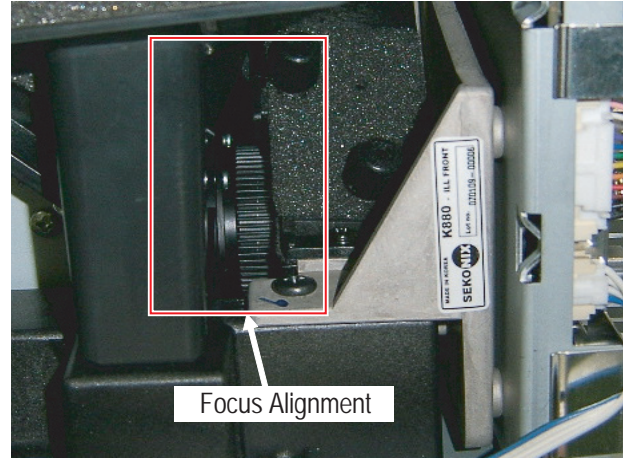
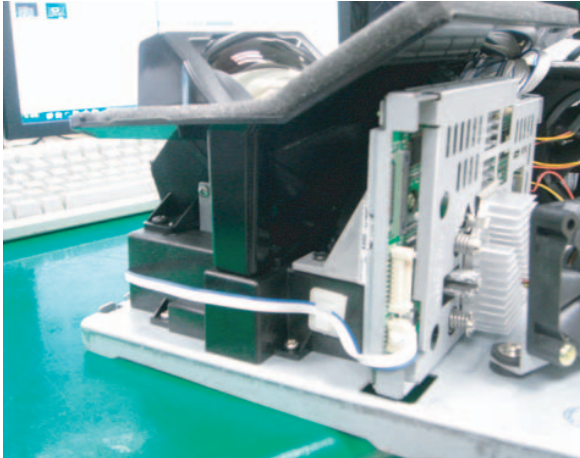

■ The Illumination Adjustment

1. Remove the 14 point screws and the Bottom cover.
:TH,B,M4.L15,BLK,SWRCH18A

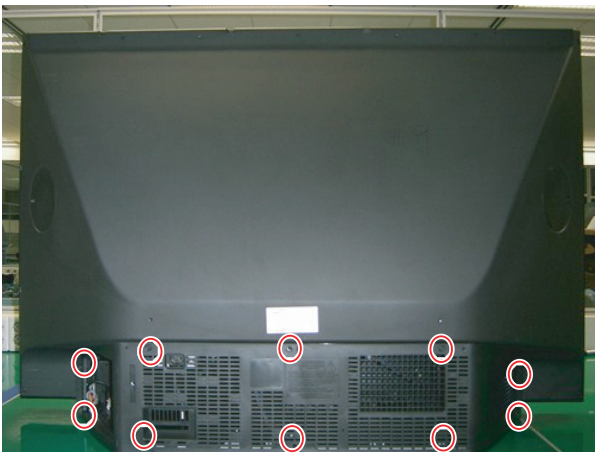

2. Turn off the power to put the unit into the STAND-BY mode. Press "Mute" → "1" → "8" → "2" → "POWER" buttons on the Remote Control. Select "DDP3021" and enter the Test Pattern (DDP) Menu Press the ▲ ▼ (Up or Down) buttons, then press ENTER to select. Press the ► (Right) button until you see the Full White picture.

3. Rotate the 2 points fine adjustment dials.

4. Upper knob is for the vertical illumination adjustment and the lower knob is for the horizontal illumination adjustment.

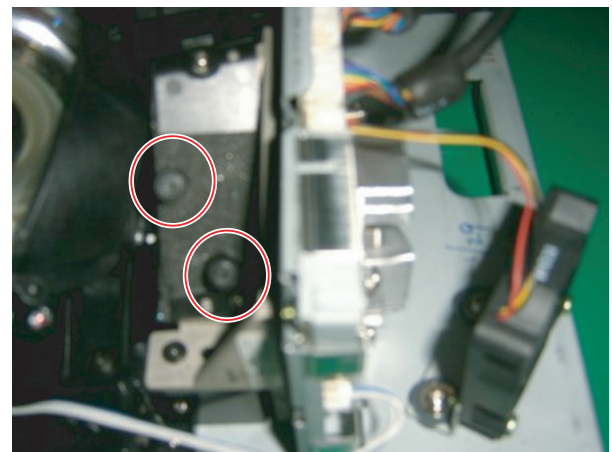
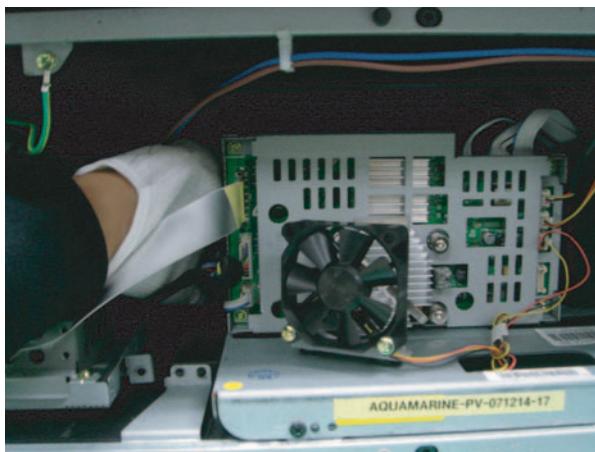

- ※ According to the white pattern of the screen when the those dials are rotated, find the direction of the adjustment dials.
- ※ Until Full White pattern without the brindle is made in the Best Illumination situation, adjust the dials delicately.

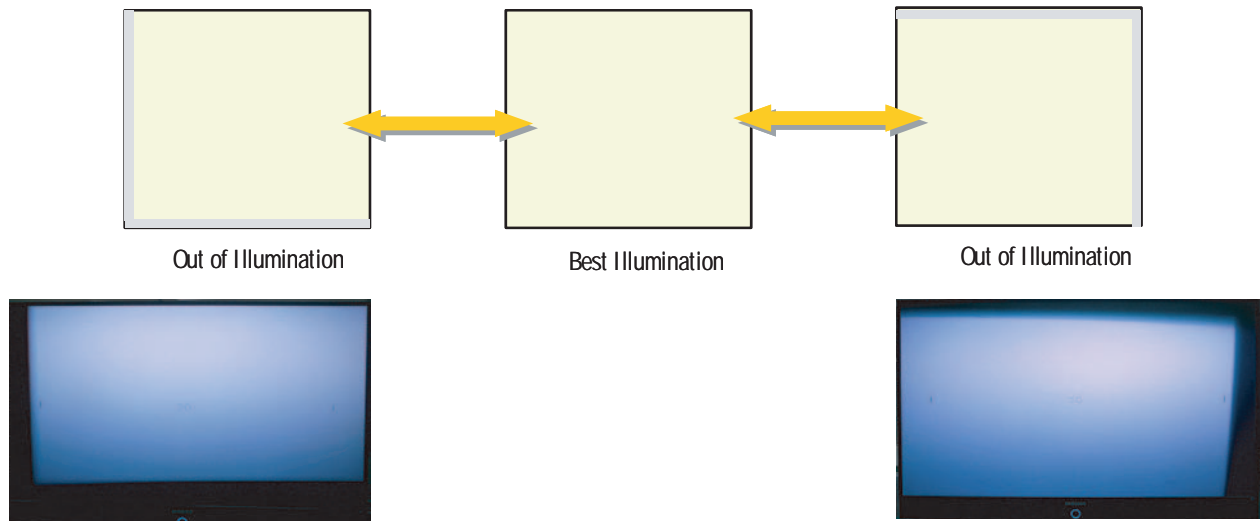

4-3 Upgrade

4-3-1 How to Update Software

1. Insert a USB drive containing the firmware upgrade into the USB Upgrade Port on the side of the TV.

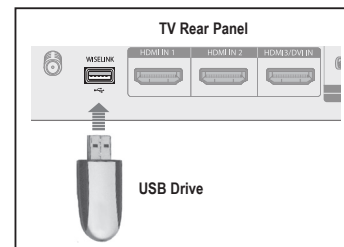

2. Press the MENU button.
Press the ▲ or ▼ button to select Setup, then press the ENTER button.
Press the ▲ or ▼ button to select SW Upgrade, then press the ENTER button.
The message "Scanning for USB may take up to 30 seconds" is displayed.

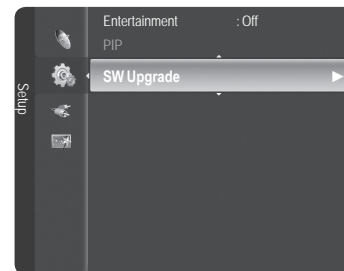

3. If the firmware on the USB is properly recognized, the message.
"Upgrade version xxxx to version xxxx? The system would be reset after upgrade."
is displayed.
Press the ◀ or ▶ button to select OK, then press the ENTER button.
The upgrade starts.
Please be careful to not disconnect the power or remove the USB drive while upgrades
are being applied.
The TV will shut off and turn on automatically after completing the firmware upgrade.
Please check the firmware version after the upgrades are complete.

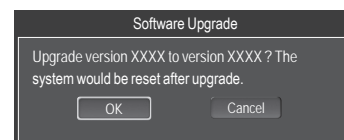
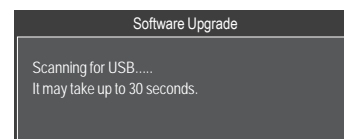

- ※ The firmware and upgrade process may be different by country and region.

T-AQMAUSC-XXXX
T-AQMAUSM-XXXX
EDID SUCCESS
RFS : T-AQMAUSC-YYYYMMDD
YYYY-MM-DD
DMD XX, DSP-X-X-X
DTP-LM-XXXX
Date of Purchase : DD/MM/YYYY

4-3-2 How to Check the Version of the Program

1. Procedures for checking in the Factory Menu.

When entering Factory Mode, the version of the software is displayed at the bottom of the menu as described on page 4-7.

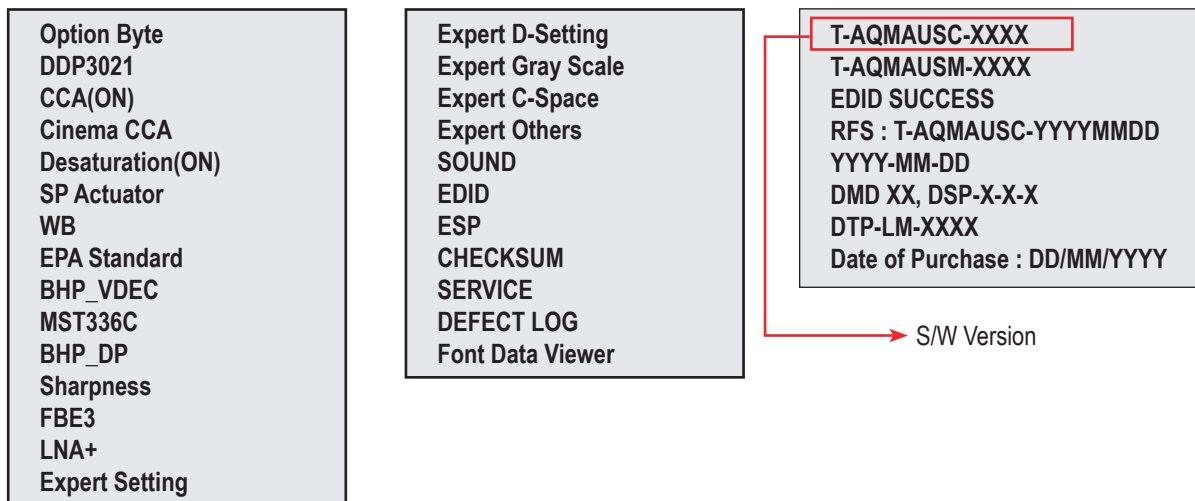

2. Procedures for checking in the User Menu

You can check the S/W Version using the customer menu using the following procedure.

- Push the MENU button on remote control
- Select Setup Menu
- Select SW Upgrade
- Push the INFO button on remote control

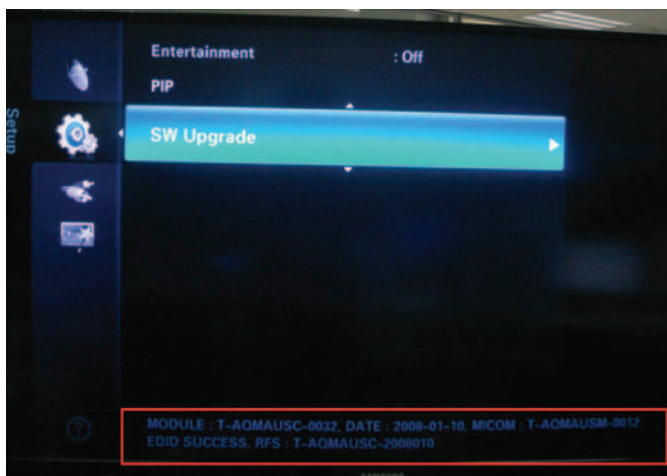

5. Exploded View & Part List

5-1 HL61A750A1FXZA Exploded View

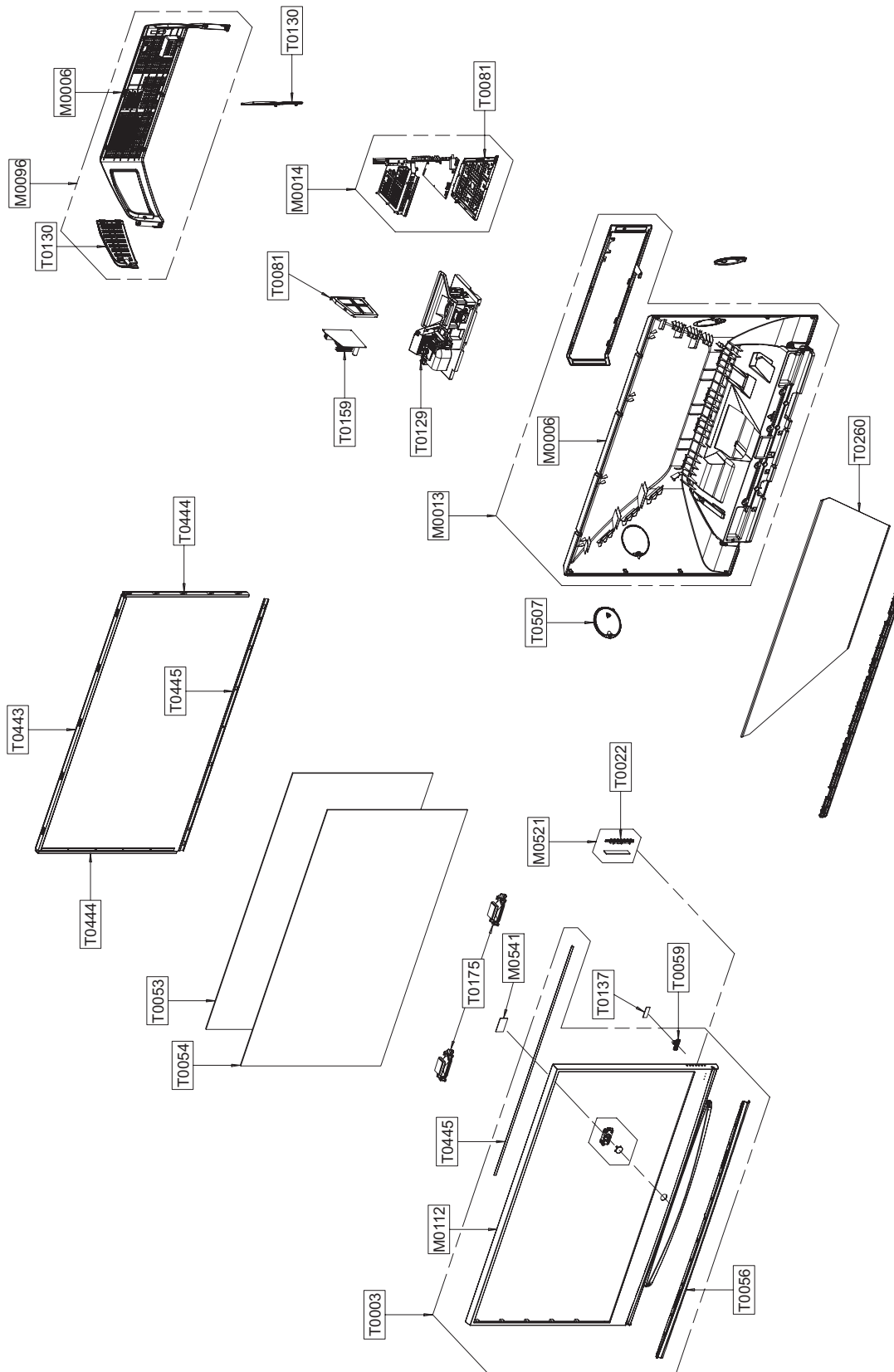

Loc. No.	Code No.	Description	Specification	Q'ty	SA/SNA	Remark
M0006	BP63-00880A	COVER-REAR BOTTOM	56K6(SLIM),PS,V0,BK500	1	S.N.A	
M0006	BP63-00883A	COVER-REAR	61K8(SLIM),PS,V0,BK500,NON-DE	1	S.N.A	
M0013	BP96-02056A	ASSY COVER P-REAR	61K8,PS,V0,BK500,NON-D	1	S.A	
M0014	BP94-02326A	ASSY PCB MAIN	HL61A750A1FXZA,AQUAMARINE	1	S.A	△
M0096	BP96-01743C	ASSY COVER P-REAR BOTTOM	K8(LED),,PS,V0,	1	S.A	
M0112	BP63-01071A	COVER-FRONT	61A750,ABS+PMMA,HB,BK23,STEAM	1	S.N.A	
M0521	BP96-01802A	ASSY PCB P-KEY CONTROL	HLT5075SX/XAA,L64	1	S.A	
M0541	BP96-02052A	ASSY BOARD P-RMC	AquaMarine,CT5000-5750A	1	S.A	
T0003	BP96-02022A	ASSY COVER P-FRONT	D750 61",ABS+PMMA,HB,	1	S.A	
T0022	BP64-00610B	KNOB CONTROL	K6/K8,ABS,HB,ORIGINAL COLOR	1	S.N.A	
T0053	BP67-00361A	SCREEN FRESNEL	CITRINE,1.9T,61W, 1372mm	1	S.A	
T0054	BP67-00344A	SCREEN LENTI	Laurel,1.7T,61W, 1372mm x 7	1	S.A	
T0056	BP63-01092A	COVER-DECORATION	61A750,HIPS HB,DGM-1713	1	S.N.A	
T0059	BP64-00625A	INDICATOR LED	56K6(SLIM),PC,CLEAR	1	S.N.A	
T0081	BP61-01408A	BRACKET-POWER	56K8(SLIM LED),SECC,T0.8,N	1	S.N.A	
T0081	BP61-01601A	BRACKET-MAIN	750 series,SECC,T0.5,NTR	1	S.N.A	
T0129	BP91-02113A	ASSY ENGINE	A750(61,67 INCH),GEN 2.3 LED	1	S.N.A	△
T0130	BP63-00968A	COVER DUCT	56K8(SLIM LED),ABS,-,-,V0(N	1	S.N.A	
T0130	BP96-02023A	ASSY COVER P-TERMINAL BOARD	D650/750,PS	1	S.A	
T0137	BP96-01861A	ASSY PCB P-LED	K6,-,-,(BP94-02304C),-	1	S.A	
T0159	BP96-01726B	ASSY PCB P-SMPS	Aquamarin,LED DLP TV,DC2	1	S.A	
T0175	BP96-01794A	ASSY SPEAKER P	8ohm,Horn type,10W,1100/4	1	S.A	
T0260	BP67-00321A	MIRROR-FRONT	61K6,Glass,1274×644×717×	1	S.A	
T0443	BP96-01755A	ASSY BRACKET P-SCREEN TOP	-,61K8,-,AL606	1	S.N.A	
T0444	BP96-01753A	ASSY BRACKET P-SCREEN SIDE	-,61K8(LEFT),	1	S.N.A	
T0444	BP96-01754A	ASSY BRACKET P-SCREEN SIDE	-,61K8(RIGHT)	1	S.N.A	
T0445	BP96-01819A	ASSY BRACKET P-SCREEN BOTTOM	-,61K8,TOP,	1	S.N.A	
T0445	BP96-01752A	ASSY BRACKET P-SCREEN BOTTOM	-,61K8,-,AL	1	S.N.A	
T0507	BP63-00832A	COVER-DUST	46K5(SLIM),PS,HB,BK500	2	S.N.A	

5-2 HL67A750A1FXZA Exploded View

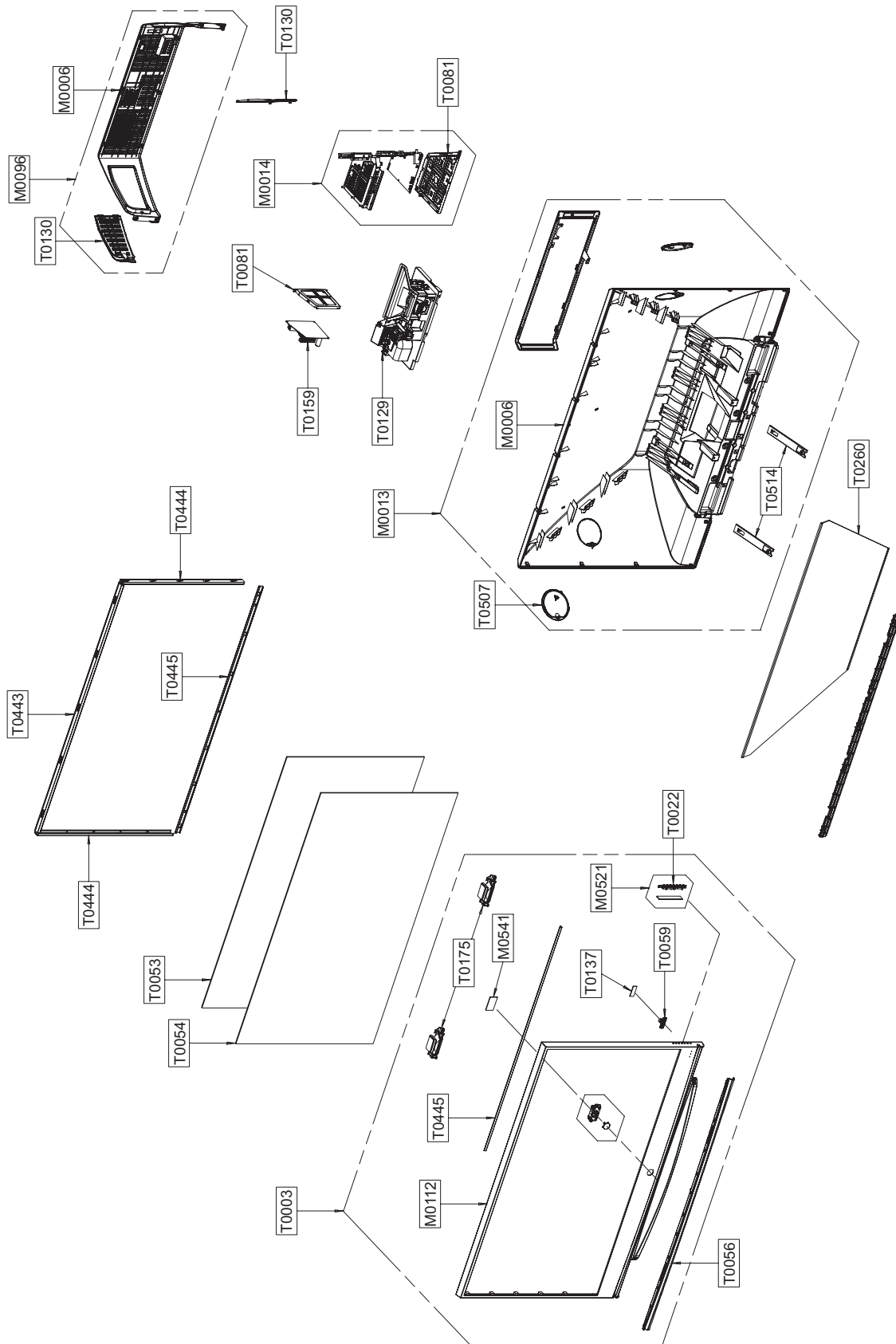

Loc. No.	Code No.	Description	Specification	Q'ty	SA/SNA	Remark
M0006	BP63-00880A	COVER-REAR BOTTOM	56K6(SLIM),PS,V0,BK500	1	S.N.A	
M0006	BP63-01074A	COVER-REAR	67A750,PS,V0,BK500,NON-DECA	1	S.N.A	
M0013	BP96-02025A	ASSY COVER P-REAR	D750 67"	1	S.A	
M0014	BP94-02326A	ASSY PCB MAIN	HL61A750A1FXZA,AQUAMARINE	1	S.A	△
M0096	BP96-01743C	ASSY COVER P-REAR BOTTOM	K8(LED),,PS,V0,	1	S.A	
M0112	BP63-01072A	COVER-FRONT	67A750,ABS+PMMA,HB,BK23,STEAL	1	S.N.A	
M0521	BP96-01802A	ASSY PCB P-KEY CONTROL	HLT5075SX/XAA,L64	1	S.A	
M0541	BP96-02052A	ASSY BOARD P-RMC	AquaMarine,CT5000-5750A	1	S.A	
T0003	BP96-02024A	ASSY COVER P-FRONT	D750 67",ABS+PMMA,HB,	1	S.A	
T0022	BP64-00610B	KNOB CONTROL	K6/K8,ABS,HB,ORIGINAL COLOR	1	S.N.A	
T0053	BP67-00352A	SCREEN FRESNEL	K3, 67inch, DNP,MS,offset	1	S.A	
T0054	BP67-00355A	SCREEN LENTI	aquamarine, 67inch, DNP,MS,	1	S.A	
T0056	BP63-01093A	COVER-DECORATION	67A750,HIPS HB,DGM-1713	1	S.N.A	
T0059	BP64-00625A	INDICATOR LED	56K6(SLIM),PC,CLEAR	1	S.N.A	
T0081	BP61-01408A	BRACKET-POWER	56K8(SLIM LED),SECC,T0.8,N	1	S.N.A	
T0081	BP61-01601A	BRACKET-MAIN	750 series,SECC,T0.5,NTR	1	S.N.A	
T0129	BP91-02113B	ASSY ENGINE	A750(67 INCH),GEN 2.3 LED	1	S.N.A	△
T0130	BP63-00968A	COVER DUCT	56K8(SLIM LED),ABS,-,-,-,V0(N	1	S.N.A	
T0130	BP96-02023A	ASSY COVER P-TERMINAL BOARD	D650/750,PS	1	S.A	
T0137	BP96-01861A	ASSY PCB P-LED	K6,-,-,-(BP94-02304C),-	1	S.A	
T0159	BP96-01726B	ASSY PCB P-SMPS	Aquamarin,LED DLP TV,DC2	1	S.A	
T0175	BP96-01794A	ASSY SPEAKER P	8ohm,Horn type,10W,1100/4	1	S.A	
T0260	BP67-00353A	MIRROR-FRONT	67K8,Glass,1407.84×719×79	1	S.A	
T0267	BP61-01628A	BRACKET-MIRROR TOP	67A750,AL 6063 EXTR	1	S.N.A	
T0443	BP96-02030A	ASSY BRACKET P-SCREEN TOP	D750 67",AL606	1	S.N.A	
T0444	BP96-02026A	ASSY BRACKET P-SCREEN SIDE	D750 67"(RIGH	1	S.N.A	
T0444	BP96-02031A	ASSY BRACKET P-SCREEN SIDE	D750 67"(LEFT	1	S.N.A	
T0445	BP96-02027A	ASSY BRACKET P-SCREEN BOTTOM	D750 67"(BO	1	S.N.A	
T0445	BP96-02029A	ASSY BRACKET P-SCREEN BOTTOM	D750 67"(TO	1	S.N.A	
T0507	BP63-00832A	COVER-DUST	46K5(SLIM),PS,HB,BK500	2	S.N.A	
T0514	BP61-01631A	BRACKET-SUPPORT	67A750,SECC,T1.2,NTR,BAC	2	S.N.A	

5-3 HL61A750A1FXZA Service Item

※ This is the list which is available to repair the real material at the time of service.

Loc. No.	Code No.	Description	Specification	Q'ty	SA/SNA	Remark
M0013	BP96-02056A	ASSY COVER P-REAR	61K8,PS,V0,BK500,NON-D	1	S.A	
M0014	BP94-02326A	ASSY PCB MAIN	HL61A750A1FXZA,AQUAMARINE	1	S.A	△
M0096	BP96-01743C	ASSY COVER P-REAR BOTTOM	K8(LED),,PS,V0,	1	S.A	
M2893	BN39-00640C	LEAD CONNECTOR	HLS5686W,UL1007#26,UL/CSA	1	S.A	
M2893	BP39-00174J	LEAD CONNECTOR	HL56A650C,UL1007#22,UL/CS	1	S.A	
M2893	BP39-00180D	LEAD CONNECTOR	HLS4676SX/XAA,UL1015#18,U	1	S.A	
M2893	BP39-00247A	LEAD CONNECTOR	LAUREL.,UL1617#22,UL/CSA,	1	S.A	
M2893	BP39-00254B	LEAD CONNECTOR	HLT5687SX/XAA,UL2835#28,U	1	S.A	
M2893	BP39-00255A	LEAD CONNECTOR	HLT5687SX/XAA,UL1061#28,U	1	S.A	
M2893	BP39-00265B	LEAD CONNECTOR	Laurel,UL1015 #14,UL/CSA,	1	S.A	
M2893	BP39-00265B	LEAD CONNECTOR	Laurel,UL1015 #14,UL/CSA,	1	S.A	
M2893	BP39-00266B	LEAD CONNECTOR	Laurel,UL1015 #14,UL/CSA,	1	S.A	
M2893	BP39-00266B	LEAD CONNECTOR	Laurel,UL1015 #14,UL/CSA,	1	S.A	
M2893	BP39-00267B	LEAD CONNECTOR	Laurel,UL1015 #14,UL/CSA,	1	S.A	
M2893	BP39-00267B	LEAD CONNECTOR	Laurel,UL1015 #14,UL/CSA,	1	S.A	
M2893	BP39-00268B	LEAD CONNECTOR	aquamarine,UL1061#28,UL/C	1	S.A	
M2893	BP39-00268B	LEAD CONNECTOR	aquamarine,UL1061#28,UL/C	1	S.A	
M2893	BP39-00274B	LEAD CONNECTOR	LOTUS,UL2464#26,UL2464 #2	1	S.A	
M2893	BP39-00297A	LEAD CONNECTOR	HLT5689SX/XAA,UL1617#22,U	1	S.A	
M2893	BP39-00297A	LEAD CONNECTOR	HLT5689SX/XAA,UL1617#22,U	1	S.A	
M2893	BP39-00298A	LEAD CONNECTOR	HLT5689SX/XAA,UL1061#28,5	1	S.A	
M2893	BP39-00299A	LEAD CONNECTOR	HLT5689SX/XAA,UL1617#22,U	1	S.A	
T0003	BP96-02022A	ASSY COVER P-FRONT	D750 61",ABS+PMMA,HB,	1	S.A	
T0053	BP67-00361A	SCREEN FRESNEL	CITRINE,1.9T,61W, 1372mm	1	S.A	
T0054	BP67-00344A	SCREEN LENTI	Laurel,1.7T,61W, 1372mm x 7	1	S.A	
T0074	BN59-00673A	REMOCON	PEARL,TM96A,49,USA,SAMSUNG,TOOLS	1	S.A	
T0159	BP96-01726B	ASSY PCB P-SMPS	Aquamarin,LED DLP TV,DC2	1	S.A	
T0175	BP96-01794A	ASSY SPEAKER P	8ohm,Horn type,10W,1100/4	1	S.A	
T0764	BP44-01001A	SMPS-DLP TV	PN082DPS-VF(A),AC/DC,90V-132	1	S.A	

5-4 HL67A750A1FXZA Service Item

※ This is the list which is available to repair the real material at the time of service.

Loc. No.	Code No.	Description	Specification	Q'ty	SA/SNA	Remark
M0013	BP96-02025A	ASSY COVER P-REAR	D750 67"	1	S.A	
M0014	BP94-02326A	ASSY PCB MAIN	HL61A750A1FXZA,AQUAMARINE	1	S.A	
M0096	BP96-01743C	ASSY COVER P-REAR BOTTOM	K8(LED),,PS,V0,	1	S.A	△
M2893	BP39-00174J	LEAD CONNECTOR	HL56A650C,UL1007#22,UL/CS	1	S.A	
M2893	BP39-00180D	LEAD CONNECTOR	HLS4676SX/XAA,UL1015#18,U	1	S.A	
M2893	BP39-00247A	LEAD CONNECTOR	LAUREL,,UL1617#22,UL/CSA,	1	S.A	
M2893	BP39-00254B	LEAD CONNECTOR	HLT5687SX/XAA,UL2835#28,U	1	S.A	
M2893	BP39-00255A	LEAD CONNECTOR	HLT5687SX/XAA,UL1061#28,U	1	S.A	
M2893	BP39-00265B	LEAD CONNECTOR	Laurel,UL1015 #14,UL/CSA,	1	S.A	
M2893	BP39-00265B	LEAD CONNECTOR	Laurel,UL1015 #14,UL/CSA,	1	S.A	
M2893	BP39-00266B	LEAD CONNECTOR	Laurel,UL1015 #14,UL/CSA,	1	S.A	
M2893	BP39-00266B	LEAD CONNECTOR	Laurel,UL1015 #14,UL/CSA,	1	S.A	
M2893	BP39-00267B	LEAD CONNECTOR	Laurel,UL1015 #14,UL/CSA,	1	S.A	
M2893	BP39-00267B	LEAD CONNECTOR	Laurel,UL1015 #14,UL/CSA,	1	S.A	
M2893	BP39-00268B	LEAD CONNECTOR	aquamarine,UL1061#28,UL/C	1	S.A	
M2893	BP39-00268B	LEAD CONNECTOR	aquamarine,UL1061#28,UL/C	1	S.A	
M2893	BP39-00274B	LEAD CONNECTOR	LOTUS,UL2464#26,UL2464 #2	1	S.A	
M2893	BP39-00297A	LEAD CONNECTOR	HLT5689SX/XAA,UL1617#22,U	1	S.A	
M2893	BP39-00297A	LEAD CONNECTOR	HLT5689SX/XAA,UL1617#22,U	1	S.A	
M2893	BP39-00298A	LEAD CONNECTOR	HLT5689SX/XAA,UL1061#28,5	1	S.A	
M2893	BP39-00299A	LEAD CONNECTOR	HLT5689SX/XAA,UL1617#22,U	1	S.A	
T0003	BP96-02024A	ASSY COVER P-FRONT	D750 67",ABS+PMMA,HB,	1	S.A	
T0053	BP67-00352A	SCREEN FRESNEL	K3, 67inch, DNP,MS,offset	1	S.A	
T0054	BP67-00355A	SCREEN LENTI	aquamarine, 67inch, DNP,MS,	1	S.A	
T0159	BP96-01726B	ASSY PCB P-SMPS	Aquamarin,LED DLP TV,DC2	1	S.A	
T0175	BP96-01794A	ASSY SPEAKER P	8ohm,Horn type,10W,1100/4	1	S.A	
T0764	BP44-01001A	SMPS-DLP TV	PN082DPS-VF(A),AC/DC,90V-132	1	S.A	

justmanuals.com

MEMO

6. Wiring Diagram

6-1 Overall Wiring

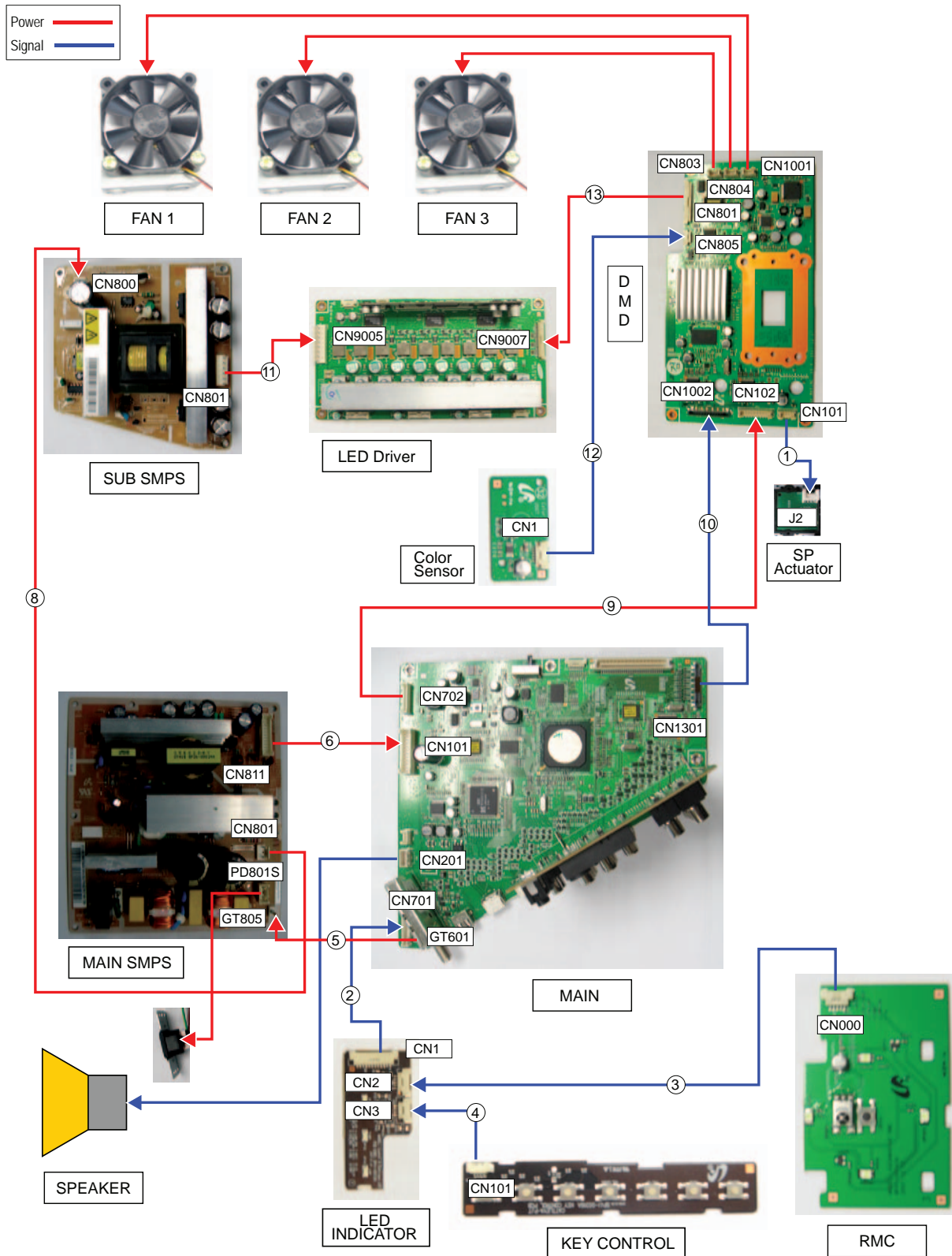

Wiring Diagram

※ The code number of cable (Lead-connector) can be changed, see "5. Exploded View & Part List."

Use	① Actuator_SP	② MISC-LED 12P/13P	③ RMC 5P
Code	BN39-00640C	BP39-00254A	BP39-00257A
Photo			
Use	④ Key Control 4p	⑤ Ground discharge cable 1p	⑥ Power 24p
Code	BP39-00255A	BP39-00180D	BP39-00174J
Photo			
Use	⑦ Inlet	⑧ Ballast cable	⑨ Main to DMD cable
Code	BP96-02046A	BP39-00247A	BP39-00274B
Photo			
Use	⑩ LVDS(350mm)	⑪ Sub Power	⑫ 22P 300mm Cable
Code	BP96-01970C	BP39-00297A	BP39-00299A
Photo			
Use	⑬ LVDS(350mm)		
Code	BP96-01970C		
Photo			

6-1-1 Pin Connection

① DMD(CN101) ↔ SP Actuator	
PIN No.	Signal
1	GND
2	P12V
3	GND
4	P_ACTOUT

② Main(CN701) ↔ LED INDICATOR(CN1)	
PIN No.	Signal
1	BLEU_LED
2	POWER_SW
3	GND
4	LAMP_GRN
5	TIMER_GRN
6	STB_RED
7	KEY1
8	KEY2
9	GND
10	IR
11	STB_5V
12	GND

④ LED INDICATOR(CN2) ↔ KEY CONTROL(CN101)	
PIN No.	Signal
1	GND
2	12V
3	GND
4	P_ACTOUT

⑤ SMPS(GT805) ↔ MAIN(GT601)	
PIN No.	Signal
1	GND

⑥ SMPS(GT805) ↔ MAIN(GT601)	
PIN No.	Signal
1	STB5V
2	N.C
3	GND
4	16VB
5	STB5V
6	GND
7	GND
8	16VB
9	POWER_SW
10	GND
11	5.7VB
12	5.7VB
13	GND
14	GND
15	12VB
16	12VB
17	GND
18	GND
19	12VB
20	12VB
21	GND
22	GND
23	GND
24	12VB

Wiring Diagram

⑦ MAIN SMPS(PD801S) ↔ Inlet	
PIN No.	Signal
1	Live
2	Neutral

⑧ SMPS(CN801) ↔ SUB SMPS(CN800)	
PIN No.	Signal
1	+
2	-

⑨ MAIN(CN702) ↔ DMD(CN102)	
PIN No.	Signal
1	GND
2	D12V
3	D12V
4	GND
5	FAN1_ERR
6	FAN2_ERR
7	FAN3_ERR
8	GND
9	GND
10	GND

⑩ MAIN(CN1301) ↔ DMD(CN1002)			
PIN No.	Signal	PIN No.	Signal
1	GND	22	LVDS_E_TX0-
2	3D_SIGNAL	23	LVDS_E_TX0+
3	GND	24	LVDS_E_TX1-
4	LAMP_ERROR	25	LVDS_E_TX1+
5	GND	26	LVDS_E_TX2-
6	GND	27	LVDS_E_TX2+
7	GND	28	LVDS_E_TXCLK-
8	LVDS_O_TX0-	29	LVDS_E_TXCLK+
9	LVDS_O_TX0+	30	LVDS_E_TX3-
10	LVDS_O_TX1-	31	LVDS_E_TX3+
11	LVDS_O_TX1+	32	LVDS_E_TX4-
12	LVDS_O_TX2-	33	LVDS_E_TX4+
13	LVDS_O_TX2+	34	GND
14	LVDS_O_TXCLK-	35	SCL_DMD
15	LVDS_O_TXCLK+	36	SDA_DMD
16	LVDS_O_TX3-	37	GND
17	LVDS_O_TX3+	38	DDP_READY
18	LVDS_O_TX4-	39	PWR_GOOD
19	LVDS_O_TX4+	40	nLVDS_EN
20	GND	41	GND
21	GND		

⑪ SUB SMPS(CN801) ↔ LED DRIVER(CN9005)	
PIN No.	Signal
1	GND
2	16V
3	GND
4	16V
5	GND
6	16V
7	GND
8	N.C.

⑫ DMD(CN805) ↔ Color Sensor(CN1)	
PIN No.	Signal
1	8V
2	GND
3	Sensor_RST
4	RGB_SENSE
5	GND

⑬ DMD(CN805) ↔ LED DRIVER(CN9007)	
PIN No.	Signal
1	GND
2	LED_SENS
3	LED_B
4	LED_G
5	LED_R
6	GND
7	LED_SUBFRAME
8	LED_LAMPLITZ
9	LED_EN
10	GND
11	LED_DRV_DOUT
12	LED_DRV_DIR
13	LED_DRV_DIN
14	GND
15	LED_DRV_OE
16	LED_DRV_SCLK
17	GND
18	12V
19	GND
20	GND
21	5V
22	5V

6-1-2 Connector role

No.	Cable Name	Description
1	Actuator_SP	This sends a 60Hz signal to the signal to the actuator module.
2	MISC-LED 12P/13P	Connection with Function Boards. (IR Board, LED indicator Board, and Side Key Board.)
3	RMC 5P	Transfer IR Signal
4	Key Control	Transfer Key Function Signal
5	Ground Discharge Cable 1P	Anti-lightning wire connected to the digital board. The anti-lightning wire should be installed for safety
6	Power 24P	Transfers Power sources from Power Board.
7	Inlet	Supply Power to Main SMPS
8	Ballast Cable	Supply Power to Sub SMPS
9	Main to DMD Cable	Supply Power to DMD and transfer Fan Error.
10	LVDS Cable	This transfers the image data to DMD Board.
11	Sub Power	Supply Power to LED Driver
12	22P 300mm	Transfers I2C signal and LED Control Signal to LED Driver. And transfers Power.
13	5P 200mm	Transfers Power and signal to Color Sensor.

7. Schematic Diagram

7-1 Circuit Description

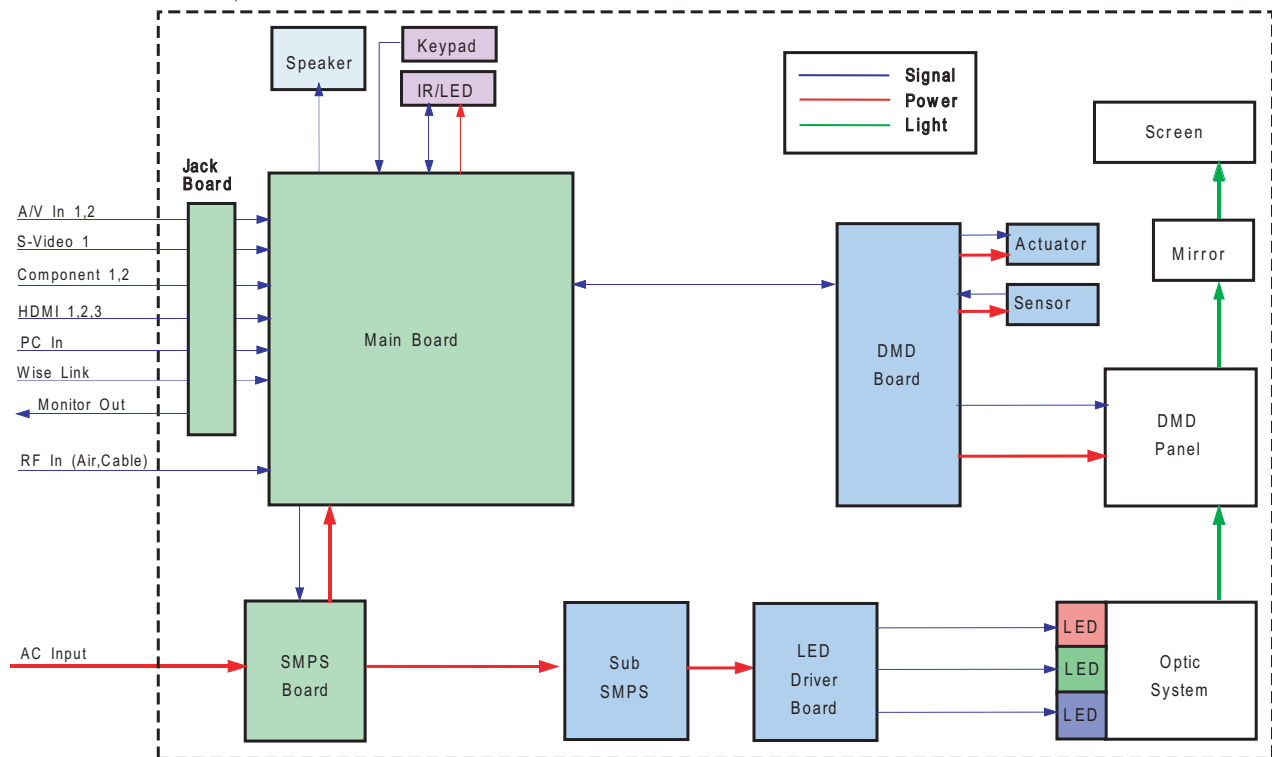

The DLP TV is largely divided into: Power part, Engine part and Main parts.

The ass'y that consists of the DMD board, Detect (Actuator) board, LED light source, LED driver board illumination part, Color sensor and optical devices is called the Engine.

The main board parts receive the AV signals to output voice signals and process the remote control signals.

The engine part displays the video data on the screen, which is generated in the main board.

The AV signals are input through the main and rear boards which processes the CPU functions, MPEG and I2S.

Finally, the improved DNle image is sent to the DMD engine board.

The final data by LED light source is processed in DDP3021 of the DMD board to display the image on the DMD panel.

This image is created by the light of the LED light source through the illumination part and Optical Module which is enlarged and projected onto the screen.

This is the DLP of the K8 type that the actuator operates additionally during this process.

The power terminal generates the DC power needed for the product and sends it to the main board. The main board supplies the power to the digital and DMD boards.

In the meantime, the power source board supplies DC220V - 400V directly to the Sub SMPS board. And then Sub SMPS board supplies 12V and 16V to the LED Driver board.

The LED Driver board is like a stabilizer for lighting the LED light source.

The ultimate purpose of the TV set is to project an image onto the screen and output the voice signals synchronized with the image.

7-2 K880 Engine

Engine	
Image	
Description	<ul style="list-style-type: none"> ▶ Actuator: used to get the smooth picture as shaking Mirror in the 60Hz. ▶ LED Driver : Controls LED Turn and Color-sensor & drivers DMD Panel. ▶ LED : KEY COMPONENTS which are used to make R,G,B Colors. ▶ Illumination Part : KEY COMPONENT which consists of Lens, Reflection-mirrors, and Light Tunnel. It is used to mix colors from the LEDs, which is then displayed on the screen. ▶ Fan : put heat, generated from LEDs and DMD Board, out of SET. ▶ Color Sensor : checks the color passing in the illuminance part, then feedback the color status to the LED Driver. ▶ DMD Board : makes a screen data, received from Main board, as a real screen in the DMD panel.

7-3 Schematic Diagram

7-3-1 Main Board-1

This Document can not be used without Samsung's authorization.



STB5V GND
 GND A16V
 STB5V GND
 GND A16V
 SW_POWER GND
 B5.7V B5.7V
 GND GND
 B12V B12V
 GND GND
 B12V B12V
 GND GND
 GND B12V

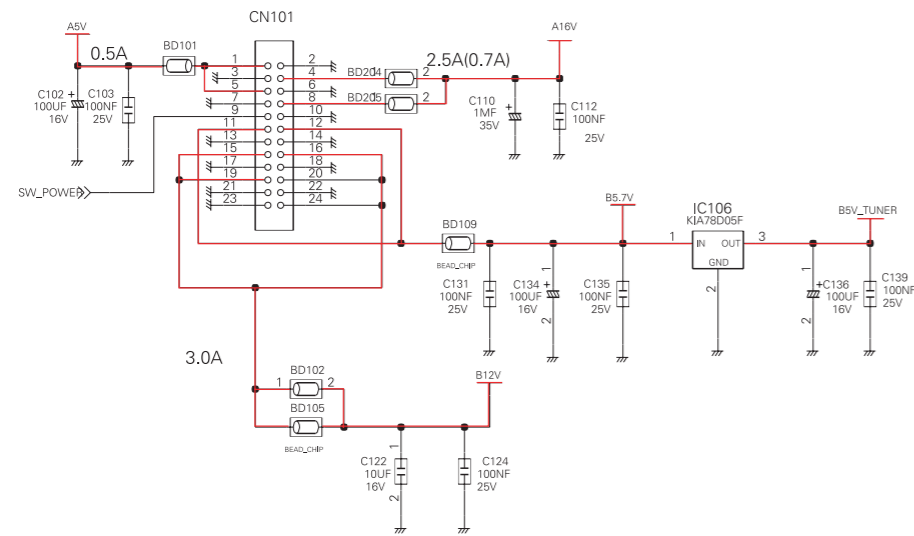

STANDBY POWER

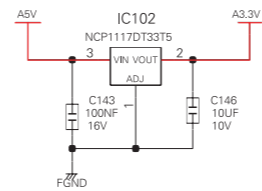

B6.5V

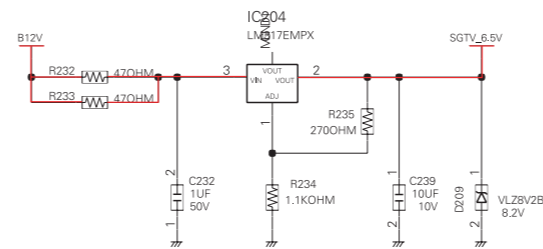

B5V

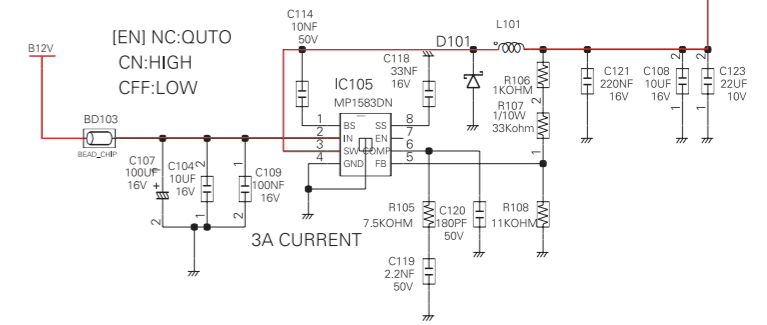

B3.3V

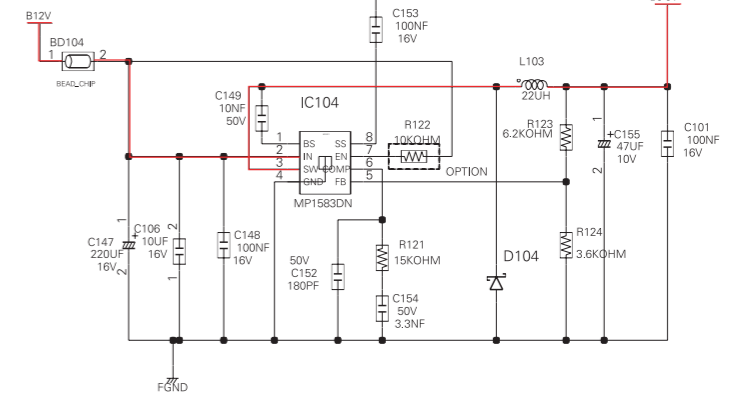

BAYHILL 1.2V

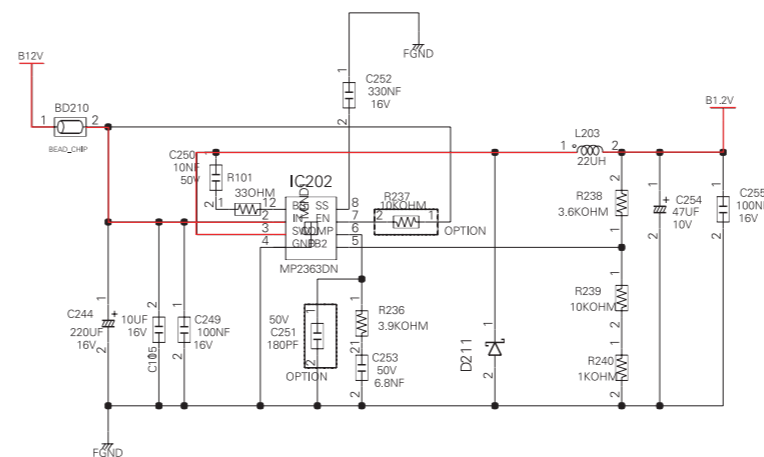

7-3-2 Main Board-2

This Document can not be used without Samsung's authorization.

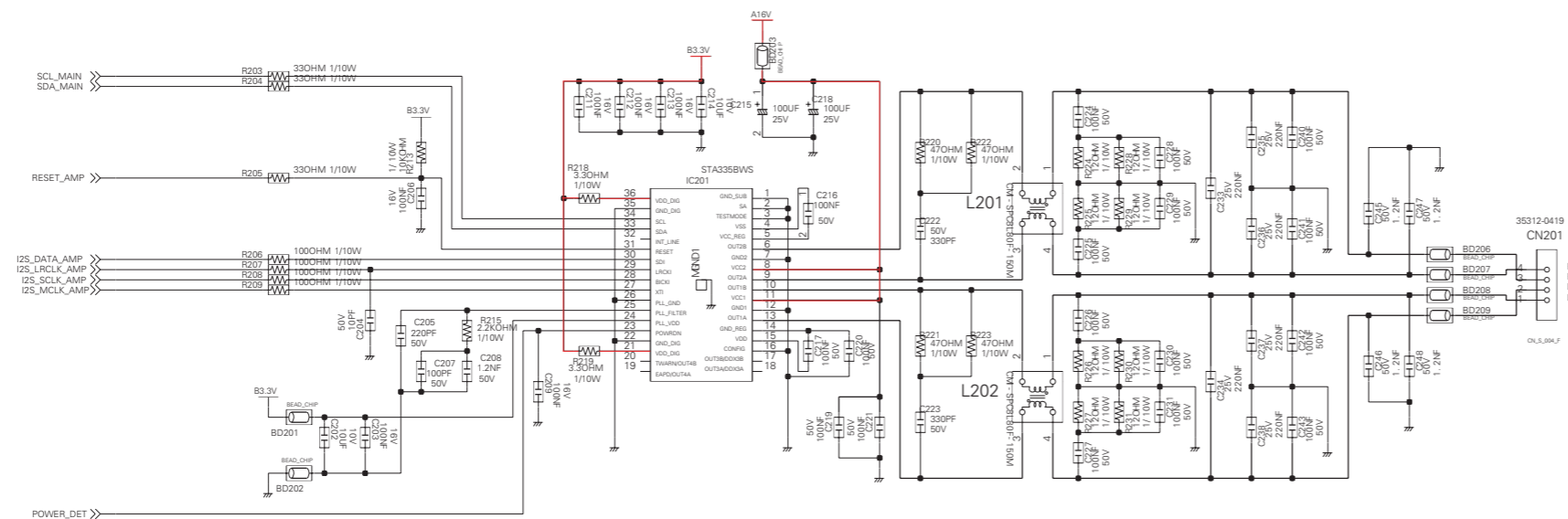
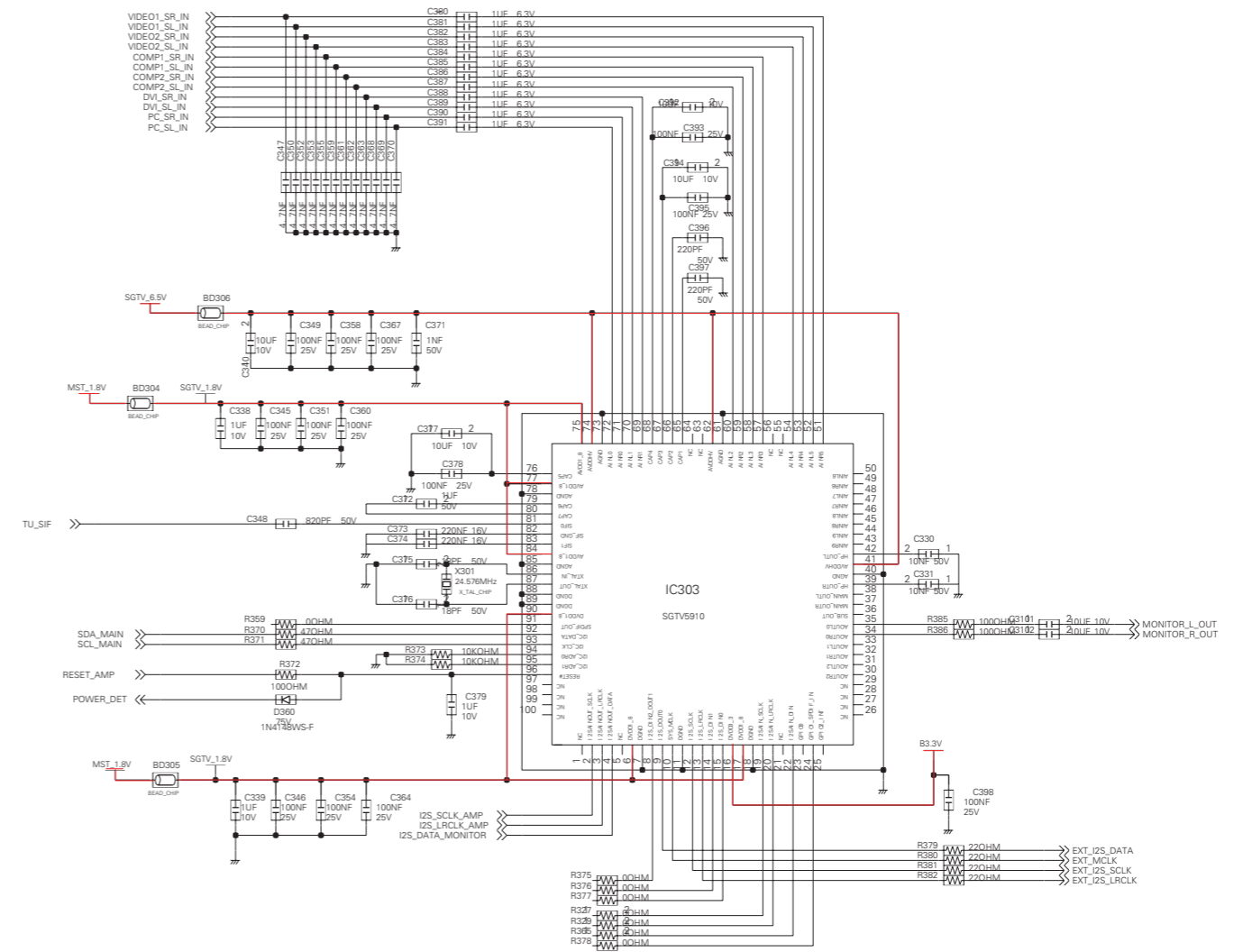
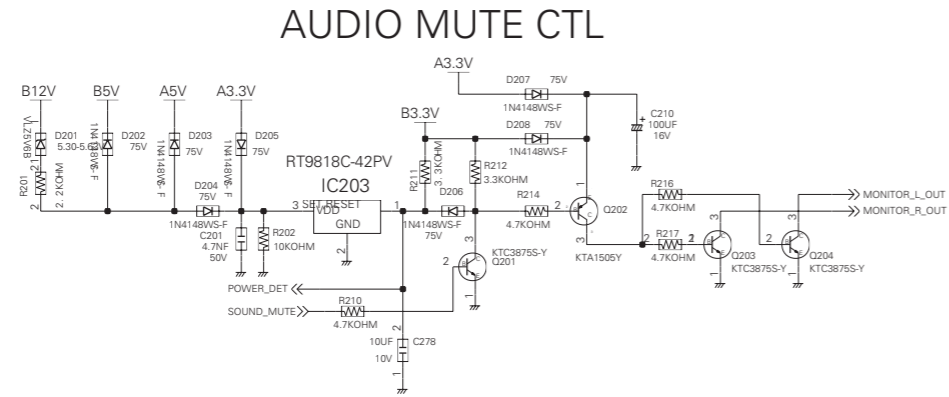

7-3-3 Main Board-3

This Document can not be used without Samsung's authorization.



FROM TERMINAL BLOCK

USB2.0

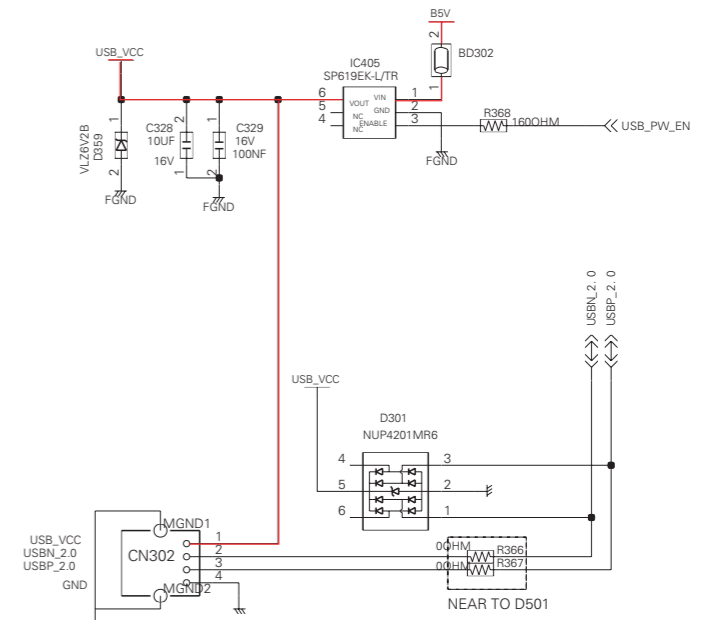
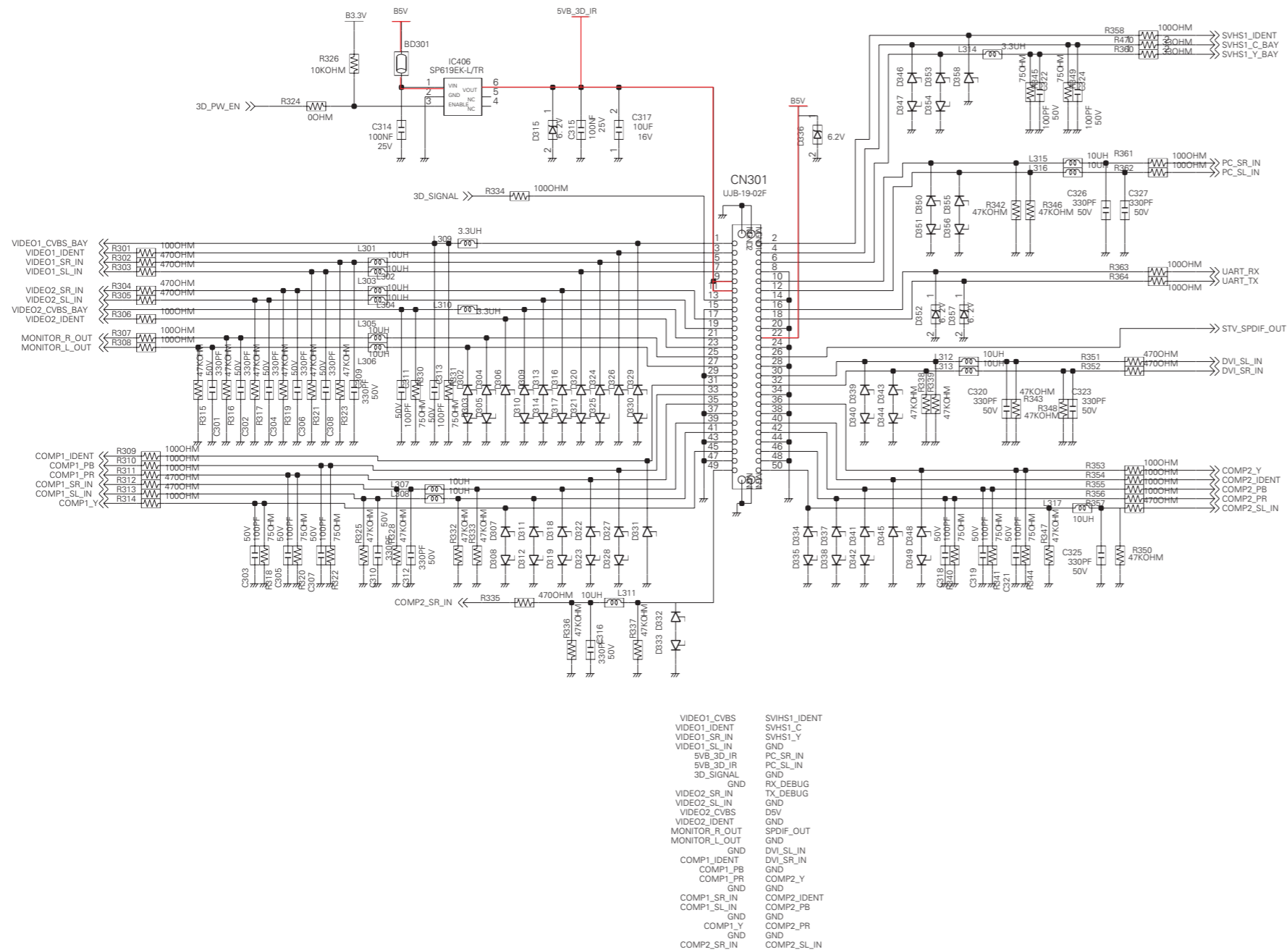

7-3-4 Main Board-4

This Document can not be used without Samsung's authorization.

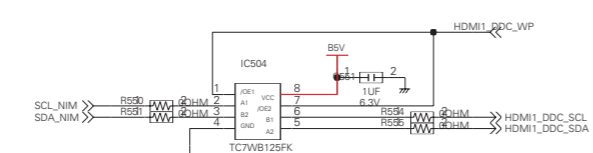
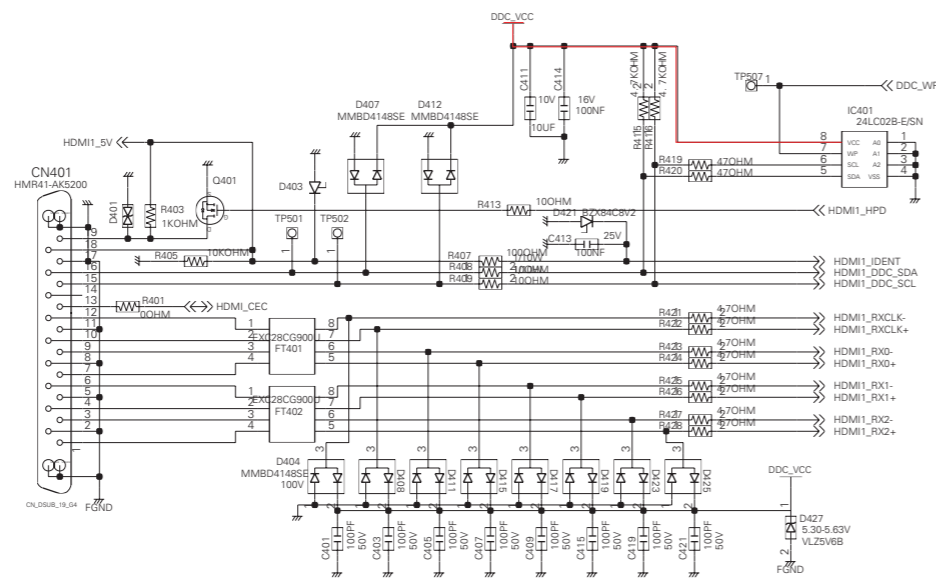

NEAR TO IC401

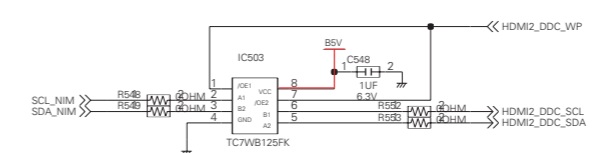
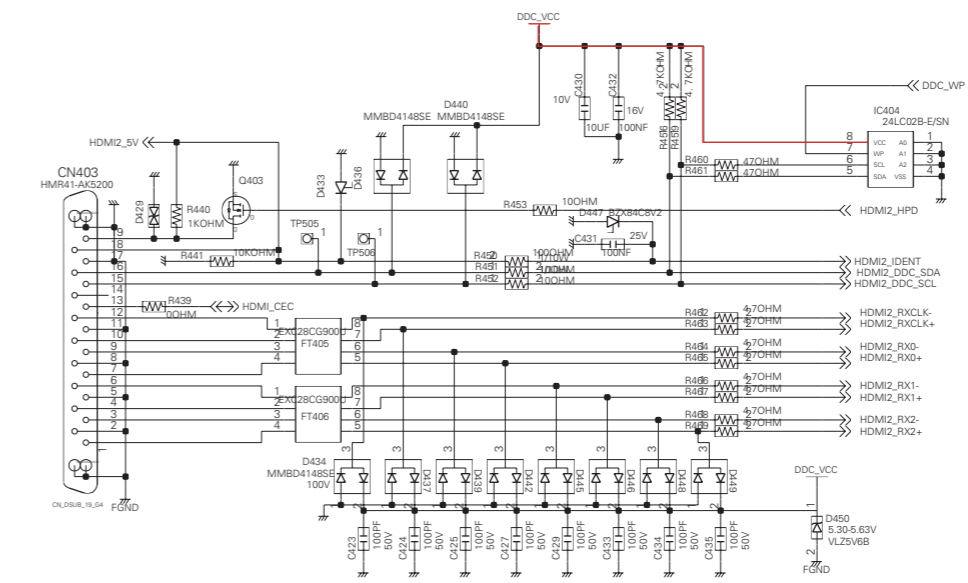

NEAR TO IC404

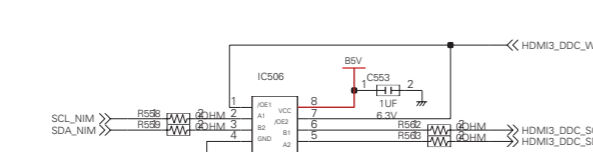
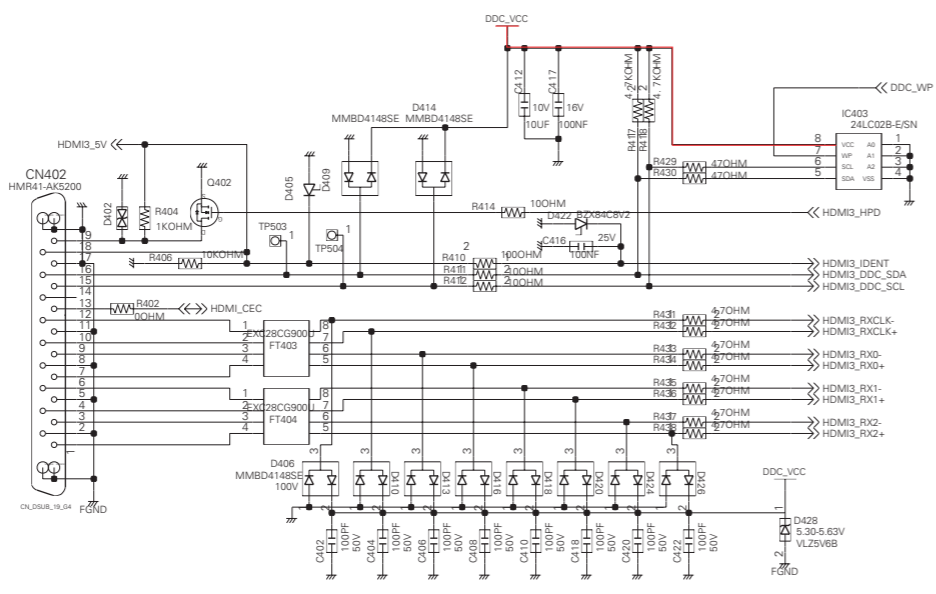

NEAR TO IC403

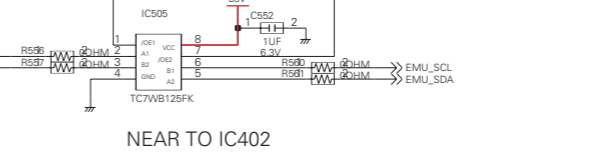
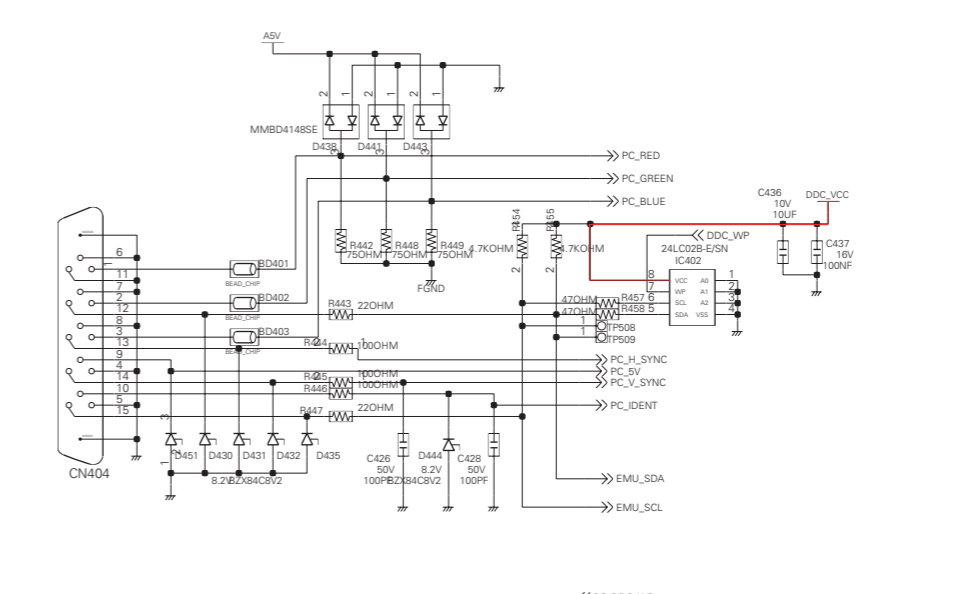

NEAR TO IC402

7-3-6 Main Board-6

This Document can not be used without Samsung's authorization.



ATSC HALF NIM TUNER

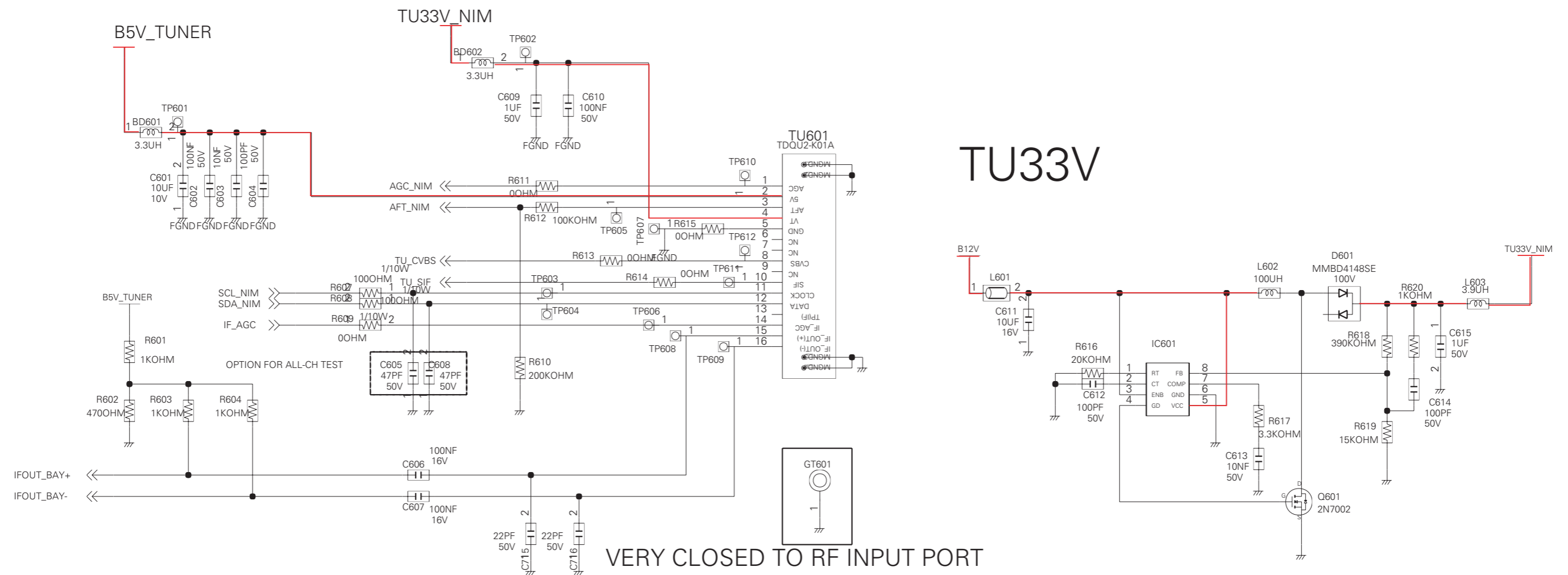

7-3-7 Main Board-7

This Document can not be used without Samsung's authorization.



FROM IR/LED/CONTROL PCB

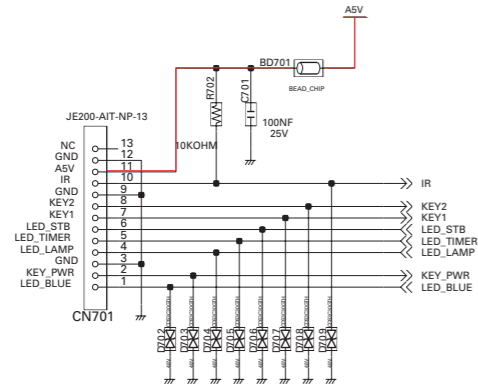

POWER CHECK INDICATOR LED

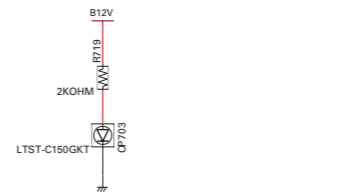

CONNECTOR WITH DMD POWER AND ETC

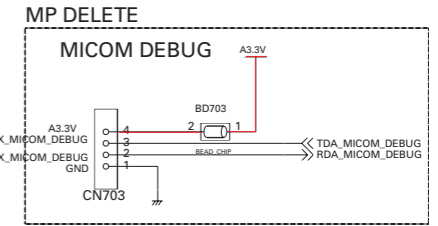
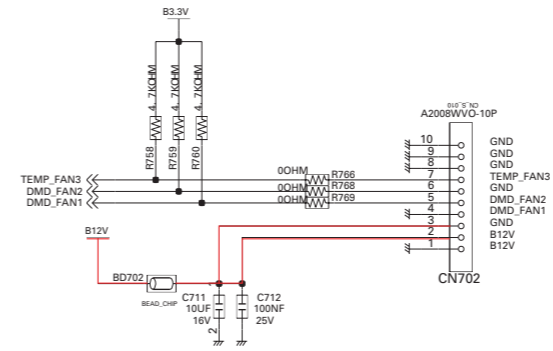

B3.3V AND B1.2V OVER_VOLTAGE DETECT

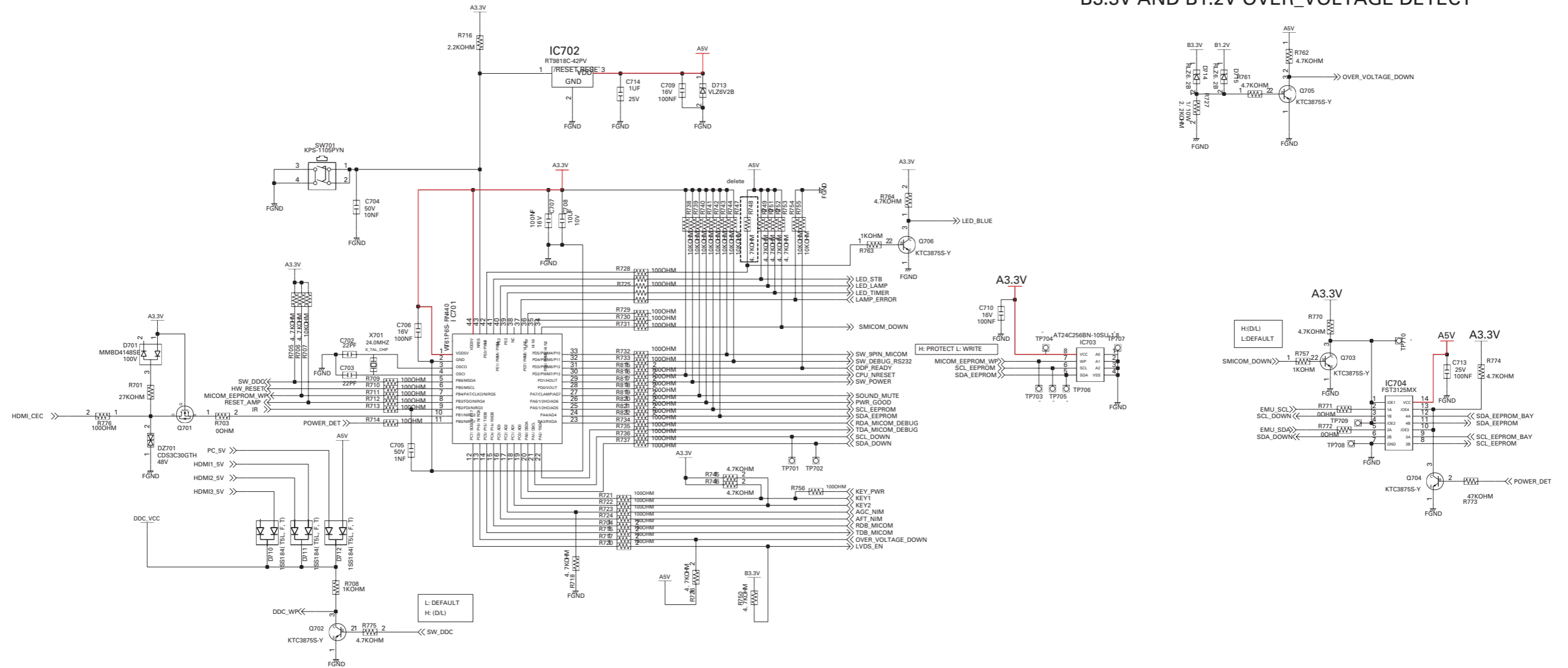
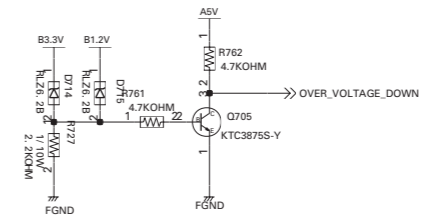

7-3-8 Main Board-8

This Document can not be used without Samsung's authorization.



UART PORT FOR SVC & DEBUGGING

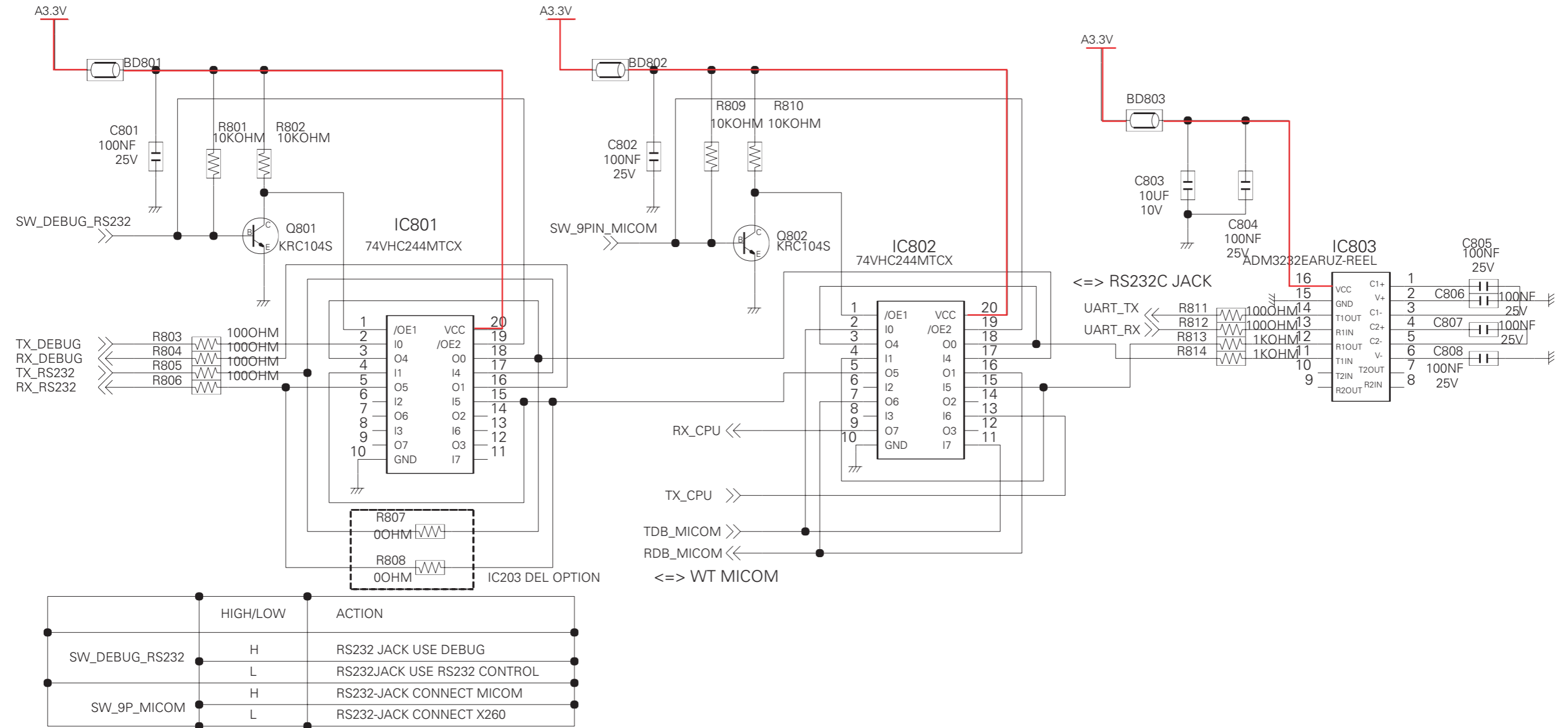

7-3-10 Main Board-10

This Document can not be used without Samsung's authorization.

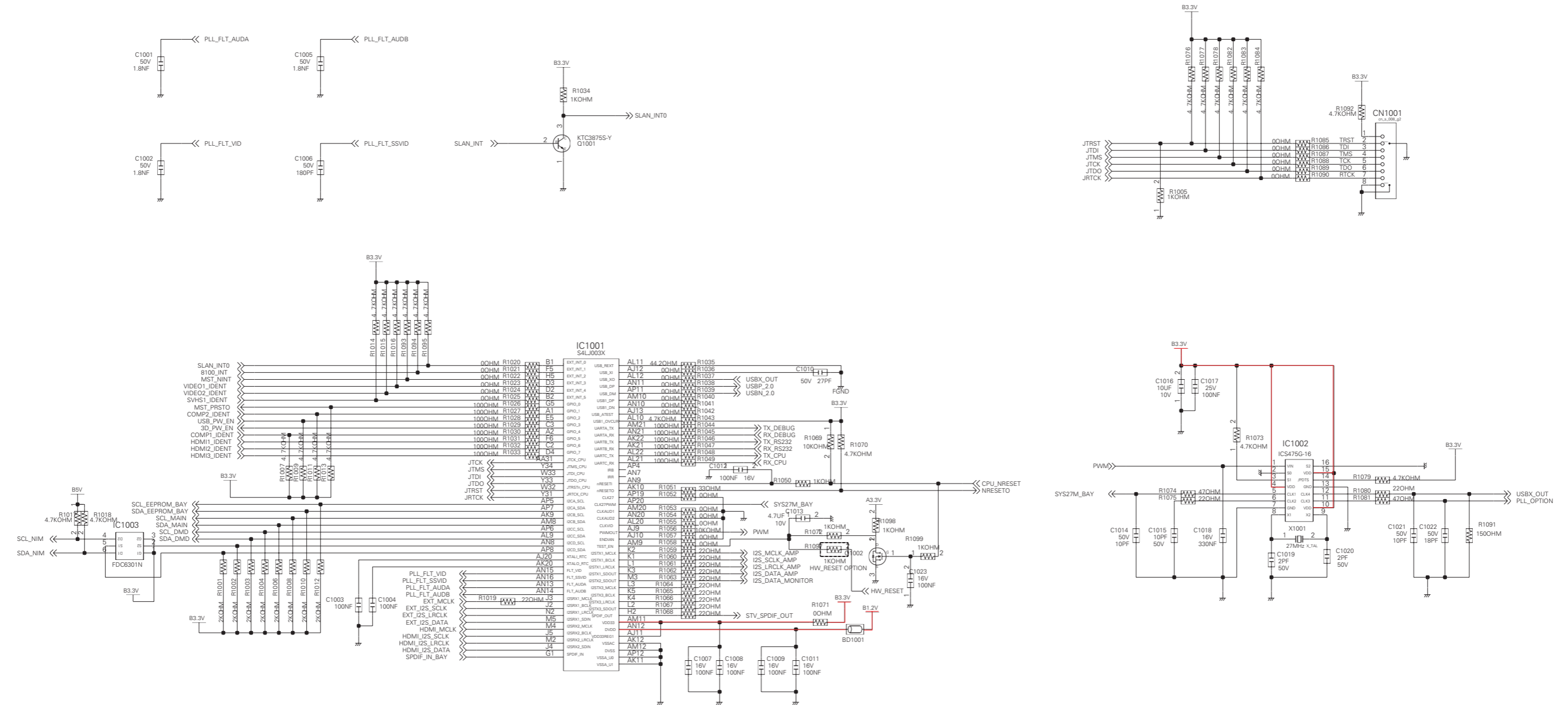

7-3-11 Main Board-11

This Document can not be used without Samsung's authorization.

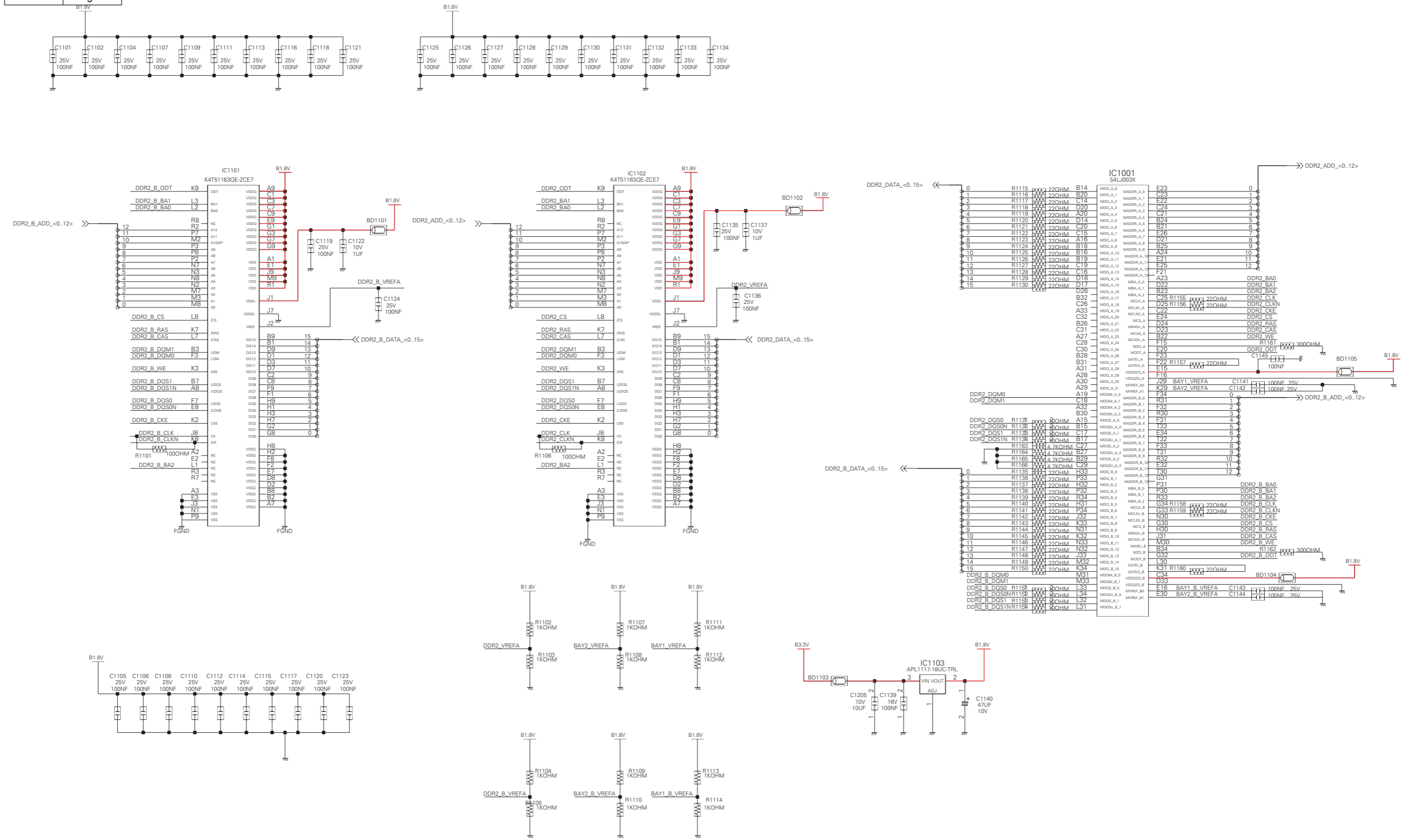
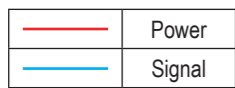

7-3-12 Main Board-12

This Document can not be used without Samsung's authorization.

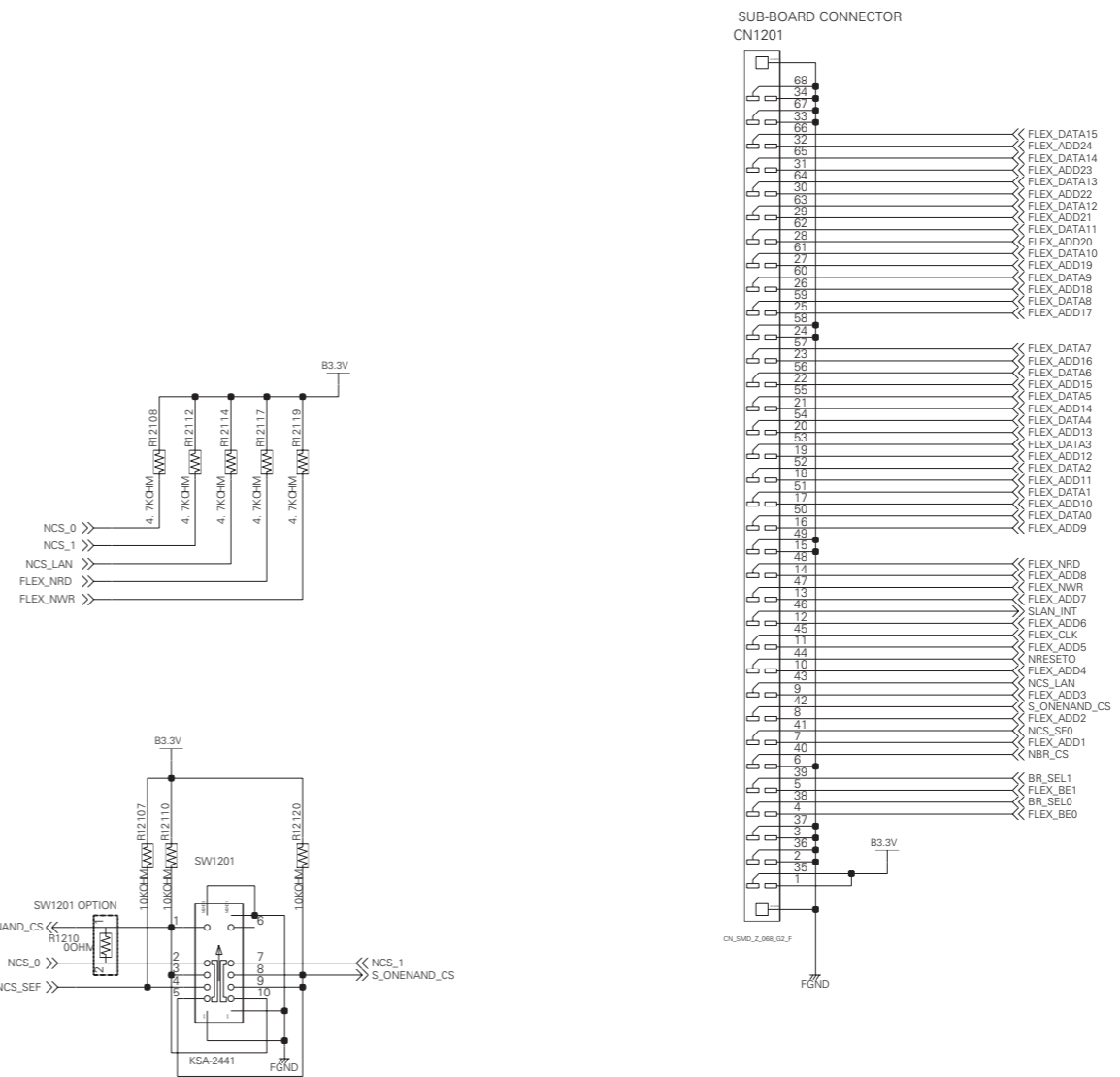
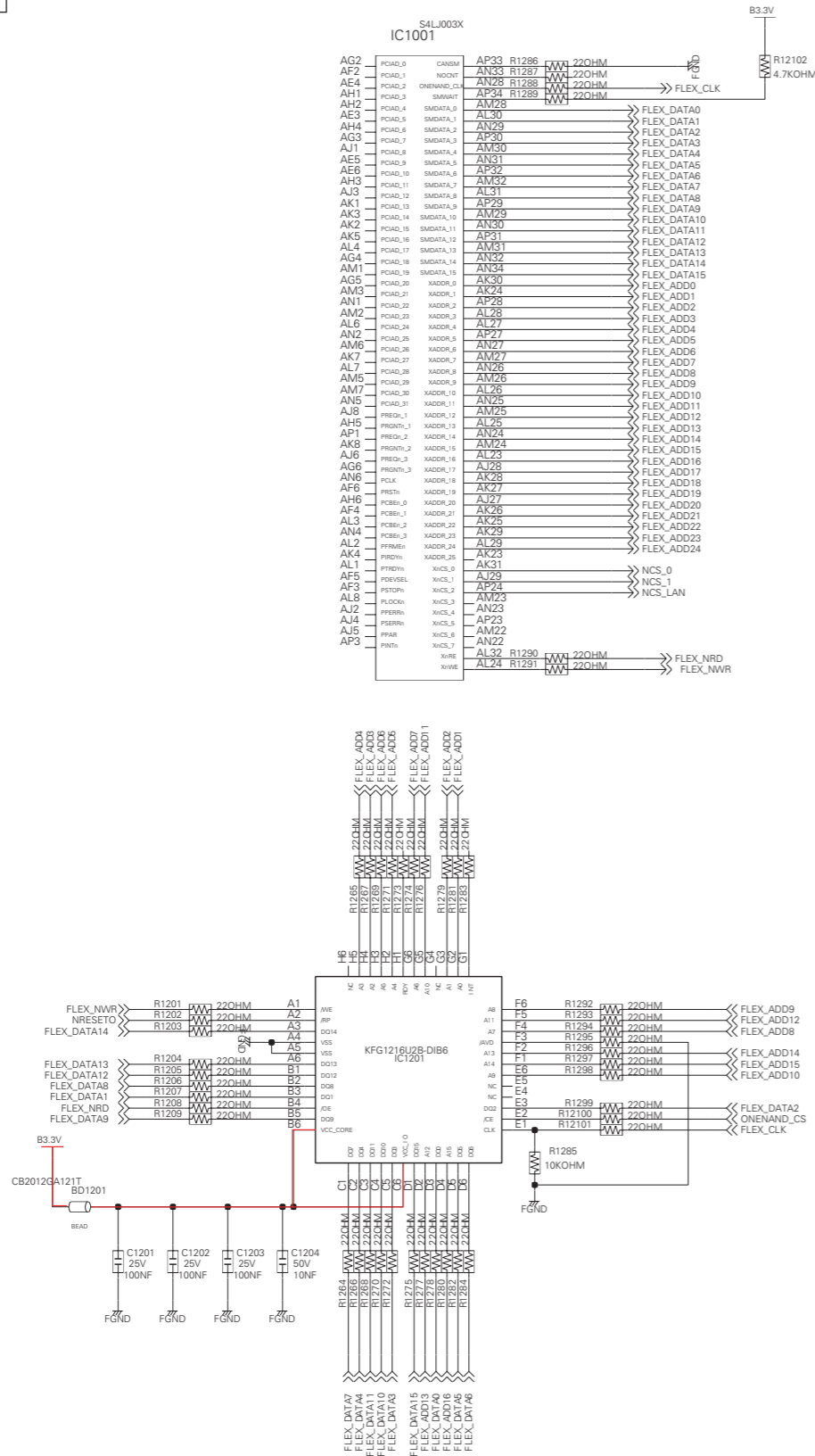
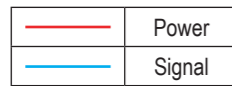

7-3-13 Main Board-13

This Document can not be used without Samsung's authorization.

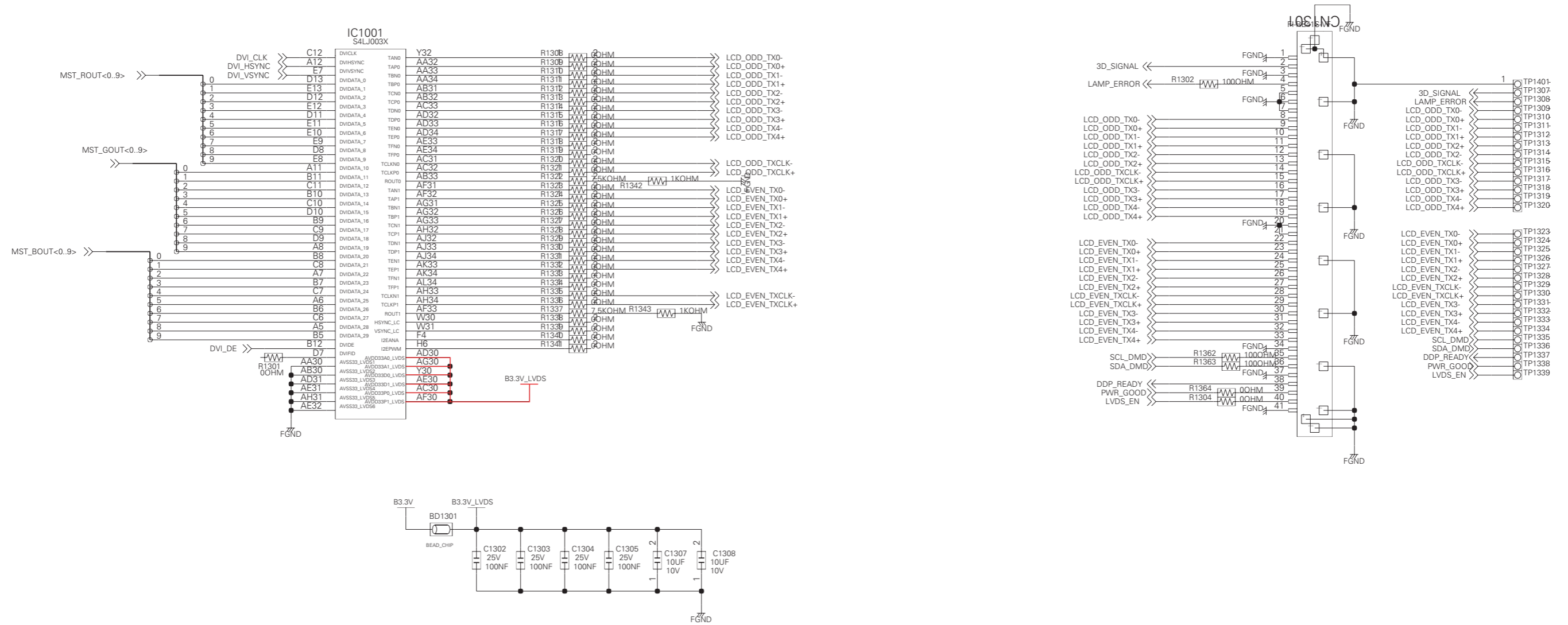

Schematic Diagram

7-3-14 Main Board-14

This Document can not be used without Samsung's authorization.

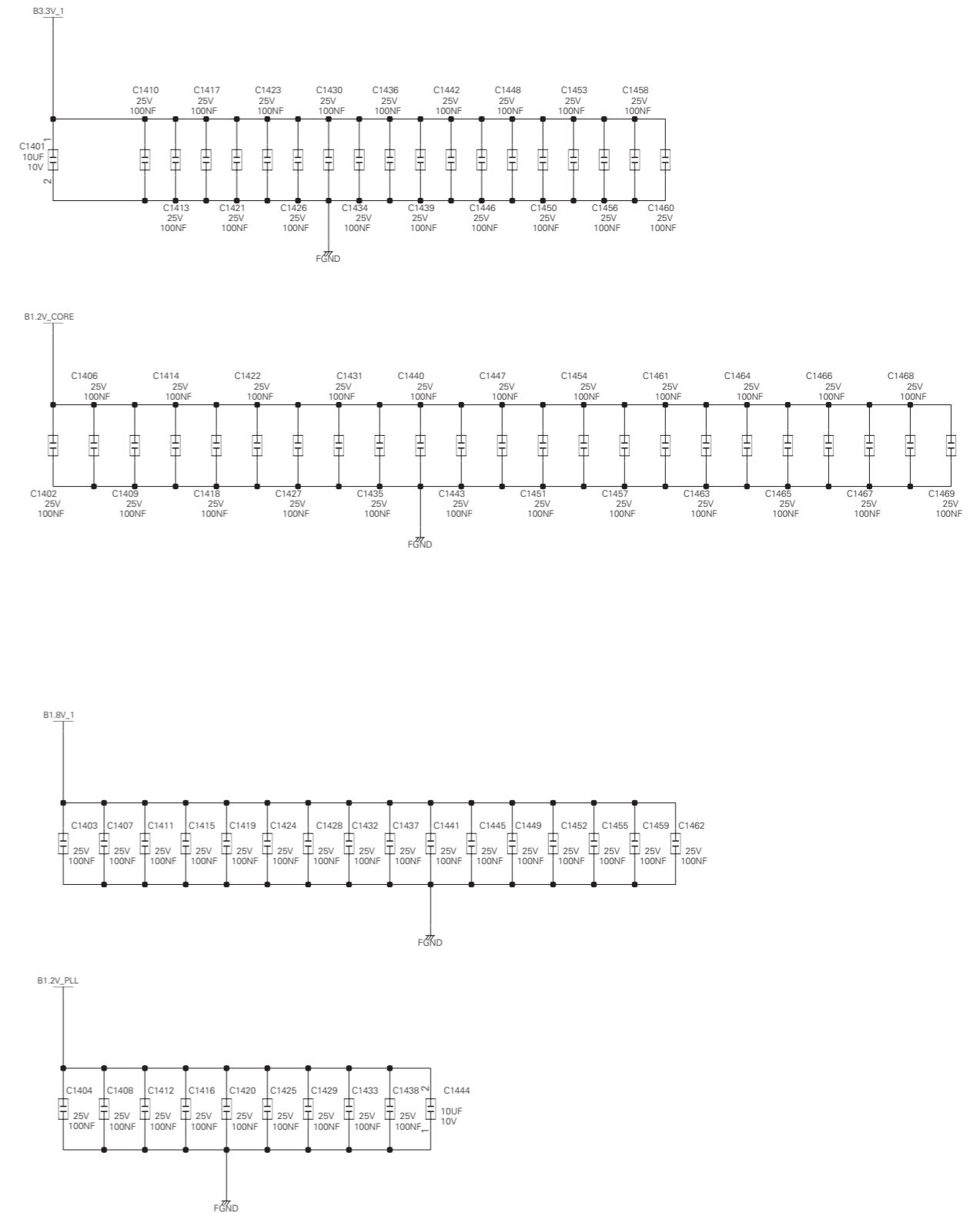
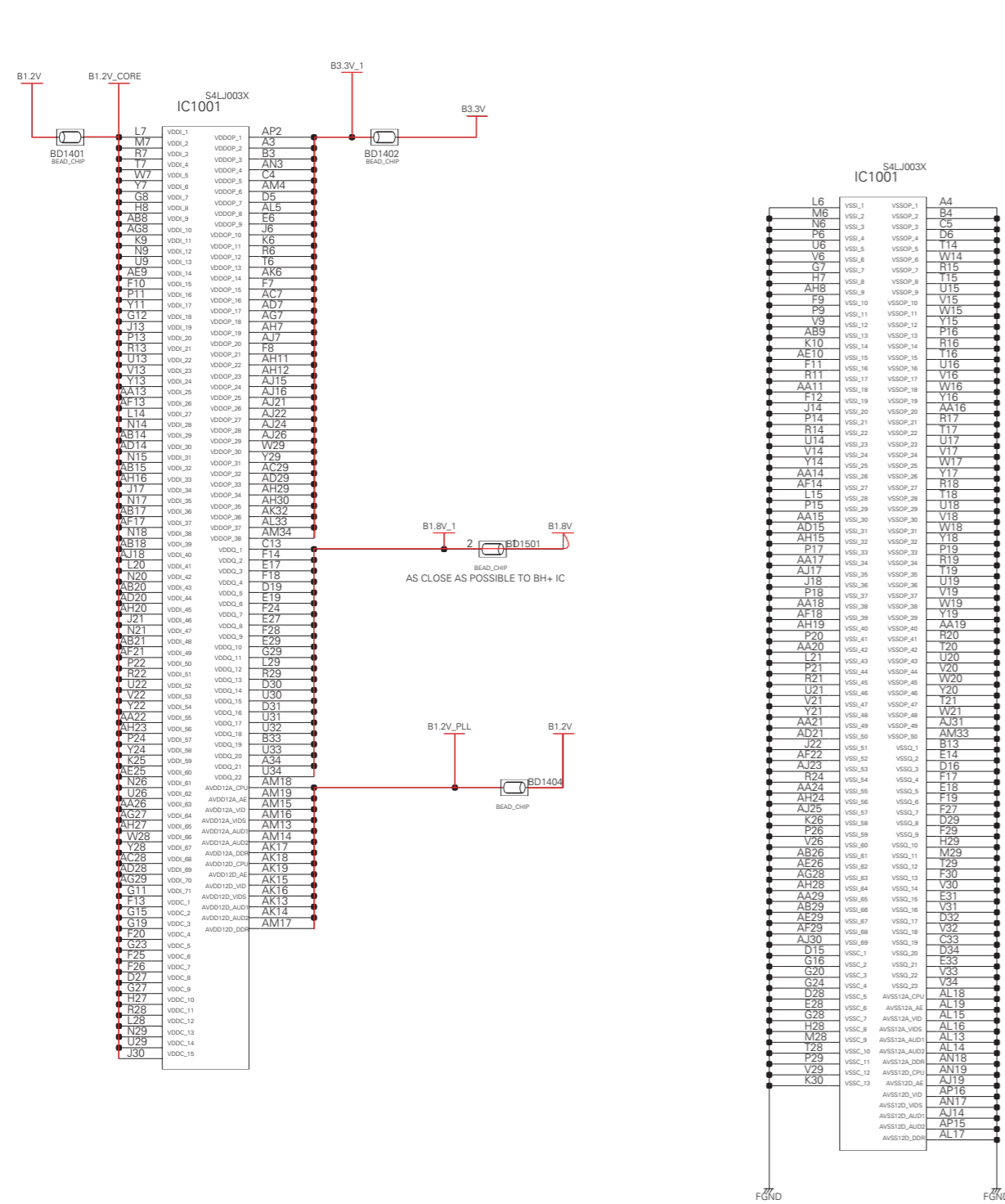

7-3-15 DMD Board-15

This Document can not be used without Samsung's authorization.

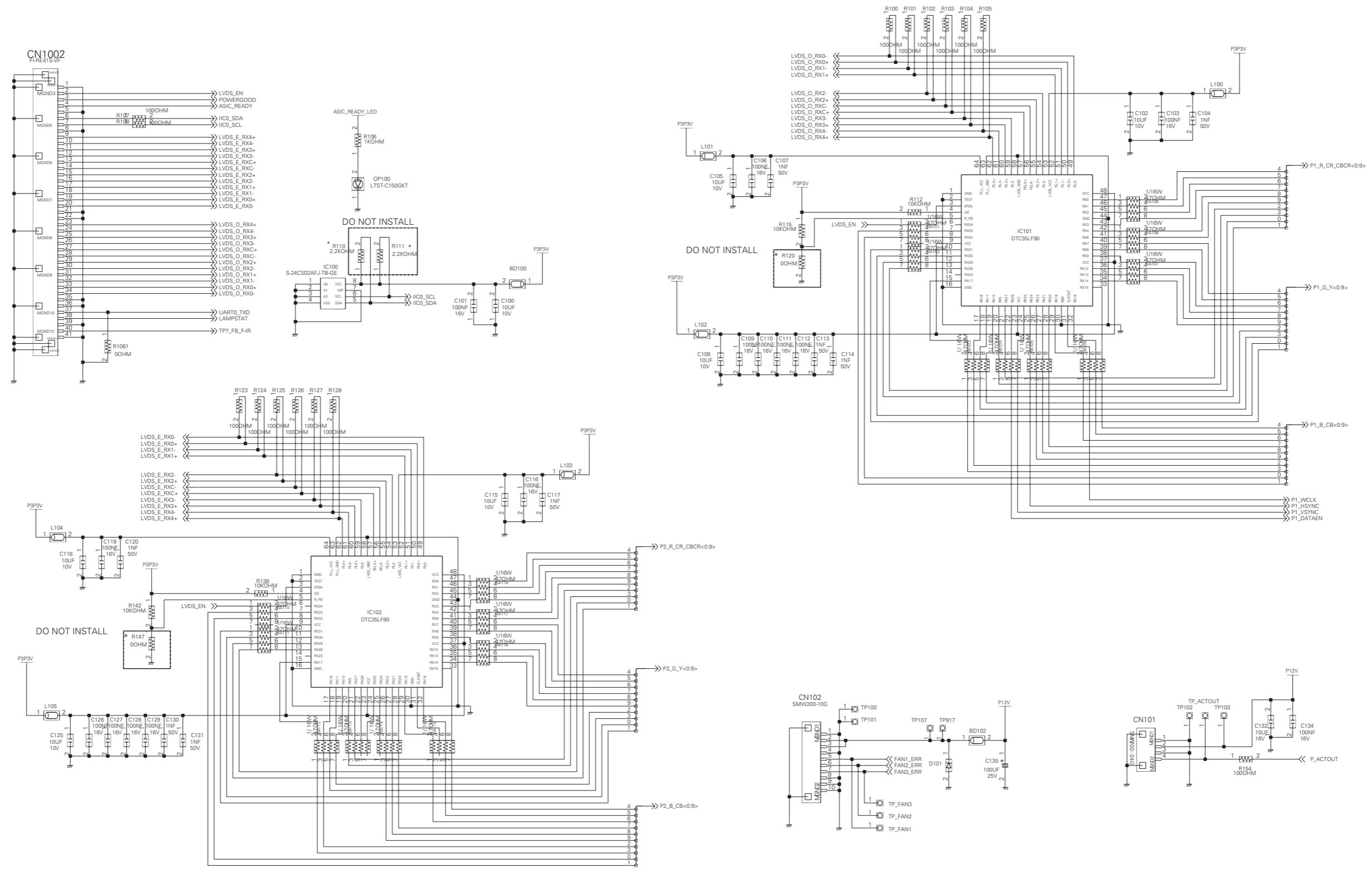

INPUT(LVDS)

7-3-16 DMD Board-16

This Document can not be used without Samsung's authorization.

DDP3021 I/O

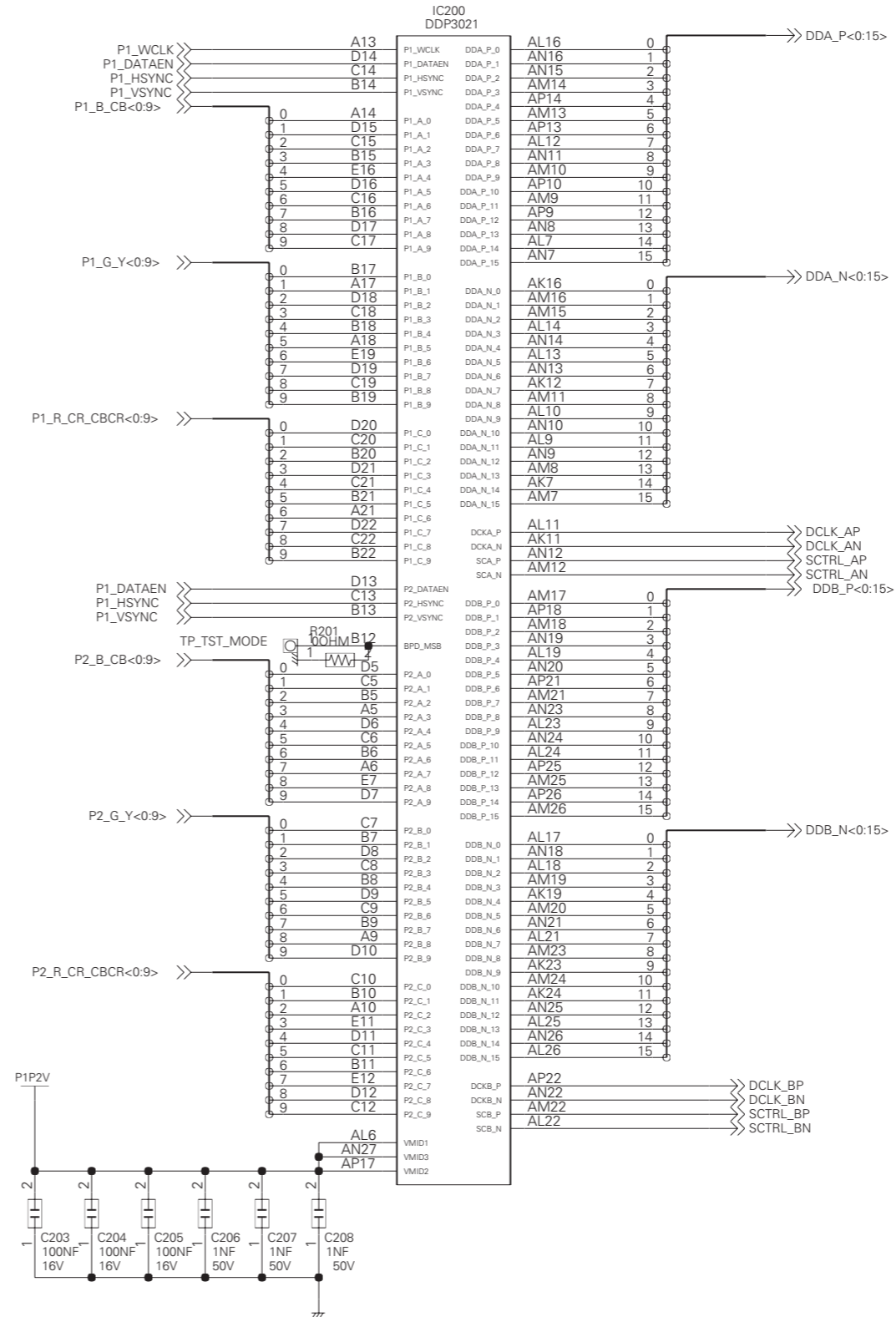

7-3-17 DMD Board-17

This Document can not be used without Samsung's authorization.

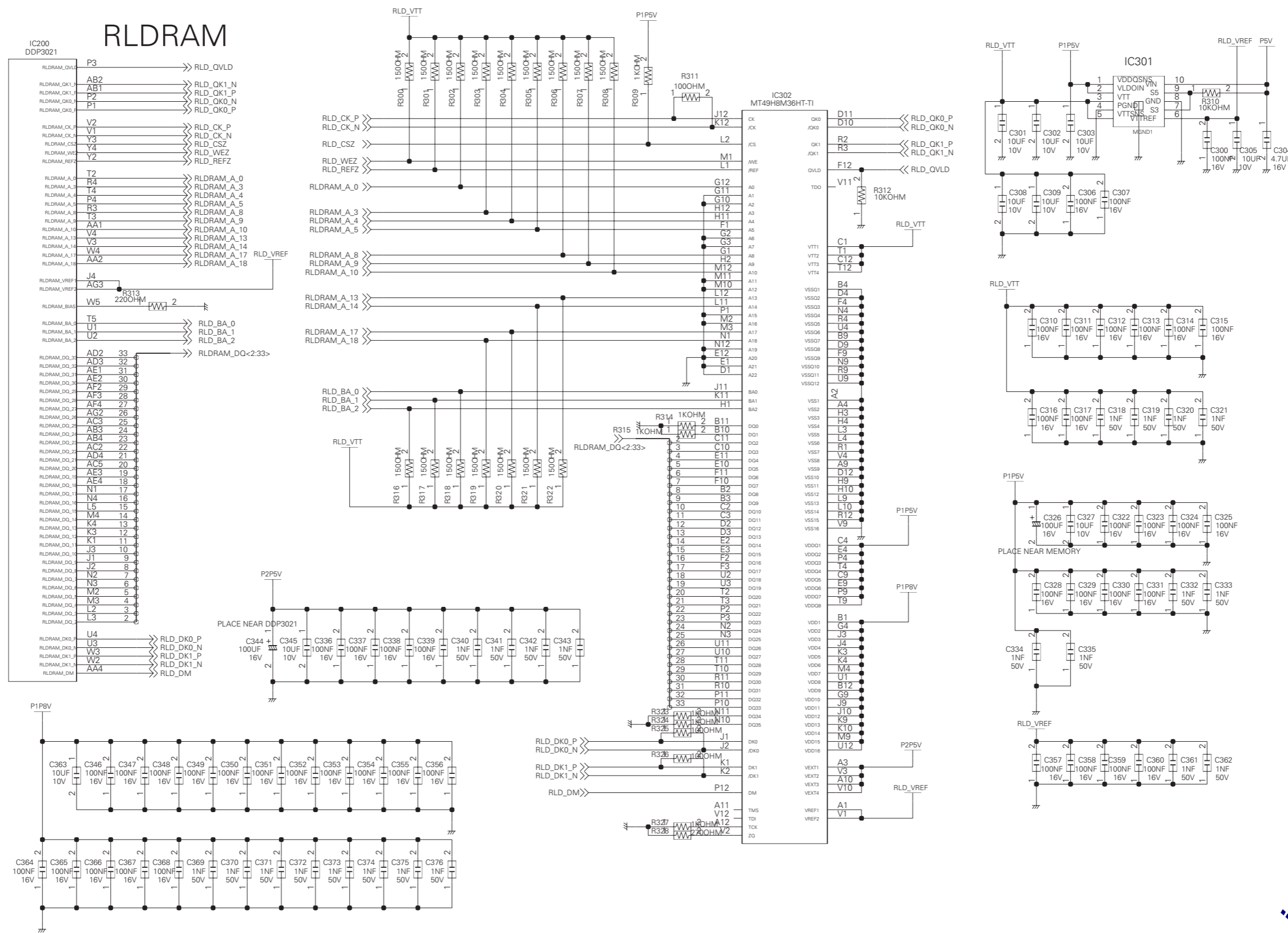

Justmanuals.com

7-3-18 DMD Board-18

This Document can not be used without Samsung's authorization.

DAD2000

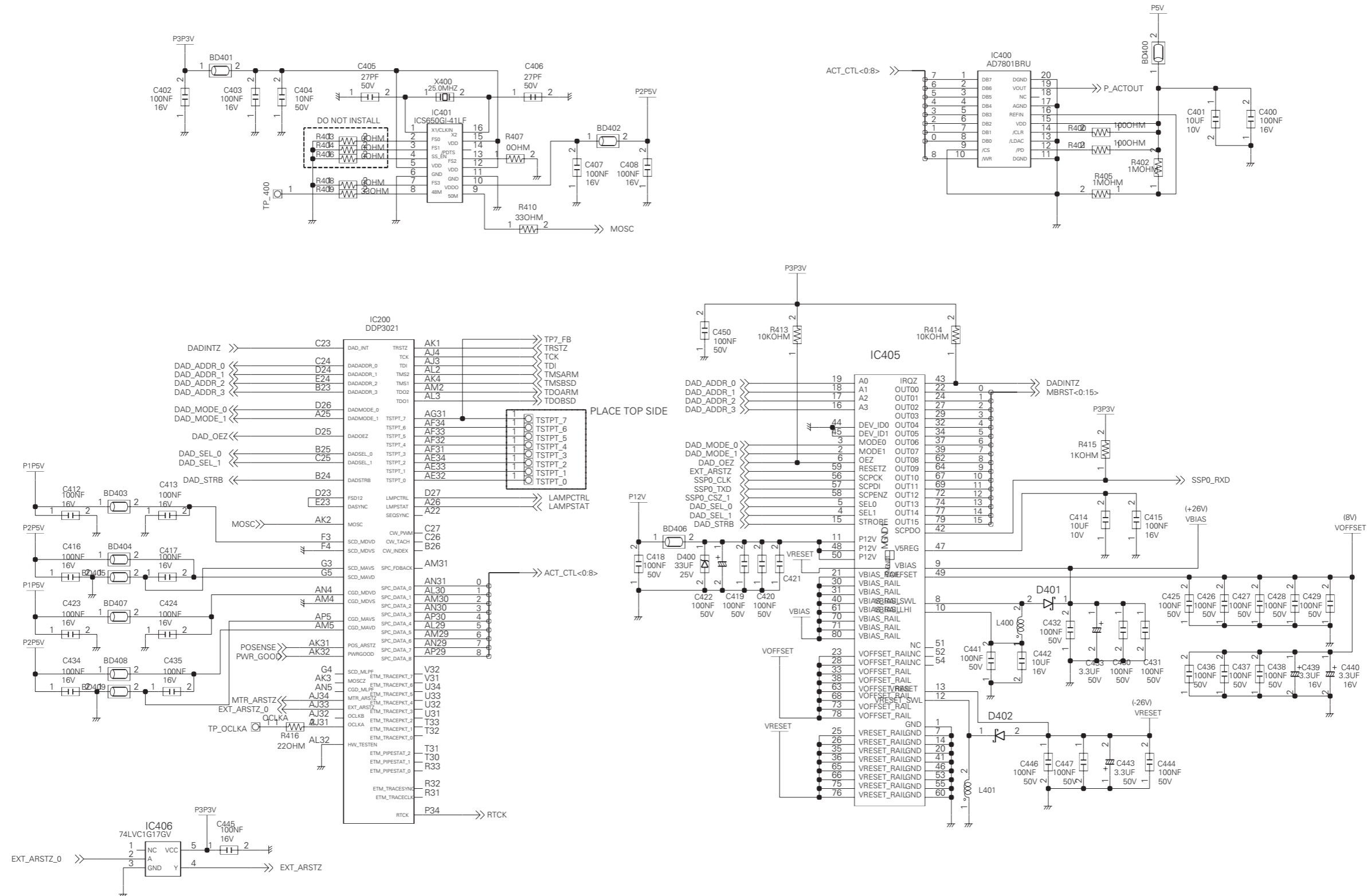

7-3-19 DMD Board-19

This Document can not be used without Samsung's authorization.

FLASH/GPIO

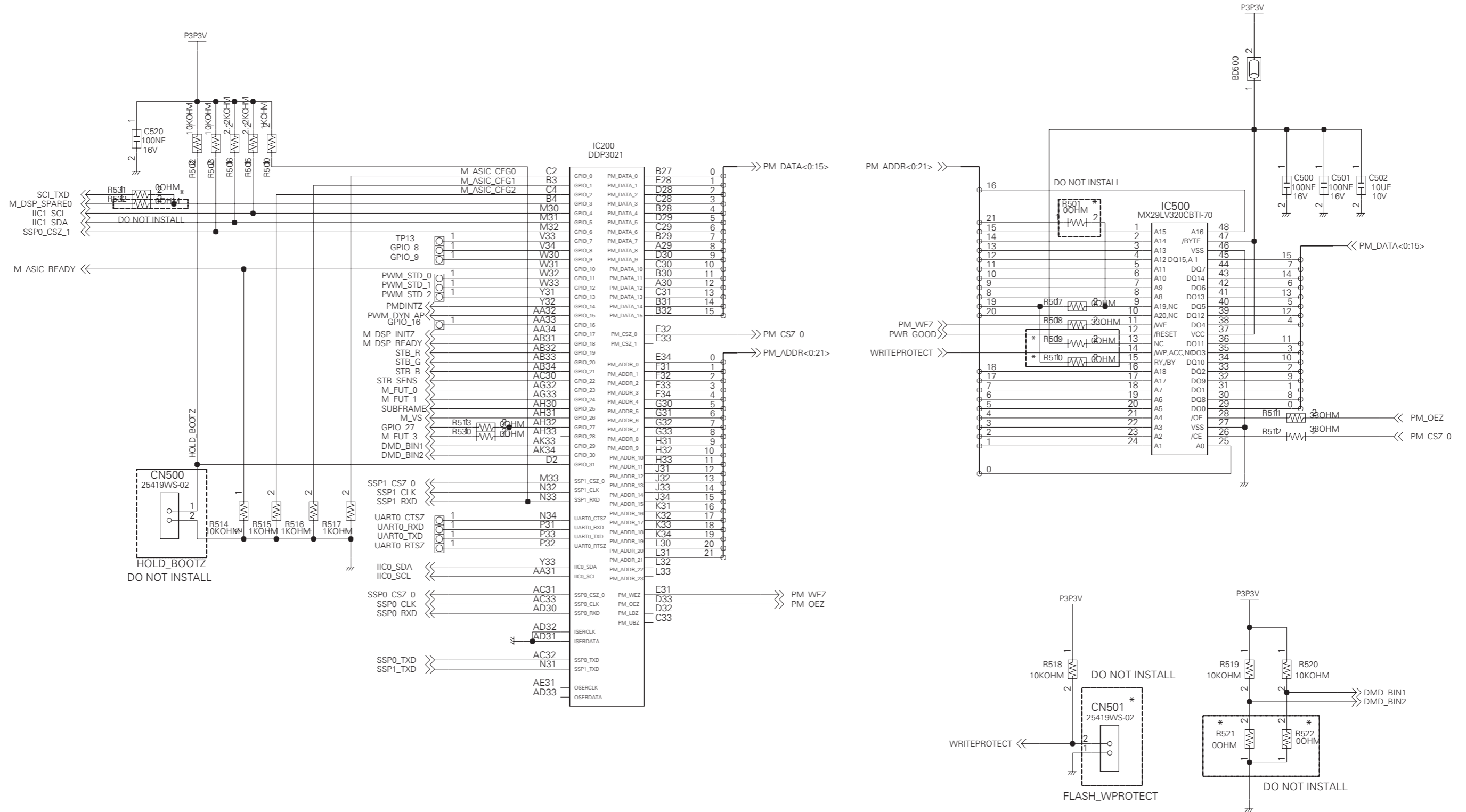

7-3-20 DMD Board-20

This Document can not be used without Samsung's authorization.

DDP3021 POWER

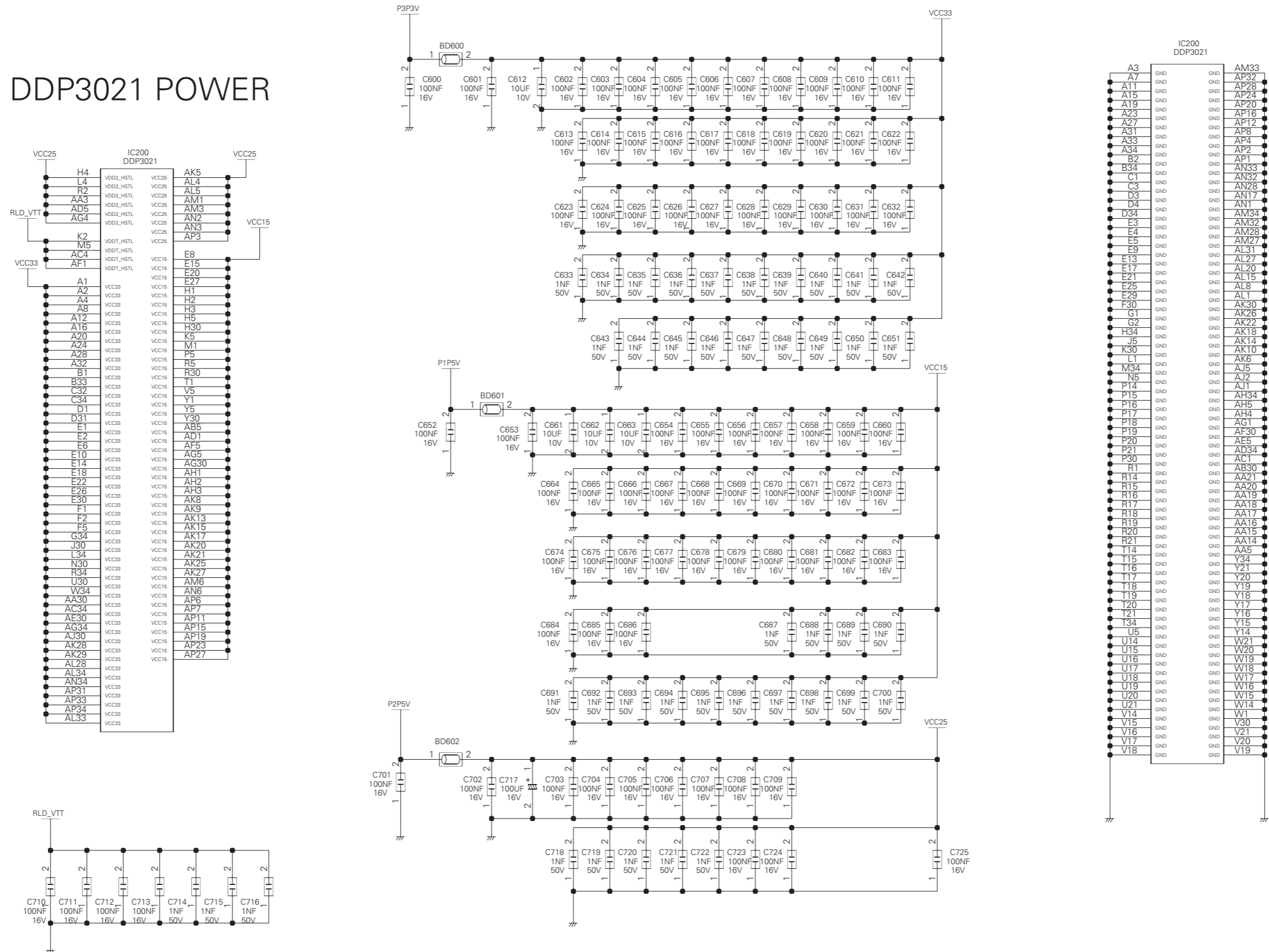

7-3-21 DMD Board-21

This Document can not be used without Samsung's authorization.

PMD1000

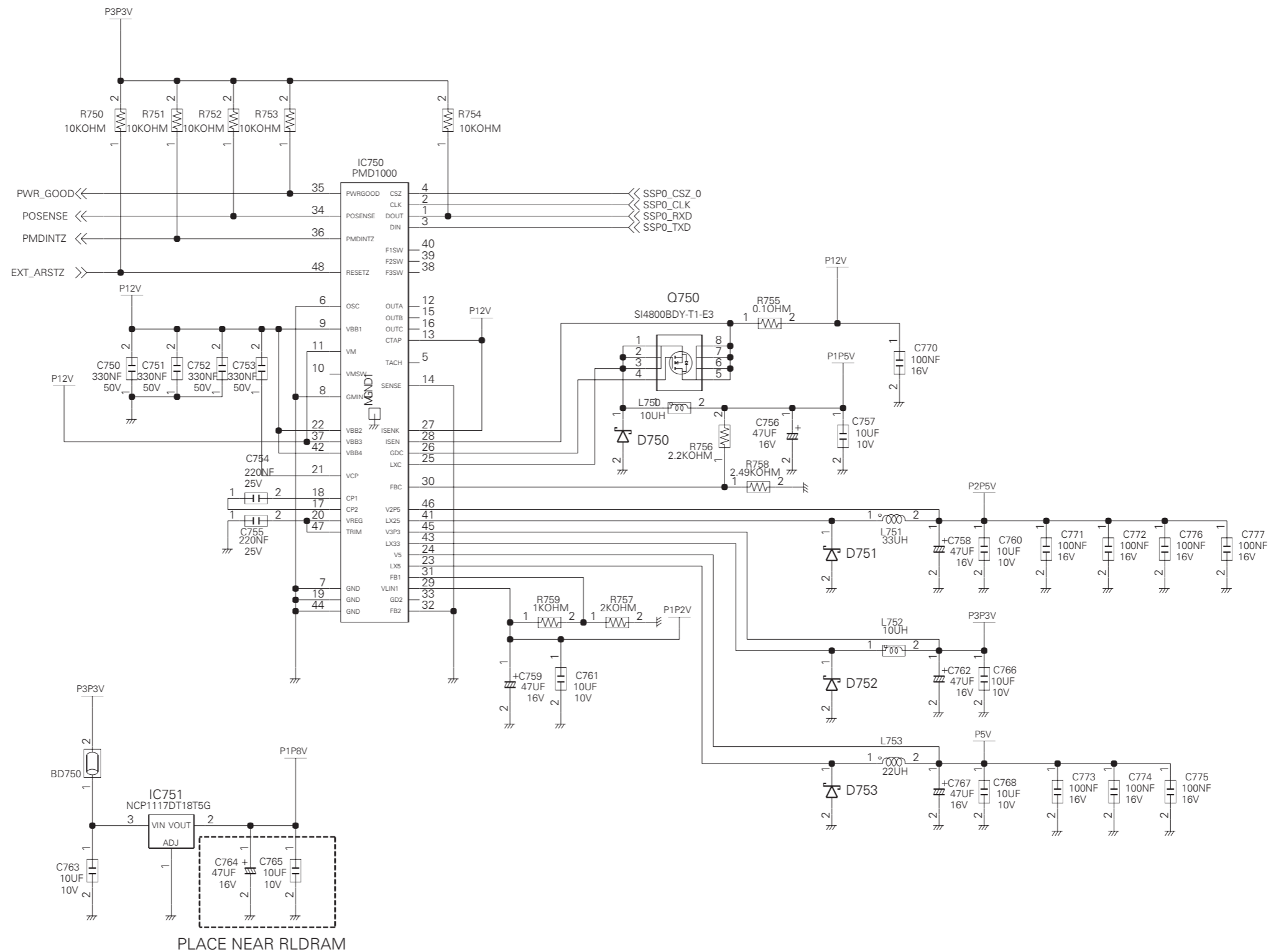

7-3-22 DMD Board-22

This Document can not be used without Samsung's authorization.

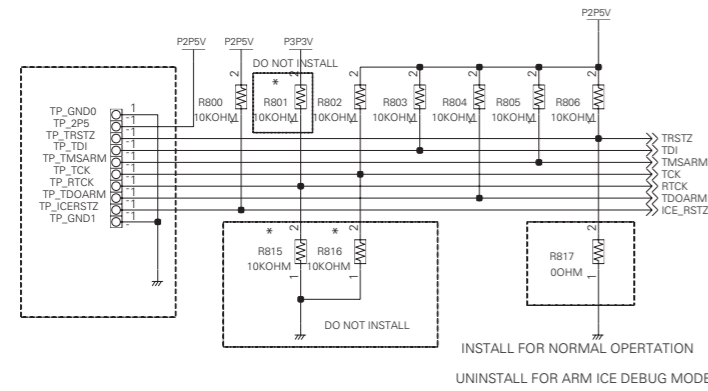

CONNECTOR FOR COLOR SENSOR

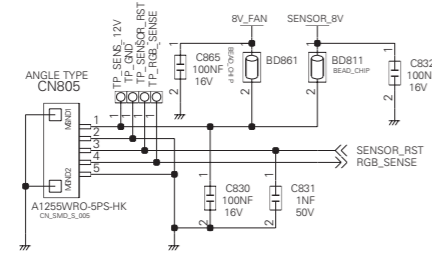

CONNECTOR FOR SCI

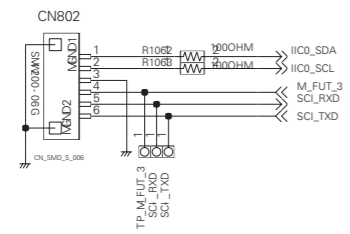

CONNECTOR FOR LED DRIVER

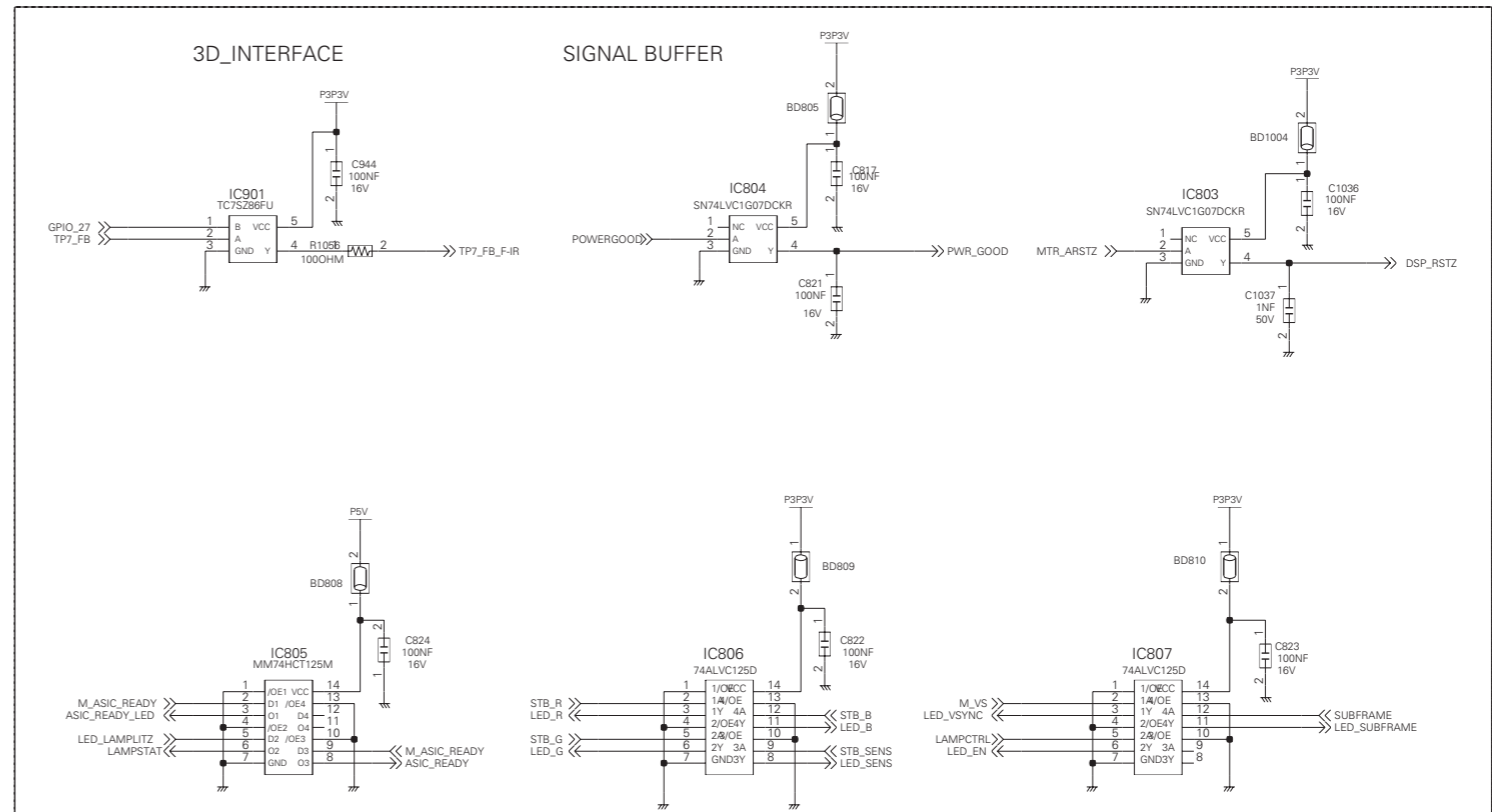
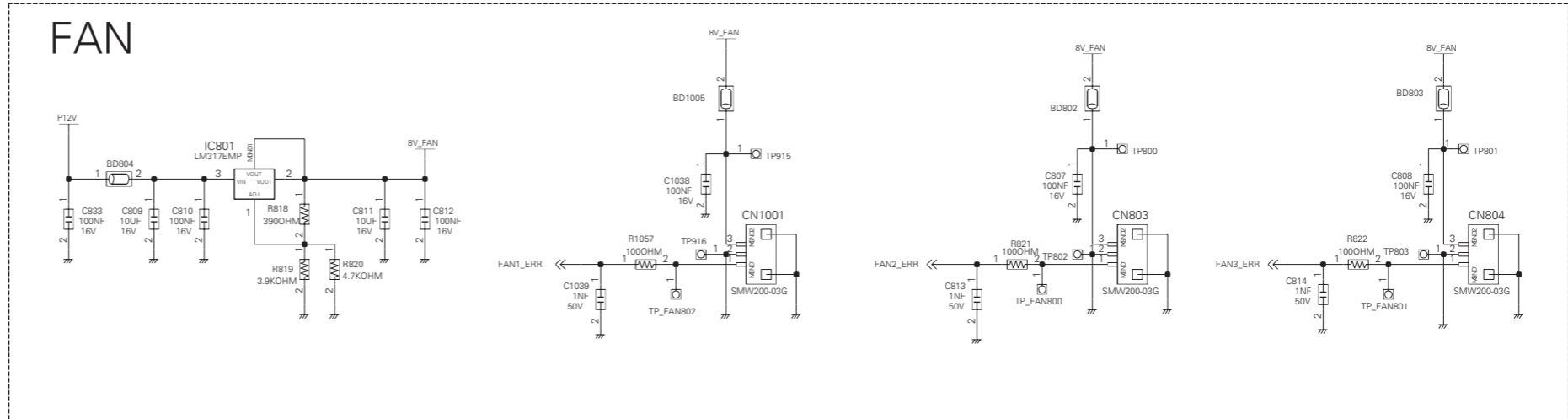
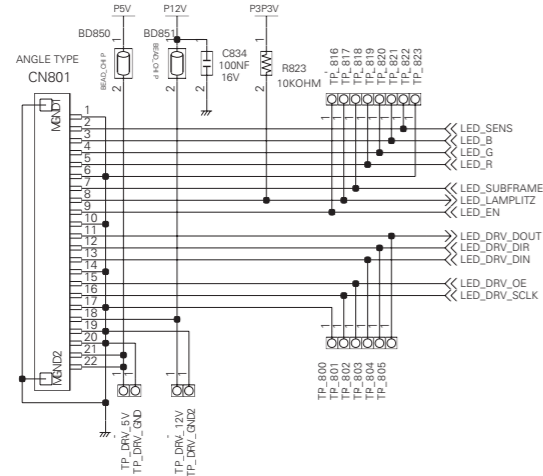

7-3-23 DMD Board-23

This Document can not be used without Samsung's authorization.

DMD

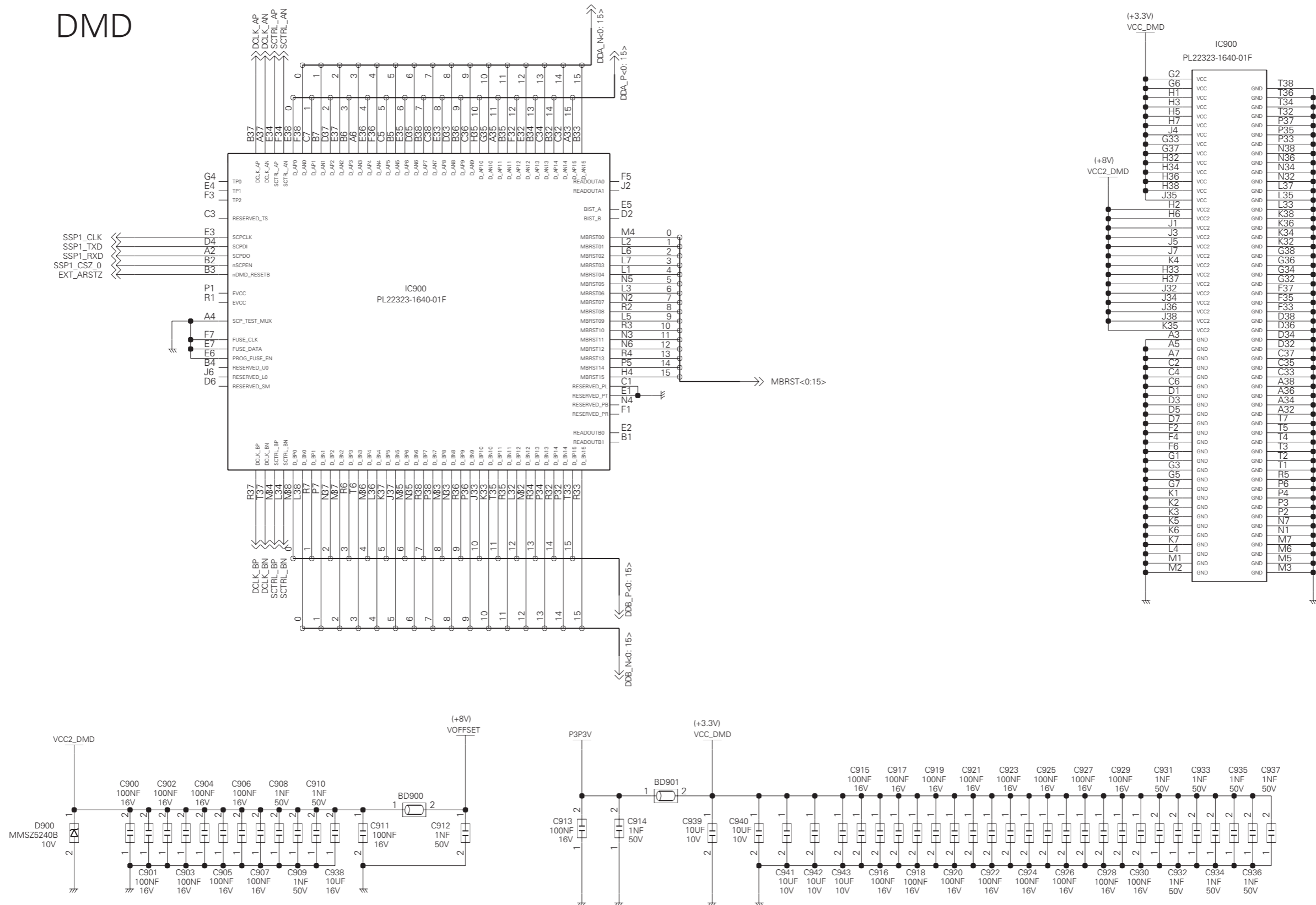

7-3-24 DMD Board-24

This Document can not be used without Samsung's authorization.

DSP

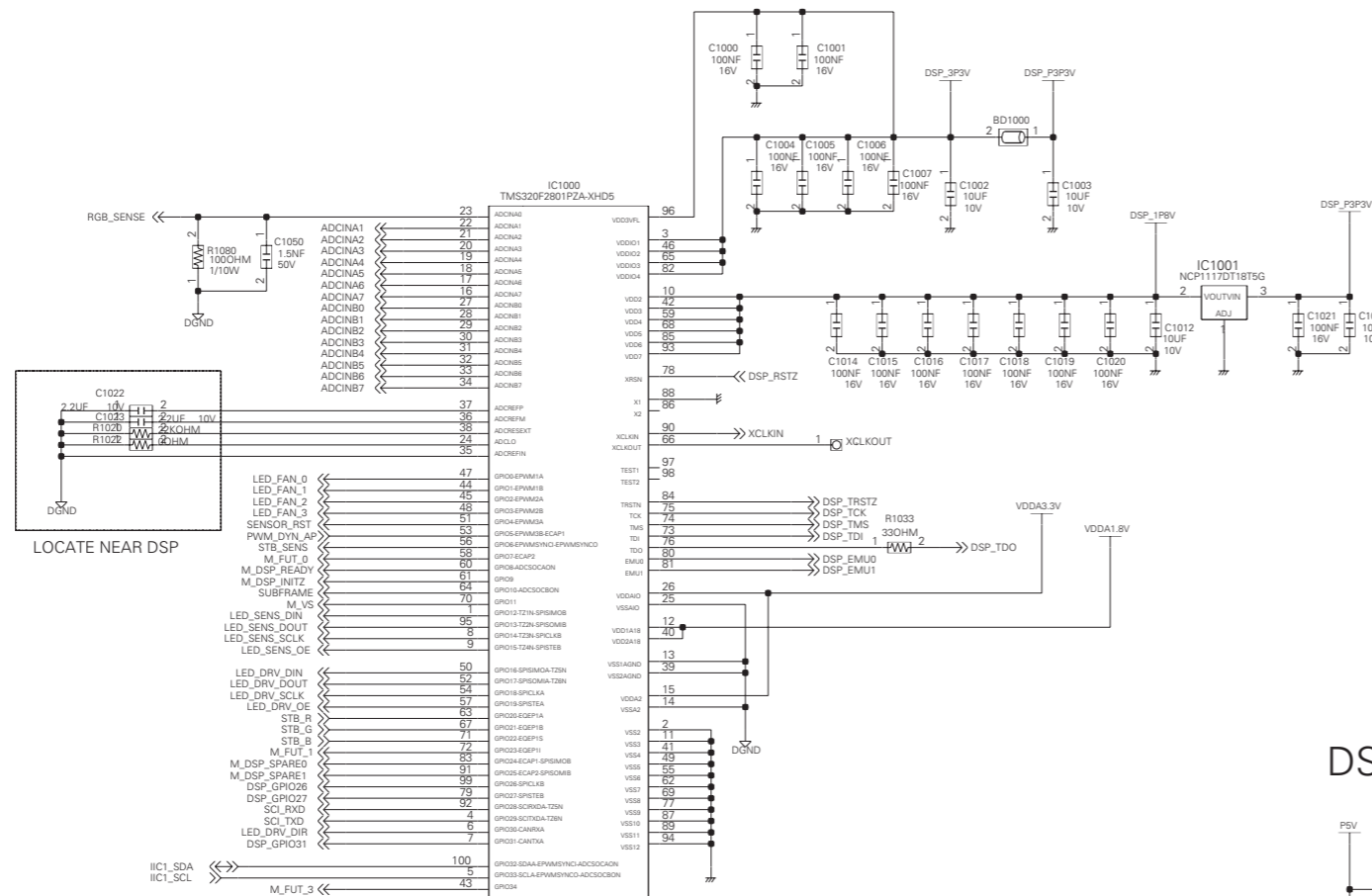

PULL UP & DOWN

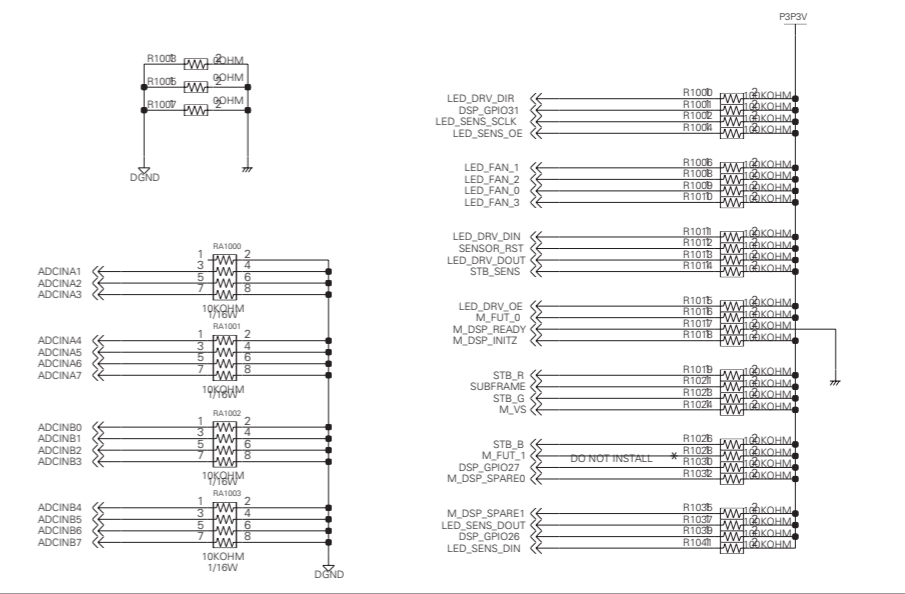

DSP POWER

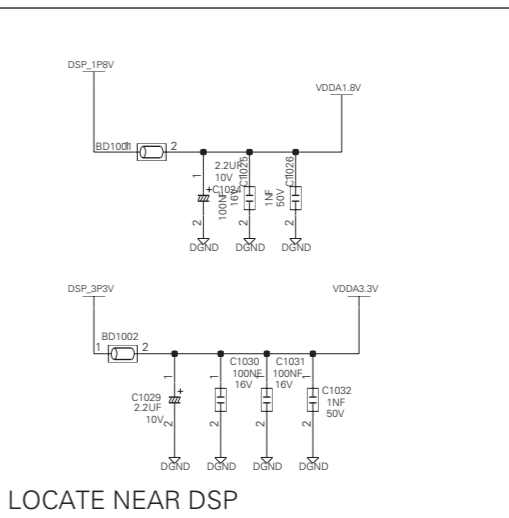
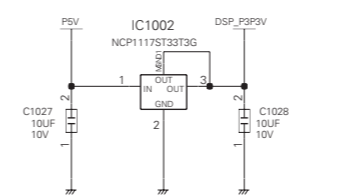

JTAG INTERFACE

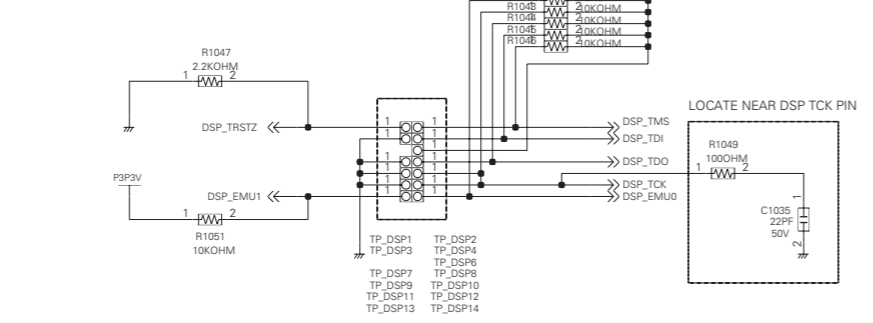

OSC CLOCK FOR DSP

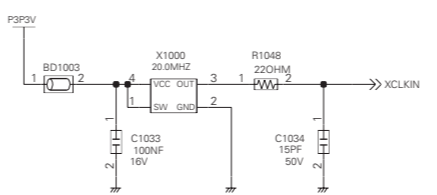

BOOT MODE JUMPER

