

Service Manual

Pioneer



ORDER NO.
ARP3051

PROJECTION MONITOR RECEIVER

PRO-610HD

PRO-510HD

SD-582HD5

SD-532HD5

THIS MANUAL IS APPLICABLE TO THE FOLLOWING MODEL(S) AND TYPE(S).

Type	Model				Power Requirement	Remarks
	PRO-610HD	PRO-510HD	SD-582HD5	SD-532HD5		
KUXC/CA	○	○	○	○	AC120V	
KBXC	—	—	—	○	AC120V	

● This service manual should be used together with the following manual(s):

Model No.	Order No.	Remarks
PRO-610HD	ARP3047	

CONTENTS

6. ADJUSTMENT	195	7.2 IC	228
7. GENERAL INFORMATION	219	7.3 EXPLANATION	254
7.1 DIAGNOSIS	219	8. PANEL FACILITIES AND SPECIFICATIONS	266
7.1.1 DIAGNOSIS METHOD	219		
7.1.2 DISASSEMBLY	224		
7.1.3 WIRING DIAGRAM	226		

PIONEER CORPORATION 4-1, Meguro 1-Chome, Meguro-ku, Tokyo 153-8654, Japan
PIONEER ELECTRONICS SERVICE, INC. P.O. Box 1760, Long Beach, CA 90801-1760, U.S.A.
PIONEER ELECTRONIC (EUROPE) N.V. Haven 1087, Keetberglaan 1, 9120 Melsele, Belgium
PIONEER ELECTRONICS ASIACENTRE PTE. LTD. 253 Alexandra Road, #04-01, Singapore 159936
© PIONEER CORPORATION 1999

PRO-610HD, PRO-510HD, SD-582HD5, SD-532HD5

6. ADJUSTMENT

6.1 INTRODUCTION

• **IMPORTANT**







When replacement of the following assemblies are required during repairs, be sure to replace the EEPROMs with the mounted ones in order to retain the adjustment data of the unit and to facilitate adjustment after the replacement of the assemblies.

Name of Assy	EEPROM	Main Contents of Memory
SIGNAL Assy	IC2454 [24LC32(I)P]	Adjustment data, such as W/B and color data, in FACTORY mode User data set on the MENU
DIGITAL CONV. Assy	IC1410 [24LC128P]	Convergence adjustment data
	IC1656 [24LC08B(I)P]	Convergence offset data

Notes:

- Even if the EEPROMs are replaced, adjustment may be necessary, depending on the part or assembly to be replaced. For details, see page 197.
- Even if the EEPROMs are replaced, if the EEPROMs are damaged or if their data have been changed from the adjustment data, the status before the failure will not be restored. Check the status of the unit after replacement of the EEPROMs, and readjust if necessary.

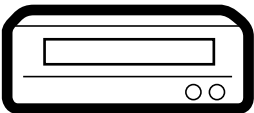
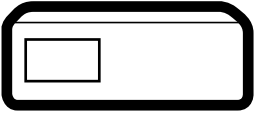
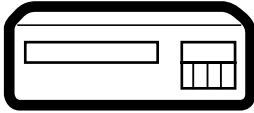
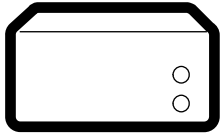
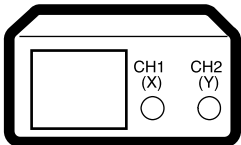
6.2 JIGS AND MEASURING INSTRUMENTS

 <p>Remote control unit AXD1448 (CU-SD110) (For PRO-610HD, PRO-510HD)</p>	 <p>Remote control unit AXD1449 (CU-SD111) (For SD-582HD5, SD-532HD5)</p>	 <p>⊖ Screwdriver</p>	 <p>⊖ Adjustment screwdriver</p>
 <p>Color bar generator</p>	 <p>D. DC Voltmeter</p>	 <p>LD Player</p>	 <p>Monoscope</p>
 <p>Dual-trace oscilloscope</p>	 <p>Frequency counter</p>	 <p>For HD Signal generator</p>	

6.3 ADJUSTMENT LOCATION AND ITEMS

Assembly Adjustment Location

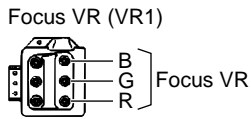

Front View

- B** CONV. AMP ASSY
- C** DIGITAL CONV. ASSY

- A** DEFLECTION (SERVICE) ASSY

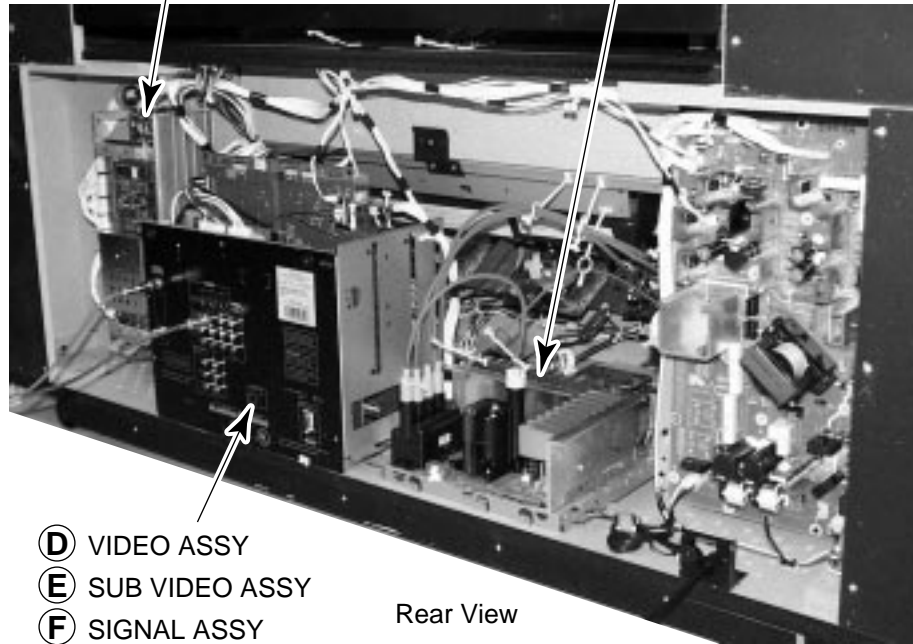

Rear View

- D** VIDEO ASSY
- E** SUB VIDEO ASSY
- F** SIGNAL ASSY

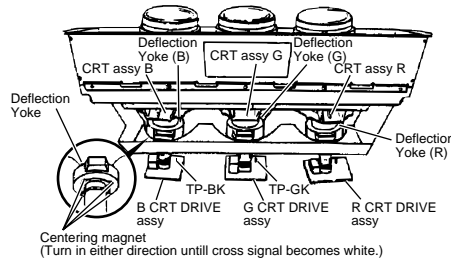
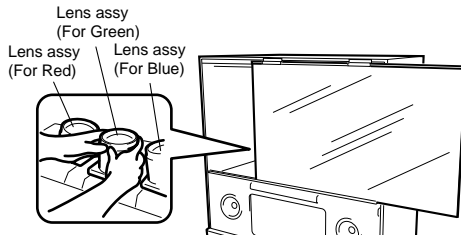

Adjustment Items

- 1 Brightness Adjustment
- 2 Deflection Yoke Adjustment
- 3 Focus Adjustment
- 4 Test-cross Position Check
- 5 Screen Size Adjustment
- 6 Convergence Adjustment
- 7 White Balance Adjustment
- 8 Panel Adjustment
- 9 Panel Adjustment for DTV

MEASURING METHOD

Disconnect the FBT anode cable as shown below.
Measure at the point where the cable enters the FBT.

Caution : Take extra precaution when measuring the voltage. High voltage are also present in surrounding circuit boards. (CRT assy, POWER SUPPLY assy)

SERVICEMAN WARNING

Before removing the anode cable, turn off the power, unplug the AC plug and let the unit discharge for more than 1 minute.

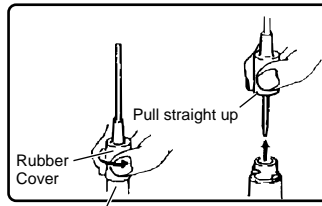

Holding the rubber cover firmly, turn counterclockwise and check that the lock has been disengaged.

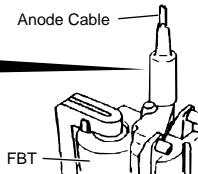

Note :
When reconnecting the cable, proceed in the reverse order. After reconnecting, tug on the cable to check that it is secure.

■ Assembly Adjustment Location Guide

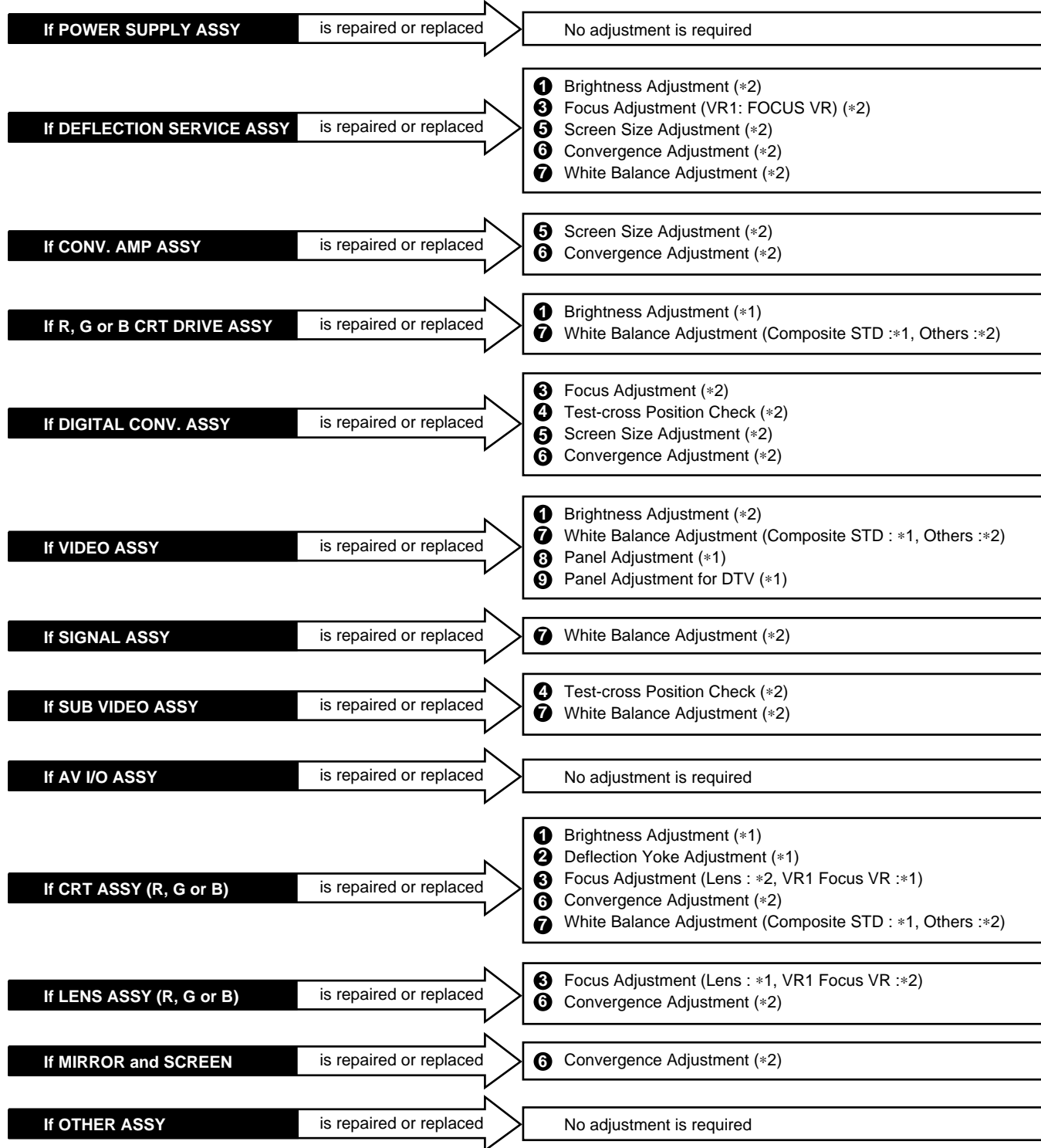

Note :

*1: Readjustment necessary

*2: Turn on the power and confirm the screen. When adjustment deviates, it is readjusted if necessary.

- When the EEPROMs are replaced, check the status of the unit.
- If any IC of the EEPROM is damaged, readjustment of all the items is necessary.

• The necessary adjustment items differ, depending on the assembly or optical part replaced. Check and readjust the adjustment items corresponding to the replaced assembly or part, following adjustment procedures 1 to 9.

Example: When the DIGITAL CONV. Assy is replaced, perform the following:

- 3. Focus check/adjustment → 4. Test-cross position check/adjustment → 5. Screen size check/adjustment → 6. Convergence check/adjustment

6.4 FACTORY ADJ MODE

■ Factory Adjustment Mode

Start Start adjusting

1st FAC Select 1st FACTORY ADJ mode, then adjust.

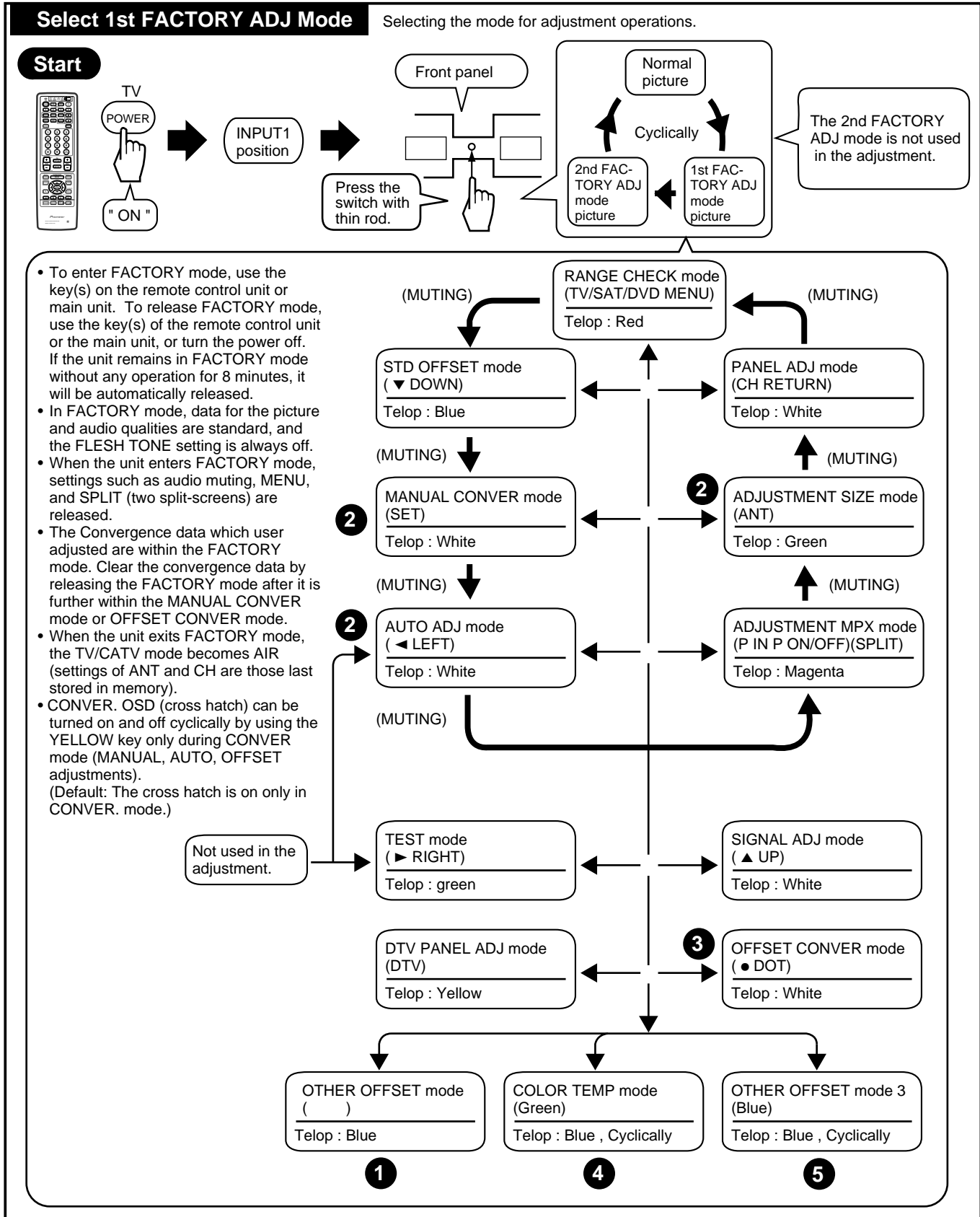

1 OTHER OFFSET mode

To enter the OFFSET mode of each picture quality, use the following keys and codes of the remote control unit:

		Key(s) on the Remote Control Unit
A	STD OFFSET MODE	DOWN
C	COMP (15 kHz) OFFSET MODE	P in P CH-, SUB CH-
D	COMP (31 kHz, 33 kHz) OFFSET MODE	P in P CH+, SUB CH+
B	TV OFFSET MODE	RED
V	COLOR TEMP B&W for STD	DTV MENU
L	COLOR TEMP FILM for STD & GAME	INFO
T	RGB OFFSET MODE	CH ENTER

2 The screen size modes change cyclically with each press of the SCREEN key as follows:

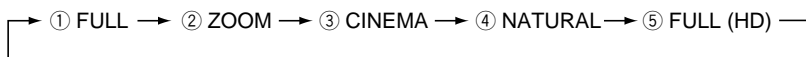

Note :The initial mode is always FULL.

3 The OFFSET CONVER. modes change cyclically with each press of the DOT key as follows:



Note :The initial mode is always OFFSET CONVER. MODE 1.

4 The offset data of the picture quality in COLOR TEMP mode change cyclically with each press of the GREEN key as follows:

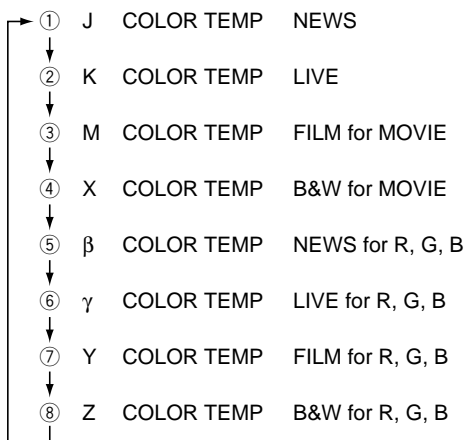

Note :The initial mode is always COLOR TEMP NEWS when the GREEN key is pressed.

5 The offset data of picture quality change cyclically with each press of the BLUE key as follows:

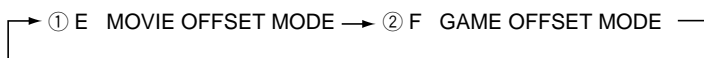

Note :The initial mode is always (1) when the BLUE key is pressed.

6.5 ADJUSTMENT

1 Brightness Adjustment

Start

1st FAC

Input signal : Black Burst (INPUT 1)

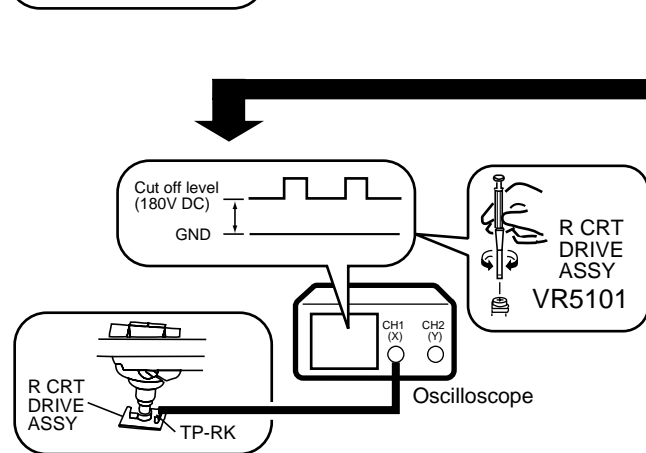
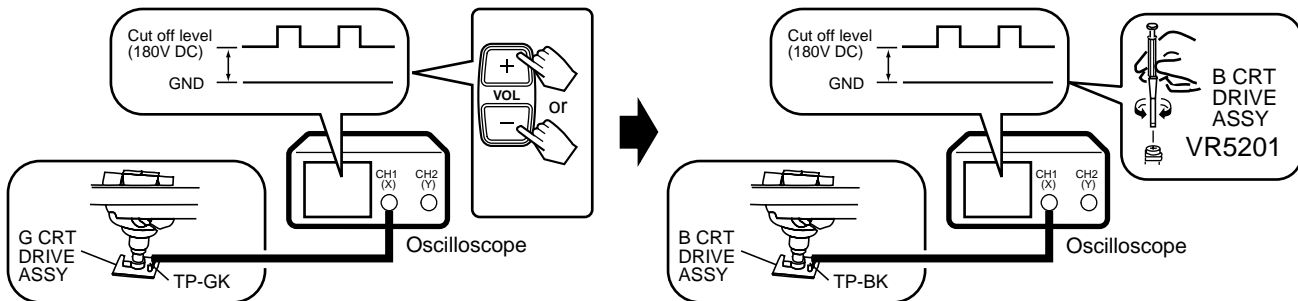
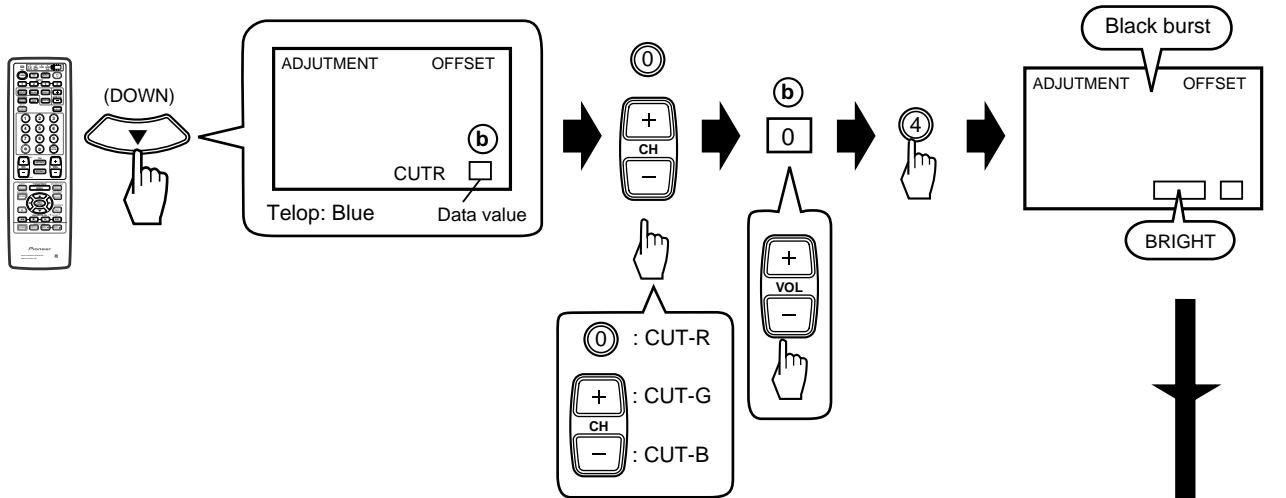

When the DEFLECTION SERVICE Assy or VIDEO Assy is replaced, check the following to confirm if the above adjustment is necessary:

- (1) Make a note of the data of CUT R, CUT G, CUT B, and BRIGHT. (1st FAC) (▼ DOWN)
- (2) Input "0" as parameters for (1) and check TP-RK, TP-GK and TP-BK of the CRT DRIVE assembly. If the levels are within $180\text{ V} \pm 5\text{ V}$, the adjustment is not necessary. Input the noted data. If the levels are not within the above level, proceed with the above adjustment.

2 Deflection Yoke Adjustment

2 -1 Deflection Yoke Lean Adjustment

Start

- Input a stable signal (e.g. from an LD player or SG) to the INPUT 1 connector.
- MENU → SETUP → Enter the MULTI-POINT (FULL) in the CONVERGENCE.
- The cross hatch disappears if there is no operation with the remote control unit for about 8 minutes. If the cross hatch disappears, repeat the above operation with the remote control unit.

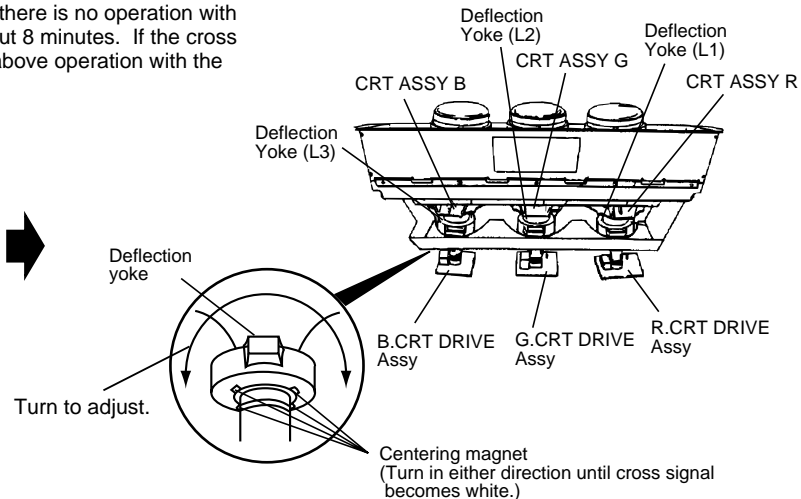
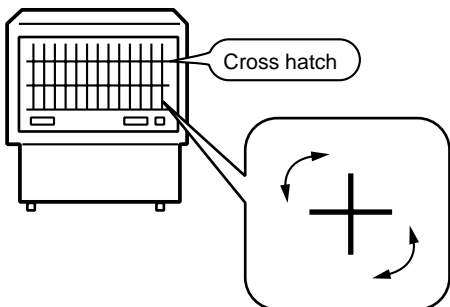

- Turn the deflection yoke of the replaced CRT so that the cross hatch of the color corresponding to the replaced CRT converges with that of the CRTs not replaced.
- When a CRT is replaced, check the position of the VM (Velocity Modulation) yoke.

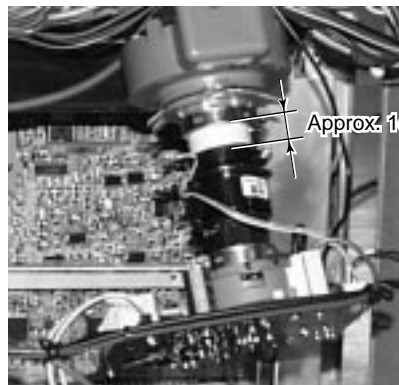

2 -2 Screen Center Adjustment

Start

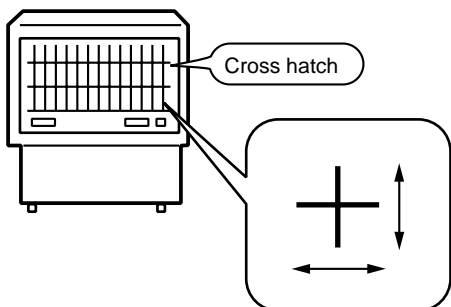

- Move the centering magnet of the deflection yoke for the replaced color so that the horizontal and vertical lines at the center of the screen align with the lines for a color not replaced.
- Secure the centering magnet from moving after adjustment is finished.

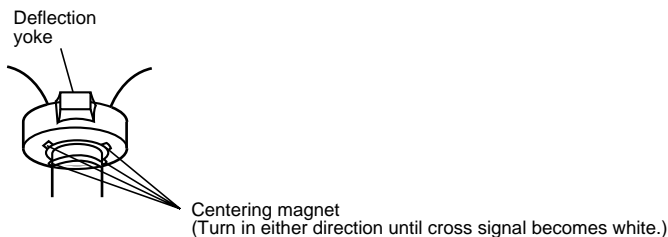

3 Focus Adjustment

3 -1 Focus Adjustment of Lens Assy

Start

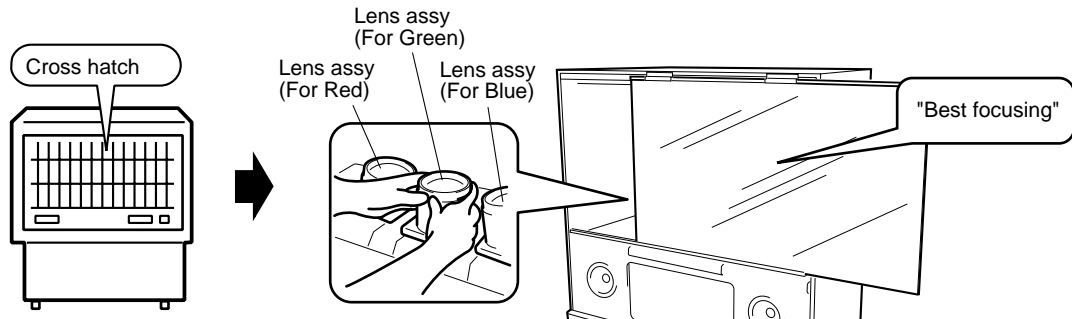

3 -2 Focus VR Adjustment

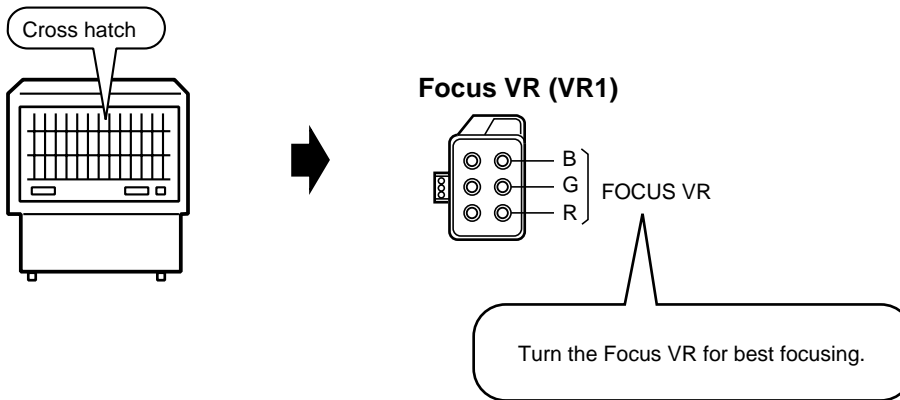

4 Test-cross Position Check

- Check the test-cross position. If it is located within ± 20 mm from the center of the screen, no adjustment is required. If it is not, adjust the position as follows:
- Input a stable NTSC (480i) signal (e.g. from an LD player) and adjust the position.

Start

MENU → SETUP → CONVERGENCE → FULL



<input type="checkbox"/>	SET UP
<input type="checkbox"/>	CHANNEL SET UP
<input checked="" type="checkbox"/>	CONVERGENCE
<input type="checkbox"/>	PROGRAM BLOCK
<input type="checkbox"/>	DPO:OFF
<input type="checkbox"/>	CHANGE PASSWORD
<input type="checkbox"/>	SYSTEM IN/OUT
<input type="checkbox"/>	DTV OUT:OFF
<input type="checkbox"/>	EXIT USE: END:

Notes:
 • The item of DTV OUT might not be displayed when the DTV BIB (built-in DTV tuner) is not connected.

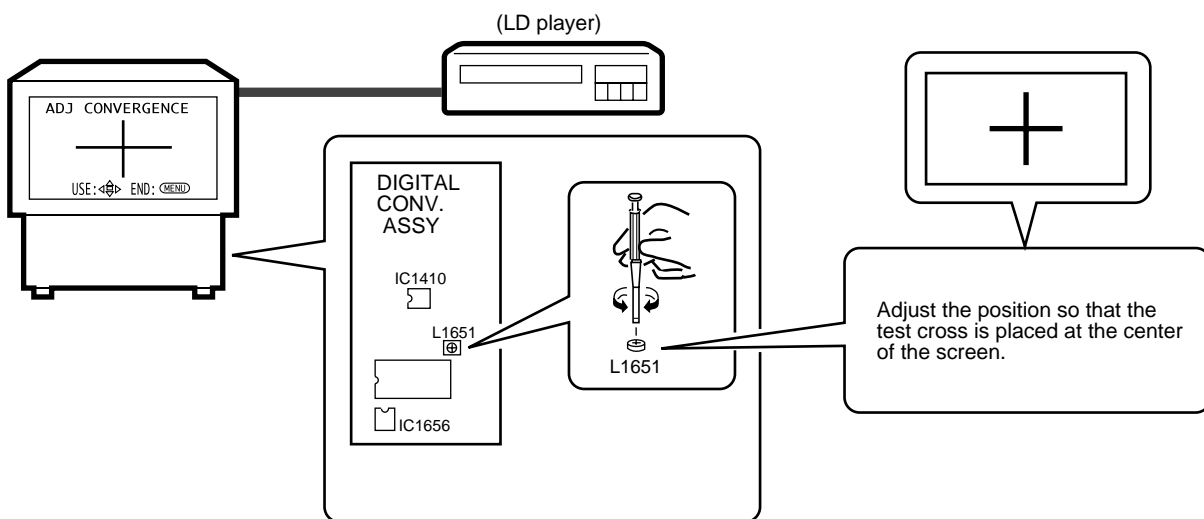

5 Screen Size Adjustment

Check if both vertical and horizontal sizes are within 91% ±2%. If they are not, perform the size adjustment as follows:

5 -1 Size Mode

Start 1st FAC

Note :
Screen mode : FULL

- Mode for roughly adjusting the horizontal and vertical sizes of the main deflection.
- In this mode, the color is green only, screen size is FULL and the contrast is +10.
- The above settings are cleared when this mode is exited.

a Data value
-128 to 126 (even data only)

b Size mode

Key No.	Function
1	H Size (15 kHz)
2	V Size
3	H PHA (15K)
6	H SIZE (33K) (fixed value D can be varied)
9	H PHA (31K RGB)
0	H PHA (33K RGB)
CH +	H PHA (31kHz)
CH -	H PHA (33kHz)

Note :

- The adjustment is unnecessary for D so that is set in factory shipment by the most suitable value. However, please adjust it when a screen is missed when displayed the HD source on the screen.
- For H PHA, refer to the section "• Reference."

Table on H SIZE and V SIZE data

Picture Quality Mode	H SIZE	V SIZE
NATURAL WIDE	A	B
CINEMA WIDE	A	B
ZOOM	A	B
FULL	A	B
FULL for HD	A+D	B

A, B : Adjustment values
D : Fixed values
A+D : Addition of A and D

- Perform the H SIZE and V SIZE adjustments only in FULL mode (NTSC MONOSCOPE signal input).
- Release the FACTORY mode, then change the screen mode and confirm that the picture is not missing.

The factory-preset values are as follows:

Key No.	PRO-610HD PRO-510HD	SD-582HD5 SD-532HD5
1 : H SIZE (15K)	Approx. 16 ± 30	Approx. 16 ± 30
2 : V SIZE	Approx. -50 ± 30	Approx. -50 ± 30
6 : H SIZE (33K)	Approx. 70 ± 30	Approx. 70 ± 30

Note: Varies depending on the factory-preset value.

5 -2 Vertical Size Adjustment

Start 1st FAC

Note :
Screen mode : FULL

INPUT 1: Monoscope

INPUT TV General broadcasting

Adjust the size so that the picture is completely displayed on the screen.

91% ± 2%

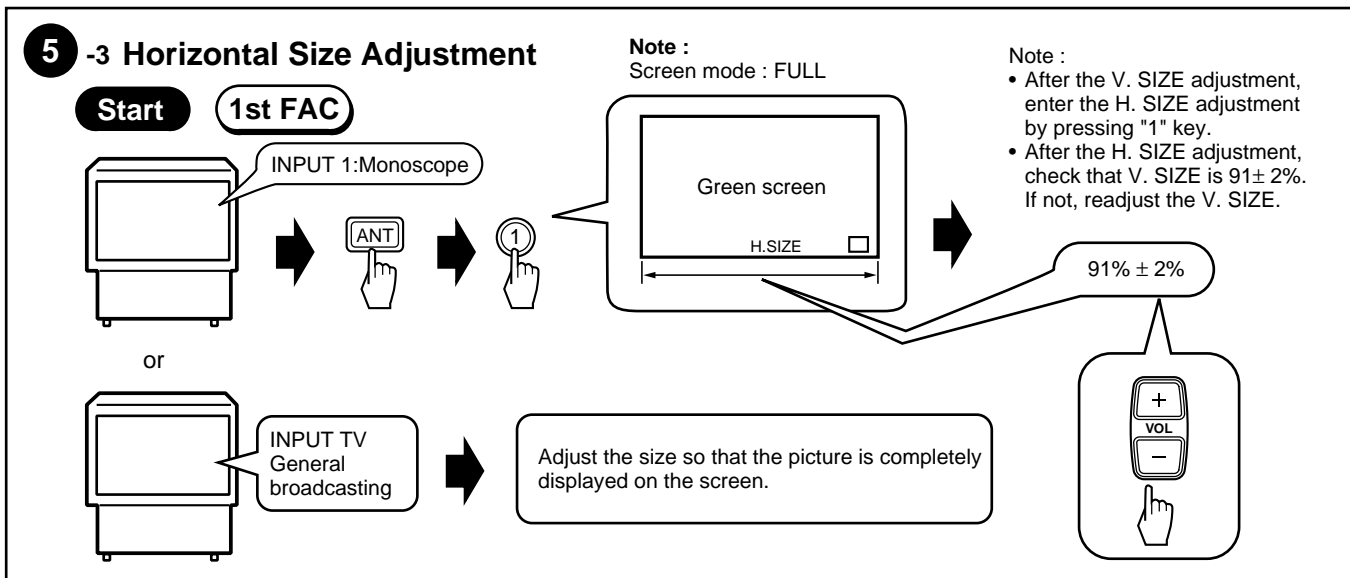

• Reference

The H PHASE adjustment is required if the left or right part of the screen becomes black, as illustrated below, depending on the format of the input signal (Ex. component 31.5 kHz, RGB 33K etc.).

Ex. Component 31K

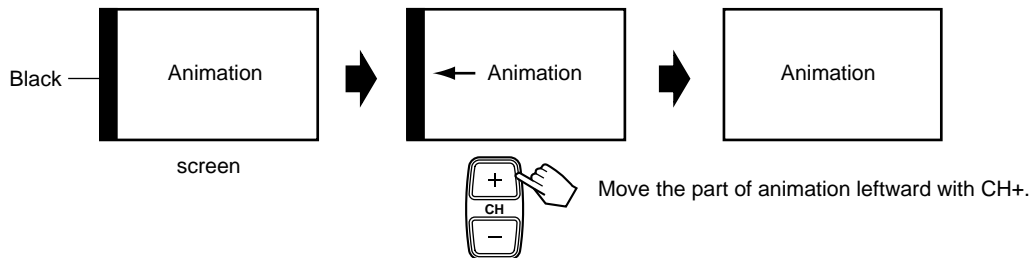

• About H. PHASE

In principle, adjustment of the data for the H. PHASE is not required.

Check whether the H. PHASE data are the factory-preset values, as indicated below:

Key No.	PRO-610HD PRO-510HD	SD-582HD5 SD-532HD5
3 : H PHA (15K)	80	80
CH+ : H PHA (31K)	36	40
CH- : H PHA (33K)	-14	-8
9 : H PHA (31K RGB)	26	30
0 : H PHA (33K RGB)	-26	-20

15K : CONPOSITE, S COMPONENT (480i)
31K : COMPONENT (480P)
33K : COMPONENT (1080i)

The screen moves to the right or the left if the above data are in variance. (See the above figures.)

Note :

H PHASE is set in factory shipment by the most suitable value. But, there is the case that screen is missed as an upper figure occurs by the signal format of other apparatus to be connected to.

A screen can be improved as the following by the readjustment. However, attention is necessary because in convenience may occur when connected to another apparatus.

6 CONVERGENCE ADJUSTMENT

1. Procedures

- When replacing the DIGITAL CONV. Assy, replace the EEPROM of new DIGITAL CONV. Assy with the EEPROM of old DIGITAL CONV. Assy.
- Check the initial data for the convergence adjustment.
- Perform the coarse adjustment for the green to roughly correct distortion of the green.
If necessary, repeat steps 3 and 4. Green adjustment is completed.
- Perform the coarse adjustment for the red by roughly converging the red with the green.
If necessary, repeat steps 5 and 6. Red adjustment is completed.
- Perform the coarse adjustment for the blue by roughly converging the blue with the green.
If necessary, repeat steps 7 and 8. Blue adjustment is completed.
- Display the green, red, and blue colors at the same time to check the convergence. Readjust the convergence if necessary.

2. Prior to Adjustment

There are five screen modes, and convergence adjustment is required for each mode. For adjustment, input the following video signal:

Table 1 Input signal

Screen mode	Input signal
1. FULL (FULL, 4:3 NORMAL)	NTSC (480i) signal
2. ZOOM (ZOOM)	
3. CINEMA (CINEMA WIDE)	
4. NATURAL (NATURAL WIDE)	
5. FULL for HD (HD/DTV)	HD/DTV (1080i) signal

NTSC : Stable signal source, such as an SG or an LD/DVD player
 HD : Stable signal source, such as an HD SG or a DTV tuner (SH-D09, etc.) Only PRO-610HD5/510HD5 can use the SH-D09.

When CRTs are replaced or when the deflection yoke is moved, perform the deflection yoke adjustment, horizontal and vertical size adjustments, and centering magnet adjustments before the convergence adjustment. (See Pages 201, 204 and 205)

3. Convergence Adjustment

3.1 Replacement of the EEPROMs inside the DIGITAL CONV. Assy

IC1410 24LC128P
 IC1656 24LC08B (I) P

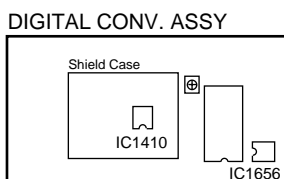

The data stored in the EEPROMs are as follows:

IC1410

- OFFSET CONVER. MODE 1 (DFH, DFV)
- OFFSET CONVER. MODE 3
- Factory-preset values for convergence
- User-adjusted values for convergence (CENTER, MULTI-POINT)

IC1656

- OFFSET CONVER. MODE 1 (HDP)
- OFFSET CONVER. MODE 2

3.2 Confirmation of convergence data

The convergence coarse adjustment modes change cyclically, as shown below, with each press of the DOT key in FACTORY mode:

Convergence coarse adjustment

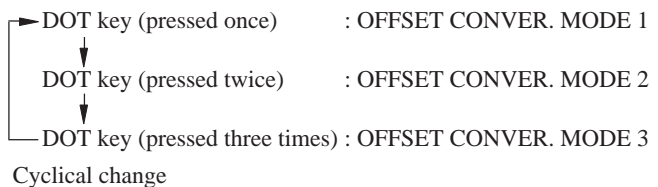

Check whether the data of MODE 1 and MODE 2 are as shown in Table 2.

The cross-hatch signal is generated inside the unit, and is automatically displayed in OFFSET CONVER. mode and MANUAL CONVERGENCE mode. You can turn on and off the cross-hatch signal with the YELLOW key.

Screen indication

Screen mode:
 F : FULL Z : ZOOM C : CINEMA
 N : NATURAL H : FULL for HD
 The Screen modes change cyclically with each press of the SCREEN mode key.

Adjustment items can be selected with the numeric keys. See Table 2.

Adjustment data:
 MAX ↑ 1FF
 100
 001
 CNT ● 000
 3FF
 2FF
 MIN ↓ 200
 Data can be adjusted with the VOL+ and VOL- keys.

Table 2 OFFSET CONVER DATA

OFFSET CONVER MODE 1						
Numeric Key	Adjustment Item	Screen Mode				
		F FULL	Z ZOOM	C CINEMA	N NATURAL	H HD FULL
1	DFH	0F0	0D0	0D0	0D0	100
2	DFV	070	070	070	070	070
3	HDP	010	010	010	010	010

OFFSET CONVER MODE 2						
Numeric Key	Adjustment Item	Screen Mode				
		F FULL	Z ZOOM	C CINEMA	N NATURAL	H HD FULL
1	HFP	0CC	0CC	0CC	0CC	0D0
2	HCP	00F	00F	00F	00F	015
3	HTP	047	047	047	047	044
4	HHD	0EE	0EE	0EE	0EE	0E9
5	HPW	00C	00C	00C	00C	00F
6	V1C	01F	029	025	022	01D
7	V1S	000	000	000	000	000
8	VFP	01D	02D	013	033	065

The above offset convergence values are common to the PRO-610HD/510HD and SD-582HD5/532HD5.

If the offset convergence values are as indicated in Table 2, proceed to 3.3. If the values are not the same, adjust the values with the numeric keys and VOL +/- keys.

Example:

To check HDP in ZOOM mode of OFFSET CONVER. MODE 1

- ① Enter the FACTORY mode.
- ② Enter the OFFSET CONVER. MODE 1 by pressing the DOT key once.
- ③ Enter the ZOOM screen mode by pressing the SCREEN mode key once. (When the unit enters FACTORY mode, the screen mode automatically becomes FULL.)
- ④ Check the indication on the screen by pressing the numeric key 3.

Indication at the bottom of the screen : Z HDP 010

If the adjustment value is 010, adjustment is not required.

If the adjustment value is other than 010, adjust with the VOL + or VOL- key so that the value becomes 010.

3.3 Coarse Adjustment of the Green

(Proceed with 3.3 and afterwards when the DIGITAL CONV. Assy is not replaced.)

Select adjustment items (STATIC and SIZE of vertical and horizontal lines, etc.) for each GH and GV, and adjust to roughly eliminate distortion. (For GV, peripheral pin distortion adjustment is necessary.)

Press the DOT key three times to enter OFFSET CONVER. MODE 3.

Press the SCREEN mode key and proceed with the adjustment for each screen mode.

The cross-hatch signal is generated inside the unit, and is automatically displayed in OFFSET CONVER. mode and MANUAL CONVERGENCE mode. You can turn on and off the cross-hatch signal with the YELLOW key.

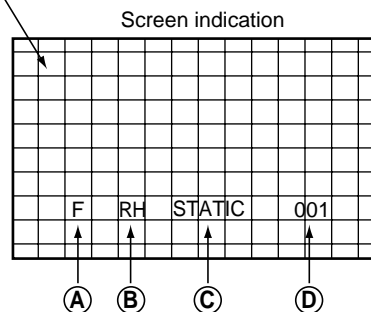

Ⓐ

Screen mode:

- F : FULL
- Z : ZOOM
- C : CINEMA
- N : NATURAL
- H : FULL for HD

The Screen modes change cyclically with each press of the SCREEN mode key.

Ⓑ

Cyclically changes with the CH+ or CH- key as follows:

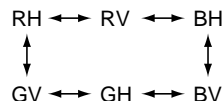

Ⓒ

Adjustment items can be selected with the numeric keys. See Table below.

• Waveforms adjustable in the coarse adjustment of the green

Numeric Key	GH	GV
0	STATIC	STATIC
1	SKEW	SKEW
6	/	PIN
8		SIZE

Ⓓ

Adjustment data:

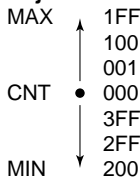

Data can be adjusted with the VOL+ and VOL- keys.

• Pattern for each adjustment item

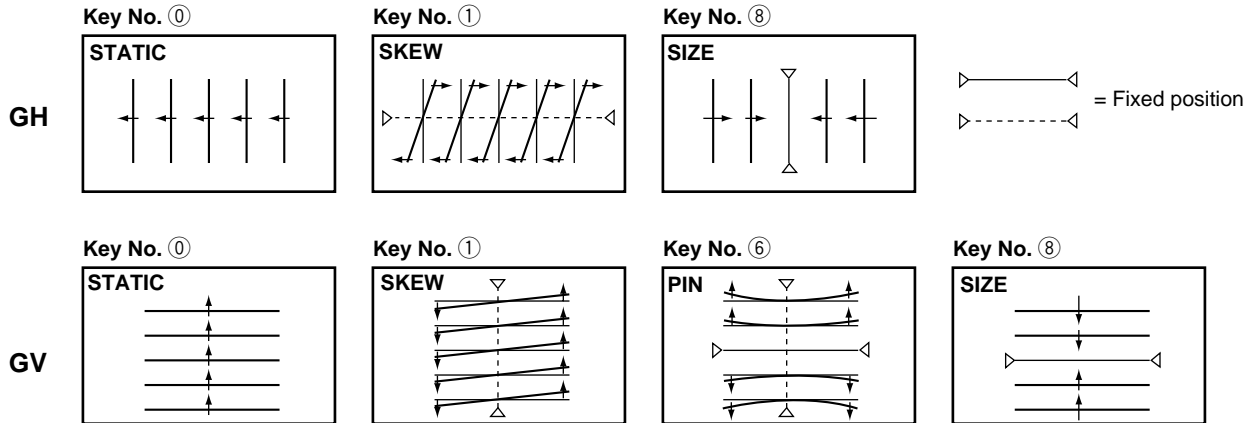

Note 1: When the green CRT is replaced, or when the deflection yoke for the green is replaced, prior to the convergence adjustment, tune the center of the image to the center of the screen by turning the centering magnet.

Note 2: When the CONVER. AMP Assy or DIGITAL CONV. Assy is replaced, make coarse adjustment as shown in 3.3 above.

3.4 Fine-adjustment of the Green

Enter MANUAL CONVERGENCE mode by pressing the SET/ENTER key, and make adjustments. Repeatedly make the coarse adjustment as shown in 3.3 if necessary. Proceed with the adjustment for each screen mode. Adjusted values for the green become the standard for the red and the blue.

3.4.1

In MANUAL CONVERGENCE mode entered by pressing the SET/ENTER key, the display becomes as shown below:

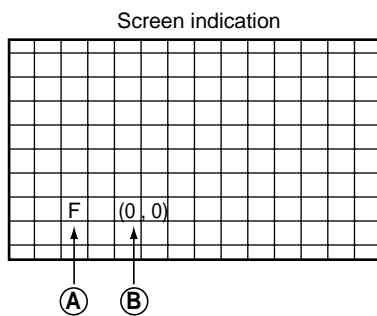

Ⓐ

Screen mode:

- F : FULL
- Z : ZOOM
- C : CINEMA
- N : NATURAL
- H : FULL for HD

The Screen modes change cyclically with each press of the SCREEN mode key.

Ⓑ

Coordinates where the cursor (adjustment point) is located

There are 72 adjustment points (8,9) on the coordinates for FULL, ZOOM, CINEMA, NATURAL and FULL for HD modes, but the coordinates actually used for adjustment are as follows (the coordinates outside the ranges indicated below are outside the screen, and adjustment will not have any effect on the screen):

- FULL : (0, 1) to (7, 9)
- ZOOM : (0, 1) to (7, 7)
- CINEMA : (0, 1) to (7, 8)
- NATURAL : (0, 1) to (7, 8)
- HD for FULL : (0, 1) to (7, 9)

(X, Y): X=abscissa, Y=ordinate

Some coordinates may be outside the screen and invisible.

The point at coordinates (0, 0) is at the upper left of the screen.

3.4.2

Move the cursor to a point to be adjusted with the cursor move keys.

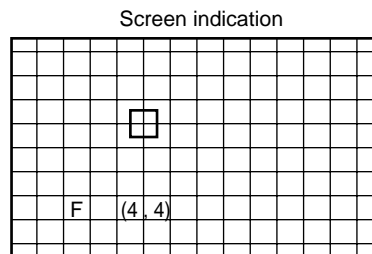

Note: The actual shape of the cursor is " []".

The position of the cursor in this figure is different from the actual position on the screen.

3.4.3

Press the SET/ENTER key when the point to be adjusted is determined.

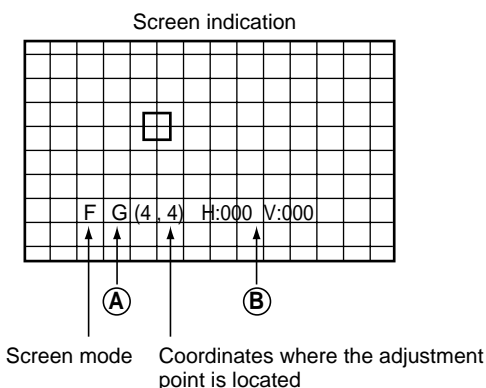

A

Color to be adjusted:

G: GREEN, R: RED, B: BLUE
 To change colors, use the CH+ or CH- key.
 The colors change cyclically as follows:
 With CH+ : R → B → G → R
 With CH- : R → G → B → R

B

H : *** Adjustment data in the horizontal direction
 V : *** Adjustment data in the vertical direction
 (***= hexadecimal number)

Data	MAX	↑	1FF
			100
			001
	CNT	●	000
			3FF
			2FF
	MIN	↓	200

For adjustment, move the Line to the desired direction with the cursor keys.

- To move the Horizontal Line upward, press the "▲" key. (The value decreases.)
- To move the Horizontal Line downward, press the "▼" key. (The value increases.)
- To move the Vertical Line to the left, press the "◀" key. (The value decreases.)
- To move the Vertical Line to the right, press the "▶" key. (The value increases.)

- To select one color, use the SEARCH key for the red, SELECT key for the green, FREEZE key for the blue. Pressing this key toggles color muting on or off.
- To mute all the colors, press the DISPLAY key. To release muting, press the SEARCH, SELECT, or FREEZE key.
- To erase the cross hatch, press the YELLOW key. Pressing this key toggles between display of the cross hatch screen and the input screen.
- To change the brightness of the input screen, use the VOL+ or VOL- key. The brightness increases with the VOL+ key (CONTRAST +10) and decreases with the VOL- key (CONTRAST -40). (The brightness can be changed only in Fine-adjustment mode. The brightness of the cross hatch screen cannot be changed.)

3.4.4

When adjustment of the selected point is finished, press the SET/ENTER key, then adjust the other adjustment points by repeating 3.4.1 to 3.4.4.

3.4.5

Make the adjustment for the green in each screen mode, and use the green as the standard screen for the red and the blue. To change screen modes, use the SCREEN mode key.

Note: Some coordinates for adjustment points are located outside the screen. Be sure not to make adjustments on those points, because adjustment of those coordinates will have little effect on the screen.

● Adjustment Technique

1st step

Adjust so that the vertical and horizontal lines forming a cross at the center of the screen become straight. Check also the screen size and the linearity of the horizontal and vertical lines.

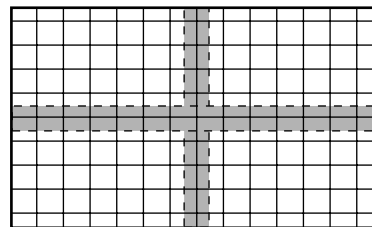

- See "3.3 Coarse adjustment of the green."
Adjust GH STATIC, SKEW and SIZE, and GV STATIC, SKEW, PIN and SIZE to correct the screen location, tilt, screen information volume, and peripheral pin distortion.
- See "3.4 Fine-adjustment of the green."
Fine-adjust the linearity of the vertical and horizontal lines forming a cross at the center of the screen.

Note: In principle, only the selected point is changed in MANUAL CONVER. mode. However, as the adjusted data (amount of adjustment) increase, peripheral points may be affected. So be sure not to greatly change the adjustment data of one point, but change peripheral points at the same time. See the examples below.

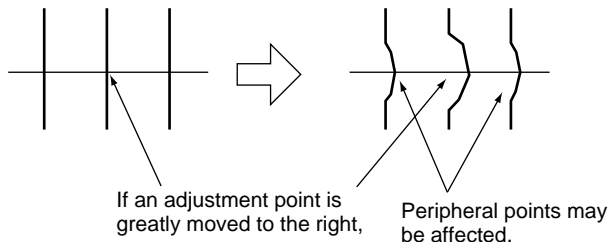

In a case of an error in convergence:

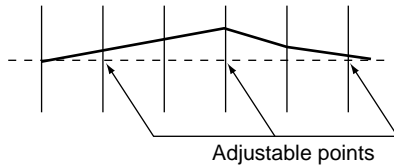

Good adjustment:

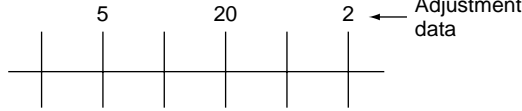

Bad adjustment:

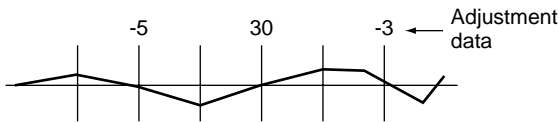

2nd step

Adjust so that the vertical lines become straight, taking care to preserve proper screen information volume and the linearity. Adjust the right half of the screen first, then the left half. (See 3.4.)

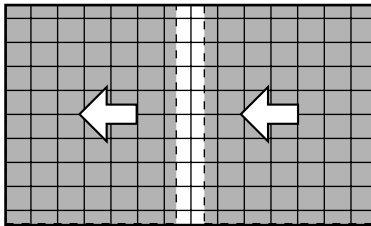

Right half : Adjust from the edge toward the center.
Left half : Adjust from the center toward the edge.

3rd step

Adjust so that the horizontal lines become straight. Adjust the upper half of the screen first, then the lower half. (See 3.4.)

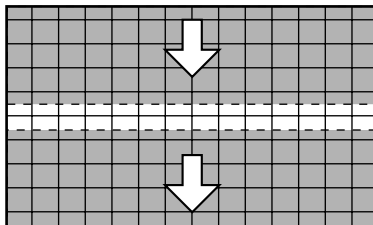

Upper half : Adjust from the edge toward the center.
Lower half : Adjust from the center toward the edge.

4th step

Repeat 2nd and 3rd steps to take total balance. Then the adjustment for the green is completed. To return from the fine adjustment mode to the coarse adjustment mode, press the MENU key once, then the DOT key.

Note: When the MENU key is pressed to quit MANUAL CONVERGENCE mode, the display will be unstable for several seconds. This is because the adjustment data are being written to the EEPROMs, and is not a malfunction. Do not perform any operation (power on/off, or pressing keys on the remote control unit or on the main unit, etc.) during this period, because doing so may affect your adjustment data.

3.5 Coarse Adjustment of the Red

After the green adjustment is completed, quit MANUAL CONVERGENCE mode by pressing the MENU or MUTING key, then press the DOT key three times to enter OFFSET CONVER. MODE 3.

Select adjustment items for RH and RV, and roughly correct distortion to converge with the green. Adjustment is required for each screen mode

For adjustable items of the red and the blue, see the following table.

Numeric Key	RH	RV	BH	BV
0	STATIC	STATIC	STATIC	STATIC
1	SKEW	SKEW	SKEW	SKEW
4	/	KEY	/	KEY
6	/	PIN	/	PIN
7	LIN	/	LIN	/
8	SIZE	SIZE	SIZE	SIZE

• Pattern for each adjustment item

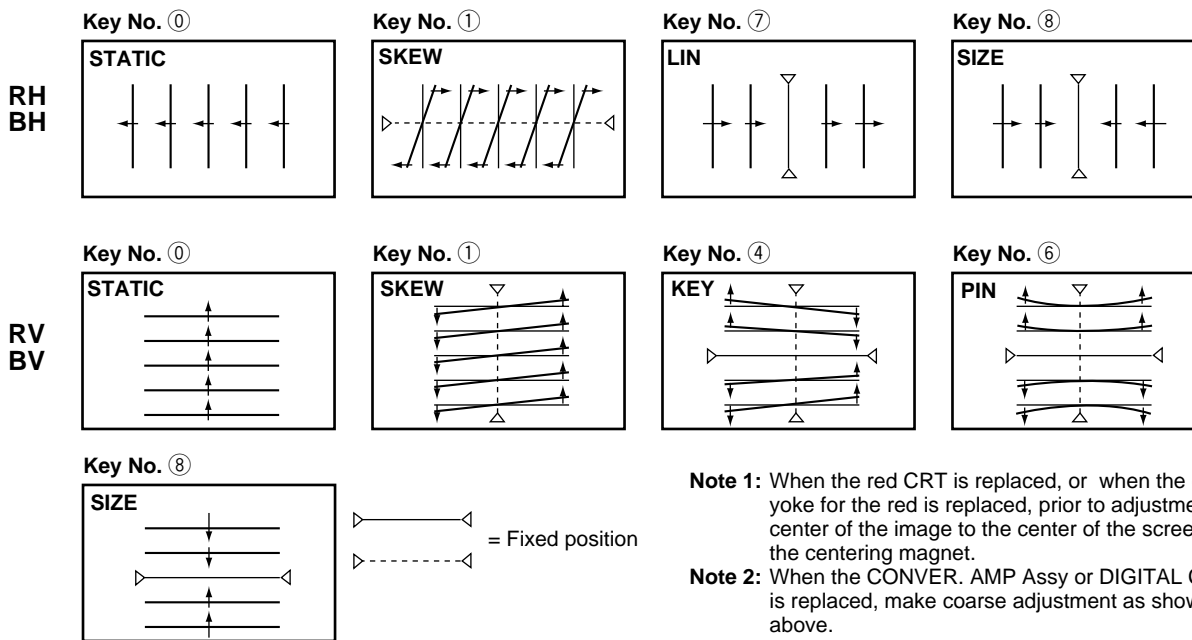

Note 1: When the red CRT is replaced, or when the deflection yoke for the red is replaced, prior to adjustment, tune the center of the image to the center of the screen by turning the centering magnet.

Note 2: When the CONVER. AMP Assy or DIGITAL CONV. Assy is replaced, make coarse adjustment as shown in 3.5 above.

3.6 Fine-adjustment of the Red

To fine-adjust the red, press the SET/ENTER key to enter MANUAL CONVERGENCE mode. Repeat the coarse adjustment described in "3.5 Coarse Adjustment of the Red" if necessary. Make adjustment for each SCREEN mode, and eliminate distortion to converge with the green.

3.6.1

Press the SET/ENTER key to enter MANUAL CONVERGENCE mode, and make adjustment in the same manner as with the green. First, adjust the vertical and horizontal the red lines at the center of the screen so that they converge with the green center lines.

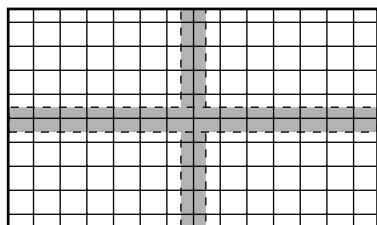

3.6.2

Adjust the red vertical lines so that they converge with the green vertical lines. Proceed to adjustment of the right half of the screen, then the left half. Adjustment should be done from the part where convergence is greatly dislocated.

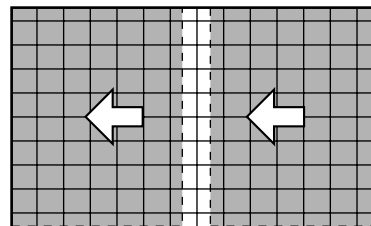

3.6.3

Adjust the red horizontal lines so that they converge with the green horizontal lines. Proceed to adjustment of the upper half of the screen, then the lower half. Adjustment should be done from the part where convergence is greatly dislocated.

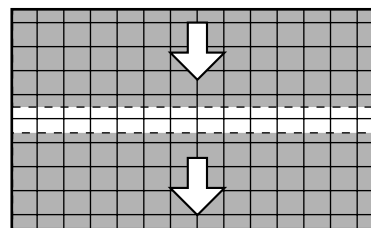

3.6.4

Repeat the adjustments described in 3.6.2 and 3.6.3 so that all the red vertical and horizontal lines converge with the green lines. (Completion of one screen mode)

3.6.5

Repeat procedures 3.6.2 through 3.6.4 for the other screen modes.
(Completion of the red adjustment)

3.7 Coarse Adjustment and Fine Adjustment of the Blue

Make coarse and fine-adjustments of the blue in the same manner as with the red, described in 3.5 and 3.6.

3.8 Confirmation of Adjustment

After the green, red, and blue adjustments are finished, check convergence errors with the patterns for all three colors on the monitor.

Check the patterns in all SCREEN modes, and if any error in convergence is recognized, readjust convergence in MANUAL CONVER. mode.

Note: Be sure NOT to change the green pattern during readjustment.

IMPORTANT!

(1) When all the adjustments are completed, or when adjustment should be temporarily interrupted, adjustment data must be written to the EEPROM, in the following manner:

When all the adjustments are completed, or to interrupt adjustment, press the MENU key to quit Convergence Adjustment mode. The display will be unstable for several seconds, but this is because the data are being written to the EEPROM. Wait without doing anything until the display becomes stable, which means writing of data to the EEPROM is finished.

If the power of the TV is turned off (standby) during Convergence Adjustment mode (coarse and fine-adjustments), turn on the TV, enter FACTORY mode, and enter Convergence Adjustment mode by pressing the SET/ENTER key. Then press the MENU key. The data will be written to the EEPROM as described above.

(2) Do NOT turn off the main power during or after convergence adjustment.

If you do so, the adjusted data may be lost. If the data are lost, you must make all the adjustments again.

(3) When the CENTER POINT (test cross) or MULTI-POINT (user convergence) adjustments have been made by a user, and if the unit enters FACTORY Convergence Adjustment mode (with the DOT and SET/ENTER keys), the user's adjustment data will be all cleared and returned to the factory-preset values.

Be sure NOT to enter this Convergence Adjustment mode except when a repair related to convergence or a repair that requires convergence adjustment later, is needed.

If you inadvertently enter Convergence Adjustment mode, readjust the convergence.

7 White Balance Adjustment

7 -1 Contrast Adjustment

Start **1st FAC**

"Color Bar"

Adjust the screen to optimum condition.

At the TP-BK of the B CRT DRIVE Assy, check that the signal is shaped as shown below.

Shapely waveform Shapeless waveform Saturated

ADJUSTMENT OFFSET

CONTR

"Normal video signal"

After the STD adjustment is complete, adjust the COMP 15K, COMP 31K, 33K RGB, COLOR TEMP FILM or STD and COLOR TEMP B&W for STD.

7 -2 White Balance Adjustment This mode is to set the standard picture quality for a normal picture.

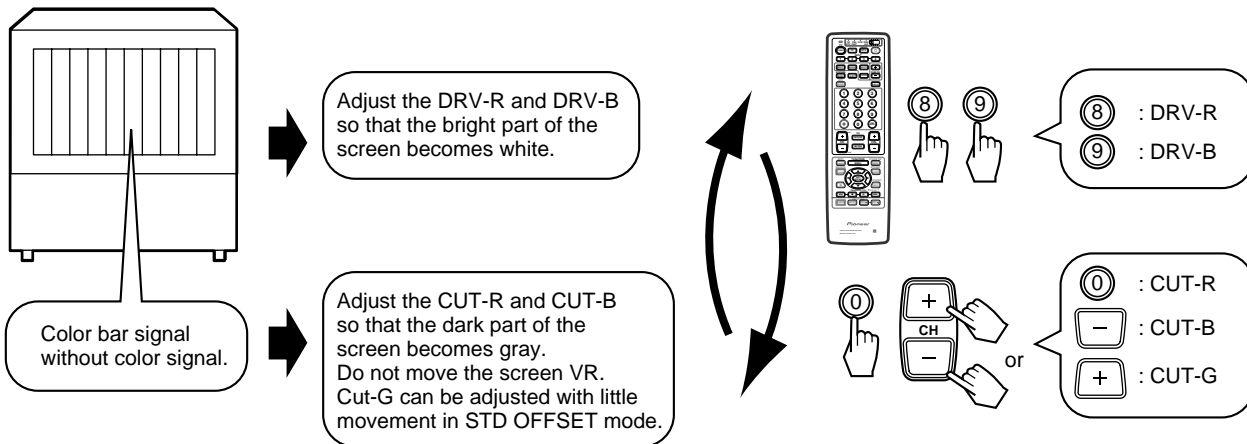
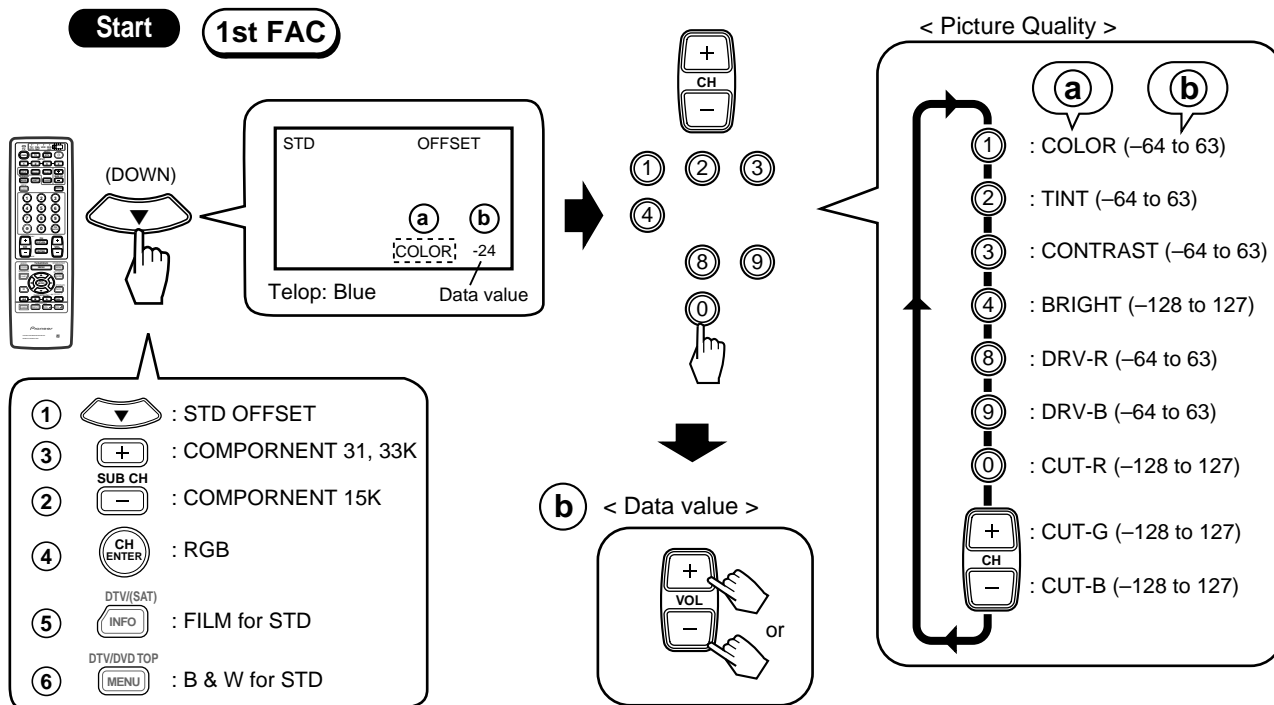

Note :
Not all adjustments described above can be made for COLOR TEMP FILM for STD and COLOR TEMP B&W for STD. Refer to the following adjustment procedure.

● Adjustment Procedure of White Balance

OFFSET Data Table

COLOR TEMP Setting	Without RGB Input							RGB Input			
	STD	NEWS	LIVE	FILM STD	FILM MOVIE	B&W STD	B&W MOVIE	NEWS	LIVE	FILM	B&W
	I	J	K	L	M	V	X	β	γ	Y	Z
User Mode	MOVIE			GAME							
	E			F							
Input Signal	TV	COMPONENT 15K		COMPONENT 31K 33K			RGB				
	B	C		D			T				
	STD OFFSET										
	A										

Adjustments are required for A, C, D, T, L, and V in the table above. Data in other parts are fixed. (I="0")
 Proceed with the adjustments in the following order:

Adjustment	Direct key	Picture quality data on the screen	} Make adjustment only for items described as ADJ in the following table. Do NOT change other data. Other data are adjusted in factory shipment by Fix data of the following table . (refer to page 215.)
(1) STD OFFSET	DOWN	A	
(2) COMPONENT 15K	SUB CH-	A+C	
(3) COMPONENT 31, 33K	SUB CH+	A+D	
(4) RGB	CH ENTER	A+T	
(5) FILM for STD	INFO	A+L	
(6) B&W for STD	DTV MENU	A+V	Adjustment of V

- First, perform "(1) STD OFFSET", then perform adjustments (2), (3) and (4) so that the same picture quality (color temperature) as achieved in (1) is obtained.
- In adjustment (5), make the whole picture more reddish than in (1), and in adjustment (6), make it more reddish.
- When readjusting, once "(1) STD OFFSET" is adjusted, the data for other input signals (component, etc.) revert to the factory-preset values, in principle.
- After the adjustment of STD OFFSET is completed, check other picture quality modes by switching color temperatures and signals. It is OK if picture quality does not deviate greatly when input signal is changed (composite, component 15K, etc.). Furthermore, it is OK if color temperature changes when color temperature is changed. With this model, five color temperature switching modes are provided. In FILM and B&W modes, a white part appears to be reddish in general because of their color temperature settings.

7 -3 Color/Tint Adjustment

Start

1st FAC

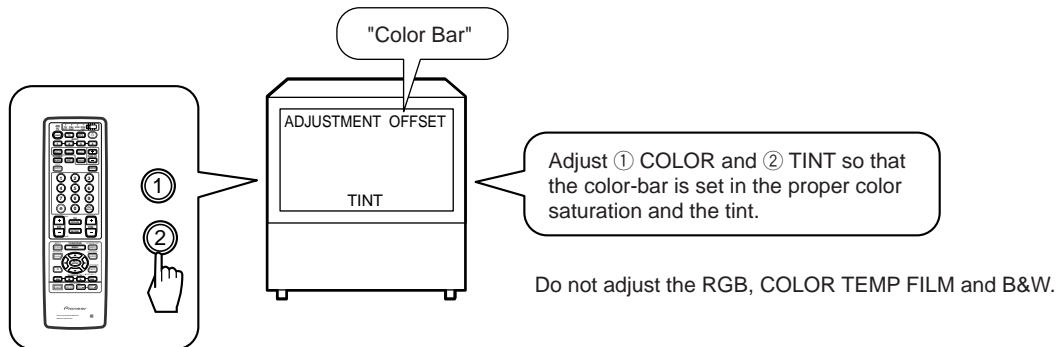

OFFSET DATA (VIDEO)

ADJ: Adjustment item

The numerical value is shipping a set value in the factory.

A set value is data of 1999.11 present provinces.

DIRECT KEY			
OFFSET MODE		MODEL	
KEY	ADJ NAME	PRO-610HD PRO-510HD	SD-582HD5 SD-532HD5
DOWN			
STD OFFSET A			
1	COLOR	ADJ	ADJ
2	TINT	ADJ	ADJ
3	CONTRAST	ADJ	ADJ
4	BRIGHT	ADJ	ADJ
5	SHARPNESS	0	0
6	DETAIL	-50	-15
7	S. V. M	0	0
8	R DRV	ADJ	ADJ
9	B DRV	ADJ	ADJ
0	R CUT	ADJ	ADJ
CH+	G CUT	ADJ	ADJ
CH-	B CUT	ADJ	ADJ
SUB CH -			
COMPONENT 15K C			
1	COLOR	ADJ	ADJ
2	TINT	ADJ	ADJ
3	CONTRAST	ADJ	ADJ
4	BRIGHT	0	0
5	SHARPNESS	0	0
6	DETAIL	0	0
7	S. V. M	0	0
8	R DRV	ADJ	ADJ
9	B DRV	ADJ	ADJ
0	R CUT	ADJ	ADJ
CH+	G CUT	ADJ	ADJ
CH-	B CUT	ADJ	ADJ
SUB CH+			
COMPONENT 31, 33K D			
1	COLOR	ADJ	ADJ
2	TINT	ADJ	ADJ
3	CONTRAST	ADJ	ADJ
4	BRIGHT	0	0
5	SHARPNESS	-20	-20
6	DETAIL	92	127
7	S. V. M	0	0
8	R DRV	ADJ	ADJ
9	B DRV	ADJ	ADJ
0	R CUT	ADJ	ADJ
CH+	G CUT	ADJ	ADJ
CH-	B CUT	ADJ	ADJ
RED			
TV OFFSET B			
1	COLOR	-10	-10
2	TINT	0	0
3	CONTRAST	0	0
4	BRIGHT	0	0
5	SHARPNESS	0	0

DIRECT KEY			
OFFSET MODE		MODEL	
KEY	ADJ NAME	PRO-610HD PRO-510HD	SD-582HD5 SD-532HD5
BLUE (cyclically)			
MOVIE OFFSET E			
1	COLOR	-11	-30
2	TINT	-13	-11
3	CONTRAST	-27	-14
4	BRIGHT	0	0
5	SHARPNESS	-20	-20
6	DETAIL	30	30
8	R DRV	1	-2
9	B DRV	4	6
0	R CUT	-5	8
CH+	G CUT	-3	5
CH-	B CUT	-3	4
GAME OFFSET F			
1	COLOR	0	0
2	TINT	0	0
3	CONTRAST	-43	-28
4	BRIGHT	0	0
5	SHARPNESS	-35	-35
6	DETAIL	0	0
8	R DRV	0	3
9	B DRV	8	7
0	R CUT	4	13
CH+	G CUT	7	13
CH-	B CUT	3	11
CH ENTER			
RGB OFFSET T			
3	CONTRAST	ADJ	ADJ
4	BRIGHT	ADJ	ADJ
8	R DRV	ADJ	ADJ
9	B DRV	ADJ	ADJ
0	R CUT	ADJ	ADJ
CH+	G CUT	ADJ	ADJ
CH-	B CUT	ADJ	ADJ
INFO			
COLOR TEMP FILM for STD L			
3	CONTRAST	ADJ	ADJ
8	R DRV	ADJ	ADJ
9	B DRV	ADJ	ADJ
0	R CUT	ADJ	ADJ
CH+	G CUT	ADJ	ADJ
CH-	B CUT	ADJ	ADJ
DTV MENU			
COLOR TEMP B&W for STD V			
3	CONTRAST	ADJ	ADJ
8	R DRV	ADJ	ADJ
9	B DRV	ADJ	ADJ
0	R CUT	ADJ	ADJ
CH+	G CUT	ADJ	ADJ
CH-	B CUT	ADJ	ADJ

DIRECT KEY			
OFFSET MODE		MODEL	
KEY	ADJ NAME	PRO-610HD PRO-510HD	SD-582HD5 SD-532HD5
GREEN (cyclically)			
COLOR TEMP NEWS for STD J			
3	CONTRAST	-6	-6
8	R DRV	-1	-1
9	B DRV	16	16
0	R CUT	3	3
CH+	G CUT	3	3
CH-	B CUT	1	1
COLOR TEMP LIVE for STD K			
3	CONTRAST	-1	-1
8	R DRV	-5	-5
9	B DRV	7	7
0	R CUT	2	2
CH+	G CUT	3	3
CH-	B CUT	1	1
COLOR TEMP FILM for MOVIE M			
3	CONTRAST	0	0
8	R DRV	9	1
9	B DRV	-10	-15
0	R CUT	-1	0
CH+	G CUT	0	0
CH-	B CUT	1	0
COLOR TEMP B&W for MOVIE X			
3	CONTRAST	-1	0
8	R DRV	15	6
9	B DRV	-17	-22
0	R CUT	1	1
CH+	G CUT	2	2
CH-	B CUT	3	1
GREEN (cyclically)			
COLOR TEMP NEWS for RGB β			
3	CONTRAST	-6	-6
4	BRIGHT	0	0
8	R DRV	-1	-1
9	B DRV	16	16
0	R CUT	3	3
CH+	G CUT	3	3
CH-	B CUT	1	1
COLOR TEMP LIVE for RGB γ			
3	CONTRAST	-1	-1
4	BRIGHT	0	0
8	R DRV	-5	-5
9	B DRV	7	7
0	R CUT	2	2
CH+	G CUT	3	3
CH-	B CUT	1	1
COLOR TEMP FILM for RGB Y			
3	CONTRAST	-1	-1
4	BRIGHT	0	0
8	R DRV	14	14
9	B DRV	-10	-10
0	R CUT	1	1
CH+	G CUT	3	3
CH-	B CUT	4	4
COLOR TEMP B&W for RGB Z			
3	CONTRAST	-1	-1
4	BRIGHT	0	0
8	R DRV	18	18
9	B DRV	-17	-17
0	R CUT	-1	-1
CH+	G CUT	2	2
CH-	B CUT	4	4

8 Panel Adjustment

Start

1st FAC

- Mode for adjusting the brightness, contrast LEFT and RIGHT of the gray part (panel) of the 4:3 normal screen.

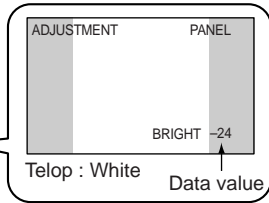

<Data value section>

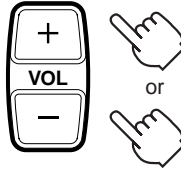

<Adjustment item section>

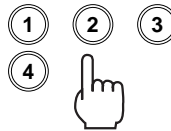

- ① : BRIGHT (-64 to 63)
- ② : CONTRAST (-64 to 63)
- ③ : LEFT (-128 to 127)
- ④ : RIGHT (-128 to 127)

Procedures

- Send the black-burst signal to the INPUT 1 connector.
Enter Adjustment mode by following the procedures described above.
- With BRIGHT, adjust the gray part (panel) of the screen.
By observing TP5151 of the GREEN CRT DRIVE assembly with the oscilloscope, adjust the brightness level which is low by 20V from Black level of the main screen.

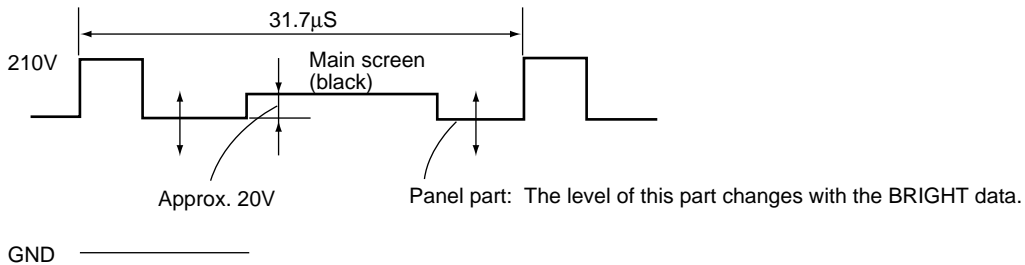

- Switch the input signal to a 100%-white signal.
Adjust the panel part and the main screen with CONTRAST.
Observe the same site as described in Step ② above, and adjust the amplitude of the luminosity.

Adjust so that the level of the luminosity of the panel and that of the main screen become the same.

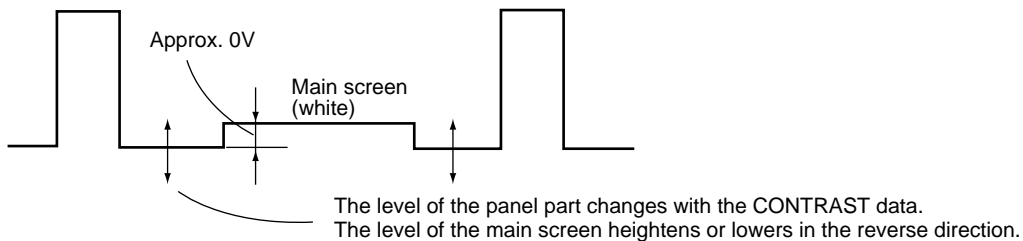

● Size Adjustment of the Panel Part of the 4:3 Normal Screen

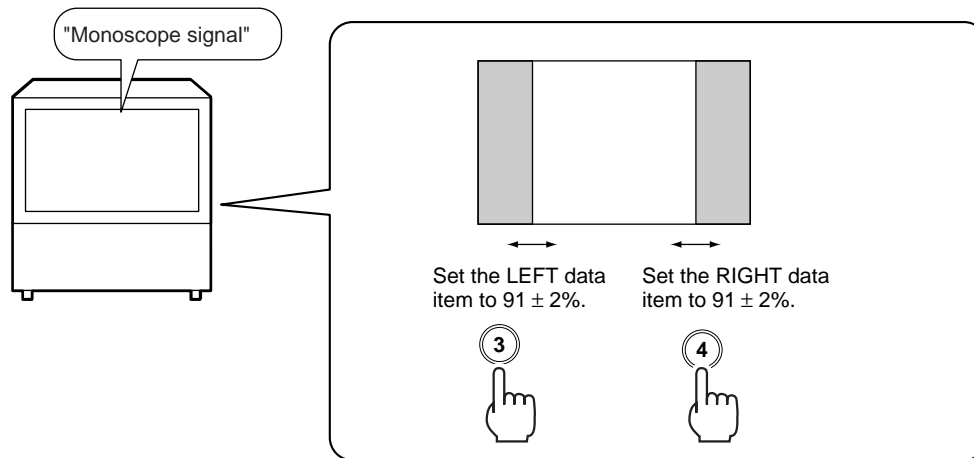

9 Panel Adjustment for DTV (PRO-610HD, PRO-510HD ONLY)

Start

1st FAC

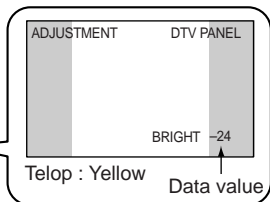

• Mode for adjusting the brightness, contrast LEFT and RIGHT of the gray part (panel) of the 4:3 normal screen of the DTV tuner.

<Data value section>

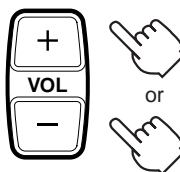

<Adjustment item section>

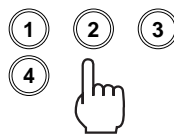

- ① : BRIGHT (-64 to 63)
- ② : CONTRAST (-64 to 63)
- ③ : LEFT (-128 to 127)
- ④ : RIGHT (-128 to 127)

Note :

- Adjustment required only for the PRO-510HD/610HD to which a BIB (SH-D07/D09) can be connected.
- No adjustment is needed for the SD-582HD5/532HD5.
- The adjustment procedures are the same as those described in "8 Panel Adjustment," except for the following:
- Send the black burst of the HD signal to the INPUT 1 connector.
- Send a 70%-white (if not available, 100%-white) HD signal to the INPUT 1 connector.
- As for the size adjustment, adjust so that the panel size becomes the same as that adjusted in "8 Panel Adjustment."

7. GENERAL INFORMATION

7.1 DIAGNOSIS

7.1.1 DIAGNOSIS METHOD

Various protection circuits are provided for this unit. When these protection circuits are activated, the power of the unit is shut down (P.D.: Power Down).

The defective parts can be easily diagnosed by observing the LEDs inside the following assemblies.

1. POWER SUPPLY Assy
 For models PRO-610HD/510HD : D915 in the AWV1795
 For models SD-582HD5/532HD5 : D915 in the AWV1808
2. DEFLECTION SERVICE Assy
 Common to all models : D321 in the AWV1796
 For service assembly : D321 in the AWV1809
3. CONV. AMP Assy
 Common to all models : D923 in the AWZ6456

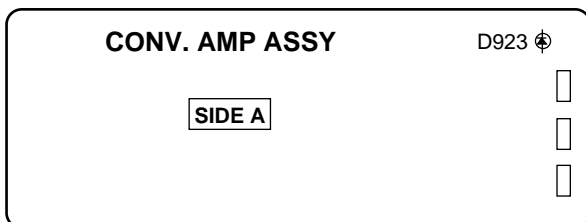
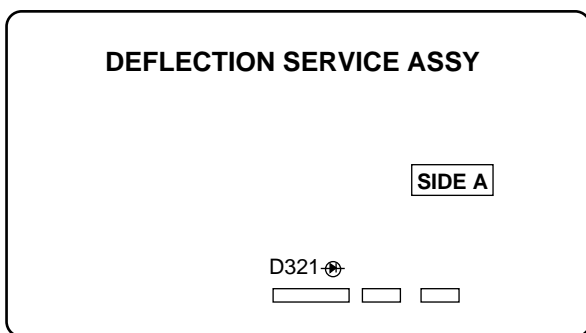
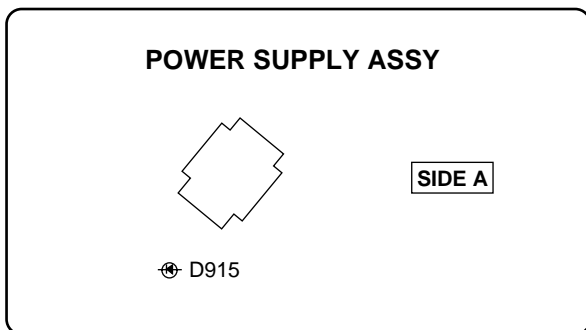

LED points

How to diagnose a failure

The D915 LED of the POWER SUPPLY Assy always lights up when the power is turned off because of the protection circuits (P.D.).

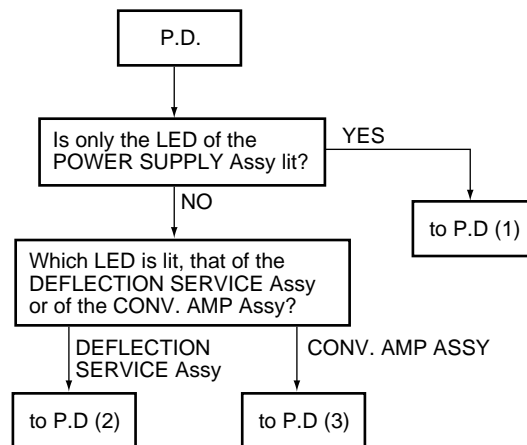

PRO-610HD, PRO-510HD, SD-582HD5, SD-532HD5

1. P.D. (1)

Failure in the POWER SUPPLY Assy and the AUDIO Assy.

There are four main possibilities:

1. Abnormality in the regulator of the heater
2. Blown fuse(s) in secondary
3. Abnormality in RELAY (RY102)
4. Abnormality in AUDIO OUTPUT

Status	Causes	Check Items	Probable Defective Parts
D223 ANODE Hi	Abnormality in the regulator for the heater	The voltage of HT- at TP205 is NOT approx. 19 V, and that of the HT+ at TP204 is NOT approx. 26 V.	Q201, R202, D210, D209
D207 ANODE Hi	Blown fuse(s)	The voltage HT+ (approx. 26 V) at TP204 is NOT supplied.	CONV. AMP Assy and DEFLECTION SERVICE Assy
		The voltage (approx. 35 V) at TP203 is NOT supplied.	AUDIO Assy
		The voltage (approx. 11 V) at TP209 is NOT supplied.	VIDEO Assy
D911 ANODE Hi	Abnormality in RELAY	The RELAY signal is NOT high (ON) at TP904.	SIGNAL Assy
		P.D. even if the RELAY signal is high (ON) at TP904.	Q904, Q905 RY102, R102
D203 ANODE Hi	Abnormality in AUDIO OUTPUT	The SP line (CN5611) is disconnected.	Connect the SP line.
		The voltage at the negative electrode of the C5616 and C5617 is 5.2 V or more.	C5616, C5617 (VIDEO Assy)

Note: The anode of the diode is high only for a short time after the power is turned on until the protection circuits are activated (P.D.) The LEDs are lit by the HOLD circuit.

In a case when the power cannot be on with no LED lit, check the following:

1. Check if the FU101 fuse in the POWER SUPPLY Assy is blown.
2. Disconnect and check connector E1 (CN201) to see whether STB 5 V is supplied.
If STB 5 V is supplied, replace the SIGNAL Assy. If STB 5 V is NOT supplied, replace the POWER SUPPLY Assy.
3. Disconnect and check connector E1 (CN201) to see whether AC CLK is supplied.
If AC CLK is supplied, replace the SIGNAL Assy. If AC CLK is NOT supplied, replace the POWER SUPPLY Assy.

2. P.D. (2)

Failure in the DEFLECTION SERVICE Assy.

There are four main possibilities:

1. H. deflection overload detection (1)
2. H. deflection stopping detection
3. H. deflection overload detection (2)
4. X-ray protection

Status	Causes	Check Items	Probable Defective Parts
D312 ANODE Hi	Overload detection 1		Q309, Q324 (short-circuited between C and E)
D309 ANODE Hi	Stopping H. deflection	Is the connector of the deflection yoke plugged in?	Plug in the connector.
		No H. OSC signal at TP304 (F=31.5 kHz, Duty 50%)	IC301, Q309
		No DH. BLK signal at TP305	Q309
D615 ANODE Hi	Overload detection 2		Q612, Q613 (short-circuited between C and E)
		About one minute after the power is turned off, disconnect the K4 connector and turn on the power. Then the power is not turned off (no P.D.).	IC5101, IC5151 and IC5201 in the CRT DRIVE Assy
D621 ANODE Hi	X-ray protection	No change in the ABL voltage (no DC change) at Pin 12 of the CN305 when a 100%-white signal is repeatedly connected and disconnected	D2224 (short-circuited) of the SUB VIDEO Assy
			T601 (FBT) rare short

Note: The anode of the diode is high only for a short time after the power is turned on until the protection circuits are activated (P.D.) The LEDs are lit by the HOLD circuit.

Note that the power may be shut down when the voltages 130 V, 25 V, and 12 V from the POWER SUPPLY Assy are not supplied because the DEFLECTION SERVICE Assy is powered by the POWER SUPPLY Assy.

When overload detection mechanisms 1 and 2 are activated, the 130 V line is short-circuited. If the power switch is set to ON again in this condition, there may be a case where the power cannot be turned on, with just a whining sound, and where only the D915 LED in the POWER SUPPLY Assy is lit. If this happens, first replace only the DEFLECTION SERVICE Assy, disconnect the AC cord from the AC outlet or turn the main power switch OFF, and wait for five minutes. Then, turn on the power again. If the condition is ameliorated, only the DEFLECTION SERVICE Assy is defective. If the same symptom occurs, replace the POWER SUPPLY Assy. In the latter case, the DEFLECTION SERVICE Assy may not be defective.

Be sure to check the fuses in the POWER SUPPLY Assy because one or more may be blown as a result of short-circuiting of the load circuit of the DEFLECTION SERVICE Assy.

3. P.D. (3)

Failure in the CONV. AMP Assy
 The following reason may be suspected:
 1. V. deflection stopping detection

Status	Causes	Check Items	Probable Defective Parts
D923, P.D. LED, lit	V. deflection stopping	Check that the connectors (G1, G2, G3) of the convergence yoke are plugged in.	Plug in the connectors.
		Check that the connectors (G4, G5) of the DIGITAL CONV. Assy are plugged in.	Plug in the connectors.
		Check that the connector (H4) from the POWER SUPPLY Assy is plugged in to the DIGITAL CONV. Assy.	Plug in the connectors.
		Check that the connector (H3) from the DEFLECTION SERVICE Assy is plugged in to the DIGITAL CONV. Assy.	Plug in the connectors.
		Abnormality in V. BLK 2 waveform that is output from Pin 6 of the CN1653 in the DIGITAL CONV. Assy (too long a high period with the DC voltage on)	IC4802 in the SUB VIDEO Assy
		Abnormality in V. BLK 0 waveform that is output from Pin 2 of the CN1652 in the DIGITAL CONV. Assy (too long a high period with the DC voltage on)	IC301 in the DEFLECTION SERVICE Assy
		No waveform is output from Pin 1 of the CN902.	Q913, Q914

Note: The anode of the diode is high only for a short time after the power is turned on until the protection circuits are activated (P.D.) The LEDs are lit by the HOLD circuit.

Be sure to check the fuses in the POWER SUPPLY Assy because one or more may be blown as a result of short-circuiting of the load circuit of the CONV. AMP Assy. See the table below.

Note that the power may be shut down when the voltages 25 V, -20 V, +5 V and -5 V from the POWER SUPPLY Assy are not supplied because the CONV. AMP and DIGITAL CONVER. Assys are powered by the POWER SUPPLY Assy.

If the FU202 and FU204 fuses are blown, see the following table:

Causes	Check Items	Probable Defective Parts
Too high loading on the CONVER. AMP	Check that waveform signals are output from Pin 3 and Pin 5 of the CN901, CN902 and CN903, and that the DC element is not added to the signals.	IC901, IC903
CONVER. MUTING not activated	Check that the electric potential of Pin 3 and Pin 4 of IC901 and IC903 are at the same level when the power is turned on.	Q904, Q918

4. Block Diagram of the Protection Circuit

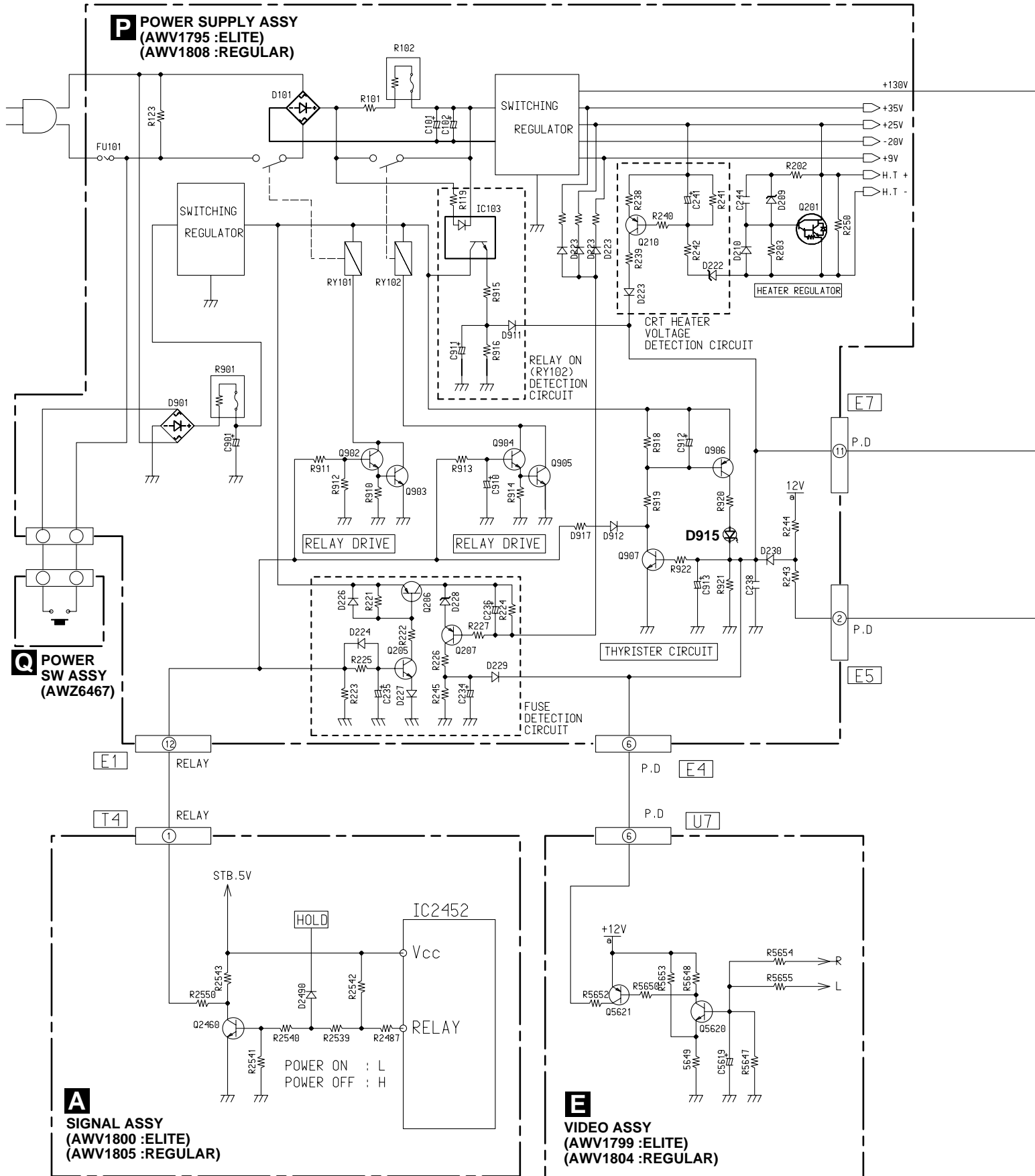

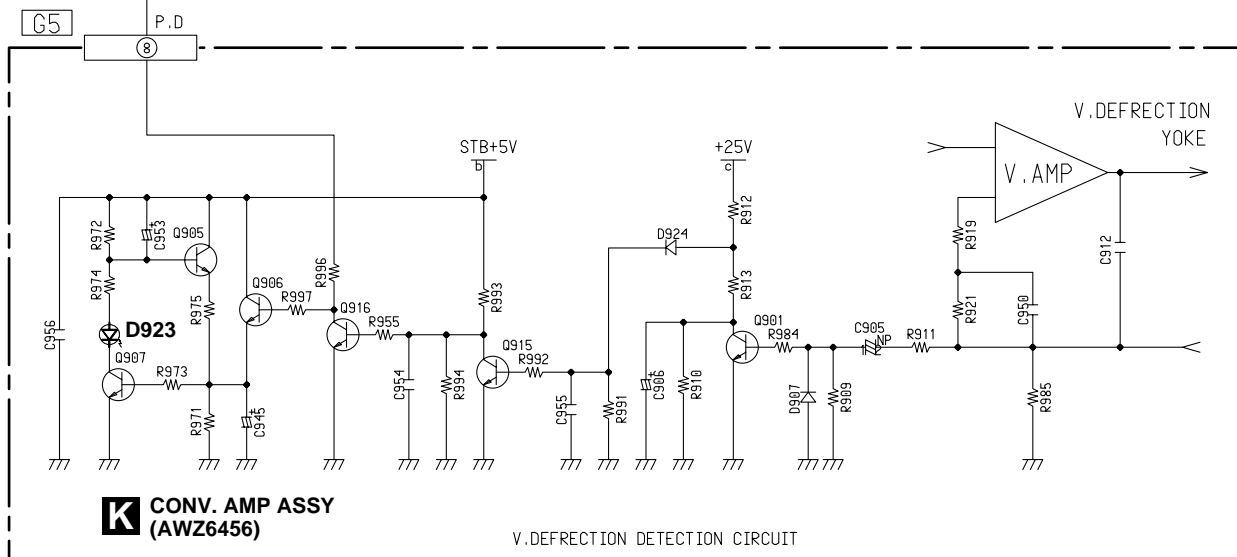
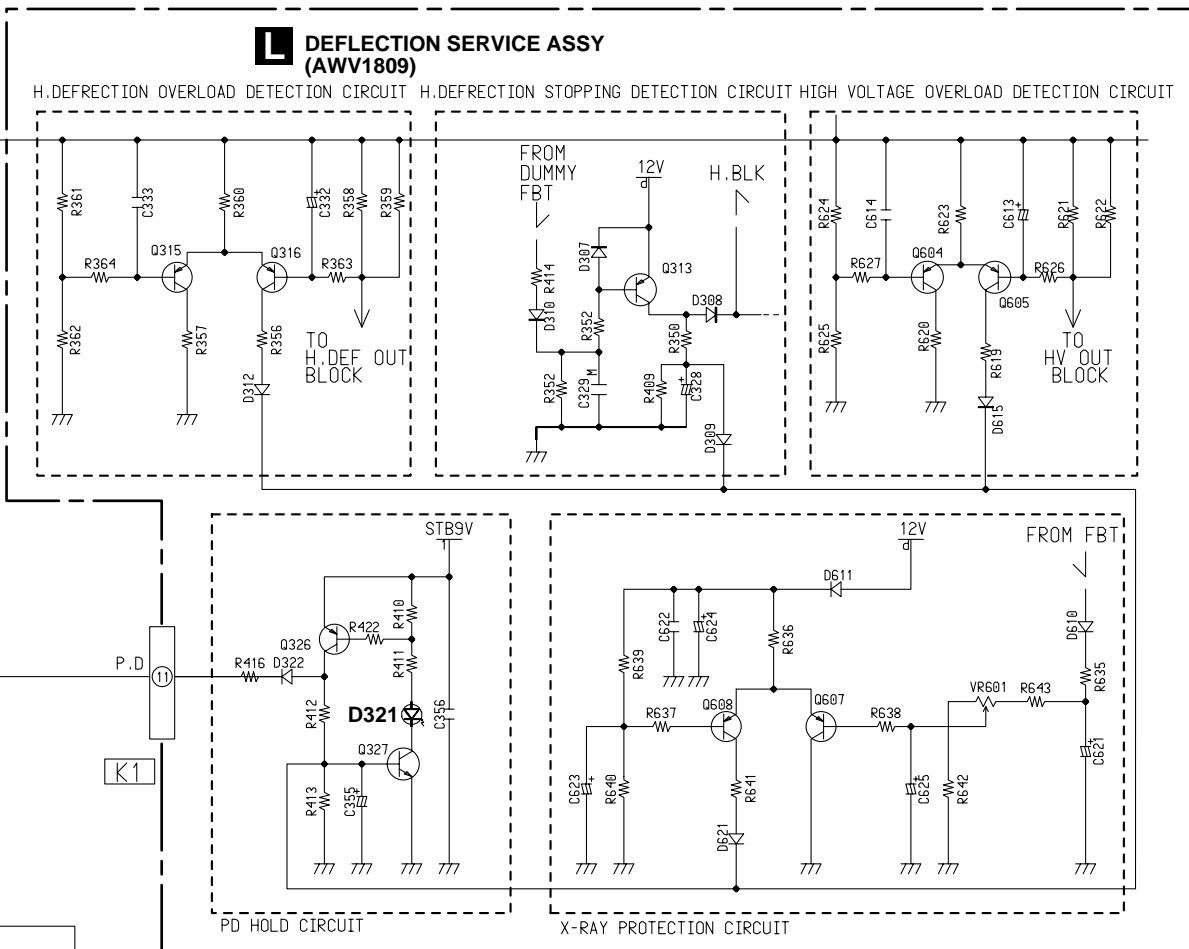

7.1.2 DISASSEMBLY

■ How to remove the screen (for adjusting Lens assemblies)

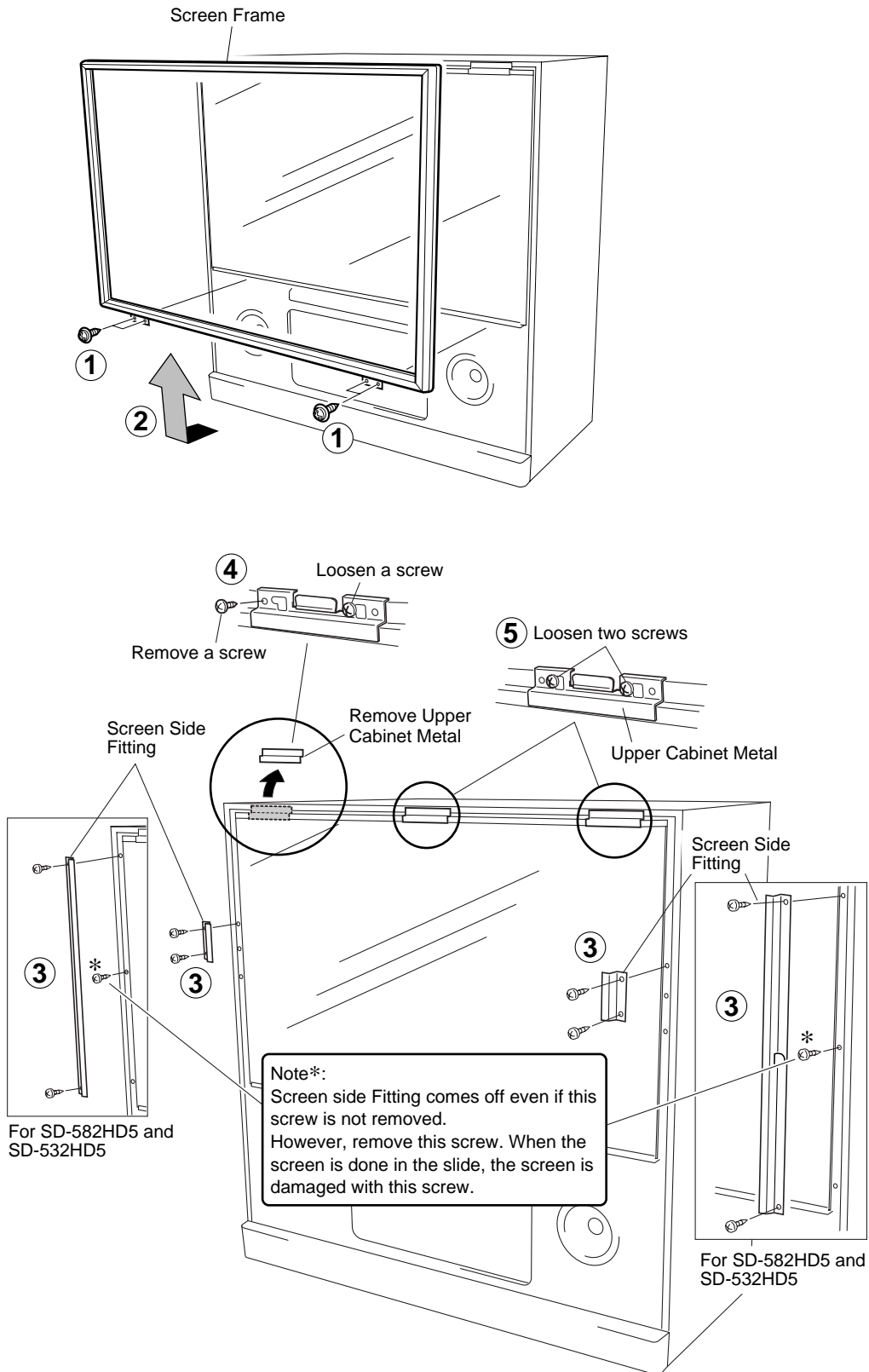

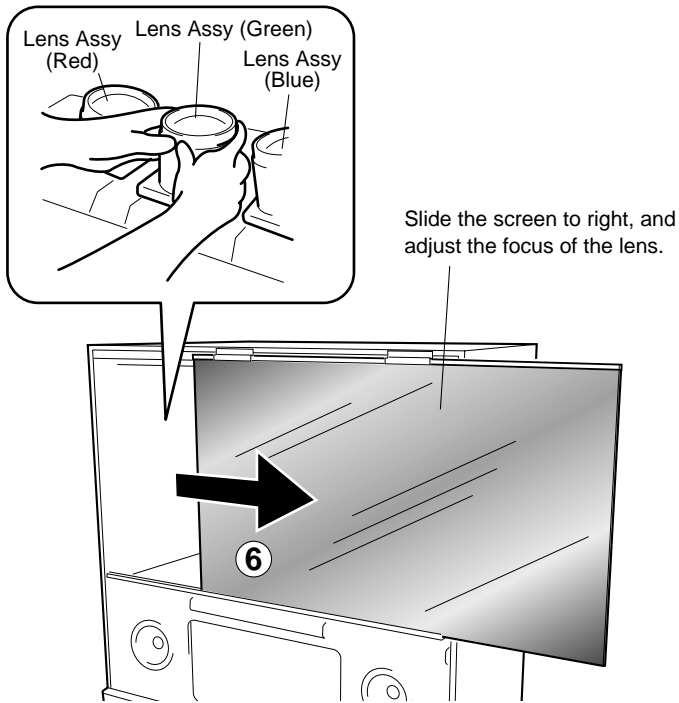

Notes:

To assemble the screen, perform the above procedures in reverse order.

After assembling it, verify that the right and left sides of the screen are positioned as shown in the figure.

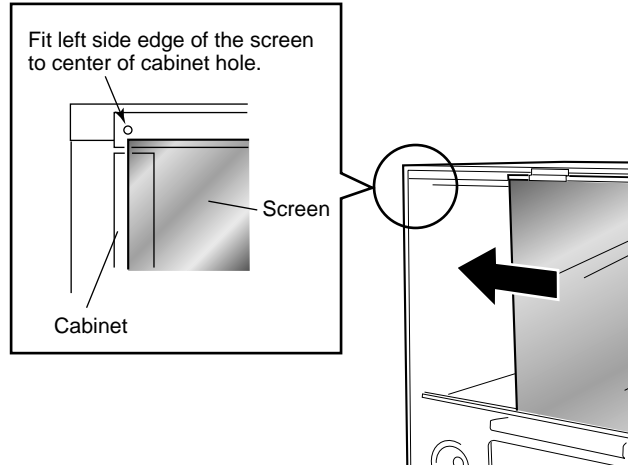

■ Disconnect the Anode Cable

WARNING:

Before disconnect the anode cable, turn off the power, unplug the AC plug and let the unit discharge for more than 1 minut.

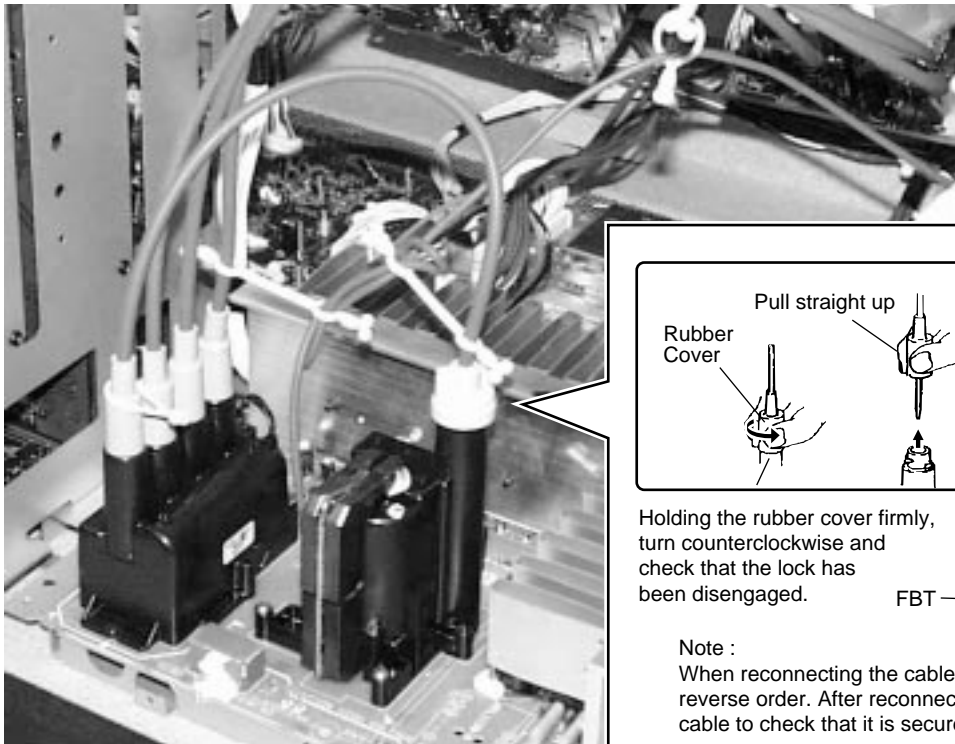

Rubber Cover Pull straight up Anode Cable

Holding the rubber cover firmly, turn counterclockwise and check that the lock has been disengaged.

FBT

Note :
When reconnecting the cable, proceed in the reverse order. After reconnecting, tug on the cable to check that it is secure.

7.1.3 WIRING DIAGRAM

■ Front Section

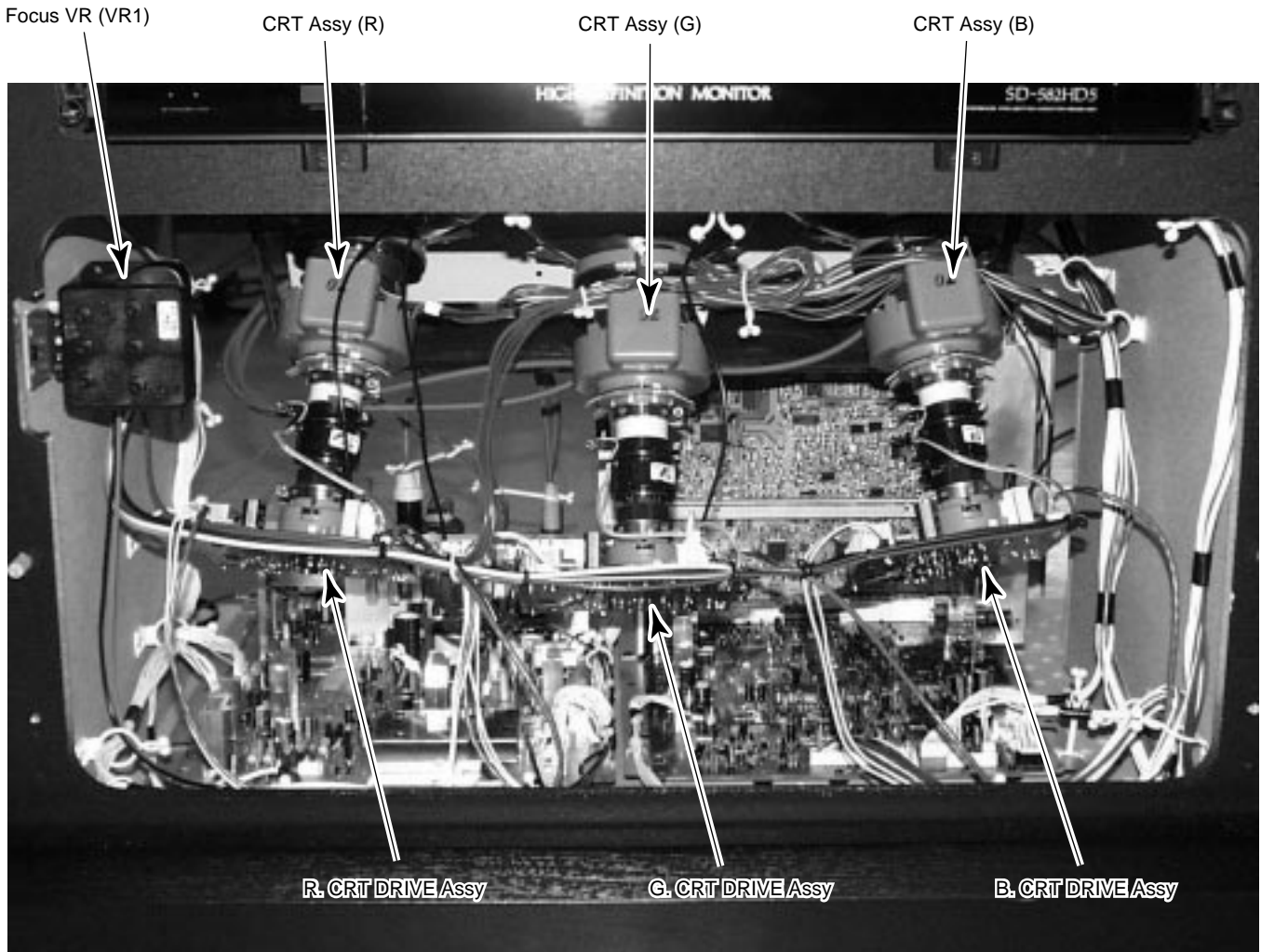

FBT Focus Wire
At least 15 mm away from
any other parts.

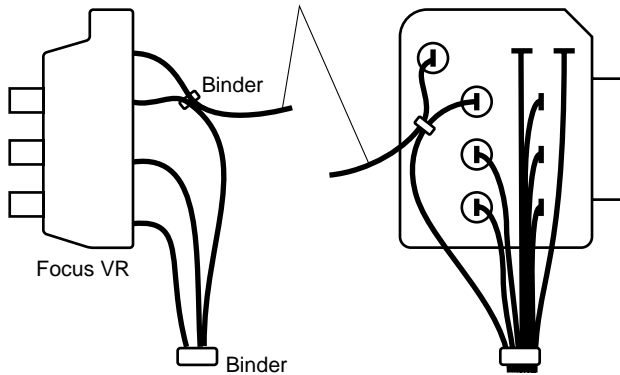

■ Rear Section

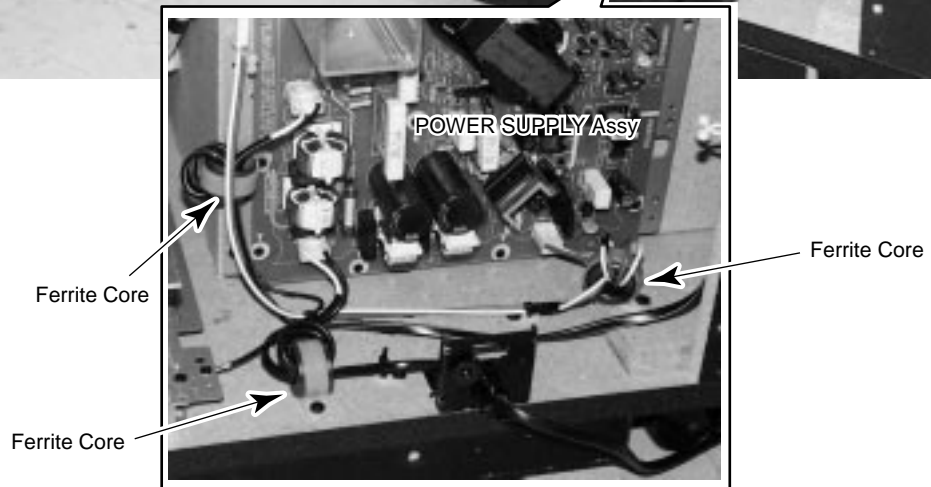
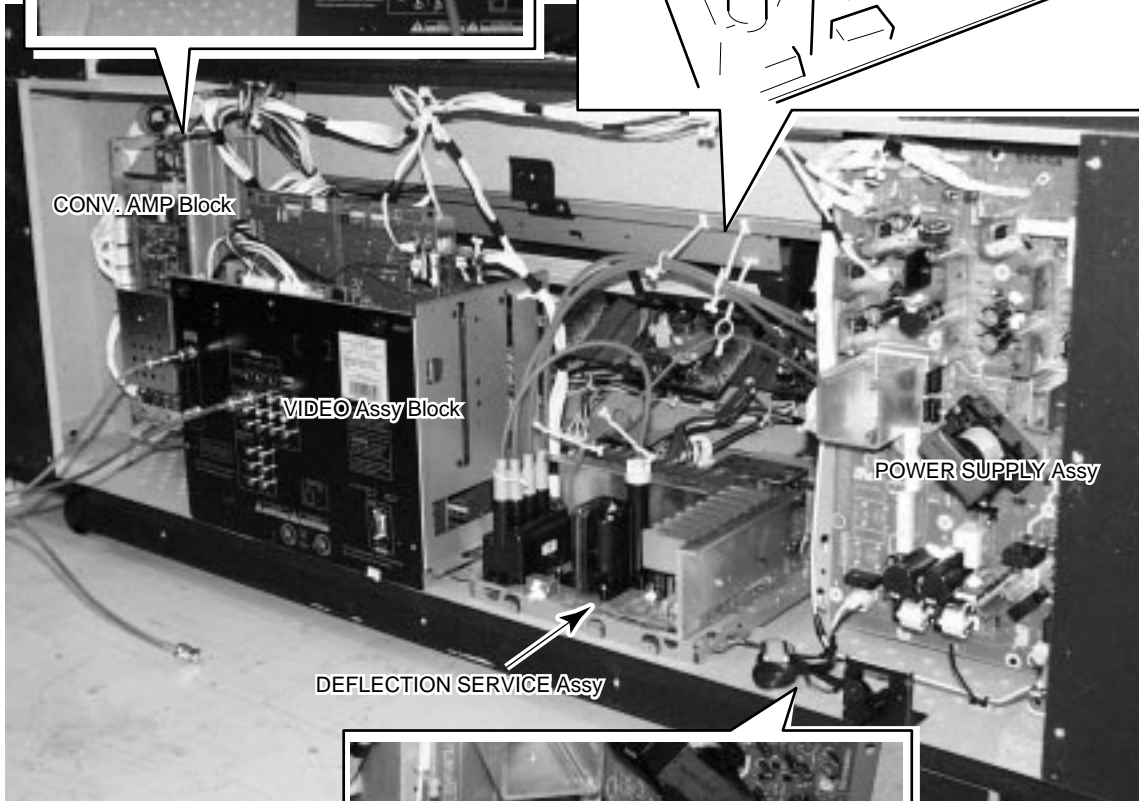
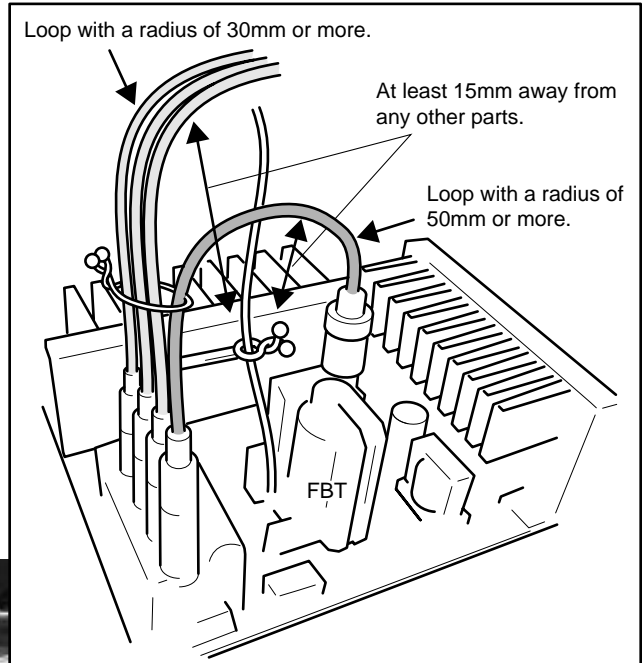
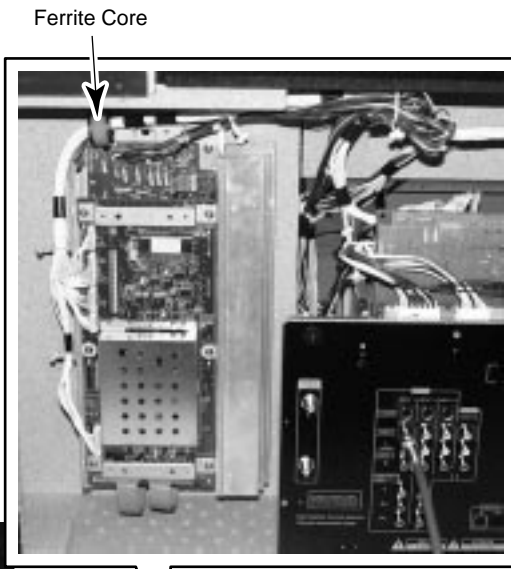

7.2 IC

• The information shown in the list is basic information and may not correspond exactly to that shown in the schematic diagrams.

• List of IC

CXD2303AQ, MB40958PFQ, CXA3106Q, PE5066A, PE5067A, EM636327Q-8, PD3420AB, SAA4990H, CD74HCT4046AM, SAA4955TJ, SAA4997H-K, 24LC128(I)P, 24LC08B(I)P, CM0006C1F, 24LC32A(I)P, ML6420CS-3, CXA2094Q, CM0010AF, TK15420M, MC33167TV

■ CXD2303AQ (SUB VIDEO SERVICE ASSY : IC3203) (PRO-610HD, PRO-510HD ONLY)

• Video A/D Converter

• Block Diagram

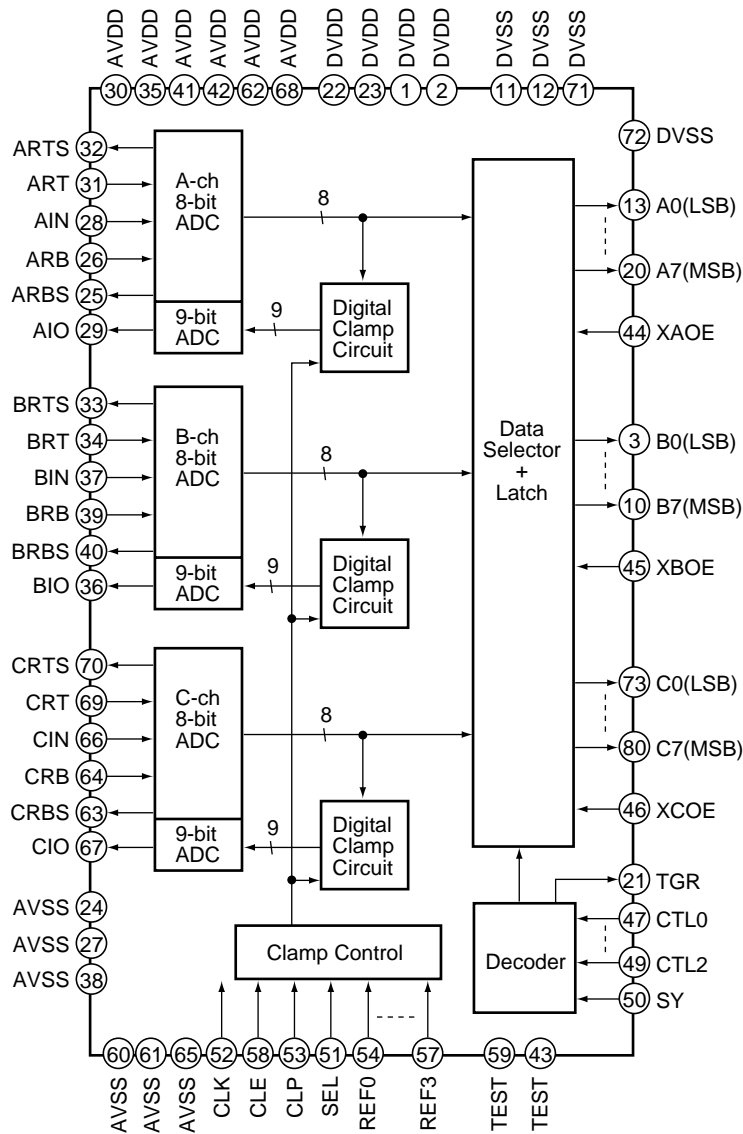

● Pin Function

No.	Pin Name	I/O	Pin Function	No.	Pin Name	I/O	Pin Function
1	DVDD	–	Digital power supply +5V or +3.3V	41	AVDD	–	Analog power supply +5V
2	DVDD	–		42	AVDD	–	
3	B0	O	Digital output (B0: LSB, B7: MSB)	43	TEST	I	Open at normal use (built-in pull-down resistor)
4	B1			I	44	XAOE	Output enable input L: output, H: High-impedance
5	B2				45	XBOE	
6	B3				46	XCOE	
7	B4				I	47	
8	B5			48		CTL1	
9	B6			49		CTL2	
10	B7					50	SY
11	DVSS	–	Digital ground	51	SEL	I	Control the polarity of CLP signal L: CLP is High, H: CLP is Low (built-in pull-down resistor)
12	DVSS	–		52	CLK	I	Clock input (built-in pull-down resistor)
13	A0	O	Digital output (A0: LSB, A7: MSB)	53	CLP	I	Clamp pulse input (built-in pull-down resistor)
14	A1			I	54	REF0	Decides the reference data of the clamp circuit (built-in pull-down resistor)
15	A2				55	REF1	
16	A3				56	REF2	
17	A4				57	REF3	
18	A5			I	58	CLE	Clamp enable L: Clamp circuit is not operate , H: Clamp circuit operates (built-in pull-down resistor)
19	A6			I	59	TEST	Open at normal use (built-in pull-down resistor)
20	A7					60	AVSS
21	TGR	O	Trigger output	61	AVSS	–	Analog ground
22	DVDD	–	Digital power supply +5V or +3.3V	62	AVDD	–	Analog power supply +5V
23	DVDD	–		63	CRBS	–	Generates about 0.5V to CRB pin by short-circuiting to AVSS
24	AVSS	–	Analog ground	64	CRB	–	Reference voltage (Bottom)
25	ARBS	–	Generates about 0.5V to ARB pin by short-circuiting to AVSS	65	AVSS	–	Analog ground
26	ARB	–	Reference voltage (Bottom)	66	CIN	I	Analog input
27	AVSS	–	Analog ground	67	CIO	O	Analog output (D/A converter output pin)
28	AIN	I	Analog input	68	AVDD	–	Analog power supply +5V
29	AIO	O	Analog output (D/A converter output pin)	69	CRT	–	Reference voltage (Top)
30	AVDD	–	Analog power supply +5V	70	CRTS	–	Generates about 2.5V to CRT pin by short-circuiting to AVDD
31	ART	–	Reference voltage (Top)	71	DVSS	–	Digital ground
32	ARTS	–	Generates about 2.5V to ART pin by short-circuiting to AVDD	72	DVSS	–	
33	BRTS	–	Generates about 2.5V to BRT pin by short-circuiting to AVDD	73	C0	O	Digital output (C0: LSB, C7: MSB)
34	BRT	–	Reference voltage (Top)	74	C1		
35	AVDD	–	Analog power supply +5V	75	C2		
36	BIO	O	Analog output (D/A converter output pin)	76	C3		
37	BIN	I	Analog input	77	C4		
38	AVSS	–	Analog ground	78	C5		
39	BRB	–	Reference voltage (Bottom)	79	C6		
40	BRBS	–	Generates about 0.5V to BRB pin by short-circuiting to AVSS	80	C7		

PRO-610HD, PRO-510HD, SD-582HD5, SD-532HD5

■ MB40958PFQ (SUB VIDEO SERVICE ASSY : IC3602) (PRO-610HD, PRO-510HD ONLY)

• D/A Converter

• Block Diagram

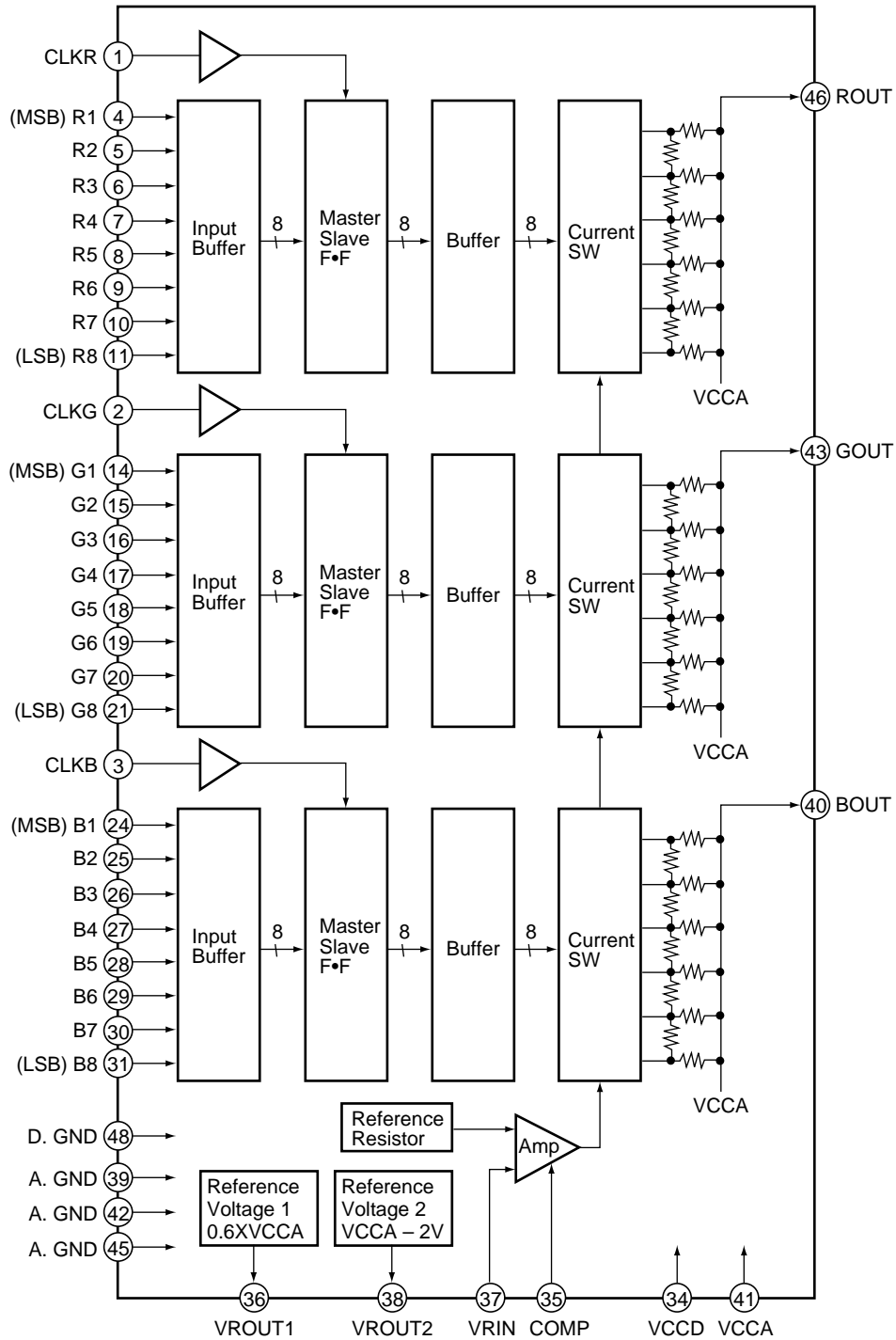

● Pin Function

No.	Pin Name	I/O	Pin Function
1	CLKR	I	R ch clock signal input
2	CLKG	I	G ch clock signal input
3	CLKB	I	B ch clock signal input
4	R1	I	R ch data signal input (R1: MSB, R8: LSB)
5	R2		
6	R3		
7	R4		
8	R5		
9	R6		
10	R7		
11	R8		
12	N.C.	-	Non connection
13	N.C.		
14	G1	I	G ch data signal input (G1: MSB, G8: LSB)
15	G2		
16	G3		
17	G4		
18	G5		
19	G6		
20	G7		
21	G8		
22	N.C.	-	Non connection
23	N.C.		
24	B1	I	B ch data signal input (B1: MSB, B8: LSB)
25	B2		
26	B3		
27	B4		
28	B5		
29	B6		
30	B7		
31	B8		
32	N.C.	-	Non connection
33	N.C.		
34	VCCD	-	Digital power supply (+5V)
35	COMP	-	Phase compensating capacitance pin Connect a 0.1μF capacitor between this pin and A.GND pin.
36	VROUT1	O	Reference voltage output 1
37	VRIN	I	Reference voltage input
38	VROUT2	O	Reference voltage output 2
39	A.GND	-	Analog ground (0V)
40	BOUT	O	B ch analog signal output
41	VCCA	-	Analog power supply (+5V)
42	A.GND	-	Analog ground (0V)
43	GOUT	O	G ch analog signal output
44	VCCA	-	Analog power supply (+5V)
45	A.GND	-	Analog ground (0V)
46	ROUT	O	R ch analog signal output
47	VCCA	-	Analog power supply (+5V)
48	D.GND	-	Digital ground (0V)

PRO-610HD, PRO-510HD, SD-582HD5, SD-532HD5

■ CXA3106Q (SUB VIDEO SERVICE ASSY : IC3201) (PRO-610HD, PRO-510HD ONLY)

• PLL IC

• Pin Function

No.	Pin Name	I/O	Pin Function	No.	Pin Name	I/O	Pin Function
1	IOVCC	–	Digital power supply	25	TTLGND	–	GND for TTL output
2	IOGND	–	Digital GND	26	TTLVCC	–	Power supply for TTL output
3	VCOH	I	External VCO input	27	IOGND	–	Digital GND
4	VCOL	I	External inverting VCO input	28	PECLVCC	–	Power supply for PECL output
5	VCO	I	External VCO input	29	CLK/2L	O	Inverting 1/2 clock output
6	HOLD	I	Phase comparating disable signal input	30	CLK/2H	O	1/2 clock output
7	SYNCH	I	Sync input	31	CLKL	O	Inverting clock output
8	SYNCL	I	Inverting sync input	32	CLKH	O	Clock output
9	SYNC	I	Sync input	33	DSYNCL	O	Delay sync signal output
10	SENABLE		Control signal (enable)	34	DSYNCH	O	Inverting delay sync signal output
11	SCLK		Control signal (clock)	35	VBB	–	Reference voltage of PECL
12	SDATA		Control signal (data)	36	PECLVCC	–	Power supply for PECL output
13	TLOAD	I	Programmable counter test input	37	IOGND	–	Digital GND
14	CS		Chip select	38	IOVCC	–	Digital power supply
15	SEROUT	O	Register read output	39	PLLVCC	–	Analog power supply for PLL circuit
16	DIVOUT	O	Programmable counter test output	40	PLLGND	–	Analog GND for PLL circuit
17	UNLOCK	O	Unlock signal output	41	VCOVCC	–	Analog power supply for VCO circuit
18	DVCC	–	Digital power supply	42	VCOGND	–	Analog GND for VCO circuit
19	DGND	–	Digital GND	43	VCOHGND	–	Analog GND for VCO SUB
20	CLK/2N	O	Inverting 1/2 clock output	44	IREF	–	For generates the charge pump current
21	CLK/2	O	1/2 clock output	45	RC2	–	External connection pin for LPF
22	CLKN	O	Inverting clock output	46	RC1	–	External connection pin for LPF
23	CLK	O	Clock output	47	IRGND	–	Analog GND for IREF
24	DSYNC	O	Delay sync signal output	48	IRVCC	–	Analog power supply for IREF

■ PE5066A (SUB VIDEO SERVICE ASSY : IC3401) (PRO-610HD, PRO-510HD ONLY)

• I/P System Controller IC

● Pin Function

No.	Pin Name	I/O	Pin Function	No.	Pin Name	I/O	Pin Function
1	GND	-	Ground	46	YP(8)	O	Digital output of sequential converting Y signal
2	GND	-	Ground	47	YP(7)		
3	PRP(15)	O	Digital output of sequential converting R-Y signal	48	YP(6)		
4	PRP(14)			49	YP(5)		
5	PRP(13)			50	YP(4)		
6	PRP(12)			51	YP(3)		
7	PRP(11)			52	YP(2)		
8	PRP(10)			53	YP(1)		
9	PRP(9)			54	YP(0)		
10	PRP(8)			55	HP		
11	PRP(7)			56	VP	O	Sequential converting V. sync signal output
12	PRP(6)			57	HI	I	H. sync signal input
13	PRP(5)	58	VI	I	V. sync signal input		
14	PRP(4)	59	GND	-	Ground		
15	PRP(3)	60	GND	-	Ground		
16	PRP(2)	61	VDD	-	Power supply (3.3V)		
17	PRP(1)	62	RES	I	Reset signal input		
18	PRP(0)	63	GND	-	Ground		
19	PBP(15)	O	Digital output of sequential converting B-Y signal (upper bit)	64	FI	I	Field signal input
20	GND	-	Ground	65	RD	I	RD signal input for PE5066A
21	VDD	-	Power supply (3.3V)	66	HWR	I	HWR signal input for PE5066A
22	PBP(14)	O	Digital output of sequential converting B-Y signal	67	CS	I	CS signal input for PE5066A
23	PBP(13)			68	IPKILL	I	ON/OFF signal input of I/P process
24	PBP(12)			69	NC	-	Non connection
25	PBP(11)			70	FILM	O	Film detection signal output
26	PBP(10)			71	NC	-	Non connection
27	PBP(9)			72	UA(11)	I	Address signal input for PE5066A
28	PBP(8)			73	UA(10)		
29	PBP(7)			74	UA(9)		
30	PBP(6)			75	UA(8)		
31	PBP(5)			76	UA(7)		
32	PBP(4)	77	UA(6)				
33	PBP(3)	78	UA(5)				
34	PBP(2)	79	UA(4)				
35	PBP(1)	80	GND	-	Ground		
36	PBP(0)	81	VDD	-	Power supply (3.3V)		
37	YP(15)	O	Digital output of sequential converting Y signal	82	UA(3)	I	Address signal input for PE5066A
38	YP(14)			83	UA(2)		
39	YP(13)			84	UA(1)		
40	GND			85	UA(0)		
41	VDD	-	Power supply (3.3V)	86	UD(7)	I/O	Data input/output for PE5066A
42	YP(12)	87	UD(6)				
43	YP(11)	88	UD(5)				
44	YP(10)	89	GND	-	Ground		
45	YP(9)	90	VDD	-	Power supply (3.3V)		

PRO-610HD, PRO-510HD, SD-582HD5, SD-532HD5

No.	Pin Name	I/O	Pin Function	No.	Pin Name	I/O	Pin Function
91	UD(4)	I/O	Data input/output for PE5066A	141	MDY(23)	I/O	Data input/output for external SGRAM
92	UD(3)			142	MDY(22)		
93	UD(2)			143	MDY(21)		
94	UD(1)			144	MDY(20)		
95	UD(0)			145	MDY(19)		
96	GND	–	Ground	146	MDY(18)		
97	MDC(23)	I/O	Data input/output for external SGRAM	147	MDY(17)		
98	MDC(22)			148	MDY(16)		
99	MDC(21)			149	MDY(7)		
100	VDD	–	Power supply (3.3V)	150	MDY(6)		
101	GND	–	Ground	151	MDY(5)		
102	MDC(20)	I/O	Data input/output for external SGRAM	152	MDY(4)		
103	MDC(19)			153	MDY(3)		
104	MDC(18)			154	MDY(2)		
105	MDC(17)			155	MDY(1)		
106	MDC(16)			156	MDY(0)		
107	MDC(7)			157	MA(10)		
108	MDC(6)			O	Address signal output for external SGRAM	158	MA(8)
109	MDC(5)			159	MA(0)		
110	MDC(4)			160	VDD	–	Power supply (3.3V)
111	MDC(3)			161	GND	–	Ground
112	MDC(2)			O	Address signal output for external SGRAM	162	MA(1)
113	MDC(1)	163	MA(2)				
114	MDC(0)	164	MA(3)				
115	MCLKC	165	MA(4)				
116	MCS	O	CS signal output for external SGRAM	166	MA(5)		
117	MRAS	O	RAS signal output for external SGRAM	167	MA(6)		
118	MCAS	O	CAS signal output for external SGRAM	168	MA(7)		
119	MWE	O	WE signal output for external SGRAM	169	MA(9)		
120	VDD	–	Power supply (3.3V)	170	MCLKY	O	CLK signal output for external SGRAM
121	GND	–	Ground	171	MDY(31)		
122	GND	–	Ground	172	MDY(30)		
123	MDC(31)	I/O	Data input/output for external SGRAM	173	MDY(29)		
124	MDC(30)			174	MDY(28)		
125	MDC(29)			175	MDY(27)		
126	MDC(28)			176	MDY(26)		
127	MDC(27)			177	MDY(25)		
128	MDC(26)			178	MDY(24)		
129	MDC(25)			179	GND	–	Ground
130	MDC(24)			180	GND	–	Ground
131	MDC(15)			181	VDD	–	Power supply (3.3V)
132	MDC(14)			I/O	Data input/output for external SGRAM	182	MDY(15)
133	MDC(13)					183	MDY(14)
134	MDC(12)					184	MDY(13)
135	MDC(11)					185	MDY(12)
136	MDC(10)					186	MDY(11)
137	MDC(9)					187	MDY(10)
138	MDC(8)					188	MDY(9)
139	GND	–	Ground	189	MDY(8)		
140	VDD	–	Power supply (3.3V)	190	NC	–	Non connection

PRO-610HD, PRO-510HD, SD-582HD5, SD-532HD5

No.	Pin Name	I/O	Pin Function	No.	Pin Name	I/O	Pin Function		
191	NC	-	Non connection	216	YI(3)	I	Digital input of Y signal (lower bit)		
192	NC			217	YI(2)				
193	NC			218	YI(1)				
194	NC			219	YI(0)				
195	NC			220	VDD	-	Power supply (3.3V)		
196	NC			221	GND	-	Ground		
197	NC			222	PBI(7)	I	Digital input of B-Y signal (upper bit)		
198	NC			223	PBI(6)				
199	NC			224	PBI(5)				
200	GND			-	Ground			225	PBI(4)
201	VDD	-	Power supply (3.3V)	226	PBI(3)				
202	NC	-	Non connection	227	PBI(2)			I	Digital input of B-Y signal (lower bit)
203	NC			228	PBI(1)				
204	NC			229	PBI(0)				
205	NC			230	PRI(7)	I	Digital input of R-Y signal (upper bit)		
206	NC			231	PRI(6)				
207	NC			232	PRI(5)				
208	NC			233	PRI(4)				
209	NC			234	PRI(3)				
210	NC			235	PRI(2)				
211	NC			236	PRI(1)				
212	YI(7)	I	Digital input of Y signal (upper bit)	237	PRI(0)	I	Digital input of R-Y signal (lower bit)		
213	YI(6)			238	GND			-	Ground
214	YI(5)			239	CLK			I	System clock input
215	YI(4)			240	VDD			-	Power supply (3.3V)

PRO-610HD, PRO-510HD, SD-582HD5, SD-532HD5

■ PE5067A (SUB VIDEO SERVICE ASSY : IC3501) (PRO-610HD, PRO-510HD ONLY)

• I/P System Controller IC

● Pin Function

No.	Pin Name	I/O	Pin Function	No.	Pin Name	I/O	Pin Function		
1	GND	–	Ground	51	DEI	I	Data enable input for external DIGITAL I/F		
2	GND	–	Ground	52	HDI	I	H. sync signal input		
3	CLK	I	System clock input	53	VDI	I	V. sync signal input		
4	GND	–	Ground	54	FLDI	I	Field signal input (Not used)		
5	GBI(0)	I	(lower bit) Demultiplex digital input B of G/Y signal	55	GND	–	Ground		
6	GBI(1)			56	RES	I	Reset signal input		
7	GBI(2)			57	VDD	–	Power supply (3.3V)		
8	GBI(3)			58	GND	–	Ground		
9	GBI(4)			59	HCLR	O	Histogram clear signal output		
10	GBI(5)			60	FDET	O	ON/OFF judge signal output of I/P process		
11	GBI(6)			61	VACT	O	Histogram signal output		
12	GBI(7)			(upper bit)	62	WAIT	O	WAIT signal input for PE5067A	
13	BBI(0)	I	(lower bit) Demultiplex digital input B of B/PB signal	63	NC	–	Non connection		
14	BBI(1)			64	HWR	I	HWR signal input for PE5067A		
15	BBI(2)			65	RD	I	RD signal input for PE5067A		
16	BBI(3)			66	CS	I	CS signal input for PE5067A		
17	BBI(4)			67	EMG_IP	I	Compulsory hardware through function		
18	BBI(5)				68	UA(11)	I	Address signal input for PE5067A	
19	VDD	–	Power supply (3.3V)	69	UA(10)				
20	GND	–	Ground	70	UA(9)				
21	BBI(6)	I	Demultiplex digital input B of B/PB signal (upper bit)	71	UA(8)				
22	BBI(7)			72	UA(7)				
23	RAI(0)	I	(lower bit) Demultiplex digital input A of R/PR signal	73	UA(6)	I	Address signal input for PE5067A		
24	RAI(1)			74	UA(5)				
25	RAI(2)			75	GND			–	Ground
26	RAI(3)			76	GND			–	
27	RAI(4)			77	VDD	–	Power supply (3.3V)		
28	RAI(5)			78	VDD	–			
29	RAI(6)			(upper bit)	79	UA(4)	I	Address signal input for PE5067A	
30	RAI(7)				80	UA(3)			
31	GAI(0)	I	(lower bit) Demultiplex digital input A of G/Y signal	81	UA(2)				
32	GAI(1)			82	UA(1)				
33	GAI(2)			83	UA(0)				
34	GAI(3)			84	GND	–	Ground		
35	GAI(4)			85	UD(7)	I/O	Data input/output for PE5067A		
36	GAI(5)			86	UD(6)				
37	VDD	–	Power supply (3.3V)	87	UD(5)				
38	VDD	–	Power supply (3.3V)	88	UD(4)				
39	GND	–	Ground	89	GND	–	Ground		
40	GND	–	Ground	90	UD(3)	I/O	Data input/output for PE5067A		
41	GAI(6)	I	Demultiplex digital input A of G/Y signal (upper bit)	91	UD(2)				
42	GAI(7)			92	UD(1)				
43	BAI(0)	I	(lower bit) Demultiplex digital input A of B/PB signal	93	UD(0)	O	System output of field signal		
44	BAI(1)			94	FLDO				
45	BAI(2)			95	GND	–	Ground		
46	BAI(3)			96	GND	–			
47	BAI(4)			97	VDO	O	System output of sequential converting V. sync signal		
48	BAI(5)			98	HDO	O	System output of sequential converting H. sync signal		
49	BAI(6)			99	DEO	O	Sequential converting data enable output		
50	BAI(7)			(upper bit)	100	BAO(7)	O	Demultiplex digital out A of B/PB signal (upper bit)	

PRO-610HD, PRO-510HD, SD-582HD5, SD-532HD5

No.	Pin Name	I/O	Pin Function	No.	Pin Name	I/O	Pin Function		
101	BAO(6)	O	Demultiplex digital output A of B/PB signal	152	VDD	-	Power supply (3.3V)		
102	BAO(5)			153	GND	-	Ground		
103	BAO(4)			154	GND	-			
104	VDD	-	Power supply (3.3V)	155	GBO(0)	O	Demultiplex digital output B of G/Y signal (lower bit)		
105	GND	-	Ground	156	RBO(7)	O	Demultiplex digital output B of R/PR signal (upper bit)		
106	BAO(3)	O	Demultiplex digital output A of B/PB signal (lower bit)	157	RBO(6)				
107	BAO(2)			158	RBO(5)				
108	BAO(1)			159	RBO(4)				
109	BAO(0)			160	RBO(3)				
110	GAO(7)			161	RBO(2)				
111	GAO(6)	O	Demultiplex digital output A of G/Y signal (upper bit)	162	VDD	-	Power supply (3.3V)		
112	GAO(5)	-	Ground	163	GND	-	Ground		
113	VDD	-	Power supply (3.3V)	164	RBO(1)	O	Demultiplex digital output B of R/PR signal (lower bit)		
114	VDD	-		165	RBO(0)				
115	GND	-	Ground	166	FI	O	Field signal output		
116	GND	-		167	VI	O	V. sync signal output		
117	GAO(4)	O	Demultiplex digital output A of G/Y signal (lower bit)	168	HI	O	H. sync signal output		
118	GAO(3)			169	VP	I	Sequential converting V. sync signal input		
119	GAO(2)			170	HP	I	Sequential converting H. sync signal input		
120	GAO(1)			171	VDD	-	Power supply (3.3V)		
121	GAO(0)			172	GND	-	Ground		
122	RAO(7)			O	(upper bit) Demultiplex digital output A of R/PR signal	173	PRP(0)	I	Digital input of R-Y signal after sequential converted (lower bit)
123	RAO(6)	174	PRP(1)						
124	VDD	-	Power supply (3.3V)	175	PRP(2)				
125	GND	-	Ground	176	PRP(3)				
126	RAO(5)	O	Demultiplex digital output A of R/PR signal (lower bit)	177	PRP(4)				
127	RAO(4)			178	PRP(5)				
128	RAO(3)			179	PRP(6)				
129	RAO(2)			180	PRP(7)				
130	RAO(1)			181	PRP(8)				
131	RAO(0)			182	PRP(9)				
132	VCLK	O	Sync clock output of digital output	183	PRP(10)	I	Digital input of R-Y signal after sequential converted (upper bit)		
133	GND	-	Ground	184	PRP(11)				
134	GND	-	Ground	185	PRP(12)				
135	BBO(7)	O	Demultiplex digital output B of B/PB signal (upper bit)	186	PRP(13)				
136	BBO(6)			187	PRP(14)				
137	BBO(5)			188	PRP(15)				
138	BBO(4)			189	VDD	-	Power supply (3.3V)		
139	BBO(3)			190	VDD	-			
140	BBO(2)			-	Ground	191	GND	-	Ground
141	BBO(1)			-	Ground	192	GND	-	
142	BBO(0)	-	(lower bit)	193	PBP(0)	I	Digital input of B-Y signal after sequential converted (lower bit)		
143	GND	-	Ground	194	PBP(1)				
144	GBO(7)	O	Demultiplex digital output B of G/Y signal (upper bit)	195	PBP(2)				
145	GBO(6)			196	PBP(3)				
146	GBO(5)			197	PBP(4)				
147	GBO(4)			198	PBP(5)				
148	GBO(3)			199	PBP(6)				
149	GBO(2)			200	PBP(7)				
150	GBO(1)			201	PBP(8)				
151	VDD			-	Power supply (3.3V)			202	PBP(9)

PRO-610HD, PRO-510HD, SD-582HD5, SD-532HD5

No.	Pin Name	I/O	Pin Function	No.	Pin Name	I/O	Pin Function		
203	PBP(10)	I	Digital input of B-Y signal after sequential converted (upper bit)	254	YI(5)	O	Digital output of Y signal (upper bit)		
204	PBP(11)			255	YI(6)				
205	PBP(12)			256	YI(7)				
206	PBP(13)			257	NC	-	Non connection		
207	PBP(14)			258	NC				
208	PBP(15)			259	NC				
209	VDD	-	Power supply (3.3V)	260	NC				
210	GND	-	Ground	261	NC				
211	YP(0)	I	Digital input of sequential converting Y signal (lower bit)	262	NC			-	Non connection
212	YP(1)			263	NC				
213	YP(2)			264	NC				
214	YP(3)			265	VDD	-	Power supply (3.3V)		
215	YP(4)			266	VDD	-			
216	YP(5)			267	GND	-	Ground		
217	YP(6)			268	GND	-			
218	YP(7)			269	NC	-		Non connection	
219	YP(8)			270	NC				
220	YP(9)			271	NC				
221	YP(10)			272	NC				
222	YP(11)			273	NC				
223	YP(12)			274	NC				
224	YP(13)			275	NC				
225	YP(14)			276	NC				
226	YP(15)	-	(upper bit)	277	GND	-	Ground		
227	GND	-	Ground	278	CLP1	O	Programmable CLP output		
228	GND	-	Ground	279	CLP2				
229	VDD	-	Power supply (3.3V)	280	HBLK1	O	Programmable HBLK output		
230	VDD	-	Power supply (3.3V)	281	HBLK2				
231	PRI(0)	O	Digital output of R-Y signal (lower bit)	282	VBLK1	O	Programmable VBLK output		
232	PRI(1)			283	VBLK2				
233	PRI(2)			284	FLD2	O	Programmable field signal output		
234	PRI(3)			285	GND	-	Ground		
235	PRI(4)			286	GND	-			
236	PRI(5)			287	NC	-	Non connection		
237	PRI(6)			288	NC				
238	PRI(7)			289	NC				
239	PBI(0)	O	Digital output of B-Y signal (lower bit)	290	NC	-	Non connection		
240	PBI(1)			291	NC				
241	PBI(2)			292	NC				
242	PBI(3)			293	NC				
243	PBI(4)			294	SGLB	I	SGLB signal input for PE5067A		
244	PBI(5)			295	RBI(0)	I	Demultiplex digital input B of R/PR signal (lower bit)		
245	PBI(6)			296	RBI(1)				
246	PBI(7)			297	RBI(2)				
247	GND	-	Ground	298	RBI(3)				
248	GND	-	Ground	299	RBI(4)				
249	YI(0)	O	Digital output of Y signal (lower bit)	300	RBI(5)			-	Power supply (3.3V)
250	YI(1)			301	RBI(6)				
251	YI(2)			302	RBI(7)				
252	YI(3)			303	VDD	-			
253	YI(4)			304	VDD	-			
					(upper bit)				

■ EM636327Q-8 (SUB VIDEO SERVICE ASSY : IC3601, IC3604)

• 16M SGRAM (PRO-610HD, PRO-510HD ONLY)

● Pin Function

No.	Pin Name	I/O	Pin Function	No.	Pin Name	I/O	Pin Function
1	DQ3	I/O	Data input/output	51	A9	I	Address input
2	VDDQ	-	DQ power supply	52	NC	-	Non connection
3	DQ4	I/O	Data input/output	53	DSF	I	Define special function signal input
4	DQ5			54	CKE	I	Clock enable input
5	VSSQ	-	DQ ground	55	CLK	I	Clock input
6	DQ6	I/O	Data input/output	56	DQM1	I	Data input/output mask input
7	DQ7			57	DQM3		
8	VDDQ	-	DQ power supply	58	NC	-	Non connection
9	DQ16	I/O	Data input/output	59	VDDQ	-	DQ power supply
10	DQ17			60	DQ8	I/O	Data input/output
11	VSSQ	-	DQ ground	61	DQ9		
12	DQ18	I/O	Data input/output	62	VSSQ	-	DQ ground
13	DQ19			63	DQ10	I/O	Data input/output
14	VDDQ	-	DQ power supply	64	DQ11		
15	VDD	-	Power supply	65	VDD	-	Power supply
16	VSS	-	Ground	66	VSS	-	Ground
17	DQ20	I/O	Data input/output	67	VDDQ	-	DQ power supply
18	DQ21			68	DQ12	I/O	Data input/output
19	VSSQ	-	DQ ground	69	DQ13		
20	DQ22	I/O	Data input/output	70	VSSQ	-	DQ ground
21	DQ23			71	DQ14	I/O	Data input/output
22	VDDQ	-	DQ power supply	72	DQ15		
23	DQM0	I	Data input/output mask input	73	VDDQ	-	DQ power supply
24	DQM2			74	DQ24	I/O	Data input/output
25	WE#	I	Write enable signal input	75	DQ25		
26	CAS#	I	Column address strobe signal input	76	VSSQ	-	DQ ground
27	RAS#	I	Row address strobe signal input	77	DQ26	I/O	Data input/output
28	CS#	I	Chip select input	78	DQ27		
29	BS	I	Bank select input	79	VDDQ	-	DQ power supply
30	A8	I	Address input	80	DQ28	I/O	Data input/output
31	A0			81	DQ29		
32	A1			82	VSSQ	-	DQ ground
33	A2			I/O	Data input/output	83	DQ30
34	A3					84	DQ31
35	VDD	-	Power supply	85	VSS	-	Ground
36	NC	-	Non connection	86	NC	-	Non connection
37	NC			87	NC		
38	NC			88	NC		
39	NC			89	NC		
40	NC			90	NC		
41	NC			91	NC		
42	NC			92	NC		
43	NC			93	NC		
44	NC			94	NC		
45	NC			95	NC		
46	VSS	-	Ground	96	VDD	-	Power supply
47	A4	I	Address input	97	DQ0	I/O	Data input/output
48	A5			98	DQ1		
49	A6			99	VSSQ	-	DQ ground
50	A7			100	DQ2	I/O	Data input/output

PRO-610HD, PRO-510HD, SD-582HD5, SD-532HD5

■ PD3420A8 (SUB VIDEO SERVICE ASSY : IC3801) (PRO-610HD, PRO-510HD ONLY)

• I/P System micro-computer IC

● Pin Function

No.	Pin Name	I/O	Pin Function	No.	Pin Name	I/O	Pin Function
1	VCC	–	Power supply (+5V)	51	A14	I	Non connection
2	CS7	O	Non connection	52	A15	I	
3	CS6	O		53	A16	O	
4	CS5	O		54	A17	O	
5	CS4	O		55	A18	O	
6	UCAS	O	Chip select of PE5066A	56	A19	O	
7	LCAS	I/O	Data phase control of PE5067A	57	VSS	–	Ground
8	PB6	O	For microcomputer communication (Not used)	58	WAIT	I	WAIT signal of PE5067A
9	PB7	I		59	BREQ	I	Non connection
10	FEW	I	For writing the flash	60	BACK	O	Compulsory hardware through of PE5067A (Not used)
11	VSS	–	Ground	61	P18 (φ)	I	Clock output
12	P90	O	Error signal for communicating with main unit microcomputer	62	STBY	I	—
13	TxD1	O	For writing the flash	63	RES	I	Hardware reset of I/P microcomputer
14	RxD0	I	Data for communicating with main unit microcomputer	64	NMI	I	—
15	RxD1	I	For writing the flash	65	VSS	–	Ground
16	SCK0	I	Clock for communicating with main unit microcomputer	66	EXTAL	I	Connect a crystal oscillator
17	P95	O	Busy for communicating with main unit microcomputer	67	XTAL	I	
18	D0	O	For test	68	VCC	–	Power supply (+5V)
19	D1			69	AS	O	Non connection
20	D2			70	RD	O	RD for PE5066A/5067A
21	D3			71	HWR	O	HWR for PE5066A/5067A
22	VSS	–	Ground	72	LWR	O	—
23	D4	O	For test	73	MD0	I	—
24	D5			74	MD1	I	—
25	D6			75	MD2	I	—
26	D7			76	AVCC	–	Power supply (+5V)
27	D8	I/O	Data bus 8-bit	77	VREF	–	Reference voltage setting (+5V)
28	D9			78	P70	I	Non connection
29	D10			79	P71	I	
30	D11			80	P72	I	
31	D12			81	P73	I	
32	D13			82	P74	I	
33	D14			83	P75	I	
34	D15			84	P76	I	PLL unlock detection (Not used)
35	VCC	–	Power supply (+5V)	85	P77	I	Obtain the external film information (Not used)
36	A0	O	Address bus 12-bit	86	AVSS	–	Ground
37	A1			87	IRQ0	I	Obtain the film information
38	A2			88	IRQ1	I	Obtain the histogram
39	A3			89	IRQ2	I	Vertical sync input
40	A4			90	IRQ3	O	Chip select of PE5067A
41	A5			91	CS0	I	Field judgement
42	A6			92	VSS	–	Ground
43	A7			93	PA0	I	System frequency detection (Not used)
44	VSS	–	Ground	94	PA1	I	Horizontal sync input
45	A8	O	Address bus 12-bit	95	PA2	O	—
46	A9			96	PA3	O	—
47	A10			97	PA4	O	For test
48	A11			98	PA5	O	
49	A12	I	Non connection	99	PA6	O	IP process (PE5066A) stop control
50	A13	I	Non connection	100	PA7	O	IP system reset

■ SAA4990H (SUB VIDEO ASSY : IC3401) (SD-582HD5, SD-532HD5 ONLY)

- Progressive scan-Zoom and Noise Reduction IC (PROZONIC)

• Pin Function

No.	Pin Name	I/O	Pin Function	No.	Pin Name	I/O	Pin Function
1	TEST1/AP	I	Action pin for testing, to be connected to Vss.	41	HD	I	Horizontal reference signal
2	TEST2/SP	I	Shift pin for testing, to be connected to Vss.	42	YUVD8	O	UV bit 0
3	RE1	O	Read enable to FM1	43	YUVD9	O	UV bit 1
4	VSS1	-	Ground 1	44	YUVD10	O	UV bit 2
5	VDD1	-	Supply voltage 1	45	VDD5	-	Supply voltage 5
6	YUVC7	O	Y bit 7 to FM2	46	VSS5	-	Ground 5
7	YUVC6	O	Y bit 6 to FM2	47	YUVD11	O	UV bit 3
8	YUVC5	O	Y bit 5 to FM2	48	YUVD0	O	Y bit 0
9	YUVC4	O	Y bit 4 to FM2	49	YUVD1	O	Y bit 1
10	YUVC3	O	Y bit 3 to FM2	50	YUVD2	O	Y bit 2
11	VSS2	-	Ground 2	51	VDD6	-	Supply voltage 6
12	VDD2	-	Supply voltage 2	52	VSS6	-	Ground 6
13	YUVC2	O	Y bit 2 to FM2	53	YUVD3	O	Y bit 3
14	YUVC1	O	Y bit 1 to FM2	54	YUVD4	O	Y bit 4
15	YUVC0	O	Y bit 0 to FM2	55	YUVD5	O	Y bit 5
16	YUVC11	O	UV bit 3 to FM2	56	YUVD6	O	Y bit 6
17	YUVC10	O	UV bit 2 to FM2	57	YUVD7	O	Y bit 7
18	YUVC9	O	UV bit 1 to FM2	58	VDD7	-	Supply voltage 7
19	YUVC8	O	UV bit 0 to FM2	59	VSS7	-	Ground 7
20	CK	I	Master clock, nominal 27 or 32 MHz	60	SNRST	I	Field frequent reset from microcomputer; reset for SNERT interface
21	VSS3	-	Ground 3	61	SNDA	I/O	Data for SNERT interface
22	VDD3	-	Supply voltage 3	62	SNCL	I	Clock for SNERT interface
23	WE2	O	Write enable to FM2	63	AUX	O	Spare output from line-sequencer
24	RE2	O	Read enable to FM2	64	HO	O	Output hold to e.g. LC display
25	YUVB8	I	UV bit 0 from FM2	65	N.C.	-	Non connection
26	YUVB9	I	UV bit 1 from FM2	66	N.C.	-	Non connection
27	YUVB10	I	UV bit 2 from FM2	67	YUVA7	I	Y bit 7 from FM1
28	YUVB11	I	UV bit 3 from FM2	68	YUVA6	I	Y bit 6 from FM1
29	YUVB0	I	Y bit 0 from FM2	69	YUVA5	I	Y bit 5 from FM1
30	YUVB1	I	Y bit 1 from FM2	70	YUVA4	I	Y bit 4 from FM1
31	YUVB2	I	Y bit 2 from FM2	71	YUVA3	I	Y bit 3 from FM1
32	YUVB3	I	Y bit 3 from FM2	72	YUVA2	I	Y bit 2 from FM1
33	VDD4	-	Supply voltage 4	73	VSS8	-	Ground 8
34	VSS4	-	Ground 4	74	VDD8	-	Supply voltage 8
35	YUVB4	I	Y bit 4 from FM2	75	YUVA1	I	Y bit 1 from FM1
36	YUVB5	I	Y bit 5 from FM2	76	YUVA0	I	Y bit 0 from FM1
37	YUVB6	I	Y bit 6 from FM2	77	YUVA11	I	UV bit 3 from FM1
38	YUVB7	I	Y bit 7 from FM2	78	YUVA10	I	UV bit 2 from FM1
39	RE	I	Master read enable	79	YUVA9	I	UV bit 1 from FM1
40	VD	I	Field frequency reset, vertical display	80	YUVA8	I	UV bit 0 from FM1

PRO-610HD, PRO-510HD, SD-582HD5, SD-532HD5

■ CD74HCT4046AM (SUB VIDEO ASSY : IC3402) (SD-582HD5, SD-532HD5 ONLY)

• PLL IC

● Pin Function

No.	Pin Name	I/O	Pin Function	No.	Pin Name	I/O	Pin Function
1	PCPOUT	O	Phase comparator pulse output	9	VCOIN	I	VCO input
2	PC1OUT	O	Phase comparator 1 output	10	DEMOUT	O	Demodulator output
3	COMPIN	I	Comparator input	11	R1	-	Resistor R1 connection
4	VCOOUT	O	VCO output	12	R2	-	Resistor R2 connection
5	INH	I	Inhibit input	13	PC2OUT	O	Phase comparator 2 output
6	C1A	-	Capacitor C1 connection A	14	SIGIN	I	Signal input
7	C1B	-	Capacitor C1 connection B	15	PC3OUT	O	Phase comparator 3 output
8	GND	-	Ground (0V)	16	VCC	-	Positive supply voltage

■ SAA4955TJ (SUB VIDEO ASSY : IC3405, IC3406) (SD-582HD5, SD-532HD5 Only)

• 2M9 Field Memory IC

● Pin Function

No.	Pin Name	I/O	Pin Function	No.	Pin Name	I/O	Pin Function
1	GNDP	-	Ground for protection circuits	21	VDDP	-	+3.3V +X V supply voltage for protection circuits
2	GND	-	Ground for general purpose	22	VDDQ	-	+3.3V supply voltage for output circuits
3	D11	I	Data input 11	23	OE	I	Output enable
4	D10	I	Data input 10	24	RE	I	Read enable
5	D9	I	Data input 9	25	RSTR	I	Reset read
6	D8	I	Data input 8	26	SRCK	I	Serial read clock
7	D7	I	Data input 7	27	Q0	O	Data output 0
8	D6	I	Data input 6	28	Q1	O	Data output 1
9	D5	I	Data input 5	29	Q2	O	Data output 2
10	D4	I	Data input 4	30	Q3	O	Data output 3
11	D3	I	Data input 3	31	Q4	O	Data output 4
12	D2	I	Data input 2	32	Q5	O	Data output 5
13	D1	I	Data input 1	33	Q6	O	Data output 6
14	D0	I	Data input 0	34	Q7	O	Data output 7
15	SWCK	I	Serial write clock	35	Q8	O	Data output 8
16	RSTW	I	Write reset clock	36	Q9	O	Data output 9
17	WE	I	Write enable	37	Q10	O	Data output 10
18	IE	I	Input enable	38	Q11	O	Data output 11
19	VDDD	-	+3.3V supply voltage for general purpose	39	GNDQ	-	Ground for output circuits
20	VDDP	-	+3.3V +X V supply voltage for protection circuits	40	GNDP	-	Ground for protection circuits

■ SAA4977H-K (SUB VIDEO ASSY : IC3403) (SD-582HD5, SD-532HD5 ONLY)

- BESIC (A/D, D/A Memory Control IC)

● Pin Function

No.	Pin Name	Pin Function	No.	Pin Name	Pin Function
1	SDA	I ² C-bus serial data (port 1.7)	41	YOD3	Y digital output bit 3
2	SCL	I ² C-bus serial data (port 1.6)	42	YOD4	Y digital output bit 4
3	P1.5	Port 1 data input/output signal 5	43	YOD5	Y digital output bit 5
4	P1.4	Port 1 data input/output signal 4	44	YOD6	Y digital output bit 6
5	P1.3	Port 1 data input/output signal 3	45	YOD7	Y digital output bit 7 (MSB)
6	P1.2	Port 1 data input/output signal 2	46	VDDD3	Digital supply voltage 3 (5V)
7	P1.1	Port 1 data input/output signal 1	47	SWC	Serial write clock output
8	VDDD5	Digital supply voltage 5 (3.3V)	48	VSSD2	Digital ground 2
9	RST	Microprocessor reset input	49	TRSTN	Test reset, Low active
10	SNRST	SNERT restart (port 1.0)	50	VSSD2	Digital ground 3
11	VDDD6	Digital supply voltage 6 (3.3V)	51	YID7	Y digital input bit 7 (MSB)
12	SNDA	SNERT data	52	YID6	Y digital input bit 6
13	SNCL	SNERT clock	53	YID5	Y digital input bit 5
14	VSSD4	Digital ground 4	54	YID4	Y digital input bit 4
15	TMS	Test mode select	55	YID3	Y digital input bit 3
16	VSSD1	Digital ground 1	56	YID2	Y digital input bit 2
17	SEL_CLK	Select acquisition clock input; internal PLL if High, external clock if Low	57	YID1	Y digital input bit 1
18	VDDD1	Digital supply voltage 1 (5V)	58	YID0	Y digital input bit 0
19	VDDD2	Digital supply voltage 2 (5V)	59	UVID7	U digital input bit 1
20	VA	Vertical synchronization input, acquisition part	60	UVID6	U digital input bit 0
21	VSSA1	Analog ground 1	61	UVID5	V digital input bit 1
22	HA	Analog/Digital horizontal reference input	62	UVID4	V digital input bit 0
23	VDDA1	Analog supply voltage 1 (5V)	63	RE	Read enable signal output, memory 1
24	RSTW	Reset write signal output, memory 1	64	IE2	Input enable signal output, memory 2
25	VDDA2	Analog supply voltage 2 (5V)	65	VSSIO	I/O ground
26	Y_IN	Y analog input	66	BLND	Horizontal blanking signal output, display part
27	VSSA2	Analog ground 2	67	VDDIO	I/O supply voltage (5V)
28	U_IN	U analog input	68	HRD	Horizontal reference signal output, deflection part
29	VDDA3	Analog supply voltage 3 (5V)	69	VDDD4	Digital supply voltage 4 (3.3V)
30	V_IN	V analog input	70	LLD	Display clock input
31	VSSA3	Analog ground 3	71	HDFL	Horizontal sync signal output, deflection part
32	WE	Write enable signal output, memory 1	72	VDFL	Vertical sync signal output, deflection part
33	LLA	Acquisition clock input	73	VSSA4	Analog ground 4
34	UVOD4	V digital output bit 0	74	V_OUT	V analog output
35	UVOD5	V digital output bit 1	75	VDDA4	Analog supply voltage 4 (3.3V)
36	UVOD6	U digital output bit 0	76	U_OUT	U analog output
37	UVOD7	U digital output bit 1	77	VSSA5	Analog ground 5
38	YOD0	Y digital output bit 0	78	VSSA6	Analog ground 6
39	YOD1	Y digital output bit 1	79	Y_OUT	Y analog output
40	YOD2	Y digital output bit 2	80	VDDA5	Analog supply voltage 5 (3.3V)

■ 24LC128(I)P (DIGITAL CONV. ASSY : IC1410)

• 128Kbit CMOS Serial EEPROM

● Pin Assignment (Top view)

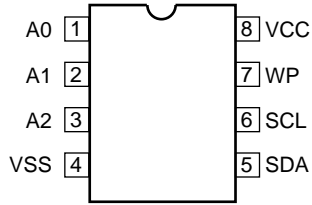

● Pin Function

No.	Pin Name	Pin Function
1	A0	User configurable chip selects
2	A1	
3	A2	
4	VSS	Ground
5	SDA	Serial Data
6	SCL	Serial clock
7	WP	Write protect input
8	VCC	+2.5V to 5.5V power supply

● Block Diagram

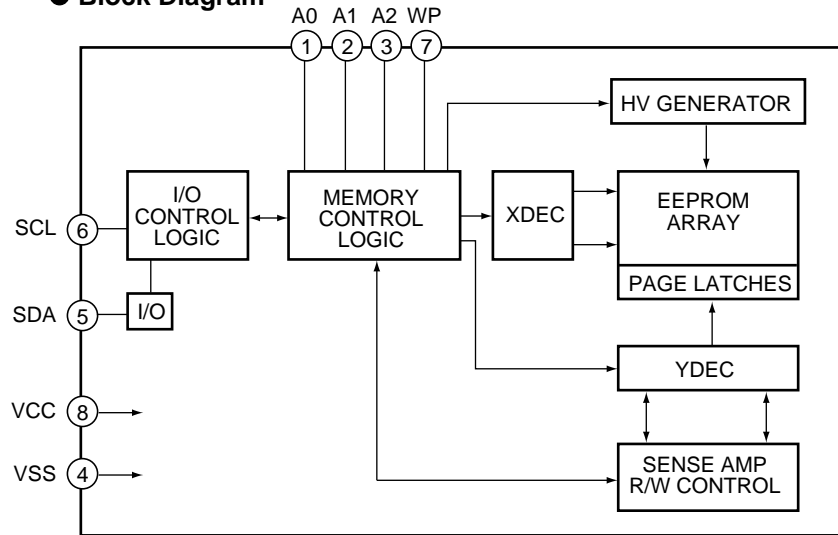

■ 24LC08B(I)P (DIGITAL CONV. ASSY : IC1656)

• 8Kbit CMOS Serial EEPROM

● Pin Assignment (Top view)

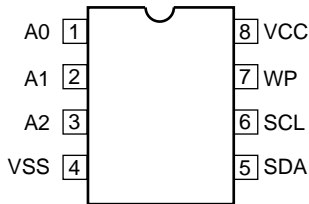

● Pin Function

No.	Pin Name	Pin Function
1	A0	No internal connection
2	A1	
3	A2	
4	VSS	Ground
5	SDA	Serial Address/Data I/O
6	SCL	Serial clock
7	WP	Write protect input
8	VCC	+2.5V to 5.5V power supply

● Block Diagram

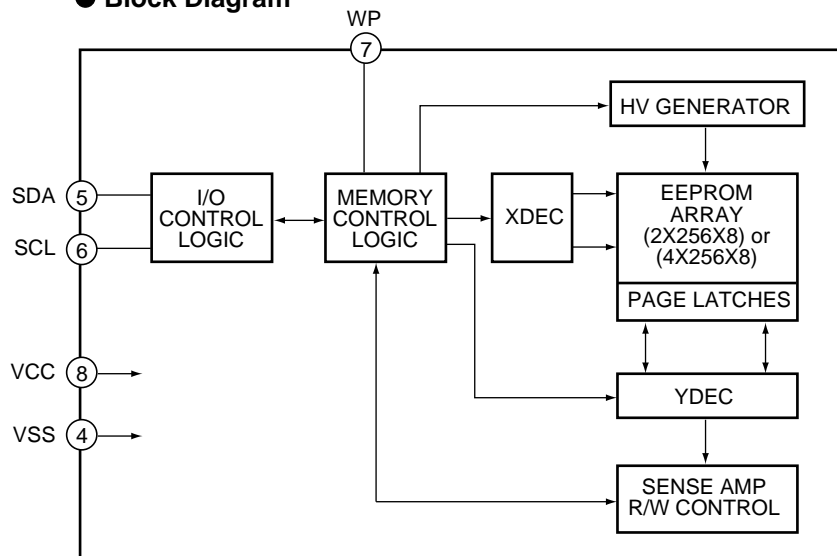

■ CM0006CF (DIGITAL CONV. ASSY : IC1401)

• Digital Convergence Correction IC

• Pin Function

No.	Pin Name	I/O	Pin Function
1	TEST1	I/O	Non connection
2	XSTOP	I/O	Input of compulsory stop for accessing external EEPROM (low active, internal pull-up resistance)
3	XWC	O	Output of write control to external EEPROM (low active)
4	SDAM	I/O	Serial data input/output (open-drain) to external EEPROM for I ² C-bus master
5	SCLM	I/O	Clock output to external EEPROM for I ² C-bus master
6	DVDD	-	+5V power supply to digital circuits
7	DVSS	-	Common of digital circuits
8	XOFDET	O	Output of DSP overflow detection (low active)
9	XMUTE	I	Mute input (low active)
10	XRESET	I	Reset input (low active)
11	XBUSY	O	Busy input (low active)
12	XACKM	O	ACK monitor output (low active)
13	SDAS	I/O	Serial data input/output (open-drain) to external master for I ² C-bus slave
14	SCLS	I/O	Clock input from external master for I ² C-bus slave
15	HBLKIN	I	Horizopntal blanking pulse input (TTL level compatible)
16	PWM1	O	Pulse width modulation output-1
17	PWM2	O	Pulse width modulation output-2
18	VBLKIN	I	Vertical blanking pulse input (TTL level compatible)
19	TEST3	I/O	Non connection
20	ODDEVEN	I/O	Odd/Even input/output, Odd (High)/Even (Low) (internal pull-up resistance)
21	ROUT	O	Red test pattern output
22	GOUT	O	Green test pattern output
23	BOUT	O	Blue test pattern output
24	YMOUT	O	Contrast control output
25	YSOUT	O	OSD control output
26	HBLKOUT	I/O	Regenerated horizontal blanking pulse output (internal pull-up resistance)
27	WCLK	O	Word clock output for external DAC
28	BCLK	O	Bit clock output for external DAC
29	TEST4	I/O	Clock input for external PLL mode
30	TEST5	I/O	Output to phase comparison for external PLL mode
31	PLLVDD	-	+5V analog power supply for VCO and phase detector
32	PDOUT	O	Phase detector output (external loop filter connection to VCOIN terminal)
33	PLLVSS	-	Common of analog circuits for VCO and phase detector
34	VCOIN	I	VCO input (external loop filter connection from PDOUT terminal)
35	R1	-	External resistance for setting VCO initial transmission frequency (external resistance connection)
36	R2	-	External resistance for setting VCO gain (external resistance connection)
37	DAREF	-	Bias for dynamic focus DAC (external filter capacitor connection)
38	DAOUT	O	Dynamic focus DAC output
39	DAVDD	-	+5V analog power supply for dynamic focus DAC
40	DAVSS	-	Common of analog circuits for dynamic focus DAC
41	SHBIAS	I	Bias resistance (external resistance connection)
42	DVSS	-	Common of digital circuits

PRO-610HD, PRO-510HD, SD-582HD5, SD-532HD5

No.	Pin Name	I/O	Pin Function
43	DVDD	–	+5V power supply to digital circuits
44	BVOUT	O	Serial data output of vertical blue convergence
45	GVOUT	O	Serial data output of vertical green convergence
46	RVOUT	O	Serial data output of vertical red convergence
47	DVDD	–	+5V power supply to digital circuits
48	NC	–	Non connection
49	NC	–	Non connection
50	NC	–	Non connection
51	DVDD	–	+5V power supply to digital circuits
52	NC	–	Non connection
53	NC	–	Non connection
54	DVSS	–	Common of digital circuits
55	NC	–	Non connection
56	NC	–	Non connection
57	DVDD	–	+5V power supply to digital circuits
58	BHOUT	O	Serial data output of horizontal blue convergence
59	GHOUT	O	Serial data output of horizontal green convergence
60	RHOUT	O	Serial data output of horizontal red convergence
61	TEST6	I	Non connection
62	TEST7	I	Non connection
63	TEST8	I	Non connection
64	TEST9	I	Non connection
65	TEST10	I	Non connection
66	TEST11	I	Non connection
67	DAMODE	I	External DAC mode setting
68	DIVCNT	I	Divider setting
69	TEST14	I/O	Non connection
70	TEST15	I/O	Non connection
71	TEST16	I/O	Non connection
72	TEST17	I/O	Non connection
73	TEST18	I/O	Non connection
74	TEST19	I/O	Non connection
75	TEST20	I/O	Non connection
76	TEST21	I/O	Non connection
77	TEST22	I/O	Non connection
78	TEST23	I/O	Non connection
79	TEST24	I/O	Non connection
80	TEST25	I/O	Non connection

- Note:** (1) A symbol beginning with "X" indicates negative logic.
(2) The terminals from "TEST1" to "TEST25" excluding "TEST4" and "TEST5" are prohibited to use.
Finish these terminals are open terminals or pull-up to VDD.

■ 24LC32A(I)P (SIGNAL ASSY : IC2454)

• 32Kbit CMOS Serial EEPROM

● Pin Assignment (Top view)

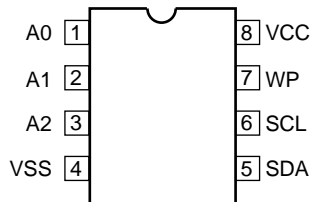

● Pin Function

No.	Pin Name	Pin Function
1	A0	User configurable chip selects
2	A1	
3	A2	
4	VSS	Ground
5	SDA	Serial Address / Data I/O
6	SCL	Serial clock
7	WP	Write protect input
8	VCC	+2.5V to 5.5V power supply

● Block Diagram

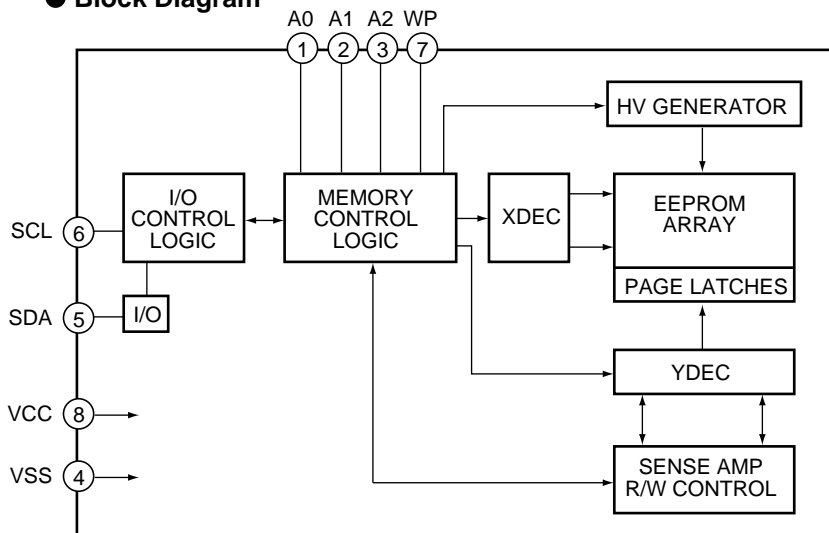

■ ML6420CS-3 (SIGNAL ASSY : IC7501)

• Video Filter IC

● Pin Assignment (Top view)

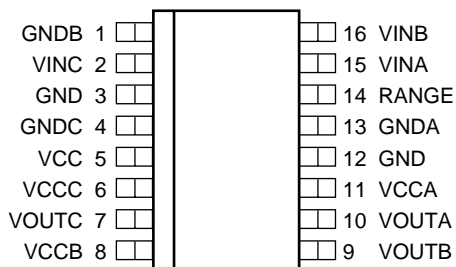

● Pin Function

No.	Pin Name	I/O	Pin Function
1	GNDB	-	Ground for filter B
2	VINC	I	Signal input to filter C
3	GND	-	Power and logic ground
4	GNDC	-	Ground for filter C
5	VCC	-	Positive supply for bias circuit
6	VCCC	-	Power supply voltage for filter C
7	VOUTC	O	Output of filter C
8	VCCB	-	Power supply voltage for filter B
9	VOUTB	O	Output of filter B
10	VOUTA	O	Output of filter A
11	VCCA	-	Power supply voltage for filter A
12	GND	-	power and logic ground
13	GNDA	-	Ground for filter A
14	RANGE	I	Input signal range select
15	VINA	I	Signal input to filter A
16	VINB	I	Signal input to filter B

■ CXA2094Q (SIGNAL ASSY : IC2701)

• US Audio Multi-channel Decoder IC

• Block Diagram

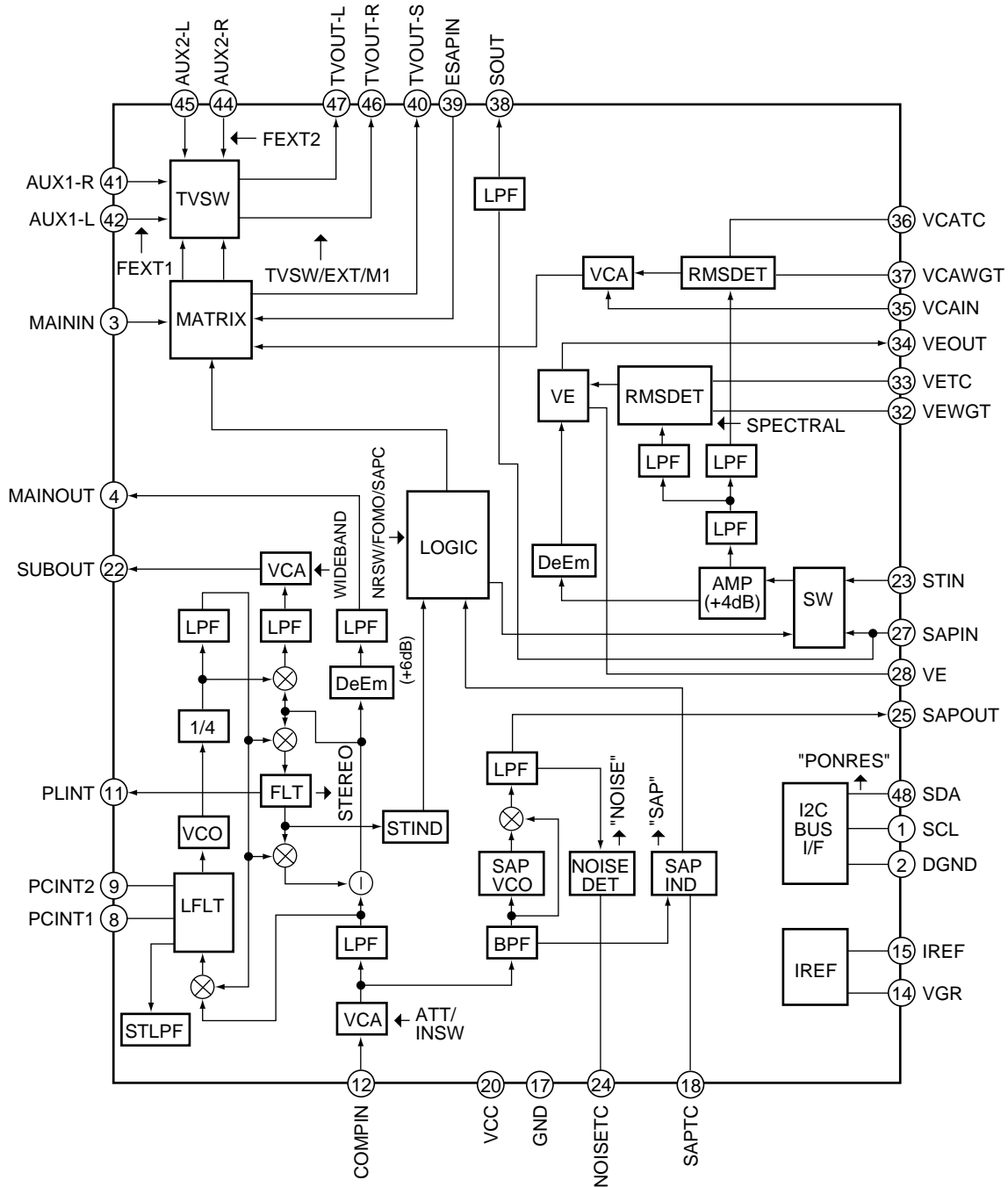

● Pin Function

No.	Pin Name	I/O	Pin Function
1	SCL	I	Serial clock input
2	DGND	–	Digital ground
3	MAININ	I	L+R signal input from MAINOUT (pin 4)
4	MAINOUT	O	L+R signal output
5	NC	–	Non connection
6	NC	–	Non connection
7	NC	–	Non connection
8	PCINT1	–	Integrated pin of the PLL loop filter of the stereo block
9	PCINT2		
10	NC	–	Non connection
11	PLINT	–	Integrated pin of the loop filter of the pilot cancel circuit
12	COMPIN	I	Audio multiple signal input
13	NC	–	Non connection
14	VGR	O	Band gap reference output
15	IREF	–	Set the reference current of the filter and VCO
16	NC	–	Non connection
17	GND	–	Analog ground
18	SAPTC	–	Set the time constant of the SAP carrier detection circuit
19	NC	–	Non connection
20	VCC	–	Power supply
21	NC	–	Non connection
22	SUBOUT	O	L-R signal output
23	STIN	I	L-R signal input from SUBOUT (pin 22)
24	NOISETC	–	Set the time constant of the NOISE detection circuit
25	SAPOUT	O	FM detector output of SAP
26	NC	–	Non connection
27	SAPIN	I	SAP signal input from SAPOUT (pin 25)
28	VE	–	Integrated pin of the variable deemphasis
29	NC	–	Non connection
30	NC	–	Non connection
31	NC	–	Non connection
32	VEWGT	–	Weight the effective value detecting circuit of variable deemphasis control
33	VETC	–	Decides the return time constant of the effective value detecting circuit of variable deemphasis
34	VEOUT	O	Variable deemphasis output
35	VCAIN	I	VCA input Input variable deemphasis output of pin 34 via the coupling capacitor.
36	VCATC	–	Decides the return time constant of the effective value detecting circuit of VCA control
37	VCAWGT	–	Weight the effective value detecting circuit of VCA control
38	SOUT	O	Simple SAP output
39	ESAPIN	I	Signal input from SOUT (pin 38)
40	TVOUT-S	O	Back output pin, it outputs the monaural or simple SAP signal
41	AUX1-R	I	R ch external input 1
42	AUX1-L	I	L ch external input 1
43	NC	–	Non connection
44	AUX2-R	I	R ch external input 2
45	AUX2-L	I	L ch external input 2
46	TVOUT-R	O	TVOUT R ch output
47	TVOUT-L	O	TVOUT L ch output
48	SDA	I/O	Serial data input/output VIH > 3.0V , VIL < 1.5V

PRO-610HD, PRO-510HD, SD-582HD5, SD-532HD5

■ CM0010AF (SIGNAL ASSY : IC7703)

- Multi Screen Controller IC

• Pin Function

(1) A/D Inputs for Main Video Signals

No.	Pin Name	I/O	Pin Function
62	MYIN	I	Main video Y luminance input signal. Typical input level is 1.7Vp-p.
56	MYVREFH	I/O	ADC top reference voltage for main Y signal. Maximum value (2.726V in typical) of ADC dynamic range is set by self-bias.
64	MYVREFL	I/O	ADC bottom reference voltage for main Y signal. Minimum value (0.574V in typical) of ADC dynamic range is set by self-bias.
59	MYVREF16	I/O	Clamp output signal for main Y signal. Clamp level is set to 16 in typical, and Y input is clamped at this level.
60	MYVCLAMP	I/O	For Test (Operation Amplifier output of MYVREF16 pin)
58, 63	AVDD	-	ADC analog power supply voltage for Y signal (x2)
57, 61	AGND	-	ADC analog ground for Y signal (x2)
53	MUIN	I	Sub video V chrominance input signal. Typical input level is 1.7Vp-p.
47	MVIN	I	Sub video U chrominance input signal. Typical input level is 1.7Vp-p.
45	MCVREFH	I/O	ADC top reference signal for sub UV signals.
55	MCVREFL	I/O	ADC bottom reference signal for sub UV signals.
50	MCVREF128	I/O	Clamp output signal for sub UV signals. Clamp level is set to 128 in typical, and UV inputs is clamped at this level.
51	MUCLAMP	I/O	For Test (Operation Amplifier output of MCVREF128 terminal)
49	MVCLAMP	I/O	For Test (Operation Amplifier output of MCVREF129 terminal)
48, 54	AVDD	-	ADC analog power supply voltage for UV signals (x2)
46, 52	AGND	-	ADC analog ground for UV signals (x2)

(2) A/D Inputs for Sub Video Signals

No.	Pin Name	I/O	Pin Function
82	SYIN	I	Sub video Y luminance input signal
76	SYVREFH	I/O	ADC top reference voltage for sub Y signal. Maximum value (2.726V in typical) of ADC dynamic range is set by self-bias.
84	SYVREFL	I/O	ADC bottom reference voltage for sub Y signal. Maximum value (0.574V in typical) of ADC dynamic range is set by self-bias.
79	SYVREF16	I/O	Clamp output signal for sub Y signal. Clamp level is set to 16 in typical, and Y input is clamped at this level.
80	SYCLAMP	-	For Test (Operation Amplifier output of SYVREF16 terminal).
78, 83	AVDD	-	ADC analog power supply voltage for Y signal (x2)
77, 81	AGND	-	ADC analog ground for Y signal (x2)
73	SUIN	I	Sub video U chrominance input signal. Typical input level is 2.0Vp-p.
67	SVIN	I	Sub video V chrominance input signal. Typical input level is 1.7Vp-p.
65	SCVREFH	I/O	ADC top reference signal for sub UV signals
75	SCVREFL	I/O	ADC bottom reference signal for sub UV signals
70	SCVREF128	I/O	Clamp output signal for sub UV signals. Clamp level is set to 128 in typical and UV inputs is clamped at this level.
71	SUCLAMP	I/O	For Test (Operation Amplifier output of MCVREF128 terminal)
69	SVCLAMP	I/O	For Test (Operation Amplifier output of MCVREF128 terminal)
68, 74	AVDD	-	ADC analog power supply voltage for UV signals (x2)
66, 72	AGND	-	ADC analog ground for UV signals (x2)

(3) Main PLL

No.	Pin Name	I/O	Pin Function
120	MHS	I	Main horizontal synchronous input, it inputs NTSC 15.75Hz signal.
121	MCPOUT1	O	Charge pump output, it connects to MVCOIN1 pin through external loop filter.
122	MVCOIN1	I	VCO voltage input
123	MLPFGND	-	Ground for the external loop filter
125	MPLLVDD1	-	Power supply voltage for PLL, it connects to digital power supply voltage.
124	MPLLGND1	-	Ground for PLL, it connects to digital ground.
119	MVS	I	Main vertical synchronous input
131	FB1	O	Divider output of PLL1, it outputs a divided signal in 1820 and is available if constructing the external PLL.
126	MRBIAS	I	Bias setting pin for main VCO (for test), it always sets to open.
127	MBP	O	Bias measuring pin for test
128	MBN	O	Bias measuring pin for test

(4) Sub PLL

No.	Pin Name	I/O	Pin Function
117	SHS	I	Sub horizontal synchronous input
108	SCPOUT	O	Charge pump output, it connects to SVCOIN pin through the external loop filter.
109	SVCOIN	I	VCO voltage input
110	SLPFGND	-	Ground for the external loop filter
112	SPLLVDD	-	Power voltage for PLL, it connects to digital power voltage.
111	SPLLGND	-	Ground for PLL, it connects to digital ground.
116	SVS	I	Sub vertical synchronous input
107	FB3	O	Divider output for PLL3, it outputs a divided signal in 1820 and is available if constructing the external PLL.
113	SRBIAS	I	Bias setting pin for sub VCO (for test), it always sets to open.
114	SBP	O	Bias measuring pin for test
115	SBN	O	Bias measuring pin for test

(5) Image D/A output

No.	Pin Name	I/O	Pin Function
40	YOUT	O	Luminance (Y) output signal. It is current-type output and converts to the voltage by connecting the resistance between YOUT and AGND.
38	UOUT	O	Chrominance (U) output signal. It is current-type output and converts to the voltage by connecting the resistance between YOUT and AGND.
36	VOUT	O	Chrominance (V) output signal. It is current-type output and converts to the voltage by connecting the resistance between YOUT and AGND.
22	NHSO	O	Horizontal synchronous output signal
23	NVSO	O	Vertical synchronous output signal
24	NBLANK	O	Video blanking output signal, it indicates the active period of video output signal.
44	VREF	I	Reference voltage input, it inputs 1V in typical.
43	VG	O	The capacitance pin compensating the gate voltage for current cell, it connects the 0.1 μ F between VG and AGND.
42	FSADJ	I/O	The resistance pin setting the maximum amplitude, it sets a full scale voltage for the DAC by connecting the external resistance.
37, 41	AVDD	-	Analog power supply voltage for DAC (x2)
35, 39	AGND	-	Analog ground for DAC (x2)

PRO-610HD, PRO-510HD, SD-582HD5, SD-532HD5

(6) DRAM

No.	Pin Name	I/O	Pin Function
144-145, 147-149, 151,152, 156,157	ADD [8:0]	O	9 bit DRAM address bus
2-4,158, 160,161, 163-165, 167,168, 170-172, 175,176	DAT [15:0]	I/O	16 bit DRAM data bus
139	NRAS	O	Row address strobe output signal
140	NCAS	O	Column address strobe output signal
141	NWE	O	Write enable output signal
142	NOE	O	Output enable signal

(7) I²C Bus

No.	Pin Name	I/O	Pin Function
137	AS	I	Select pin for I ² C slave address. 0 selects "2C", 1 selects "2E".
135	SDA	I/O	Serial data output signal, it includes ACK signal.
136	SCL	I	Serial clock input signal

(8) Digital Input

No.	Pin Name	I/O	Pin Function
8-15	DY [7:0]	I	Digital Y inputs
25-32	DC [7:0]	I	Digital UV inputs
16	MCLK	I/O	Main 8fsc clock input/output signal
17	SCLK	I/O	Sub 8fsc clock input/output signal
18	MLOP1	O	Main ADC (Y) clamp pulse output signal, it is available for the clamp pulse of the external ADC.
19	MLOP2	O	Main ADC (UV) clamp pulse output signal, it is available for the clamp pulse of the external ADC.
20	SLOP1	O	Sub ADC (Y) clamp pulse output signal
21	SLOP2	O	Sub ADC (UV) clamp pulse output signal

(9) Test

No.	Pin Name	I/O	Pin Function
88-92	TMODE [4:0]	I	Test mode pins, it is always set to Low.
94-101	TDO [7:0]	I/O	8 bit digital output signals/digital input signals for DAC
7	SCANEN	I	Scan test enable signal, it is always set to Low or Open.
106	SYS_STOP	I	System stopping pins except PLL, it is always set to Low.
129	VCOREN	I	VCO bias ON/OFF control pins, it is always set to Low.
130	DEVSEL	I	VCO clock divider ON/OFF control pins, it is always set to Low.

(10) Others

No.	Pin Name	I/O	Pin Function
134	NRST	I	System reset input signal
5,86,87, 105,132, 133,143, 150,159, 166,173, 174	SYSVDD	-	3.3V power supply voltage
1,6,33,34, 93,102, 103,104, 118,138, 146,153, 154,155, 162,169	SYSGND	-	Digital ground (GND)

■ TK15420M (SIGNAL ASSY : IC7102, IC7302, IC7502)
(SUB VIDEO ASSY : IC3002)

• 75ohm Video Driver IC

● Pin Assignment (Top view)

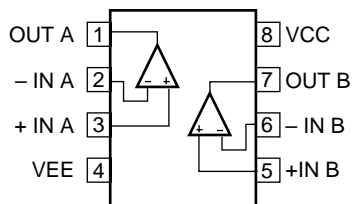

■ MC33167TV (POWER SUPPLY ASSY : IC204)

• Switching Power Supply IC

● Block Diagram

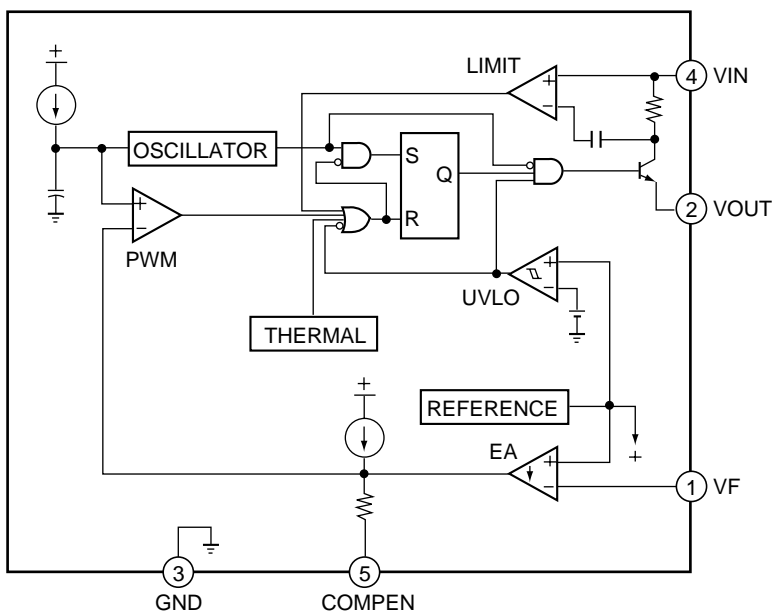

● Pin Function

No.	Pin Name	Pin Function
1	VF	Voltage feedback input
2	VOUT	Switch output
3	GND	Ground
4	VIN	Input voltage / VCC
5	COMPEN	Compensation/Standby

7.3 EXPLANATION

■ CONNECTING VIDEO/AUDION EQUIPMENT

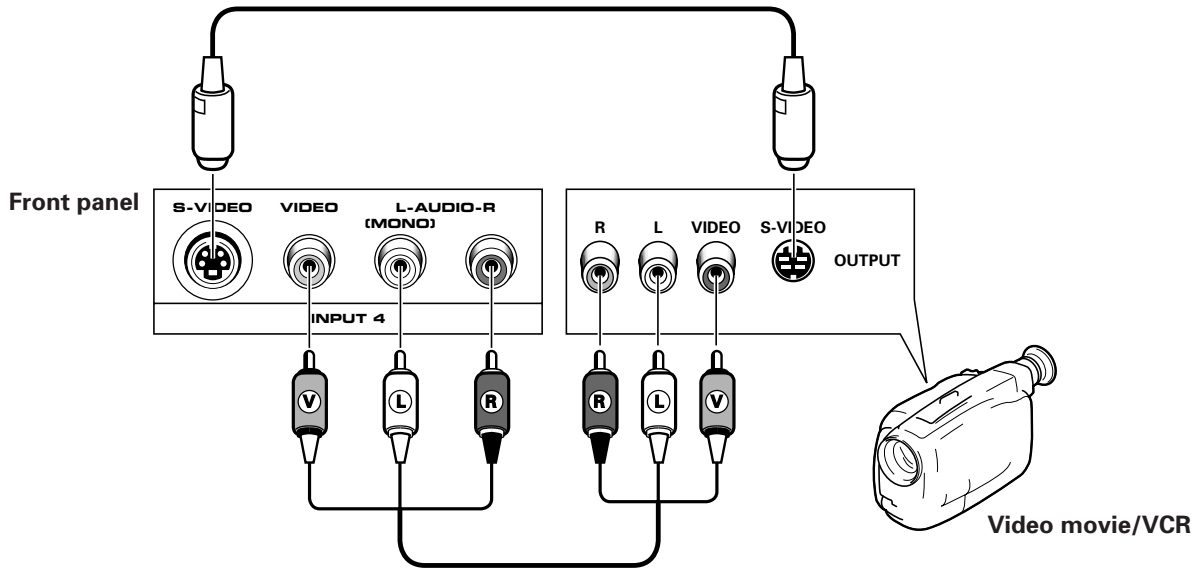

INPUT jacks

There are 4 sets of inputs for VCR and DVD/LD players. Use RCA-type pin plug cords (the same as those used in Hi-Fi systems) for connections. When the audio source to be connected is monaural, connect the source to the L-(MONO) jack.

MONITOR OUTPUT jacks

These are used for connecting the monitor to a VCR for recording, or for linking it to another monitor. These jacks output the video and audio signals of the source currently selected by the INPUT SELECTOR. Connect these output jacks to your VCR's inputs. Connect the VCR's outputs to the monitor's VIDEO inputs.

S-VIDEO INPUT jacks

- Inputs S-VHS video signals or signals from a DVD/LD player that has an S-VIDEO output jack.
- When the signal input from the S-VIDEO INPUT jack is output from the MONITOR OUTPUT jack, the output signal will be a composite of Y and C.

COMPONENT VIDEO INPUT jack

Inputs three signals – Y, P_B (Cb) and P_R (Cr) – output from DVD players and the like.

Input formats in which images can be received.

	Format	Horizontal frequency	Vertical frequency
DVD player, etc.	480 i	15.734 kHz	60 Hz
Digital tuner, etc.	1080 i	33.75 kHz	60 Hz
	480 p	31.468 kHz	60 Hz

RGB INPUT jack

Inputs five signals – R, G, B, H and V – output from digital tuners and the like.

Input format in which images can be received.

	Format	Horizontal frequency	Vertical frequency
Digital tuner	1080 i	33.75 kHz	60 Hz

NOTES:

- *SPLIT* screen, *FREEZE* screen and *SEARCH* screen functions cannot be used when 1080i or 480p component signals are input.
- Signals from MONITOR OUTPUT jacks will not be output when component signals or RGB signals are input.
- The RGB input jack is designed for use in connecting a digital tuner with RGB signal output, and it should accordingly never be used for connecting to a personal computer or other device.

NOTE:

Setting the INPUT 3 SELECT switch to 'RGB' will cause all S-Video and composite images input from the INPUT 3 jack to be suppressed. Similarly, setting the INPUT 3 SELECT switch to 'S-VIDEO/VIDEO' will cause all images input from the RGB input jack to be suppressed.

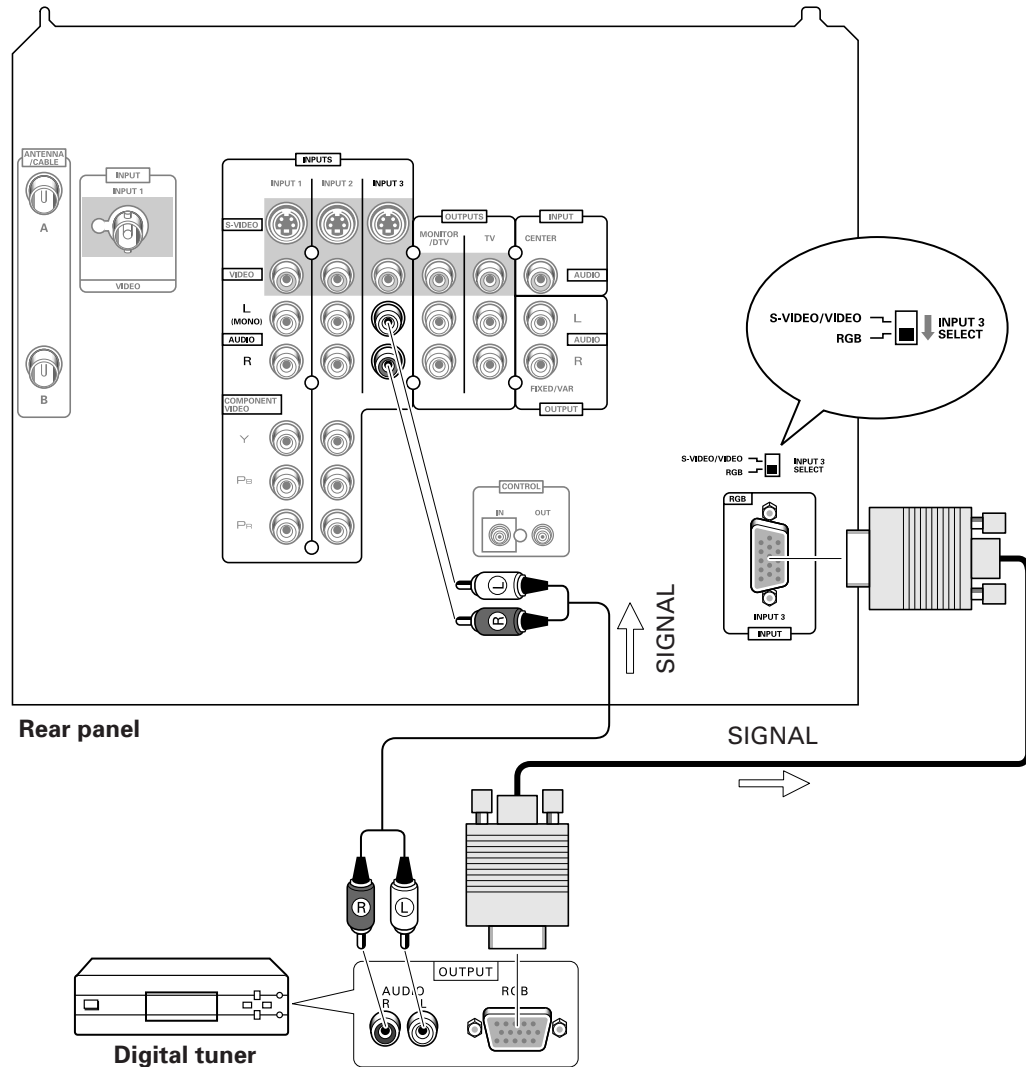

■ TO WATCH TV

To turn off the sound

Press the MUTING button.



When mute is turned on, a volume indicator will appear in red on the screen (and will disappear in a few seconds). If the MUTING button is pressed while a closed caption signal is being received, CC/TEXT will be displayed. Press MUTING again to return to the previous volume level.

Auto power off function

If the monitor is receiving no input signals in TV mode, its power will turn off (go on standby) after some time has passed.

PROGRAM BLOCK (V. CHIP) FUNCTION

Since laws have been passed in the United States requiring a way of blocking undesirable programming, the V-chip has become a required component in television sets. The V-chip is a computer chip which decodes signals added to broadcast signals transmitted by television broadcasters. These signals are classified by programming content (e.g., amount of violence or sexual content) and age, and viewers may specify settings which block certain types of programming.

Program blocking may be set to a specific level judged by parents to be harmful to children depending on their age or the content of the programming in question, and the V-chip makes it impossible for such children to view programs with ratings exceeding the specified level.

The V-chip uses the following rating system.

MPAA RATING

RATING		
Age-Base	G	GENERAL AUDIENCES. All ages admitted.
	PG	PARENTAL GUIDANCE SUGGESTED. Some material may not be suitable for children.
	PG-13	PARENTAL STRONGLY CAUTIONED. Some material may be inappropriate for children under 13.
	R	RESTRICTED. Under 17 requires accompanying parent or adult guardian.
	NC-17	NO ONE 17 AND UNDER ADMITTED.
	X	X Rating is an older rating that is unified with NC-17 but may be encoded on older movie's data.
	NR	NOT RATED

TV PARENTAL GUIDELINES

RATING		Description and Content Themes				
		FV	D	L	S	V
Age-Base	TV-Y	–	–	–	–	–
	TV-Y7	○	–	–	–	–
	TV-G	–	–	–	–	–
	TV-PG	–	○	○	○	○
	TV-14	–	○	○	○	○
	TV-MA	–	–	○	○	○

FV: Fantasy Violence
 D: Sexually Suggestive Dialog
 L: Adult Language
 S: Sexual Situations
 V: Violence

TV-Y All Children. This program is designed to be appropriate for all children.

TV-Y7 Directed to Older Children. This program is designed for children age 7 and above.

Note: For those programs where fantasy violence may be more intense or more combative than other programs in this category, such programs will be designated TV-Y7-FV.

TV-G General Audience. Most parents would find this program suitable for all ages.

TV-PG Parental Guidance Suggested. This program contains material that parents may find unsuitable for younger children.

The program contains one or more of the following:
 (D) Some suggestive dialogue
 (L) Infrequent coarse language
 (V) Moderate violence
 (S) Some sexual situations

TV-14 Parents Strongly Cautioned. This program contains some material that many parents would find unsuitable for children under 14 years of age.

This program contains one or more of the following:
 (D) Intensely suggestive dialogue
 (L) Strong coarse language
 (S) Intense sexual situations
 (V) Intense violence

TV-MA Mature Audience Only. This program is specifically designed to be viewed by adults and therefore may be unsuitable for children under 17.

This program contains one or more of the following:
 (L) Crude indecent language
 (S) Explicit sexual activity
 (V) Graphic violence

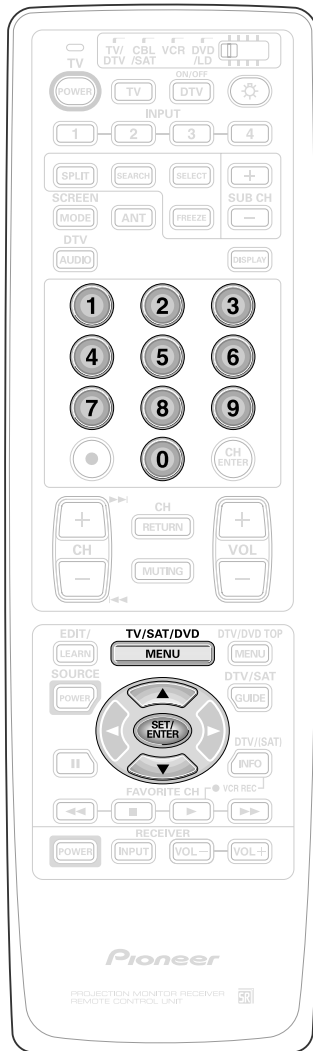

SETTING THE PROGRAM BLOCKING LEVEL

1 Press MENU and select **SET UP** by using the ▲ or ▼ button and then pressing SET/ENTER.

2 Select **PROGRAM BLOCK** in the same way.

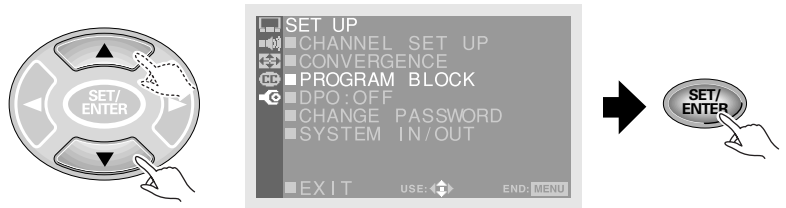

3 Enter password.

- Press numeric buttons '0' through '9' to enter a four-digit password.
- If the password has not been changed as described in Changing Password, enter the default password of '1234'.
- If you wish to change the password, see p. 36 Changing Password for instructions on how to do so.

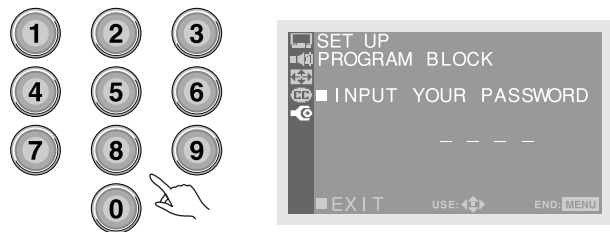

4 Select **BLOCK** .



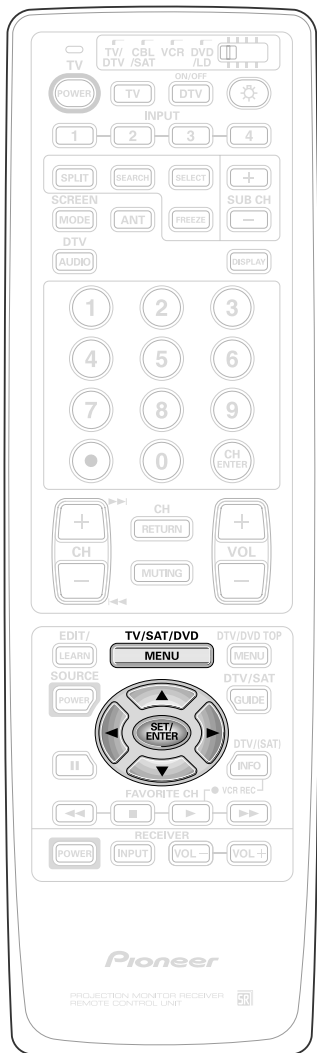

5 Set BLOCK to ON.

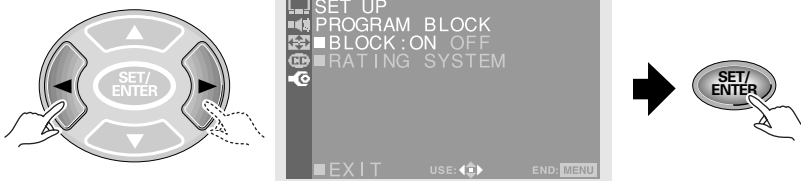

6 Select MPA A RATING or TV PARENTAL GUIDELINES .

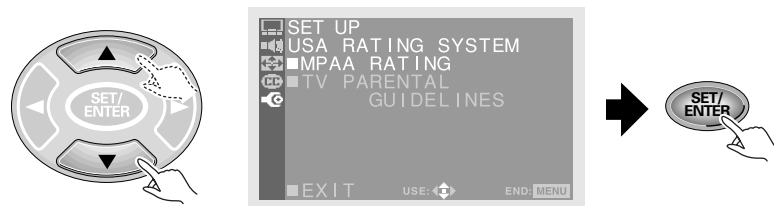

7 Select and then confirm the rank of the MPA A RATING.

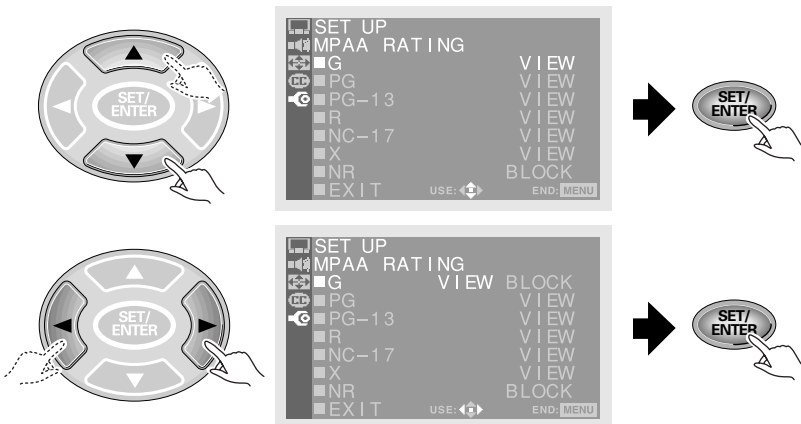

8 Select and confirm the rank of the TV PARENTAL GUIDELINES.



NOTE:

- Blocking programming with a low rating will cause all programming with a higher rating also to be blocked.
- The 'NR' (not rated) of the MPA A RATING may be set to 'View' or 'Block' without regarded to other ratings.

- Each time the SET/ENTER button is pressed, the setting will toggle between 'B' (Block) and 'V' (View).

9 After setting, press MENU to turn the menu off.



HOW TO REMOVE BLOCKING FROM A PROGRAM IN PROGRESS

When a selected program or a program on a channel to which you have just changed has a rating higher than the current program blocking rating, the picture and sound will cut off and an enter password screen will appear.

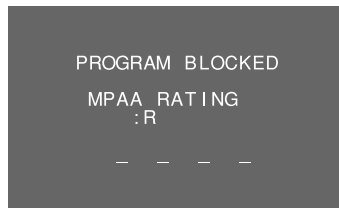

Once the password has been entered, blocking will be removed.

NOTE:

Even when a password has been entered to cancel a block, if the monitor power is turn OFF then turned ON again, the Program Blocked screen will appear.

REMOVING BLOCKING IN MULTI-SCREEN MODE

- Just as in normal single-screen mode, programs are blocked in SPLIT screen and SEARCH screen mode (see pages 40 and 41), but blocking may be removed only from the Main picture.
- To remove blocking from a Sub picture or Search picture screen, switch to the Main picture for that channel and then remove blocking.
- When viewing in FREEZE screen (p. 40) mode, only programming on the Moving screen to the left will be blocked and the programming on the Still screen to the right will be displayed as is.

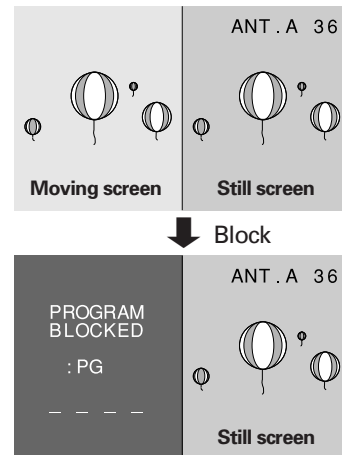

- When blocking is on during SEARCH screen mode, the screen at search picture side will be blacked out (mute) without displaying: "PROGRAM BLOCKED".

■ CHANGING PASSWORD

If you forget the password

When the message 'INPUT YOUR PASSWORD' shown in step 3 is displayed, press the RETURN button on the front panel and hold it down for 3 seconds or longer.

The password will become "1234".

■ MULTI-SCREEN FUNCTION

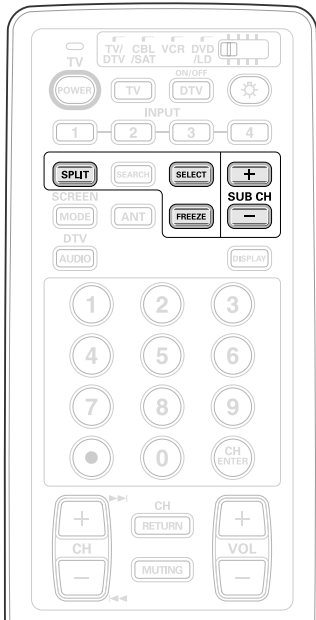

VIEWING TWO SCREENS (SPLIT screen)

The screen can be split vertically, making it possible to view different images on the left and right.

Press the SPLIT button.

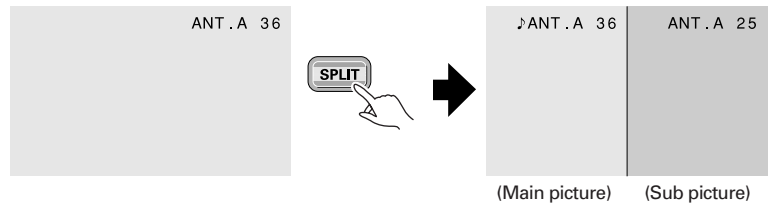

- The screen on which is displayed is the main picture, and the other screen is the sub-picture. Sound will be output for the main picture.
- Regular operations can be performed on the main picture.
- When the SUB CH +/- buttons are pressed, the channel for the sub-picture will be changed.
- When the SELECT button is pressed, the will move to the other screen.
- The MONITOR OUTPUT terminal outputs the main picture signal.
- Pressing the SPLIT button again will restore the original screen.

NOTES:

- The same image cannot be viewed as both the main picture and the sub-picture.
- Pressing the MENU button in SPLIT or FREEZE screen mode restores the screen display to normal and displays the menu on screen.
- These functions cannot be used while watching a DTV broadcast using the SH-D09 digital tuner (sold separately).
- These functions cannot be used when INPUT 1 or INPUT 2 is receiving a 1080i or 480p component signal (or the signals might not be received or noise might be generated).
- When a TV broadcast is being received, the screen on the right will not show the antenna B signal.
- RGB signals input from INPUT3 cannot be displayed.
- Continuous operation for extended periods in SPLIT or FREEZE screen mode may burn out the screen. We thus recommend that these modes only be used in conjunction with the normal screen mode.
- If the non-interlace signal for a TV game etc. is entered to the left screen during SPLIT screen mode, the right screen may be disrupted. If this occurs, use the right screen for TV game etc. entry.

MAKING NOTES ON PROGRAM CONTENT (FREEZE screen)

The screen can be frozen, such as for taking down a recipe from a cooking program or an address for entering a quiz or the like.

Press the FREEZE button.

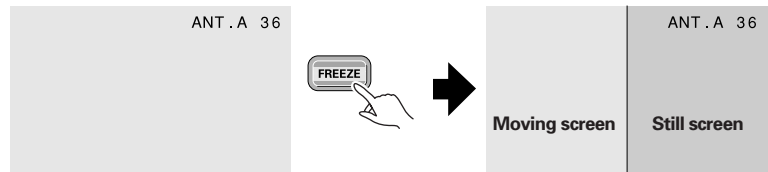

- This function is operable only with the normal screen.
- Pressing the FREEZE button again will restore the original screen.

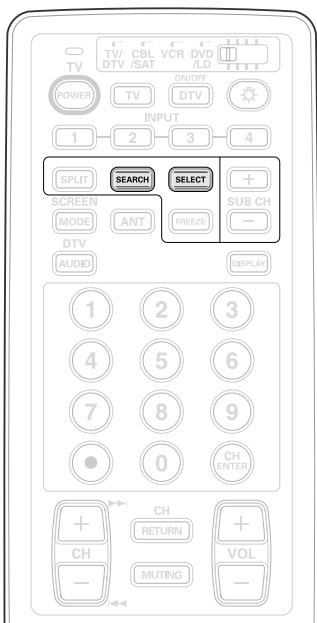

SEARCHING FOR A PROGRAM ON A DIFFERENT CHANNEL (SEARCH screen)

The screen on the right side can be made into nine or three different screens, making it possible to search for programs or enjoy multiple images.

Press the SEARCH button.



- Each time the SEARCH button is pressed, the screen mode changes in the following order.

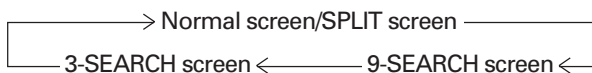

- Pressing the MENU button in SEARCH screen mode restores the screen display to normal and displays the menu on screen.
- These functions cannot be used while watching a DTV broadcast using the SH-D09 digital tuner (sold separately).
- These functions cannot be used when INPUT 1 or INPUT 2 is receiving a 1080i or 480p component signal (or the signals might not be received or noise might be generated).
- RGB signals input from INPUT3 cannot be displayed.
- Continuous operation for extended periods in SEARCH screen mode may burn out the screen. We thus recommend that these modes only be used in conjunction with the normal screen mode.
- The only channels displayed on the SEARCH screen will be those with input signals input from antenna A. Antenna B channels cannot be displayed on this screen.
- If the non-interlace signal for a TV game etc. is entered to the left screen during 9-SEARCH screen or 3-SEARCH screen modes, the screen may be disrupted.

① 9-SEARCH screen

▶ ANT . A 36	1	4	8
	12	18	30
	41	49	52

Main picture Search picture

- On the search picture, the antenna A preset channel (see page 28) will be displayed as a frozen image. If 9 or more channels have been preset, the screens will automatically be switched and displayed.
- The search picture cannot be operated.
- If the channel or input source is changed, SEARCH screen mode will turn off.

② 3-SEARCH screen

▶ ANT . A 36	A 4
	A 10
	A 8

Main picture Search picture

- Press the SELECT button to select image that you wish to switch the channel or input source to. When the color of the channel or input indicator changes to yellow, screen operations can be performed. (Use only the selector buttons, direct channel selection buttons and CH +/- buttons.)
- Sound output is limited to the main picture.

■ MULTI-SCREEN FUNCTION

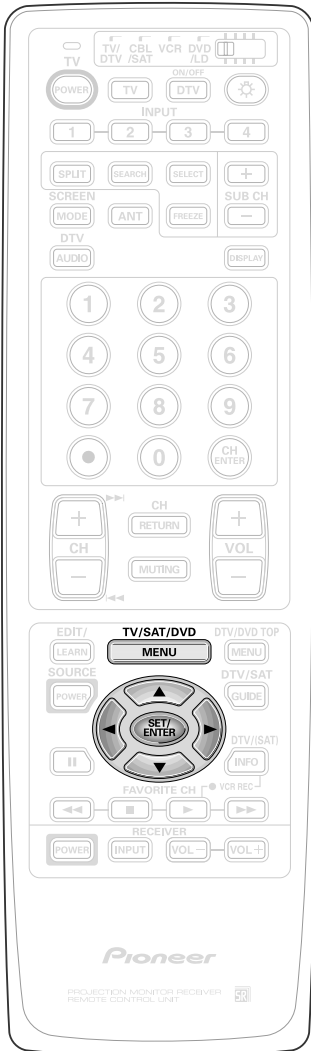

Convergence adjustment may be fined-tuned from here.

1 Press MENU and select **SET UP** by using the ▲ or ▼ button and then pressing SET/ENTER.

2 Adjust the center point convergence.

3 Select **ADJ MULTI-POINT**.



4 Select the adjust point.

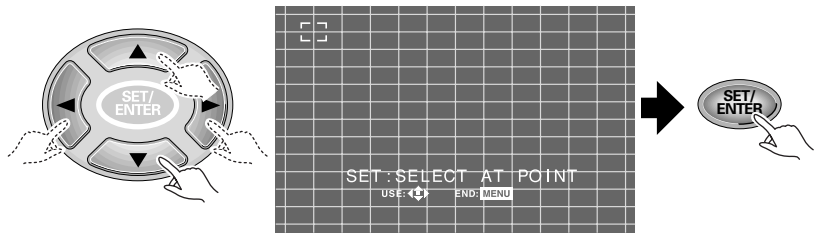

5 Adjust the red line.



NOTES:

- The number of adjustment points varies according to the screen mode. The cursor is partially invisible around the edge of the screen according to the screen mode.
- It is not possible to adjust all these points (points of change on the cross-hatch).
- Some of the cross-hatch lines are not straight, but this is not a malfunction. They are not always straight on a normal TV.

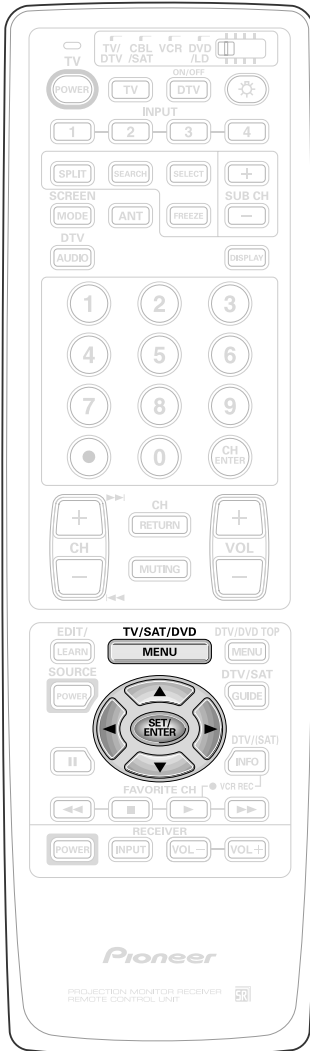

6 Adjust the blue line.



- The brackets which shows the adjusting point will move in order.
Move to the next point to be adjusted, and repeat steps 4 to 6.

7 After completing the convergence adjustment, press MENU to turn the menu off.



■ SPECIAL NOTES

● Picture Adjustments

MOVIE or GAME mode may not be selected when receiving RGB input.

GAME mode setting:

- All signals output from the Projection Monitor will be unaffected. Only the original output signal is sent through the output jacks.

Picture Quality setting:

- The *COLOR*, *TINT*, and *SHARP* settings may not be changed when receiving RGB input.
- When *DPO* is on, *CONTRAST*, *BLACK LEVEL* and *COLOR* cannot be adjusted.
- When picture quality has been adjusted, the user mode data will be overwritten with the new settings.

Other Picture Quality setting:

Only the COLOR TEMP settings may be changed when receiving RGB input.

PURECINEMA adjustment:

Normally, this function should be set to "HQ" (High Quality), however, occasionally this setting may cause slight syncopation problems with the audio track. If you are bothered by this, select "STD" (Standard) or "OFF". If "OFF" is selected, normal progressive signal processing is performed.

● Sound Adjustments

BASS, TREBLE and BALANCE are SPEAKER mode settings, which can only be adjusted when mode is NORMAL.

Surround Mode setting:

- This function cannot be used when the *SPEAKER* mode is *CENTER IN* or when the *SPEAKER* mode is *OFF* and *AUDIO OUT* mode is *FIXED*.
- The surround effect cannot be obtained with mono sound.
- In some cases, the surround effect may be minimal.

● Connection with Receiver (1)

Speaker and AUDIO OUT Setting:

- After the speaker mode is set to *CENTER IN*, the volume of the center speaker should be controlled from this monitor.
- If *AUDIO OUT* is set to *VAR* and the sound is distorted, lower the Monitor volume.

● Connection with Receiver (2)

SYSTEM MODE ON :

- The input cannot be switched even if you press the Input selector button of the remote control unit.
- On the sub-picture of a *SPLIT* screen, only the input signal from the antenna can be displayed.
- The *SEARCH* screen function will not be operable.
- No signal will be output from the *AUDIO OUTPUT* terminal.
- Setting *SYSTEM MODE ON* will cause RGB input signals to not be displayed.

● Changing Screen Mode

- When 1080i or 480p component signals or RGB signals are input, *SCREEN MODE* will be limited to *FULL*.

8. PANEL FACILITIES AND SPECIFICATIONS

■ PANEL FACILITIES for PRO-610HD and PRO-510HD

A flip-down door conceals the control panel. Push gently and release, to open the door. To close the door, lift it back up into place.

NOTE:

If you accidentally pull the door, it may not shut properly. Push the door back in to shut it.



① **POWER STANDBY/ON indicator**

red: STANDBY
green: ON

② **DTV indicator**

Lights when receiving a digital television broadcast. If the SH-D09 digital tuner (sold separately) has been connected, the DTV indicator may still blink even when the power has been turned off. (This is not a defect.)

③ **DPO sensor**

Sensor to detect the room brightness.

④ **MAIN POWER switch**

Press once to turn on the main power (STANDBY mode). Press again to turn off the main power.

⑤ **POWER button (STANDBY/ON)**

Press once to turn on the Monitor. Press again to turn off the Monitor.

⑥ **INPUT SELECTOR button**

Press to select your program source. Each press of the INPUT SELECTOR changes the selection to the next source.



⑦ **CHANNEL buttons**

Press plus (+) or minus (-) to tune to a higher or lower channel. Only the preset channels can be tuned in using these buttons.

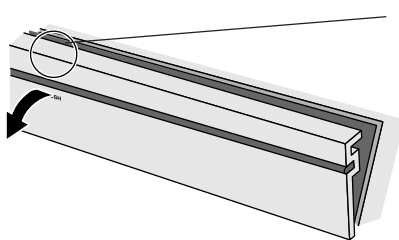

In some cases, the door may only open slightly when pushed. In such cases, open the door with your finger as shown in the figure at left.

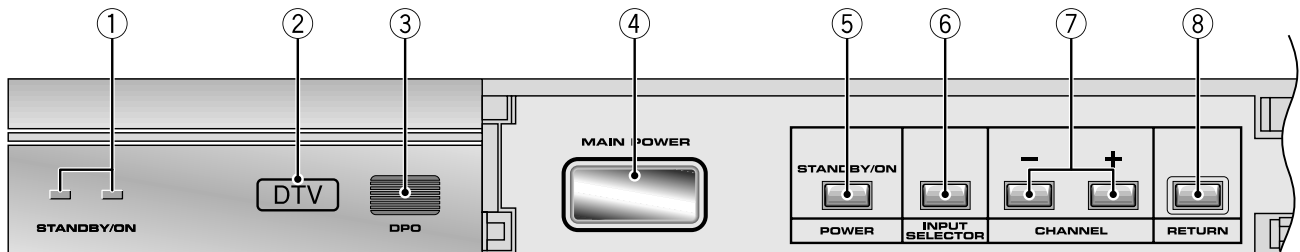

⑧ **RETURN button**

Press to set the Projection Monitor to its initial mode.

Initial mode

Input selector:	Set to TV.
TV channel:	Remains at the last channel set.
VOLUME:	Remains at the last setting.
MUTING:	OFF
PICTURE	
MODE:	STD
Parameters:	Set to 0.
3D Y/C LEVEL:	3
3D NR LEVEL:	3
COLOR TEMP:	STD
FLESH TONE:	ON
PURECINEMA:	HQ
SVM	HIGH
SOUND	
MTS:	MAIN
Parameters:	Set to 0.
SURROUND:	OFF
SUPER BASS:	OFF
SCREEN	
MODE:	NATURAL WIDE
V. POSITION:	Set to 0.
CC:	OFF
DPO:	OFF
SYSTEM IN/OUT	
SPEAKER:	NORMAL
AUDIO OUT:	FIXED
SYSTEM MODE:	OFF
DTV OUT:	OFF (When the SH-D09 is connected)

- When this button is pressed while adjusting the MULTI-POINT convergence, the MULTI-POINT convergence returns to the initial mode.

⑨ **VOLUME buttons**

Press plus (+) button to increase the volume, press minus (-) button to decrease it.

⑩ **INPUT 4 jacks**

These inputs are for Video Movie and VCR. Use RCA-type pin plug cords (the same as those used in Hi-Fi systems) and S-VIDEO cords for connections. When the audio source to be connected is monaural, connect the source to the L-(MONO) jack.

CAUTION:

Do not press any operation button on the Projection Monitor or the remote control unit while recording. Signals from the MONITOR OUTPUT jacks may be temporarily interrupted when a button is pressed.

ATTENTION

The Projection Monitor Receiver will not function properly in the following cases.

- An electrical discharge in the CRT.
- Lightning storms.
- High static electricity environment.
- Poor voltage regulation in the power source.

If the Projection Monitor does not operate properly, reset it as follows:

1. Turn off the power of the unit with the ④ MAIN POWER switch.
2. After approximately 1 minute, turn on the power with ④ MAIN POWER switch and ⑤ POWER button.

If the normal operation cannot be restored after the above treatment, immediately unplug the power cord and call your nearest PIONEER-authorized service center.

NOTE:

On rare occasions, an electrical discharge may occur inside the CRT. It makes a short, sharp pop and either no sound is produced or the volume level changes by itself. The SPLIT screen and SEARCH screen functions will be cancelled automatically if an electrical discharge occurs when this function is engaged.

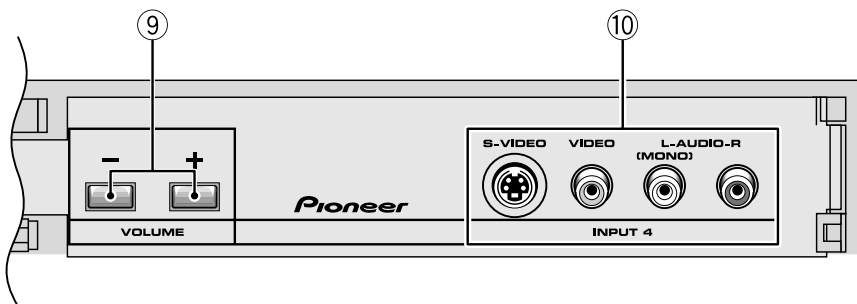

■ REMOTE CONTROL UNIT (AXD1448: CU-SD110) for PRO-610HD and PRO-510HD

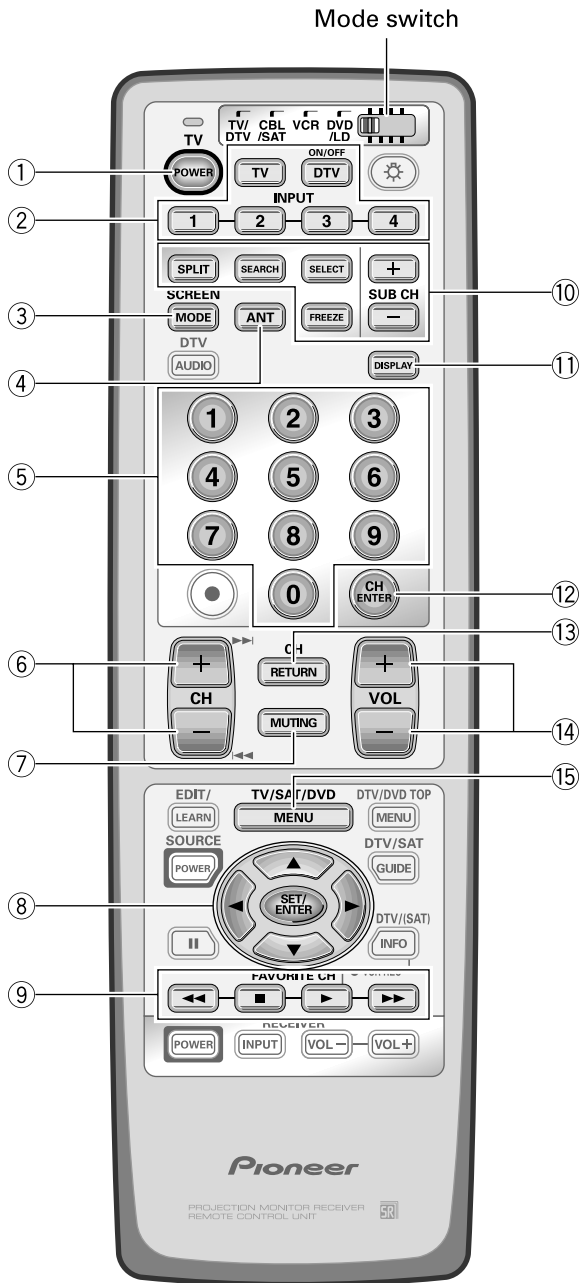

Set the mode switch to TV/DTV.

- ① **TV POWER button (STANDBY/ON)**
Turns the power of the monitor on and off.
- ② **Input Selector buttons (TV, DTV*1, INPUT 1 to INPUT 4)**
Press the button to select the source you wish to watch. The screen will display your selection.
- ③ **SCREEN MODE button**
Press to select the SCREEN MODE.
- ④ **ANT (antenna selector) button**
Press to switch between ANTENNA-A and ANTENNA-B when you wish to watch TV.
- ⑤ **Direct channel selection buttons**
Press the button (or buttons) that corresponds to the channel that you wish to watch.
- ⑥ **CH (channel) +, - button**
Press plus (+) or minus (-) to tune in a higher or lower channel. Only the preset channels can be tuned in using these buttons.
- ⑦ **MUTING button**
Press to temporarily turn off the sound. Press again to return to the previous volume level.
- ⑧ **Select/Adjust/Set buttons (SET/ENTER, ◀, ▶, ▲, ▼)**
◀, ▶, ▲, ▼: Press to select or adjust items on the menu screen.
SET/ENTER: Press to activate the selected function.
- ⑨ **FAVORITE CH buttons**
These buttons call up the channels that have been assigned to them.

⑩ **SPLIT/SEARCH screen buttons**

- SPLIT:** Press to turn the SPLIT screen function on and off.
- SEARCH:** Press to select the SEARCH screen mode.
- SELECT:** Selects the screen for switching the channel or input source.*2
- FREEZE:** When this button is pressed with the regular screen, the screen will change to the SPLIT screen and the picture at the time the button was pressed will become the sub-picture, displayed as a frozen image.
- SUB CH +, -:** Used to switch the channel for the sub-picture of the SPLIT screen.

⑪ **DISPLAY button**

Press to display the input source, channel, setting and other screen indicators for a few seconds.

⑫ **CH ENTER button**

Fix the selected channel with the direct channel selection buttons.

⑬ **CH RETURN (channel return) button**

Press to switch between the current channel and the channel you were watching immediately before.

⑭ **VOL (volume) +, - buttons**

Press plus (+) button to increase the volume, press minus (-) button to decrease it.
Volume level will appear on the screen as numbers and a bar graph. The maximum volume level is "63".
The display will disappear from the screen after 2 seconds.

⑮ **MENU button**

Press to turn on the menu screen for use in function selection.
Press again to return to normal TV screen.

*1 For viewing DTV broadcasts, the SH-D09 digital tuner (sold separately) is necessary.

*2 With the 9-SEARCH screen, the search picture's input source and channel cannot be switched.

■ **PANEL FACILITIES for SD-582HD5 and SD-532HD5**

A flip-down door conceals the control panel. Push gently and release, to open the door. To close the door, lift it back up into place.

NOTE:
If you accidentally pull the door, it may not shut properly. Push the door back in to shut it.

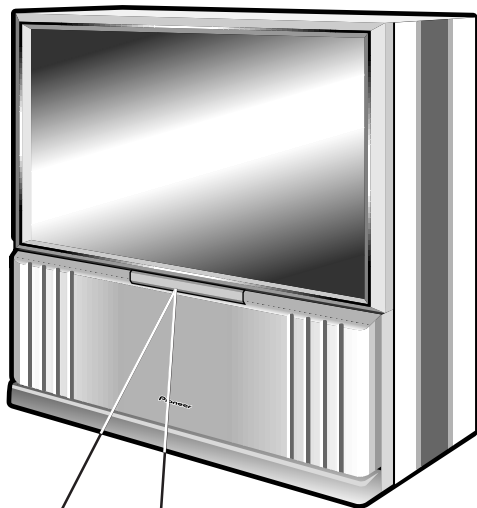

① **POWER STANDBY/ON indicator**

red: STANDBY
green: ON

② **DPO sensor**

Sensor to detect the room brightness.

③ **MAIN POWER switch**

Press once to turn on the main power (STANDBY mode). Press again to turn off the main power.

④ **POWER button (STANDBY/ON)**

Press once to turn on the Monitor. Press again to turn off the Monitor.

⑤ **INPUT SELECTOR button**

Press to select your program source. Each press of the INPUT SELECTOR changes the selection to the next source.



⑥ **CHANNEL buttons**

Press plus (+) or minus (-) to tune to a higher or lower channel. Only the preset channels can be tuned in using these buttons.

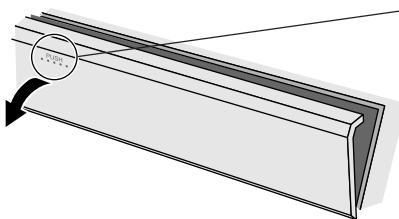

In some cases, the door may only open slightly when pushed. In such cases, open the door with your finger as shown in the figure at left.

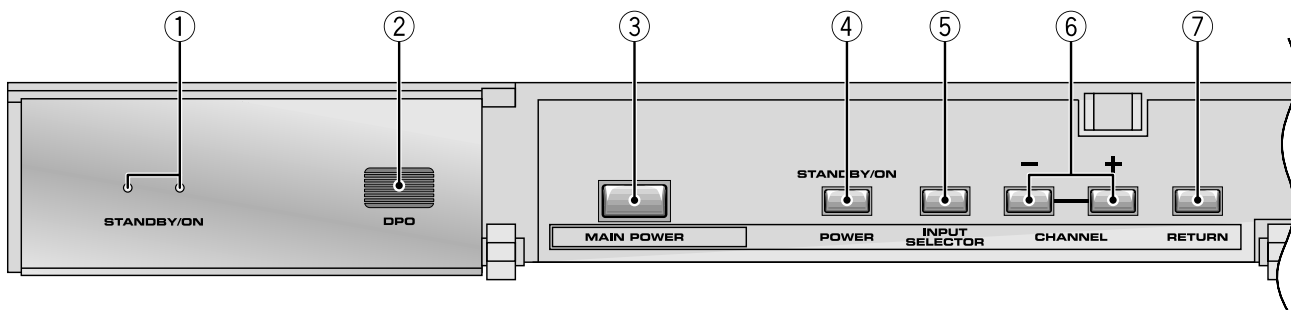

⑦ RETURN button

Press to set the Projection Monitor to its initial mode.

Initial mode

Input selector:	Set to TV.
TV channel:	Remains at the last channel set.
VOLUME:	Remains at the last setting.
MUTING:	OFF
PICTURE	
MODE:	STD
Parameters:	Set to 0.
3D Y/C LEVEL:	3
3D NR LEVEL:	3
COLOR TEMP:	STD
FLESH TONE:	ON
SOUND	
MTS:	MAIN
Parameters:	Set to 0.
SURROUND:	OFF
SUPER BASS:	OFF
SCREEN	
MODE:	NATURAL WIDE
V. POSITION:	Set to 0.
CC:	OFF
DPO:	OFF

- When this button is pressed while adjusting the MULTI-POINT convergence, the MULTI-POINT convergence returns to the initial mode.

⑧ VOLUME buttons

Press plus (+) button to increase the volume, press minus (-) button to decrease it.

⑨ INPUT 4 jacks

These inputs are for Video Movie and VCR. Use RCA-type pin plug cords (the same as those used in Hi-Fi systems) and S-VIDEO cords for connections. When the audio source to be connected is monaural, connect the source to the L-(MONO) jack.

CAUTION:

Do not press any operation button on the Projection Monitor or the remote control unit while recording. Signals from the MONITOR OUTPUT jacks may be temporarily interrupted when a button is pressed.

ATTENTION

The Projection Monitor Receiver will not function properly in the following cases.

- An electrical discharge in the CRT.
- Lightning storms.
- High static electricity environment.
- Poor voltage regulation in the power source.

If the Projection Monitor does not operate properly, reset it as follows:

1. Turn off the power of the unit with the ③ MAIN POWER switch.
2. After approximately 1 minute, turn on the power with ③ MAIN POWER switch and ④ POWER button.

If the normal operation cannot be restored after the above treatment, immediately unplug the power cord and call your nearest PIONEER-authorized service center.

NOTE:

On rare occasions, an electrical discharge may occur inside the CRT. It makes a short, sharp pop and either no sound is produced or the volume level changes by itself. The SPLIT screen and SEARCH screen functions will be cancelled automatically if an electrical discharge occurs when this function is engaged.

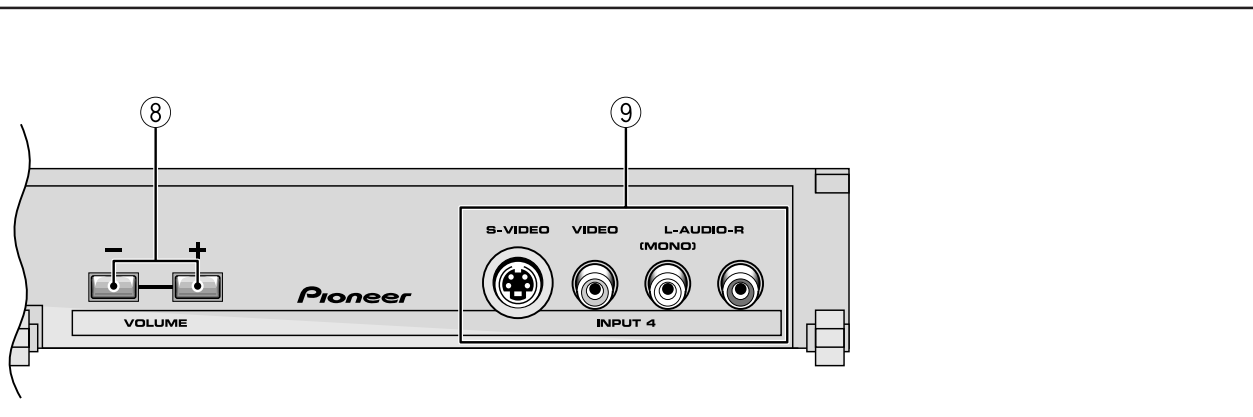

■ REMOTE CONTROL UNIT (AXD1449: CU-SD111) for SD-582HD5 and SD-532HD5

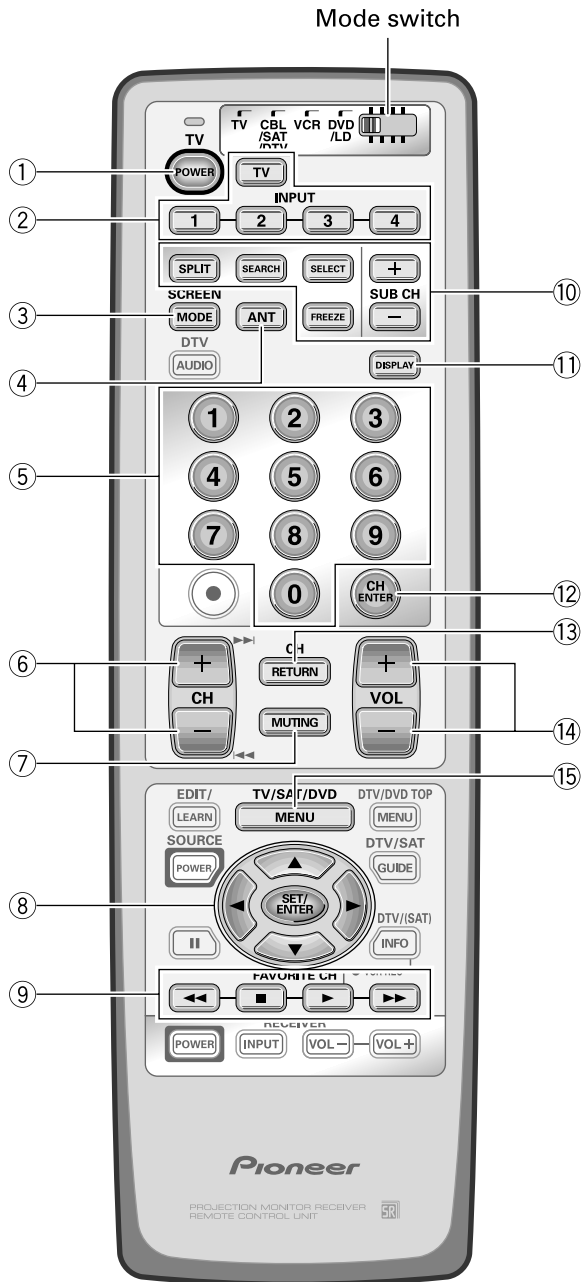

Set the mode switch to TV.

- ① **TV POWER button (STANDBY/ON)**
Turns the power of the monitor on and off.
- ② **Input Selector buttons (TV, INPUT 1 to INPUT 4)**
Press the button to select the source you wish to watch. The screen will display your selection.
- ③ **SCREEN MODE button**
Press to select the SCREEN MODE.
- ④ **ANT (antenna selector) button**
Press to switch between ANTENNA-A and ANTENNA-B when you wish to watch TV.
- ⑤ **Direct channel selection buttons**
Press the button (or buttons) that corresponds to the channel that you wish to watch.
- ⑥ **CH (channel) +, - button**
Press plus (+) or minus (-) to tune in a higher or lower channel. Only the preset channels can be tuned in using these buttons.
- ⑦ **MUTING button**
Press to temporarily turn off the sound. Press again to return to the previous volume level.
- ⑧ **Select/Adjust/Set buttons (SET/ENTER, ◀, ▶, ▲, ▼)**
◀, ▶, ▲, ▼: Press to select or adjust items on the menu screen.
SET/ENTER: Press to activate the selected function.
- ⑨ **FAVORITE CH buttons**
These buttons call up the channels that have been assigned to them.

⑩ **SPLIT/SEARCH screen buttons**

- SPLIT:** Press to turn the SPLIT screen function on and off.
- SEARCH:** Press to select the SEARCH screen mode.
- SELECT:** Selects the screen for switching the channel or input source.*1
- FREEZE:** When this button is pressed with the regular screen, the screen will change to the SPLIT screen and the picture at the time the button was pressed will become the sub-picture, displayed as a frozen image.
- SUB CH +, -:** Used to switch the channel for the sub-picture of the SPLIT screen.

⑪ **DISPLAY button**

Press to display the input source, channel, setting and other screen indicators for a few seconds.

⑫ **CH ENTER button**

Fix the selected channel with the direct channel selection buttons.

⑬ **CH RETURN (channel return) button**

Press to switch between the current channel and the channel you were watching immediately before.

⑭ **VOL (volume) +, - buttons**

Press plus (+) button to increase the volume, press minus (-) button to decrease it.
Volume level will appear on the screen as numbers and a bar graph. The maximum volume level is "63".
The display will disappear from the screen after 2 seconds.

⑮ **MENU button**

Press to turn on the menu screen for use in function selection.
Press again to return to normal TV screen.

*1 With the 9-SEARCH screen, the search picture's input source and channel cannot be switched.

NOTE:

If the remote control unit is left in total darkness for a long period of time, it will not emit light, but will not be damaged. In this case, place it in a bright place for a little while before using it.

■ SPECIFICATIONS for PRO-610HD and PRO-510HD

Display and amplifier section

Reception system	American TV standard NTSC system
Screen size	58" (PRO-610HD) 53" (PRO-510HD)
CRT	7" High focus CRT x 3
Brightness (White peak)	420 Foot-Lambert (PRO-610HD) 500 Foot-Lambert (PRO-510HD) [White window signal input contrast Max.] without protective screen
Horizontal resolution	More than 1250 lines (PRO-610HD) More than 1150 lines (PRO-510HD) [Input digital test pattern (1250 lines resolution)]
Input terminals	4 video inputs 4 S-VIDEO input jacks (Y/C separate INPUT) 2 COMPONENT VIDEO INPUT jacks (Y, P _B , P _R) 4 audio inputs CENTER INPUT jack Mini D-sub 15 pin INPUT jack (RGB)
Output terminals	MONITOR/DTV, TV, AUDIO
Input terminal signal ratings	
Input signal	
Video signal:	
Composite and S-VIDEO (Y):	1.0 Vp-p (75 ohms load)
COMPONENT (Y):	1.0 Vp-p (75 ohms load)
(P _B , P _R):	0.7 Vp-p (75 ohms load)
Mini D-sub 15 pin (RGB):	0.7 Vp-p (75 ohms load)
Audio signal (including CENTER):	400mV rms
Input impedance	Video input: 75 ohms Audio input (including CENTER): 22 kilo-ohms or more
Input signal polarity (Video)	Synchronized negative
Output terminal signal ratings	
Output signal	Video signal: 1 Vp-p (75 ohms load) Audio signal: 500 mV rms (100 % modulation)
Output impedance	Video output: 75 ohms Audio output: Less than 1 kilo-ohms
Effective output	
Front both channels driven	10 W + 10 W (THD. 1 % 1 kHz, 8 ohms)
Built-in speaker system	16 cm (6-5/16 in) full range x 2

Tuner section

Circuit type	Video signal detection: PLL full synchronous detection PLL digital synthesizer system Audio multiplex: BTSC system
Reception channels	VHF; CH2~CH13, UHF; CH14~CH69 CATV (STANDARD, IRC or HRC) CATV 1-125 CH
Antenna terminals	Antenna terminal, 75 ohms UNBAL, F-type connector (VHF, UHF MIXED)

Electrical section, miscellaneous

Power requirements	120 V AC, 60 Hz
Power consumption	
At time of shipment	325 W, 600 VA (CSA)
With digital tuner installed	360 W, 660 VA (CSA)
External dimensions	
PRO-610HD	1378 (W) x 675 (D) x 1351 (H) mm 54-1/4 (W) x 26-9/16 (D) x 53-3/16 (H) inch
PRO-510HD	1268 (W) x 640 (D) x 1289 (H) mm 49-15/16 (W) x 25-3/16 (D) x 50-3/4 (H) inch
Weight of main unit	
PRO-610HD	141 kg (311 lb 9 oz)
PRO-510HD	127 kg (280 lb 6 oz)

Wireless remote control unit

Operation system	Infrared remote control system
Power source	Two DURACELL® "AA" MN1500 1.5 V ALKALINE dry cell batteries
Dimensions	66 (W) x 24.6 (H) x 226.5 (D) mm 2-19/32 (W) x 31/32 (H) x 8-29/32 (D) inch
Weight	170 g (4 oz) (without batteries)

Accessories

Operating instructions	1
Warranty card	1
Remote control unit	1
DURACELL® "AA" MN1500 1.5V Alkaline dry cell batteries	2
Protective screen	1
Panel frame	2
Side frame cover	2
Frame cover	2
Panel frame attaching screw	10 (PRO-610HD) 6 (PRO-510HD)

NOTE:

Specifications and design are subject to possible modifications without notice due to improvements.

■ SPECIFICATIONS for SD-582HD5 and SD-532HD5

Display and amplifier section

Reception system	American TV standard NTSC system
Screen size	58" (SD-582HD5) 53" (SD-532HD5)
CRT	7" High focus CRT x 3
Brightness (White peak)	480 Foot-Lambert (SD-582HD5) 580 Foot-Lambert (SD-532HD5) [White window signal input contrast Max.] without protective screen
Horizontal resolution	More than 1000 lines (SD-582HD5) More than 1000 lines (SD-532HD5) [Input digital test pattern (1000 lines resolution)]
Input terminals	4 video inputs 4 S-VIDEO input jacks (Y/C separate INPUT) 2 COMPONENT VIDEO INPUT jacks (Y, Pb, Pr) 4 audio inputs Mini D-sub 15 pin INPUT jack (RGB)
Output terminals	MONITOR
Input terminal signal ratings	
Input signal	
Video signal:	
Composite and S-VIDEO (Y):	1.0 Vp-p (75 ohms load)
COMPONENT (Y):	1.0 Vp-p (75 ohms load)
(Pb, Pr):	0.7 Vp-p (75 ohms load)
Mini D-sub 15 pin (RGB):	0.7 Vp-p (75 ohms load)
Audio signal (including CENTER):	400mV rms
Input impedance	Video input: 75 ohms Audio input (including CENTER): 22 kilo-ohms or more
Input signal polarity (Video)	Synchronized negative
Output terminal signal ratings	
Output signal	Video signal: 1 Vp-p (75 ohms load) Audio signal: 500 mV rms (100 % modulation)
Output impedance	Video output: 75 ohms Audio output: Less than 1 kilo-ohms
Effective output	
Front both channels driven	10 W + 10 W (THD. 1 % 1 kHz, 8 ohms)
Built-in speaker system	16 cm (6-5/16 in) full range x 2

Tuner section

Circuit type	Video signal detection: PLL full synchronous detection PLL digital synthesizer system Audio multiplex: BTSC system
Reception channels	VHF; CH2~CH13, UHF; CH14~CH69 CATV (STANDARD, IRC or HRC) CATV 1-125 CH
Antenna terminals	
.....	Antenna terminal, 75 ohms UNBAL, F-type connector (VHF, UHF MIXED)

Electrical section, miscellaneous

Power requirements	120 V AC, 60 Hz
Power consumption	310 W, 575 VA (CSA)
External dimensions	
SD-582HD5	1378 (W) x 661 (D) x 1351 (H) mm 54-1/4 (W) x 26 (D) x 53-3/16 (H) inch
SD-532HD5	1268 (W) x 626 (D) x 1289 (H) mm 49-15/16 (W) x 24-11/16 (D) x 50-3/4 (H) inch
Weight of main unit	
SD-582HD5	131 kg (289 lb 3 oz)
SD-532HD5	121 kg (267 lb 2 oz)

Wireless remote control unit

Operation system	Infrared remote control system
Power source	Two DURACELL® "AA" MN1500 1.5 V ALKALINE dry cell batteries
Dimensions	66 (W) x 24.6 (H) x 226.5 (D) mm 2-19/32 (W) x 31/32 (H) x 8-29/32 (D) inch
Weight	170 g (4 oz) (without batteries)

Accessories

Operating instructions	1
Warranty card	1
Remote control unit	1
DURACELL® "AA" MN1500 1.5V	
Alkaline dry cell batteries	2

NOTE:

Specifications and design are subject to possible modifications without notice due to improvements.