

# DVP-S9000ES

RMT-D122A/D122E/D1220/D122P

## SERVICE MANUAL

**Self Diagnosis**  
Supported model



Photo: Gold type

*US Model  
Canadian Model  
AEP Model  
UK Model  
Australian Model  
Chinese Model  
Hong Kong Model*

### SPECIFICATIONS

#### SACD/DVD player

Laser Semiconductor laser  
Signal format system PAL / (NTSC)

#### Audio characteristics

Frequency response  
DVD (PCM 96 kHz): 2 Hz to 44 kHz  
(-2 dB  $\pm$ 1 dB at 44 kHz)  
CD: 2 Hz to 20 kHz ( $\pm$ 0.5 dB)  
SACD: 2 Hz to 100 kHz (-3 dB  $\pm$ 1 dB at 50 kHz)

Signal to noise ratio  
more than 115 dB (DVD)

Harmonic distortion  
DVD: Less than 0.0015%  
CD: Less than 0.002%  
SACD: Less than 0.0015%

Dynamic range  
More than 103 dB (DVD)  
More than 103 dB (SACD)  
More than 99 dB (CD)

Wow and flutter  
Less than detected value  
( $\pm$ 0.001% W PEAK)

#### Outputs

	Jack type	Output level	Load impedance
AUDIO OUT (1, 2)	Phono jacks	2 Vrms (at 50 kilohms)	Over 10 kilohms
DIGITAL OUT (OPTICAL)	Optical output connector	-18 dBm	Wave length: 660 nm
DIGITAL OUT (COAXIAL)	Phono jack	0.5 Vp-p	75 ohms terminated
VIDEO OUT	Phono jacks	1.0 Vp-p	75 ohms, sync negative
S VIDEO OUT	4-pin mini DIN	Y: 1.0 Vp-p C: 0.3 Vp-p (PAL) (EXCEPT US, Canadian) C: 0.286 Vp-p (NTSC)	75 ohms, sync negative 75 ohms terminated
COMPONENT VIDEO OUT (Y, Pb/Cb, Pr/Cr)	Phono jacks	Y: 1.0 Vp-p Pb/Cb, Pr/Cr: $\pm$ 0.35 Vp-p	75 ohms, sync negative 75 ohms

#### General

Power requirements  
220 - 240 V AC, 50 / 60 Hz  
120 V AC, 60Hz (EXCEPT US, Canadian)

Power consumption  
48 W  
43 W (EXCEPT US, Canadian)

Dimensions (approx.)  
430  $\times$  126  $\times$  398 mm (17  $\times$  5  $\times$  15 <sup>11</sup>/<sub>16</sub> in.)  
(w / h / d) incl. projecting parts

Mass (approx.)  
12.6 kg (27 lb 12 oz)

Operating temperature  
5  $^{\circ}$ C to 35  $^{\circ}$ C (41  $^{\circ}$ F to 95  $^{\circ}$ F)

Operating humidity  
25% to 80%

#### Supplied accessories

Check that you have the following items:

- Audio connecting cord (1)
- Video connecting cord (1)
- S-link (Control S) connecting cord (1)
- S video cord (1)
- Power cord (1)
- Remote commander (remote) (1)
- Size AA (R6) batteries (2)

Design and specifications are subject to change without notice.



**SACD/DVD PLAYER**

**SONY**<sup>®</sup>

## SAFETY CHECK-OUT

After correcting the original service problem, perform the following safety checks before releasing the set to the customer:

1. Check the area of your repair for unsoldered or poorly-soldered connections. Check the entire board surface for solder splashes and bridges.
2. Check the interboard wiring to ensure that no wires are "pinched" or contact high-wattage resistors.
3. Look for unauthorized replacement parts, particularly transistors, that were installed during a previous repair. Point them out to the customer and recommend their replacement.
4. Look for parts which, though functioning, show obvious signs of deterioration. Point them out to the customer and recommend their replacement.
5. Check the line cord for cracks and abrasion. Recommend the replacement of any such line cord to the customer.
6. Check the B+ voltage to see it is at the values specified.
7. Check the antenna terminals, metal trim, "metallized" knobs, screws, and all other exposed metal parts for AC leakage. Check leakage as described below.

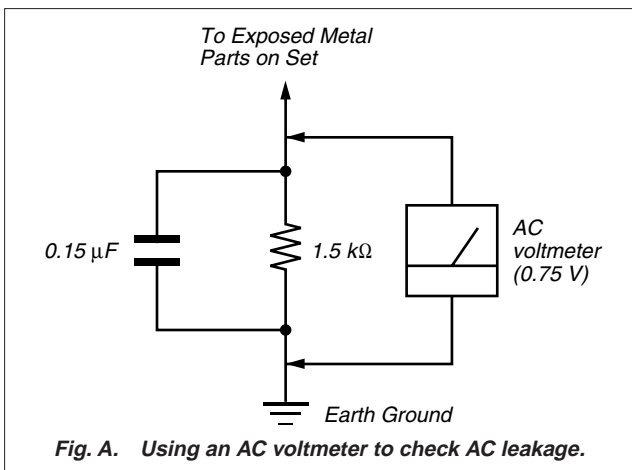

### WARNING!!

**WHEN SERVICING, DO NOT APPROACH THE LASER EXIT WITH THE EYE TOO CLOSELY. IN CASE IT IS NECESSARY TO CONFIRM LASER BEAM EMISSION, BE SURE TO OBSERVE FROM A DISTANCE OF MORE THAN 25 cm FROM THE SURFACE OF THE OBJECTIVE LENS ON THE OPTICAL PICK-UP BLOCK.**

### SAFETY-RELATED COMPONENT WARNING!!

COMPONENTS IDENTIFIED BY MARK  $\triangle$  OR DOTTED LINE WITH MARK  $\triangle$  ON THE SCHEMATIC DIAGRAMS AND IN THE PARTS LIST ARE CRITICAL TO SAFE OPERATION. REPLACE THESE COMPONENTS WITH SONY PARTS WHOSE PART NUMBERS APPEAR AS SHOWN IN THIS MANUAL OR IN SUPPLEMENTS PUBLISHED BY SONY.

### LEAKAGE TEST

The AC leakage from any exposed metal part to earth ground and from all exposed metal parts to any exposed metal part having a return to chassis, must not exceed 0.5 mA (500 microamperes). Leakage current can be measured by any one of three methods.

1. A commercial leakage tester, such as the Simpson 229 or RCA WT-540A. Follow the manufacturers' instructions to use these instruments.
2. A battery-operated AC milliammeter. The Data Precision 245 digital multimeter is suitable for this job.
3. Measuring the voltage drop across a resistor by means of a VOM or battery-operated AC voltmeter. The "limit" indication is 0.75V, so analog meters must have an accurate low-voltage scale. The Simpson 250 and Sanwa SH-63Trd are examples of a passive VOM that is suitable. Nearly all battery operated digital multimeters that have a 2V AC range are suitable. (See Fig. A)

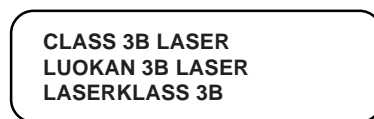
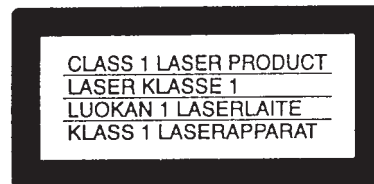
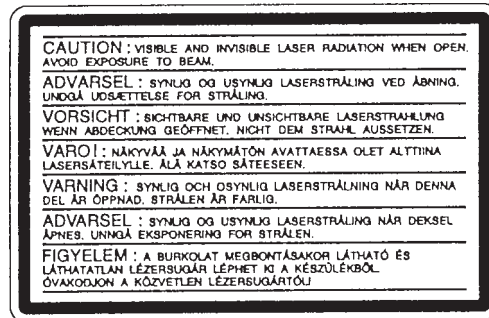

### CAUTION:

The use of optical instrument with this product will increase eye hazard.

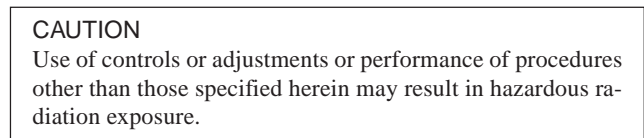

### ATTENTION AU COMPOSANT AYANT RAPPORT À LA SÉCURITÉ!

LES COMPOSANTS IDENTIFIÉS PAR UNE MARQUE  $\triangle$  SUR LES DIAGRAMMES SCHÉMATIQUES ET LA LISTE DES PIÈCES SONT CRITIQUES POUR LA SÉCURITÉ DE FONCTIONNEMENT. NE REMPLACER CES COMPOSANTS QUE PAR DES PIÈCES SONY DONT LES NUMÉROS SONT DONNÉS DANS CE MANUEL OU DANS LES SUPPLÉMENTS PUBLIÉS PAR SONY.

## TABLE OF CONTENTS

<u>Section</u>	<u>Title</u>	<u>Page</u>	<u>Section</u>	<u>Title</u>	<u>Page</u>
Service Note .....		5	VP-52 (PROGRESSIVE) Schematic Diagram .....		4-51
			VP-52 (SGRAM) Schematic Diagram .....		4-53
			VP-52 (D/A CONVERTER) Schematic Diagram .....		4-55
			VP-52 (VIDEO BUFFER) Schematic Diagram .....		4-57
			AU-226, CO-26 Printed Wiring Boards .....		4-59
			AU-226 (D/A CONVERTER, DIGITAL FILTER), CO-26 (DIGITAL OUT COAXIAL JACK) Schematic Diagram .....		4-63
			AU-226 (CURRENT PULSE D/A, AMP) Schematic Diagram .....		4-65
			ER-11 Printed Wiring Board .....		4-67
			ER-11 (EURO AV1) Schematic Diagram .....		4-71
			ER-11 (EURO AV2) Schematic Diagram .....		4-73
			FL-114 Printed Wiring Board .....		4-75
			BZ-1 Printed Wiring Board .....		4-78
			FL-114 (IF CON) Schematic Diagram .....		4-79
			FL-114 (LED DRIVE), BZ-1 (BUZZER) Schematic Diagram .....		4-81
			FR-172 Printed Wiring Board .....		4-83
			FR-172 (DC-DC CONVERTER, REMOTE COMMANDER RECEIVER) Schematic Diagram .....		4-85
			AC-113/114, SW-344 Printed Wiring Boards .....		4-87
			AC-113/114 (STANDBY), SW-344 (POWER SWITCH) Schematic Diagram .....		4-91
			MS-59 (LOADING MOTOR), CK-95 (SENSOR) Printed Wiring Boards and Schematic Diagram .....		4-93
			PS-436/438 Printed Wiring Board .....		4-95
			PS-436/438 (POWER SUPPLY) Schematic Diagram .....		4-99
			PS-437/439 (POWER SUPPLY) Schematic Diagram .....		4-101
			PS-437/439 Printed Wiring Board .....		4-103
<b>1. GENERAL</b>					
	This Player Can Play the Following Discs .....	1-1			
	Getting Started .....	1-2			
	Playing Discs .....	1-4			
	Using Various Functions with the Control Menu .....	1-6			
	Settings and Adjustments .....	1-12			
	Additional Information .....	1-16			
<b>2. DISASSEMBLY</b>					
2-1.	Top Case Removal .....	2-1			
2-2.	Front Panel Removal .....	2-1			
2-3.	FL-114 Board Removal .....	2-1			
2-4.	MB-91 Board Removal .....	2-1			
2-5.	PS-436/437/438/439 Board Removal .....	2-2			
2-6.	AV-226 Board Removal .....	2-2			
2-7.	Mechanism Deck Removal .....	2-2			
2-8.	TK-58 Board Removal .....	2-2			
2-9.	Loading Assembly Removal .....	2-3			
2-10.	Optical Pick-up Removal .....	2-3			
2-11.	Base Assembly Removal .....	2-3			
2-12.	Internal View .....	2-4			
2-13.	Circuit Boards Location .....	2-5			
<b>3. BLOCK DIAGRAMS</b>					
3-1.	Overall Block Diagram .....	3-1			
3-2.	RF/Servo Block Diagram .....	3-3			
3-3.	Signal Process 1 Block Diagram .....	3-5			
3-4.	Signal Process 2 Block Diagram .....	3-7			
3-5.	Video 1 Block Diagram .....	3-9			
3-6.	Video 2 Block Diagram .....	3-11			
3-7.	System Control Block Diagram .....	3-13			
3-8.	Audio Block Diagram .....	3-15			
3-9.	Interface Control Block Diagram .....	3-17			
3-10.	Power 1 Block Diagram .....	3-19			
3-11.	Power 2 Block Diagram .....	3-21			
<b>4. PRINTED WIRING BOARDS AND SCHEMATIC DIAGRAMS</b>					
4-1.	Frame Schematic Diagram .....	4-3			
	Frame (1) Schematic Diagram .....	4-3			
	Frame (2) Schematic Diagram .....	4-5			
4-2.	Printed Wiring Boards and Schematic Diagrams .....	4-7			
	TK-58 Printed Wiring Board .....	4-7			
	TK-58 (RW GAIN CONTROL) Schematic Diagram .....	4-11			
	TK-58 (RF AMP) Schematic Diagram .....	4-13			
	MB-91 Printed Wiring Board .....	4-15			
	MB-91 (AV DECODER) Schematic Diagram .....	4-19			
	MB-91 (SDRAM) Schematic Diagram .....	4-21			
	MB-91 (SERVO DSP) Schematic Diagram .....	4-23			
	MB-91 (DRIVE) Schematic Diagram .....	4-25			
	MB-91 (ARP3) Schematic Diagram .....	4-27			
	MB-91 (SYSTEM CONTROL) Schematic Diagram .....	4-29			
	MB-91 (ROM/RAM) Schematic Diagram .....	4-31			
	MB-91 (H2GA) Schematic Diagram .....	4-33			
	MB-91 (MIP) Schematic Diagram .....	4-35			
	MB-91 (OSD) Schematic Diagram .....	4-37			
	MB-91 (SDRAM) Schematic Diagram .....	4-39			
	MB-91 (PRAWN) Schematic Diagram .....	4-41			
	VP-52 Printed Wiring Board .....	4-43			
	VP-52 (TBC) Schematic Diagram .....	4-47			
	VP-52 (VIDEO ENCODER) Schematic Diagram .....	4-49			
			<b>5. IC PIN FUNCTION DESCRIPTION</b>		
			5-1. System Control Pin Function (MB-91 Board IC102) .....		5-1
			<b>6. TEST MODE</b>		
			6-1. General Description .....		6-1
			6-2. Starting Test Mode .....		6-1
			6-3. Syscon Diagnosis .....		6-1
			6-4. Drive Auto Adjustment .....		6-5
			6-5. Drive Manual Operation .....		6-7
			6-6. Mecha Aging .....		6-9
			6-7. Emergency History .....		6-9
			6-8. Version Information .....		6-10
			6-9. Video Level Adjustment .....		6-10
			6-10. If Con Self Diagnostic Function .....		6-11
			<b>7. ELECTRICAL ADJUSTMENTS</b>		
			7-1. Power Supply Check .....		7-1
			1. AC-113 Board .....		7-1
			2. PS-436 Board .....		7-1
			3. PS-437 Board .....		7-1
			7-2. Adjustment of System Control .....		7-2
			1. System Clock 27 MHz Adjustment .....		7-2
			7-3. Adjustment of Video System .....		7-2
			1. Interface Video Output Level Adjustment .....		7-2
			2. S-terminal Output Check .....		7-2
			3. Checking Component Video Output B-Y .....		7-2
			4. Checking Component Video Output R-Y .....		7-3
			5. Component Video Output Level Adjustment .....		7-3
			6. Progressive Video Output Level Adjustment .....		7-3
			7. Checking RGB Output R .....		7-3
			8. Checking RGB Output G .....		7-4

<u>Section</u>	<u>Title</u>	<u>Page</u>
9.	Checking RGB Output B (AEP, UK Model) .....	7-4
10.	Checking S Video Output S-C .....	7-4
7-4.	Adjustment Related Parts Arrangement .....	7-6
8.	REPAIR PARTS LIST	
8-1.	Exploded Views .....	8-1
8-1-1.	Case Assembly .....	8-1
8-1-2.	Chassis Assembly .....	8-2
8-1-3.	Mechanism Deck Assembly .....	8-3
8-2.	Electrical Parts List .....	8-4

# SERVICE NOTE

## 1. DISASSEMBLY

- This set can be disassembled in the order shown below.

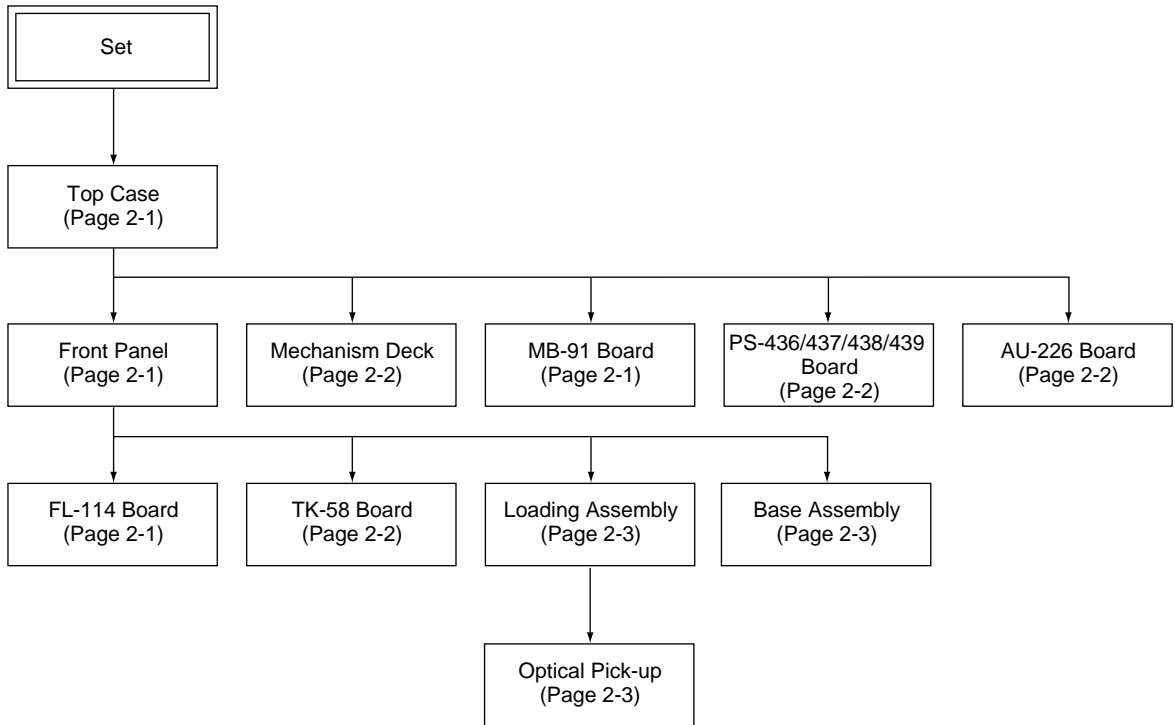

# SECTION 1 GENERAL

This section is extracted from instruction manual (3-063-397-11).

## About This Manual

### Conventions

- Instructions in this manual describe the controls on the remote. You can also use the controls on the player if they have the same or similar names as those on the remote.
- The icons on the right are used in this manual:

Icon	Meaning
	Indicates tips and hints for making the task easier.
	Indicates that the function is for DVD VIDEOS.
	Indicates that the function is for VIDEO CDs.
	Indicates that the function is for SACDs and for Audio CDs.

## This Player Can Play the Following Discs

Disc logo	DVD VIDEOS	Super Audio CDs	Audio CDs	VIDEO CDs
Contents	Audio + Video	Audio	Audio	Audio + Video

The "DVD VIDEO" logo is a trademark.

This player conforms to the NTSC color system. You cannot play discs recorded in other color systems such as PAL or SECAM.

### Region code of DVs you can play on this unit

Your DVD player has a region code printed on the back of the unit and will only play DVDs that are labeled with identical region codes.

DVDs labeled will also play on this unit.

If you try to play any other DVD, the message "Playback prohibited by area limitations," will appear on the TV screen.

Depending on the DVD, no region code indication may be labeled even though playing the DVD is prohibited by area restrictions.

### Note on playback operations of DVDs and VIDEO CDs

Some playback operations of DVDs and VIDEO CDs may be intentionally fixed by software producers. Since this player plays DVDs and VIDEO CDs according to the disc contents the software producers designed, some playback features may not be available. Also refer to the instructions supplied with the DVDs or VIDEO CDs.



5

## This Player Can Play the Following Discs

### DVD

A DVD disc contains both audio and visual data, and is either 12 or 8 centimeters in diameter. A 12 centimeter disc can hold 7 times the amount of data contained in a CD-ROM, which translates to 4 consecutive hours of playing time (8 hours for double-sided discs). DVD discs are divided into 4 types: single sided single layer, single sided double layer, double sided single layer, and double sided double layer.

- Single-layer single-sided: Capacity 4.7 GB

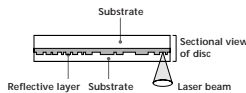

- Double-layer single-sided: Capacity 8.5 GB

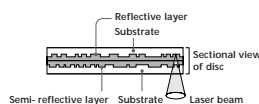

- Single-layer double-sided: Capacity 9.4 GB

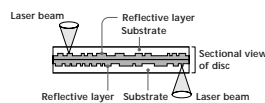

- Double-layer double-sided: Capacity 17 GB

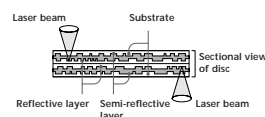

### Super Audio CD (SACD)

An SACD disc can reproduce sounds that are extremely faithful to the original sound by use of DSD (Direct Stream Digital) technology. This technology utilizes a sampling frequency of 2.8224MHz, which is 64 times that of a conventional CD, and 1-bit quantization that enables the disc to hold 4 times the amount of information that a standard PCM format CD can hold. SACDs are divided into the following types.

- Super Audio CD (single layer disc)  
This disc consists of a single HD layer\*. Press SACD/CD repeatedly so that the SACD indicator on the player lights up.  
\* High density signal layer for the Super Audio CD



### Super Audio CD (dual layer disc)

This disc consists of dual HD layers and is capable of extended play over long periods. Press SACD/CD repeatedly so that the SACD indicator on the player lights up. Also, as the dual layer disc consists of dual HD layers on one side only, you do not have to turn the disc over during playback.



### Super Audio CD + CD (Hybrid disc)

This disc consists of an HD layer and a CD layer. Press SACD/CD while the disc is stopped to select the layer you want to listen to. Also, as the dual layers are on one side only, you do not have to turn the disc over during playback. You can play the CD layer using a conventional CD player.



6

### Audio CD

An audio CD contains audio data. The playing time is 74 minutes for a standard 12 centimeter CD, and 20 minutes for an 8 centimeter CD single.

### Video CD

A video CD can contain both audio and visual data in a disc that is the same size as an audio CD. The playing time is 74 minutes for a standard 12 centimeter CD, and 20 minutes for an 8 centimeter CD single.

### Terms for discs

- **Title**  
The longest section of a picture or music feature on a DVD, the movie, etc. in video software, or the name of an album in audio software.
- **Chapter**  
Sections of a picture or a music feature that are smaller than titles. A title is composed of several chapters. Each chapter is assigned a chapter number enabling you to locate the chapter you want. Depending on the disc, no chapters may be recorded.
- **Track**  
Sections of a picture or a music feature on a VIDEO CD or a SACD/CD. Each track is assigned a track number enabling you to locate the track you want.

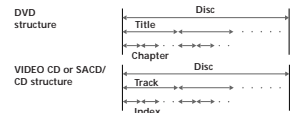

### Index (SACD/CD) / Video Index (VIDEO CD)

A number that divides a track into sections to easily locate the point you want on a VIDEO CD or an SACD/CD. Depending on the disc, no indexes may be recorded.

### Scene

On a VIDEO CD with PBC (playback control) functions, the menu screens, moving pictures and still pictures are divided into sections called "scenes." Each scene is assigned a scene number enabling you to locate the scene you want.

### Note on PBC (Playback Control) (VIDEO CDs)

This player conforms to Ver. 1.1 and Ver. 2.0 of VIDEO CD standards. You can enjoy two kinds of playback according to the disc type.

Disc type	You can
VIDEO CDs without PBC functions (Ver. 1.1 discs)	Enjoy video playback (moving pictures) as well as music.
VIDEO CDs with PBC functions (Ver. 2.0 discs)	Play interactive software using menu screens displayed on the TV screen (PBC Playback), in addition to the video playback functions of Ver. 1.1 discs. Moreover, you can play high-resolution still pictures if they are included on the disc.

### Discs that the player cannot play

The player cannot play disc types other than the ones listed in the table on page 5. CD-Rs, CD-ROMs including PHOTO CDs, data sections in CD-EXTRAS, DVD-ROMs, DVD-audio etc., cannot be played.

When playing DTS\*-encoded CDs, excessive noise will be heard from the analog stereo outputs. To avoid possible damage to the audio system, the consumer should take proper precautions when the analog stereo outputs of the DVD player are connected to an amplification system. To enjoy DTS Digital Surround™ playback, an external 5.1-channel DTS Digital Surround™ decoder system must be connected to the digital output of the DVD player.

This product incorporates copyright protection technology that is protected by method claims of certain U.S. patents and other intellectual property rights owned by Macrovision Corporation and other rights owners. Use of this copyright protection technology must be authorized by Macrovision Corporation, and is intended for home and other limited viewing uses only unless otherwise authorized by Macrovision Corporation. Reverse engineering or disassembly is prohibited.

Consumers should note that not all high definition television sets are fully compatible with this product and may cause artifacts to be displayed in the picture. In case of 480 progressive scan picture problems, it is recommended that the user switches the connection to the standard definition output. If there are questions regarding your Sony TV set's compatibility with this model 480p DVD player, please contact our customer service center.

\* "DTS," "DTS Digital Surround" and "DTS Digital Out" are trademarks of Digital Theater Systems, Inc.

7

## Precautions

### On safety

- **Caution** – The use of optical instruments with this product will increase eye hazard.
- Should any solid object or liquid fall into the cabinet, unplug the player and have it checked by qualified personnel before operating it any further.

### On power sources

- The player is not disconnected from the AC power source as long as it is connected to the wall outlet, even if the player itself has been turned off.
- If you are not going to use the player for a long time, be sure to disconnect the player from the wall outlet. To disconnect the AC power cord, grasp the plug itself; never pull the cord.
- Should the AC power cord need to be changed, have it done at a qualified service shop only.

### On placement

- Place the player in a location with adequate ventilation to prevent heat build-up in the player.
- Do not place the player on a soft surface such as a rug that might block the ventilation holes on the bottom.
- Do not place the player in a location near heat sources, or in a place subject to direct sunlight, excessive dust or mechanical shock.

### On operation

- If the player is brought directly from a cold to a warm location, or is placed in a very damp room, moisture may condense on the lenses inside the player. Should this occur, the player may not operate properly. In this case, remove the disc and leave the player turned on for about half an hour until the moisture evaporates.
- When you move the player, take out any discs. If you don't, the disc may be damaged.

### On adjusting volume

- Do not turn up the volume while listening to a section with very low level inputs or no audio signals. If you do, the speakers may be damaged when a peak level section is played.

### On cleaning

- Clean the cabinet, panel and controls with a soft cloth slightly moistened with a mild detergent solution. Do not use any type of abrasive pad, scouring powder or solvent such as alcohol or benzene.

If you have any questions or problems concerning your player, please consult your nearest Sony dealer.

### IMPORTANT NOTICE

The enclosed DVD player is capable of holding a still video image or liquid fall into the cabinet, unplug the player and have it checked by qualified personnel before operating it any further. Projection televisions are especially susceptible to this.

## Notes About the Discs

### On handling discs

- To keep the disc clean, handle the disc by its edge. Do not touch the surface.
- Do not stick paper or tape on the disc. If there is glue (or a similar substance) on the disc, remove the glue completely before using the disc.



- Do not expose the disc to direct sunlight or heat sources such as hot air ducts, or leave it in a car parked in direct sunlight as the temperature may rise considerably inside the car.
- After playing, store the disc in its case.

### On cleaning

- Before playing, clean the disc with a cleaning cloth. Wipe the disc from the center out.



- Do not use solvents such as benzene, thinner, commercially available cleaners or anti-static spray intended for vinyl LPs.

### On novelty discs

- Do not use irregularly shaped discs such as heart- or star-shaped discs as they may cause the player to malfunction.

8

# Getting Started

This section describes how to hook up the SACD/DVD player to a TV (with audio/video input jacks) and/or an AV receiver (amplifier). You cannot connect this player to a TV which does not have a video input connector. Be sure to turn off the power of each component before making the connections.

## Unpacking

- Check that you have the following items:
- Audio connecting cord (1)
  - Video connecting cord (1)
  - S-link (Control S) connecting cord (1)
  - S video cord (1)
  - Power cord (1)
  - Remote commander (remote) RMT-D122A (1)
  - Size AA (R6) batteries (2)

### Inserting batteries into the remote

You can control the player using the supplied remote. Insert two Size AA (R6) batteries by matching the + and - ends on the batteries to the markings inside the compartment. When using the remote, point it at the remote sensor on the player.

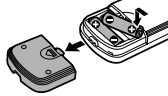

You can control TVs and AV receivers (amplifiers) using the supplied remote. See page 64.

### Notes

- Do not leave the remote in an extremely hot or humid place.
- Do not drop any foreign object into the remote casing, particularly when replacing the batteries.
- Do not expose the remote sensor to direct sunlight or lighting apparatuses. Doing so may cause a malfunction.
- If you do not use the remote for an extended period of time, remove the batteries to avoid possible damage from battery leakage and corrosion.

### Connecting the power cord

Connect the supplied power cord to the AC IN terminal of the player.

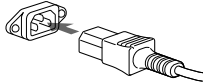

Getting Started

Getting Started

9

## TV Hookups

This connection is for listening to the sound through TV speakers (L: left, R: right). Refer to the instructions supplied with the component to be connected.

### Required cords

- Audio connecting cord (supplied) (1)
- Video connecting cord (supplied) (1)
- S-link (control S) connecting cord (supplied) (1)

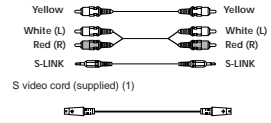

When connecting the cords, be sure to match the color-coded cord to the appropriate jacks on the components: Yellow (video) to Yellow, Red (right) to Red and White (left) to White. Be sure to make connections firmly to avoid hum and noise. If your TV has an S-link (control S) connector, you can control the SACD/DVD player from the TV. Connect the TV via the S-LINK/CONTROL S IN connector. If your TV has an S video input connector, connect the component via the S VIDEO OUT connector using the supplied S video cord. You will get a better picture. Refer to the instructions supplied with the TV to be connected.

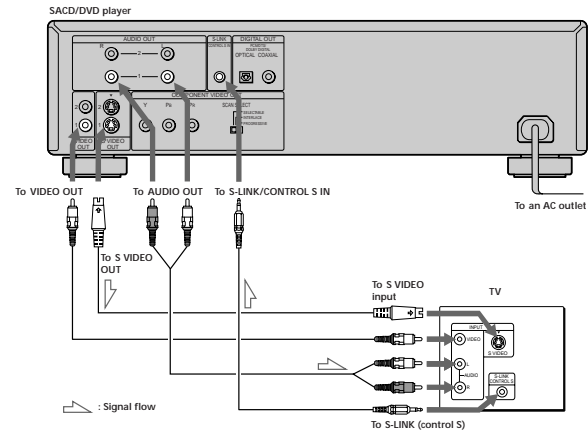

10

If you connect the player to a monitor or projector having component video input connectors that conform to output signals from the COMPONENT VIDEO OUT (Y, Pb, Pr) connectors on the player

Connect the component via the COMPONENT VIDEO OUT connectors using three video connecting cords (75 Ω coaxial) (not supplied) of the same kind and length. You will get a better picture.

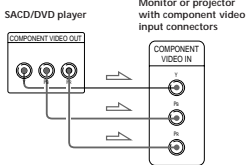

### Notes

- Refer to the instructions supplied with the component to be connected.
- Do not connect this player to a video deck. If you do, noise may appear in the picture.

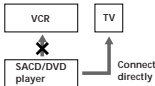

- Depending on the TV or receiver (amplifier), sound distortion may occur because the audio output level from this player is high. In this case, set "AUDIO ATT" in "AUDIO SETUP" to "ON" in the setup display. For details, see page 60.

If your TV has an S-link (control S) connector You can control the player from the TV. Connect the TV via the S-LINK/CONTROL S IN connector using the S-link (control S) cord (supplied). Refer to the instructions supplied with the TV to be connected.

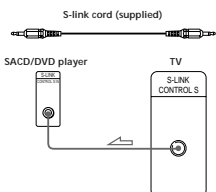

## Setups for the player

Some setup adjustments are necessary for the player depending on the TV or other components to be connected.

Use the setup display to change the various settings. For details on using the setup display, see page 50.

- **To connect the player to a normal TV** In the setup display, set "TV TYPE" in "SCREEN SETUP" to "4:3 LETTER BOX" (default setting) or "4:3 PAN SCAN." For details, see page 54.
- **To connect the player to a TV having the WIDE MODE function** In the setup display, set "TV TYPE" in "SCREEN SETUP" to "16:9/4:3 WIDE MODE." For details, see page 54.
- **To connect the player to a wide-screen TV** In the setup display, set "TV TYPE" in "SCREEN SETUP" to "16:9/4:3 WIDE MODE." For details, see page 54.
- **To connect the player to a TV that accepts progressive (480p) format signals** Connect the player to your TV using the COMPONENT VIDEO OUT connectors, and set "COMPONENT OUT" in "CUSTOM SETUP" to "PROGRESSIVE."

Getting Started

Getting Started

11

## Receiver (Amplifier) Hookups

This connection is for listening to the sound through speakers connected to a receiver lacking a built-in DTS or Dolby® Digital decoder. Refer as well to the instructions supplied with the component to be connected.

If you have a digital component with a built-in DTS or Dolby Digital decoder You can enjoy multi-channel surround sound by connecting the component via the DIGITAL OUT OPTICAL or COAXIAL connector using an optical or coaxial digital connecting cord (not supplied). For details on hookups and settings, see page 14.

Do not connect the AC outlet to a switched AC power supply such as the AC outlet on a receiver (amplifier). Doing so may cause the Playback Memory, Disc Memo and menu settings to be cancelled when you turn off the receiver.

\* Manufactured under license from Dolby Laboratories. "Dolby", "Pro Logic" and the double-D symbol are trademarks of Dolby Laboratories. Confidential unpublished works. ©1992-1997 Dolby Laboratories. All rights reserved.

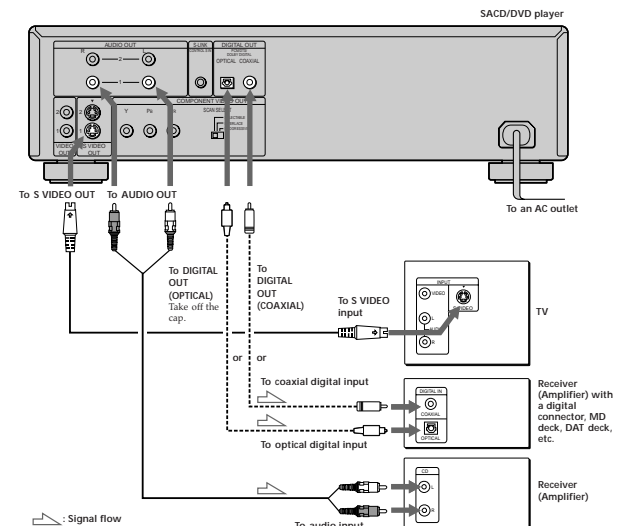

12

### Required cords

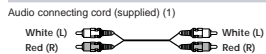

S video cord (supplied) (1)

When connecting the cords, be sure to match the color-coded cord to the appropriate jacks on the components: Red (right) to Red and White (left) to White. Be sure to make connections firmly to avoid hum and noise.

If you have a digital component such as a receiver (amplifier) with a digital connector, DAT or MD, connect the component via the DIGITAL OUT OPTICAL or COAXIAL connector using an optical or coaxial digital connecting cord (not supplied).

Optical digital connecting cord (not supplied) (1)

Coaxial digital (75 Ω) connecting cord (not supplied) (1)

### Notes

- You cannot enjoy a picture with an S video signal if your TV does not conform to the S video signal. When your TV does not have an S VIDEO input, connect the component via the VIDEO INPUT connector using the audio/video connecting cord (supplied) instead of the S video cord. For details, see page 12.
- Refer to the instructions supplied with your TV.
- You cannot make digital audio recordings of discs recorded in multi-channel surround format directly using an MD deck or DAT deck.
- SACD audio signals are not output from the DIGITAL OUT OPTICAL or COAXIAL connectors.

When you have made the connections using an optical or coaxial digital connecting cord, do not set "DOLBY DIGITAL" to "DOLBY DIGITAL," "DTS" to "ON" and "48kHz/96kHz PCM" to "96kHz/24bit." If you do, a loud noise will suddenly come out from the speakers, affecting your ears or causing the speakers to be damaged.

### Setup for the player

Some setup adjustments are necessary for the player depending on the components to be connected. Use the setup display to change the various settings. For details on using the setup display, see page 50.

- To listen to the sound through speakers connected to a receiver (amplifier) which has a digital connector and lacks a built-in DTS or Dolby Digital decoder, or to output the sound to a digital component such as a DAT or MD deck. Set the "AUDIO SETUP" items in the setup display (page 60) as shown in the illustration below. These are the default settings.

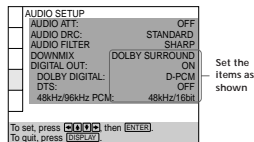

### Note

When you output the signals which do not reproduce the Dolby Surround (Pro Logic) effect from the DIGITAL OUT OPTICAL or COAXIAL connector, set "DOWNMIX" to "NORMAL" in "AUDIO SETUP" in the setup display (page 60).

## 5.1 Channel Surround Hookups

With DVDs which contain DTS or Dolby Digital sound, you can enjoy the surround sound while producing the effect of being in a movie theater or a concert hall using a digital component with a built-in DTS or Dolby Digital decoder (not supplied). The player outputs the surround sound signals from the DIGITAL OUT OPTICAL and COAXIAL connectors.

Using a receiver (amplifier) having the OPTICAL or COAXIAL connector and 6 speakers, you can enjoy even greater real audio presence in the comfort of your own home.

### Required cords

Optical digital connecting cord\* (not supplied) (1)

Coaxial digital (75 Ω) connecting cord\* (not supplied) (1)

S video cord (supplied) (1)

\* Connect the component via the DIGITAL OUT OPTICAL or COAXIAL connector using an optical or coaxial digital connecting cord (not supplied). You do not need to connect both of these cords. See the figure on the next page.

Do not connect the AC outlet to a switched AC power supply such as the AC outlet on a receiver (amplifier). Doing so may cause the Playback Memory, Disc Memo and menu settings to be cancelled when you turn off the receiver.

### Notes

- Do not connect the power cord to an AC outlet or press the POWER switch before completing all connections.
- Refer to the instructions supplied with the component to be connected.
- The cord connectors should be fully inserted into the jacks. A loose connection may cause hum and noise.
- SACD audio signals are not output from the DIGITAL OUT OPTICAL or COAXIAL connectors.

### Setup for the player

Some setup adjustments are necessary for the player depending on the components to be connected. Use the setup display to change the various settings. For details on using the setup display, see page 50.

- When you connect an audio component with a built-in Dolby Digital decoder
  - Set "DIGITAL OUT" in "AUDIO SETUP" to "ON" and then set "DOLBY DIGITAL" to "DOLBY DIGITAL" in the setup display. (page 60, 61)

- When you connect an audio component with a built-in DTS decoder
  - Set "DIGITAL OUT" in "AUDIO SETUP" to "ON" and then set "DTS" to "ON" in the setup display. (page 60, 61)

- When you connect an audio component that accept the 96kHz/24bit audio signal
  - Set "DIGITAL OUT" in "AUDIO SETUP" to "ON" and then set "48kHz/96kHz PCM" to "96kHz/24bit" in the setup display. (page 60)

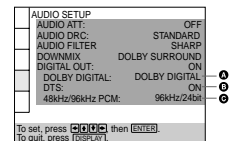

### Notes

- When you do not connect an audio component with a built-in Dolby Digital decoder, do not set "DOLBY DIGITAL" to "DOLBY DIGITAL."
- When you do not connect an audio component with a built-in DTS decoder, do not set "DTS" to "ON."
- When you do not connect an audio component that cannot accept the 96kHz/24bit audio signal, do not set "48kHz/96kHz PCM" to "96kHz/24bit."
- SACD audio signals are not output from the DIGITAL OUT OPTICAL or COAXIAL connectors.

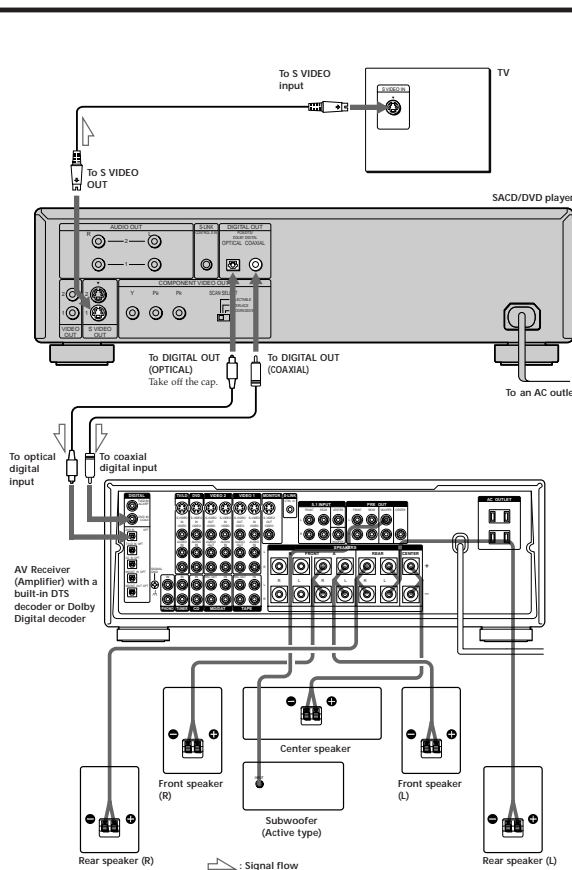

## Selecting the Language for the On-Screen Display

You can select the language for the setup display, the Control Menu display or the messages displayed on the screen. The default setting is "ENGLISH."

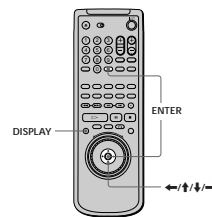

- When the player is in stop mode, press DISPLAY and select "SETUP" using  $\uparrow/\downarrow$ . The on-screen menu items are different depending on whether there is a disc in the player or not.

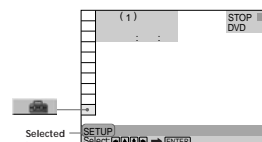

- Press ENTER. The setup display appears on the TV screen.

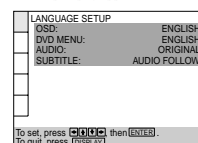

- Select "LANGUAGE SETUP" using  $\uparrow/\downarrow$ , and then press ENTER.

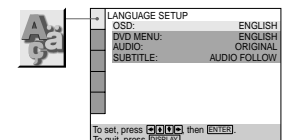

- Select "OSD" using  $\uparrow/\downarrow$ , then press  $\rightarrow$  or ENTER. The languages you can select are displayed.

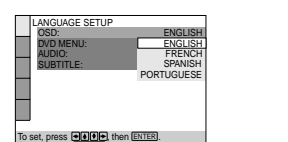

- Select the desired language using  $\uparrow/\downarrow$ , then press ENTER.

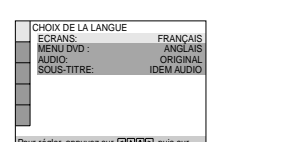

- Press DISPLAY. The setup display disappears.

- Press DISPLAY repeatedly to turn off the on-screen menu.



**To return to the previous screen**  
Press **RETURN**.

**To quit while making a selection**  
Press **DISPLAY**.

**Note**  
The languages you can select are the ones displayed in step 4. For details, see page 53.

## Operation Sound Effects (Sound Feedback)

The player beeps when the following operations are performed. The default setting of the Sound Feedback function is set to off.

Operation	Operation sound
Power is turned on	One beep
Power is turned off	Two beeps
> is pressed	One beep
II is pressed	Two beeps
Playback is stopped	One long beep
Operation is not possible	Three beeps

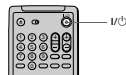
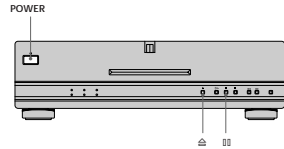

**1 Press POWER on the player, then press I/O on the remote.**  
The power indicator lights up in green.

When there is a disc in the player, press **II** and remove the disc. Then press **II** again to close the disc tray.

**2 Press and hold II on the player for more than two seconds.**

You will hear one beep and the Sound Feedback function is turned on.

### To turn off the Sound Feedback Function

When there is no disc in the player, press and hold **II** on the player for more than two seconds. You will hear two beeps and the Sound Feedback function is turned off.

Getting Started

17

## Playing Discs

This chapter describes how to play a DVD/SACD/CD/VIDEO CD.

### Playing Discs DVD VIDEO SACD

Depending on the DVD or VIDEO CD, some operations may be different or restricted. Refer to the instructions supplied with your disc.

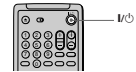
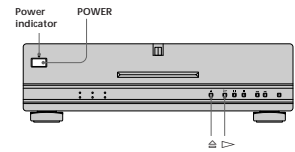

**1 Turn on your TV.**  
Turn on the TV and select the video input so that you can view the pictures from this player.

#### When using a receiver (amplifier)

Turn on the receiver (amplifier) and select the appropriate position so that you can listen to the sound from this player.

**2 Press POWER to turn on the player.**

The player enters standby mode and the power indicator lights up in red.

**3 Press II on the player, and place a disc on the disc tray.**

The player automatically turns on and the power indicator lights up in green.

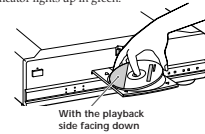

**4 Press >.**

The disc tray closes and the player starts playback (continuous play). Adjust the volume on the TV or the receiver (amplifier).

### Playing Discs

#### Achieving high quality sound reproduction

The following settings enable you to play audio CDs, 96 kHz DVDs, and SACDs at the highest possible sound quality.

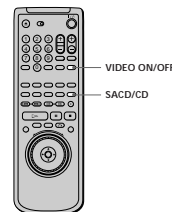
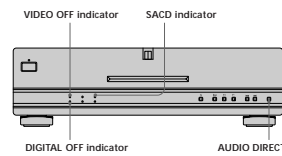

By pressing **AUDIO DIRECT** on the player when it is stopped, the video and digital audio output can be switched on or off. When the playback audio signal is set to be output from the digital connectors, this button will cut the video signal. By setting the digital audio signal to off, this button reduces the effect of the video and digital circuitry on the audio signal. When no video signal is output from the player, the **VIDEO OFF** indicator lights up, and when the digital audio or video signal is cut, the **DIGITAL OFF** indicator lights up.

By pressing the **VIDEO ON/OFF** button on the remote when the player is stopped, the video output can be switched on or off. When the video output is set to off, the effect of the digital and analog video circuitry on the audio signal is cut to a minimum. When no video signal output from the player, the **VIDEO OFF** indicator lights up on the player.

#### When playing SACDs

When you are playing an SACD, the SACD indicator on the player lights up. In order to select one of the layers on a hybrid SACD (page 6), stop the player and press the **SACD/CD** button on the remote. The SACD indicator on the player turns off when a CD layer is played.

#### Notes

- When **DIGITAL OUT** is set to **OFF** in **AUDIO SETUP**, you cannot turn the digital audio output back on using the **AUDIO DIRECT** button.
- SACD signals are not output from the **DIGITAL OUT OPTICAL** or **COAXIAL** connectors.

#### After following Step 4

##### ■ When playing a DVD

A DVD menu or title menu may appear on the TV screen (see page 24).

##### ■ When playing a VIDEO CD

Depending on the VIDEO CD, a menu may appear on the TV screen. You can play the disc interactively by following the instructions on the menu. (PBC Playback, see page 25.)

#### To turn on the player

Press **POWER** on the player. The player enters standby mode and the power indicator lights up in red. Then press **I/O** on the remote. The player turns on and the power indicator lights up in green. In standby mode, the player also turns on by pressing **II** on the player or by pressing **>**.

#### To turn off the player

Press **I/O** on the remote. The player enters standby mode and the power indicator lights up in red. To disconnect the power of the player, press **POWER** on the player.

#### Notes on playing DTS sound tracks on a CD

- Do not play DTS sound tracks without first connecting the player to an audio component having a built-in DTS decoder. The player outputs the DTS signal via the **DIGITAL OUT OPTICAL** and **COAXIAL** connectors even if "DTS" in "AUDIO SETUP" is set to "OFF" in the setup display, and may affect your ears or cause your speakers to be damaged.
- Set the sound to "STEREO" when you play DTS sound tracks on a CD. (See "Changing the Sound" on page 35.) If you set the sound to "L" or "R", no sound will come from the **DIGITAL OUT OPTICAL** and **COAXIAL** connectors.
- If you play a CD with a DTS sound track, a loud noise may come out from the **AUDIO OUT** connectors, affecting your ears or causing the speakers to be damaged.

#### Notes on playing DTS sound tracks on a DVD

The signals of the DTS sound tracks are output from the **DIGITAL OUT OPTICAL** and **COAXIAL** connectors only. No sound will be output from the **AUDIO OUT** connectors.

• If the player is connected to an audio component lacking a built-in DTS decoder, do not set "DTS" in "DIGITAL OUT" to "ON" in the setup display. Otherwise, when you play the DTS sound track, a loud noise will come out from the speakers, affecting your ears or causing the speakers to be damaged.

• When you set "DTS" in "AUDIO SETUP" to "OFF", no sound will come out from the **DIGITAL OUT OPTICAL** and **COAXIAL** connectors even if you play DTS sound tracks on DVDs.

#### Notes

- If you leave the player or the remote in pause or stop mode for 15 minutes, the screen saver image appears automatically. It will also appear if you play back a CD for more than 15 minutes. To make the screen saver image go away, press **>**. (If you want to set the screen saver function to off, see page 54.)
- While playing a disc, do not turn off the player by pressing **POWER**. Doing so may cancel the settings of the menu. When you turn off the player, press **II** first to stop playback and then press **I/O** on the remote. After the power indicator lights up in red and the player enters standby mode, press **POWER** on the player.

Playing Discs

Playing Discs

19

20

### Additional operations

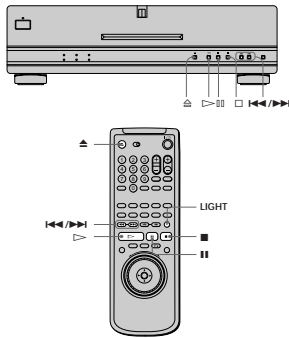

To	Operation
Stop	Press ■
Pause	Press ■■
Resume play after pause	Press ■■ or ▷
Go to the next chapter, track or scene in continuous play mode	Press ►►
Go back to the preceding chapter, track or scene in continuous play mode	Press ◄◄
Stop play and remove the disc	Press ▲

You can play discs in various modes such as Program Play using the on-screen menu (Control Menu). For Control Menu operations, see page 28.

#### To light up the buttons on the remote

When you press LIGHT on the remote, ▷, ■, ■■ and DISPLAY light up. If you do not press any buttons for a short while, the buttons will automatically turn off. Note, however, that using the LIGHT function will shorten the battery life of the remote.

## Playing at Various Speeds/Frame by Frame

**DVD VIDEO SACD/CD**  
Using the click shuttle and the JOG button/indicator, you can play back a DVD/SACD/CD/VIDEO CD at various speeds or frame by frame. Each time you press JOG, it changes between shuttle mode and jog mode.

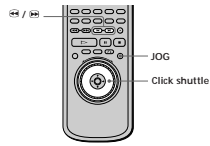

### To change the playback speed (Shuttle mode)

Turn the click shuttle. The playback speed changes depending on the turning direction and angle as follows:

#### When you play back a DVD

**During playback**

FF2 ►► Fast forward (about 30 times the normal speed)  
 ↓  
 FF1 ►► Fast forward (about 10 times the normal speed)  
 ↓  
 x2 (about twice the normal speed)  
 ↓  
 PLAY ► (normal speed)  
 ↓  
 x/2 (about twice the normal speed)  
 ↓  
 FR1 ◄◄ Fast rewind (about 10 times the normal speed)  
 ↓  
 FR2 ◄◄ Fast rewind (about 30 times the normal speed)

If you turn the click shuttle quickly, the playback speed goes to FF2 ►► or FR2 ◄◄ at once.

#### During pause

SLOW1 ► Slow (playback direction)  
 ↓  
 SLOW2 ► Slow (playback direction – slower than “SLOW1 ►”)  
 ↓  
 PAUSE ■■ Pause  
 ↓  
 SLOW2 ◄ Slow (opposite direction – slower than “SLOW1 ◄”)  
 ↓  
 SLOW1 ◄ Slow (opposite direction)

## Playing at Various Speeds/Frame by Frame

### When you play back a SACD/CD/VIDEO CD

**During playback**

FF2 ►► Fast forward (faster than “FF1 ►►”)  
 ↓  
 FF1 ►► Fast forward  
 ↓  
 x2 (about twice the normal speed)\*  
 ↓  
 PLAY ► (normal speed)  
 ↓  
 FR1 ◄◄ Fast rewind  
 ↓  
 FR2 ◄◄ Fast rewind (faster than “FR1 ◄◄”)  
 \* SACD/CD Only

#### During pause (VIDEO CD only)

SLOW1 ► Slow (playback direction)  
 ↓  
 SLOW2 ► Slow (playback direction – slower than “SLOW1 ►”)  
 ↓  
 PAUSE ■■ Pause

#### To return to continuous play

Press ▷.

#### To search for a picture using the remote

Keep pressing ◀ or ▶ on the remote. The playback speed is the same as FR1 ◄◄ or FF1 ►► when using the click shuttle.

#### Note

Depending on the DVD/VIDEO CD, you may not be able to do some of the operations described.

### To play the disc frame by frame (Jog mode)

1 Press JOG.  
 JOG lights up during jog mode.

2 Turn the click shuttle.

Depending on the turning speed, playback goes to frame-by-frame playback in the direction that the click shuttle is turned. If you turn the click shuttle at a constant speed for a while, the playback speed goes to slow or normal.

#### To return to Continuous Play

Press ▷.

#### Notes

- The JOG indicator shows the mode of the corresponding click shuttle.
- If you don't operate the click shuttle for about 20 seconds after pressing JOG, the click shuttle returns to shuttle mode.

21

22

## Resuming Playback from the Point Where You Stopped the Disc (Resume Play)

The player remembers the point where you stopped the disc, and when “RESUME” appears on the front panel display, you can resume playback from that point. As long as you do not open the disc tray, Resume Play will work even if the player enters standby mode by pressing I/O on the remote.

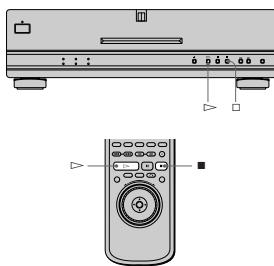

### 1 While playing a disc, press ■ to stop playback.

“RESUME” appears on the front panel display and “Disc will restart from current point. To start from beginning, press [STOP] again.” appears on the TV screen. If “RESUME” does not appear, Resume Play is not available.

### 2 Press ▷.

The player starts playback from the point where you stopped the disc in Step 1.

#### To play from the beginning of the disc

When the playing time appears on the front panel display before you start playing, press ■ to reset the playing time, then press ▷.

#### Notes

- Resume Play may not be available on some DVDs.
- Resume Play is not available in Shuffle or Program Play mode.
- Depending on where you stopped the disc, the player may resume playback from a different point.
- The point where you stopped playing is cleared when:
  - you open the disc tray
  - you turn the power off by pressing POWER on the player
  - you change the play mode
  - you start playback after selecting a title, chapter or track
  - you change the settings in the setup display

23

## Using the DVD's Menu

Some DVDs have a title menu or a DVD menu that is provided with DVDs only.

### Using the title menu

A DVD is divided into long sections of a picture or a music feature called “titles.” When you play a DVD which contains several titles, you can select the title you want using the title menu.

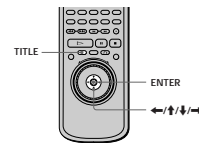

### 1 Press TITLE.

The title menu appears on the TV screen. The contents of the menu vary from disc to disc.

### 2 Press ◀/▶/▲/▼ to select the title you want to play.

Depending on the disc, you can use the number buttons to select the title.

### 3 Press ENTER.

The player starts playing the selected title.

#### Notes

- On some DVDs, you may not be able to select the title.
- On some DVDs, a “title menu” may simply be called a “menu” or “title” in the instructions supplied with the disc. “Press ENTER.” may also be expressed as “Press SELECT.”

### Using the DVD menu

Some DVDs allow you to select the disc contents using a menu. When you play these DVDs, you can select the language for the subtitles, the language for the sound, etc., using the DVD menu.

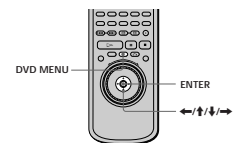

### 1 Press DVD MENU.

The DVD menu appears on the TV screen. The contents of the menu vary from disc to disc.

### 2 Press ◀/▶/▲/▼ to select the item you want to change.

Depending on the disc, you can use the number buttons to select the item.

### 3 To change other items, repeat Step 2.

### 4 Press ENTER.

If you want to select the language for the DVD menu Change the setting using “DVD MENU” in “LANGUAGE SETUP” in the setup display. For details, see page 53.

#### Note

Depending on the DVD, a “DVD menu” may simply be called a “menu” in the instructions supplied with the disc.

24

## Playing VIDEO CDs with PBC Functions (PBC Playback) VIDEO CD

When playing VIDEO CDs with PBC (Play Back Control) functions (Ver. 2.0 discs), you can enjoy simple interactive operations, search functions, and other such operations. PBC Playback allows you to play VIDEO CDs interactively by following the menu on the TV screen. On this player, you can use the number buttons, ENTER, **◀▶**, **↑/↓**, and **↻** RETURN during PBC Playback.

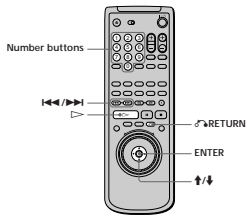

- 1 Start playing a VIDEO CD with PBC functions by following Steps 1 to 4 in "Playing Discs" on page 18.
- 2 Select the item number you want.  
Press **↑/↓** to select the item number.  
You can also select the item number with the number buttons on the remote.
- 3 Press ENTER.
- 4 Follow the instructions in the menu for interactive operations.  
Refer to the instructions supplied with the disc, as the operating procedure may differ according to the VIDEO CD.

**To go back to the menu**  
Press **↻** RETURN, **◀**, or **▶**.

**To cancel PBC playback of a VIDEO CD with PBC functions and play the disc in continuous play mode**  
There are two ways.

- Before you start playing, select the track you want using **◀▶** or **▶▶**, then press ENTER or **▶**.
- Before you start playing, select the track number using the number buttons on the remote, then press ENTER or **▶**. "Play without PBC" appears on the TV screen and the player starts continuous play. You cannot play still pictures such as a menu.  
To return to PBC playback, press **■** twice then press **▶**.

**Note**  
Depending on the VIDEO CD, "Press ENTER" in Step 3 may be expressed as "Press SELECT" in the instructions supplied with the disc. In this case, press **▶**.

Playing Discs

25

## Using the Front Panel Display DVD VIDEO CD SACD CD

You can check information about the disc, such as the total number of titles or tracks or remaining time, using the front panel display. This display can be turned on or off using the FL ON/OFF button.

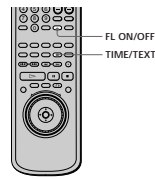

### Turning the front panel display on or off

You can turn the front panel display on or off using the remote. Each time you press the FL ON/OFF button, the display turns on and off. When the display is off, the FL OFF indicator on the player lights up.

**Note**  
You can adjust the brightness of the front panel display. You can adjust the brightness of the front panel display or set it to turn off automatically by selecting DIMMER in CUSTOM SETUP.

**Note**  
The FL ON/OFF button does not work when DIMMER is set to OFF in CUSTOM SETUP.

### When playing back a DVD DVD

#### Displaying information while playing the disc

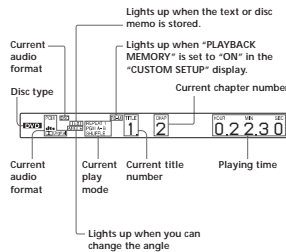

26

### Checking the remaining time

Press TIME/TEXT.  
Each time you press TIME/TEXT while playing the disc, the display changes as shown in the following chart.

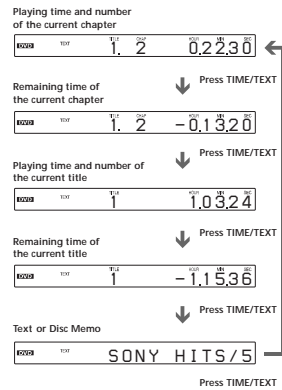

**Notes**

- On some DVDs, the chapter number or time may not appear or you may not be able to change the front panel display.
- During Shuffle Play or Program Play, the playing time of the title and the remaining time of the title are not displayed.

### When playing back a SACD/CD/VIDEO CD VIDEO CD SACD CD

#### Displaying information while playing a disc

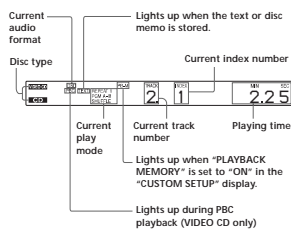

**Note**  
When playing VIDEO CDs with PBC functions  
The current scene number is displayed instead of the current track number and the current index number. In this case, the front panel display does not change when you press TIME/TEXT. If TEXT is recorded on the disc, the front panel display changes to the Text display when you press TIME/TEXT (see page 32).

### Checking the remaining time

Press TIME/TEXT.  
Each time you press TIME/TEXT while playing a disc, the display changes as shown in the following chart.

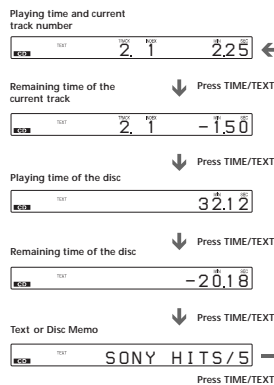

**Note**  
While you are doing Shuffle Play, or Program Play, the playing time of the disc and the remaining time of the disc are not displayed.

Playing Discs

27

## Using Various Functions with the Control Menu

This chapter describes how to play discs in various modes and how to use the convenient features of the on-screen menu (Control Menu).

### Using the Control Menu Display DVD VIDEO CD SACD CD

Using the Control Menu display, you can select the starting point, play scenes in any order you like, change the viewing angles, make video control settings, and other such operations. The possible operations are different depending on the kind of disc. For details on each Control Menu display item, see pages 30 to 49.

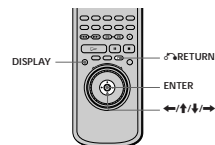

- 1 Press DISPLAY to show the Control Menu display on the TV screen.

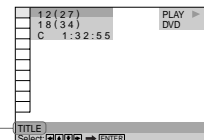

- 2 Select the item you want using **↑/↓**.

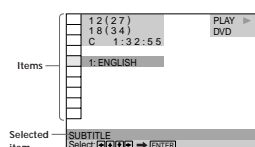

28

3 Press ENTER.

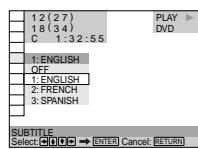

4 Select the item you want using  $\uparrow/\downarrow$ .

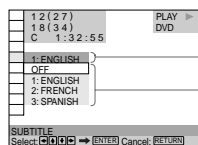

5 Press ENTER.

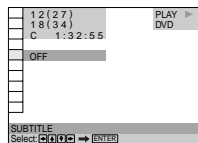

**To cancel while making a selection**  
Press  $\leftarrow$  RETURN.

**To display other items**  
Each time you press DISPLAY, the Control Menu display changes as follows:

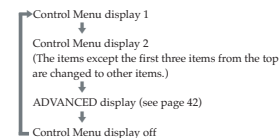

The Control Menu display items are different depending on the disc.

**You can select some items directly**  
Some items can be selected by pressing the corresponding button on the remote. In this case, only the item you selected is displayed. For instructions on using the remote, see the pages of each relevant item.

**Note**  
Some Control Menu display items require operations other than selecting the setting. For details on these items, see the relevant pages.

## Control Menu Item List

- TITLE (DVD only) (page 31)**
- SCENE (VIDEO CD during PBC playback only) (page 31)**
- TRACK (VIDEO CD only) (page 31)**
- CHAPTER (DVD only) (page 31)/**
- INDEX (VIDEO CD only) (page 31)**
- TRACK (SACD/CD only) (page 31)**
- INDEX (SACD/CD only) (page 31)**

You can search for a point on the DVD by selecting the title, chapter, track, index or scene.

- TIME/MEMO (pages 32, 33, 34)**
- TIME/TEXT (pages 32, 33, 34)**

You can check the playing time and remaining time of the current title, chapter, track and the total playing time or remaining time of the disc.

You can also search for a scene by inputting the time code. You can check the DVD TEXT, SACD TEXT or CD TEXT of the disc on the TV screen and the front panel display. When the disc is a VIDEO CD or the DVD TEXT/SACD TEXT/CD TEXT is not recorded on the disc, you can label the disc using the Disc Memo function.

- AUDIO (page 35)**

If the DVD is recorded with multilingual tracks, you can select the language you want while playing the DVD. If the DVD is recorded in multiple audio formats (PCM, Dolby Digital or DTS), you can select the audio format you want while playing the DVD. With CDs or VIDEO CDs, you can select the sound from the right or left channel and listen to the sound of the selected channel through both the right and left speakers.

- SUBTITLE (DVD only) (page 37)**

With DVDs on which multilingual subtitles are recorded, you can change the subtitle language whenever you want while playing the DVD, and turn it on or off whenever you want.

- ANGLE (DVD only) (page 37)**

With DVDs on which various angles (multi-angles) are recorded, you can change the angle of the scene.

- VIDEO CONTROL (DVD and VIDEO CD only) (page 38)**

You can make detailed adjustments to the playback image and store up to 5 different setting patterns in the player's memory. This is useful when you want to store certain settings for different genres such as movies or concerts. You can also store individual settings in the player's memory for up to 300 discs (playback memory). The player can be programmed to automatically recall the settings for a particular disc when that disc is played.

- ADVANCED (DVD only) (page 42)**

You can check play information about the bit rate or the position where the disc is being played (layer).

- CUSTOM PARENTAL CONTROL (page 43)**

Using a registered password, you can set playback restrictions for a desired disc. The same password is used for both Parental Control (page 57) and Custom Parental Control.

- SETUP (page 50)**

Using the setup display, you can do the initial setup, adjust the picture and sound and set the various outputs. You can also set a language for the subtitles and the setup display, limit playback by children, and so on. For details about the setup display, see page 50, 51.

- PROGRAM (page 45)**

You can play the contents of the disc in the order you want by arranging the order of the titles, chapters or tracks on the disc to create your own program.

- SHUFFLE (page 47)**

You can have the player "shuffle" titles, chapters or tracks and play them in a random order. Subsequent "shuffling" may produce a different playing order.

- REPEAT (page 48)**

You can play all the titles/tracks on a disc or a single title/chapter/track repeatedly.

- A-B REPEAT (page 49)**

You can play a specific portion of a title, chapter, or track repeatedly.

## Searching for a Title/Chapter/Track/Index/Scene



You can search the disc by title, chapter, track, index or scene.

Select "TITLE," "CHAPTER," "TRACK," "INDEX" or "SCENE" after pressing DISPLAY.

When you play back a DVD, "TITLE" and "CHAPTER" are displayed.

When you play back a VIDEO CD/CD, "TRACK" and "INDEX" are displayed. When you play back a VIDEO CD with PBC functions, "SCENE" is displayed.

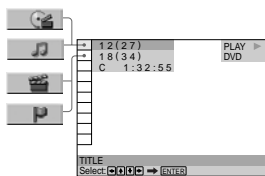

1 Select "TITLE," "CHAPTER," "TRACK," "INDEX" or "SCENE" using  $\uparrow/\downarrow$ .  
"\*\*\* (\*\*\*)" is highlighted (\*\* refers to a number). The number in parentheses indicates the total number of titles, chapters, tracks, indexes or scenes.

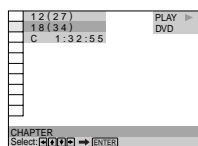

2 Press  $\rightarrow$  or ENTER.  
"\*\*\* (\*\*\*)" changes to "---- (\*\*\*)".

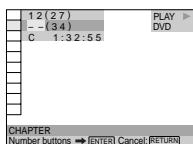

3 Select the number of the title, chapter, track, index or scene you want to search for using the number buttons or  $\uparrow/\downarrow$ , then press ENTER.  
The player starts playback at the selected number. To cancel the number, press CLEAR before pressing ENTER.

**To cancel while making a selection**  
Press  $\leftarrow$  RETURN.

**Notes**

- The title, chapter or track number displayed is the same number recorded on the disc.
- The index numbers are not displayed during PBC playback of VIDEO CDs.

## Checking the Playing Time and Remaining Time



You can check the playing time and remaining time of the current title, chapter or track and the total playing time or remaining time of the disc.

Press DISPLAY. Then press TIME/TEXT on the remote to change the time information.

You can also check the DVD TEXT, CD TEXT or Disc Memo, and label the disc. See page 26.

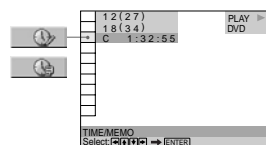

**When playing a DVD**

- **TIME/MEMO or TIME/TEXT**
  - C \*\*\*:\*\*\*:\*\*\*: Playing time of the current chapter
  - C -\*\*\*:\*\*\*:\*\*\*: Remaining time of the current chapter
  - T \*\*\*:\*\*\*:\*\*\*: Playing time of the current title
  - T -\*\*\*:\*\*\*:\*\*\*: Remaining time of the current title

**When playing a VIDEO CD (during PBC playback)**

- **TIME/MEMO**
  - \*\*\*:\*\*\*:\*\*\*: Playing time of the current scene

**When playing a VIDEO CD (in continuous play) or SACD/CD**

- **TIME/MEMO or TIME/TEXT**
  - T \*\*\*:\*\*\*:\*\*\*: Playing time of the current track
  - T -\*\*\*:\*\*\*:\*\*\*: Remaining time of the current track
  - D \*\*\*:\*\*\*:\*\*\*: Playing time of the current disc
  - D -\*\*\*:\*\*\*:\*\*\*: Remaining time of the current disc

**You can select "TIME/MEMO" or "TIME/TEXT" directly**  
Press TIME/TEXT on the remote. Each time you press the button, the time information changes.

**Note**  
The displayed time may vary depending on the play mode.

## Selecting a Starting Point Using the Time Code



You can search for a starting point by inputting the time code.

Select "TIME/MEMO" or "TIME/TEXT" after pressing DISPLAY.

The time code corresponds to the approximate actual playing time. For example, to search for a scene 2 hours 10 minutes 20 seconds past the beginning, input 2:10:20.

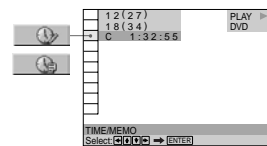

1 Select "C \*\*\*:\*\*\*:\*\*\*" (playing time of the current chapter) when playing a DVD.

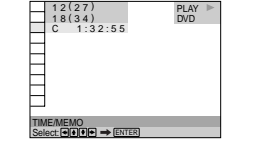

2 Press  $\rightarrow$  or ENTER.  
Time code changes to "T----:--:--".

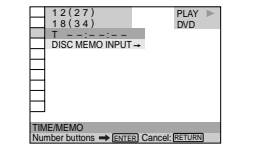

- 3** Input the time code using the number buttons, then press ENTER.  
The player starts playback at the selected time code. To cancel the number, press CLEAR before pressing ENTER.

**To cancel while making a selection**  
Press  $\rightarrow$  RETURN.

**Note**  
When you input the time code, input the playing time of the title, not the chapter or track time.

## Labeling the Disc

You can label discs so that the label appears on your TV screen and the front panel display when you play the disc. If the disc already has DVD TEXT, SACD TEXT or CD TEXT recorded on it, then this information will appear instead.

Press DISPLAY. "TIME/MEMO" appears. Press TIME/TEXT on the remote until the Disc Memo appears at the bottom of the display. If the disc does not contain a label, "NO TEXT" is displayed. Follow the steps below to label a disc.

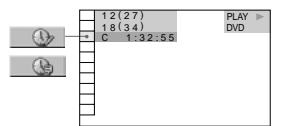

Disc Memo or DVD/CD TEXT

You can select "TIME/MEMO" or "TIME/TEXT" directly. Press TIME/TEXT on the remote. To display DVD/CD TEXT or Disc Memo, press TIME/TEXT until DVD/CD TEXT or Disc Memo is displayed.

You can view the entire DVD/CD TEXT or Disc Memo recorded on the disc. DVD/CD TEXT or Disc Memo is scrolled on the front panel display.

**Note**  
This player can only display the first level of DVD/CD TEXT information.

### Labeling discs (Disc Memo)

When DVD TEXT or CD TEXT is not recorded on the disc, you can put a personal title on the disc by labeling it on the on-screen display. You can input up to 20 characters per disc.

You can also have the player display the Disc Memo each time you select the disc. The Disc Memo can be anything you like, such as a title, musician's name, category or date of purchase.

Using Various Functions with the Control Menu

Using Various Functions with the Control Menu

33

## Labeling the Disc

- 1** Select "TIME/MEMO" and press ENTER.  
"DISC MEMO INPUT" appears.

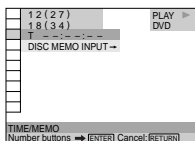

- 2** Select "DISC MEMO INPUT" and press ENTER.  
The DISC MEMO INPUT display appears.

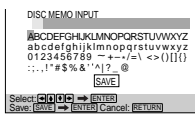

- 3** Select a character by pressing  $\leftarrow/\uparrow/\downarrow/\rightarrow$ .  
The selected character changes color.

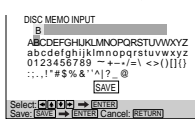

- 4** Press ENTER.

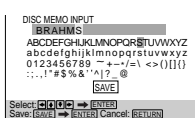

- 5** Repeat steps 3 and 4 to input other characters.

- 6** When you have entered all the characters for the Disc Memo, select [SAVE] by pressing  $\leftarrow/\uparrow/\downarrow/\rightarrow$  and then press ENTER.  
The Disc Memo is stored.

### To correct the characters

- To erase the characters:
  - 1 Move the cursor to the character you want to erase by pressing  $\leftarrow$  or  $\rightarrow$ .
  - 2 Press CLEAR.
- To insert or overwrite the characters:
  - 1 Move the cursor to the character you want to correct by pressing  $\leftarrow$  or  $\rightarrow$ .
  - 2 Select the correct character by pressing  $\leftarrow/\uparrow/\downarrow/\rightarrow$  or by turning the click shuttle.
  - 3 To insert the character, press ENTER.  
To overwrite, don't press ENTER but move the cursor by pressing  $\leftarrow$  or  $\rightarrow$ .

### Notes

- Do not turn off the player by pressing POWER. Doing so may cancel the settings. When you turn off the player, press  $\blacksquare$  first to stop playback and then press I/O on the remote. After the power indicator lights up in red and the player enters standby mode, press POWER on the player.
- You can label up to 300 discs. When you have the player store over 300 discs in memory, each new Disc Memo erases the oldest Disc Memo from those first stored.

34

## Changing the Sound

If the DVD is recorded with multilingual tracks, you can select the language you want while playing the DVD. If the DVD is recorded in multiple audio formats (PCM, Dolby Digital or DTS), you can select the audio format you want while playing the DVD.

With multiples CDs or VIDEO CDs, you can select the sound from the right or left channel and listen to the sound of the selected channel through both the right and left speakers. In this case, the sound loses its stereo effect. For example, with a disc containing a song, the right channel may output the vocals and the left channel may output the instrumental. If you only want to hear the instrumental, you can select the left channel and hear it from both speakers.

Select "AUDIO" after pressing DISPLAY.

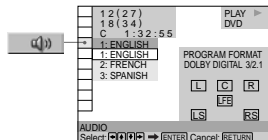

### AUDIO

#### When playing a DVD

Select the language. The languages you can select are different depending on the DVD. When 4 digits are displayed, they represent the language code. Select the language code from the list on page 73.

When the same language is displayed two or more times, the DVD is recorded in multiple audio formats. The current audio format is shown on the "PROGRAM FORMAT" display.

#### When playing a VIDEO CD or a CD

- The default setting is underlined.
- STEREO: The standard stereo sound
  - 1/L: The sound of the left channel (monaural)
  - 2/R: The sound of the right channel (monaural)

You can select AUDIO directly. Press AUDIO on the remote. Each time you press the button, the item changes.

### Notes

- You cannot change the sound for SACDs.
- Depending on the DVD, you may not be able to change the languages even if multilingual tracks are recorded on the DVD.
- While playing the CD/VIDEO CD, standard stereo playback will be resumed when:
  - you open the disc tray
  - the player enters standby mode by pressing I/O on the remote
  - you turn the power off by pressing POWER on the player
- While playing the DVD, the sound may change automatically.
- If "DTS" is set to "OFF" in "AUDIO SETUP", the DTS track selection option will not appear on the screen even if the disc contains DTS tracks.

Using Various Functions with the Control Menu

Using Various Functions with the Control Menu

35

## Changing the Sound

### Displaying the audio information of the disc

When you select "AUDIO," the channels being played are displayed on the screen. For example, in Dolby Digital format, multiple signals ranging from monaural to 5.1 channel signals can be recorded on a DVD. Depending on the DVD, the number of the recorded channels may be different.

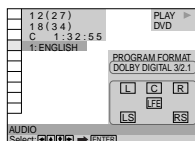

"PCM," "DTS" or "DOLBY DIGITAL" is displayed. In case of "DOLBY DIGITAL," the channels in the playing track are displayed by numbers as follows:

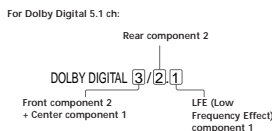

The letters in the program format display mean the following:

- L: Front (left)
- R: Front (right)
- C: Center (monaural)
- LS: Rear (left)
- RS: Rear (right)
- S: Rear (monaural) - the rear component of the Dolby Surround processed stereo signal and the Dolby Digital Signal.
- LFE: LFE (Low Frequency Effect)

The display examples are as follows:  
• PCM (stereo)

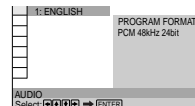

### Dolby Surround

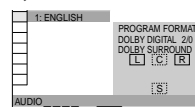

### Dolby Digital 5.1ch

"LFE" is always enclosed in a solid line regardless of the LFE signal component being output.



### DTS

"LFE" is always enclosed in a solid line regardless of the LFE signal component being output.

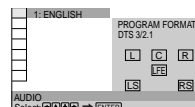

36

## Displaying the Subtitles

DVD

With DVDs on which subtitles are recorded, you can turn the subtitles on and off whenever you want while playing the DVD.

With DVDs on which multilingual subtitles are recorded, you can change the subtitle language whenever you want while playing the DVD, and turn it on or off whenever you want. For example, you can select the language you want to practice and turn the subtitles on for better understanding.

Select "SUBTITLE" after pressing DISPLAY.

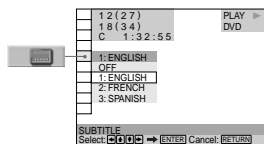

### SUBTITLE

Select the language. The languages you can select are different depending on the DVD. When 4 digits are displayed, they indicate the language code. Select the language code from the list on page 73.

You can select "SUBTITLE" directly. Press SUBTITLE on the remote. Each time you press the button, the item changes.

### Notes

- When playing a DVD on which no subtitles are recorded, no subtitles appear.
- Depending on the DVD, you may not be able to turn the subtitles on even if they are recorded on the DVD.
- Depending on the DVD, you may not be able to turn the subtitles off.
- The type and number of languages for subtitles vary from disc to disc.
- Depending on the DVD, you may not be able to change the subtitles even if multilingual subtitles are recorded on it.
- While playing the DVD, the subtitle may automatically change.

## Changing the Angles

DVD

With DVDs on which various angles (multi-angles) for a scene are recorded, you can change the angles. For example, while playing a scene of a train in motion, you can display the view from either the front of the train, the left window of the train or from the right window without having the train's movement interrupted.

Select "ANGLE" after pressing DISPLAY. When the angles can be changed, the "ANGLE" indicator lights up in green.

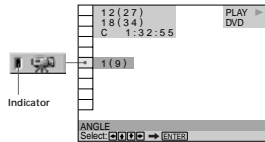

### 1 Select "ANGLE."

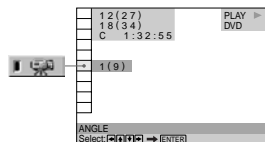

### 2 Press →.

The number of the angle changes to "-". The number in parentheses indicates the total number of angles.

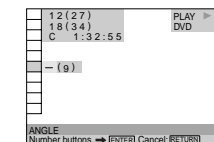

## Changing the Angles

3 Select the angle number using the number buttons or ↑/↓, then press ENTER.

The angle is changed to the selected angle.

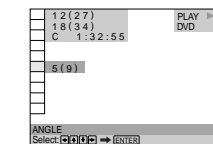

You can select the angle directly.

Press ANGLE on the remote. Each time you press the button, the angle changes.

### Notes

- The number of angles varies from disc to disc or from scene to scene. The number of angles that can be changed on a scene is equal to the number of angles recorded for that scene.
- Depending on the DVD, you may not be able to change the angles even if multi-angles are recorded on the DVD.

## Adjusting the Picture

(VIDEO CONTROL) DVD

You can adjust the playback image of a DVD to match the light level of your room or the type of software that you are watching.

By using the noise reduction function, you can lessen the flickering that appears in the still areas of a playback image. You also can adjust the gamma level to improve the light areas of images that appear washed out or the dark areas that lack definition.

By making settings for different DVD genres such as movies or concerts and storing these settings in Memory 1 through 5, you can quickly adjust the player to the type of DVD software that you are watching. You can also save these settings for up to 300 individual discs using the Playback Memory function. See page 56 for more information about Playback Memory.

Select "VIDEO CONTROL" after pressing DISPLAY.

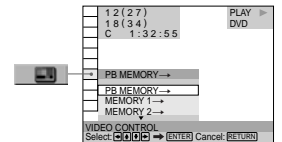

### VIDEO CONTROL

- PB MEMORY → Plays a DVD according to the video control settings. You can select this item only when you set "PLAYBACK MEMORY" to "ON" in the "CUSTOM SETUP" display.
- MEMORY 1 to 5 → Plays a DVD according to the settings saved in memory 1 through 5. To make a setting, see "Adjust the picture items" on the next page.

37

38

## Selecting a video control setting to be applied during playback

1 Select VIDEO CONTROL using ↑/↓, then press ENTER.

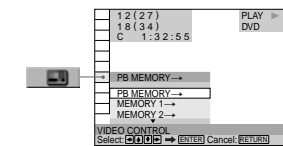

2 Select the video control setting you want to apply during playback using ↑/↓, then press ENTER.

The "VIDEO CONTROL" display appears.

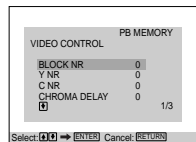

3 Confirm the setting and press →/RETURN.

Playback starts according to the selected setting.

To make additional changes to the selected setting When "VIDEO CONTROL" is displayed in step 2, select the item you want to adjust using ↑/↓, then press ENTER. You can now adjust the item. The new setting can be saved to the Playback Memory for the current disc regardless of the video control setting (PB MEMORY → or MEMORY 1 to 5). However, the original MEMORY 1 to 5 settings will not change.

### Notes

- If you remove the disc or press I/O on the remote and place the player in standby mode when "PLAYBACK MEMORY" is set to "ON" in the "CUSTOM SETUP" display, the current PB MEMORY → or MEMORY 1 to 5 settings are saved to Playback Memory for the current disc.
- If you have selected MEMORY 1 to 5 but do not want to change the Playback Memory setting for the current disc, select PB MEMORY → before removing the disc or pressing I/O on the remote to place the player in standby mode.

## To adjust the picture items

You can adjust each element of the picture individually and save the adjustments to each disc (Playback Memory) or to one of the five settings (Memory 1 through 5).

- BLOCK NR (noise reduction): Reduce the "block noise" or the mosaic like patterns that appear on your screen.
- Y (luminance) NR: This reduces the noise contained in the luminance element of the image's video signal.
- C (chroma) NR: This reduces the noise contained in the color (chroma) element of the image's video signal.
- CHROMA DELAY: Adjust this when the color of images on your screen appear to have shifted horizontally.
- PICTURE: Changes the contrast.
- BRIGHTNESS: Changes the overall brightness.
- COLOR: Makes the colors deeper or lighter.
- HUE: Changes the color balance.
- SHARPNESS: This will sharpen the outline of images.
- GAMMA: This will adjust the washed out or darkened areas of an image. See "Gamma Correction" on the next page for more information.

1 Select "VIDEO CONTROL" using ↑/↓ and press ENTER.

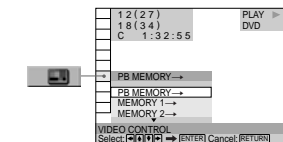

2 Select "PB MEMORY →" or memory number you want to adjust using ↑/↓ and press ENTER.

The "VIDEO CONTROL" display appears.

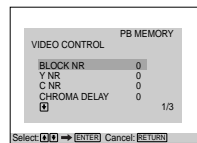

## Adjusting the Picture (VIDEO CONTROL)

3 Select an item you want to adjust using ↑/↓ and press ENTER.

The selected item appears.

To cancel adjusting the picture, press →/RETURN before pressing ENTER.

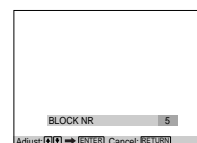

4 Adjust the item you selected using ↑/↓ and press ENTER.

The adjusted value is displayed.

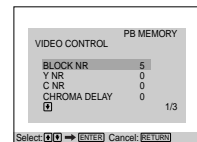

5 When you want to adjust another item, repeat steps 3 to 4.

6 If you selected "PB MEMORY →" The adjusted values are stored in memory when you remove the disc or press I/O on the remote and place the player in standby mode.

If you selected a memory number Select [SAVE] at the bottom of the "VIDEO CONTROL" display by pressing ↑/↓ and press ENTER.

The adjusted values are stored in memory for the memory number you selected in step 2.

To reset the value you adjusted Select "RESET" in the "VIDEO CONTROL" display by pressing ↑/↓ and press ENTER.

### Notes

- Depending on the disc, the effects of BLOCK NR, Y NR and C NR may be difficult to discern.
- HUE is not available when a interface format (480i) signal is output through the COMPONENT VIDEO OUT connectors.

## Adjusting the areas of an image that are too light or dark (Gamma Correction)

Depending on your TV or viewing environment, images on the screen may lose definition because certain areas of the image are too light or too dark. When it is too light, the image will appear to be washed out, and when it is too dark, the image will blend into the surrounding dark areas.

By correcting the Gamma value, you can alter the brightness of selected areas so that the image can be seen clearly. Since the BRIGHTNESS adjustment controls the brightness of the entire image, the Gamma adjustment is useful when you need to increase the brightness of just the area that is too bright or too dark.

Example: You are watching a movie that is rich in shadows and you want to be able to see the details of the scenery hidden in these shadows. If you use the BRIGHTNESS function to increase the brightness, the brightness of the entire image will increase, thus causing the light areas of the image to become washed out. By using the Gamma Correction feature, you can gradually increase the brightness of just the dark areas of an image without sacrificing the detail of the entire image.

1 Select "VIDEO CONTROL" using ↑/↓ and press ENTER.

2 Select "PB MEMORY →" or memory number you want to correct the gamma value by pressing ↑/↓ and press ENTER.

The "VIDEO CONTROL" display appears.

3 Press ↓ to select "GAMMA" and press ENTER.

The "GAMMA" adjust display appears.

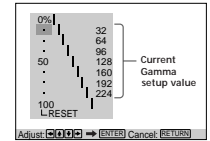

40

39

- 4 Press  $\uparrow/\downarrow$  to select areas of an image. The upper region adjusts the dark areas and the lower region adjusts the light areas.

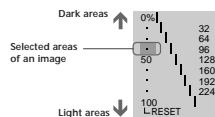

- 5 Press  $\leftarrow/\rightarrow$  to adjust the brightness level of the area that you selected.  $\leftarrow$  will decrease the level (darkens the area), and  $\rightarrow$  will increase the level (lightens the area). The level can be adjusted between 16 and 235. However, the level for the dark areas can never be greater than the light areas.

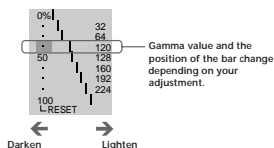

- 6 Repeat steps 4 and 5 to adjust the brightness level of other areas that you select. Try to keep the line that connects the brightness level of each area as smooth and straight as possible.

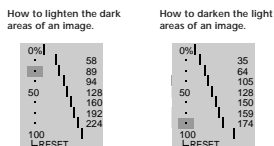

To prevent the image from appearing overly altered, do not give the line any sharp changes. Gradually make the adjustments while viewing the image on your TV screen. Press  $\rightarrow$  RETURN to stop making adjustments to the image.

- 7 Press ENTER. "VIDEO CONTROL" display appears.
- 8 • If you selected "PB MEMORY" The adjusted values are stored in memory when you remove the disc or press I/O on the remote and place the player in standby mode.
- If you selected a memory number Select [SAVE] at the bottom of the "VIDEO CONTROL" display by pressing  $\uparrow/\downarrow$  and press ENTER. The adjusted values are stored in memory for the memory number you selected in step 2.

To reset only the gamma value to the default setting Select "RESET" in the gamma adjustment display by pressing  $\uparrow/\downarrow$  and press ENTER.

You can move the gamma adjustment display horizontally By pressing  $\leftarrow/\rightarrow$ , you can move the gamma adjustment display horizontally.

Using Various Functions with the Control Menu

## Checking the Play Information DVD

You can check information such as the bit rate or the disc layer that is being played. While playing a disc, the approximate bit rate of the playback picture is always displayed as Mbps (Mega bit per second) and the audio as kbps (kilo bit per second).

Select "ADVANCED" after pressing DISPLAY.

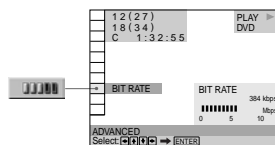

■ **ADVANCED**  
The default setting is underlined.

- When playing a DVD
- **BIT RATE:** displays the bit rate.
  - **LAYER:** displays the layer and the pick-up point.
  - **OFF:** turns off ADVANCED display.

### Displays of each item

By pressing DISPLAY repeatedly, you can display either "BIT RATE" or "LAYER," whichever was selected in "ADVANCED."

#### BIT RATE

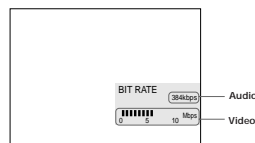

Bit rate refers to the amount of video/audio data per second in a disc. The higher the bit rate, the larger the amount of data. When the bit rate level is high, there is a large amount of data. However, this does not always mean that you can get higher quality pictures or sounds.

#### LAYER

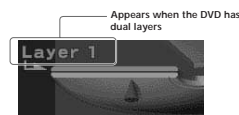

Indicates the approximate point where the disc is playing. If it is a dual-layer DVD, the player indicates which layer is being read ("Layer 0" or "Layer 1"). For details on the layers, see page 71 (DVD).

## Locking Discs (Custom Parental Control) DVD VIDEO SACD

Using a registered password, you can set playback restrictions for the desired disc. You can set the same Custom Parental Control password for up to 300 discs. When you set the three hundred and first disc, the first disc is canceled. The same password is used for both Parental Control (page 57) and Custom Parental Control.

Select "CUSTOM PARENTAL CONTROL" after pressing DISPLAY.

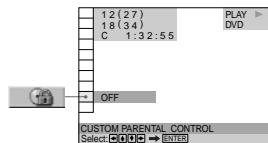

### Setting the Custom Parental Control for a disc

- 1 Insert the disc you want to lock. If a disc is playing, press  $\blacksquare$  to stop playback.
- 2 Select "CUSTOM PARENTAL CONTROL" using  $\uparrow/\downarrow$ , then press ENTER.

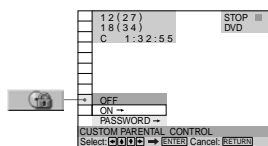

- 3 Select "ON" using  $\uparrow/\downarrow$ , then press ENTER.

■ If you have not entered a password  
The display for entering a password appears.

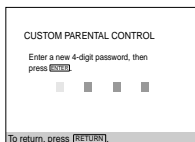

■ When you have already registered a password  
The display for confirming the password appears. Skip Step 4.

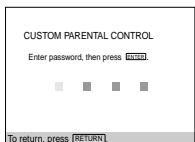

- 4 Enter a 4-digit password using the number buttons, then press ENTER. The digits change to asterisks (\*), and the display for confirming the password appears.

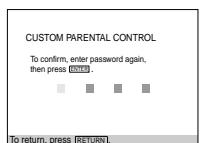

- 5 Enter the same 4-digit password using the number buttons, then press ENTER. "Custom parental control is set." appears and then the screen returns to the Control Menu display.

Using Various Functions with the Control Menu

## Locking Discs (Custom Parental Control)

To return to the normal screen  
Press  $\rightarrow$  RETURN.

To turn off the Custom Parental Control function  
1 Select "CUSTOM PARENTAL CONTROL" using  $\uparrow/\downarrow$ , then press ENTER.  
2 Select "OFF" using  $\uparrow/\downarrow$ , then press ENTER.  
3 Enter your 4-digit password using the number buttons, then press ENTER.

To change the password  
1 Select "CUSTOM PARENTAL CONTROL" using  $\uparrow/\downarrow$ , then press ENTER.  
2 Select "PASSWORD" using  $\uparrow/\downarrow$ , then press ENTER.  
3 Enter your 4-digit password using the number buttons, then press ENTER.  
The display for changing the password appears.  
4 Enter a new 4-digit password using the number buttons, then press ENTER.  
5 To confirm your password, re-enter it using the number buttons, then press ENTER.

### Playing the disc for which the Custom Parental Control is set

- 1 Insert the disc. The CUSTOM PARENTAL CONTROL display appears.

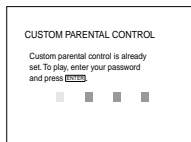

- 2 Enter your 4-digit password using the number buttons, then press ENTER. The player starts playback.

If you forget your password  
Enter the 6-digit number "199703" whenever the CUSTOM PARENTAL CONTROL display asks you for your password, then press ENTER. The display will ask you to enter a new 4-digit password.

Note  
Unless you enter the password, the player cannot play the disc for which the Custom Parental Control is set. When you do not know the password, press  $\blacksquare$  and remove the disc.

## Creating Your Own Program (Program Play)

You can play the contents of the disc in the order you want by arranging the order of the titles, chapters or tracks on the disc and create your own program. One program can be stored in the player and contain up to 99 titles, chapters and tracks.

Select "PROGRAM" after pressing DISPLAY. When you select "ON," the "PROGRAM" indicator lights up in green.

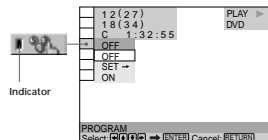

### PROGRAM

The default setting is underlined.

- OFF: plays normally.
- SET: allows you to create your own program.
- ON: plays Program Play.

### Creating the program

- Select "SET" in "PROGRAM."

The programming display appears.

"TRACK" is displayed when you play a VIDEO CD or a SACD/CD.

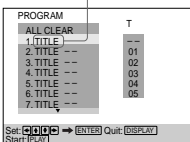

- Press "01". "01" is highlighted. It is ready to set the first title or track for Program Play.

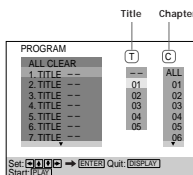

- Select the title, chapter or track you want to program using  $\uparrow/\downarrow$ , then press ENTER. For example, select title or track 2. (You can also use the number buttons and ENTER button to make a selection. In this case, the selected number is displayed on the screen.)

### When playing a DVD

When both titles and chapters are recorded on the disc, select the title, then the chapter.

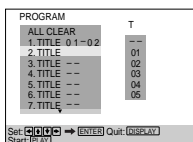
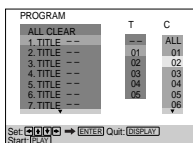

## Creating Your Own Program (Program Play)

- When playing a VIDEO CD or SACD/CD Select the track you want to program.

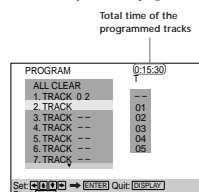

- To program other titles, chapters or tracks, repeat Step 3. The programmed titles, chapters or tracks are displayed in the selected order.

- Press  $\triangleright$  to start Program Play

To stop Program Play Press CLEAR.

To cancel programming Press PROGRAM on the remote.

### To change the program

- In Step 2, select the program number of the title, chapter or track you want to change using  $\uparrow/\downarrow$ .
- Follow Step 3 for new programming.

### To cancel the programmed order

- To cancel all the titles, chapters or tracks in the programmed order, select "ALL CLEAR" in Step 2.
- To cancel the selected program, select the program using  $\uparrow/\downarrow$  in Step 2 then press CLEAR, or select "--" in Step 3 then press ENTER.

The program remains even after Program Play ends. When you press  $\triangleright$ , you can play the same program again.

You can do Repeat Play or Shuffle Play of the programmed titles, chapters or tracks. During Program Play, press REPEAT or SHUFFLE on the remote. Or set "REPEAT" or "SHUFFLE" to "ON" in the Control Menu display.

You can select PROGRAM directly. Press PROGRAM on the remote.

You can select discs, titles, chapters and tracks for the program by looking at the front panel display. You can program by looking at the front panel display instead of using the programming display on the TV screen. When you select Track 3 in a CD for program 1, the front panel display will appear as follows:

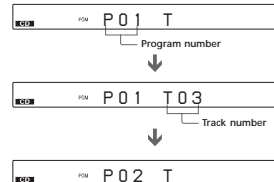

### Notes

- The number of titles, chapters or tracks displayed are the same number of titles, chapters or tracks recorded on a disc.
- The program is canceled when:
  - you open the disc tray
  - the player enters standby mode by pressing I/O on the remote
  - you turn the power off by pressing POWER on the player
- Depending on the DVD, you may not be able to perform Program Play.
- If you are using the PBC playback function, you must first stop the disc before you can set a program.
- When playing SACDs, the track number appears as three digits.

45

46

## Playing in Random Order (Shuffle Play)

You can have the player "shuffle" titles or tracks and play them in a random order. Subsequent "shuffling" may produce a different playing order.

Select "SHUFFLE" after pressing DISPLAY. When you select a shuffle mode other than "OFF," the "SHUFFLE" indicator lights up in green.

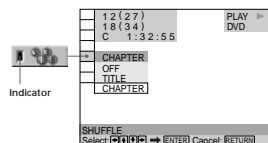

### SHUFFLE

Selects the Shuffle Play setting. The default settings are underlined.

When playing a DVD and when Program Play is set to OFF

- OFF: does not play a disc in random order.
- TITLE: has the player "shuffle" titles and play them in a random order.
- CHAPTER: has the player "shuffle" chapters and play them in a random order.

When playing a VIDEO CD or SACD/CD (when Program Play is set to OFF)

- OFF: does not play a disc in random order.
- TRACK: has the player "shuffle" tracks and play them in a random order.

When playing a VIDEO CD, SACD/CD or DVD (when Program Play is set to ON)

- OFF: does not play a disc in random order.
- ON: has the player "shuffle" titles or tracks selected in Program Play and play them in a random order.

To stop Shuffle Play Press CLEAR.

You can set Shuffle Play while the disc is stopped. After selecting the "SHUFFLE" option, press  $\triangleright$ . The player starts Shuffle Play.

You can select "SHUFFLE" directly. Press SHUFFLE on the remote. Each time you press the button, the item changes.

### Notes

- Shuffle Play is canceled when:
  - you open the disc tray
  - the player enters standby mode by pressing I/O on the remote
  - you turn the power off by pressing POWER on the player
- Depending on the DVD, you may not be able to perform Shuffle Play.
- Up to 200 chapters in a disc can be played in random order when "CHAPTER" is selected.
- You cannot perform Shuffle Play during PBC playback of VIDEO CDs (page 25).

## Playing Repeatedly (Repeat Play)

You can play all of the titles or tracks on a disc or a single title, chapter or track repeatedly. In Shuffle or Program Play mode, the player repeats the titles or tracks in the shuffled or programmed order. You cannot perform Repeat Play during PBC playback of VIDEO CDs (page 25).

Select "REPEAT" after pressing DISPLAY. When you select a repeat mode other than "OFF," the "REPEAT" indicator lights up in green.

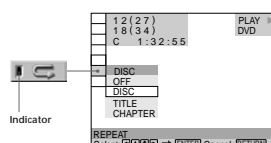

### REPEAT

Selects the Repeat Play setting. The default settings are underlined.

When playing a DVD and when Program Play and Shuffle Play are set to OFF

- OFF: does not play repeatedly.
- DISC: repeats all of the titles.
- TITLE: repeats the current title on a disc.
- CHAPTER: repeats the current chapter.

When playing a VIDEO CD/SACD/CD and when Program Play and Shuffle Play are set to OFF

- OFF: does not play repeatedly.
- DISC: repeats all of the tracks on a disc.
- TRACK: repeats the current track.

When Program Play or Shuffle Play is on

- OFF: does not play repeatedly.
- ON: repeats Program Play or Shuffle Play.

To stop Repeat Play Press CLEAR on the remote.

You can set Repeat Play while the disc is stopped. After selecting the "REPEAT" option, press  $\triangleright$ . The player starts Repeat Play.

You can select "REPEAT" directly. Press REPEAT on the remote. Each time you press the button, the item changes.

### Notes

- Repeat play is canceled when:
  - you open the disc tray
  - the player enters standby mode by pressing I/O on the remote
  - you turn the power off by pressing POWER on the player
- Depending on the DVD, you may not be able to perform Repeat Play.

47

48



## Repeating a Specific Portion (A-B Repeat)

You can play a specific portion of a title, chapter or track repeatedly. This function is useful when you want to do such things as memorize lyrics. During PBC Playback of VIDEO CDs (page 25), this function is available only while playing moving pictures.

Select "A-B REPEAT" after pressing DISPLAY. During A-B Repeat Play, the "A-B REPEAT" indicator lights up in green.

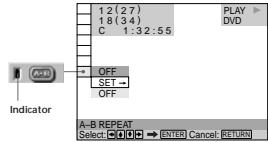

### A-B REPEAT

The default setting is underlined.

- SET → : sets the A and B points.
- CLEAR: does not play a specific portion of a title / chapter / track repeatedly.

### Setting a portion for A-B repeat

- 1 Select "A-B REPEAT" and press ENTER.

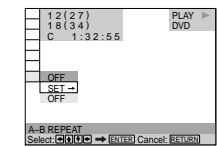

- 2 Select "SET" and press ENTER.

The A-B REPEAT setting display appears.

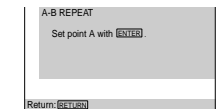

- 3 During playback, when you find the starting point (point A) of the portion to be played repeatedly, press ENTER.

The starting point (point A) is set.

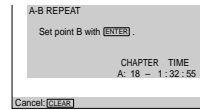

- 4 When you reach the ending point (point B), press ENTER again.

The set points are displayed and the player starts repeating this specific portion. "A-B" appears on the front panel display during A-B repeat play.

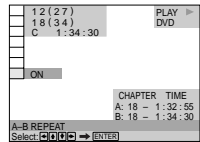

### To stop A-B Repeat Play

Press CLEAR.

You can directly select the portion to be repeated. During playback, press the AA→B button once to set the A (starting) point. Press the button again to set the B (ending) point. The portion between points A and B will be played repeatedly.

### Notes

- You can set A-B Repeat for only one specific portion.
- A-B Repeat is cancelled when:
  - you open the disc tray
  - the player enters standby mode by pressing I/O on the remote
  - you turn the power off by pressing POWER on the player
- When you set A-B Repeat, the settings for Shuffle Play, Repeat Play and Program Play are canceled.
- You may not be able to set A-B Repeat for some DVD or VIDEO CD scenes.

Using Various Functions with the Control Menu

# Settings and Adjustments

This chapter describes how to set and adjust the player using the on-screen setup menu. Most settings and adjustments are required to be set when you first use the player. This chapter also describes how to control the TV or AV receiver (amplifier) using the supplied remote.

## Using the Setup Display

Using the setup display, you can do the initial setup, adjust the picture and sound and set the various outputs. You can also set a language for the subtitles and the setup display, limit playback by children, and so on. For details on each setup display item, see pages 52 to 63.

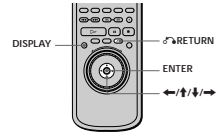

- 1 Press DISPLAY and select "SETUP" using ↑/↓.

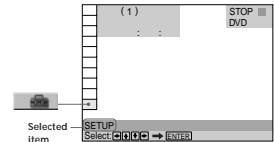

- 2 Press ENTER. The setup display appears.

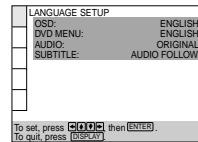

## Setup Display Item List

The default settings are underlined.

- 3 Select the main item you want using ↑/↓.

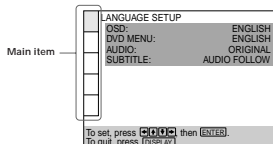

- 4 Press ENTER.

The selected main item is highlighted.

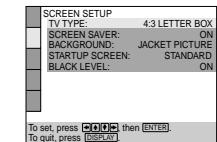

- 5 Select the item you want using ↑/↓.

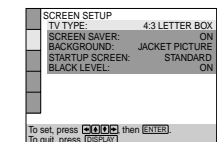

- 6 Press ENTER.

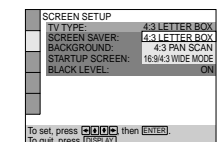

- 7 Select the setting you want using ←/→.

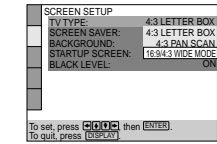

- 8 Press ENTER.

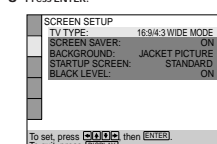

- 9 Press DISPLAY.

The setup display disappears.

- 10 Press DISPLAY repeatedly to turn off the on-screen menu.

To return to the previous screen Press RETURN.

To quit while making a selection Press DISPLAY.

### Notes

- You cannot change some setup display items unless the player stops.
- Some setup display items require operations other than selecting the setting. For details on these items, see the relevant pages.

Settings and Adjustments

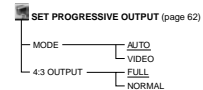
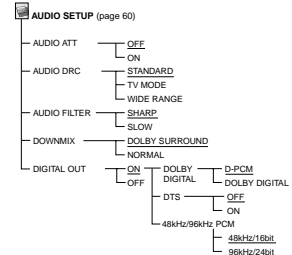
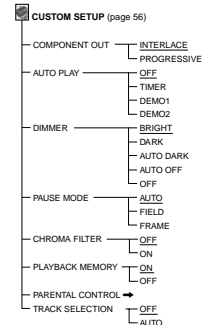
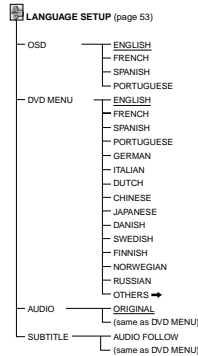

## Setting the Display Language or Sound Track (LANGUAGE SETUP) DVD VIDEO SACD CD

"LANGUAGE SETUP" allows you to set various languages for the on-screen display or sound track. The default settings are underlined.

Select "LANGUAGE SETUP" in the setup display.

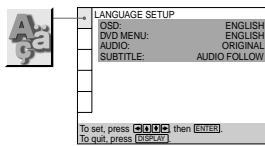

### Notes

- When you select a language that is not recorded on the DVD, one of the recorded languages is automatically selected for the "DVD MENU," "AUDIO" and "SUBTITLE" settings.
- Depending on the DVD, the player may not start playing with the selected language even when you select a language in "DVD MENU," "AUDIO" or "SUBTITLE."

### OSD (On-Screen Display)

Selects the language for the on-screen display.

- ENGLISH
- FRENCH
- SPANISH
- PORTUGUESE

### DVD MENU

Selects the language for the DVD menu.

- ENGLISH
- FRENCH
- SPANISH
- PORTUGUESE
- GERMAN
- ITALIAN
- DUTCH
- CHINESE
- JAPANESE
- DANISH
- SWEDISH
- FINNISH
- NORWEGIAN
- RUSSIAN
- OTHERS

When you select "OTHERS," select and enter the language code from the list using the number buttons (page 73). After you have made a selection, the language code (4 digits) is displayed.

### AUDIO

Selects the language for the sound track.

- ORIGINAL: the language given priority in the disc
- ENGLISH
- FRENCH
- SPANISH
- PORTUGUESE
- GERMAN
- ITALIAN
- DUTCH
- CHINESE
- JAPANESE
- DANISH
- SWEDISH
- FINNISH
- NORWEGIAN
- RUSSIAN
- OTHERS

When you select "OTHERS," select and enter the language code from the list using the number buttons (page 73). After you have made a selection, the language code (4 digits) is displayed.

### SUBTITLE

Selects the language for the subtitles.

- AUDIO FOLLOW
- ENGLISH
- FRENCH
- SPANISH
- PORTUGUESE
- GERMAN
- ITALIAN
- DUTCH
- CHINESE
- JAPANESE
- DANISH
- SWEDISH
- FINNISH
- NORWEGIAN
- RUSSIAN
- OTHERS

When you select "OTHERS," select and enter the language code from the list using the number buttons (page 73). After you have made a selection, the language code (4 digits) is displayed.

When you select "AUDIO FOLLOW," the language for the subtitles changes according to the language you selected for the sound track.

## Settings for the Display (SCREEN SETUP) DVD VIDEO SACD CD

"SCREEN SETUP" allows you to set the display according to the playback conditions. The default settings are underlined.

Select "SCREEN SETUP" in the setup display.

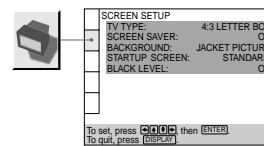

### TV TYPE

Selects the aspect ratio of the TV to be connected.

- 4:3 LETTER BOX: select this when you connect a 4:3 normal screen TV to the player. Displays a wide picture with bands on the upper and lower portions of the screen.
- 4:3 PAN SCAN: select this when you connect a 4:3 normal screen TV to the player. Displays the wide picture on the whole screen automatically and cuts off the portions that do not fit.
- 16:9/4:3 WIDE MODE: select this when you connect a wide-screen TV to the player or when you connect a TV with the WIDE MODE function to the player (displays a wide picture with bands displayed on the upper and lower portions of the screen).

### 4:3 LETTER BOX



### 4:3 PAN SCAN



### 16:9



### 4:3 WIDE MODE



### Note

Depending on the DVD, "4:3 LETTER BOX" may be selected automatically instead of "4:3 PAN SCAN" and vice versa.

### SCREEN SAVER

Turns on and off the screen saver. If you turn on the screen saver, the screen saver image appears when you leave the player or the remote in pause or stop mode for 15 minutes, or when you play back a CD for more than 15 minutes. The screen saver will help prevent your display device from becoming damaged.

- ON: turns on the screen saver.
- OFF: turns off the screen saver.

Settings and Adjustments

### BACKGROUND

Selects the background color or picture on the TV screen in stop mode or while playing a CD.

- JACKET PICTURE: The jacket picture appears in the background, but only when the jacket picture is already recorded on the disc (for instance, a CD-EXTRA).
- PICTURE MEMORY: Your favorite picture appears in the background. For an explanation of how to store your favorite scene recorded on the disc for the background picture, see the following section "Storing a picture in memory."
- GRAPHICS: A preset picture stored in the player appears in the background.
- BLUE: The background color is blue.
- BLACK: The background color is black.

### Note

If a disc which does not contain the jacket picture is played while "BACKGROUND" is set to "JACKET PICTURE," the picture stored in the player will automatically appear in the background.

### STARTUP SCREEN

Selects the startup screen. The startup screen image you selected appears when you turn on the player.

- STANDARD: The standard startup screen in the player's memory appears.
  - PICTURE MEMORY: Your favorite picture appears in the startup screen. For an explanation of how to store your favorite scene recorded on the disc for the startup screen, see the following section "Storing a picture in memory."
- If you select PICTURE MEMORY before setting a picture in memory, the standard startup screen will appear.

### Storing a picture in memory

During playback, when you find the scene to be stored in memory press PICTURE MEMORY on the remote. The picture is stored in memory.

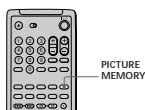

### Notes

- The player can store only one scene in memory. The stored picture appears in both the background and the startup screen.
- When the picture is stored in memory by pressing PICTURE MEMORY, the picture stored before is erased.
- If you operate this player while the picture is being stored in memory, the player will fail to store the picture.
- Depending on the DVD, some scenes cannot be stored in memory.

### BLACK LEVEL

You can select the black level (setup level) for the output video (NTSC) signal. Use this to adjust the picture when dark objects are too pronounced, or when the picture becomes whitish.

- ON: This will set the black level of the output signal to the standard level.
- OFF: This will lower the standard black level. Use this setting when the picture becomes too white.

### Notes

- The standard setup level may differ according to the connected equipment. If the image becomes too white, set the level to OFF.
- Black level setup does not work for progressive (480p) signals output from the COMPONENT VIDEO OUT connectors.

Settings and Adjustments

## Custom Settings (CUSTOM SETUP) DVD VIDEO SACD CD

"CUSTOM SETUP" allows you to set the playback conditions. The default settings are underlined.

Select "CUSTOM SETUP" in the setup display.

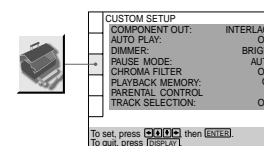

### COMPONENT OUT

This will change the type of signal output from the COMPONENT VIDEO OUT connectors on this player.

- INTERLACE: This outputs the signal in interlace format. Select this when you are connected to a standard (interlace format) TV.
- PROGRESSIVE: This outputs the signal in progressive (480p) format. Select this when you have a TV that can accept progressive signals.

### Note

If you select "PROGRESSIVE" when you connect the player to a TV that cannot accept the signal in progressive format (480p), the image quality will deteriorate. In this case, set the SCAN SELECT switch on the back panel of the player to "INTERLACE." Then set "COMPONENT OUT" to "INTERLACE" when you can see the TV screen correctly, and set SCAN SELECT to "SELECTABLE."

### AUTO PLAY

Selects the Auto Play setting when you connect the AC power cord to the AC outlet.

- OFF: does not use "TIMER," "DEMO1" or "DEMO2" to start playback.
- TIMER: starts playing when the player is turned on, or at any time you want when connected to a timer (not supplied). Set the timer when the player is in standby mode (the power indicator lights up in red).
- DEMO1: starts playing the first demonstration automatically.
- DEMO2: starts playing the second demonstration automatically.

### DIMMER

Adjusts the lighting of the front panel display and indicators.

- BRIGHT: makes the front panel display bright.
- DARK: makes the front panel display dark.
- AUTO DARK: If you do not operate the player or remote for a short while, the front panel display becomes dark.
- AUTO OFF: If you do not operate the player or remote for a short while, the front panel display turns off.
- OFF: This turns off the front panel display.

### Note

You can directly turn on/off the front panel display by using the remote. By pressing FLON/OFF on the remote, you can turn on/off the front panel display regardless the "DIMMER" setting (except when it is set to OFF).

### PAUSE MODE (DVD only)

Selects the picture in pause mode.

- AUTO: Moving subjects are output with no jitter, and still objects are shown at high resolution. The picture remains clear even during slow playback when using the shuttle ring (Clear Frame function). Normally select this position.
- FIELD: A picture including subjects that move is output with less jitter but at a lower resolution than "FRAME."
- FRAME: A picture including subjects that do not move dynamically is output with high resolution.

### CHROMA FILTER

This filter controls the level of the color (chroma) element of the image's video signal to control color saturation level.

- OFF: This turns off the chroma filter. The filter is normally set to off.
- ON: This turns on the chroma filter and adjusts the color saturation level so that colors do not bleed.

### Notes

- This function is not available when the player is set to output progressive video signals.
- If you use the COMPONENT VIDEO OUT connectors, set CHROMA FILTER to OFF to maintain accurate color reproduction.

### PLAYBACK MEMORY

The player can store the SUBTITLE, VIDEO CONTROL and other settings of each disc for up to 300 discs (Playback Memory).

- Set the Playback Memory function on or off.
- ON: stores the settings in memory when you eject the disc or when you press I/O on the remote and the player enters the standby mode with the disc still in the player.
- OFF: does not store the settings in memory.

The following settings are stored in memory by the Playback Memory function.

- AUDIO (page 35)
- SUBTITLE (page 37)
- ANGLE (page 37)
- VIDEO CONTROL (page 38)
- \* DVD only

**Notes**

- The player can store the settings of up to 300 discs. When you store the setting of disc number 301, the first disc setting is canceled.
- Depending on the DVD, the information stored in the disc takes priority over the Playback Memory settings and the function does not work.
- Do not turn off the player by pressing POWER. Doing so may cancel the settings. When you turn off the player, press **■** first to stop playback and then press **II/O** on the remote. After the power indicator lights up in red and the player enters standby mode, press POWER on the player.

**■ PARENTAL CONTROL**

Sets a password and playback limitation level for DVDs with playback limitation for children. The same password is used for both Parental Control and Custom Parental Control (page 43).

For details, see "Limiting Playback by Children (Parental Control)".

**■ TRACK SELECTION**

Gives the sound track which contains the highest number of channels priority when you play a DVD on which multiple audio formats (PCM, DTS or Dolby Digital format) are recorded.

- **QEE**: No priority given.
- **AUTO**: Priority given.

**Notes**

- When you set this item to "AUTO," the language may change depending on the "AUDIO" settings in "LANGUAGE SETUP." The "TRACK SELECTION" setting has higher priority than the "AUDIO" settings in "LANGUAGE SETUP" (page 53).
- If you set "DTS" in "AUDIO SETUP" to "OFF," the DTS sound track is not played even if you set this item to "AUTO" and the highest-numbered audio channel is recorded in DTS format.
- If PCM, DTS and Dolby Digital sound tracks have the same number of channels, the player selects PCM, DTS and Dolby Digital sound tracks in this order.
- Depending on the DVD, the audio channel with priority may be predetermined. In this case, you cannot give priority to the DTS or Dolby Digital format by selecting "AUTO."

**Limiting Playback by Children (Parental Control) DVD**

Playback of some DVDs can be limited depending on the age of the users. The "Parental Control" function allows you to set a playback limitation level.

Select "CUSTOM SETUP" in the setup display.

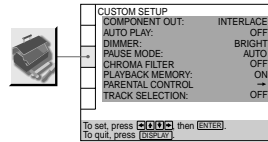

1 Select "PARENTAL CONTROL" using **↑/↓**, then press **ENTER**.

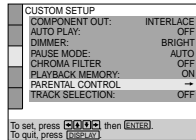

**■ When you have not entered a password**  
The display for entering a password appears.

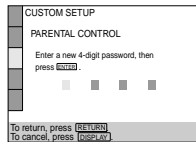

Settings and Adjustments

**Custom Settings (CUSTOM SETUP)**

**■ When you have already registered a password**  
The display for confirming the password appears. Skip Step 2.

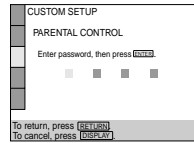

2 Enter a password in 4 digits using the number buttons, then press **ENTER**. The digits change to asterisks (\*), and the display for confirming the password appears.

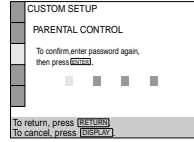

3 To confirm your password, enter it again using the number buttons, then press **ENTER**. The display for setting the playback limitation level and changing the password appears.

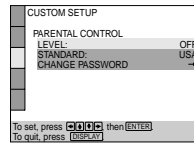

4 Select "STANDARD" using **↑/↓**, then press **→**.

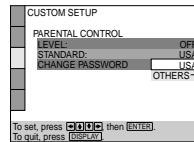

5 Select a geographic area as the playback limitation level standard using **↑/↓**, then press **ENTER**. When you select "OTHERS" **→**, select and enter the standard code in the table on the next page using the number buttons.

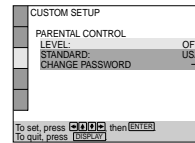

6 Select "LEVEL" using **↑/↓**, then press **→**.

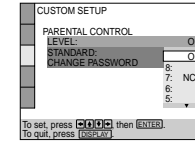

7 Select the level you want using **↑/↓**, then press **ENTER**.

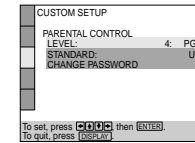

The lower the value, the more strict the limitation.

To return to the normal screen  
Press **DISPLAY**.

To turn off the Parental Control function and play the DVD after entering your password  
Set "LEVEL" to "OFF" in Step 7, then press **▷**.

**To change the password**

- 1 After Step 3, select "CHANGE PASSWORD" using **↑/↓**, then press **→** or **ENTER**. The display for changing the password appears.
- 2 Follow Steps 2 and 3 to enter a new password.

**Playing a disc which is blocked by the playback limitation level**

- 1 Insert the disc and press **▷**. The PARENTAL CONTROL display appears.
- 2 Enter your 4-digit password using the number buttons, then press **ENTER**. The player starts playback. When you stop playing the DVD, the level returns to the original level.

**⚠ If you forget your password**

Enter the 6-digit number "199703" whenever the PARENTAL CONTROL display asks you for your password, then press **ENTER**. The display will ask you to enter a new 4-digit password.

**Notes**

- When you play DVDs which do not have the Parental Control function, playback cannot be limited on this player.
- If you do not set a password, you cannot change the settings for playback limitation.
- Depending on the DVD, you may be asked to change the parental control level while playing the disc. In this case, enter your password, then change the level. When you stop playing the DVD, the level returns to the original level.
- The same password is used for both Parental Control and Custom Parental Control (page 43).

Standard	Code number
Argentina	2044
Australia	2047
Austria	2046
Belgium	2057
Brazil	2070
Canada	2079
Chile	2090
China	2092
Denmark	2115
Finland	2165
France	2174
Germany	2109
Hong Kong	2219
India	2248
Indonesia	2238
Italy	2254
Japan	2276
Korea	2304
Malaysia	2363
Mexico	2362
Netherlands	2376
New Zealand	2390
Norway	2379
Pakistan	2427
Philippines	2424
Portugal	2436
Russia	2489
Singapore	2501
Spain	2149
Sweden	2499
Switzerland	2086
Taiwan	2543
Thailand	2528
United Kingdom	2184

Settings and Adjustments

**Settings for the Sound (AUDIO SETUP)**

"AUDIO SETUP" allows you to set the sound according to the playback conditions. The default settings are underlined.

Select "AUDIO SETUP" in the setup display.

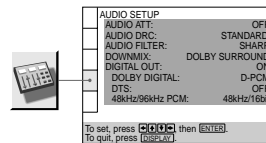

**■ AUDIO ATT (attenuation)**

- If the playback sound is distorted, set this item to "ON." The player reduces the audio output level.
- The setting of the output from the AUDIO OUT (1, 2) connectors according to the audio equipment to be connected.
- **QEE**: turns off the audio attenuation. Normally select this position.
- **ON**: reduces the audio output level so that no sound distortion occurs. Select this when the playback sound from the built-in TV speakers is distorted.

**Note**

The setting does not affect the output from the DIGITAL OUT OPTICAL and COAXIAL connectors.

**■ AUDIO DRC (Dynamic Range Control) (DVD only)**

- Makes the sound clear when the volume is turned down when playing a DVD. This function works only when you play a DVD which has the AUDIO DRC function.
- This affects the output from the DIGITAL OUT connectors only when "DOLBY DIGITAL" is set to "D-PCM" in "DIGITAL OUT."
- **STANDARD**: Normally select this position.
- **TV MODE**: makes the low sounds clear even if you turn the volume down. It is especially recommended when you listen to the sound using the speakers of the TV.
- **WIDE RANGE**: It gives you the original sound recorded in the disc. You may have difficulty hearing the audio, depending on your environment.

**Note**

When you play DVDs without the AUDIO DRC function, there is no effect on the sound.

**■ AUDIO FILTER**

Selects the digital filter to reduce noises above the 22.05 kHz (Sampling frequency (Fs) of the audio source is 44.1 kHz), 24 kHz (Fs is 48 kHz) or 48 kHz (Fs is above 96 kHz).

- **SHARP**: provides a wide frequency range and spatial feeling.
- **SLOW**: provides smooth and warm sound.

**Notes**

- There may be little effect by changing the digital filter, depending on discs or playback environment.
- There is no effect on SACDs.

**■ DOWNMIX**

Switches the mixing down methods when you play a DVD on which rear signal components such as LS, RS, or S are recorded in Dolby Digital format. For details on the rear signal components, see "Displaying the audio information of the disc" (page 36).

The "DOWNMIX" setting affects the following connectors:

- AUDIO OUT connectors
- DIGITAL OUT OPTICAL and COAXIAL connectors (when you set "DOLBY DIGITAL" to "D-PCM" in "AUDIO SETUP" in the setup display)

- **DOLBY SURROUND**: when the player is connected to an audio component that conforms to Dolby Surround (Pro Logic). The output signals which reproduce the Dolby Surround (Pro Logic) effect are mixed down to 2 channels.
- **NORMAL**: when the player is connected to an audio component that does not conform to Dolby Surround (Pro Logic). The signals without the Dolby Surround (Pro Logic) effect are output.

**■ DIGITAL OUT**

Selects output signals via the DIGITAL OUT OPTICAL and COAXIAL connectors.

- **QEE**: Normally select this position. When you select "ON," set "DOLBY DIGITAL," "DTS" and "48kHz/96kHz PCM." For details on setting these items, see "Setting the Digital Output Signal."
- **OFF**: when the player does not output the sound signals via the DIGITAL OUT OPTICAL and COAXIAL connectors, the influence of the digital circuit upon the analog circuit is at a minimum.

You can directly switch the digital audio output on or off. When "DIGITAL OUT" is set to "ON" and the player is stopped, press AUDIO DIRECT on the player. The digital audio output is turned on or off. Note, however, that the "DIGITAL OUT" setting remains the same.

- Notes**
- When you select "OFF" you cannot set "DOLBY DIGITAL," "DTS" and "48kHz/96kHz PCM."
  - SACD sound signals are not output from the DIGITAL OUT OPTICAL or COAXIAL connectors.

### Setting the Digital Output Signal

Switches the methods of outputting audio signals when you connect 1. a digital component such as a receiver (amplifier) having a digital connector, 2. an audio component having a built-in decoder (Dolby Digital or DTS), 3. a DAT or MD via the DIGITAL OUT OPTICAL or COAXIAL connector using an optical or coaxial digital connecting cord. For connection details, see page 13. You cannot adjust "DOLBY DIGITAL," "DTS" and "48kHz/96kHz PCM" if you set "DIGITAL OUT" to "OFF."

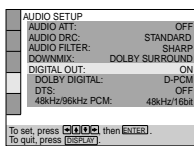

### DOLBY DIGITAL

Selects the Dolby Digital signals to be output via the DIGITAL OUT OPTICAL and COAXIAL connectors.

- D-PCM (Downmix PCM):** when the player is connected to an audio component lacking a built-in Dolby Digital decoder. If you play Dolby Digital sound tracks, the output audio signals are mixed down to 2 channels. You can select whether the signals conform to Dolby Surround (Pro Logic) or not by making adjustments to the "DOWNMIX" item in "AUDIO SETUP."
- DOLBY DIGITAL:** when the player is connected to an audio component with a built-in Dolby Digital decoder. If the player is connected to an audio component lacking a built-in Dolby Digital decoder, do not set this. Otherwise, when you play the Dolby Digital sound track, a loud noise (or no sound) will come out from the speakers, affecting your ears or causing the speakers to be damaged.

### DTS

Outputs the DTS signal from the DIGITAL OUT OPTICAL and COAXIAL connectors.

- QEE:** when the player is connected to an audio component lacking a built-in DTS decoder.
- ON:** when the player is connected to an audio component having a built-in DTS decoder. If the player is connected to an audio component lacking a built-in DTS decoder, do not set this. Otherwise, when you play the DTS sound track, a loud noise (or no sound) will come out from the speakers, affecting your ears or causing the speakers to be damaged.

### 48kHz/96kHz PCM (DVD only)

Selects the sampling frequency and word length of the audio signal to be output via the DIGITAL OUT OPTICAL and COAXIAL connectors.

- 48kHz/16bit:** The audio signals of DVDs are always converted to 48 kHz/16 bit.
- 96kHz/24bit:** All types of signals including 96 kHz/24 bit are output in their original format. However, if the signal is encrypted for copyright protection purposes, the signal is only output as 48 kHz/16 bit.

### Note

If you select "96kHz/24bit" when a receiver (amplifier) which cannot accept 96 kHz is connected to the player, no sound or a loud noise will come out from the speakers.

## Adjusting the Progressive video signal (SET PROGRESSIVE OUTPUT) (DVD)

You can fine-tune the Progressive (480p) video signal output when you have selected "PROGRESSIVE" in "COMPONENT OUT" of the "CUSTOM SETUP" display and connect the player to the TV that is able to accept the video signal in progressive format (480p). The default settings are underlined.

Select "SET PROGRESSIVE OUTPUT" in the setup display.

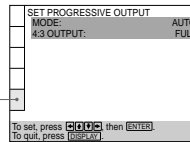

### Note

If you select "PROGRESSIVE" in spite of you connect the player to a TV that cannot accept the signal in progressive format, the image quality will deteriorate. In this case, set SCAN SELECT switch on the back panel of the player to "INTERLACE." Then set "COMPONENT OUT" to "INTERLACE" after you can see the TV screen correctly, and set SCAN SELECT to "SELECTABLE."

### MODE (Conversion Modes)

DVD software can be divided into two types: film based software and video based software. Video based software is derived from TV, such as dramas and sit-coms, and displays images at 30 frames/60 fields per second. Film based software is derived from film and displays images at 24 frames per second. In order for these images to appear natural on your screen when output in PROGRESSIVE mode (60 frames per second), the progressive video signal needs to be converted to match the type of software that you are watching. For more information about conversion modes, see "Progressive Conversion methods of Film Based and Video Based Software."

- AUTO:** This will automatically detect if you are playing Film based or Video based software and convert the signal to the appropriate mode.
- VIDEO:** This will convert the output signal for Video based software, regardless of the type of software that you are playing.

### Notes

- Some DVD software contains both Video and Film. For instance, DVDs of movies may contain the movie taken on film, and a "Making of" sequence taken on video.
- If you select "VIDEO" and play back a DVD that contains Film based software, sections of images may be unclear.
- When you select "AUTO," sections of images may become unclear. This happens when the output signal tag (progressive/interlace) is not correct on the software. If this happens, set the conversion mode to "VIDEO."

### 4:3 OUTPUT

Adjust this when you watch progressive signals on a standard 4:3 aspect ratio television. If you can change the aspect ratio on your progressive format (480p) compatible TV, change the setting on your TV, not the player.

- EULL:** when you can change the aspect ratio on your TV.
- NORMAL:** when you cannot change the aspect ratio on your TV. A 16:9 aspect ratio signal will be shown with black bands on left and right sides of the image, and a 4:3 aspect ratio signal will be shown with black bands on all sides of the image.

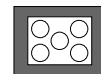
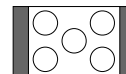

### Progressive Conversion Methods of Film Based and Video Based Software

This player converts video based software and film based software in the following manner.

#### Video based software conversion

Video shows an image by alternately displaying every other line of an image (field) at 30 frames (60 fields) per second (Interlace format).



The Interlace format displays 30 frames (60 fields) per second by displaying every other line of the image, causing scanning lines to appear across the image. Furthermore, since only half of the image is shown at once, the amount of information contained in an image is limited.



The Progressive format displays 60 entire frames per seconds. The player accomplishes this by converting each field into a frame by using either a field-based conversion method or a frame-based conversion method. The appropriate method is automatically selected by the player according to the movement of the images on the screen. If the movement on the screen is slow, the frame-based conversion method makes borrows adjacent field information to fill in the missing information. If the movement on the screen is rapid, the field-based conversion method creates the missing information by predicting the movement of the images on the screen from field to field. The end result is an image that is higher in quality when compared to the Interlace format.

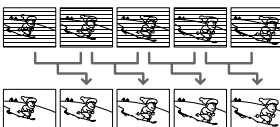

#### Film based software conversion

Film shows an image by displaying an entire image at 24 frames per second. When you watch a film on television, the television displays every other line of the frame as a field, thus reducing information level and the clarity of the film image.

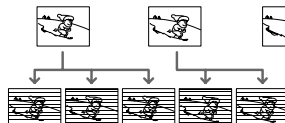

This player solves this problem by increasing the speed at which the frames are displayed, consecutively showing 3 identical frames followed by 2 identical frames in the time that it normally takes to show 2 consecutive frames. The end result is that the 24 frames per second are increased to 60 frames per second, which is the speed at which Progressive video signals are shown.

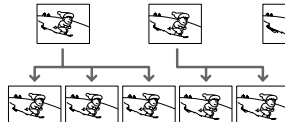

This not only allows film to be shown in a frame based format, it also increases the clarity and sharpness which is unique to Progressive format images.

## Controlling Your TV or AV Receiver (Amplifier) with the Supplied Remote

By adjusting the remote signal, you can control your TV or AV receiver (amplifier) with the supplied remote.

### Controlling TVs with the remote

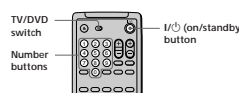

- Slide the TV/DVD switch to TV.
- Hold down I/O, and enter your TV's manufacturer's code (see the table) using the number buttons. Then release I/O.

#### Code numbers of controllable TVs

If more than one code number is listed, try entering them one at a time until you find the one that works with your TV.

Manufacturer	Code number	Manufacturer	Code number
Sony (default)	01	Panasonic	06,19
Akai	04	Philco	03,04
AOC	04	Philips	08
Centurion	12	Pioneer	16
Coronado	03	Portland	03
Curis-Mathes	12	Quasar	06,18
Daytron	12	Radio Shack	05,14
Emerson	03,04,14	RCA	04,10
Fisher	11	Sampo	12
General Electric	06,10	Sanyo	11
Gold Star	03,04,17	Scott	12
Hitachi	02,03	Sears	07,10,11
J.C.Penney	04,12	Sharp	03,05,18
JVC	09	Sylvania	08,12
KMC	03	Teknika	03,08,14
Magnavox	03,08,12	Toshiba	07
Marantz	04,13	Wards	03,04,12
MGA/Mitsubishi	04,12,13,17	Yors	12
NEC	04,12	Zenith	15

### Notes

- If you enter a new code number, the code number previously entered will be erased.
- When you replace the batteries of the remote, the code number may be reset to the default setting. Reset the appropriate code number.

#### Controlling the TV

You can control your TV using the buttons below. When you set the TV/DVD switch to TV, you can also control the number, I/O and ENTER buttons.

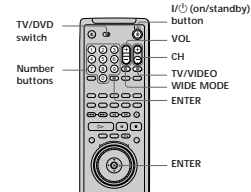

By pressing	You can
I/O	Turn the TV on or off
TV/VIDEO*	Switch the TV's input source between the TV and other input sources
VOL	Adjust the volume of the TV
CH*	Select the channel of the TV
WIDE MODE*	Switch to or from the wide mode of a Sony Wide TV.
Number buttons and ENTER	Select the channel of the TV

\* These buttons also work when the TV/DVD switch is set to DVD.

### Note

Depending on the TV, you may not be able to control your TV or to use some of the buttons above.

### Controlling AV receivers (amplifiers) with the remote

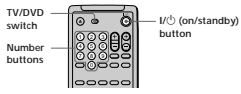

- Slide the TV/DVD switch to DVD.
- Hold down I/O, and enter your AV receiver's manufacturer's code (see the table) using the number buttons. Then release I/O.

#### Code numbers of controllable AV receivers (amplifier)

If more than one code number is listed, try entering them one at a time until you find the one that works with your AV receiver (amplifier).

Manufacturer	Code number
Sony	91 (default), 89
Demon	84, 85, 86
Kenwood	92, 93
Onkyo	81, 82, 83
Pioneer	99
Sansui	87
Technics	97, 98
Yamaha	94, 95, 96

#### Notes

- If you enter a new code number, the code number previously entered will be erased.
- When you replace the batteries of the remote, the code number may be reset to the default setting. Reset the appropriate code number.

### Controlling the AV receiver (amplifier)

You can change the volume of the AV receiver (amplifier) using VOL.

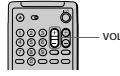

#### Note

Depending on the AV receiver (amplifier), you may not be able to control your AV receiver (amplifier).

## Additional Information

### Troubleshooting

If you experience any of the following difficulties while using the player, use this troubleshooting guide to help remedy the problem. Should any problem persist, consult your nearest Sony dealer.

#### Power

**The power is not turned on.**

- Check that the AC power cord is connected securely.

#### Picture

**There is no picture.**

- Check that the player is connected securely.
- The video connecting cord is damaged. Replace it with a new one.
- Make sure you connect the player to the video input connector on the TV. (page 10)
- Make sure you turn on the TV.
- Make sure you select the video input on the TV so that you can view the pictures from the player.

**Picture noise appears.**

- Clean the disc.
- If the video signal from your DVD player has to go through your VCR to get to your TV, the copy-protection applied to some DVD programs could affect picture quality. If you still experience problems after checking your connections, please try connecting your DVD player directly to your TV's S-input, if your TV is equipped with this input. (page 10)
- You have selected "PROGRESSIVE" in "COMPONENT OUT" even though your TV cannot accept the signal in progressive format. In this case, set the SCAN SELECT switch on the back panel of the player to "INTERLACE." Then set "COMPONENT OUT" to "INTERLACE" after you can see the TV screen correctly, and set SCAN SELECT to "SELECTABLE."
- Even if your TV is compatible with progressive format (480p) signals, the image may be affected when you set "COMPONENT OUT" to "PROGRESSIVE." In this case, set "COMPONENT OUT" to "INTERLACE."

**Even though you set the aspect ratio in "TV TYPE" in "SCREEN SETUP" of the setup display, the picture does not fill the screen.**

- The aspect ratio is fixed on your DVD.

### Sound

**There is no sound.**

- Check that the player is connected securely.
- The audio connecting cord is damaged. Replace it with a new one.
- Make sure you connect the player to the audio input connectors on the receiver (amplifier). (page 12)
- Make sure you turn on the TV and the receiver (amplifier).
- Make sure you select the appropriate input on the receiver (amplifier) so that you can listen to the sound from the player.
- The player is in pause mode or in Slow-motion Play mode. Press [>] to return to normal play mode.
- The player is in fast forward or fast reverse mode. Press [<] to return to normal play mode.
- Check the speaker connections and setting (page 15). Refer to the operating manual of your receiver (amplifier).
- If you use the DIGITAL OUT connectors, set "DIGITAL OUT" to "ON" in the setup display. Otherwise no sound will come from the DIGITAL OUT connectors. (page 60)
- SACD audio signals are not output from the DIGITAL OUT OPTICAL or COAXIAL connectors.

**Sound is noisy.**

- Clean the disc.
- When you play a CD with DTS sound tracks, noise will come from any connector other than the DIGITAL OUT OPTICAL or COAXIAL connector. (page 19)

**Sound distortion occurs.**

- In the setup display, set "AUDIO ATT" in "AUDIO SETUP" to "ON." (page 60)

**The sound loses its stereo effect when you play a VIDEO CD or a CD.**

- Set "AUDIO" to "STEREO" in the Control Menu display. (page 35)
- Make sure you connect the player correctly. (pages 10, 12, 14)

### Operation

**The remote does not function.**

- Remove any obstacles between the remote and the player.
- Use the remote near the player.
- Point the remote at the remote sensor [ ] on the player.
- Replace all of the batteries in the remote with new ones if they are weak.

**The disc does not play.**

- There is no disc inside ("Insert disc." appears on the TV screen).
- Insert a disc.
- Insert the disc correctly with the playback side facing down on the disc tray.
- Clean the disc.
- The player cannot play CD-ROMs, etc. (page 5)
- Insert a DVD, a VIDEO CD, or CD.
- Check the region code of the DVD. (page 5)
- Moisture has condensed inside the player. Remove the disc and leave the player turned on for about half an hour. (page 8)

**The player does not play from the beginning when playing a disc.**

- Program Play, Shuffle Play, Repeat Play or A-B Repeat Play has been selected. Press CLEAR. (pages 45 through 49)
- Resume Play has been selected. Press [ ] on the front panel or on the remote before you start playing. (page 23)
- A title menu or a DVD menu automatically appears on the TV screen when you play your DVD, or a setup display automatically appears on the TV screen when you play your VIDEO CD with PBC functions.

**The player starts playing the disc automatically.**

- The DVD features the auto playback function.
- "AUTO PLAY" in "CUSTOM SETUP" is set to "TIMER." (page 56)

**Playback stops automatically.**

- The disc may contain an auto pause signal. While playing such a disc, the player stops playback at the signal.

### Troubleshooting

**You cannot perform some functions such as Stop, Search, Slow-motion Play, Repeat Play, Shuffle Play or Program Play.**

- Depending on the disc, you may not be able to do some of the operations above.

**Messages do not appear on the TV screen in the language you want.**

- In the setup display, select the desired language for the on-screen display in "OSD" under "LANGUAGE SETUP." (page 53)

**The language for the sound track cannot be changed when you play a DVD.**

- Multilingual tracks are not recorded on the DVD.
- Changing the language for the track is prohibited on the DVD.

**The subtitle language cannot be changed when you play a DVD.**

- Multilingual subtitles are not recorded on the DVD.
- Changing the language for the subtitles is prohibited on the DVD.

**The subtitles cannot be turned off when you play a DVD.**

- Depending on the DVD, you may not be able to turn the subtitles off.

**The angles cannot be changed when you play a DVD.**

- Multi-angles are not recorded on the DVD.
- Change the angles when "ANGLE" appears on the front panel display. (page 37)
- Changing the angles is prohibited on the DVD.

**The player does not operate properly.**

- Static electricity, etc., may affect the player's operation. Press POWER on the player to turn the player off and then on again.

## Self-diagnosis function

When the self-diagnosis function activates to prevent the player from malfunctioning, a five-character service number (combination of a letter and digits) flashes on the screen and on the front panel display. In this case, check the following table.



First three characters	Cause and/or Corrective Action
C13	<ul style="list-style-type: none"> <li>The disc is dirty.                             <ul style="list-style-type: none"> <li>Clean the disc with a cleaning cloth. (page 8)</li> </ul> </li> </ul>
C31	<ul style="list-style-type: none"> <li>The disc is not inserted correctly.                             <ul style="list-style-type: none"> <li>Open the disc tray and insert the disc correctly.</li> </ul> </li> </ul>
Exx (xx is any number)	<ul style="list-style-type: none"> <li>To prevent a malfunction, the player has performed the self-diagnosis function.                             <ul style="list-style-type: none"> <li>When you contact your Sony dealer or local authorized Sony service facility, give the 5-character service number. (example: E61:10)</li> </ul> </li> </ul>

## Language Code List

For details, see pages 53.

The language spellings conform to the ISO 639: 1988 (E/F) standard.

Code	Language	Code	Language	Code	Language	Code	Language
1027	Afar	1186	Scots Gaelic	1350	Malayalam	1513	Siswati
1028	Abkhazian	1194	Galician	1352	Mongolian	1514	Sesotho
1032	Afrikaans	1196	Guarani	1353	Moldavian	1515	Sundanese
1039	Amharic	1203	Gujarati	1356	Marathi	1516	Swedish
1044	Arabic	1209	Hausa	1357	Malay	1517	Swahili
1045	Assamese	1217	Hindi	1358	Maltese	1521	Tamil
1051	Aymara	1226	Croatian	1363	Burmese	1525	Telugu
1052	Azerbaijani	1229	Hungarian	1365	Nauru	1527	Tajik
1053	Bashkir	1233	Armenian	1369	Nepali	1528	Thai
1057	Byelorussian	1235	Interlingua	1376	Dutch	1529	Tigrinya
1059	Bulgarian	1239	Interlingue	1379	Norwegian	1531	Turkmen
1060	Bihari	1245	Inupiak	1393	Occitan	1532	Tagalog
1061	Bislama	1248	Indonesian	1403	(Afan) Oromo	1534	Setswana
1066	Bengali; Bangla	1253	Icelandic	1408	Oriya	1535	Tonga
1067	Tibetan	1254	Italian	1417	Punjabi	1538	Turkish
1070	Breton	1257	Hebrew	1428	Polish	1539	Tsonga
1079	Catalan	1261	Japanese	1435	Pashto; Pushto	1540	Tatar
1093	Corsican	1269	Yiddish	1436	Portuguese	1543	Twi
1097	Czech	1283	Javanese	1463	Quechua	1557	Ukrainian
1103	Welsh	1287	Georgian	1481	Rhaeto-Romanche	1564	Urdu
1105	Danish	1297	Kazakh	1482	Kirundi	1572	Uzbek
1109	German	1298	Greenlandic	1483	Romanian	1581	Vietnamese
1130	Bhutani	1299	Cambodian	1489	Russian	1587	Volapük
1142	Greek	1300	Kannada	1491	Kinyarwanda	1613	Wolof
1144	English	1301	Korean	1495	Sanskrit	1632	Xhosa
1145	Esperanto	1305	Kashmiri	1498	Sindhi	1665	Yoruba
1149	Spanish	1307	Kurdish	1501	Sango	1684	Chinese
1150	Estonian	1311	Kirghiz	1502	Serbo-Croatian	1697	Zulu
1151	Basque	1313	Latin	1503	Singhalese	1703	Not specified
1157	Persian	1326	Lingala	1505	Slovak		
1165	Finnish	1327	Laotian	1506	Slovenian		
1166	Fiji	1332	Lithuanian	1507	Samoa		
1171	Faroese	1334	Latvian; Lettish	1508	Shona		
1174	French	1345	Malagasy	1509	Somali		
1181	Frisian	1347	Maori	1511	Albanian		
1183	Irish	1349	Macedonian	1512	Serbian		

## Index to Parts and Controls

Refer to the pages indicated in parentheses for details.

### Front Panel

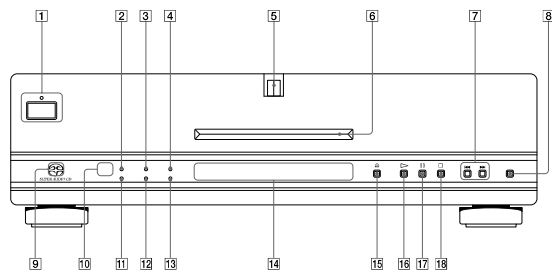

- 1 POWER button and indicator (18)**  
Disconnects the power of the player or places the player in standby mode.
- 2 VIDEO OFF indicator (20)**  
Lights up when:  
– video output is set to off by using VIDEO ON/OFF on the remote  
– you press AUDIO DIRECT on the player.
- 3 PROGRESSIVE indicator (56)**  
Lights up when the video signal is output in the progressive format from the COMPONENT VIDEO OUT connector.
- 4 SACD indicator (20)**  
Lights up when SACD audio signals are played.
- 5 Disc indicator (18)**  
Lights up while the disc is inserted.
- 6 Disc tray (18)**  
Place a disc on the tray.
- 7 PREV ◀◀/▶▶ NEXT (previous/next) buttons (21)**  
Press to go to the next chapter or track, or to go back to the previous chapter or track.
- 8 AUDIO DIRECT button and indicator (20)**  
Cuts off the video and audio digital signal output. The indicator lights up when the video and audio signals are cut.
- 9 SACD logo indicator (22)**  
Lights up when no disc is in the player, or when a SACD disc is inserted and SACD audio signals are played.
- 10 (remote sensor) (9)**  
Accepts the remote control signals.
- 11 DIGITAL OFF Indicator (20)**  
Lights up when:  
– “DIGITAL OUT” is set to “OFF” in “AUDIO SETUP”  
– you press AUDIO DIRECT on the player and cut the digital output.
- 12 FILM indicator (63)**  
Lights up when the film based DVD software is played during normal play mode.
- 13 FL OFF indicator (56)**  
Lights up when:  
– “DIMMER” in “CUSTOM SETUP” is set to “OFF.”  
– you press FL ON/OFF on the remote to turn off the front panel display.
- 14 Front Panel Display (26)**  
Indicates the playing time, etc.  
For details, see page 00.
- 15 OPEN/CLOSE button (18)**  
Opens or closes the disc tray.
- ▶▶ (play) button and indicator (18)**  
Plays a disc. The indicator lights up when a disc is playing.
- ⏸ (pause) button and indicator (21)**  
Pauses playing a disc. The indicator lights up when a disc is paused.
- ⏹ (stop) button (21)**  
Stops playing a disc.

### Rear Panel

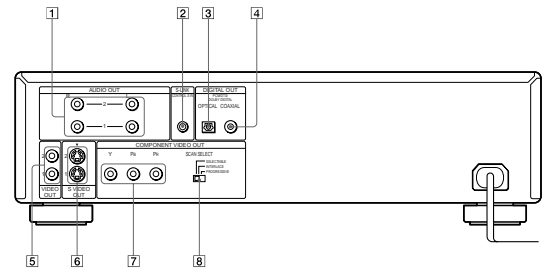

- 1 AUDIO OUT R (right)/L (left) 1/2 connectors (10, 12)**  
Connect to the audio input connector on your TV or receiver (amplifier).
- 2 S-LINK/CONTROL S IN connector (10)**  
Connect to the S-link (Control S) connector on an external component.
- 3 DIGITAL OUT OPTICAL connector (12, 15)**  
Connect to an audio component using an optical digital connecting cord. Take off the cap.
- 4 DIGITAL OUT COAXIAL connector (12, 15)**  
Connect to an audio component using a coaxial digital connecting cord.
- 5 VIDEO OUT 1/2 connectors (10)**  
Connect to the video input connector on your TV or monitor.
- 6 S VIDEO OUT 1/2 connectors (10, 12, 15)**  
Connect to the S video input connector on your TV or monitor.
- 7 COMPONENT VIDEO OUT (Y, Pb, Pb) connectors (11)**  
Connects to a monitor or projector having component video input connectors (Y, Pb, Pb) that conform to output signals from the player.
- 8 SCAN SELECT switch (62)**  
Select the component video signal format.  
• SELECTABLE: changes the format according to the setting made in “COMPONENT OUT” of the “CUSTOM SETUP” display.  
• INTERLACE: fixes the format to interlace format.  
• PROGRESSIVE: fixes the format to progressive format (480p).

## Remote

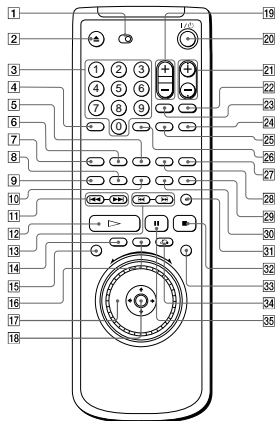

- 1 TV/DVD switch (64)**  
Selects to control the player and receiver or the TV with the remote.
- 2 ▲OPEN/CLOSE button (21)**  
Opens or closes the disc tray.
- 3 Number buttons**  
Selects and executes the items or settings.
- 4 CLEAR button (45 through 49)**  
Press to return to continuous play, etc.
- 5 REPEAT button (48)**  
Each time you press this button, the "REPEAT" setting changes.
- 6 PROGRAM button (45)**  
Press for "PROGRAM" playback.
- 7 SHUFFLE button (47)**  
Each time you press this button, the "SHUFFLE" setting changes.
- 8 ANGLE button (38)**  
Changes the angles when playing a DVD.
- 9 AUDIO button (35)**  
Changes the sound while playing a DVD, CD or VIDEO CD.
- 10 SUBTITLE button (37)**  
Changes the subtitles when playing a DVD.
- 11 ◀/▶/⏪/⏩/NEXT (previous/next) buttons (21)**  
Press to go to the next chapter or track, or to go back to the previous chapter or track.
- 12 ▷/PLAY button (18)**  
Plays a disc.
- 13 ⏹/SEARCH buttons (21)**  
While monitoring the picture, keep pressing to locate a point quickly.
- 14 TITLE button (24)**  
Displays the title menu on the TV screen.
- 15 DISPLAY button (28)**  
Displays the Control Menu display on the TV screen to set or adjust the items.
- 16 DVD MENU button (24)**  
Displays the DVD menu on the TV screen.
- 17 Click shuttle (21)**  
Changes the playback speed.
- 18 ◀/▶/⏪/⏩/ENTER buttons**  
Selects and executes the items or settings.
- 19 VOL button (65)**  
Changes the volume of the TV when the TV/DVD switch is set to TV, or the volume of the receiver (amplifier) when the switch is set to DVD.
- 20 I/O (on/standby) button (18)**  
Press to turn on the player or place it in standby mode after power is connected by pressing POWER on the player. When the TV/DVD switch is set to TV, this button turns your TV on or off.
- 21 CH button (65)**  
Changes the channel of the TV.
- 22 TV/VIDEO button (65)**  
Changes the video input of the TV.
- 23 WIDE MODE button (65)**  
Changes the wide mode of the Sony TV.
- 24 VIDEO ON/OFF button (20)**  
Turns on/off the video output.
- 25 FL ON/OFF button (56)**  
Turns on/off the front panel display.
- 26 ENTER button**  
Executes the items or settings.
- 27 PICTURE MEMORY button (55)**  
Press to store a picture in memory.
- 28 A→B button (49)**  
Press to play the desired section of the software (A-B repeat playback).
- 29 SACD/CD button (20)**  
Changes the playback layer between the HD (High density) layer and CD layer when you insert a hybrid SACD into the player.
- 30 TIME/TEXT button (32)**  
Displays the playing time of the disc, etc., on the front panel display and the screen.
- 31 LIGHT button (21)**  
Press to light up ▷/PLAY, ■PAUSE, ■STOP and DISPLAY buttons on the remote.
- 32 ■STOP button (21)**  
Stops playing a disc.
- 33 JOG button / indicator (21)**  
Press to play a disc frame by frame using the click shuttle.
- 34 ◂RETURN button (25, 29)**  
Press to return to the previously selected screen, etc.
- 35 ■PAUSE button (21)**  
Pauses playing a disc.

## SECTION 2 DISASSEMBLY

**Note:** Follow the disassembly procedure in the numerical order given.

### 2-1. TOP CASE REMOVAL

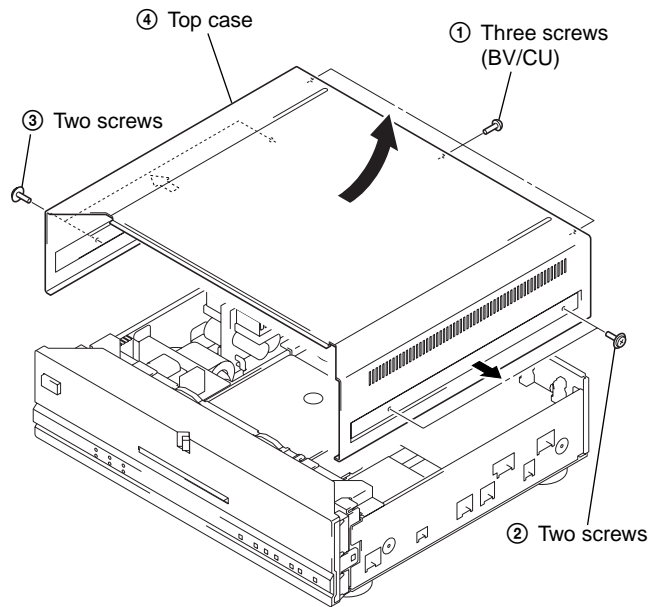

### 2-3. FL-114 BOARD REMOVAL

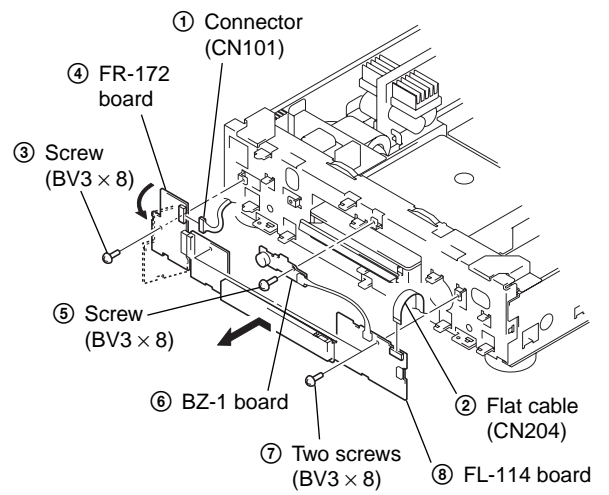

### 2-2. FRONT PANEL REMOVAL

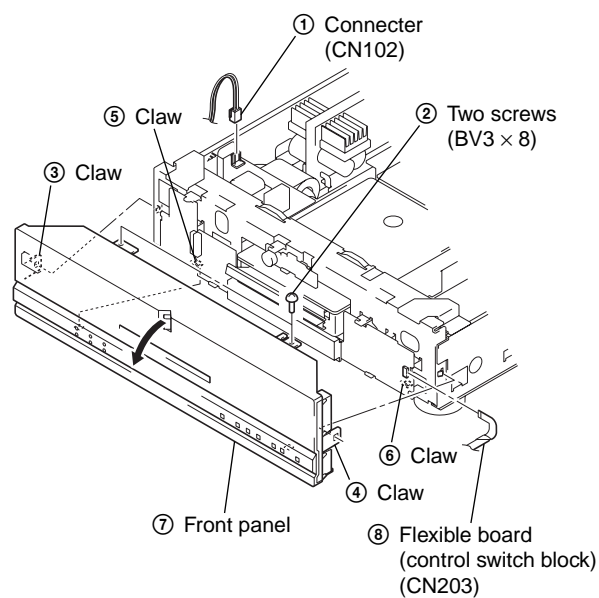

### 2-4. MB-91 BOARD REMOVAL

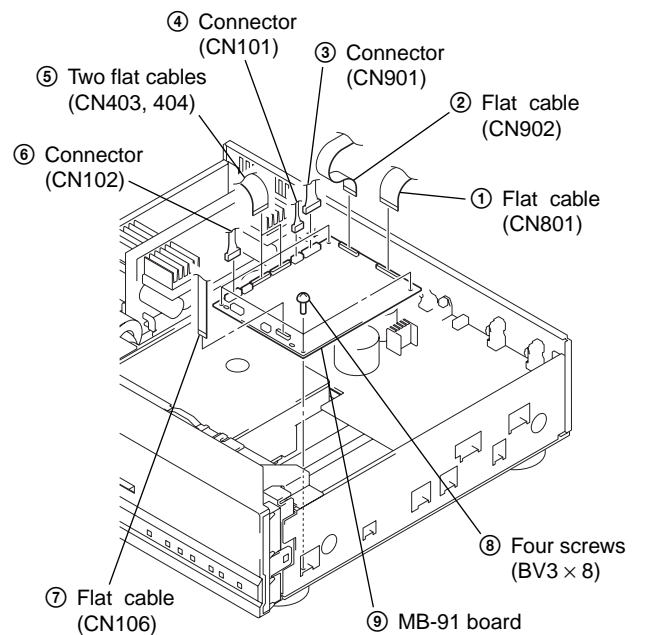



## 2-5. PS-436/437/438/439 BOARD REMOVAL

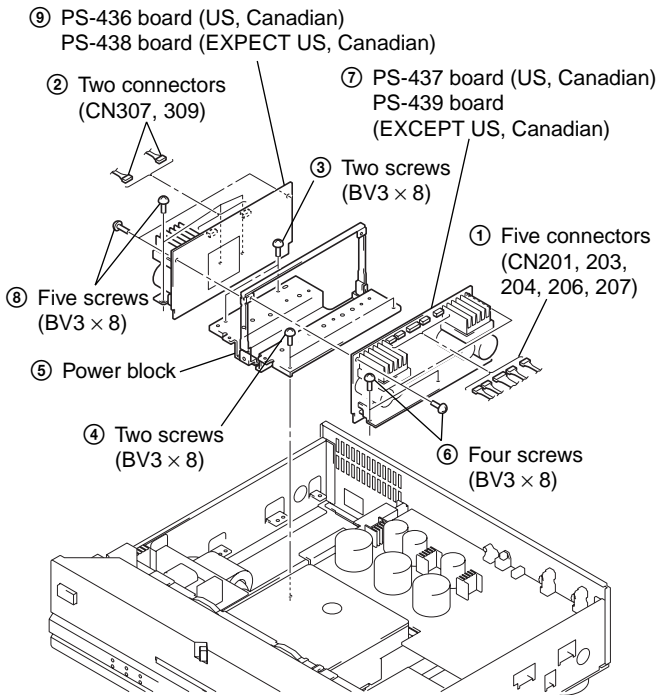

## 2-7. MECHANISM DECK REMOVAL

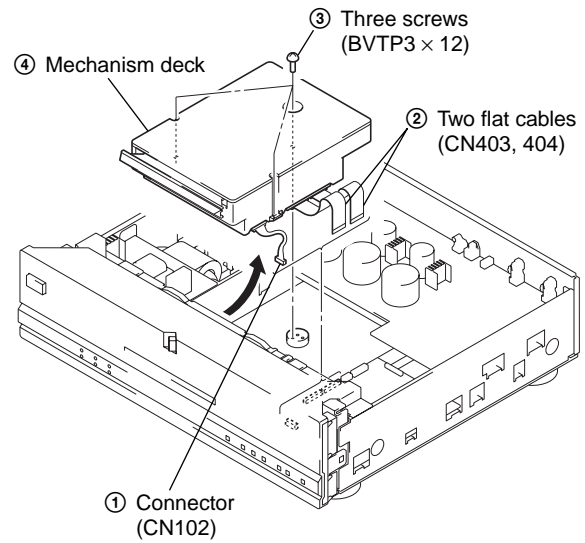

## 2-6. AU-226 BOARD REMOVAL

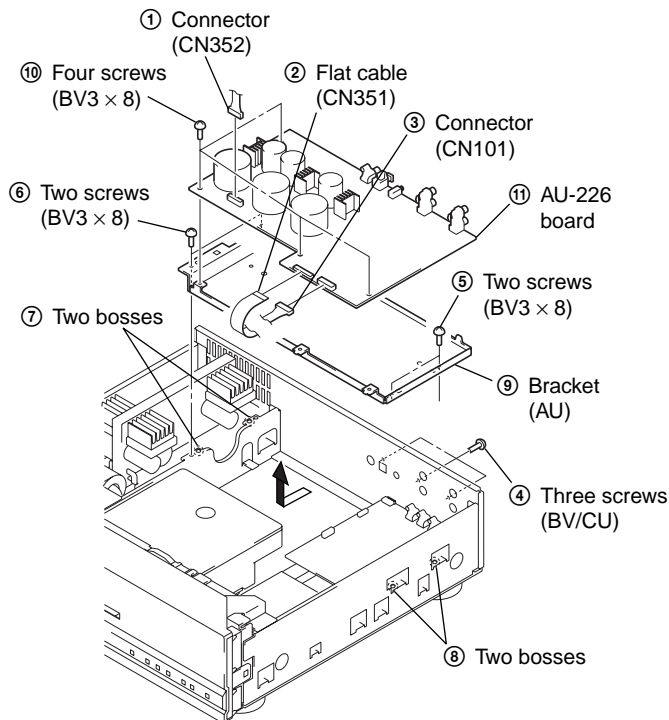

## 2-8. TK-58 BOARD REMOVAL

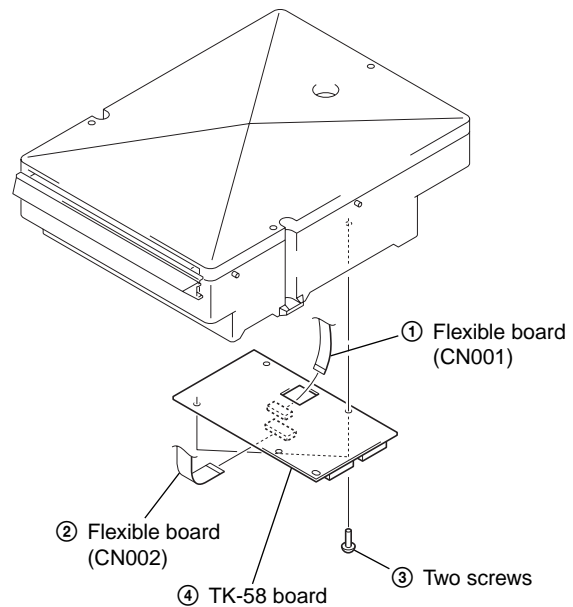

## 2-9. LOADING ASSEMBLY REMOVAL

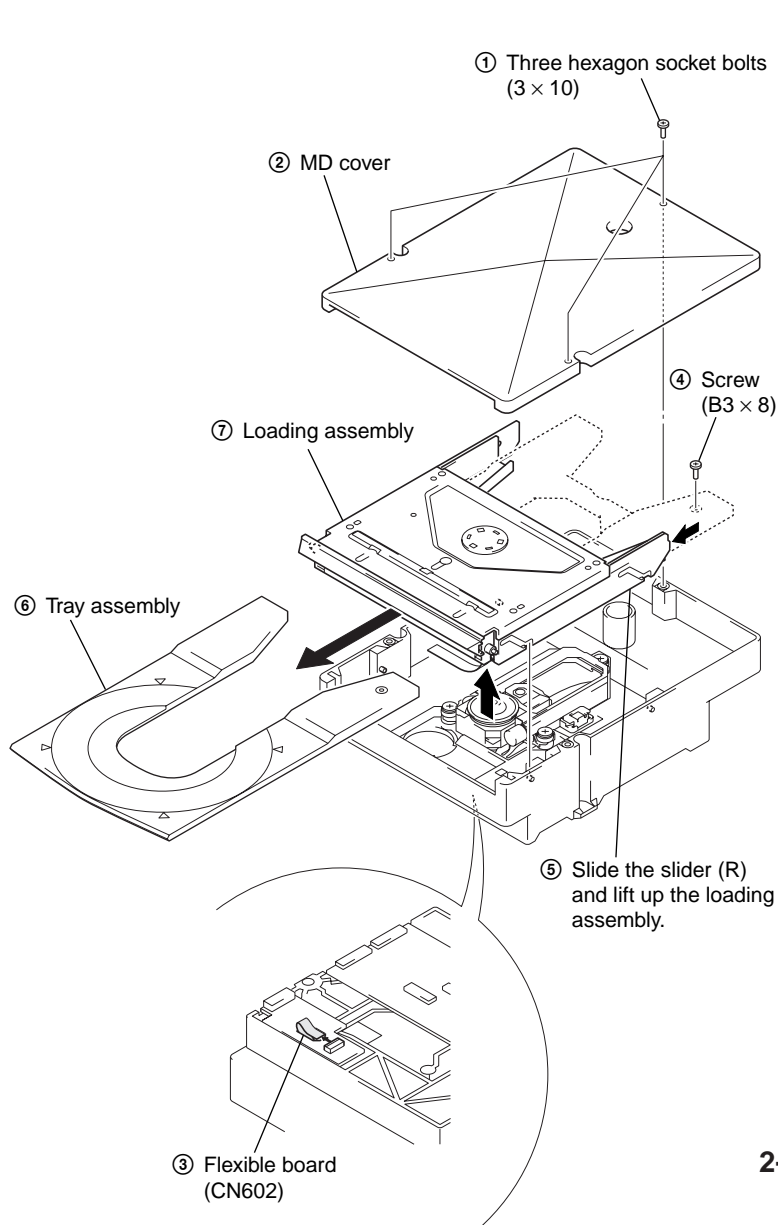

## 2-10. OPTICAL PICK-UP REMOVAL

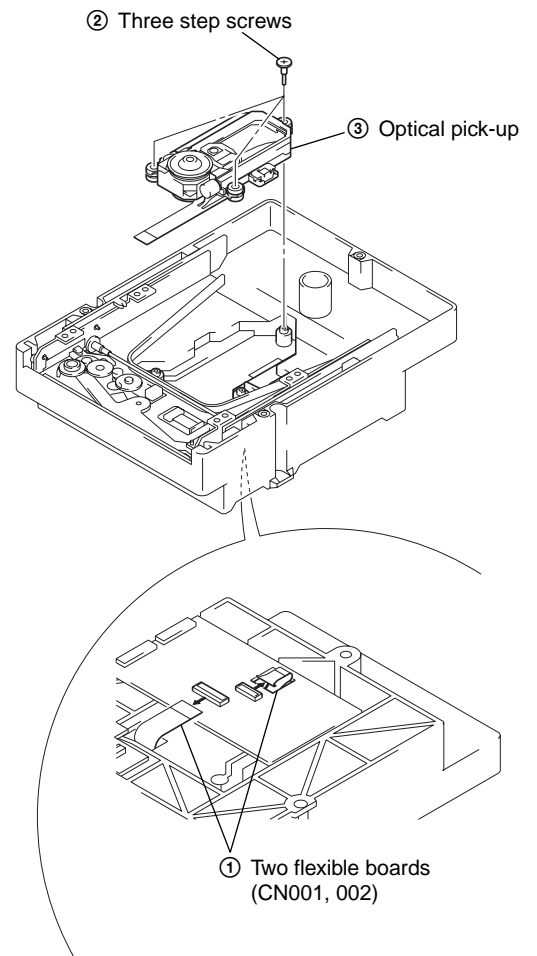

## 2-11. BASE ASSEMBY REMOVAL

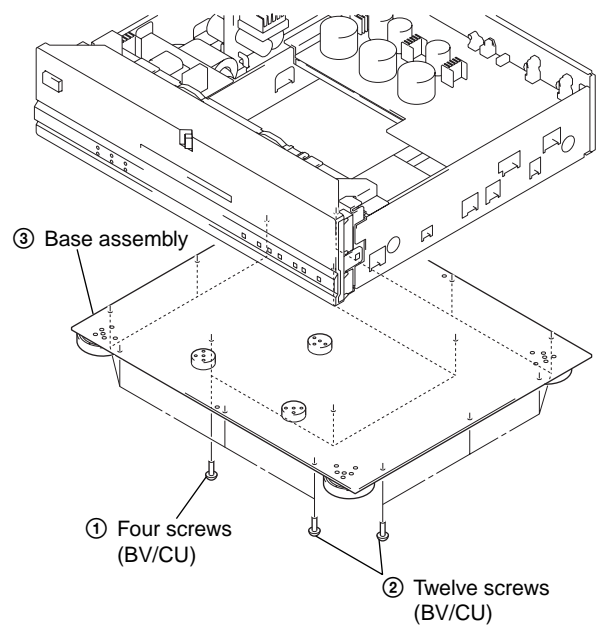

2-12. INTERNAL VIEW

DC motor (loading)  
1-763-397-21

KHM-220AAA  
service assembly  
A-6062-397-A

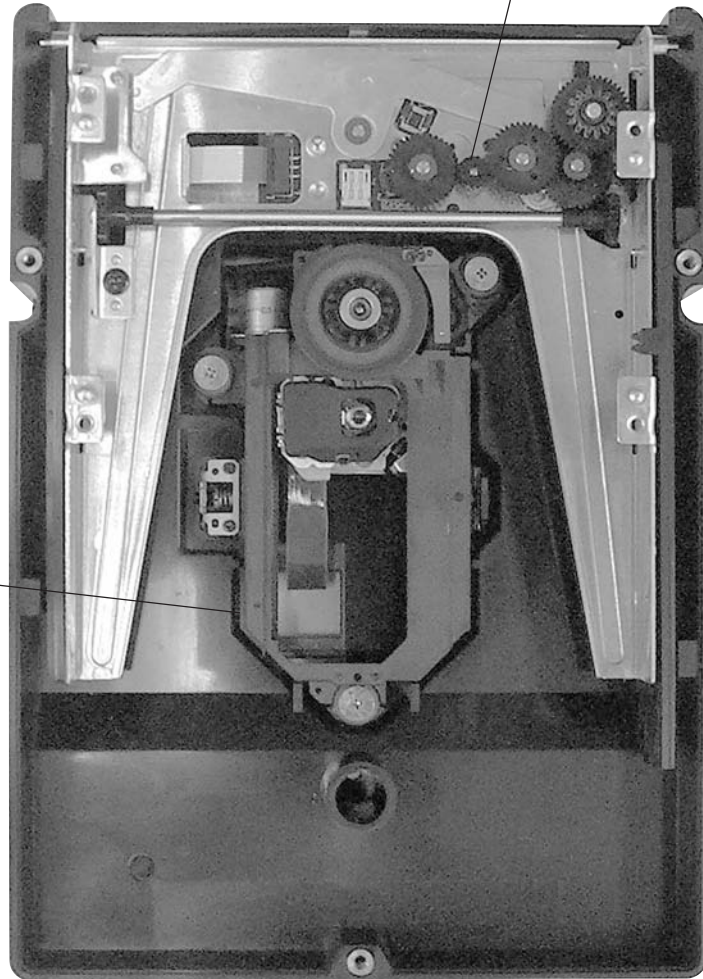

## 2-13. CIRCUIT BOARDS LOCATION

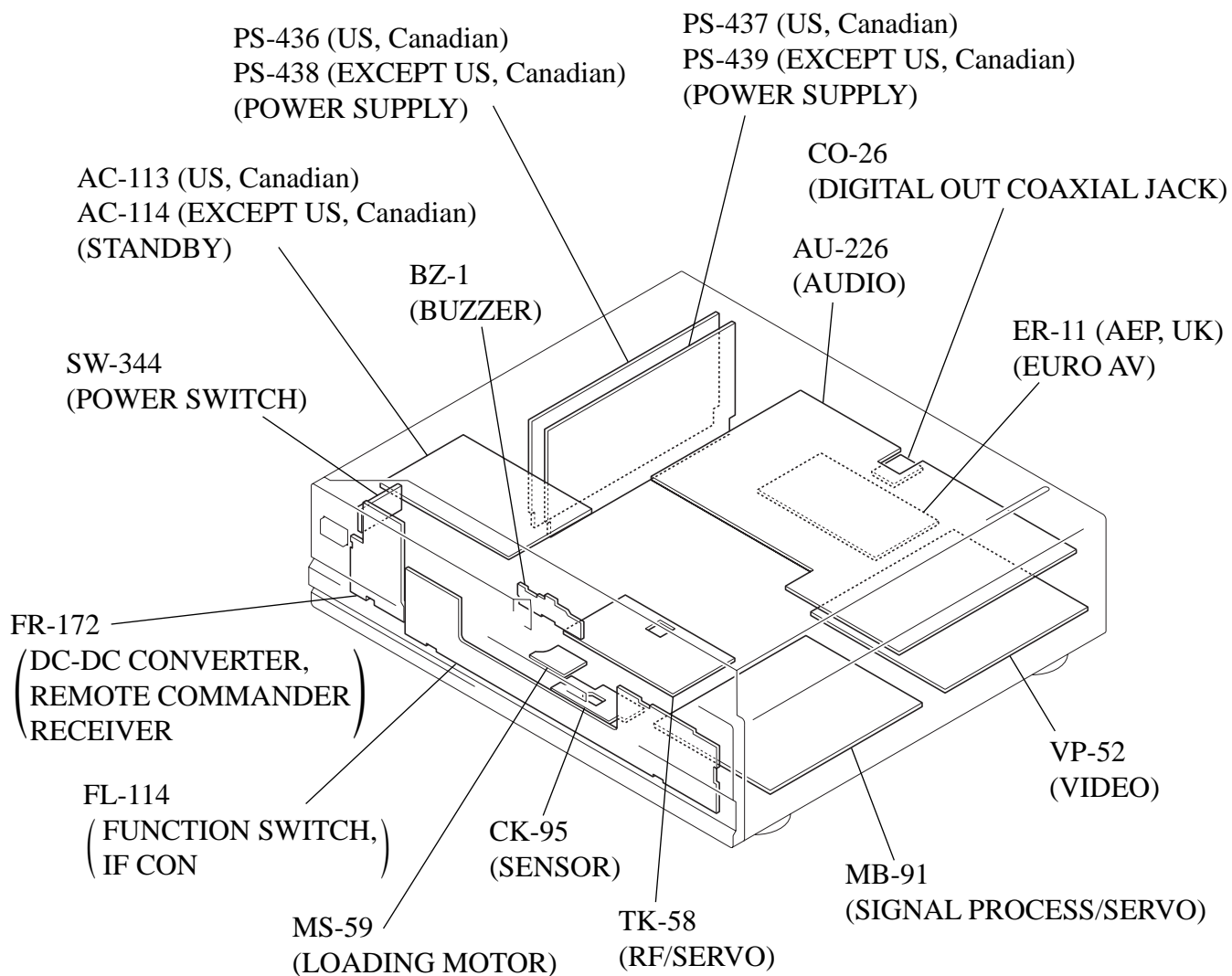

### SECTION 3 BLOCK DIAGRAMS

#### 3-1. OVERALL BLOCK DIAGRAM

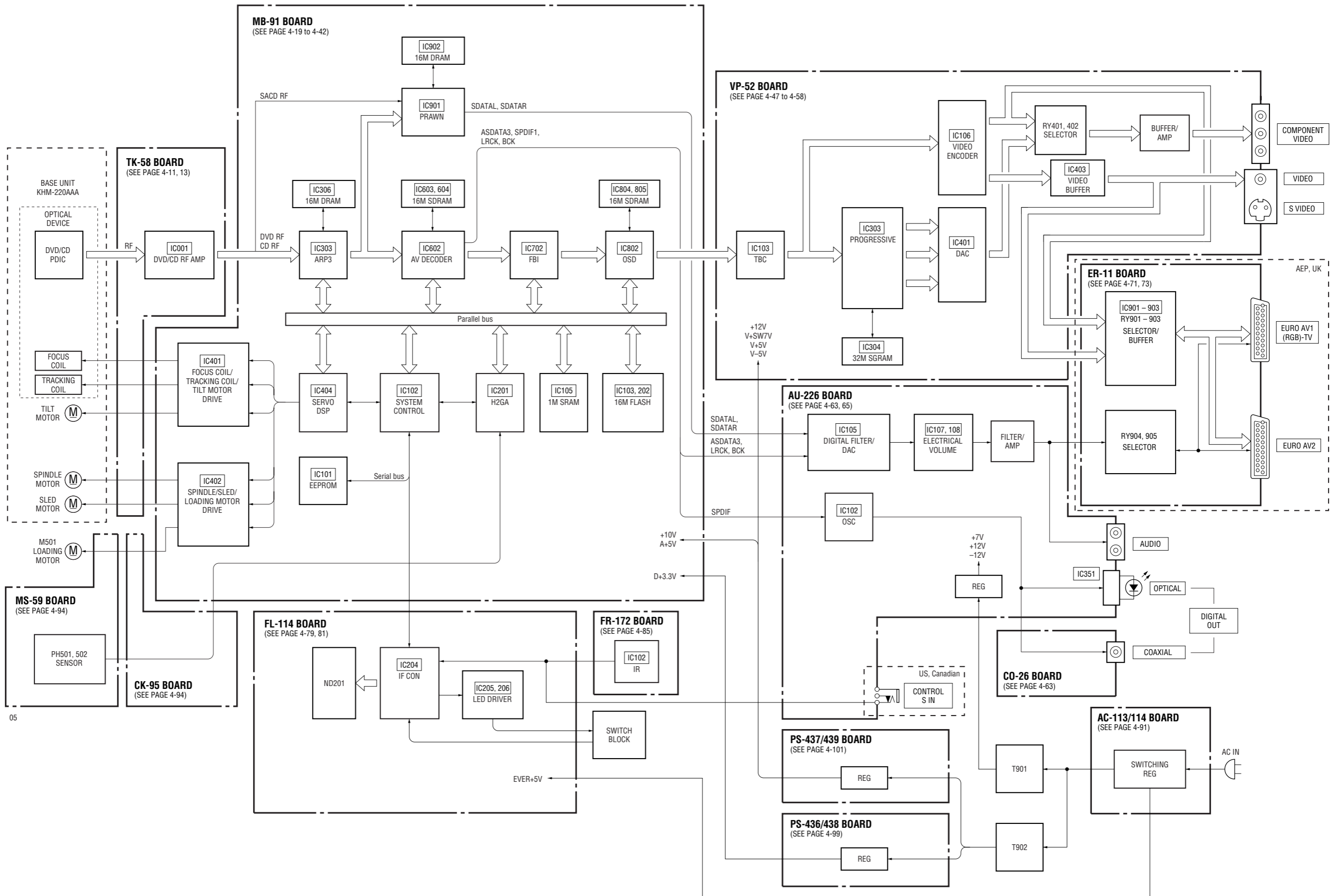

05

DVP-S9000ES 3-2. RF/SERVO BLOCK DIAGRAM

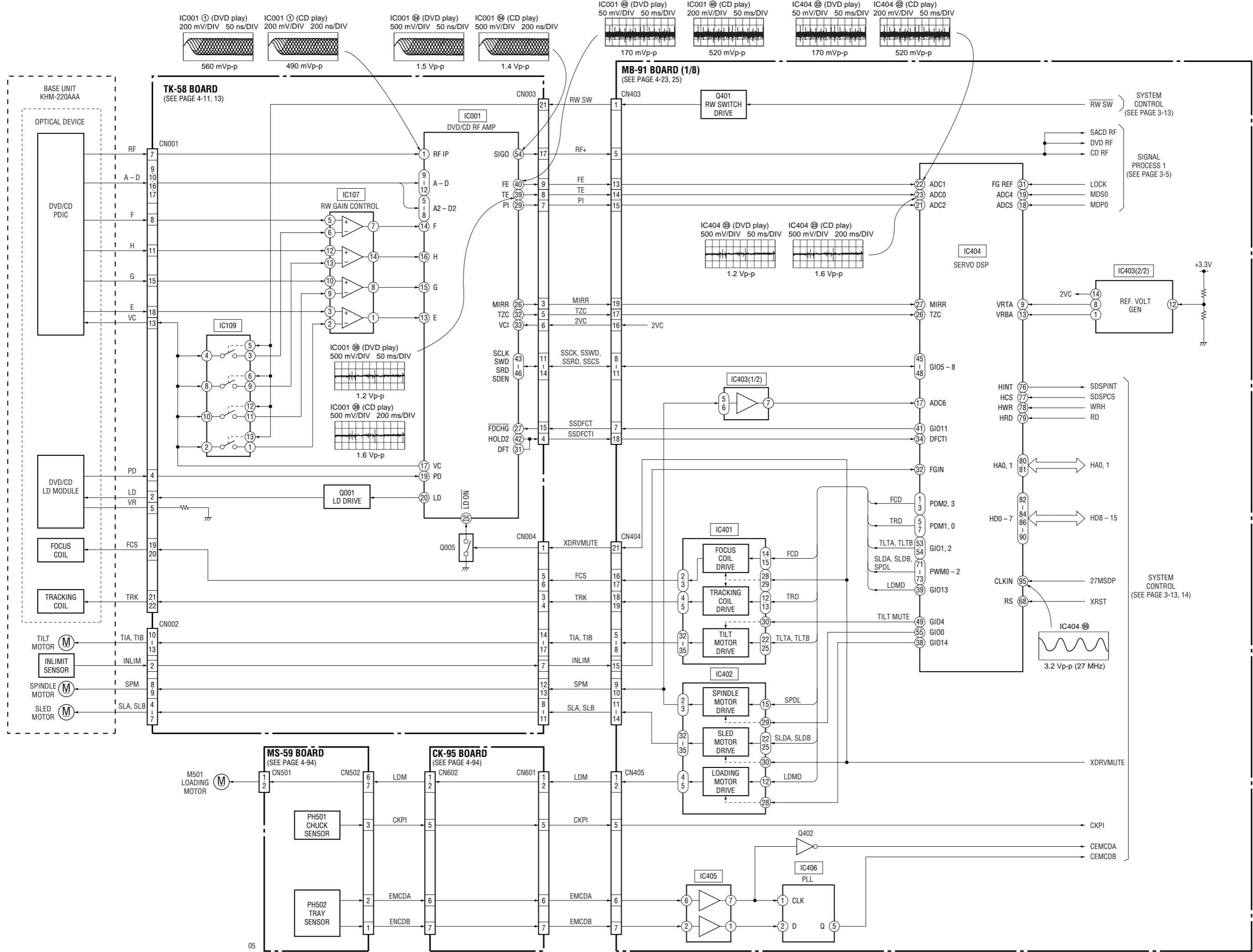

3-3. SIGNAL PROCESS 1 BLOCK DIAGRAM

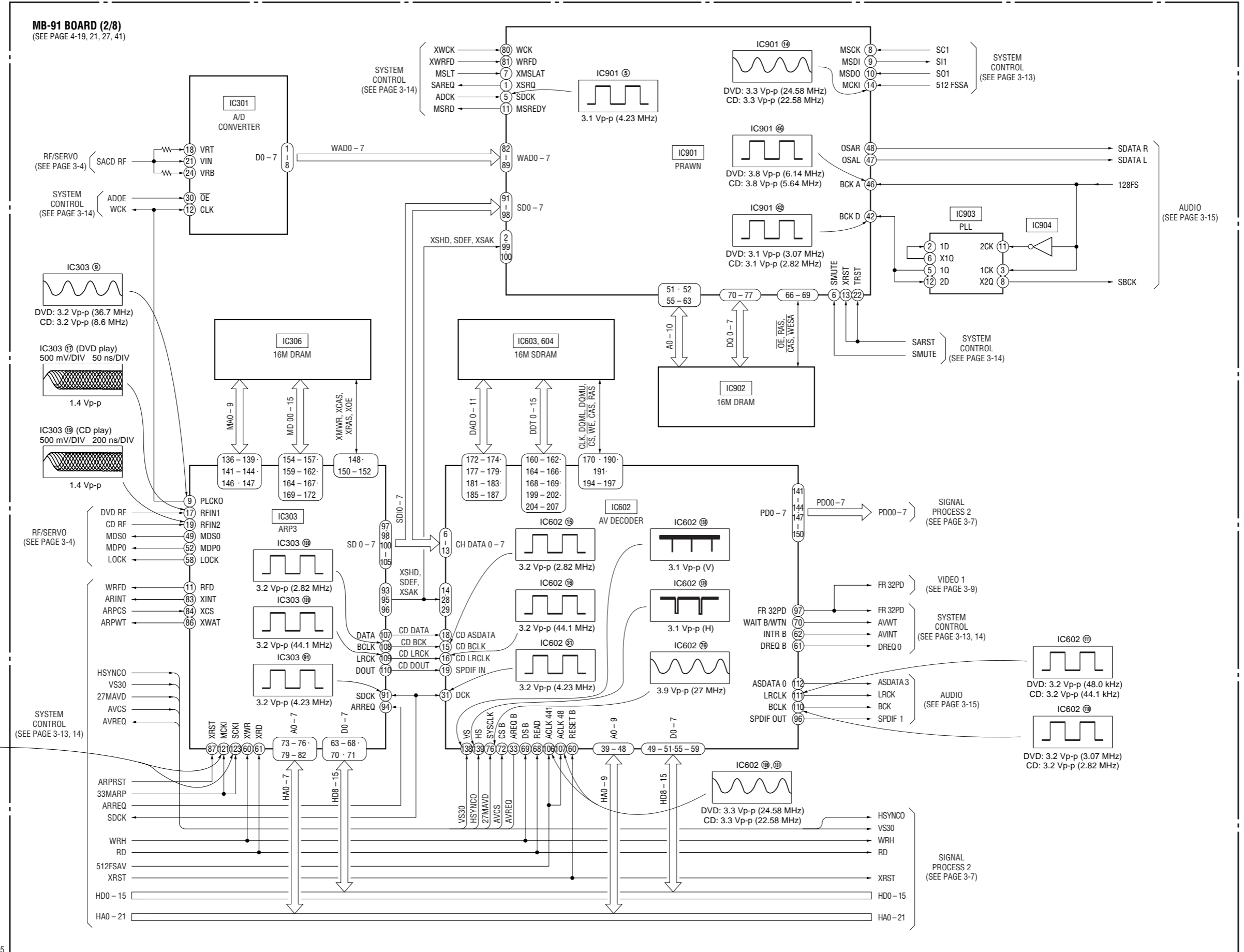

05

3-4. SIGNAL PROCESS 2 BLOCK DIAGRAM

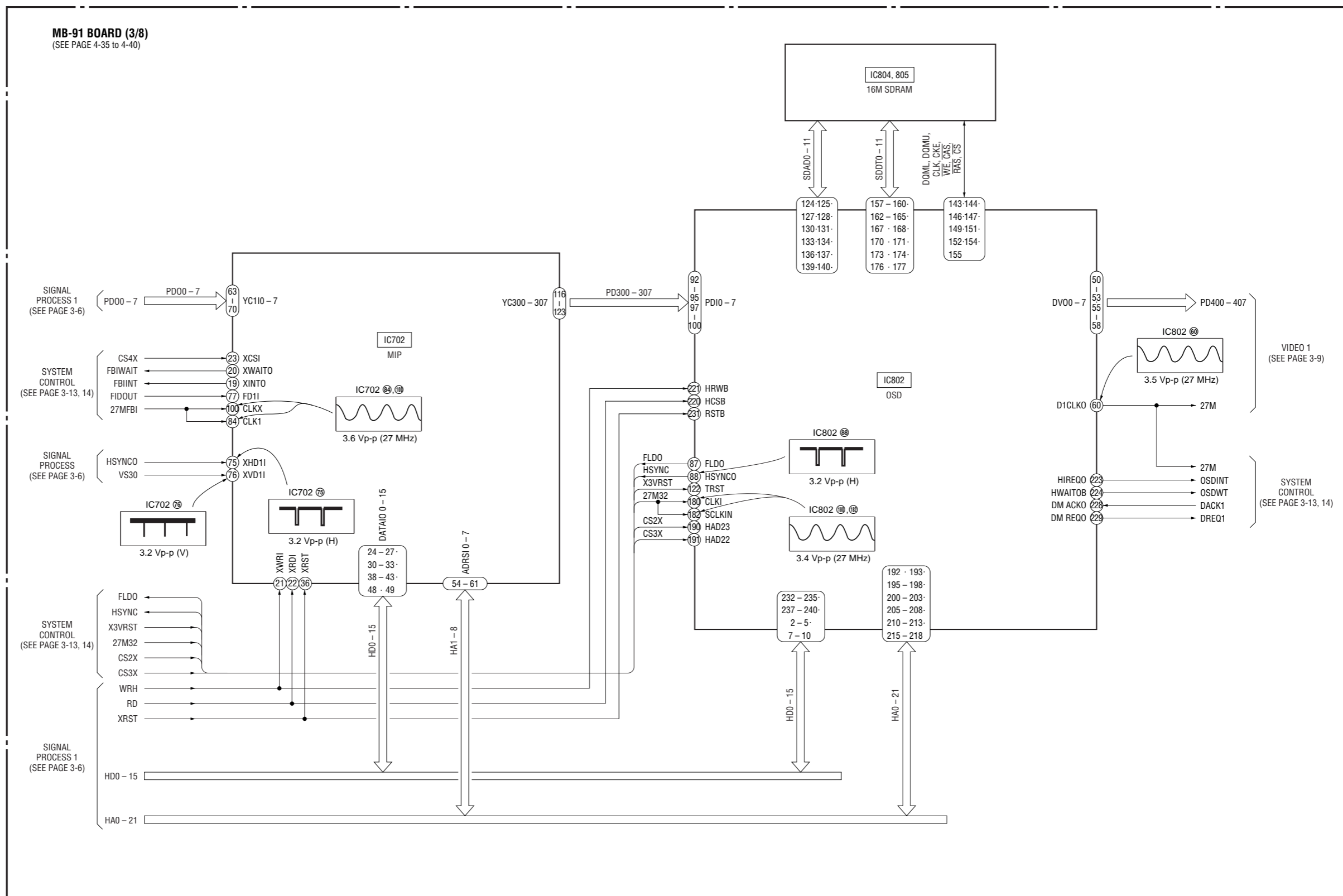

05



3-5. VIDEO 1 BLOCK DIAGRAM

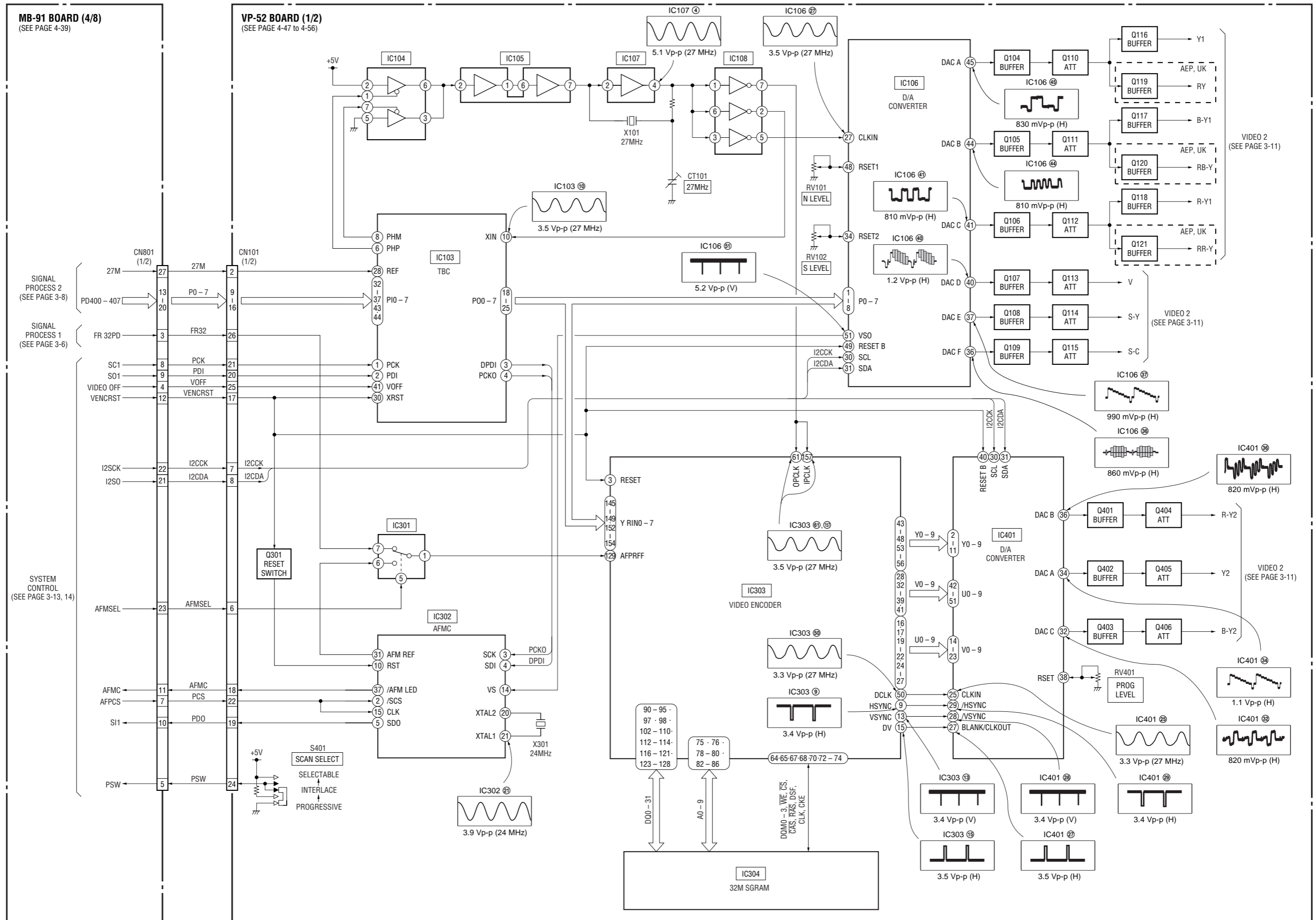

3-6. VIDEO 2 BLOCK DIAGRAM

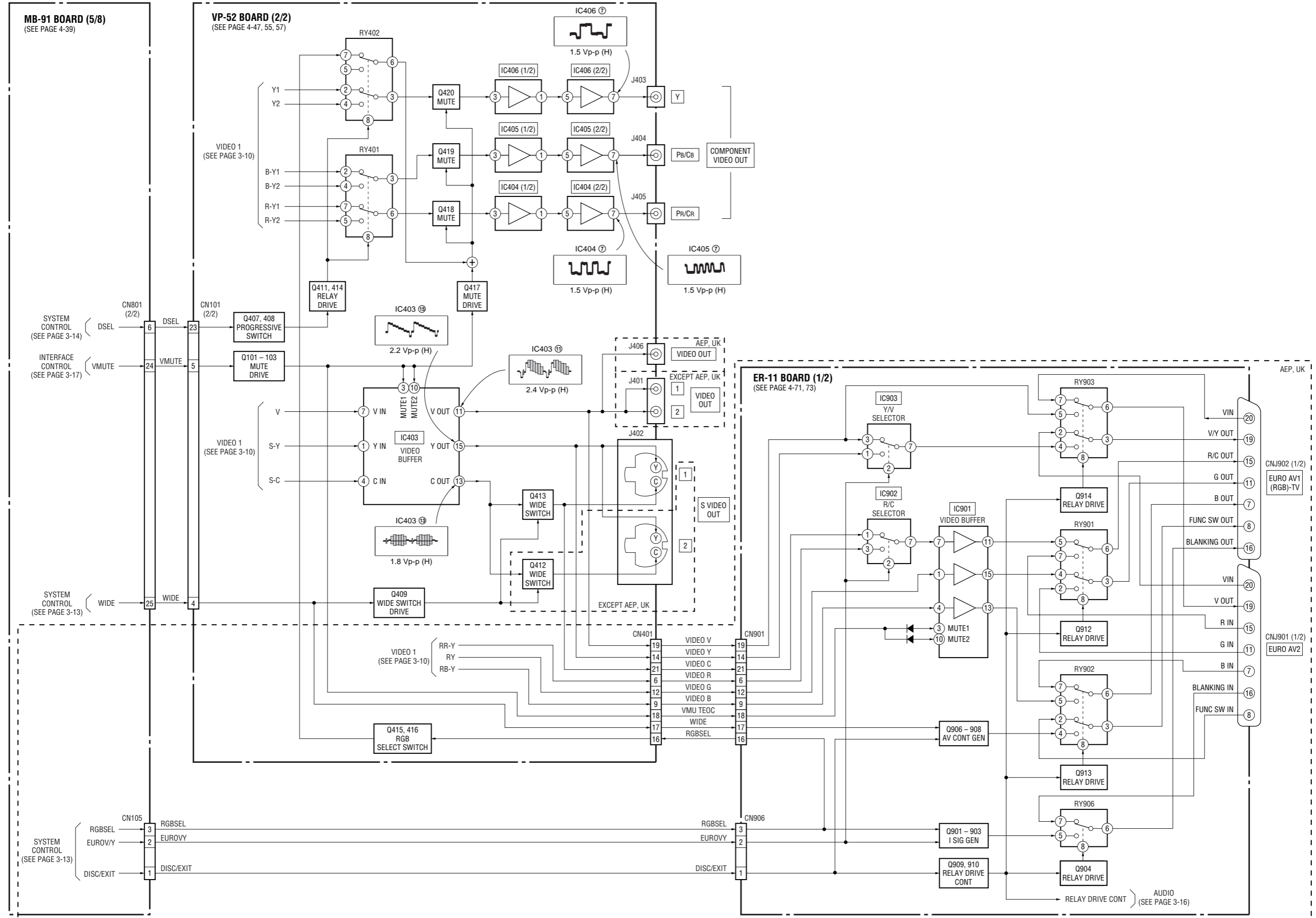

3-7. SYSTEM CONTROL BLOCK DIAGRAM

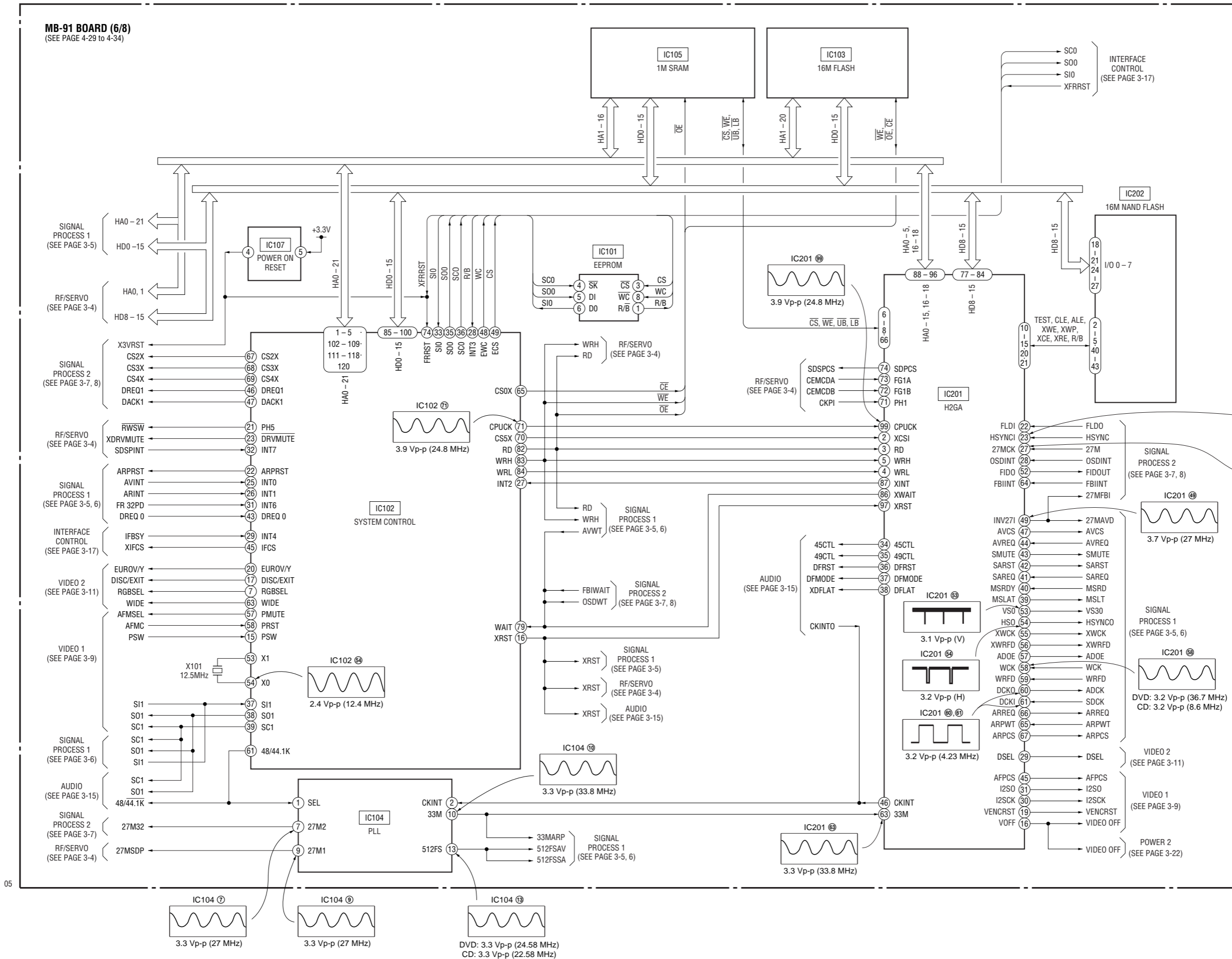

3-8. AUDIO BLOCK DIAGRAM

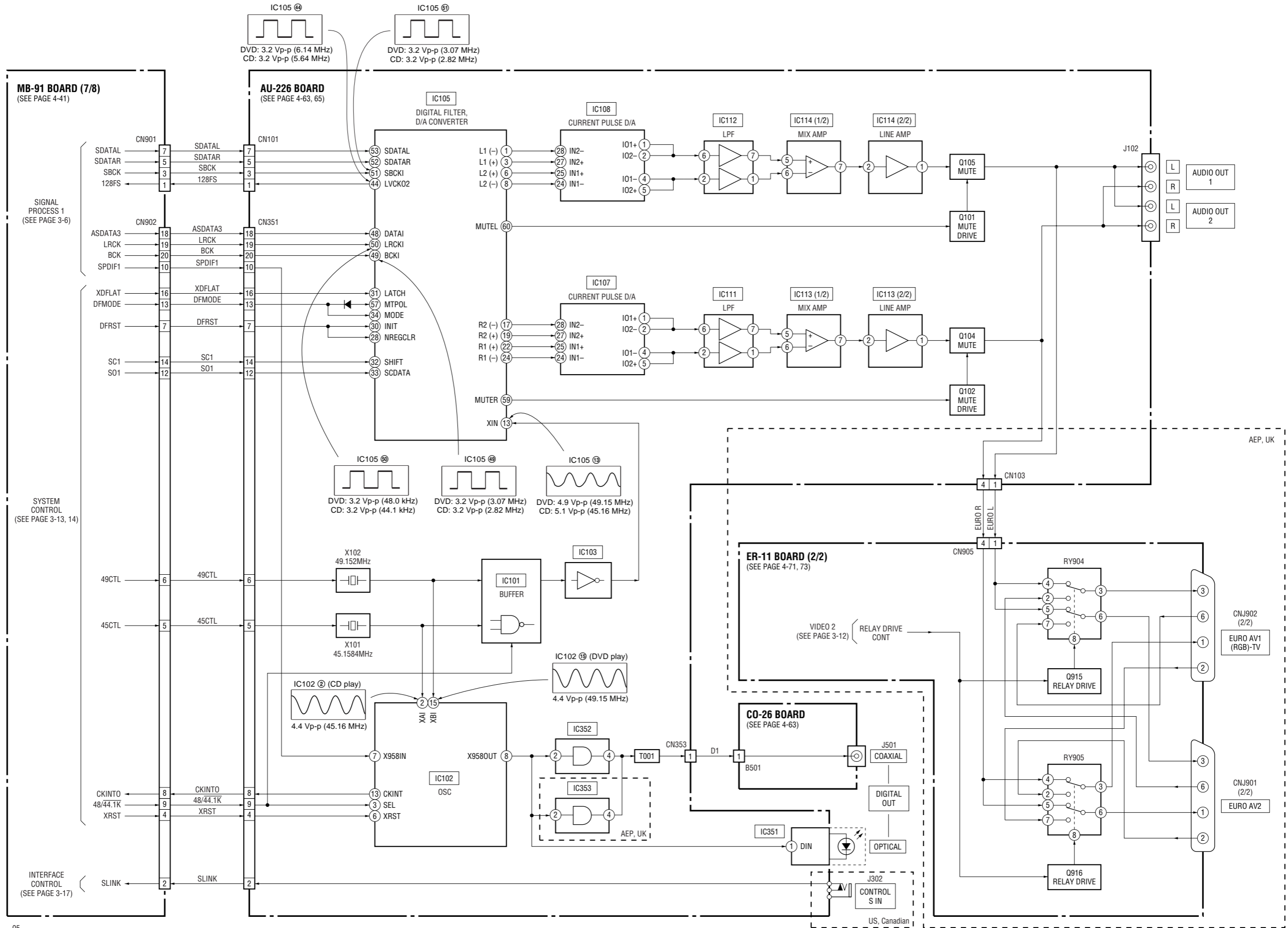

3-9. INTERFACE CONTROL BLOCK DIAGRAM

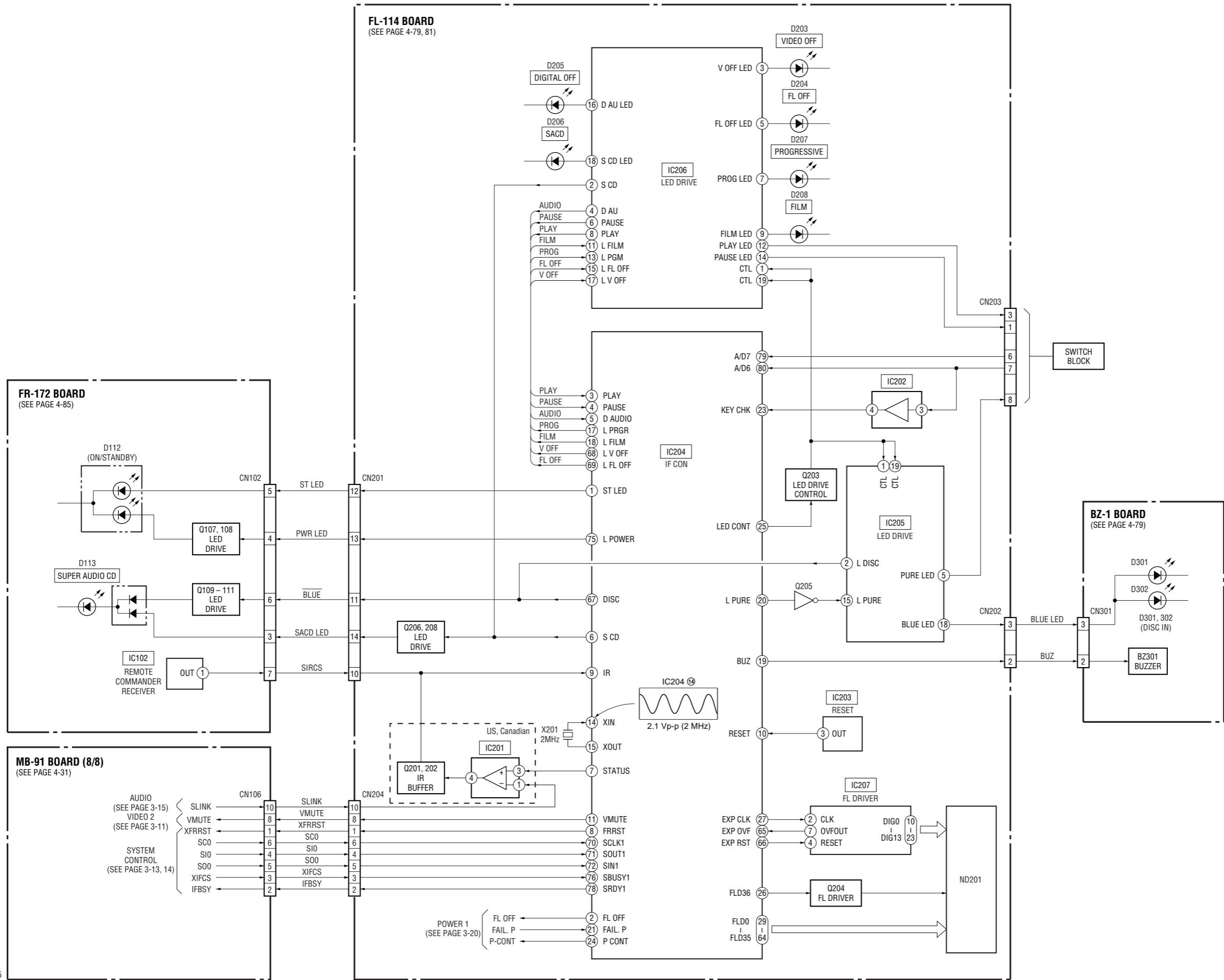

3-10. POWER 1 BLOCK DIAGRAM

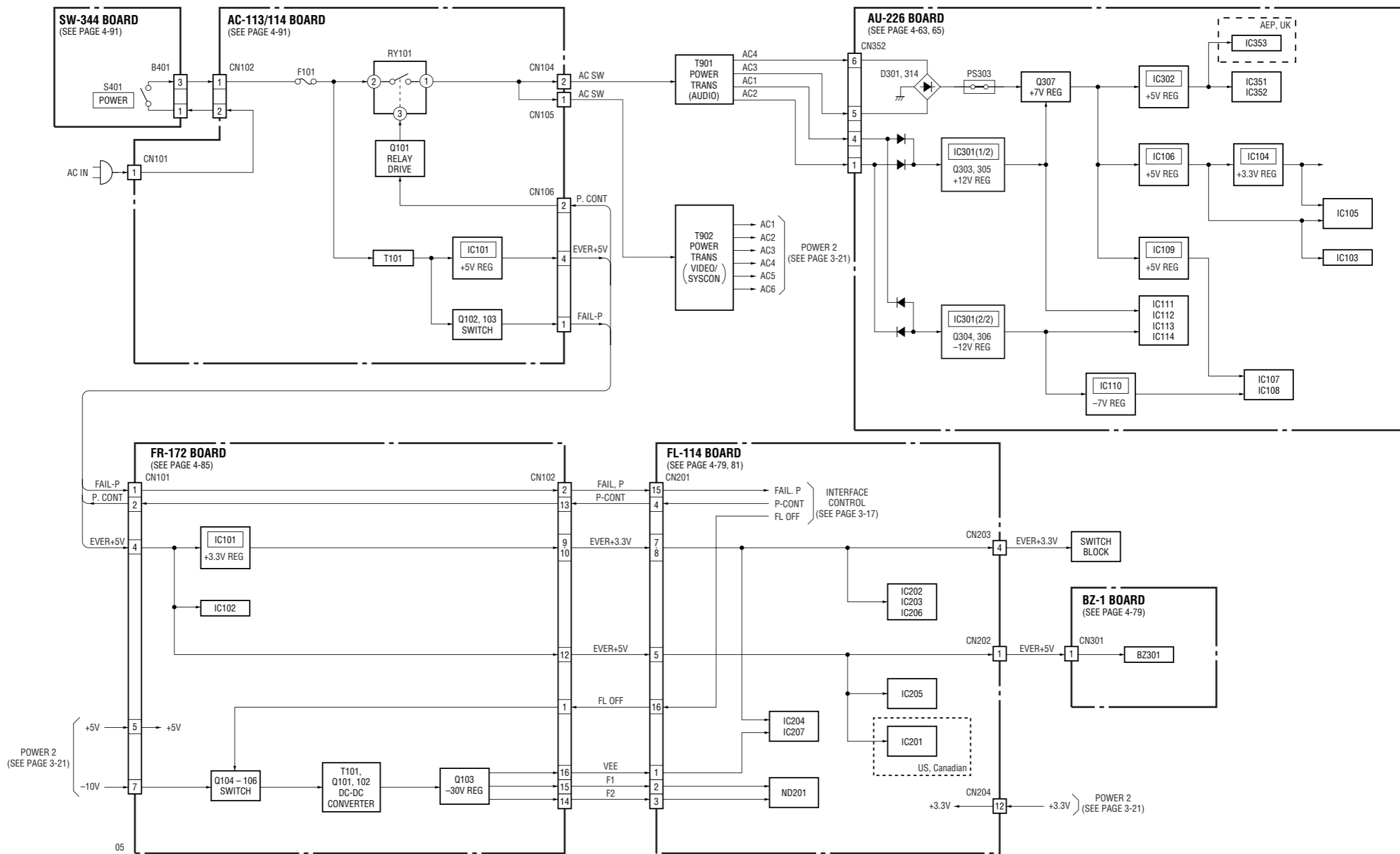



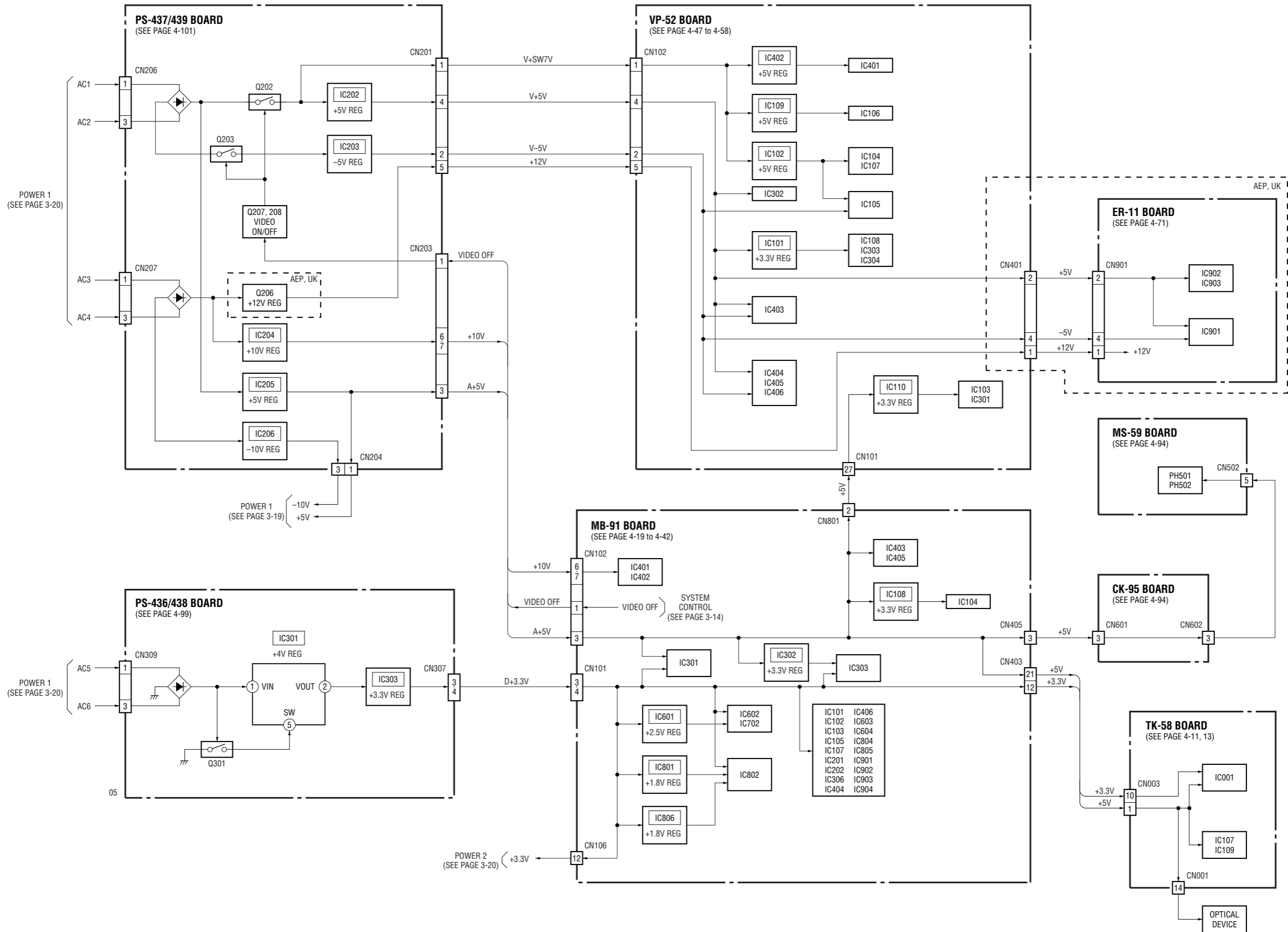

3-11. POWER 2 BLOCK DIAGRAM



## SECTION 4 PRINTED WIRING BOARDS AND SCHEMATIC DIAGRAMS







**THIS NOTE IS COMMON FOR PRINTED WIRING BOARDS AND SCHEMATIC DIAGRAMS.  
(In addition to this, the necessary note is printed in each block.)**



**For printed wiring boards:**

-  : indicates a lead wire mounted on the component side.
-  : indicates a lead wire mounted on the printed side.
-  : Through hole.
-  : Pattern from the side which enables seeing.  
(The other layers' patterns are not indicated.)

**Caution:**  
 Pattern face side: Parts on the pattern face side seen from the pattern face are indicated.  
 (Side A)  
 Parts face side: Parts on the parts face side seen from the parts face are indicated.  
 (Side B)

**For schematic diagram:**

- Caution when replacing chip parts.  
New parts must be attached after removal of chip.  
Be careful not to heat the minus side of tantalum capacitor, because it is damaged by the heat.
- All resistors are in ohms,  $\frac{1}{4}W$  (Chip resistors:  $\frac{1}{10}W$ ) unless otherwise specified.  
k $\Omega$  : 1000 $\Omega$ , M $\Omega$  : 1000k $\Omega$ .
- All capacitors are in  $\mu F$  unless otherwise noted. pF :  $\mu\mu F$   
50V or less are not indicated except for electrolytics and tantalums.
- All variable and adjustable resistors have characteristic curve B, unless otherwise noted.
-  : nonflammable resistor.
-  : fusible resistor.
-  : panel designation.
-  : internal component.
-  : adjustment for repair.
-  : B+ Line.
-  : B- Line.
- Circled numbers refer to waveforms.
- Voltages are dc between measurement point.
- Readings are taken with a color-bar signal on DVD reference disc and when playing CD reference disc.
- Readings are taken with a digital multimeter (DC 10M $\Omega$ ).
- Voltage variations may be noted due to normal production tolerances.

<p><b>Note:</b> The components identified by mark  or dotted line with mark  are critical for safety. Replace only with part number specified.</p>	<p><b>Note:</b> Les composants identifiés par une marque  sont critiques pour la sécurité. Ne les remplacer que par une pièce portant le numéro spécifié.</p>
--	--

When indicating parts by reference number, please include the board name.

- Abbreviation  
 AUS : Australian model  
 CN : Chinese model  
 CND : Canadian model  
 HK : Hong Kong model



4-1. FRAME SCHEMATIC DIAGRAM

FRAME (1) SCHEMATIC DIAGRAM

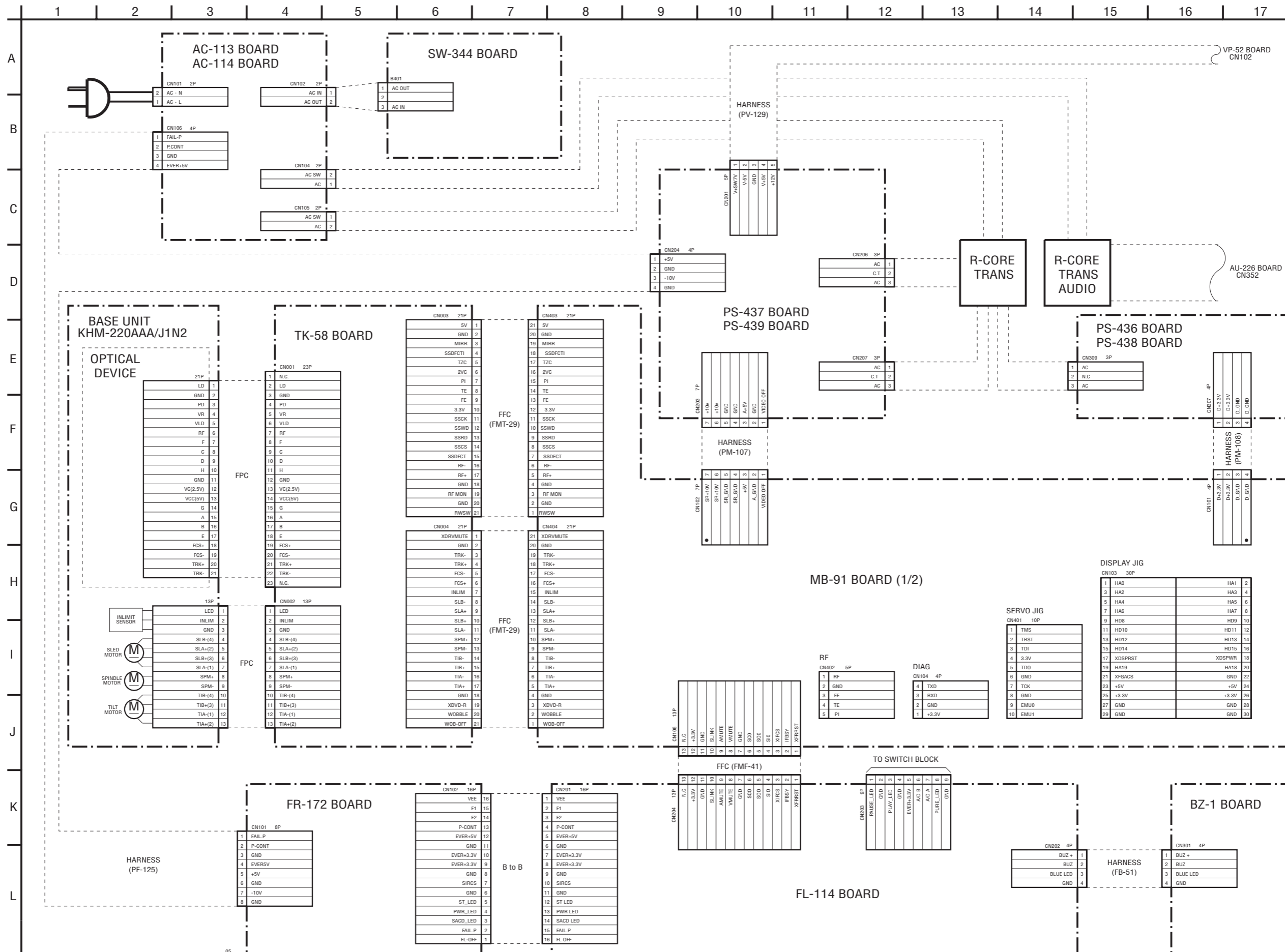

FRAME (2) SCHEMATIC DIAGRAM

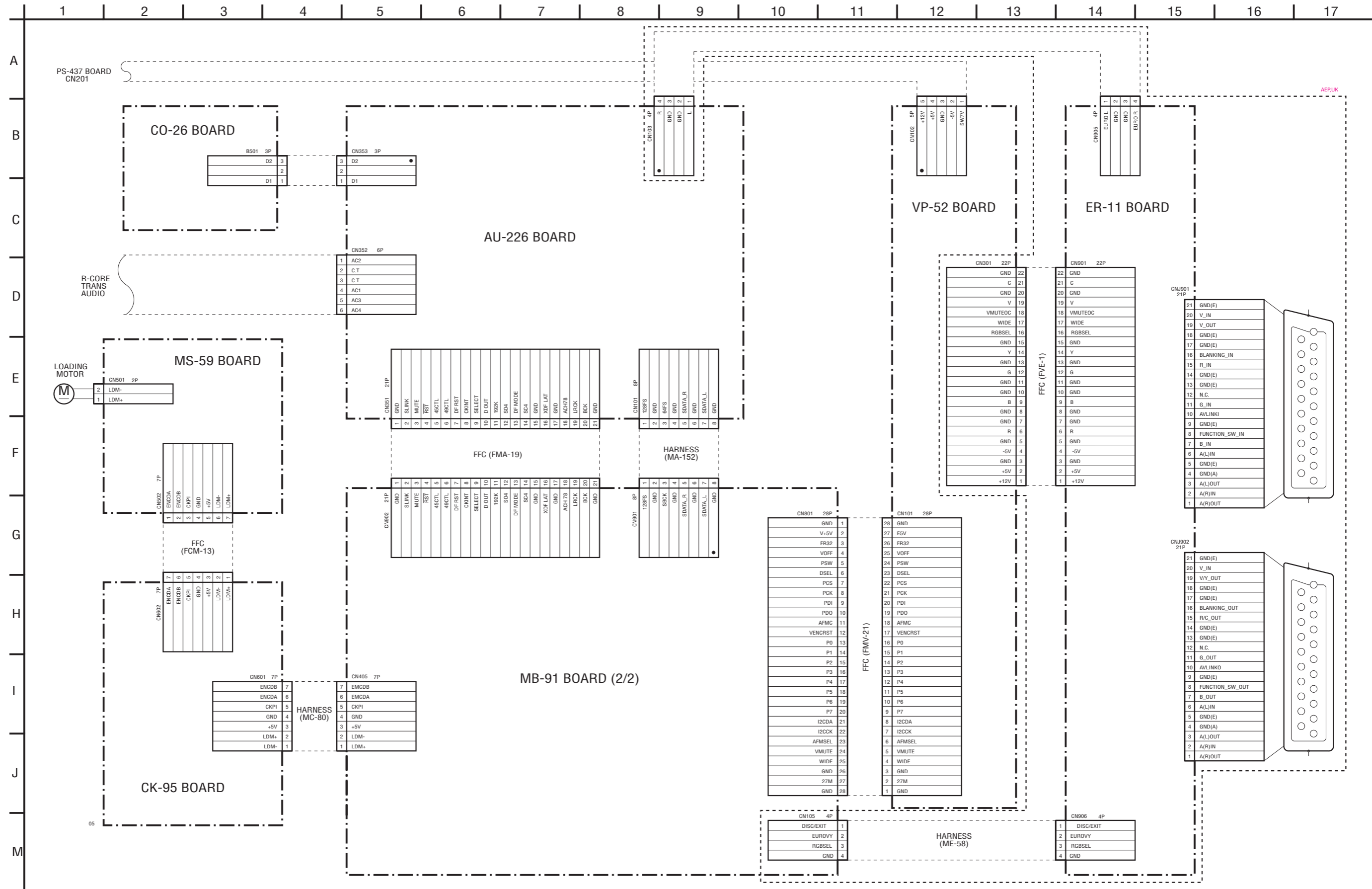

4-2. PRINTED WIRING BOARDS AND SCHEMATIC DIAGRAMS

TK-58 (RF/SERVO) PRINTED WIRING BOARD

– Ref. No.: TK-58 board; 1,000 series –

There are a few cases that the part isn't mounted in this model is printed on this diagram.

TK-58 BOARD (SIDE A)

- CN001 B-3
- CN002 B-3
- CN003 A-1
- CN004 B-1
- D003 B-4
- IC001 A-2
- IC107 A-2
- IC109 A-2
- Q001 B-4
- Q005 A-2

TK-58 BOARD (SIDE A)

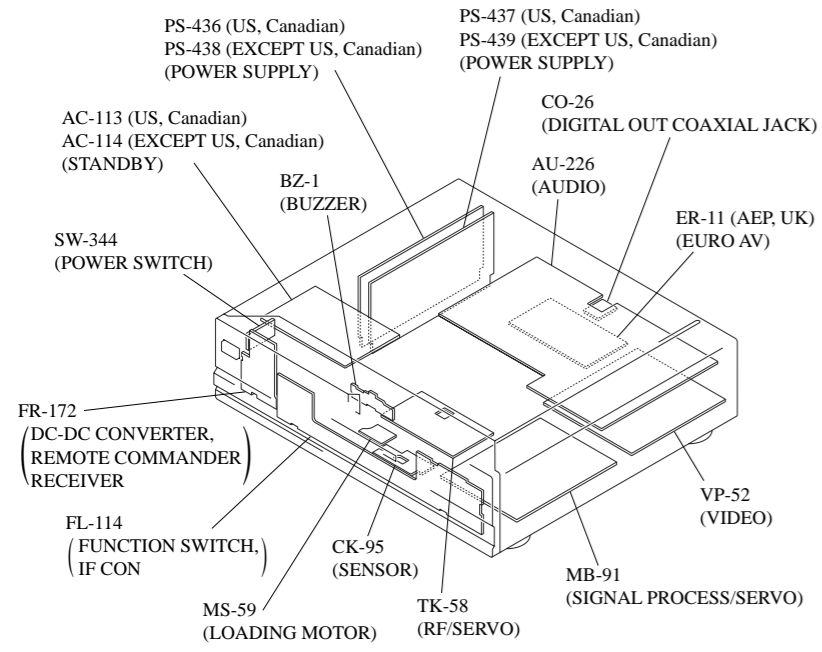
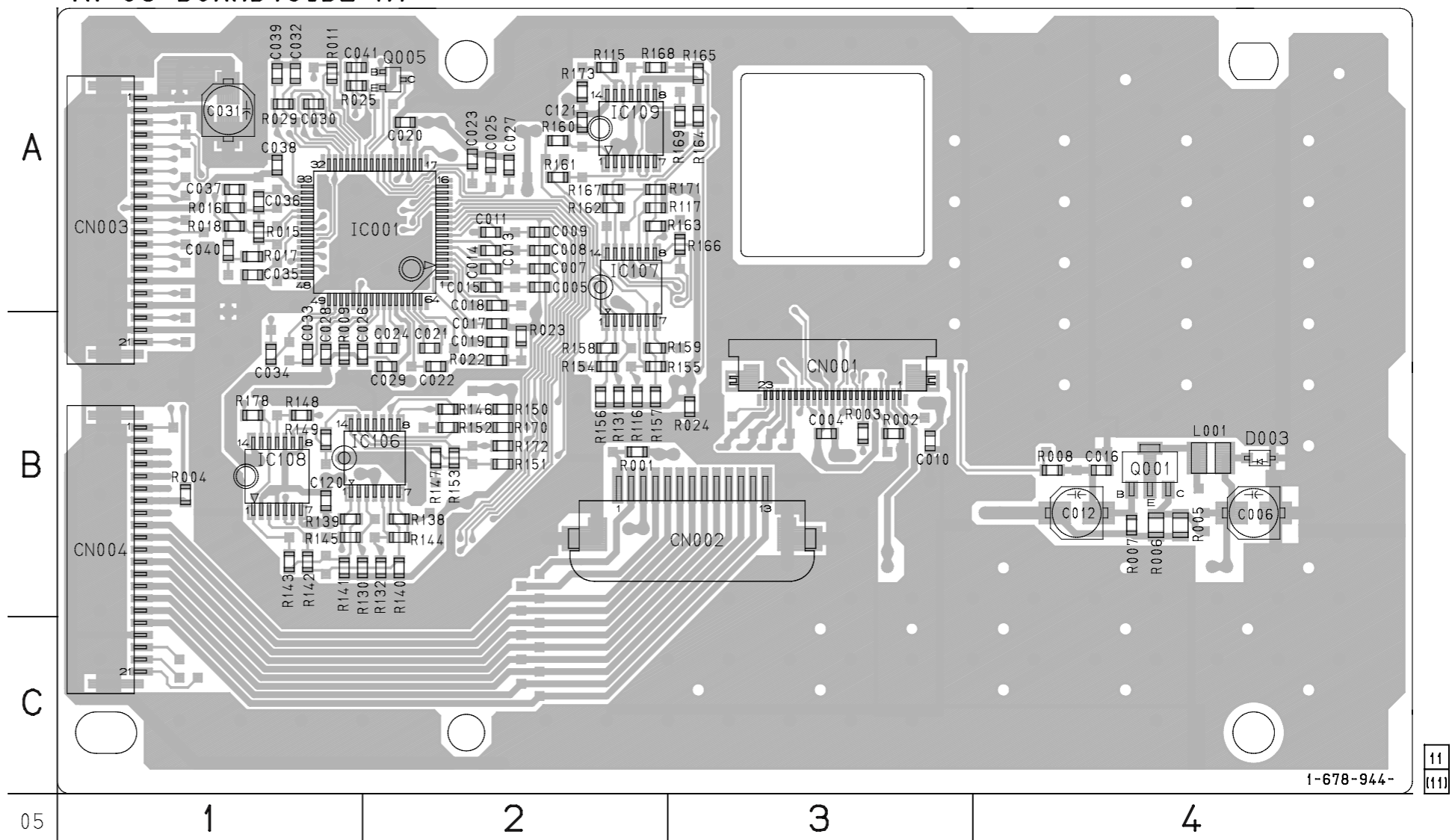

TK-58 BOARD(SIDE B)

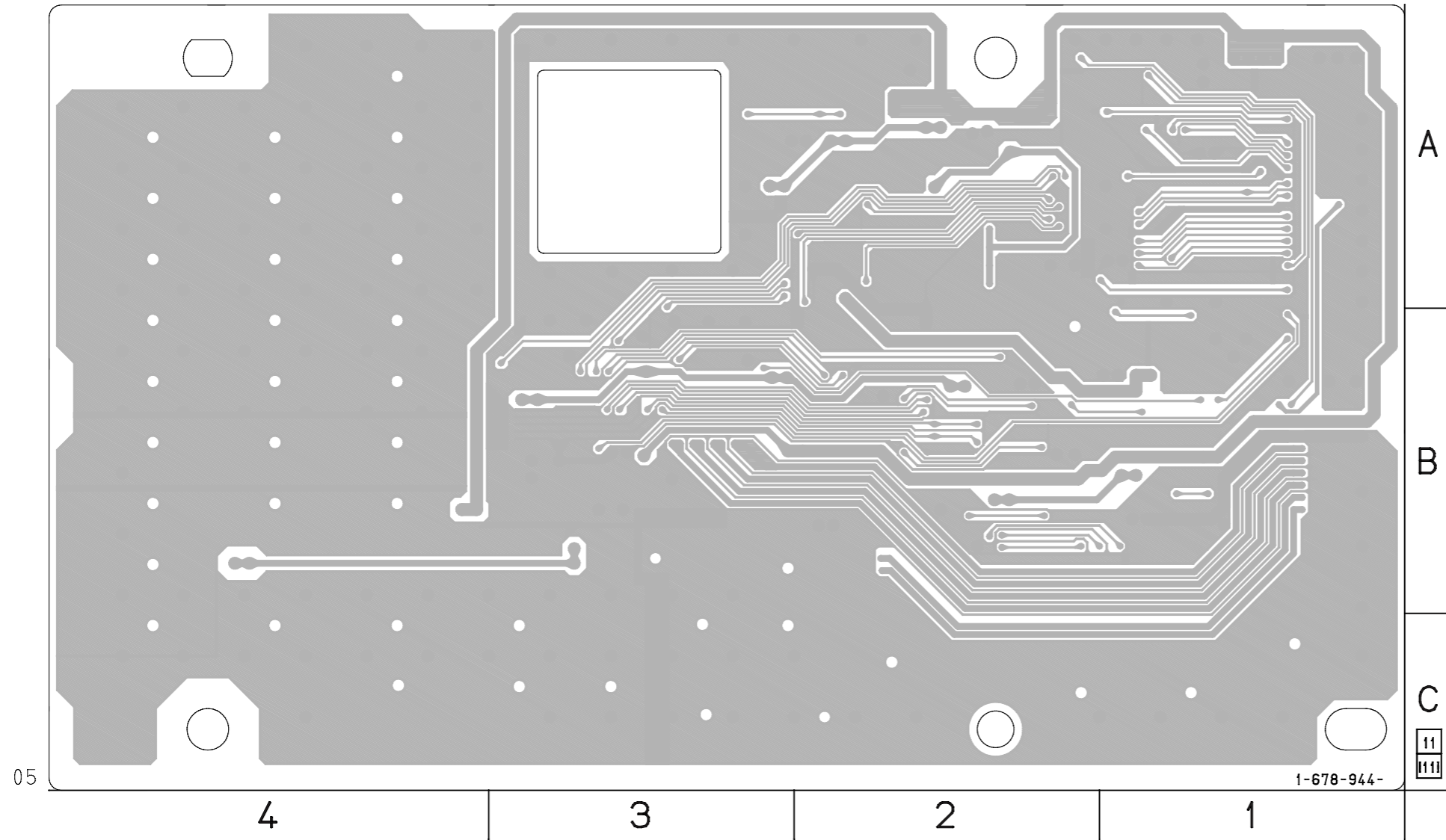

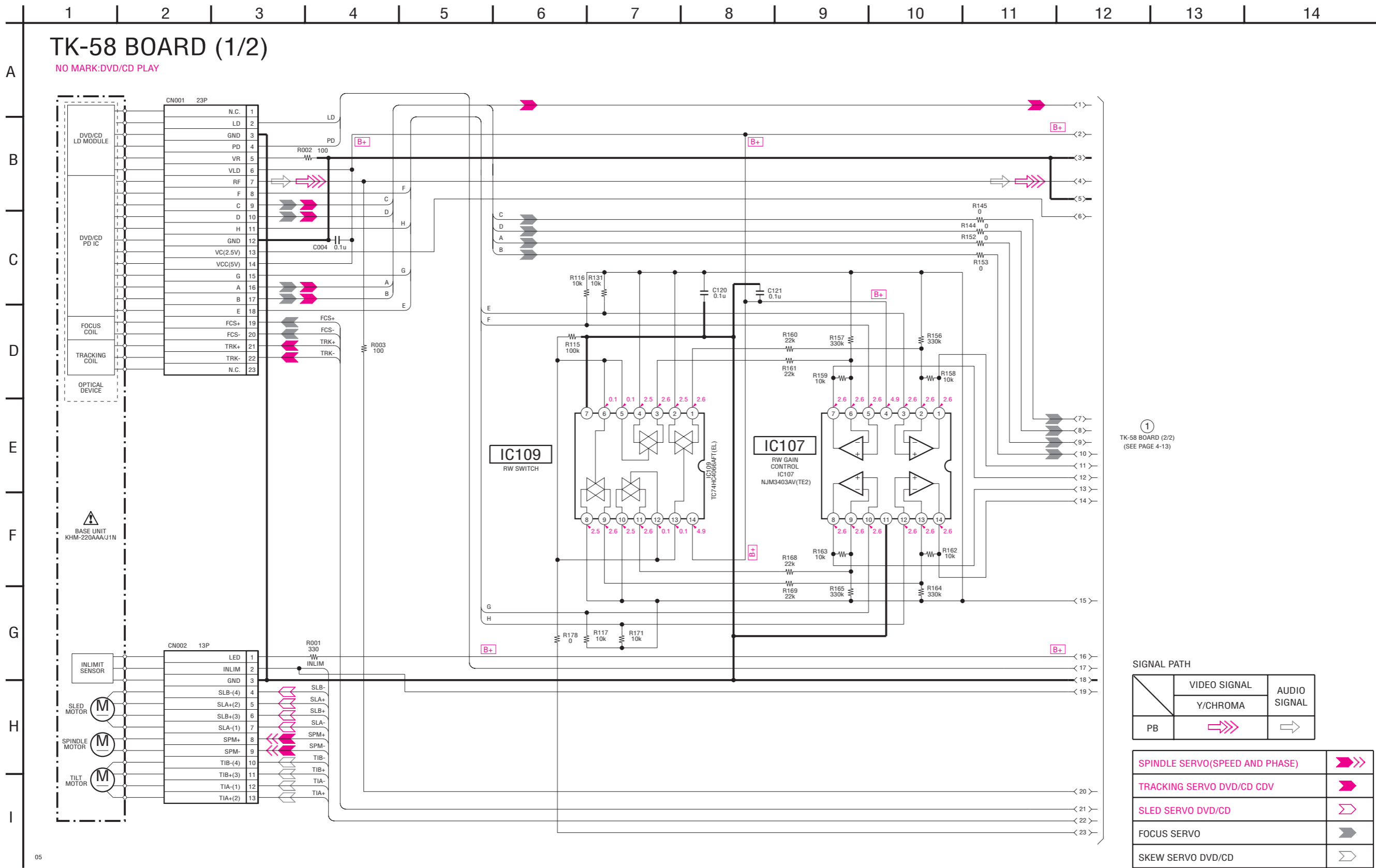

1  
TK-58 BOARD (2/2)  
(SEE PAGE 4-13)

**Note:**  
The components identified by mark  $\Delta$  or dotted line with mark  $\Delta$  are critical for safety. Replace only with part number specified.

**Note:**  
Les composants identifiés par une marque  $\Delta$  sont critiques pour la sécurité. Ne les remplacer que par une pièce portant le numéro spécifié.

TK-58 (RF AMP) SCHEMATIC DIAGRAM • See page 4-7 for printed wiring board.

– Ref. No.: TK-58 board; 6,000 series –

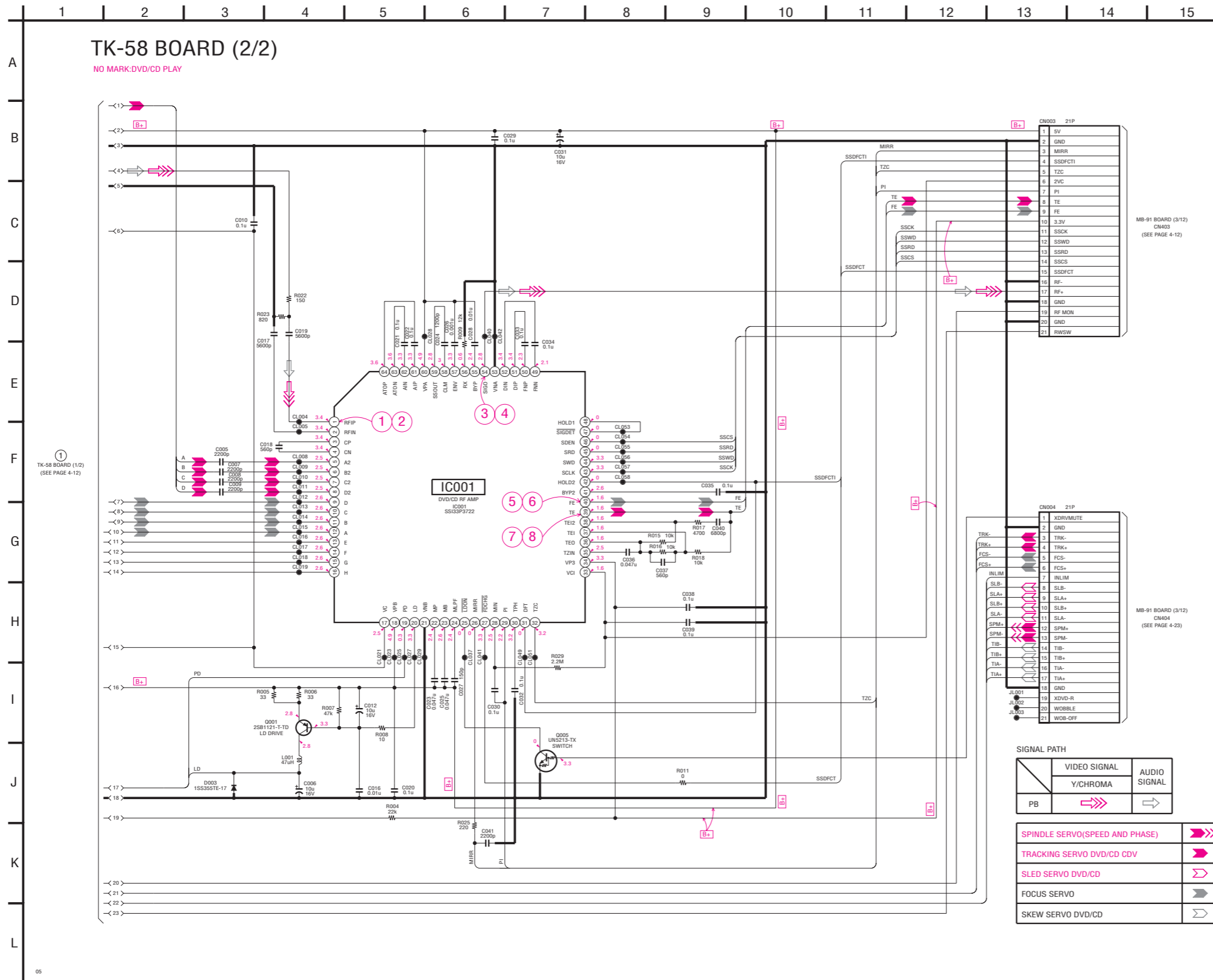

• Waveforms

① IC001 ① (DVD play)  
200 mV/DIV 50 ns/DIV

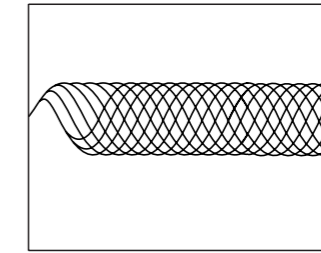

② IC001 ① (CD play)  
200 mV/DIV 200 ns/DIV

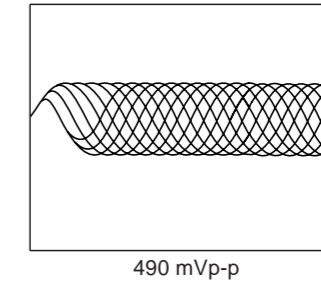

③ IC001 ⑤④ (DVD play)  
500 mV/DIV 50 ns/DIV

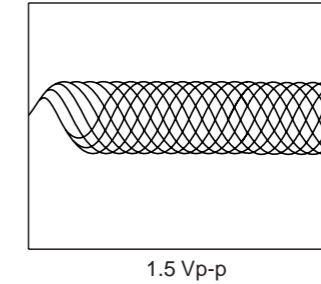

④ IC001 ⑤④ (CD play)  
500 mV/DIV 200 ns/DIV

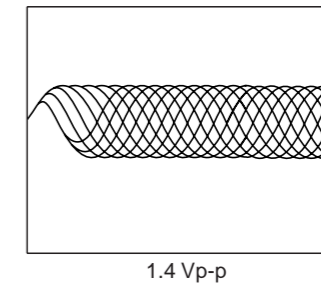

⑤ IC001 ④⑩ (DVD play)  
50 mV/DIV 50 ms/DIV

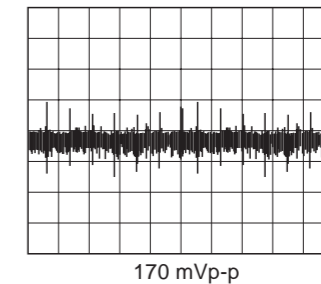

⑥ IC001 ④⑩ (CD play)  
200 mV/DIV 50 ms/DIV

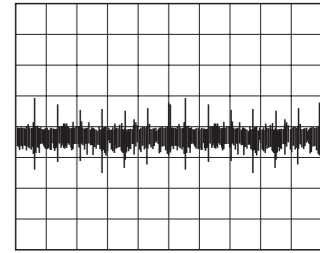

⑦ IC001 ③⑨ (DVD play)  
500 mV/DIV 50 ms/DIV

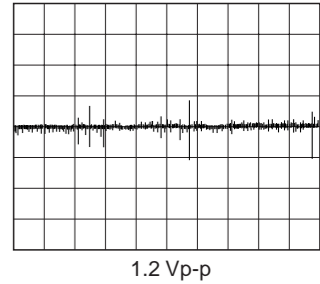

⑧ IC001 ③⑨ (CD play)  
500 mV/DIV 200 ms/DIV

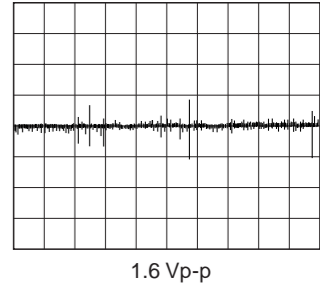

**DVP-S9000ES**

**MB-91 (SIGNAL PROCESS/SERVO) PRINTED WIRING BOARD**

– Ref. No.: MB-91 board; 1,000 series –

There are a few cases that the part isn't mounted in this model is printed on this diagram.

MB-91 BOARD (SIDE A)

CN101	E-3
CN102	E-6
CN104	C-6
CN105	A-4
CN106	B-6
CN402	E-5
CN403	E-3
CN404	E-4
CN405	D-6
CN801	A-1
CN901	E-2
CN902	E-1
D101	B-6
D404	D-6
IC101	A-6
IC102	A-5
IC104	C-5
IC107	A-6
IC108	C-4
IC201	B-4
IC303	D-4
IC404	D-6
IC405	C-6
IC602	D-3
IC801	A-2
IC802	B-2
IC901	D-1
Q401	E-4

MB-91 BOARD (SIDE A)

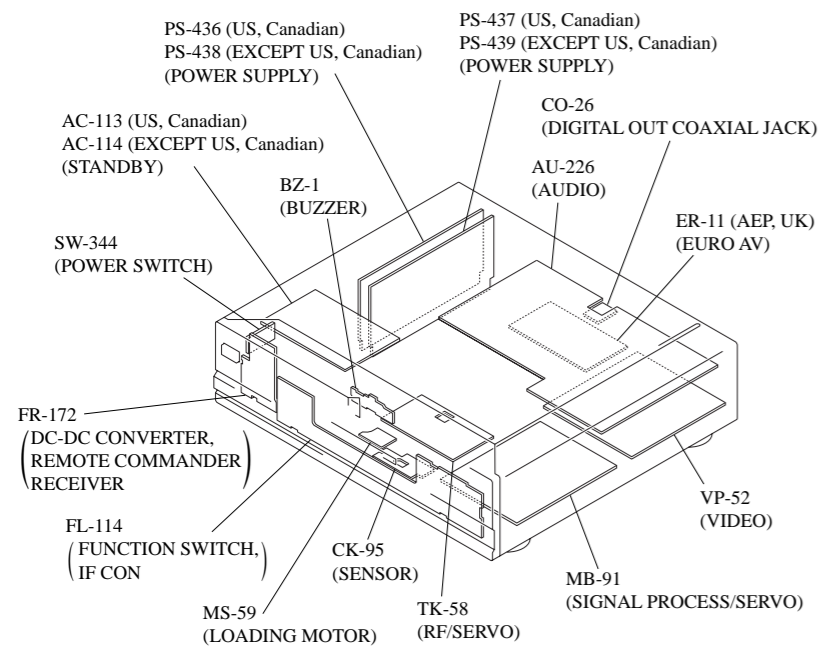
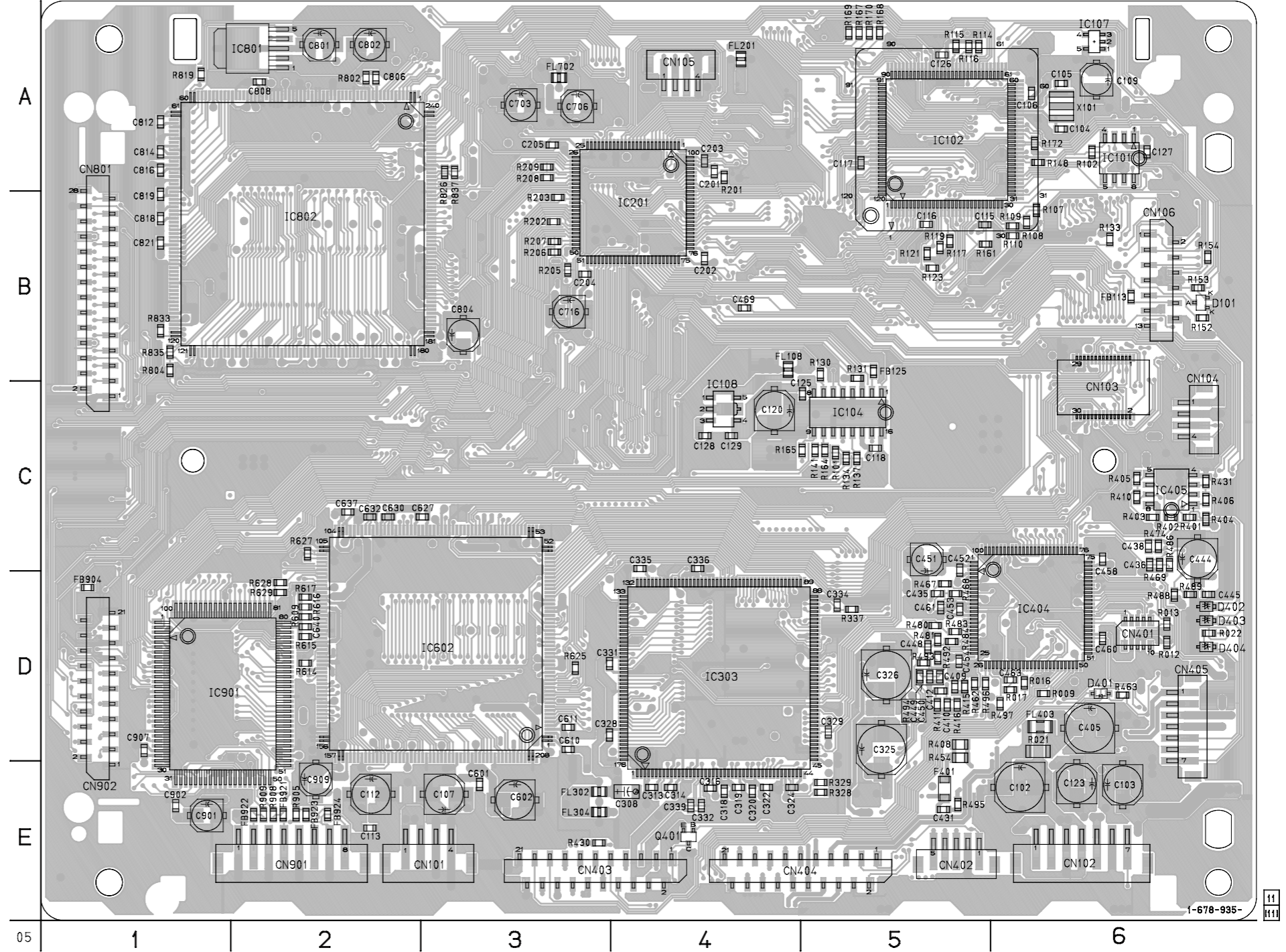

MB-91 BOARD(SIDE B)

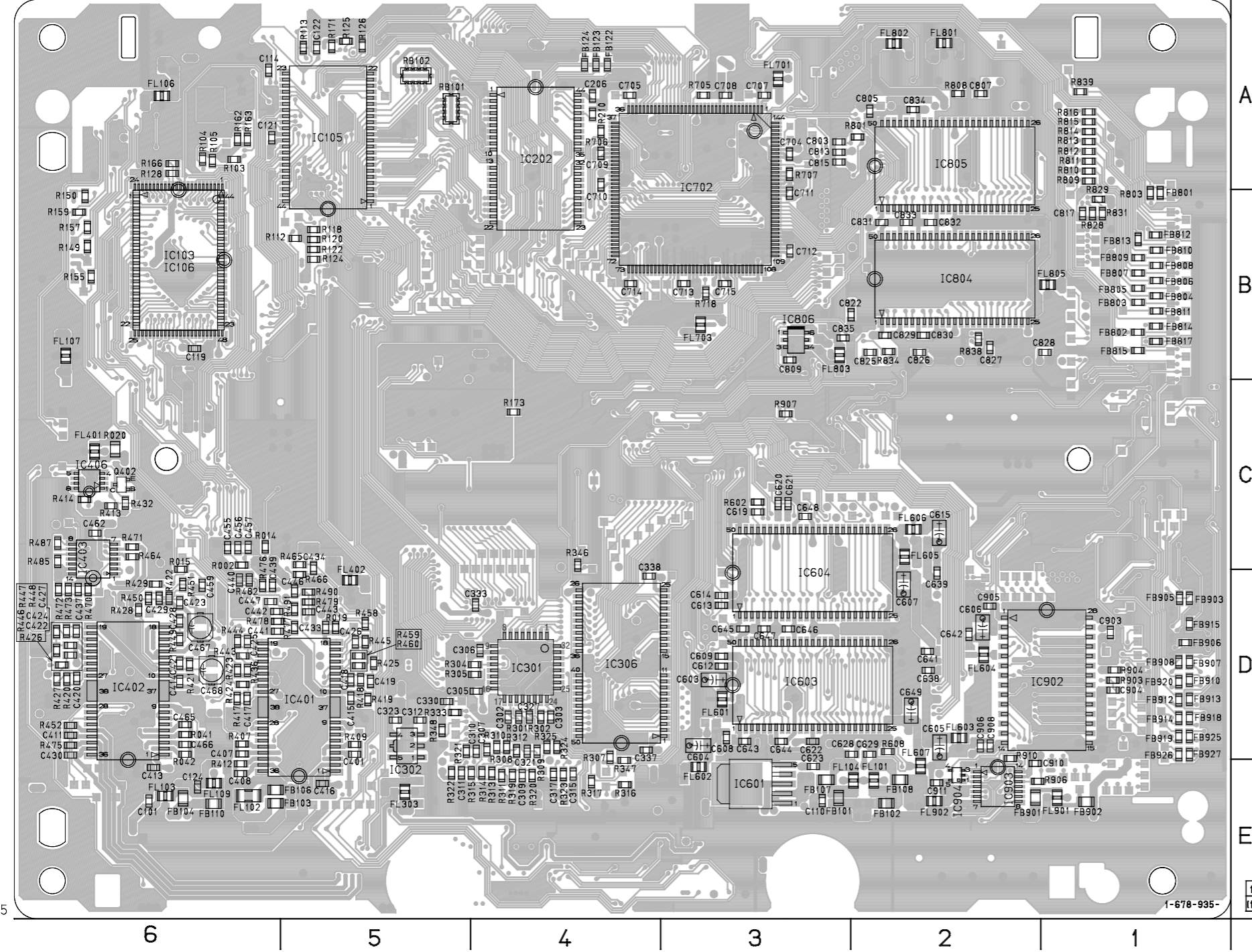

MB-91 BOARD (SIDE B)

- IC103 B-6
- IC105 A-5
- IC202 A-4
- IC301 D-4
- IC302 D-5
- IC306 D-4
- IC401 D-5
- IC402 D-6
- IC403 D-6
- IC406 C-6
- IC601 E-3
- IC603 D-3
- IC604 C-3
- IC702 A-3
- IC804 B-2
- IC805 A-2
- IC806 B-3
- IC902 D-1
- IC903 E-2
- IC904 E-2
- Q402 C-6



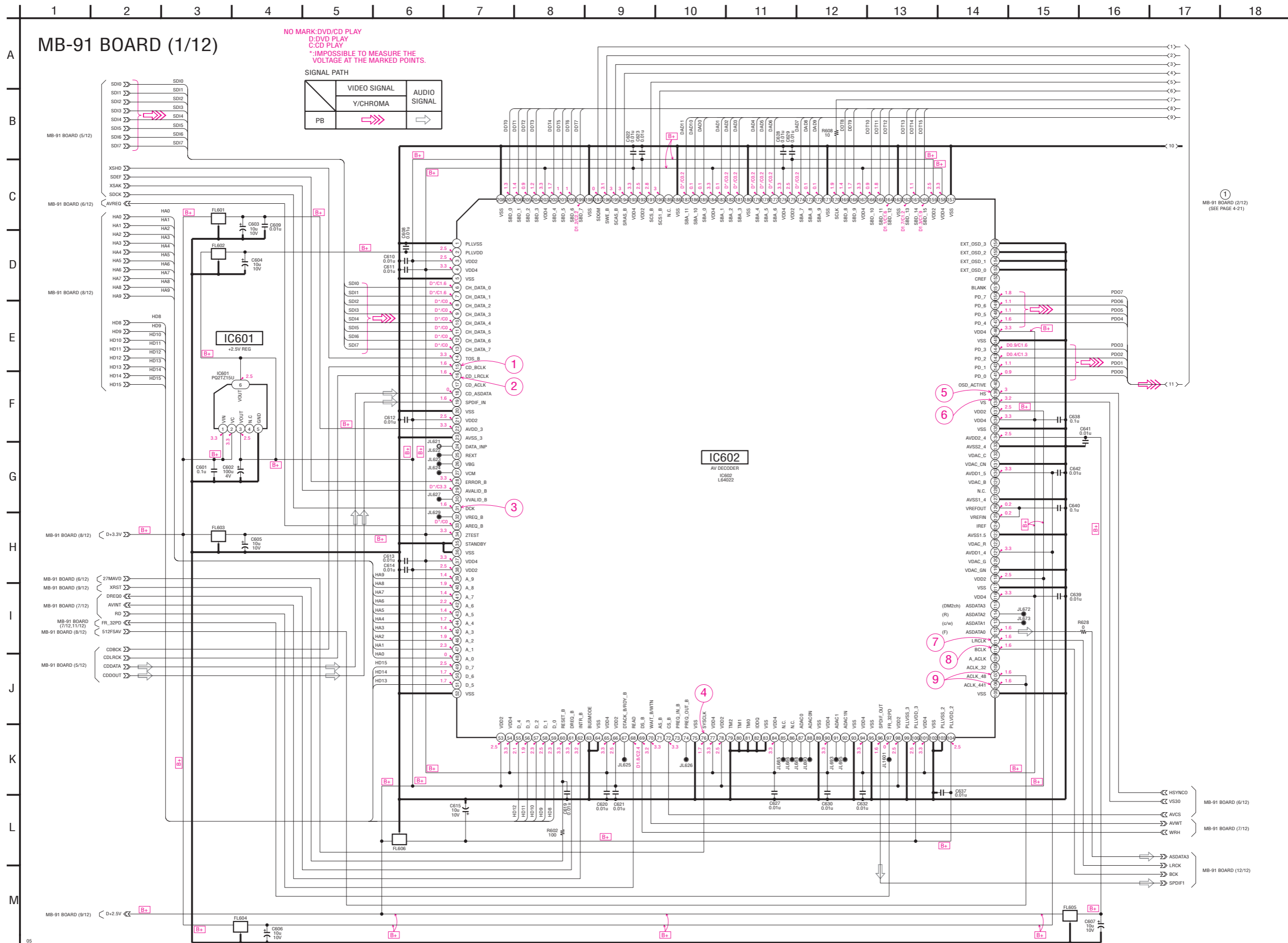

**MB-91 (SDRAM) SCHEMATIC DIAGRAM** • See page 4-15 for printed wiring board.

– Ref. No.: MB-91 board; 1,000 series –

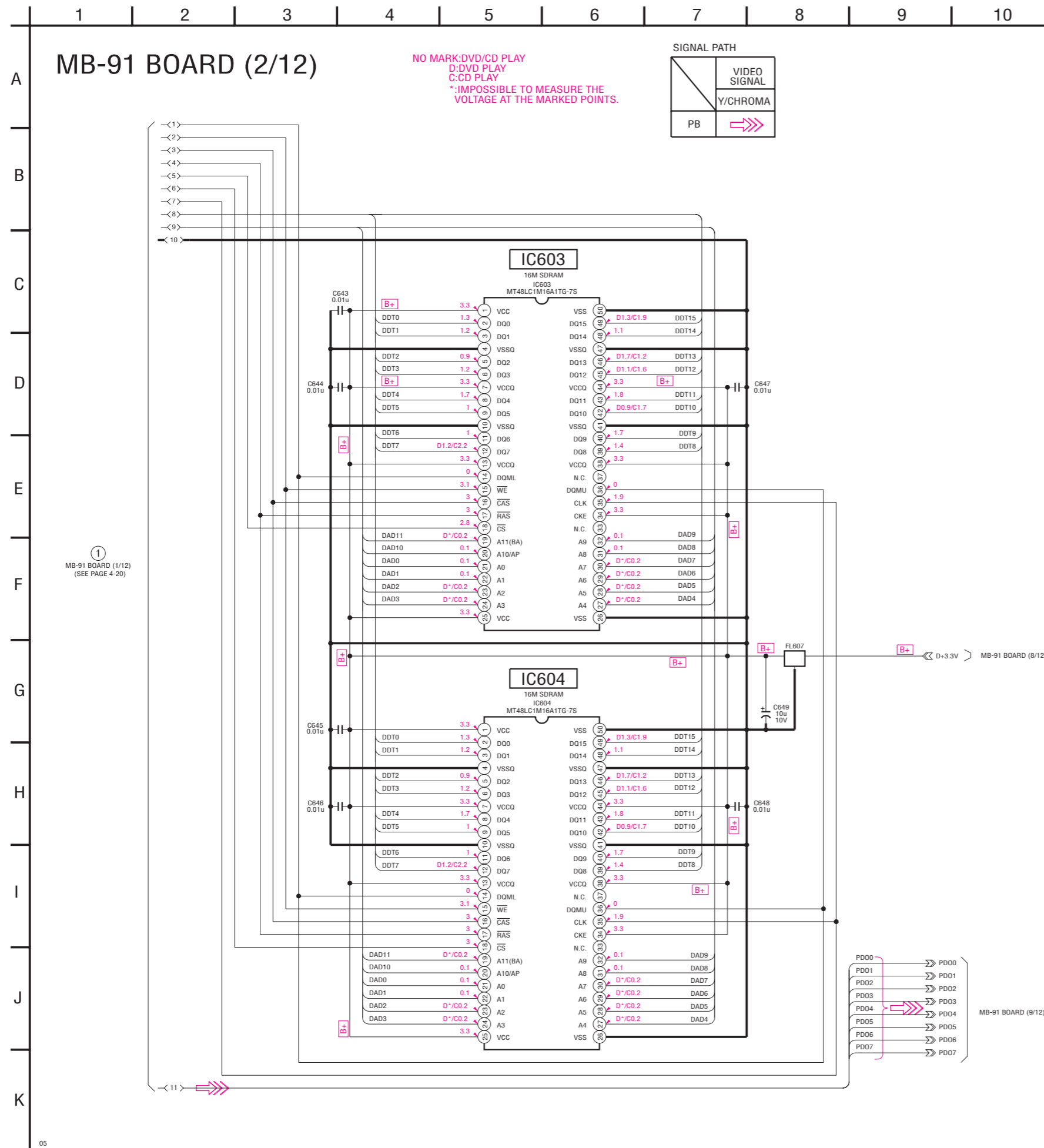

• Waveforms

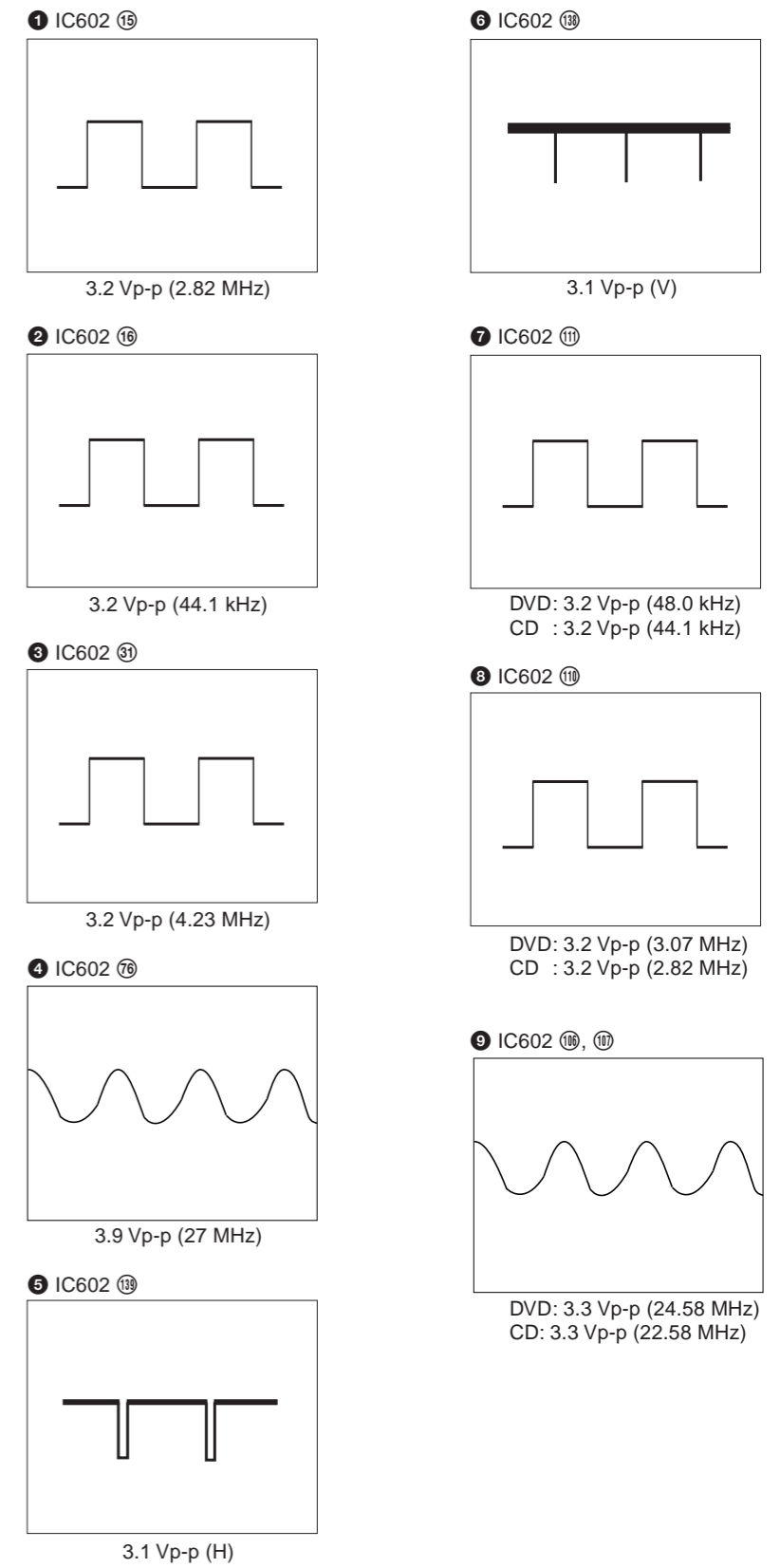

1 2 3 4 5 6 7 8 9 10 11 12 13 14 15 16 17 18 19 20

MB-91 BOARD (3/12)

NO MARK: DVD/CD PLAY  
 D: DVD PLAY  
 C: CD PLAY

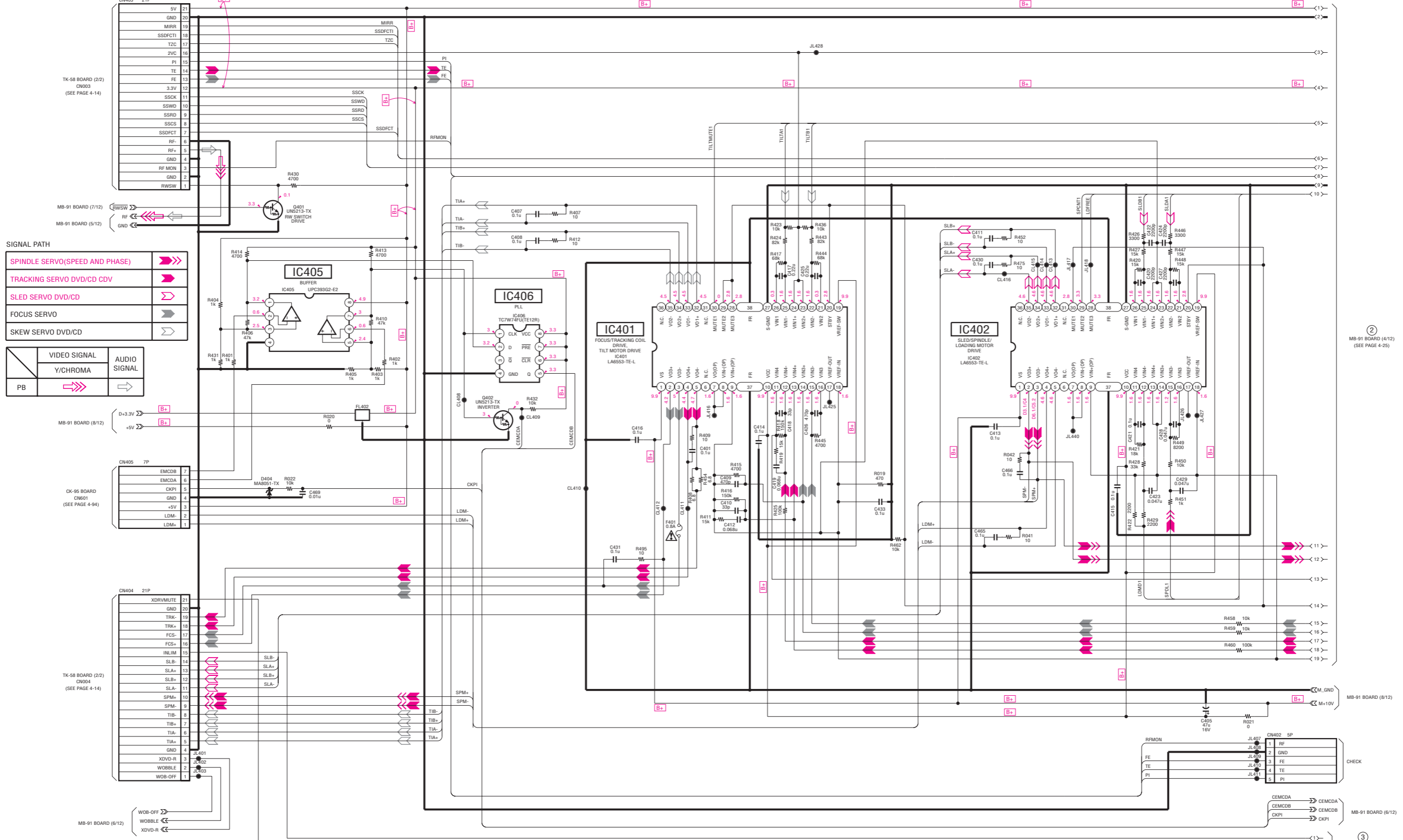

**Note:**  
 The components identified by mark  $\Delta$  or dotted line with mark  $\Delta$  are critical for safety. Replace only with part number specified.

**Note:**  
 Les composants identifiés par une marque  $\Delta$  sont critiques pour la sécurité. Ne les remplacer que par une pièce portant le numéro spécifié.

**MB-91 (DRIVE) SCHEMATIC DIAGRAM • See page 4-15 for printed wiring board.**

– Ref. No.: MB-91 board; 1,000 series –

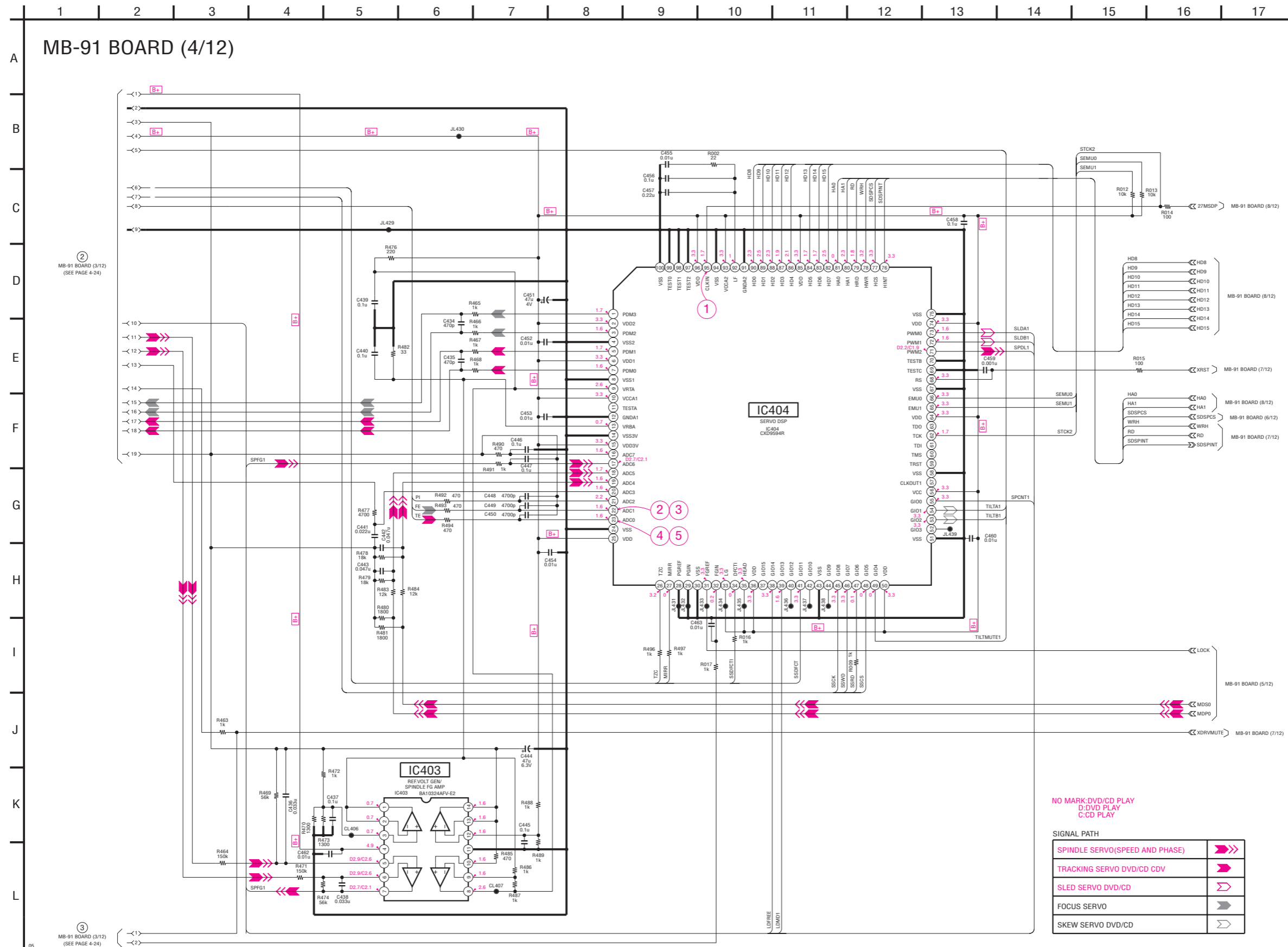

• Waveforms

1 IC404 ⑤

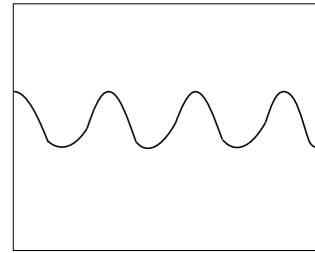

3.2 Vp-p (27 MHz)

2 IC404 ② (DVD play)  
50 mV/DIV 50 ms/DIV

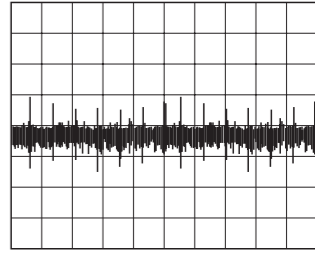

170 mVp-p

3 IC404 ② (CD play)  
200 mV/DIV 50 ms/DIV

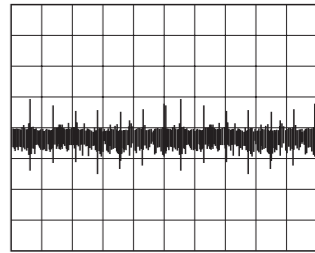

520 mVp-p

4 IC404 ③ (DVD play)  
500 mV/DIV 50 ms/DIV

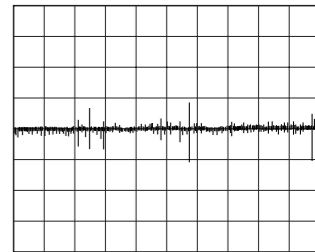

1.2 Vp-p

5 IC404 ③ (CD play)  
500 mV/DIV 200 ms/DIV

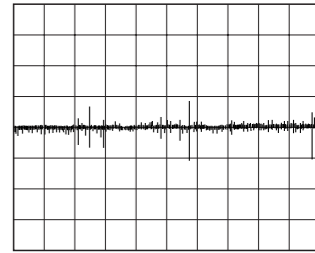

1.6 Vp-p

MB-91 (ARP3) SCHEMATIC DIAGRAM • See page 4-15 for printed wiring board.

- Ref. No.: MB-91 board; 1,000 series -

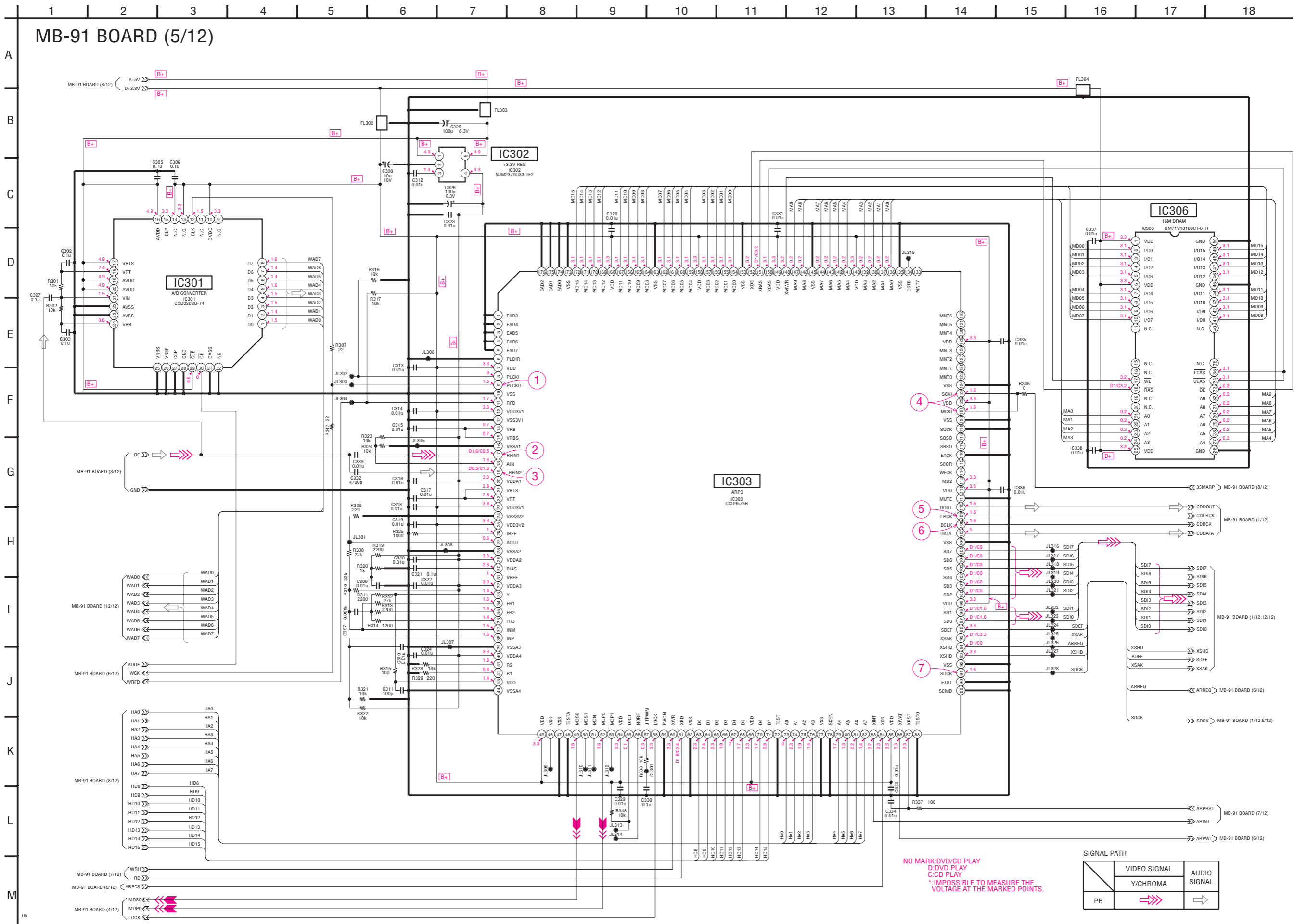

NO MARK: DVD/CD PLAY  
 D: DVD PLAY  
 C: CD PLAY  
 \*\*: IMPOSSIBLE TO MEASURE THE VOLTAGE AT THE MARKED POINTS.

SIGNAL PATH

	VIDEO SIGNAL	AUDIO SIGNAL
	Y/CHROMA	
PB		

**MB-91 (SYSTEM CONTROL) SCHEMATIC DIAGRAM** • See page 4-15 for printed wiring board.

– Ref. No.: MB-91 board; 1,000 series –

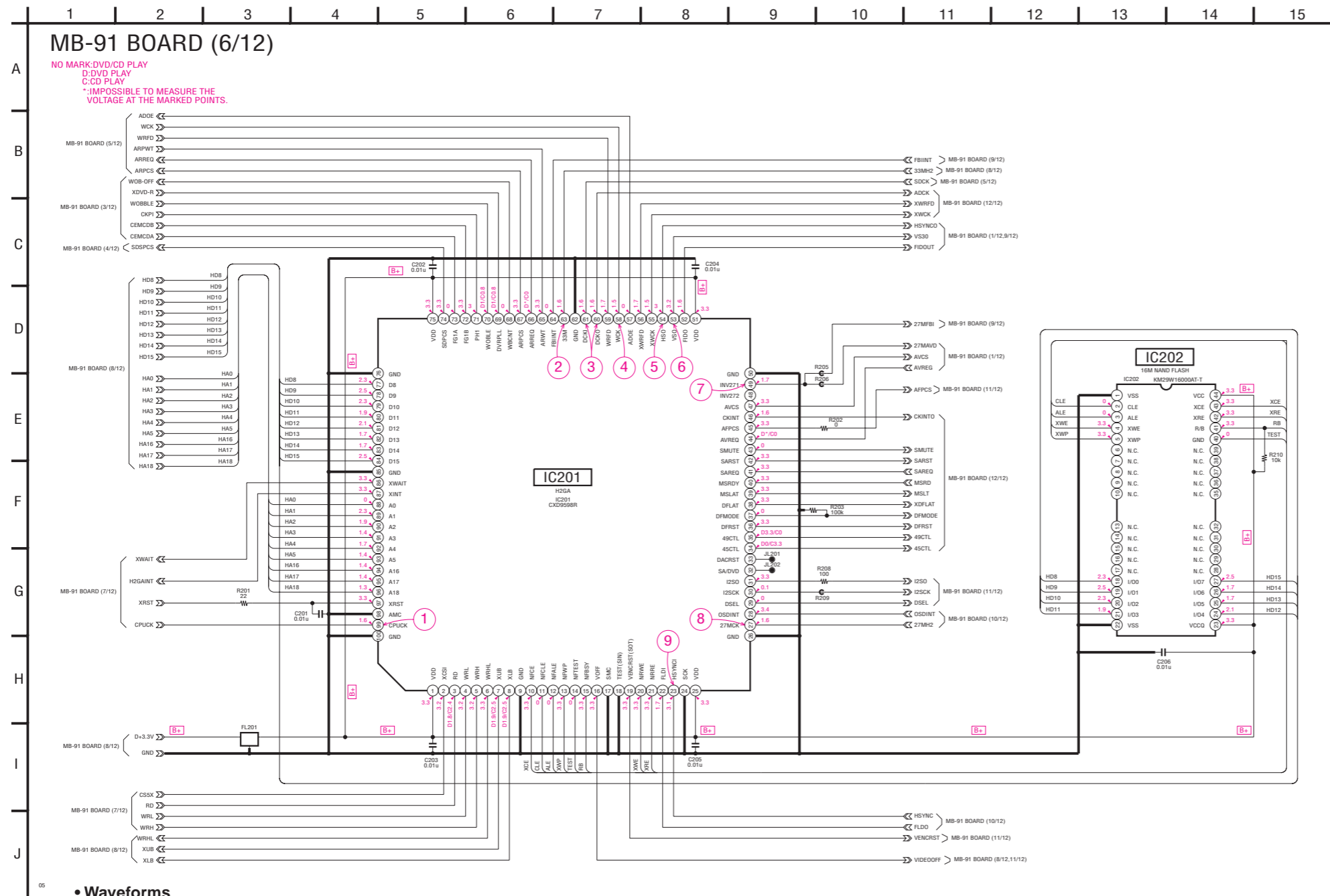

**• Waveforms MB-91 BOARD (6/12)**

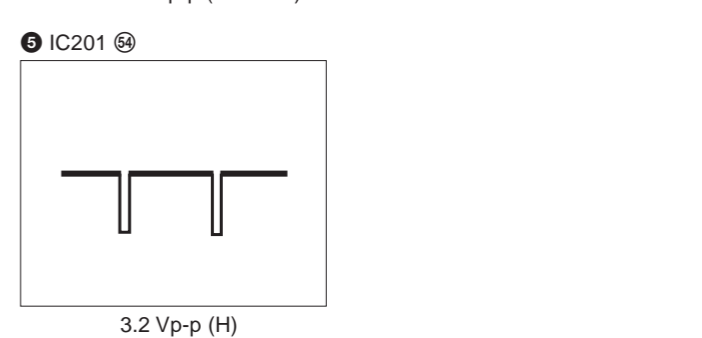
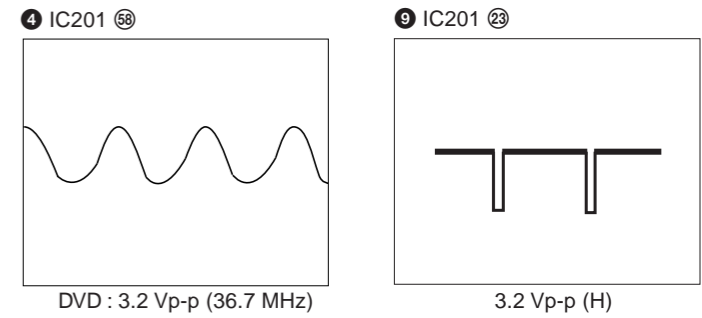
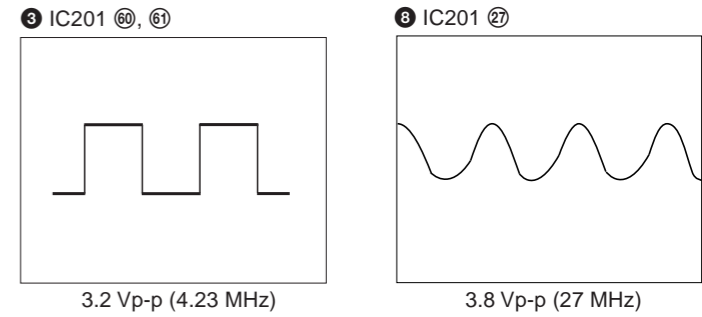
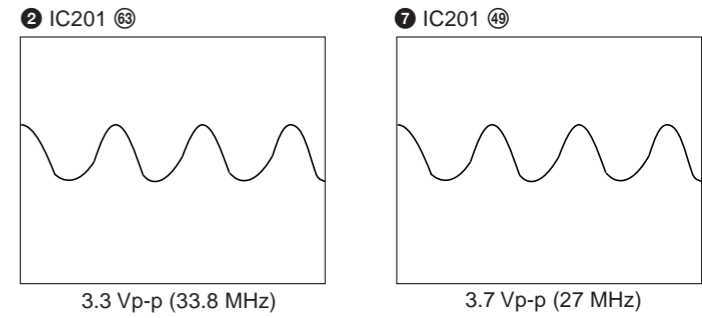
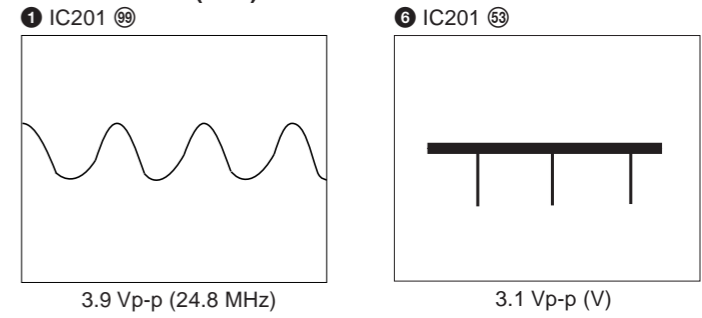

**• Waveforms MB-91 BOARD (5/12)**

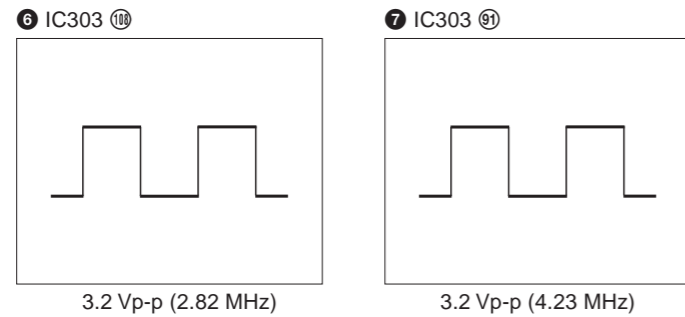
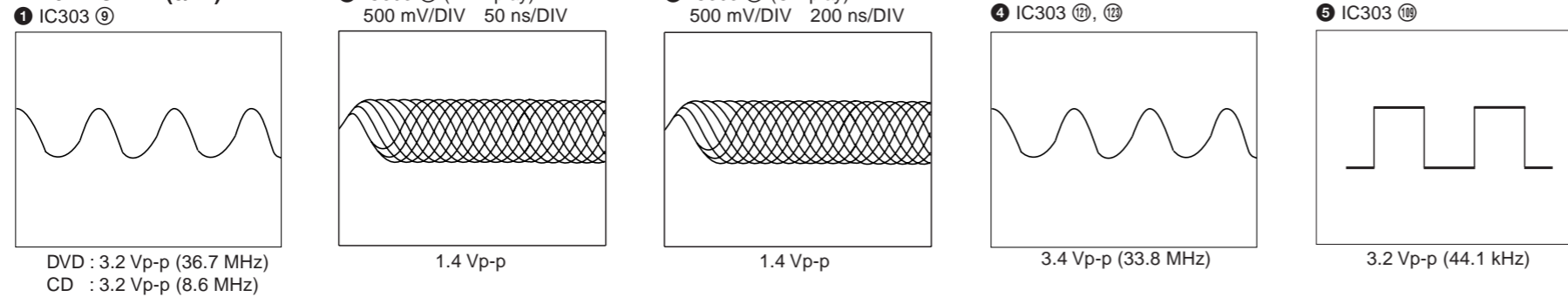

**MB-91 (ROM/RAM) SCHEMATIC DIAGRAM** • See page 4-15 for printed wiring board.

– Ref. No.: MB-91 board; 1,000 series –

• Waveforms

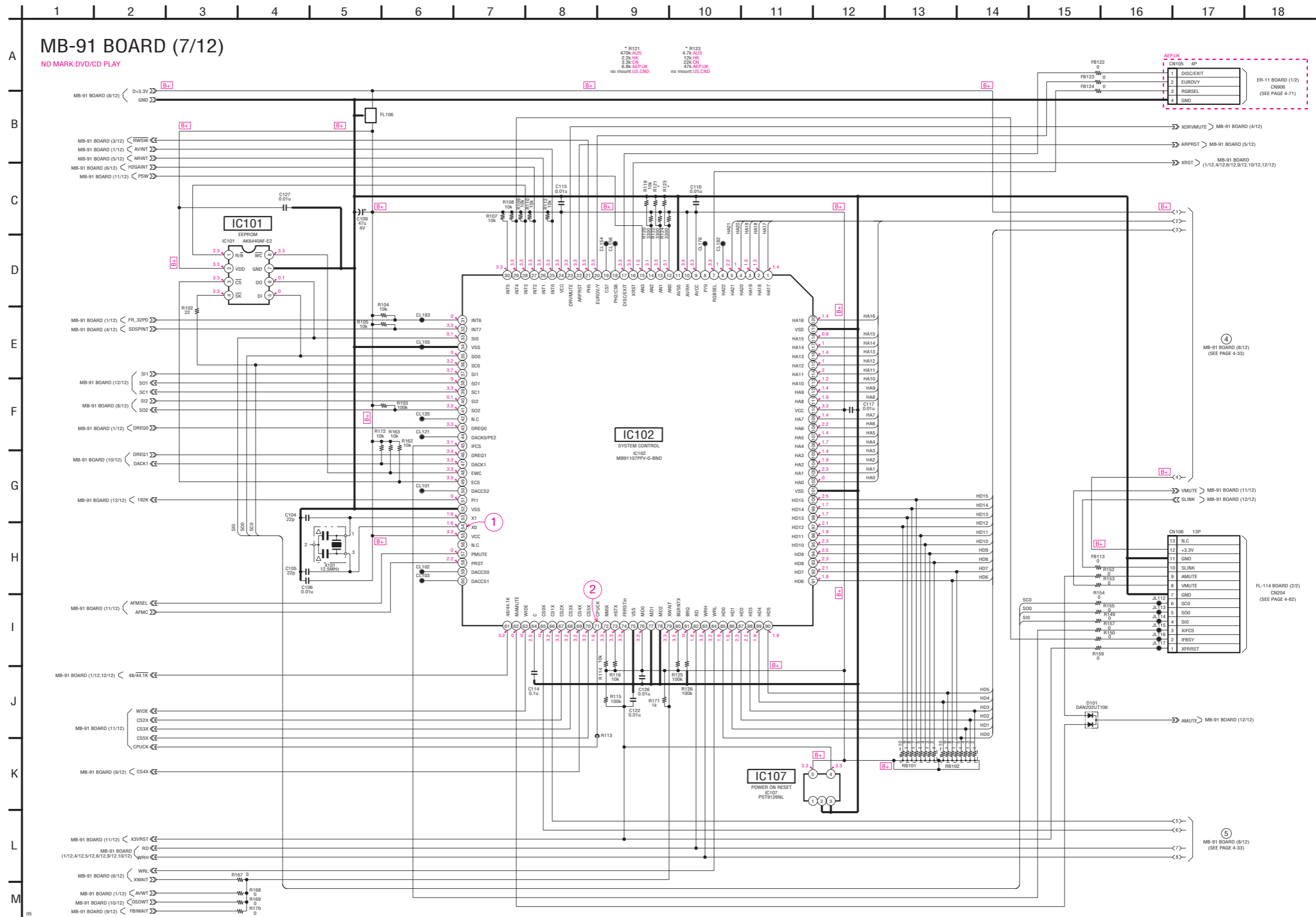
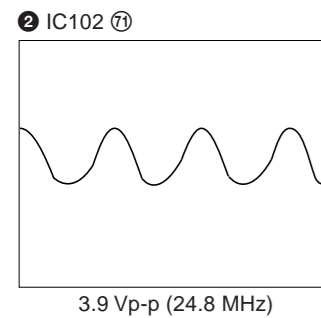
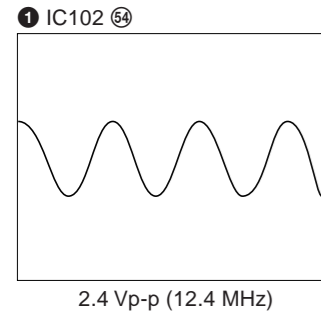

**MB-91 (H2GA) SCHEMATIC DIAGRAM • See page 4-15 for printed wiring board.**

– Ref. No.: MB-91 board; 1,000 series –

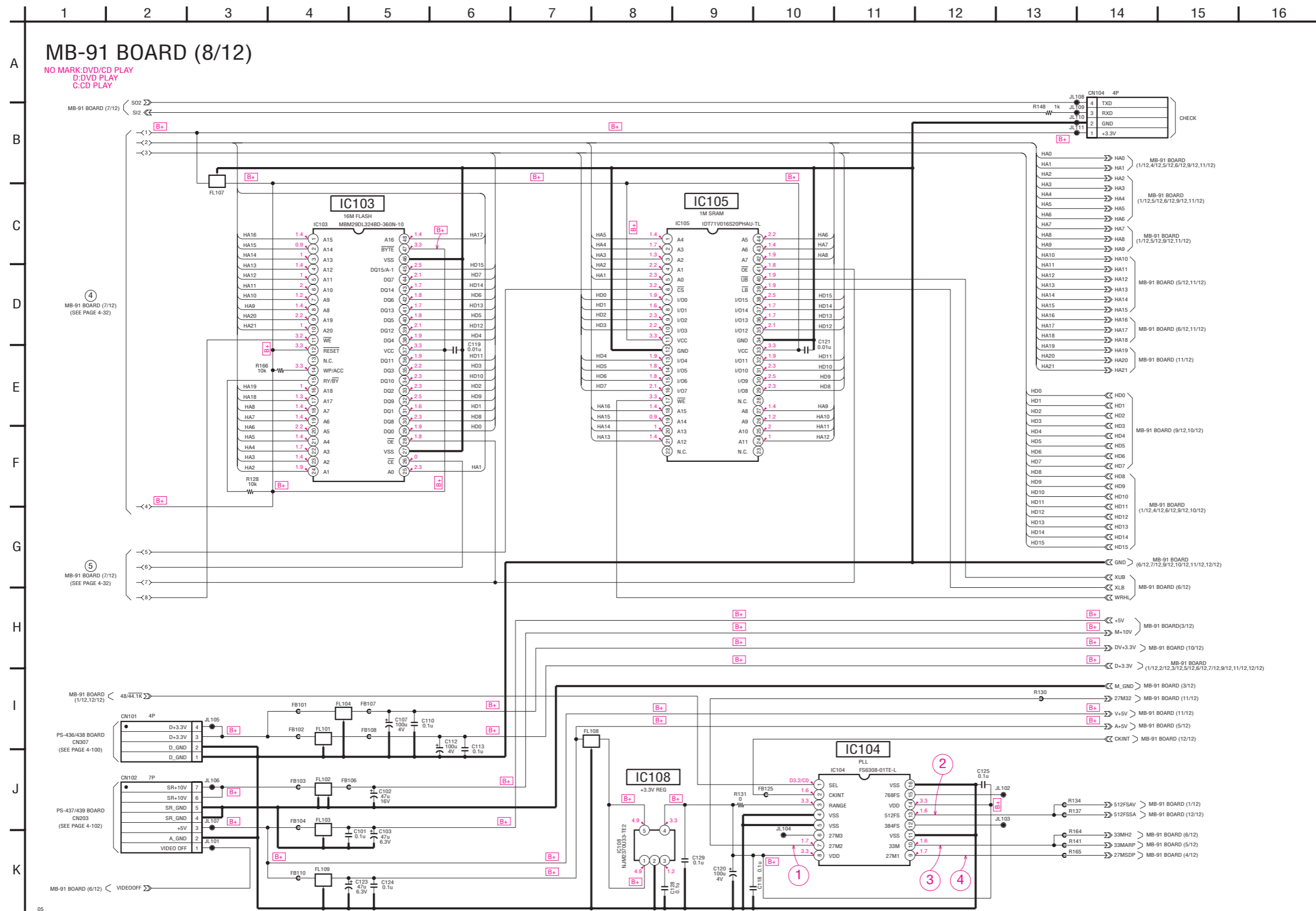

• Waveforms

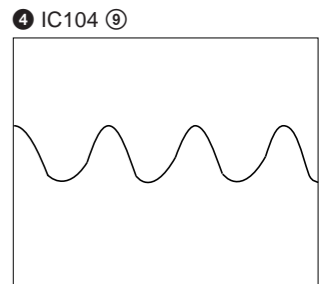
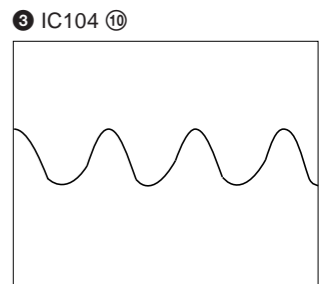
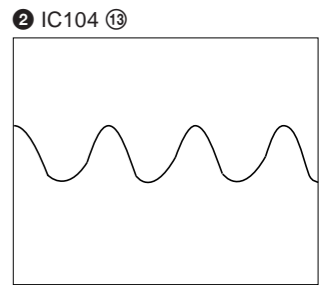
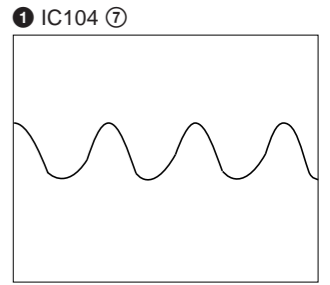



**MB-91 (MIP) SCHEMATIC DIAGRAM** • See page 4-15 for printed wiring board.

– Ref. No.: MB-91 board; 1,000 series –

• Waveforms

1 IC702 84, 100

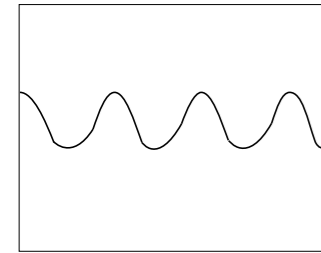

2 IC702 76

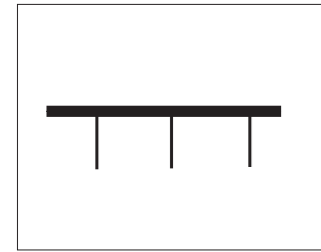

3 IC702 75

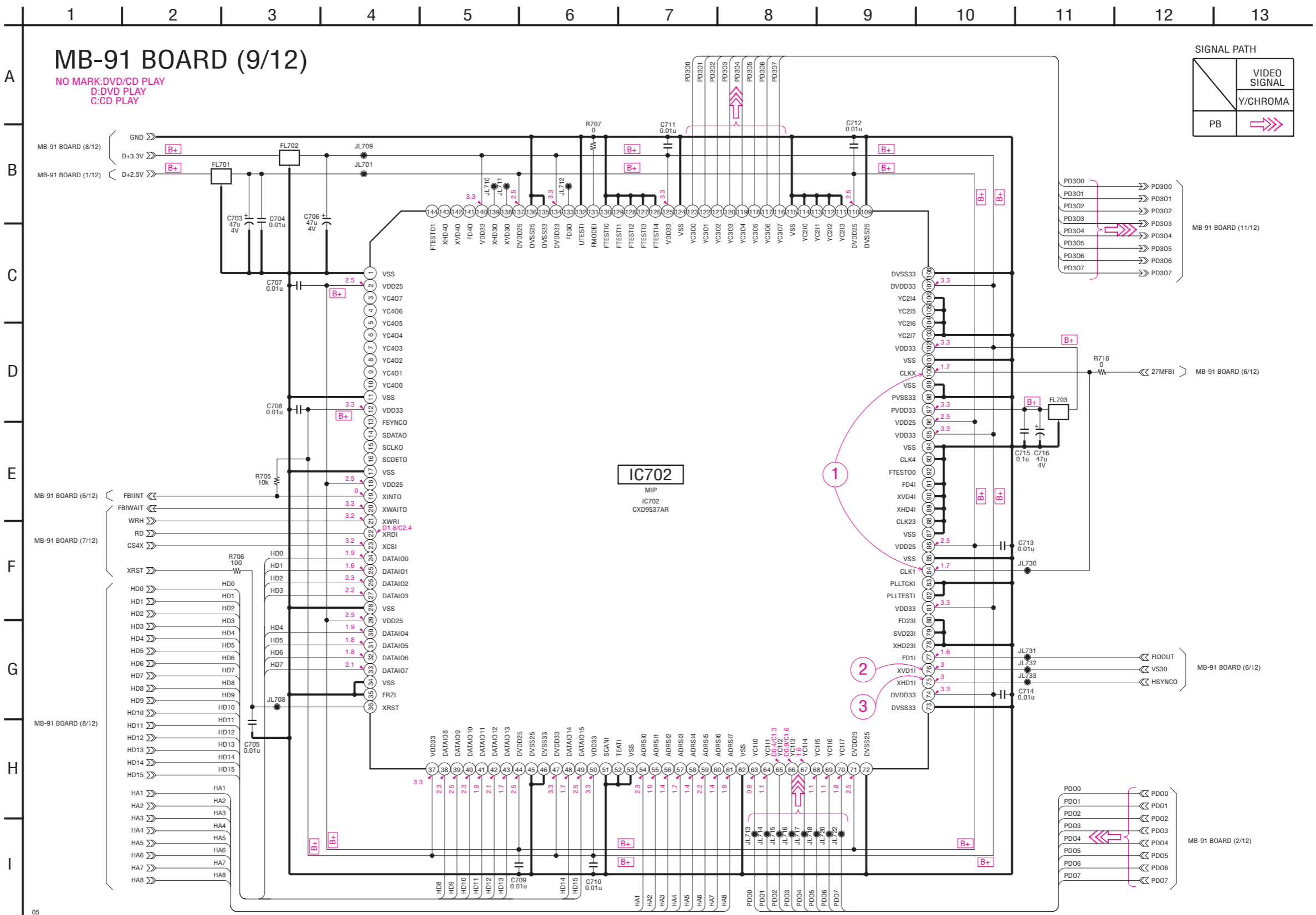
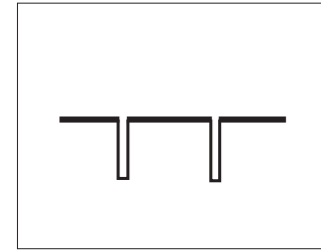

MB-91 (OSD) SCHEMATIC DIAGRAM • See page 4-15 for printed wiring board.

- Ref. No.: MB-91 board; 1,000 series -

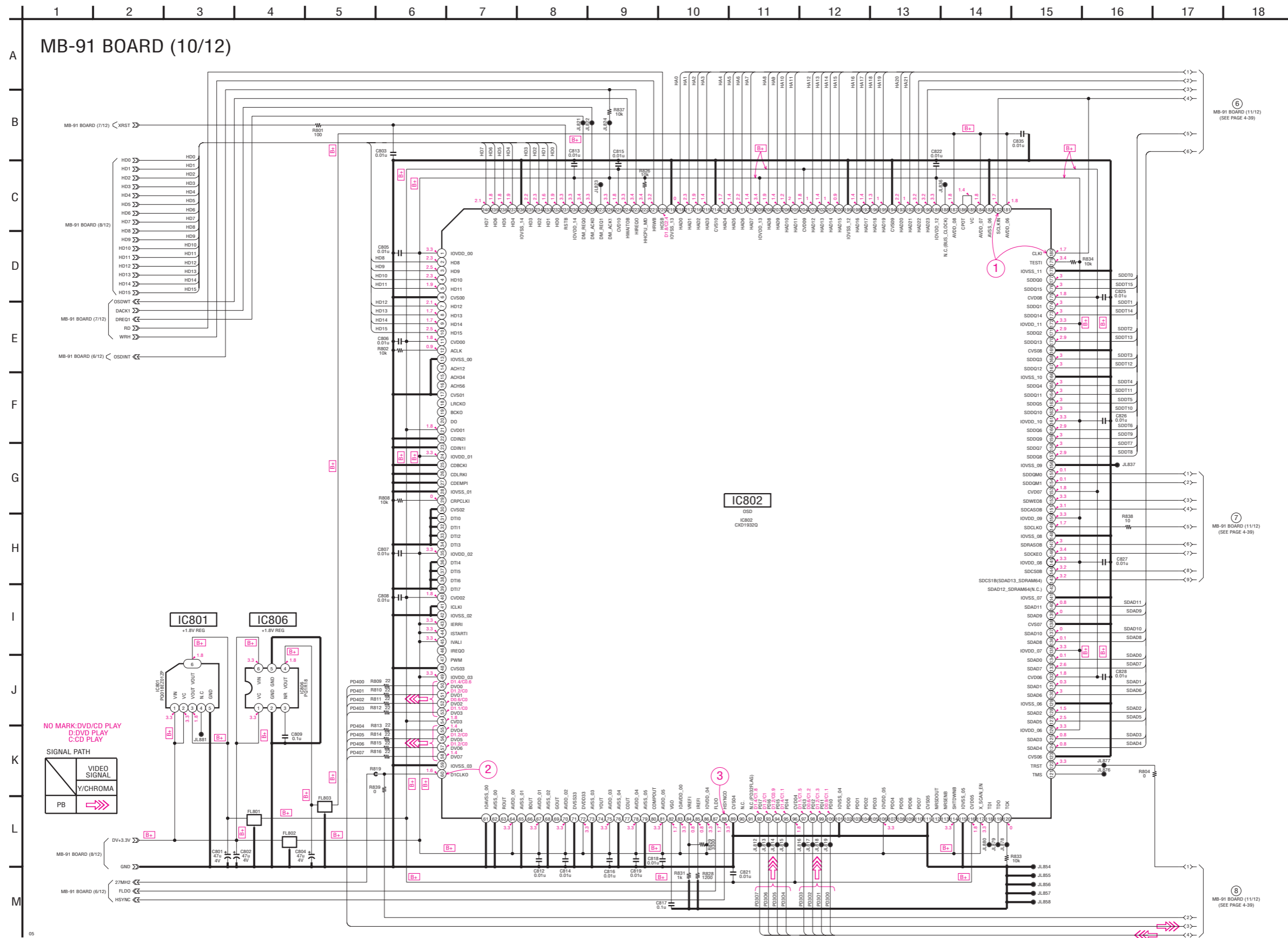

• Waveforms

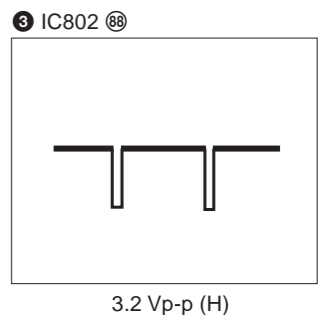
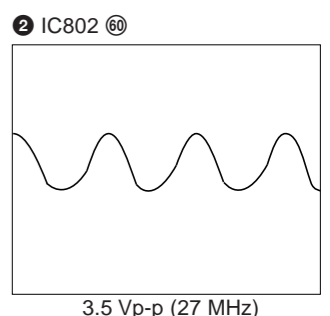
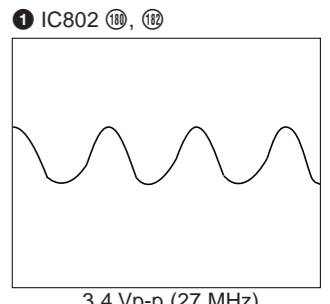

MB-91 (SDRAM) SCHEMATIC DIAGRAM • See page 4-15 for printed wiring board.

- Ref. No.: MB-91 board; 1,000 series -

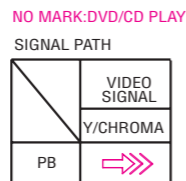
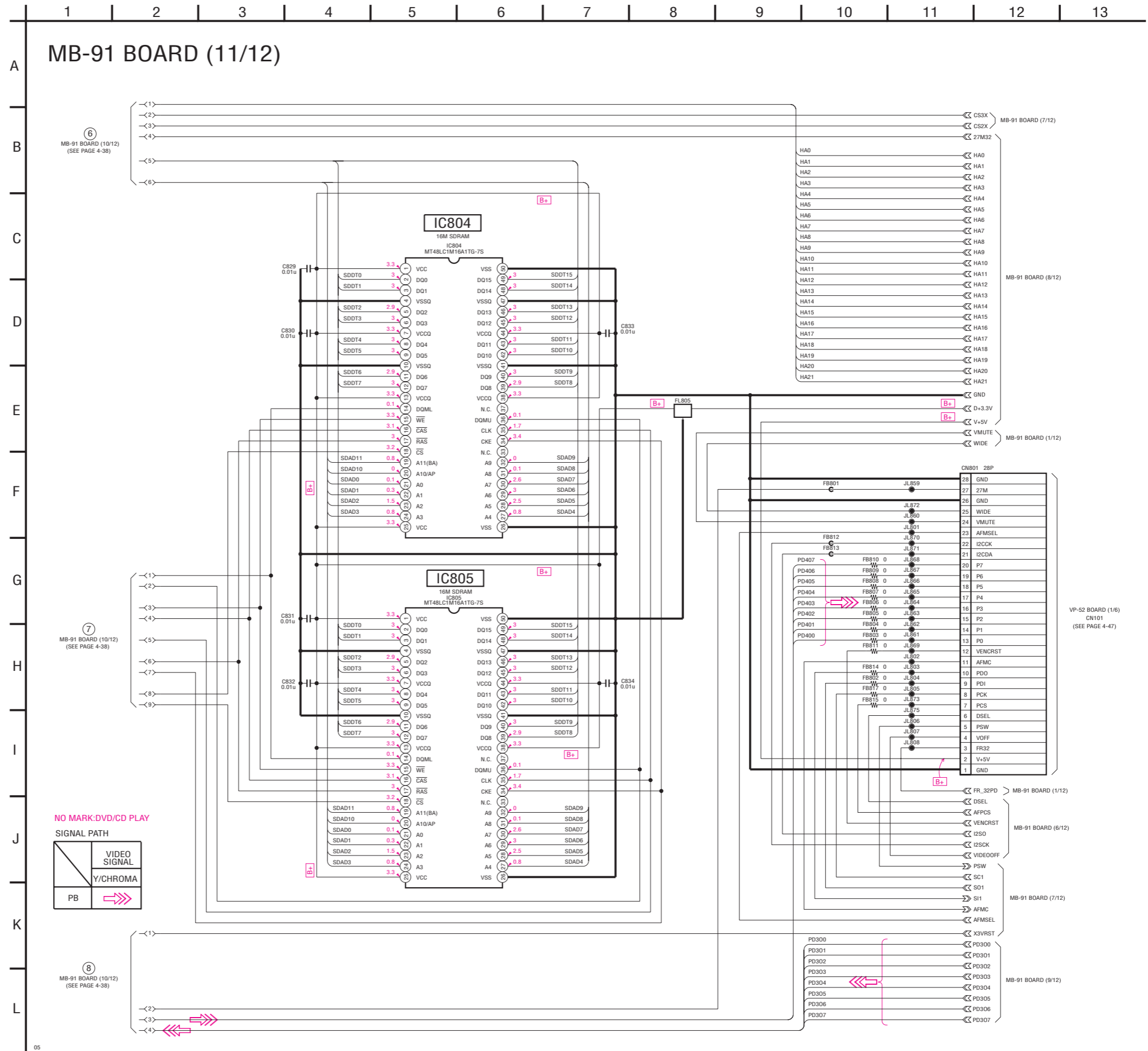



# MB-91 BOARD (12/12)

NO MARK-DVD/CD PLAY  
 D: DVD PLAY  
 C: CD PLAY  
 \*: IMPOSSIBLE TO MEASURE THE VOLTAGE AT THE MARKED POINTS.

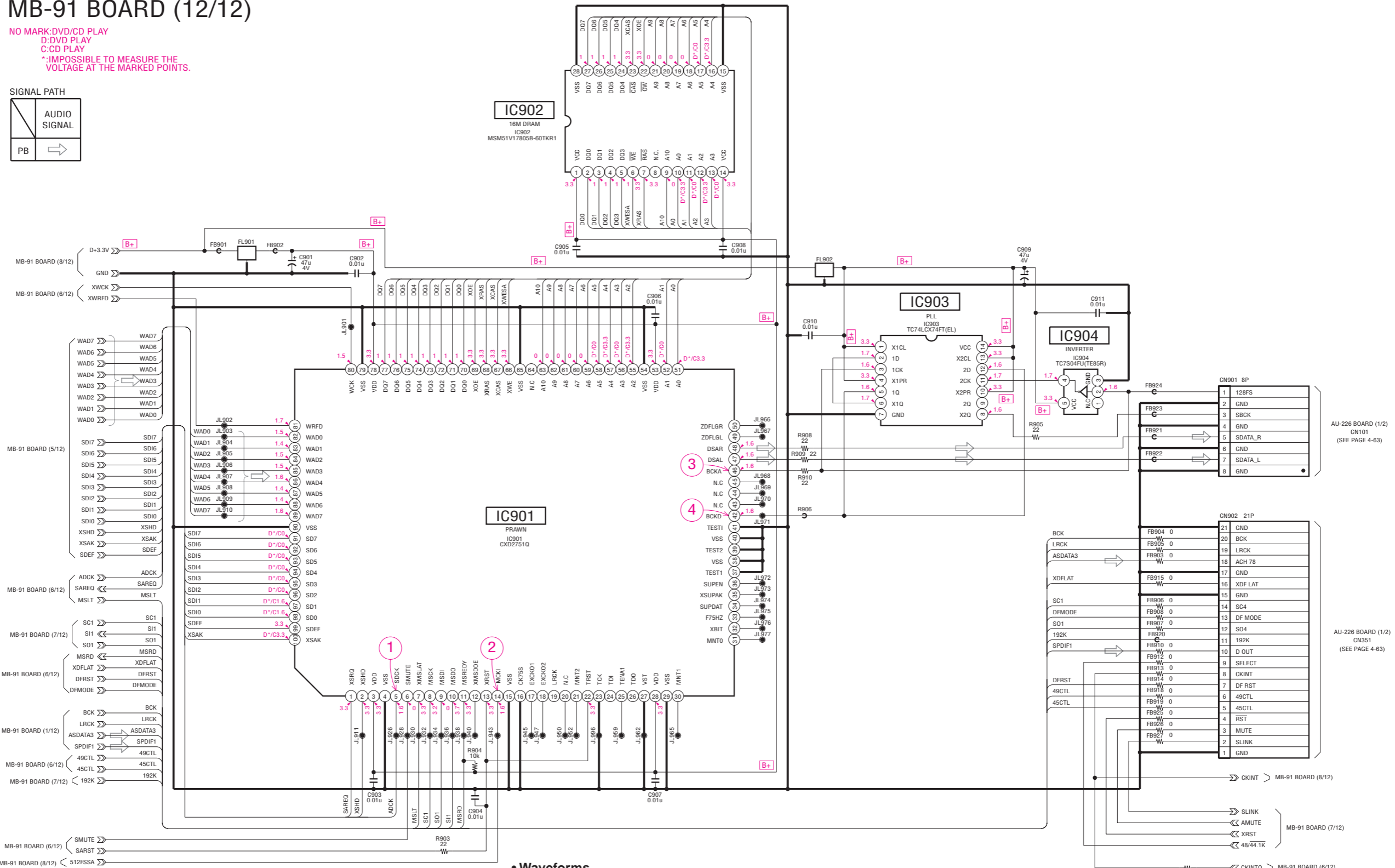
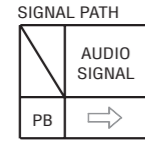

• Waveforms

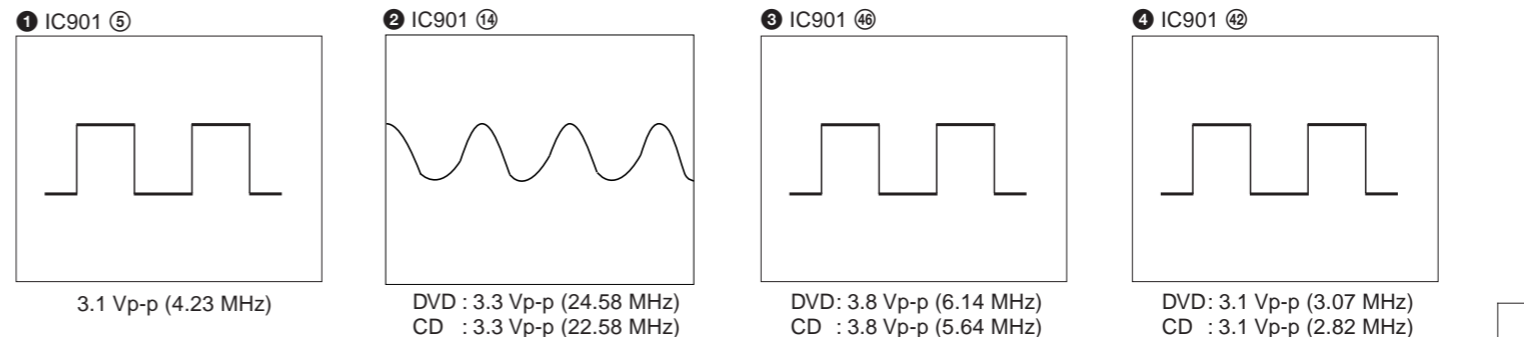

AU-226 BOARD (1/2)  
CN101  
(SEE PAGE 4-63)

AU-226 BOARD (1/2)  
CN351  
(SEE PAGE 4-63)

CKINT > MB-91 BOARD (8/12)  
 SLINK >>> MB-91 BOARD (7/12)  
 AMUTE <<< MB-91 BOARD (7/12)  
 XRST <<< MB-91 BOARD (7/12)  
 48/44.TK <<< MB-91 BOARD (6/12)  
 CKINT0 > MB-91 BOARD (6/12)

There are a few cases that the part isn't mounted in this model is printed on this diagram.

VP-52 BOARD (SIDE A)

VP-52 BOARD (SIDE A)

CN101	B-6	Q105	B-3
CN102	F-4	Q106	B-3
CN103	C-3	Q107	B-3
CN401	A-2	Q108	A-3
		Q109	A-3
D101	C-3	Q110	D-3
D102	C-3	Q111	C-3
D401	D-2	Q112	C-3
D402	C-2	Q113	B-3
D403	B-1	Q114	B-3
D404	B-1	Q115	A-3
D405	C-1	Q116	D-2
D406	B-1	Q117	C-2
		Q118	C-2
IC101	F-6	Q119	D-2
IC102	C-4	Q120	C-2
IC103	B-5	Q121	C-2
IC104	C-4	Q301	A-6
IC105	C-4	Q401	E-3
IC106	B-4	Q402	E-3
IC107	C-4	Q403	D-3
IC108	D-4	Q404	E-2
IC109	A-4	Q405	E-2
IC110	C-6	Q406	D-3
IC301	B-5	Q407	F-1
IC302	A-5	Q408	F-1
IC303	D-5	Q409	B-2
IC304	E-5	Q410	B-2
IC401	E-4	Q411	D-2
IC402	F-4	Q412	B-2
IC403	A-2	Q413	B-2
IC404	E-1	Q414	C-2
IC405	D-1	Q415	F-1
IC406	C-1	Q416	F-2
		Q417	E-2
Q101	A-6	Q418	D-2
Q102	A-6	Q419	D-2
Q103	A-6	Q420	C-2
Q104	B-3		

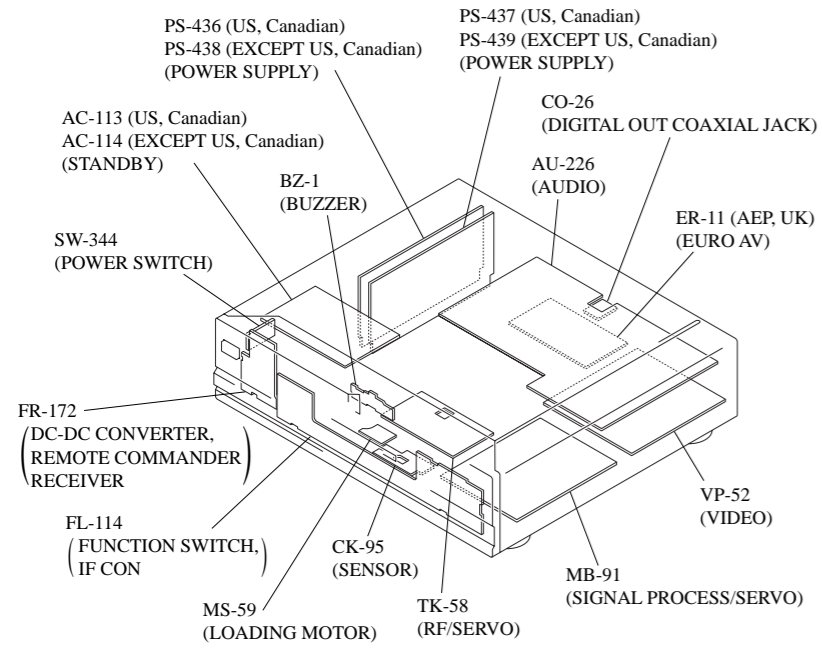
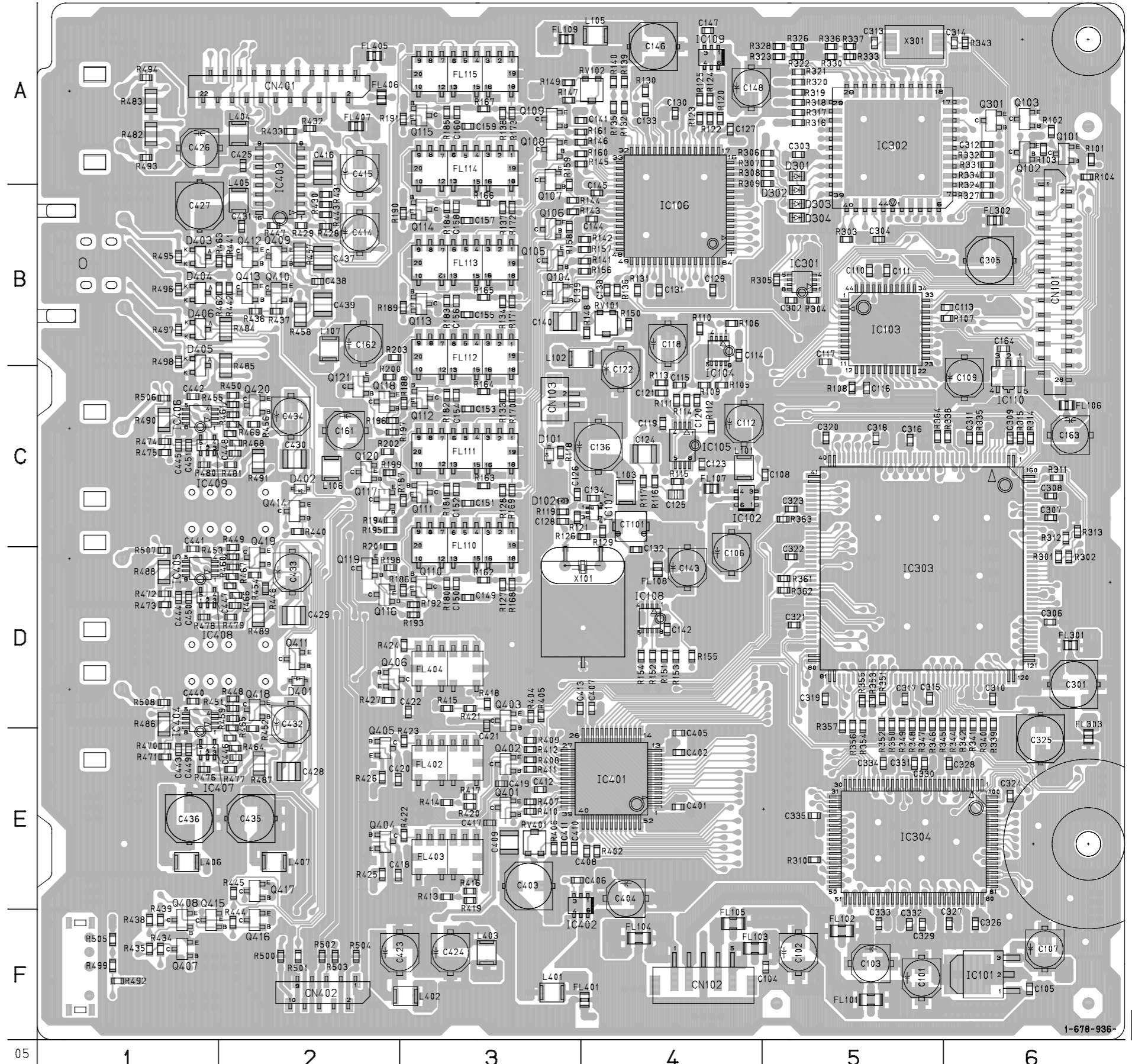

VP-52 BOARD(SIDE B)

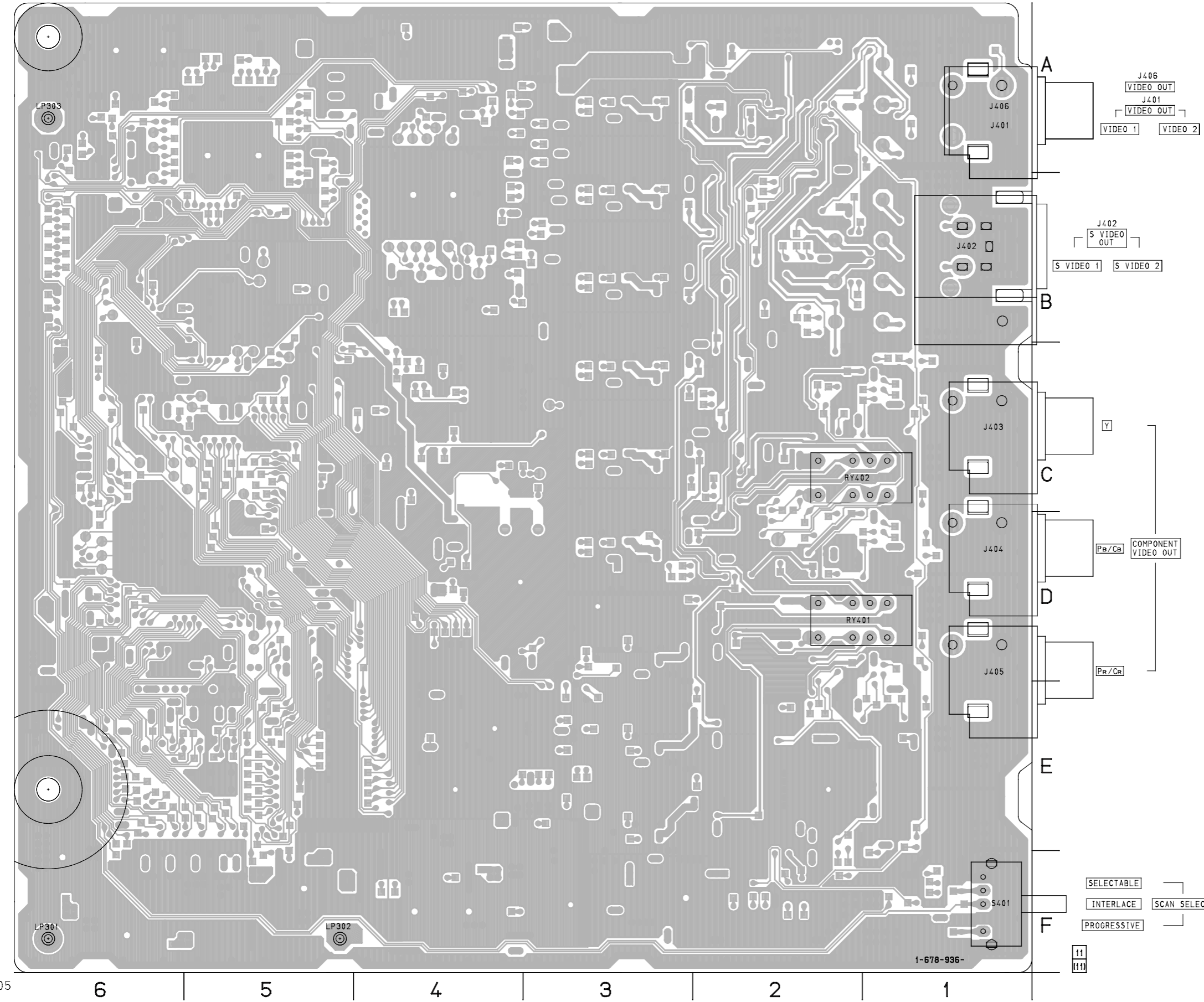

1-678-936-

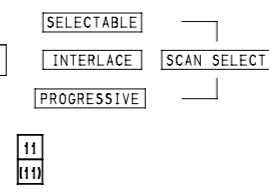

05

6

5

4

3

2

1

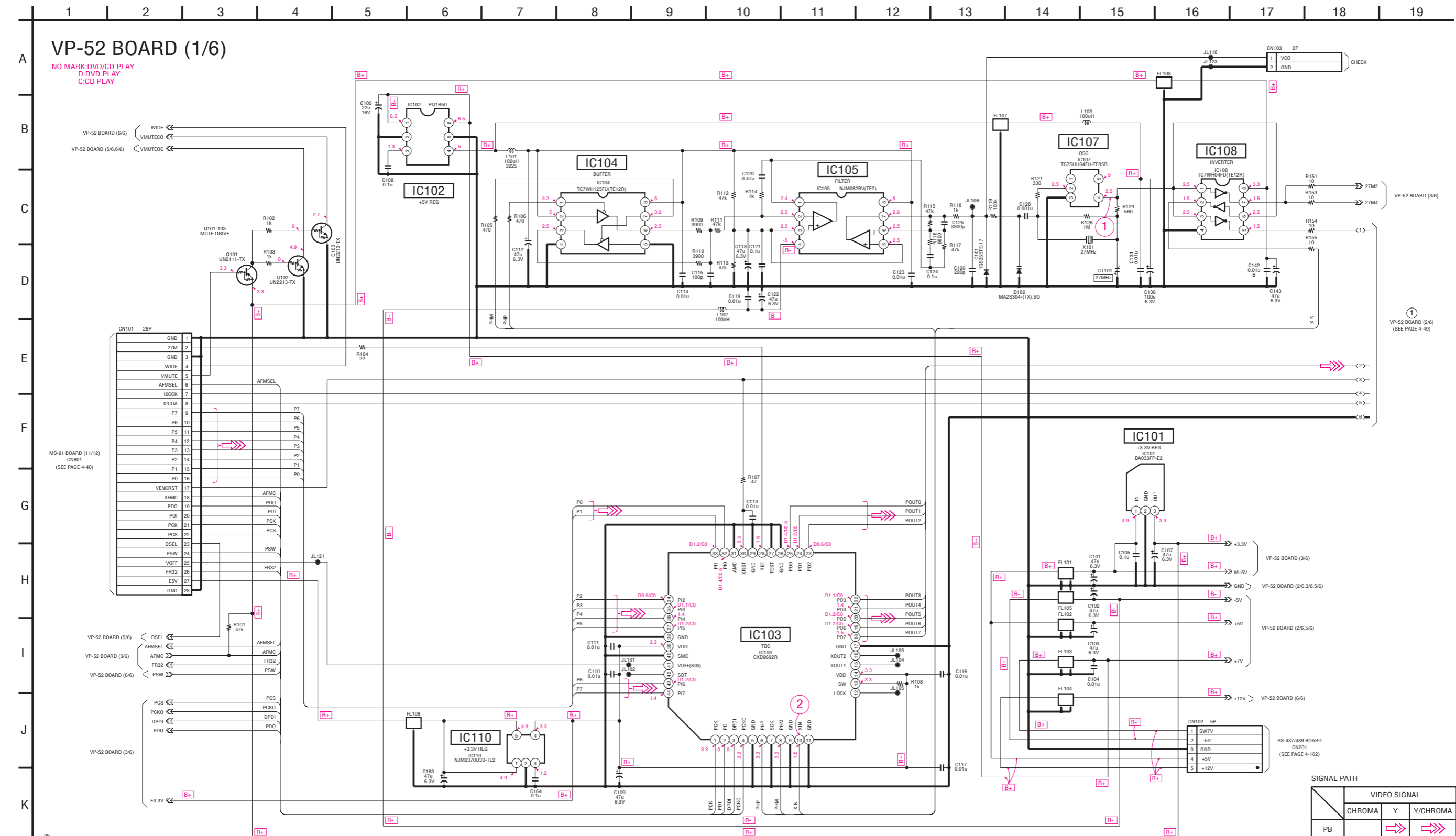

• Waveforms

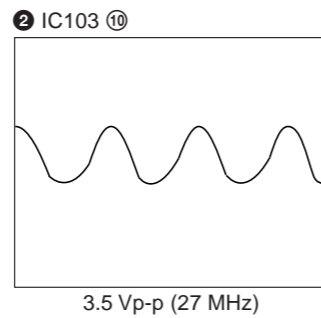
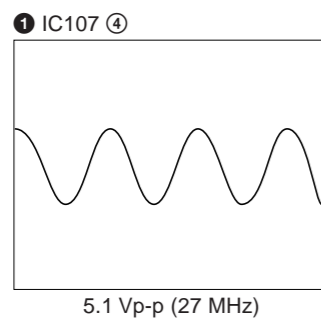

• Waveforms

VP-52 (VIDEO ENCODER) SCHEMATIC DIAGRAM • See page 4-43 for printed wiring board.

– Ref. No.: VP-52 board; 5,000 series –

① IC106 ⑤1

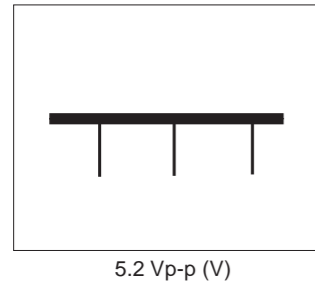

② IC106 ④5

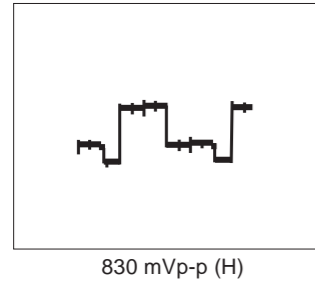

③ IC106 ④4

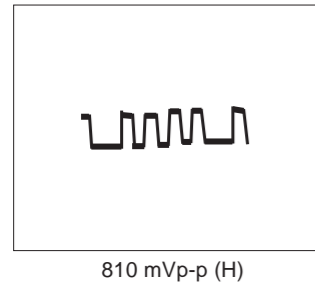

④ IC106 ④1

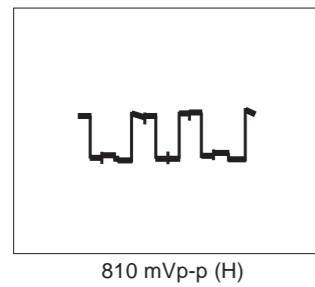

⑤ IC106 ④0

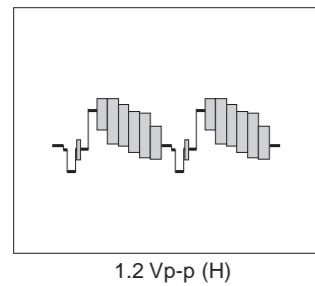

⑥ IC106 ③7

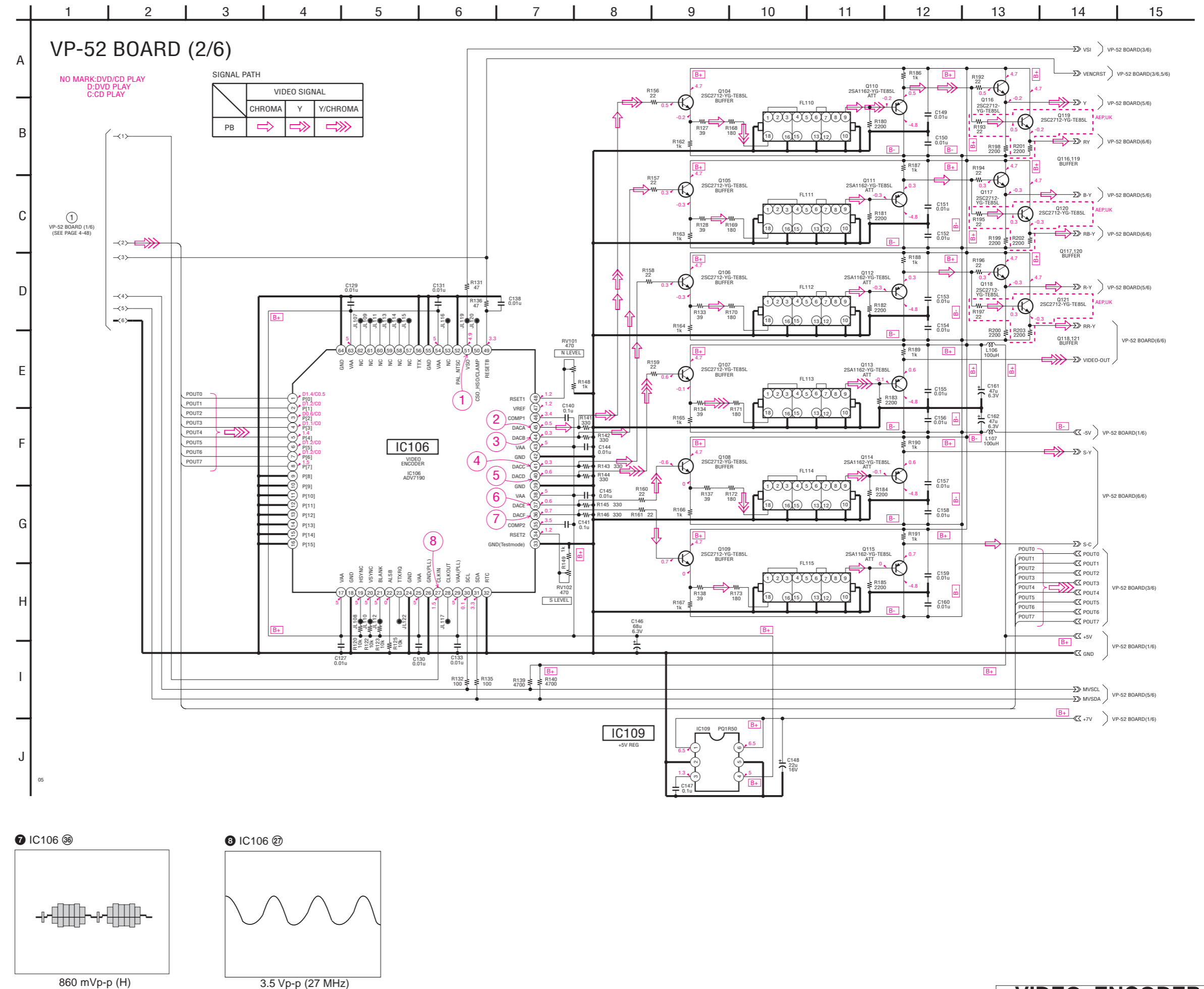
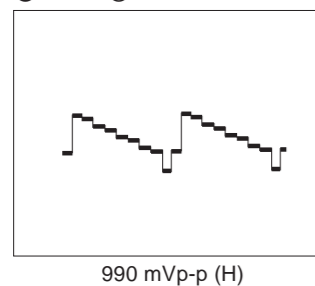



VP-52 (PROGRESSIVE) SCHEMATIC DIAGRAM • See page 4-43 for printed wiring board.

– Ref. No.: VP-52 board; 5,000 series –

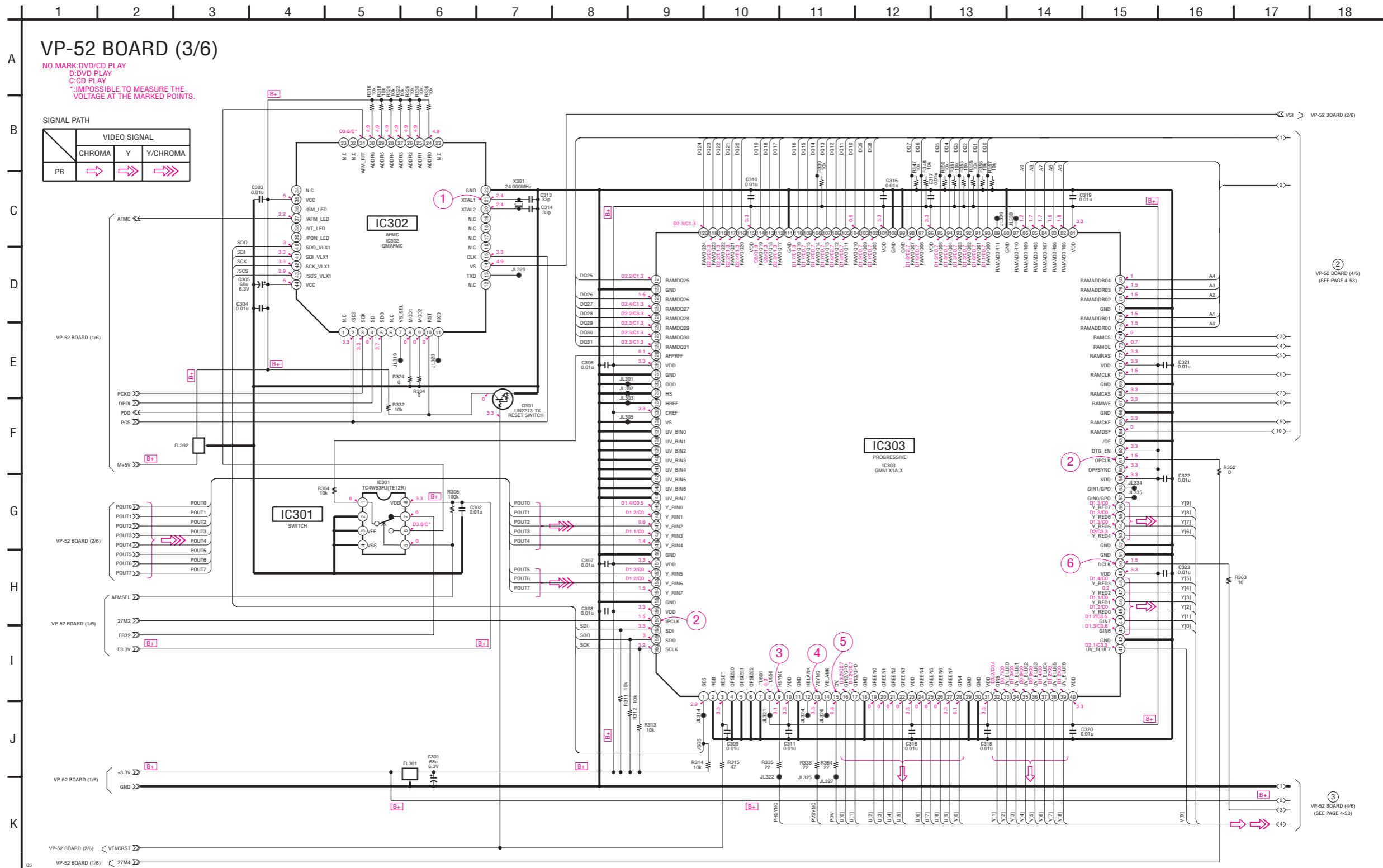

• Waveforms

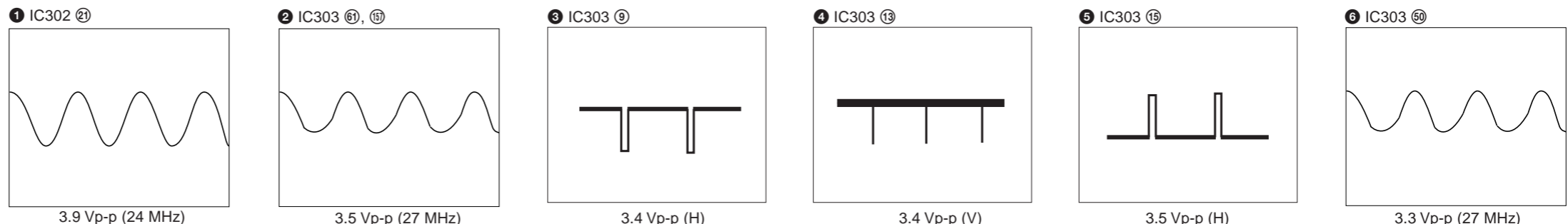

VP-52 (SGRAM) SCHEMATIC DIAGRAM • See page 4-43 for printed wiring board.

– Ref. No.: VP-52 board; 5,000 series –

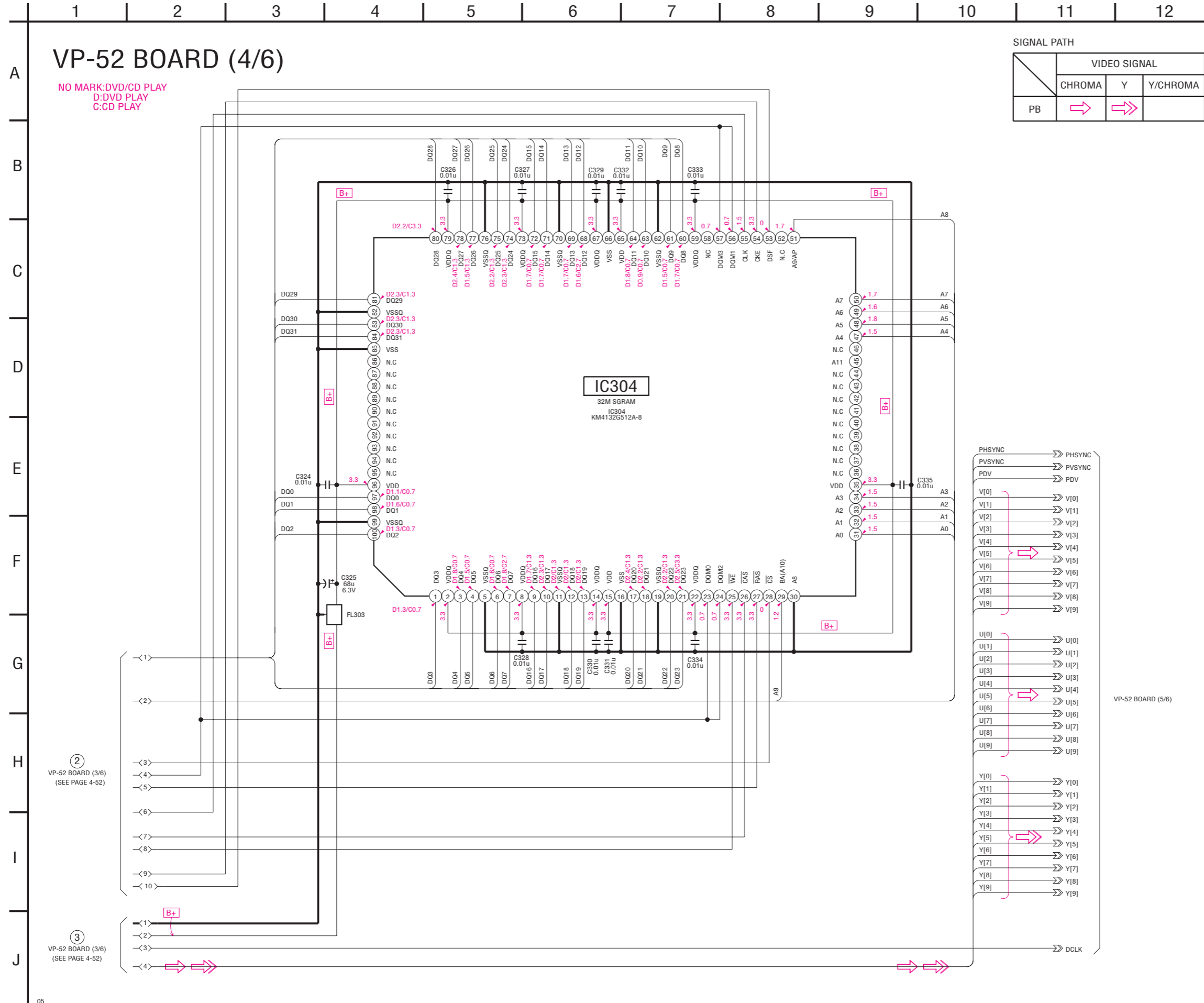

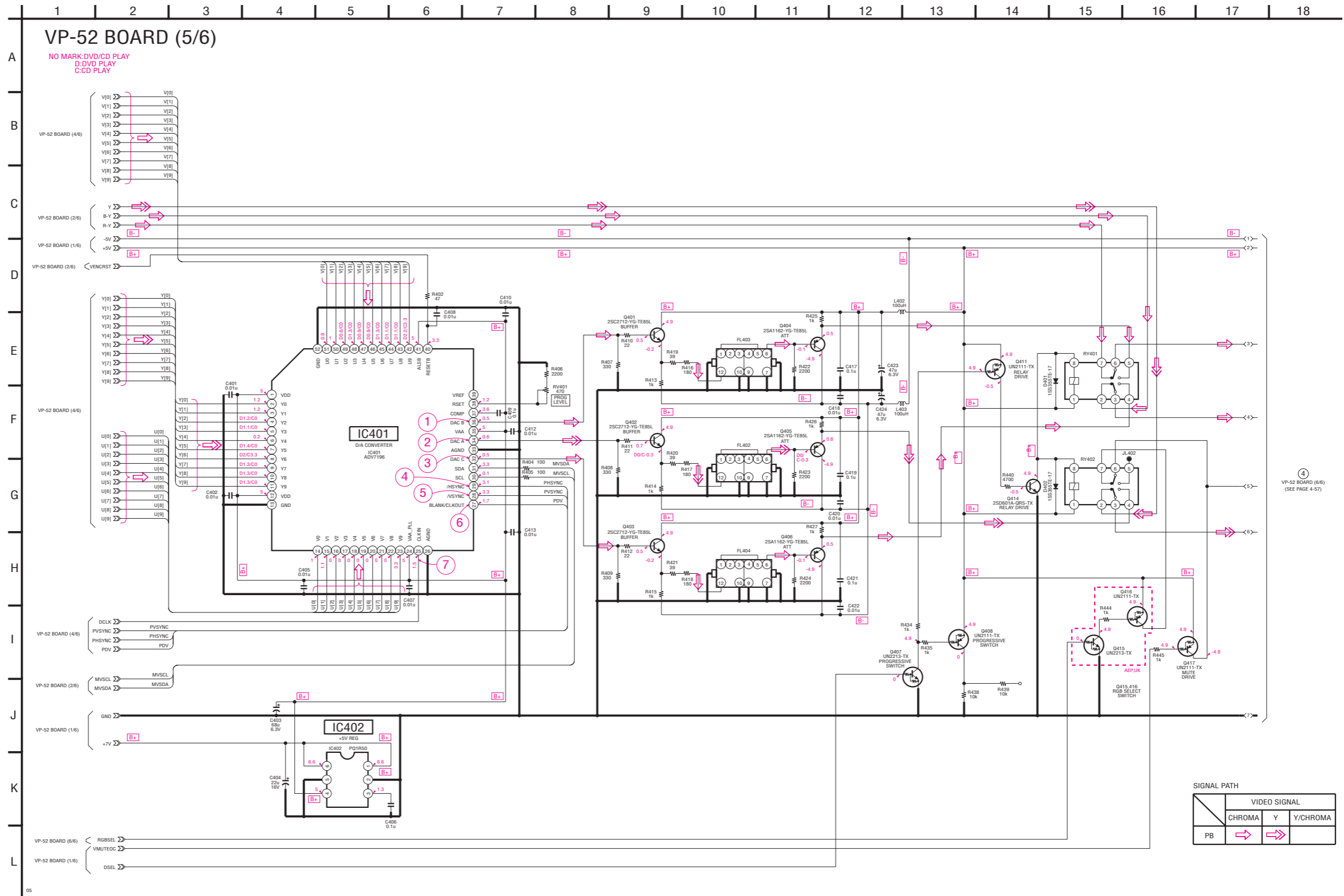

• Waveforms

1 IC401 36

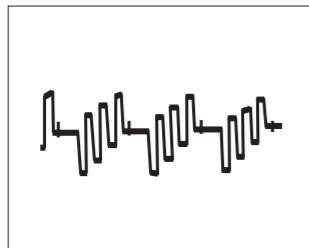

820 mVp-p (H)

2 IC401 34

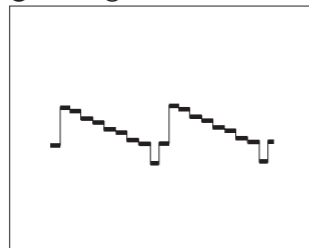

1.1 Vp-p (H)

3 IC401 32

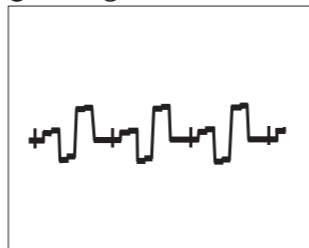

820 mVp-p (H)

4 IC401 29

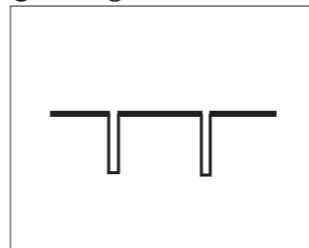

3.4 Vp-p (H)

5 IC401 26

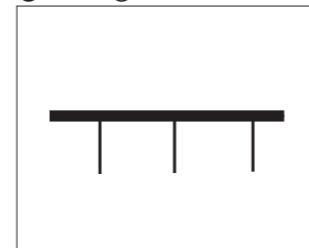

3.4 Vp-p (V)

6 IC401 27

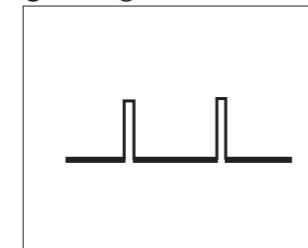

3.5 Vp-p (H)

7 IC401 25

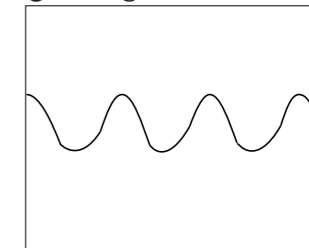

3.3 Vp-p (27 MHz)

VP-52 (VIDEO BUFFER) SCHEMATIC DIAGRAM • See page 4-43 for printed wiring board.

– Ref. No.: VP-52 board; 5,000 series –

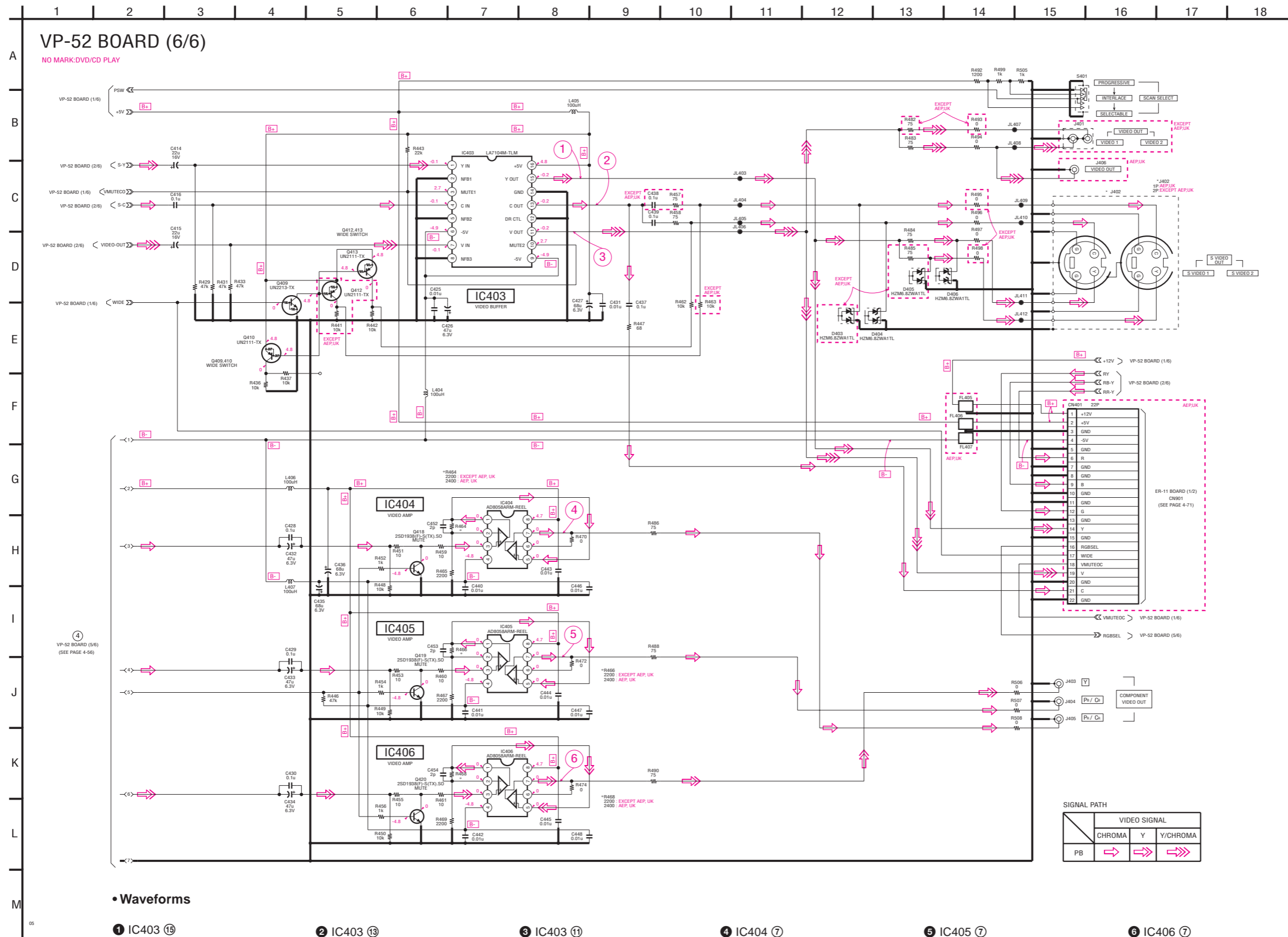

• Waveforms

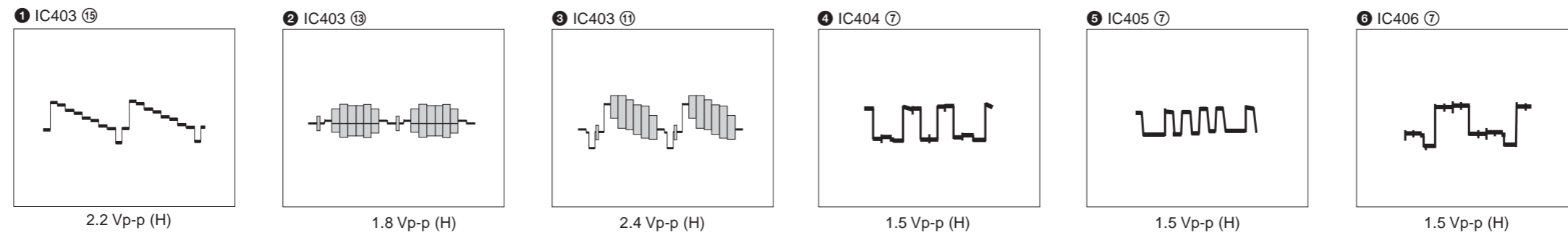

# DVP-S9000ES

## AU-226 (AUDIO), CO-26 (DIGITAL OUT COAXIAL JACK) PRINTED WIRING BOARDS

– Ref. No.: AU-226 board; 3,000 series, CO-26 board; 1,000 series –

There are a few cases that the part isn't mounted in this model is printed on this diagram.

### AU-226 BOARD (SIDE A)

- CN101 G-9
- CN103 A-7
- CN351 G-8
- CN353 B-4
  
- D101 G-9
- D102 C-9
- D103 C-10
- D104 A-9
- D302 A-7
  
- IC101 F-8
- IC102 F-7
- IC103 F-8
- IC104 F-8
- IC105 F-9
- IC352 B-6
- IC353 B-6
  
- Q101 F-10
- Q102 G-10
- Q103 A-9
- Q106 A-9
- Q301 D-5
- Q302 D-5

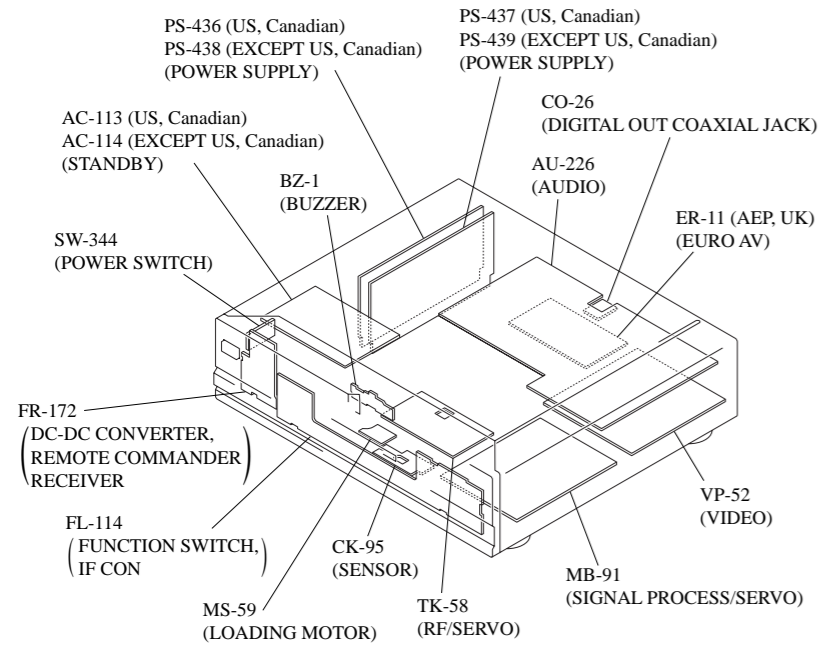
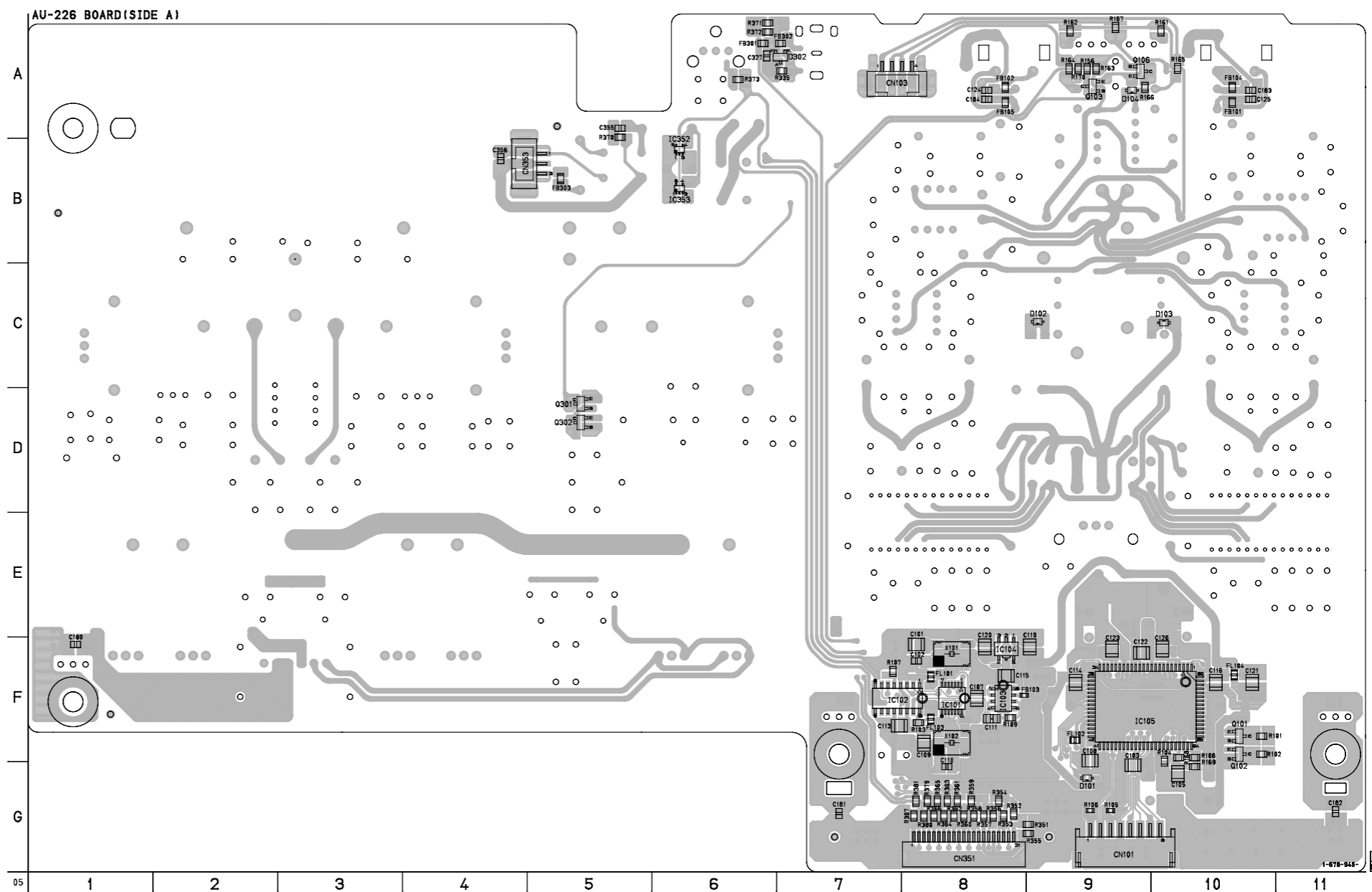

AU-226 BOARD (SIDE B)

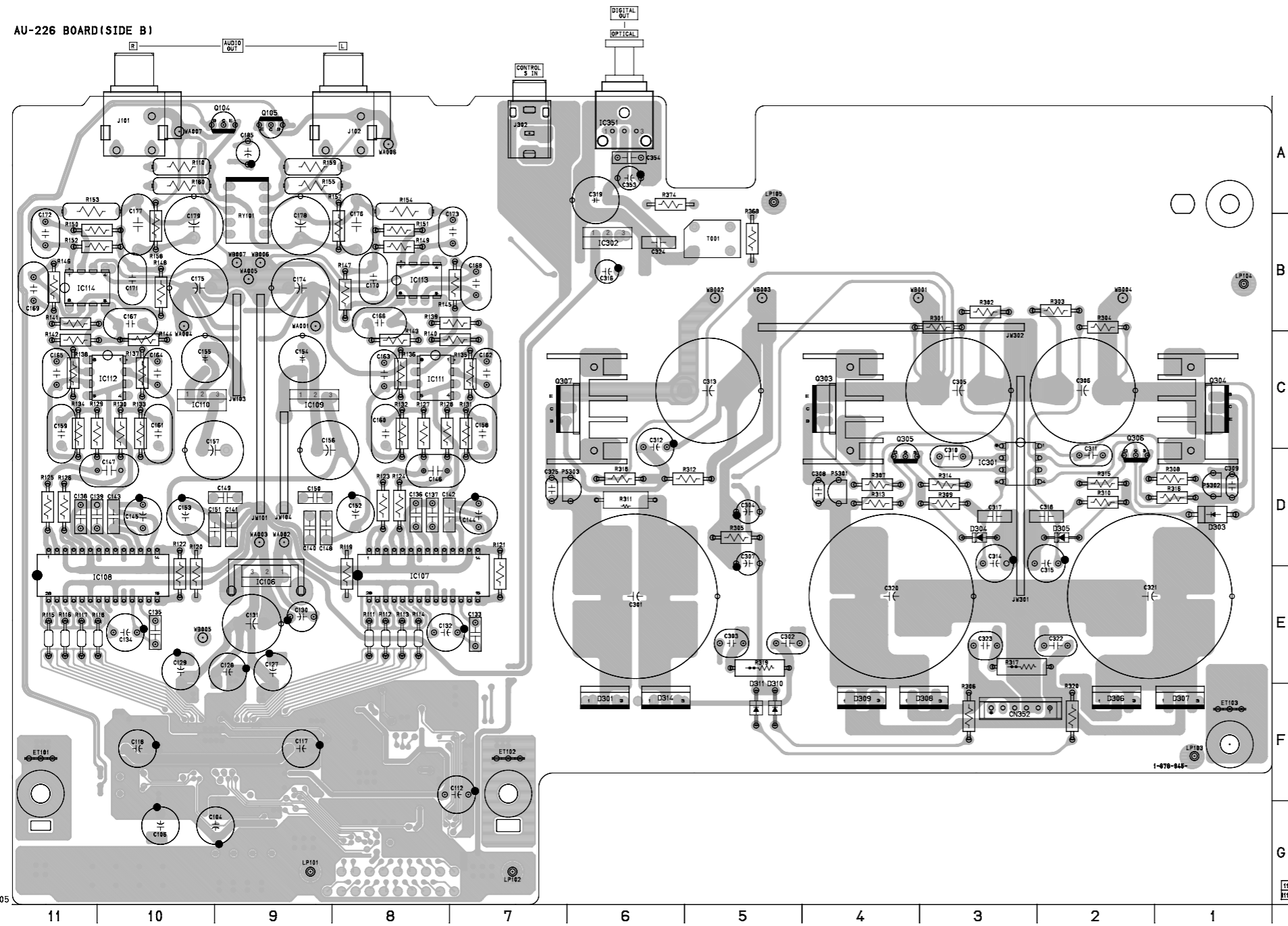

AU-226 BOARD (SIDE B)

- CN352 F-3
- D301 F-6
- D303 D-1
- D304 D-3
- D305 D-2
- D306 F-2
- D307 F-1
- D308 F-3
- D309 F-4
- D310 F-5
- D311 F-5
- D314 F-6
- IC106 E-9
- IC107 E-8
- IC108 E-10
- IC109 C-9
- IC110 C-10
- IC111 C-8
- IC112 C-10
- IC113 B-8
- IC114 B-11
- IC301 D-3
- IC302 B-6
- IC351 A-6
- Q104 A-10
- Q105 A-9
- Q303 C-4
- Q304 C-1
- Q305 D-4
- Q306 D-2
- Q307 C-7

CO-26 BOARD

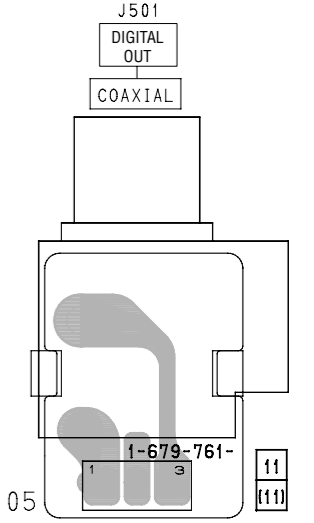

AU-226 (D/A CONVERTER, DIGITAL FILTER), CO-26 (DIGITAL OUT COAXIAL JACK) SCHEMATIC DIAGRAM • See page 4-59 for printed wiring board.

- Ref. No.: AU-226 board; 3,000 series, CO-26 board; 1,000 series -

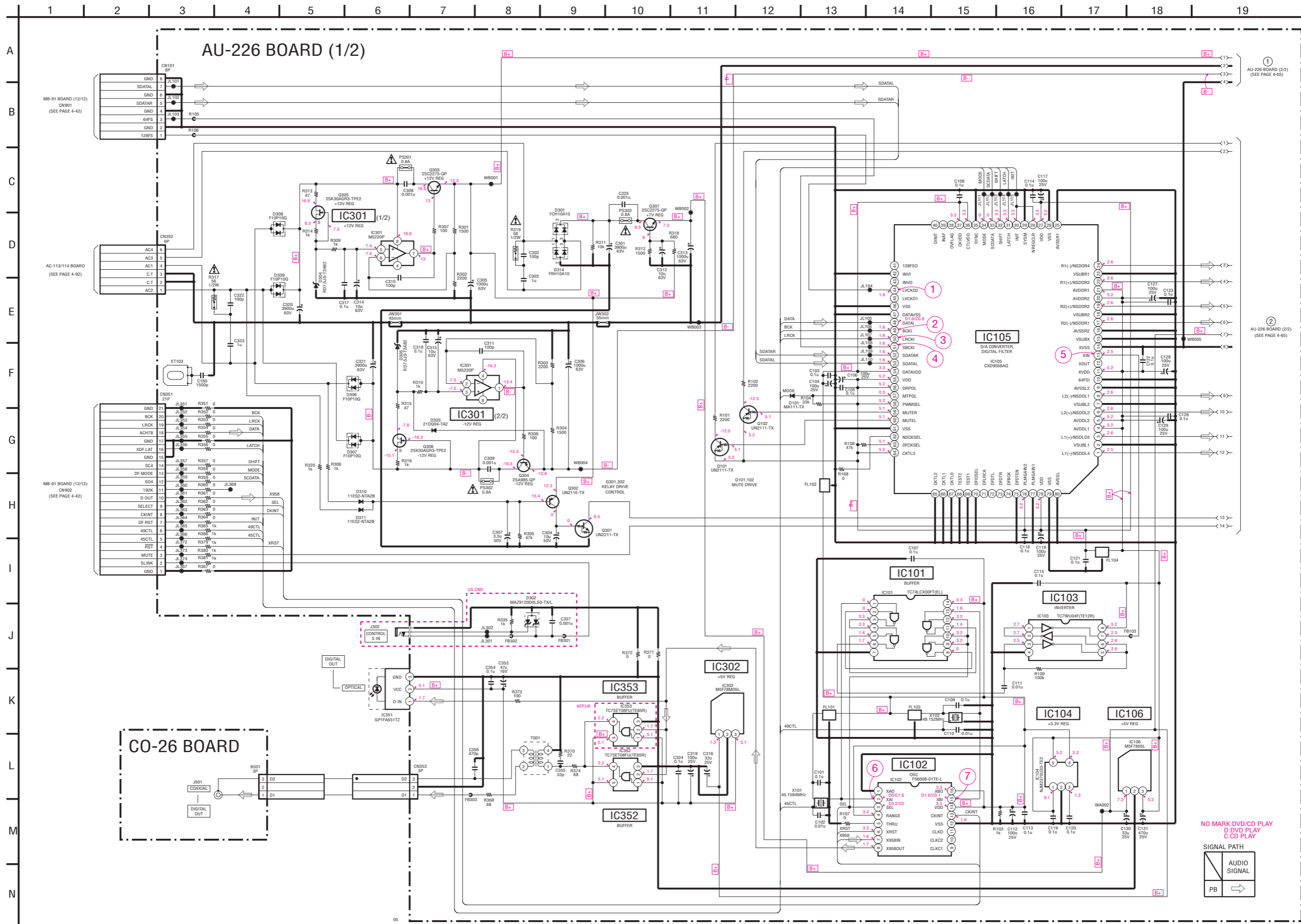

① AU-226 BOARD (2/2) (SEE PAGE 4-65)

② AU-226 BOARD (2/2) (SEE PAGE 4-65)

NO MARK/DVD/CD PLAY  
D-DVD PLAY  
C-CD PLAY

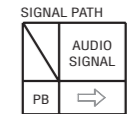

**AU-226 (CURRENT PULSE D/A, AMP) SCHEMATIC DIAGRAM • See page 4-59 for printed wiring board.**

– Ref. No.: AU-226 board; 3,000 series –

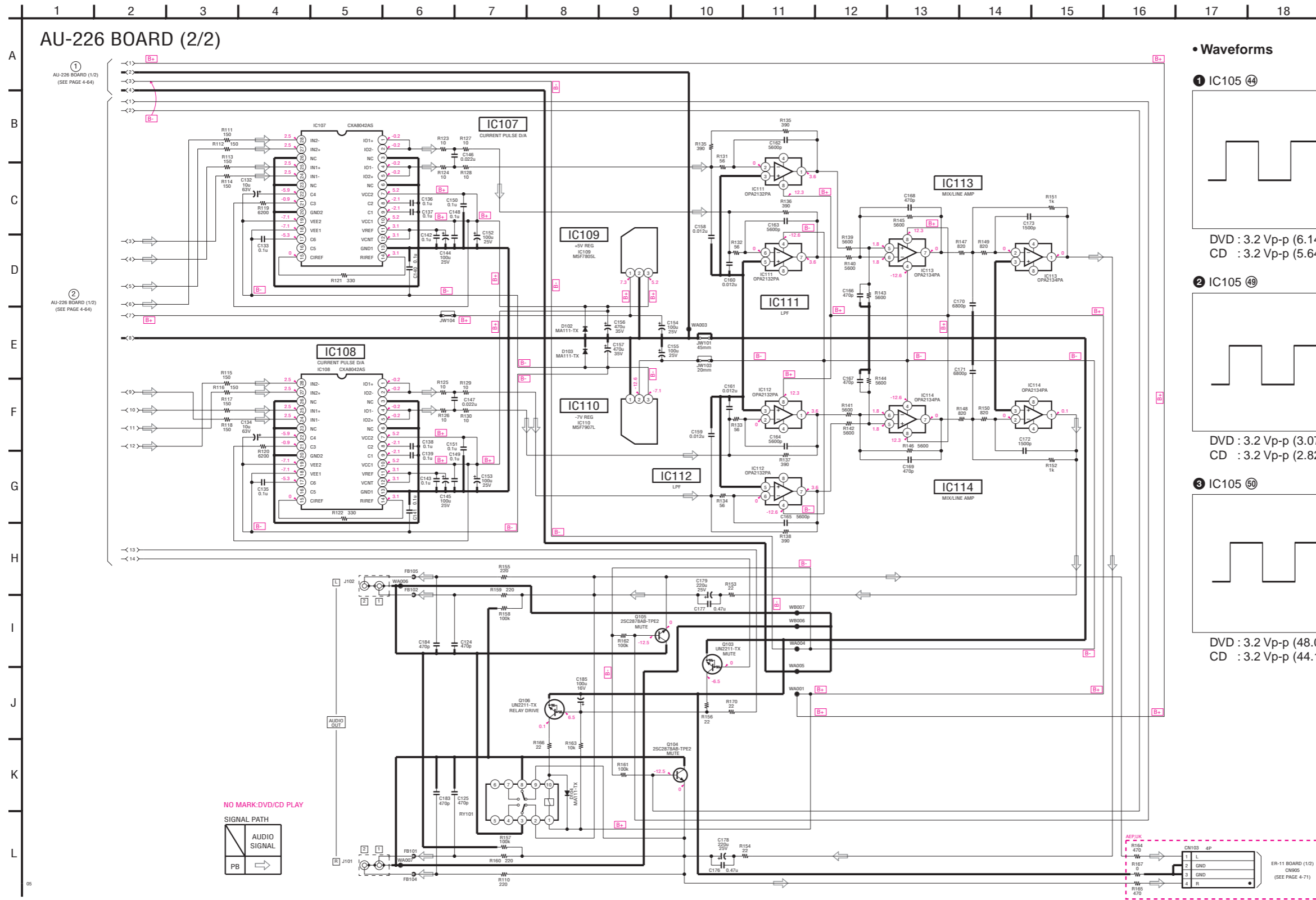

• Waveforms

1 IC105 ④④

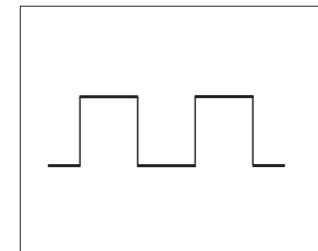

DVD : 3.2 Vp-p (6.14 MHz)  
 CD : 3.2 Vp-p (5.64 MHz)

4 IC105 ⑤①

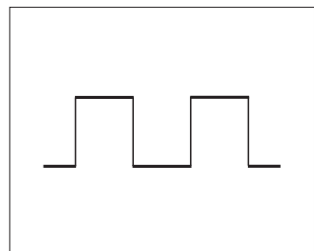

DVD : 3.2 Vp-p (3.07 MHz)  
 CD : 3.2 Vp-p (2.82 MHz)

2 IC105 ④⑨

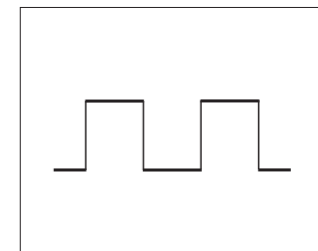

DVD : 3.2 Vp-p (3.07 MHz)  
 CD : 3.2 Vp-p (2.82 MHz)

5 IC105 ⑬③

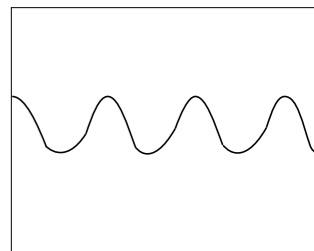

DVD : 4.9 Vp-p (49.15 MHz)  
 CD : 5.1 Vp-p (45.16 MHz)

3 IC105 ⑥⑩

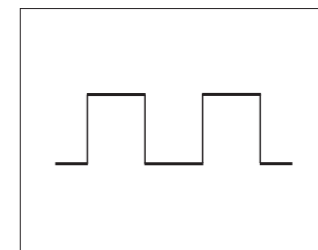

DVD : 3.2 Vp-p (48.0 kHz)  
 CD : 3.2 Vp-p (44.1 kHz)

6 IC102 ② (CD play)

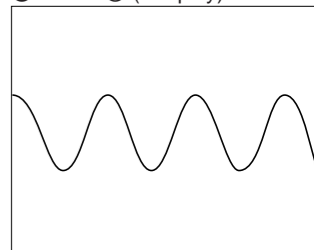

4.4 Vp-p (45.16 MHz)

7 IC102 ⑮ (DVD play)

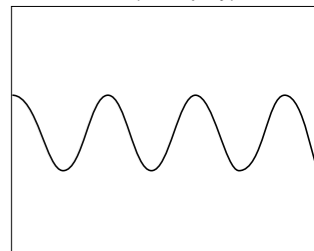

4.4 Vp-p (49.15 MHz)

**Note:**  
 The components identified by mark  $\Delta$  or dotted line with mark  $\Delta$  are critical for safety.  
 Replace only with part number specified.

**Note:**  
 Les composants identifiés par une marque  $\Delta$  sont critiques pour la sécurité.  
 Ne les remplacer que par une pièce portant le numéro spécifié.



**DVP-S9000ES**

**ER-11 (EURO AV) PRINTED WIRING BOARD**

– Ref. No.: ER-11 board; 2,000 series –

There are a few cases that the part isn't mounted in this model is printed on this diagram.

– AEP, UK –

**ER-11 BOARD (SIDE A)**

ER-11 BOARD (SIDE A)

CN901	C-5
CN905	C-2
CN906	C-2
D901	B-2
D907	C-5
D909	C-5
D911	C-5
IC901	B-4
IC902	B-5
IC903	B-5
Q901	C-2
Q902	C-2
Q903	B-2
Q904	B-2
Q906	C-3
Q907	C-4
Q908	C-4
Q909	C-3
Q910	C-3
Q912	B-3
Q913	A-2
Q914	B-3
Q915	B-1
Q916	A-1

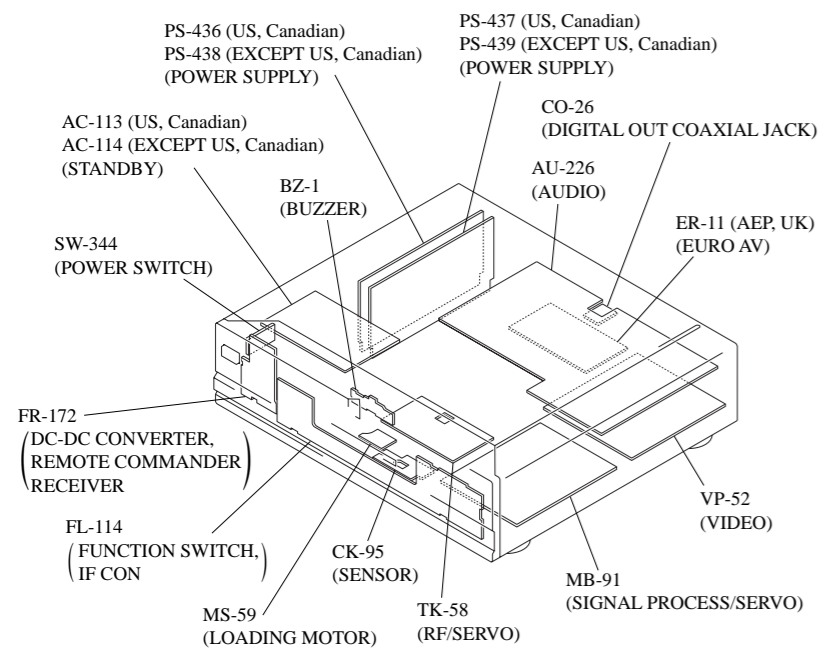
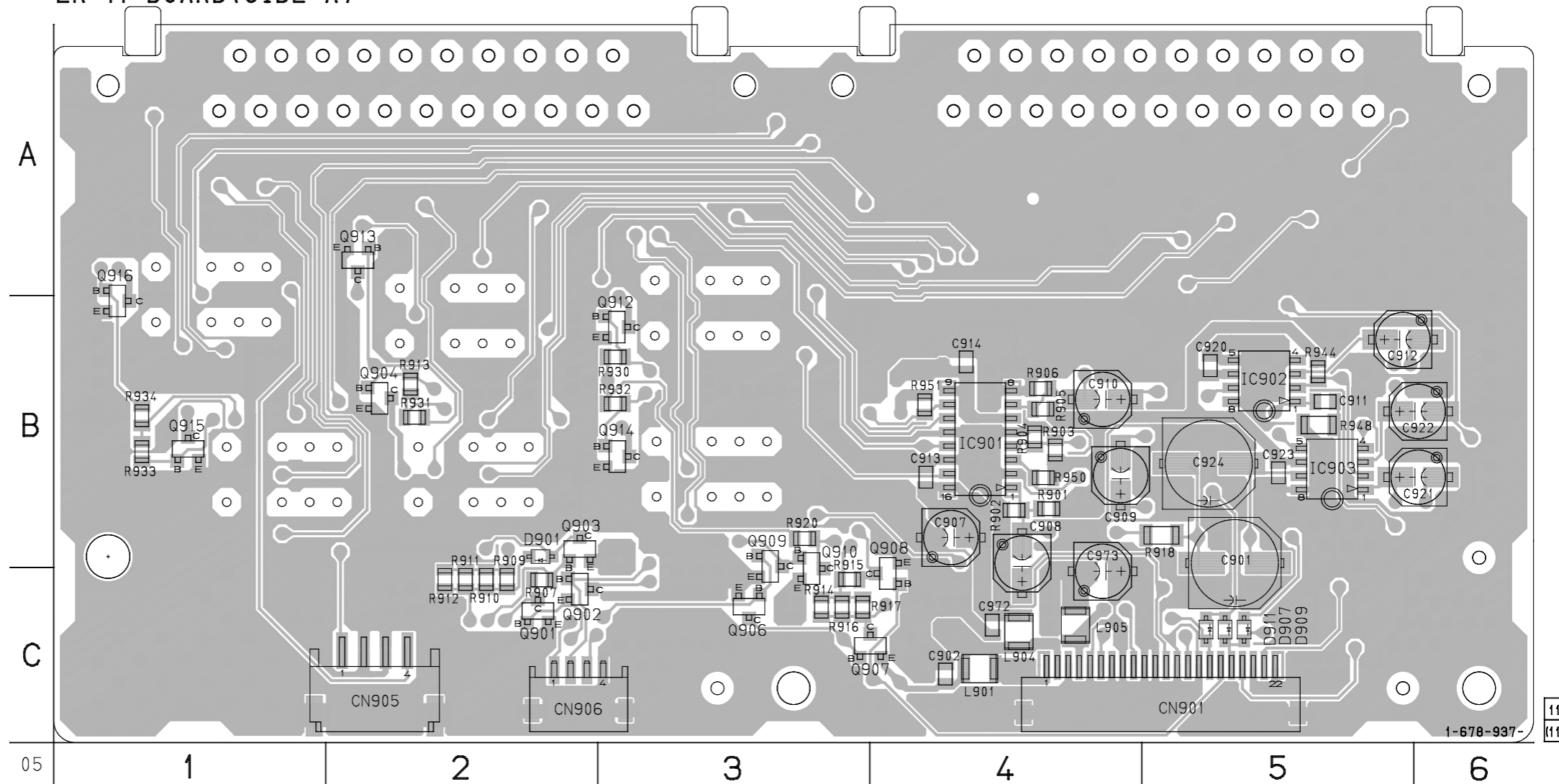

ER-11 BOARD(SIDE B)

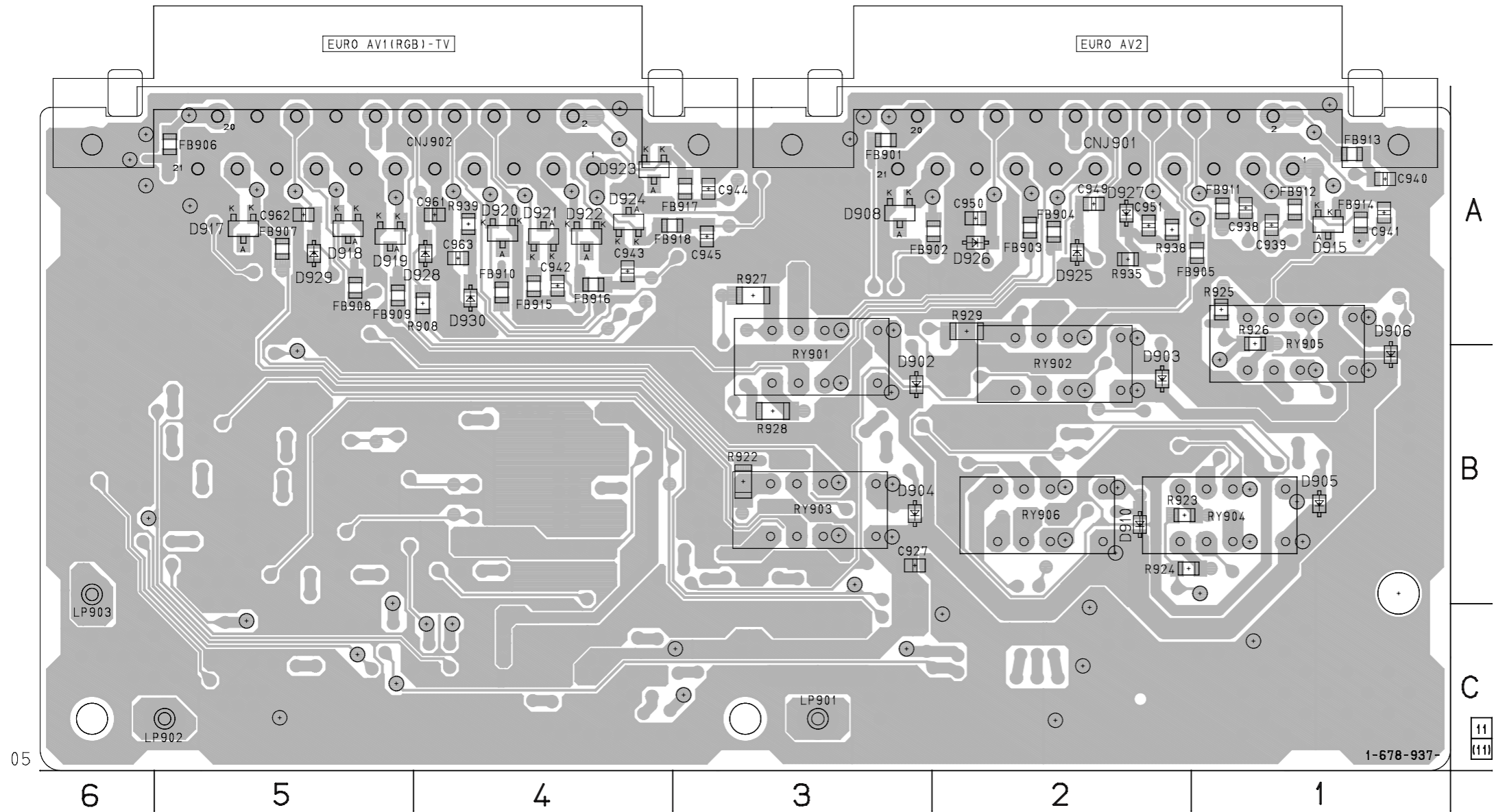

ER-11 BOARD (SIDE B)

- D902 B-3
- D903 B-2
- D904 B-3
- D905 B-1
- D906 B-1
- D908 A-3
- D910 B-2
- D915 A-1
- D917 A-5
- D918 A-5
- D919 A-5
- D920 A-4
- D921 A-4
- D922 A-4
- D923 A-4
- D924 A-4
- D926 A-2
- D927 A-2
- D929 A-5
- D930 A-4

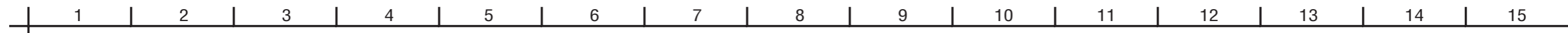

# ER-11 BOARD (1/2)

NO MARK: DVD/CD PLAY

SIGNAL PATH

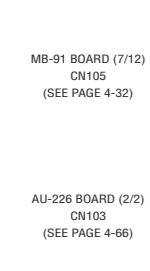
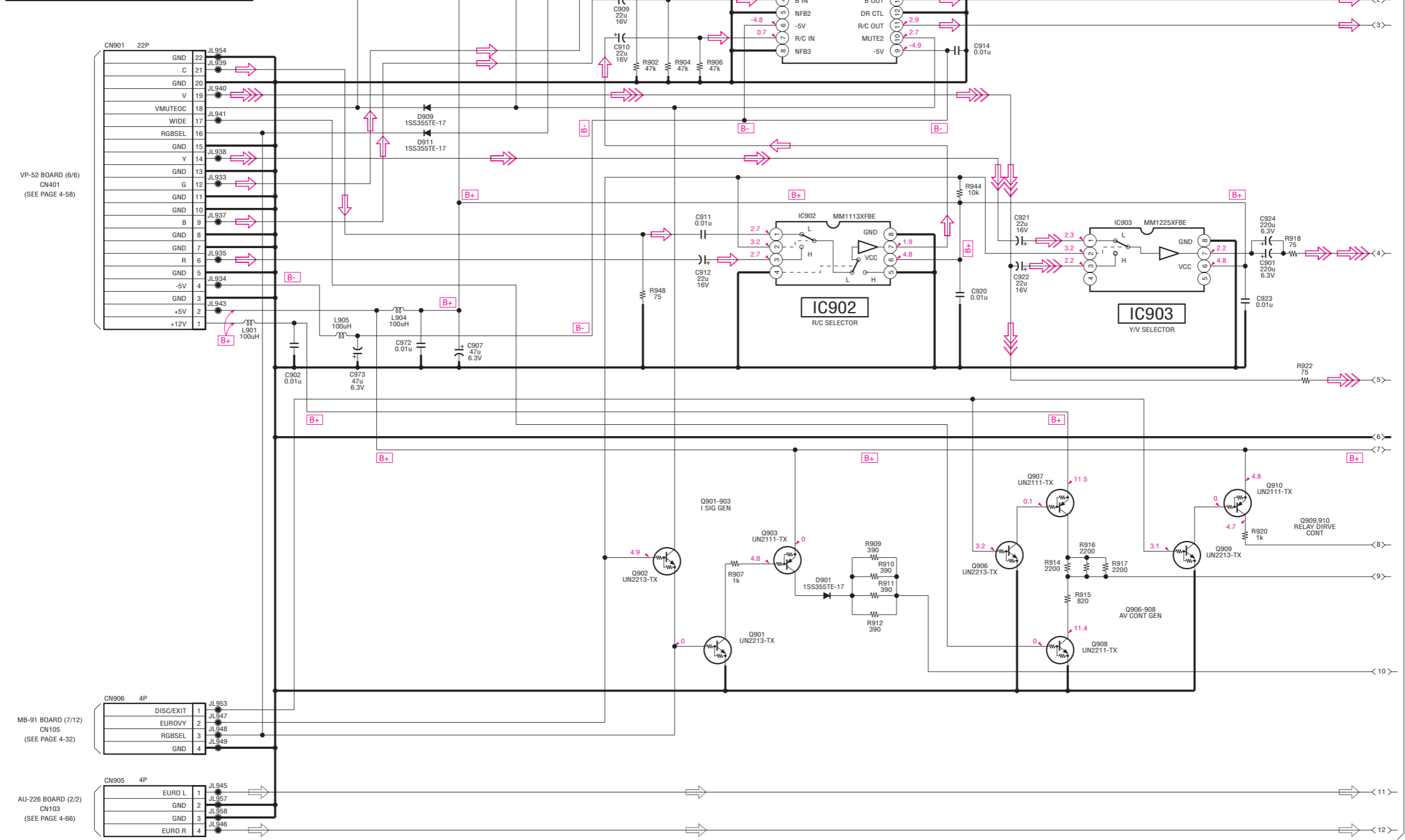
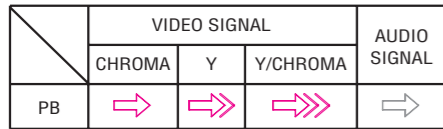

1 ER-11 BOARD (2/2)  
(SEE PAGE 4-73)

ER-11 (EURO AV2) SCHEMATIC DIAGRAM • See page 4-67 for printed wiring board.

– Ref. No.: ER-11 board; 2,000 series –

– AEP, UK –

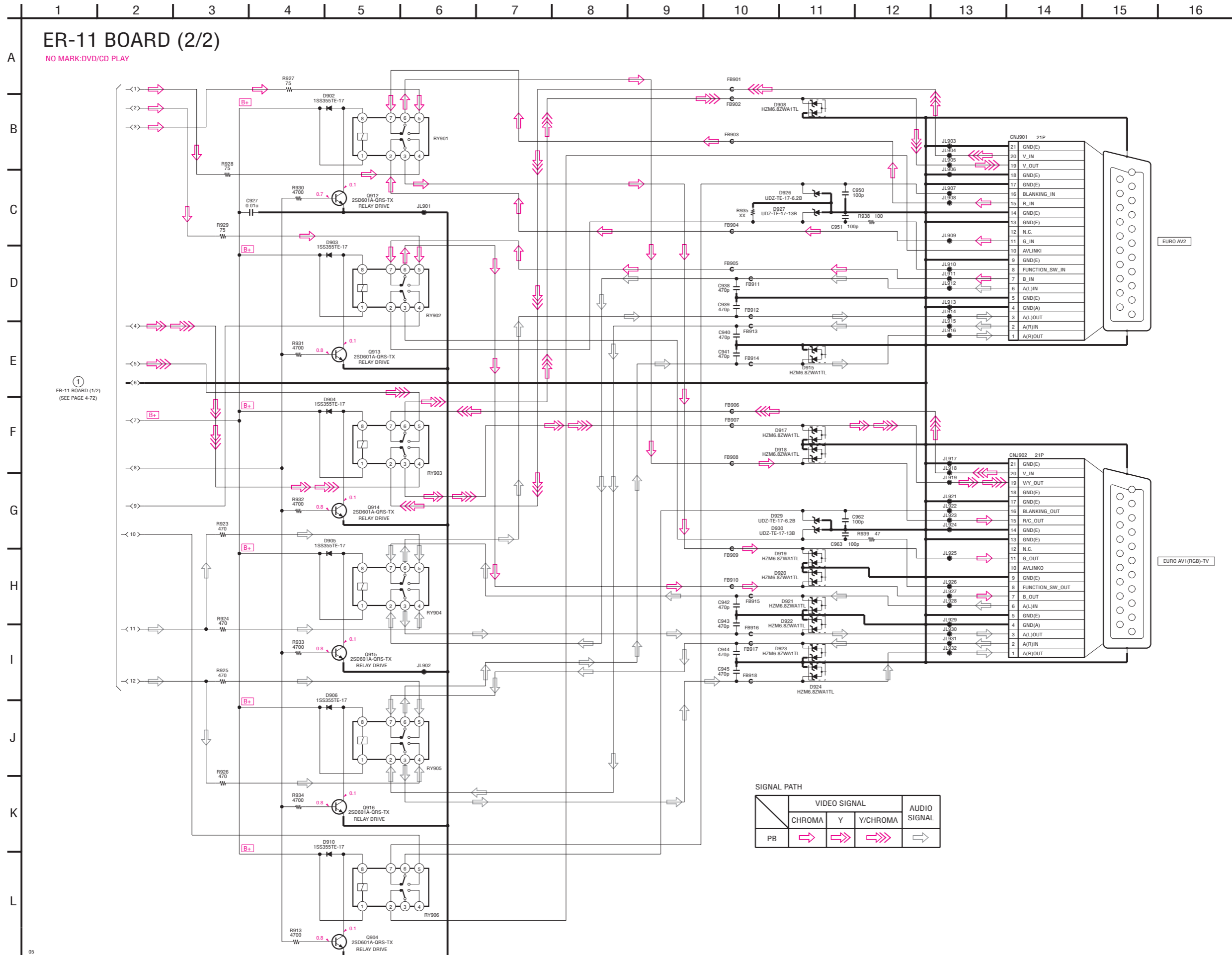

FL-114 (FUNCTION SWITCH, IF CON) PRINTED WIRING BOARD

– Ref. No.: FL-114 board; 2,000 series –

There are a few cases that the part isn't mounted in this model is printed on this diagram.

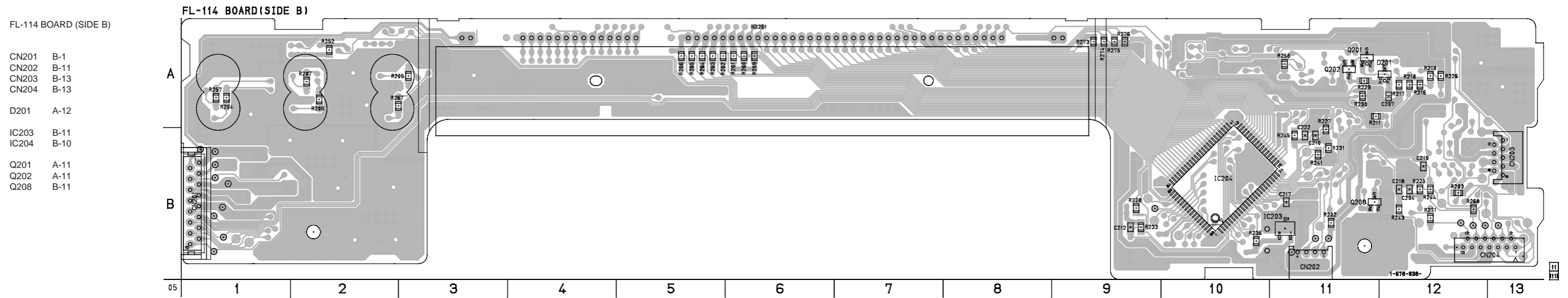
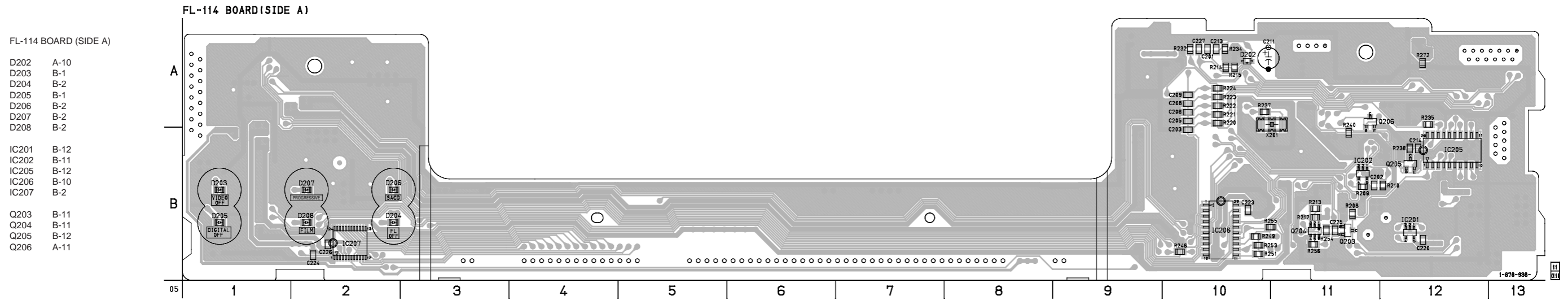

**BZ-1 (BUZZER) PRINTED WIRING BOARD**

– Ref. No.: BZ-1 board; 2,000 series –

There are a few cases that the part isn't mounted in this model is printed on this diagram.

**BZ-1 BOARD (SIDE A)**

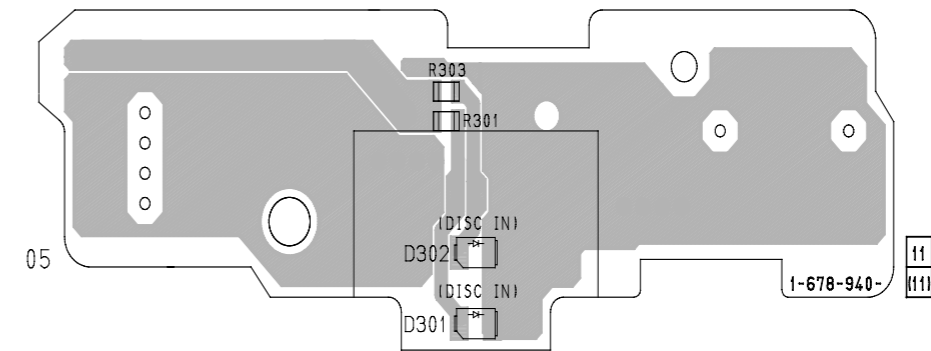

**BZ-1 BOARD (SIDE B)**

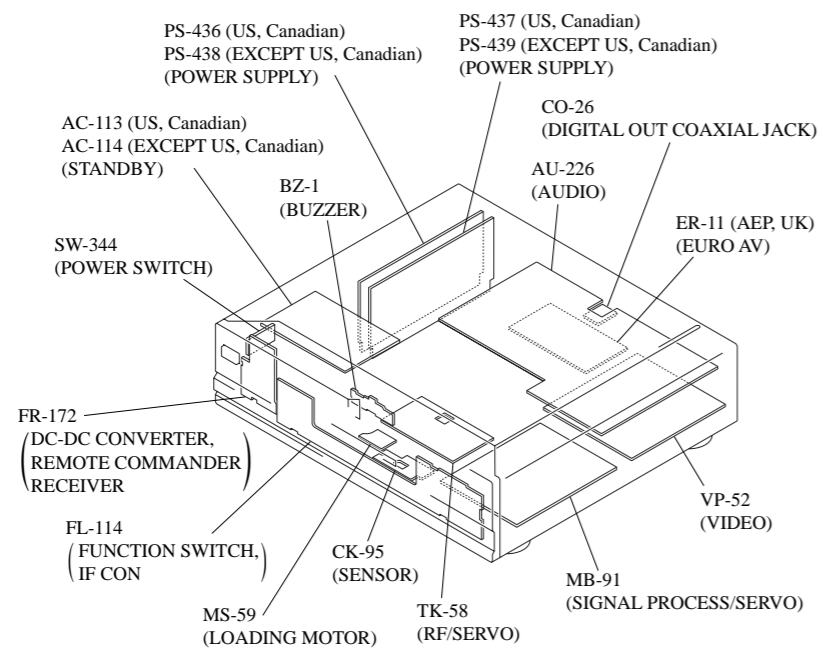
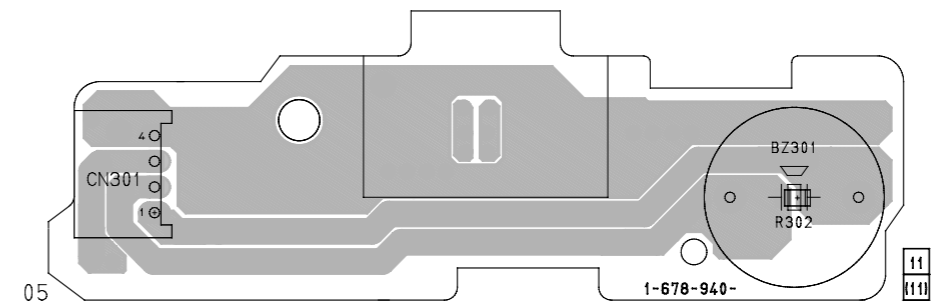

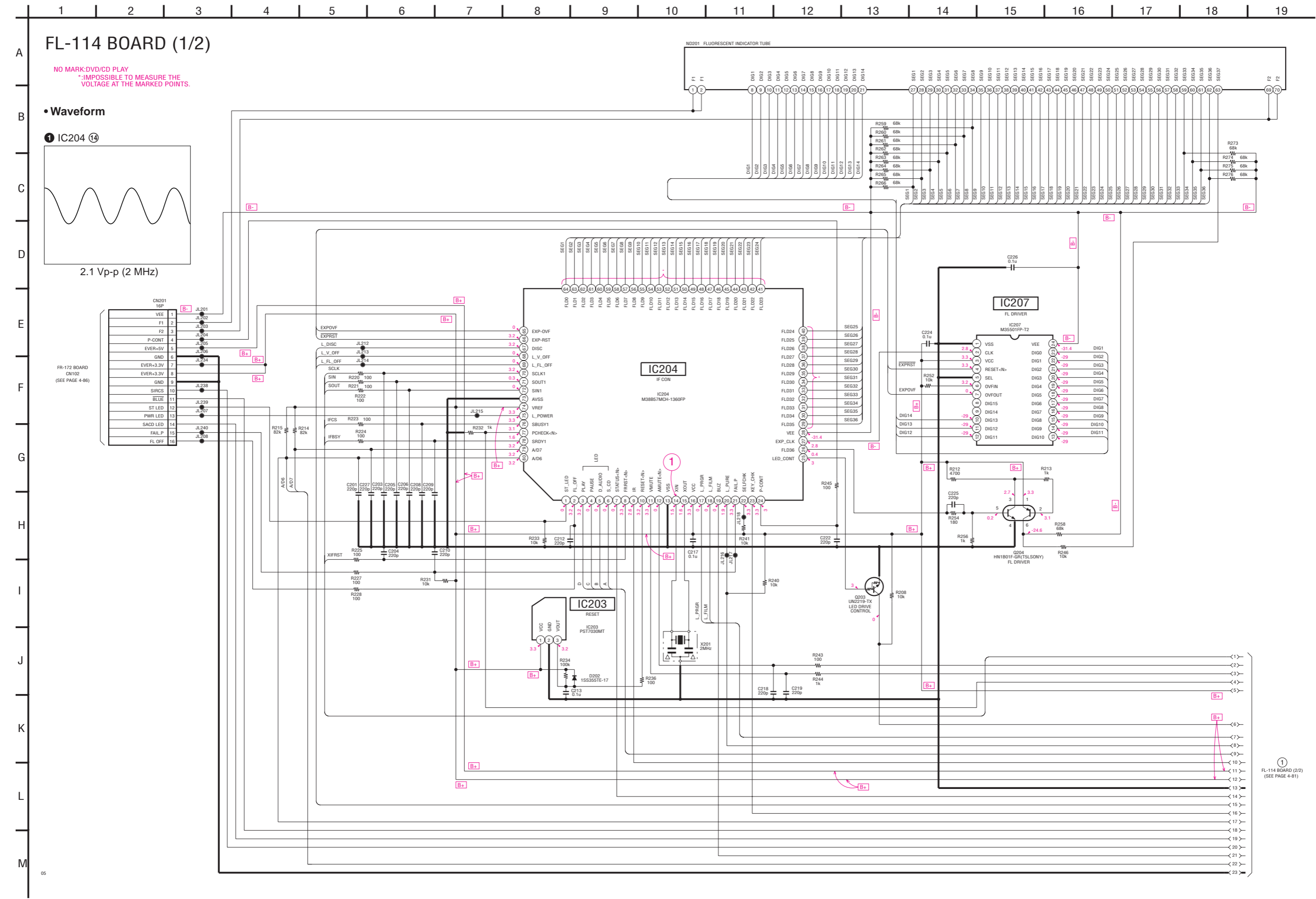

**FL-114 (LED DRIVE), BZ-1 (BUZZER) SCHEMATIC DIAGRAM • See page 4-75 for printed wiring board.**

– Ref. No.: FL-114, BZ-1 board; 2,000 series –

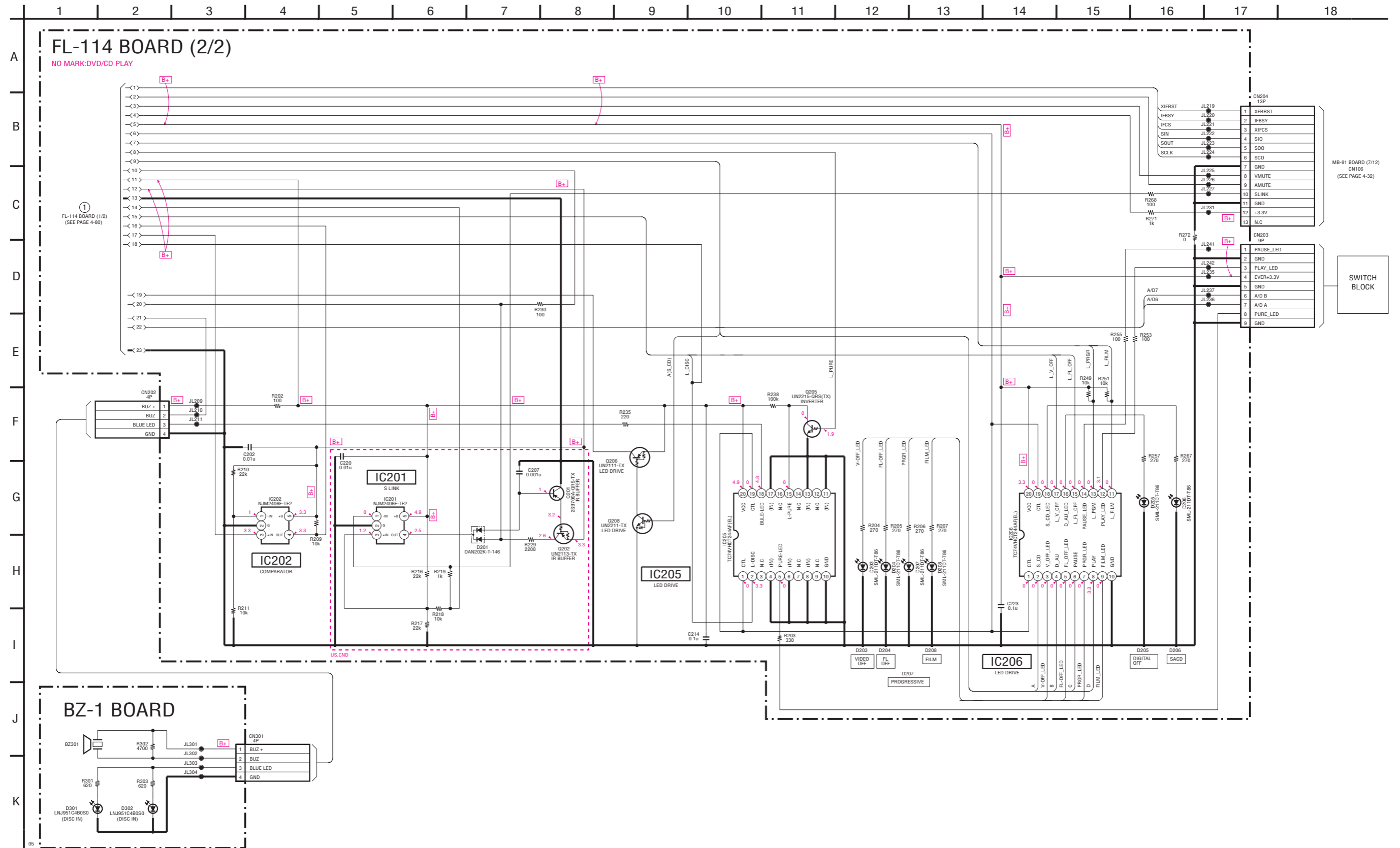



**DVP-S9000ES**

**FR-172 (DC-DC CONVERTER, REMOTE COMMANDER RECEIVER) PRINTED WIRING BOARD**

- Ref. No.: FR-172 board; 4,000 series -

There are a few cases that the part isn't mounted in this model is printed on this diagram.

**FR-172 BOARD (SIDE A)**

FR-172 BOARD (SIDE A)

- D113 C-1
- D114 C-1
- IC101 C-2
- Q107 A-2
- Q108 A-2
- Q109 C-1
- Q110 C-1
- Q111 C-1

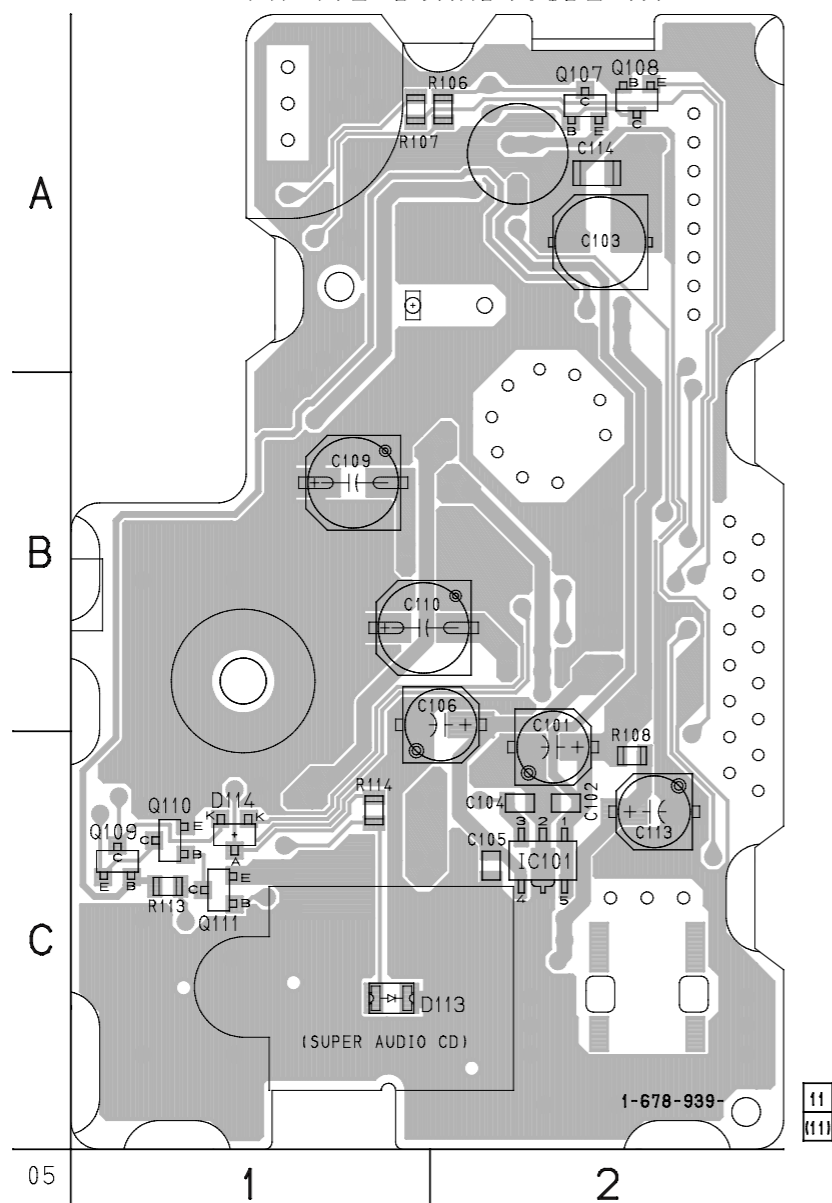

**FR-172 BOARD (SIDE B)**

FR-172 BOARD (SIDE B)

- CN101 A-2
- CN102 B-2
- D106 B-2
- D107 B-2
- D108 B-2
- D109 B-2
- D110 B-2
- D111 C-2
- D112 A-1
- IC102 C-2
- Q101 A-1
- Q102 A-1
- Q103 B-2
- Q104 A-2
- Q105 A-2
- Q106 A-2

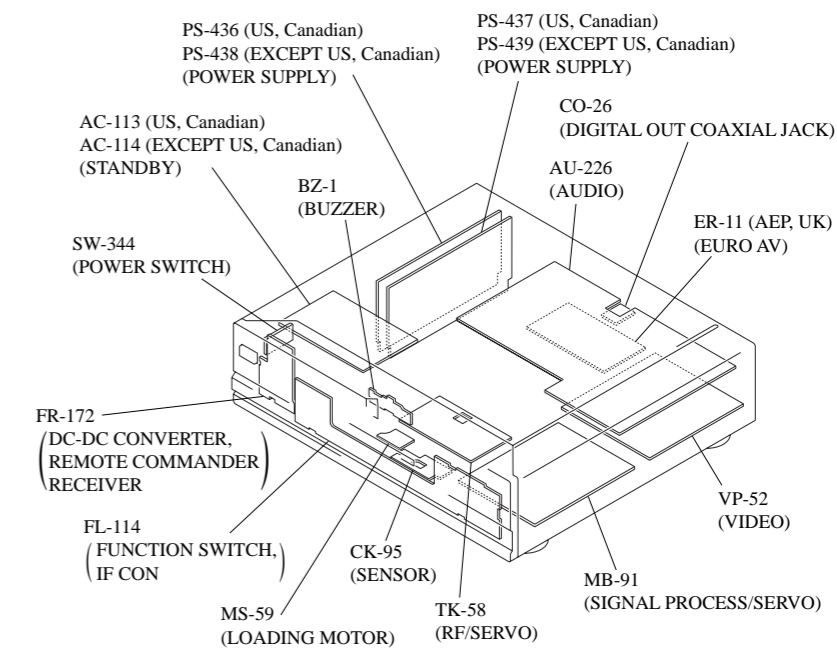
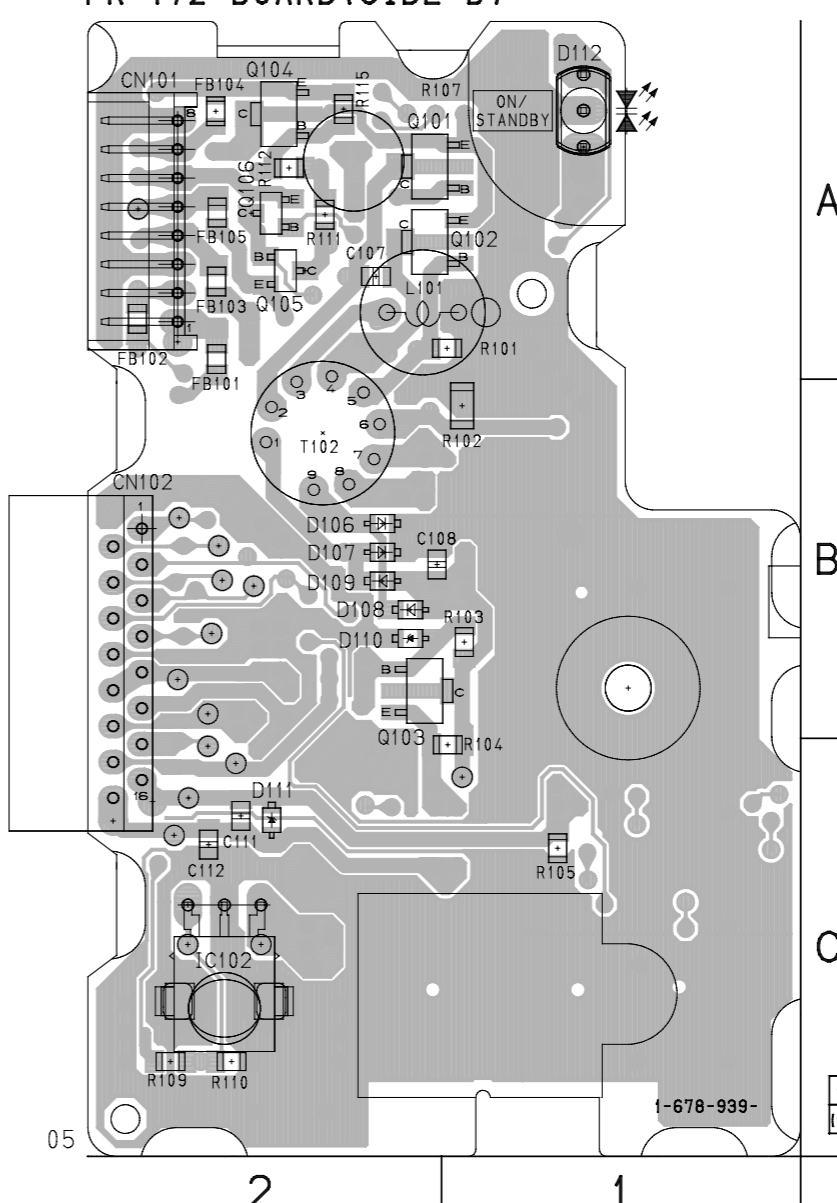

**FR-172 (DC-DC CONVERTER, REMOTE COMMANDER RECEIVER) SCHEMATIC DIAGRAM**

- Ref. No.: FR-172 board; 4,000 series -

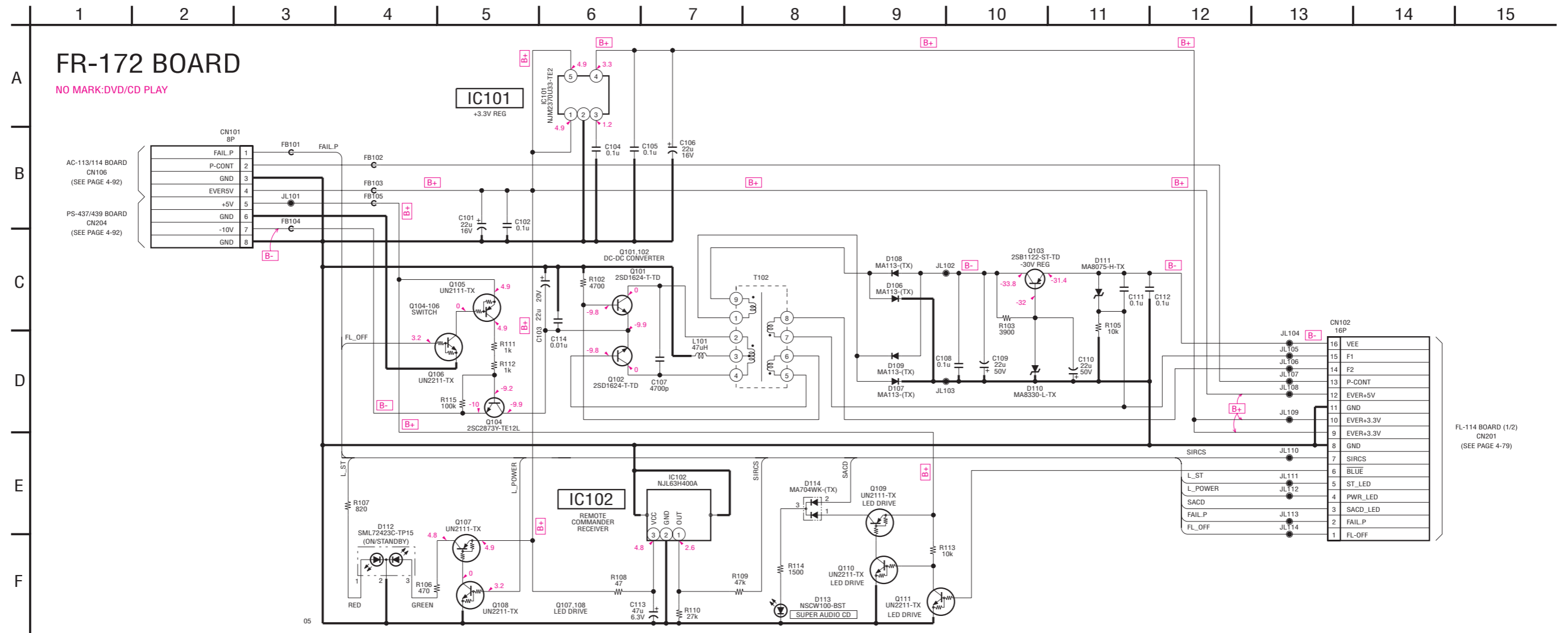

**DVP-S9000ES**

**AC-113/114 (STANDBY), SW-344 (POWER SWITCH) PRINTED WIRING BOARDS**

- Ref. No.: AC-113/114, SW-344 board; 2,000 series -

There are a few cases that the part isn't mounted in this model is printed on this diagram.

**AC-113/114 BOARD (SIDE A)**

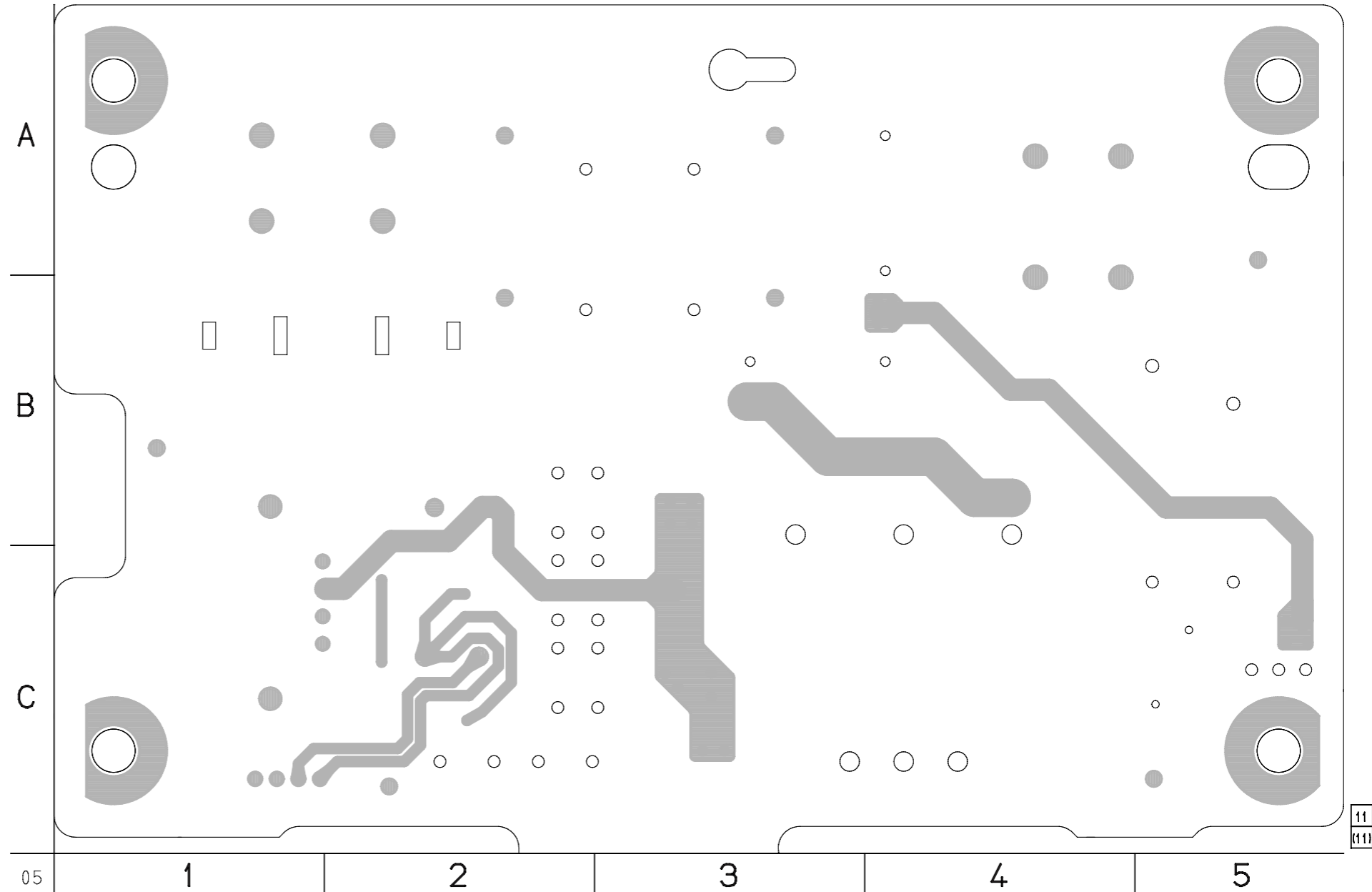

AC-113 : 1-678-947-  
AC-114 : 1-678-950-

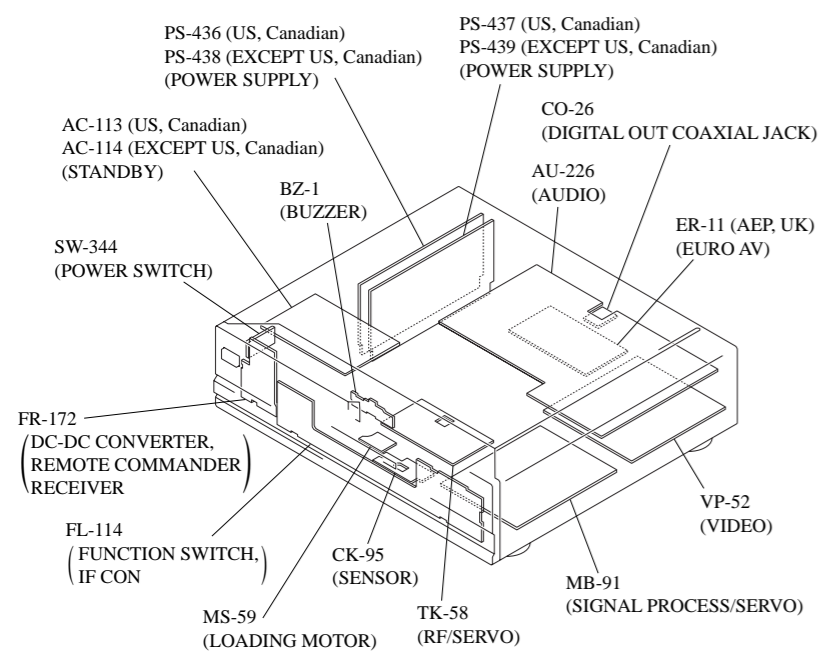

**STANDBY/POWER SWITCH  
AC-113/114/SW-344**

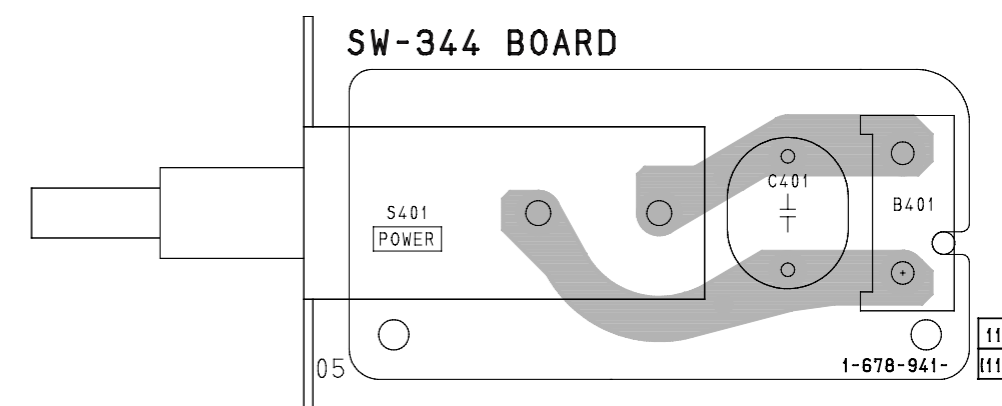

AC-113/114 BOARD(SIDE B)

AC-113/114 BOARD  
(SIDE B)

- CN101 A-2
- CN102 A-1
- CN104 A-4
- CN105 B-4
- CN106 C-1

- D101 C-2
- D102 C-2
- D103 C-2
- D105 B-2
- D106 B-2
- D107 C-5
- D108 C-2
- D109 C-2

- IC101 C-2

- Q101 C-5
- Q102 C-2
- Q103 C-2

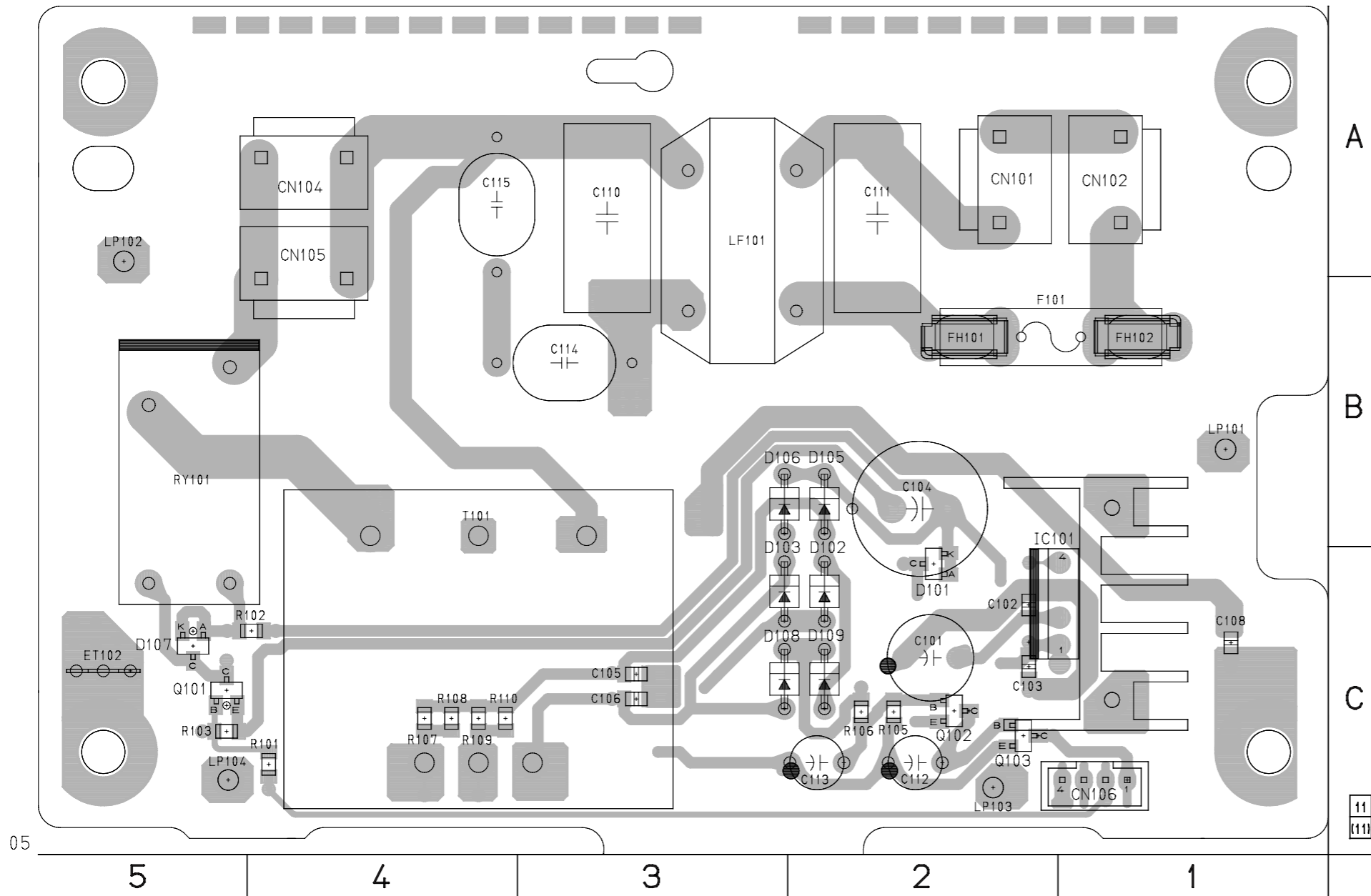

AC-113: 1-678-947-  
AC-114: 1-678-950-

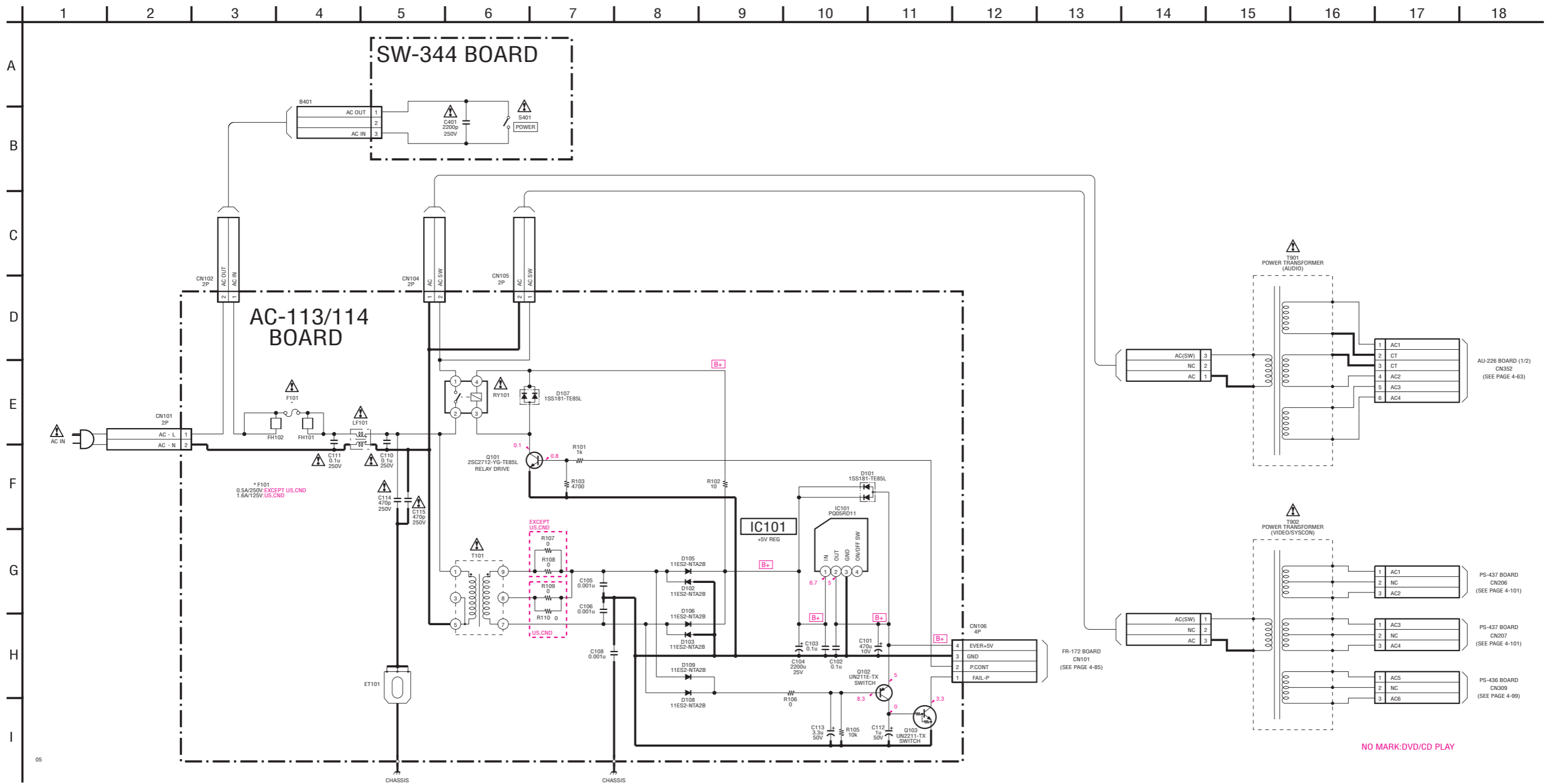

NO MARK: DVD/CD PLAY

**Note:**  
The components identified by mark  $\triangle$  or dotted line with mark  $\triangle$  are critical for safety. Replace only with part number specified.

**Note:**  
Les composants identifiés par une marque  $\triangle$  sont critiques pour la sécurité. Ne les remplacer que par une pièce portant le numéro spécifié.

**MS-59 (LOADING MOTOR), CK-95 (SENSOR) PRINTED WIRING BOARDS AND SCHEMATIC DIAGRAM**

– Ref. No.: MS-59, CK-95 board; 1,000 series –

There are a few cases that the part isn't mounted in this model is printed on this diagram.

**MS-59 BOARD**

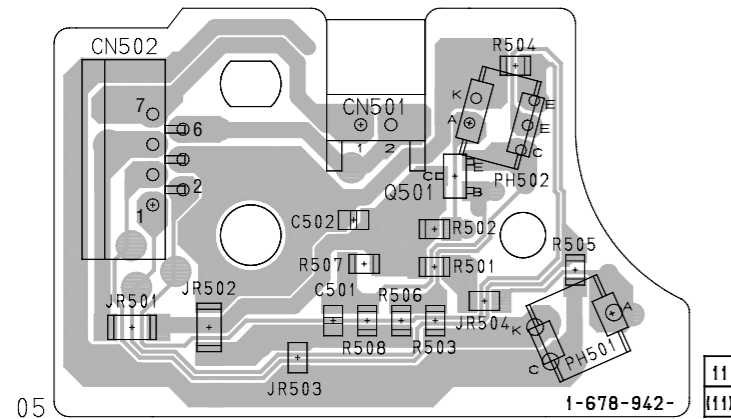

**CK-95 BOARD**

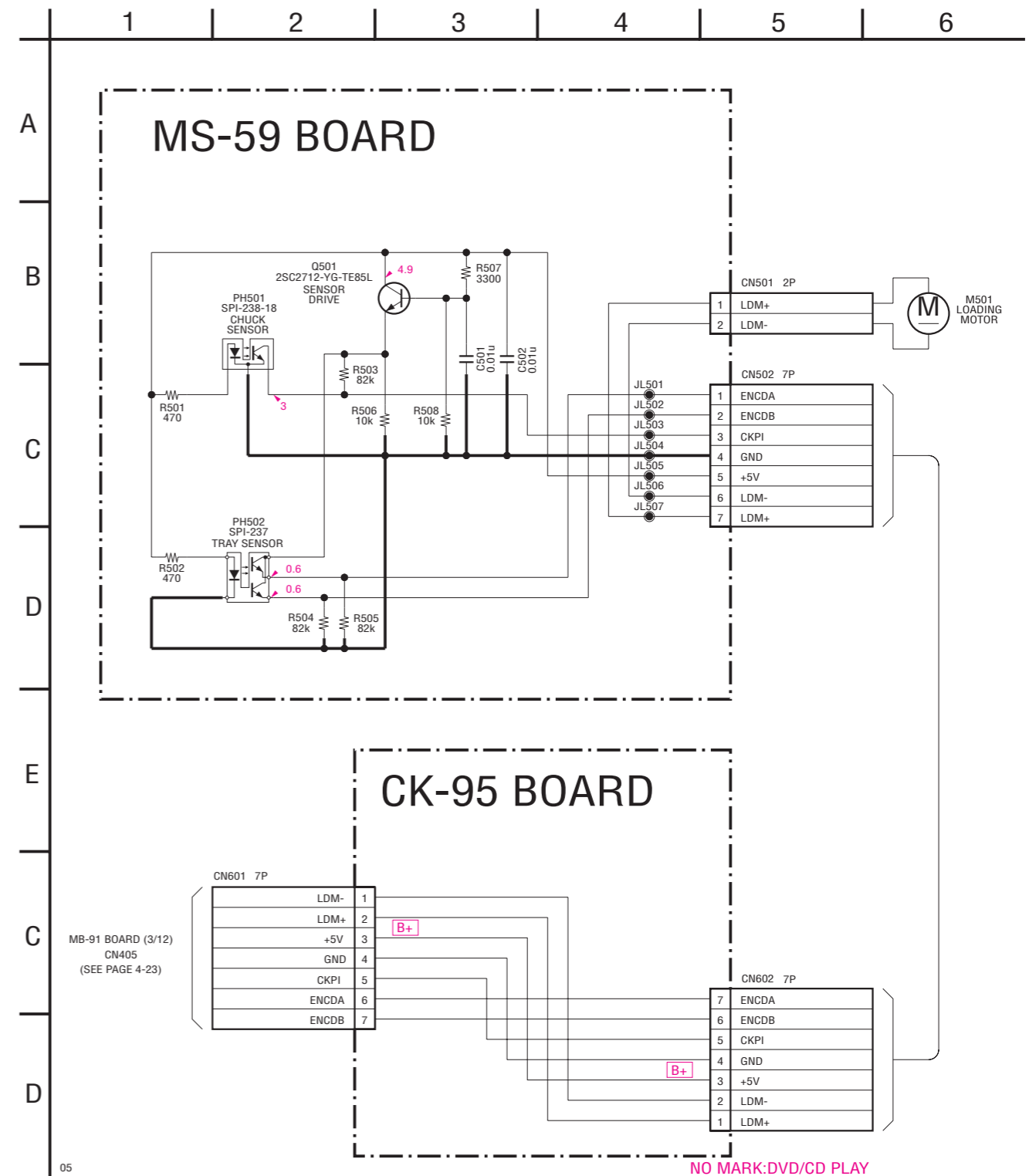
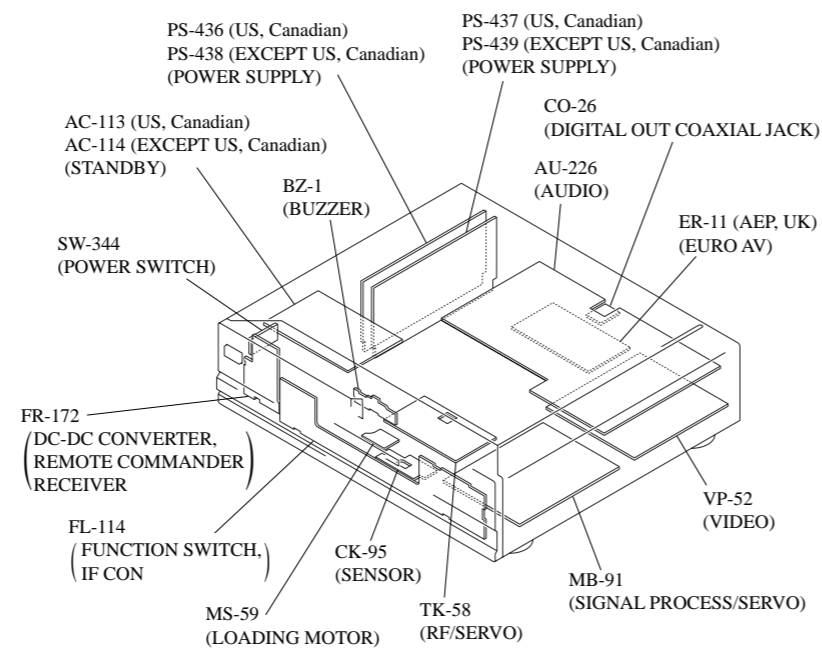
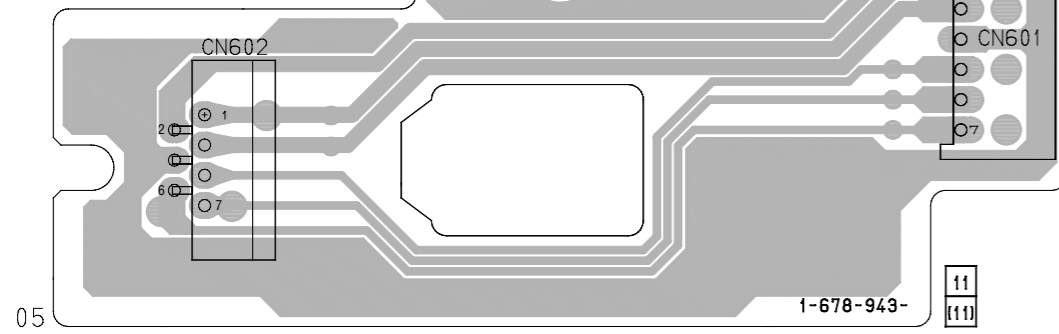

**DVP-S9000ES**

**PS-436/438 (POWER SUPPLY) PRINTED WIRING BOARD**

– Ref. No.: PS-436/438 board; 2,000 series –

There are a few cases that the part isn't mounted in this model is printed on this diagram.

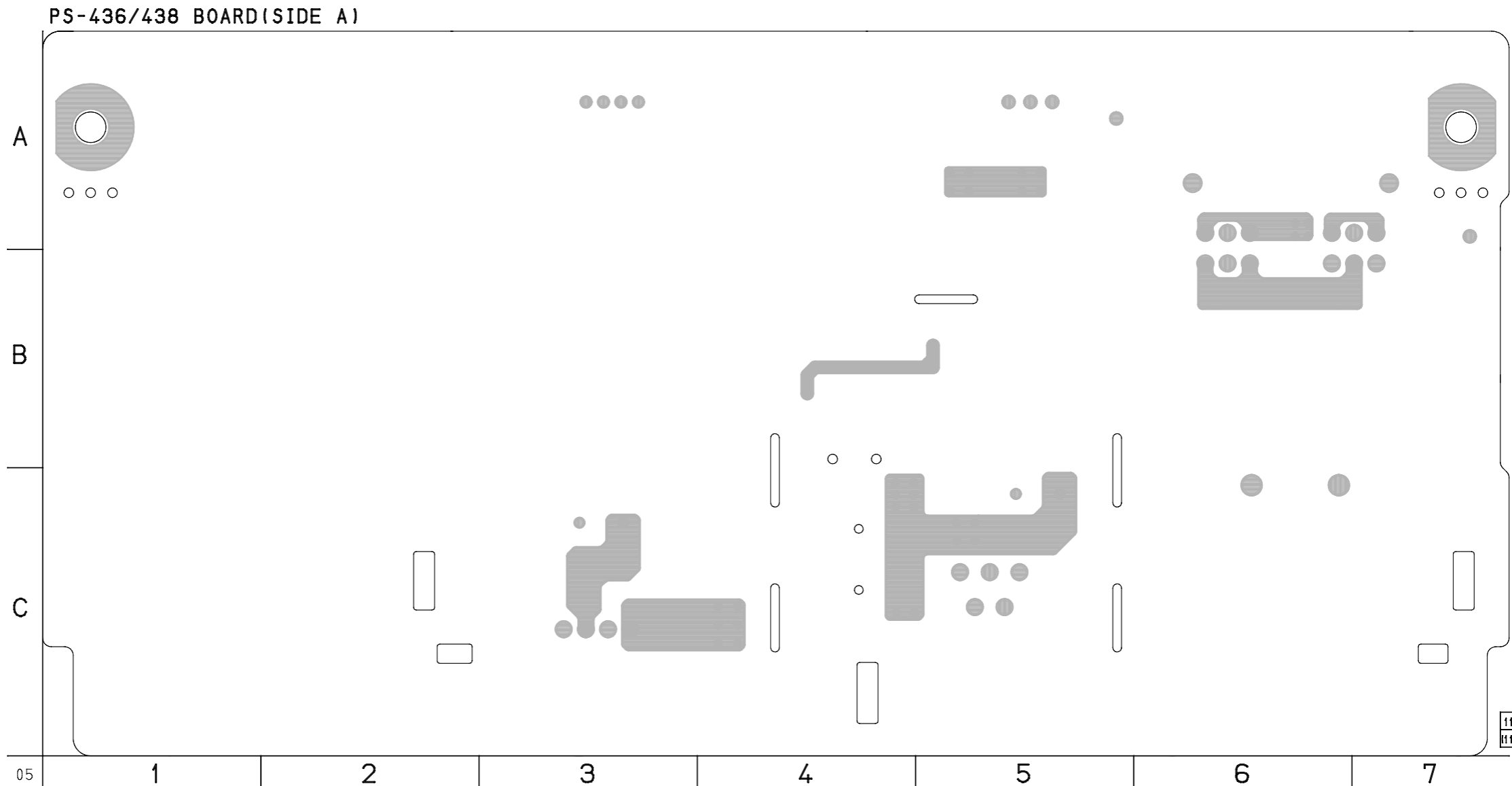

PS-436 : 1-678-948-  
PS-438 : 1-678-951-

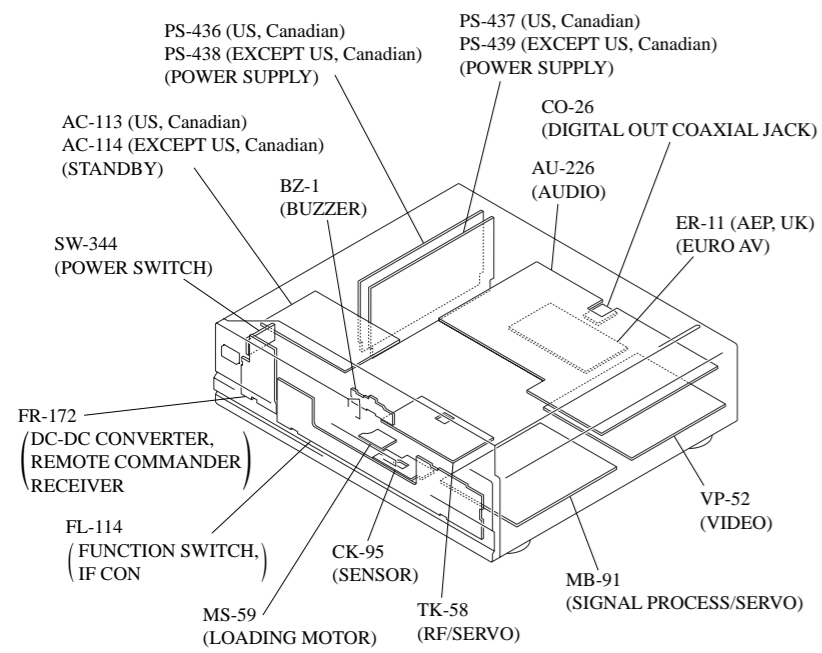

PS-436/438 BOARD (SIDE B)

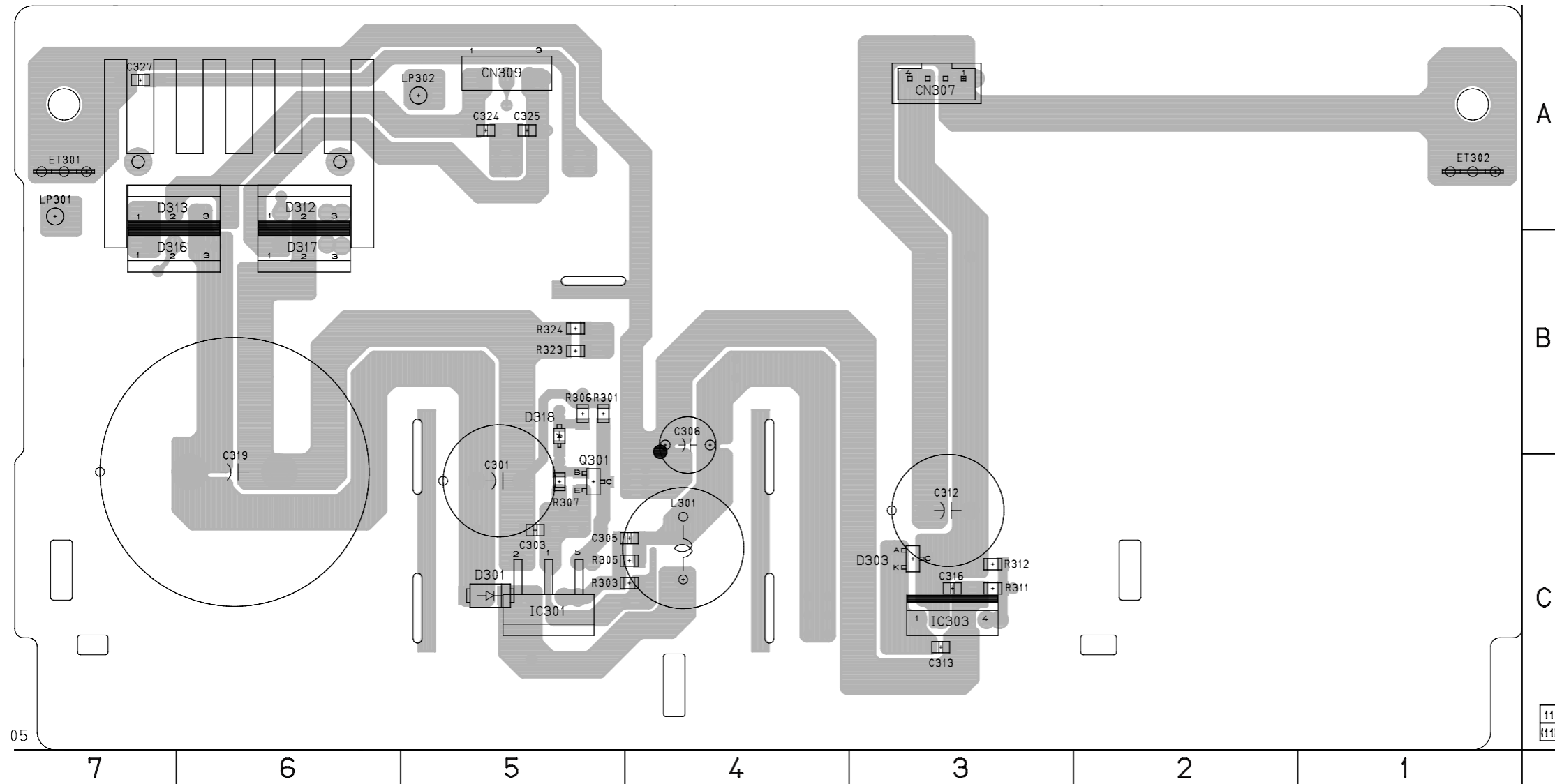

PS-436/438 BOARD (SIDE B)

- CN307 A-3
- CN309 A-5
- D301 C-5
- D303 C-3
- D312 A-6
- D313 A-6
- D316 B-6
- D317 B-6
- D318 B-5
- IC301 C-5
- IC303 C-3
- Q301 C-5

PS-436 : 1-678-948-  
PS-438 : 1-678-951-



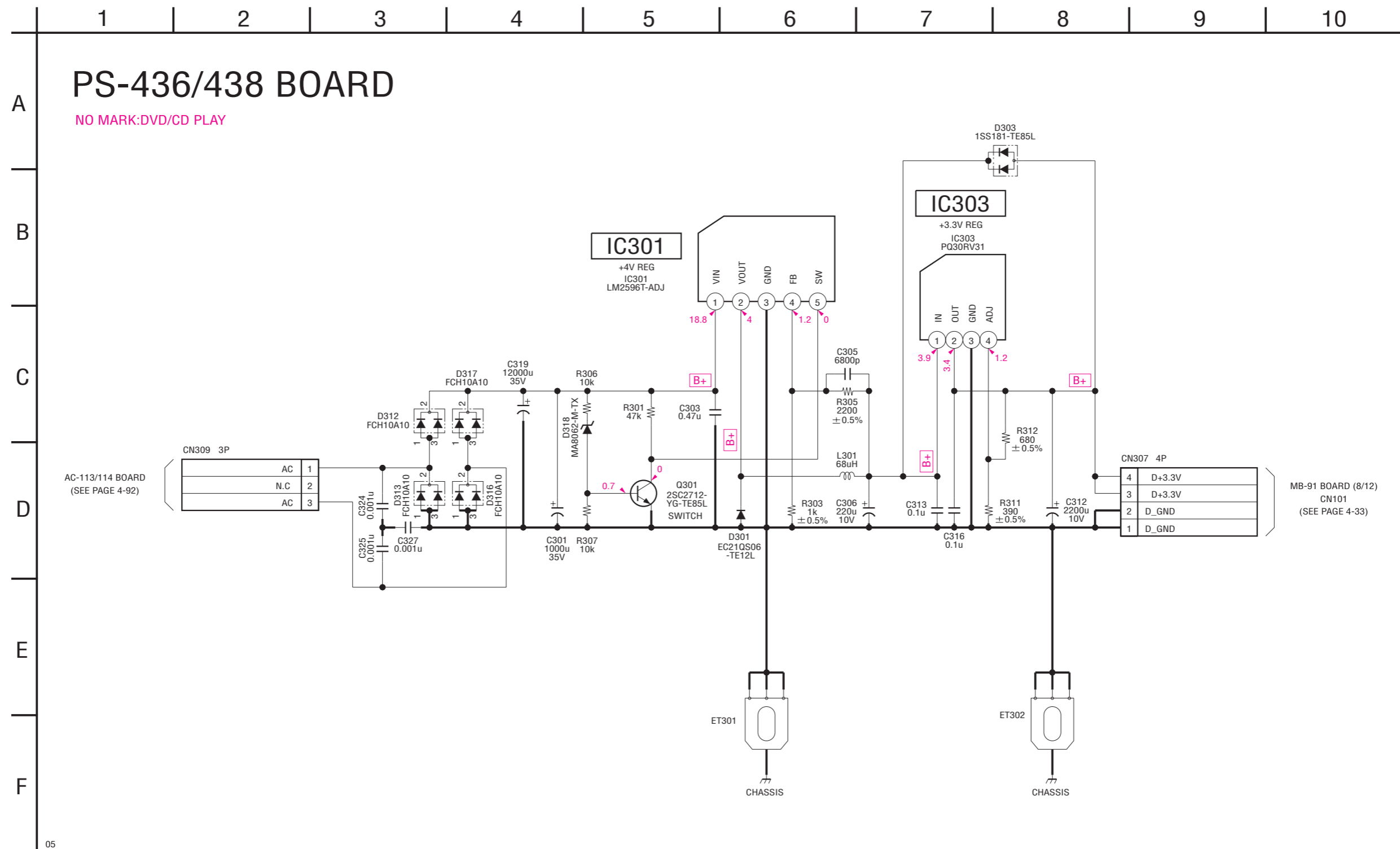

PS-437/439 (POWER SUPPLY) SCHEMATIC DIAGRAM • See page 4-103 for printed wiring board.

– Ref. No.: PS-437/439 board; 3,000 series –

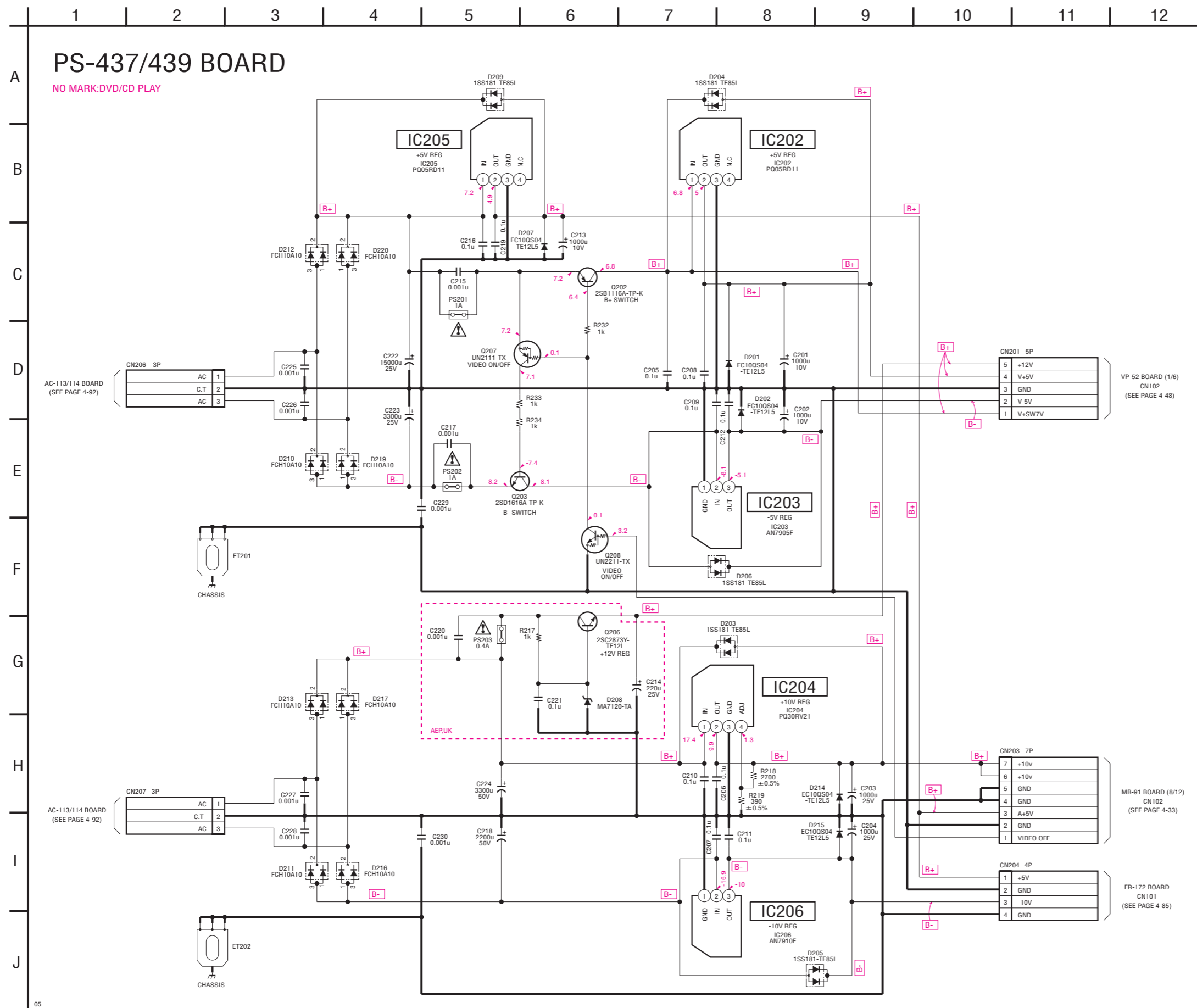

**Note:** The components identified by mark  $\Delta$  or dotted line with mark  $\Delta$  are critical for safety. Replace only with part number specified.

**Note:** Les composants identifiés par une marque  $\Delta$  sont critiques pour la sécurité. Ne les remplacer que par une pièce portant le numéro spécifié.

There are a few cases that the part isn't mounted in this model is printed on this diagram.

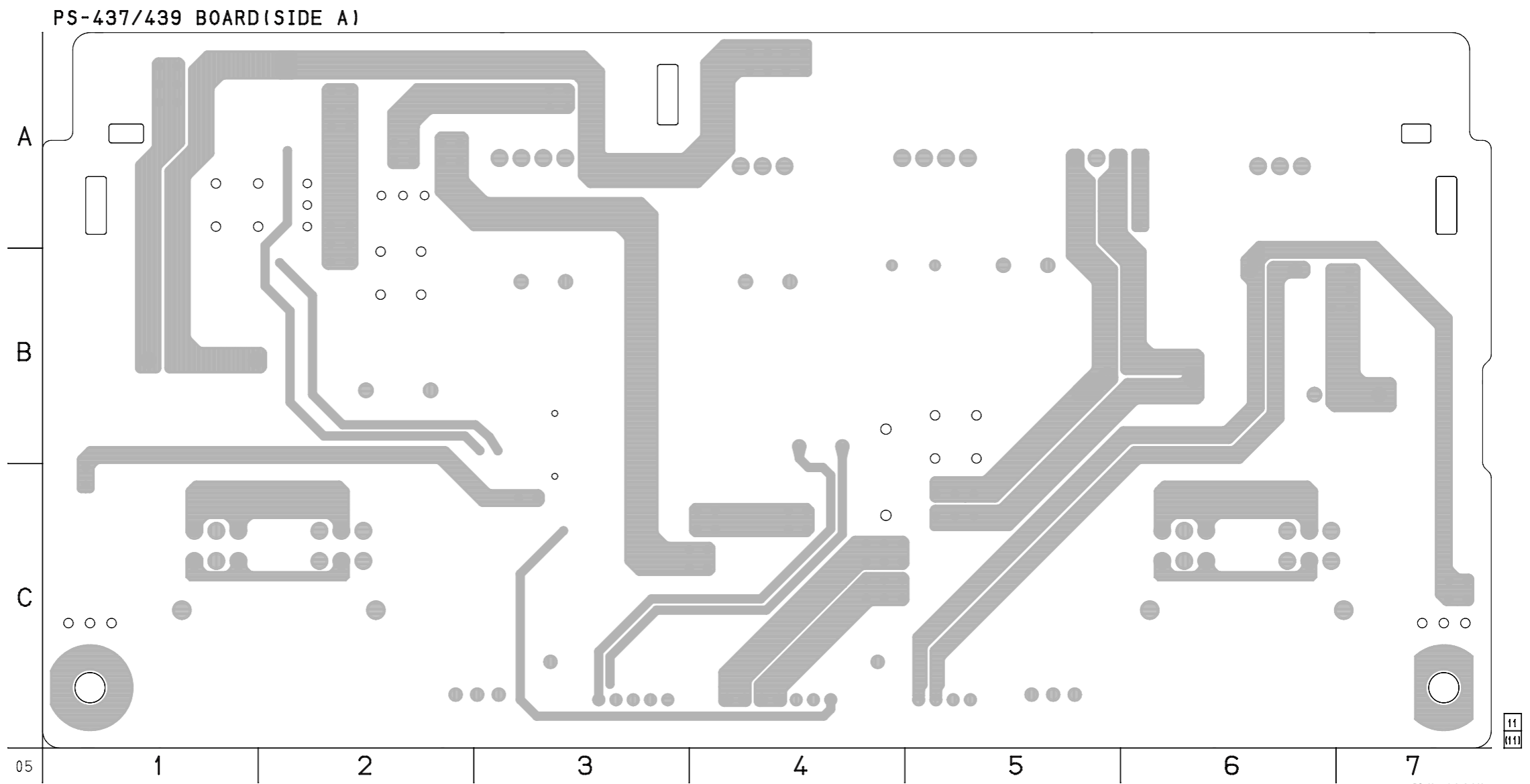

PS-437 : 1-678-949-  
PS-439 : 1-678-952-

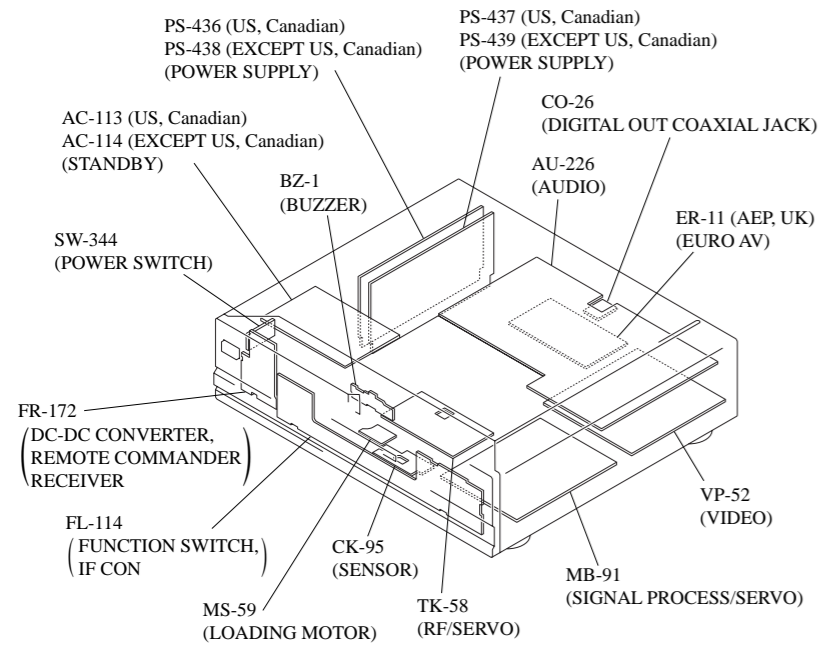

PS-437/439 BOARD (SIDE B)

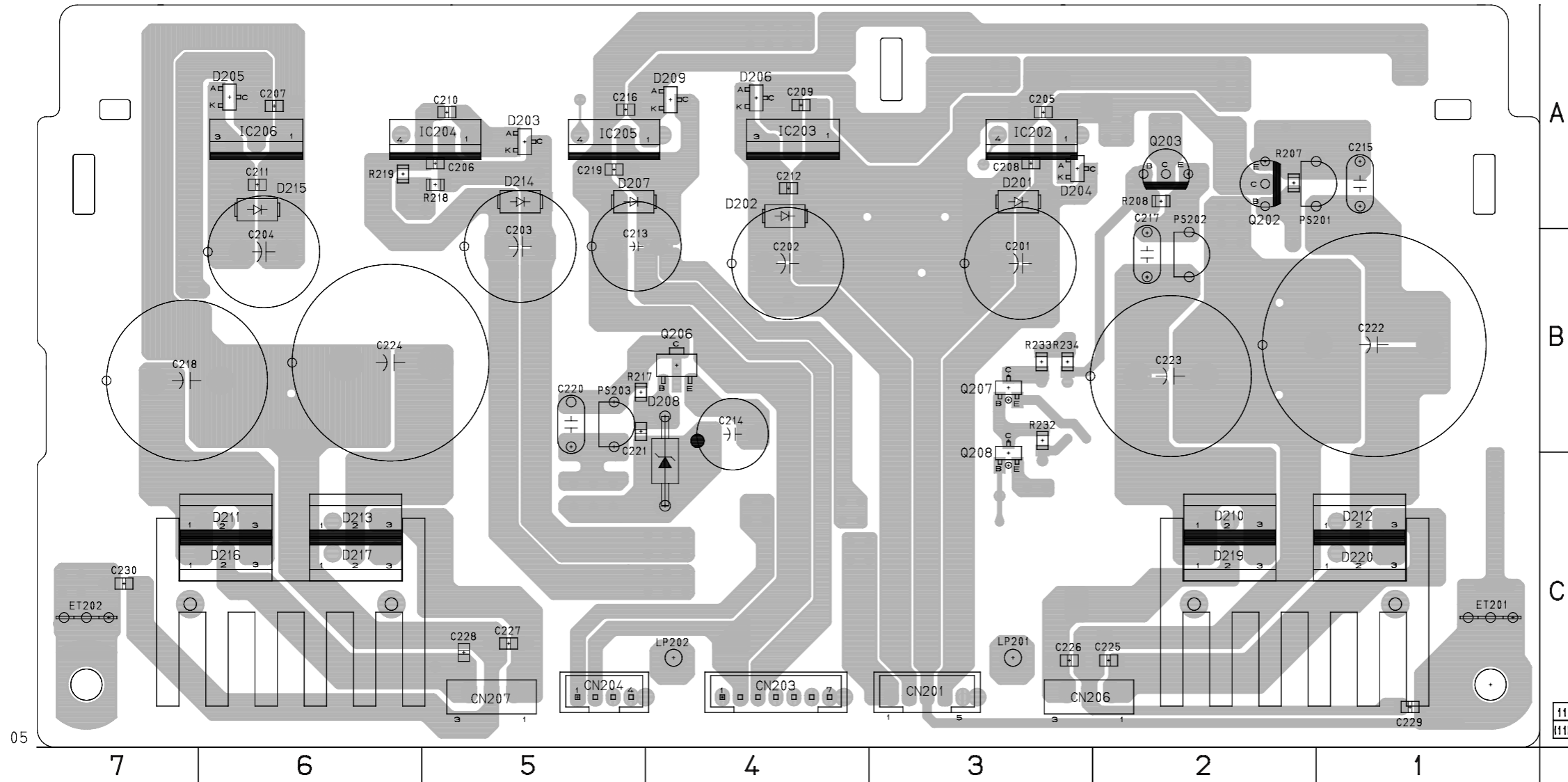

PS-437/439 BOARD (SIDE B)

CN201	C-3
CN203	C-4
CN204	C-5
CN206	C-2
CN207	C-5
D201	A-3
D202	A-4
D203	A-5
D204	A-3
D205	A-6
D206	A-4
D207	A-5
D208	B-4
D209	A-4
D210	C-2
D211	C-6
D212	C-1
D213	C-6
D214	A-5
D215	A-6
D216	C-6
D217	C-6
D219	C-2
D220	C-1
IC202	A-3
IC203	A-4
IC204	A-5
IC205	A-5
IC206	A-6
Q202	A-2
Q203	A-2
Q206	B-4
Q207	B-3
Q208	B-3

PS-437 : 1-678-949-  
PS-439 : 1-678-952-

## SECTION 5

### IC PIN FUNCTION DESCRIPTION

#### 5-1. SYSTEM CONTROL PIN FUNCTION (MB-91 BOARD IC102)

Pin No.	Pin name	I/O	Function
1~5	HA17-HA21	O	Address bus A17-A21
6	HA22	-	Not used
7	RGBSEL	O	Color difference signal/RGB signal select signal output
8	P70	-	Not used
9	AVCC	-	Power supply
10	AVRH	-	Reference power supply (+3.3 V)
11	AVSS	-	Ground
12	AN0	I	Set of mode 0
13	AN1	I	Set of mode 1
14	AN2	I	Set of mode 2
15	AN3	I	SCAN SELECT Switch (S401) input (PROGRESSIVE: "L", INTERLACE "M", SELECTABLE: "H")
16	XRST	O	System reset signal output
17	DISC/EXIT	O	Line input select signal output (DISC: "H", EXT: "L")
18	PH2/CS6	-	Not used
19	CS7	-	Not used
20	EUROV/Y	O	EURO V/Y select signal output
21	PH5	O	DVD-RW gain select signal output (RW: "L")
22	ARRPST	O	Reset signal output for ARP3
23	DRVMUTE	O	Drive mute signal output
24	VCC	-	Power supply
25	INT0	I	Input of interrupt from AV DEC
26	INT1	I	Input of interrupt from ARP3
27	INT2	I	Input of interrupt from H2GA
28	INT3	I	Input of interrupt from EEPROM
29	INT4	I	Input of interrupt from IF CON
30	INT5	I	Not used (fixed at "H")
31	INT6	I	Input of interrupt from AV DEC
32	INT7	I	Input of interrupt from servo DSP
33	SI0	I	Serial data input from IF CON and EEPROM
34	VSS	-	Ground
35	SO0	O	Serial data output to IF CON and EEPROM
36	SC0	O	Serial clock output to IF CON and EEPROM
37	SI1	I	Serial bus 1 (for data input)

Pin No.	Pin name	I/O	Function
38	SO1	O	Serial bus 1 (for data output)
39	SC1	O	Serial clock output
40	SI2	I	Serial bus 2 (for data input)
41	SO2	O	Serial bus 2 (for data output)
42	N.C	-	Not used
43	DREQ0	I	Input of DMA-REQ 0 from AV DEC
44	DACK0/PE2	-	Not used
45	IFCS	O	Chip select signal to IF CON
46	DREQ1	I	Input of DMA-REQ 1 from OSD
47	DACK1	O	Output of DMA-ACK 1 to OSD
48	EWC	O	Write control signal output to EEPROM
49	ECS	O	Chip select signal output to EEPROM
50	DACCS2	-	Not used
51	PI1	-	Not used
52	VSS	-	Ground
53	X1	O	Clock output (12.5 MHz)
54	X0	I	Clock input (12.5 MHz)
55	VCC	-	Power supply
56	NC	-	Not used
57	PMUTE	O	32 PD signal output (AFMC: "H")
58	PRST	I	32 PD signal input (FILM: "L")
59	DACCS0	-	Not used
60	DACCS1	-	Not used
61	48/44.1K	O	PLL FS control signal output ("H" = 48 k/"L" = 44.1 k)
62	MAMUTE	O	Audio mute signal output
63	WIDE	O	WIDE select signal output ("H" = 16 : 9/"L" = 4 : 3)
64	C	-	Capacitor (0.1uF) connect between ground
65	CS0X	O	External ROM chip select signal output
66	CS1X	O	External RAM chip select signal output
67	CS2X	O	Chip select signal output (for OSD)
68	CS3X	O	Chip select signal output (for OSD)
69	CS4X	O	Chip select signal output (for FBI)
70	CS5X	O	Chip select signal output (for H2GA)

Pin No.	Pin name	I/O	Function
71	CPUCK	O	CPU clock (25 MHz) signal output
72	NMIX	–	Not used (fixed at “H”)
73	HSTX	–	Not used (fixed at “H”)
74	FRSTIN	I	Reset signal input from IF CON
75	VSS	–	Ground
76	MD0	I	Input of mode select 0 (fixed at “H”)
77	MD1	I	Input of mode select 1 (fixed at “L”)
78	MD2	I	Input of mode select 2 (fixed at “L”)
79	XWAIT	I	Wait signal input
80	BGRNTX	–	Test terminal (fixed at “H”)
81	BRQ	–	Test terminal (fixed at “L”)
82	RD	O	Read enable signal output
83	WRH	O	High byte write enable signal output (16 bit and 8 bit)
84	WRL	O	Low byte write enable signal output (16 bit only)
85–92	HD0-HD7	I/O	Data bus D0-D7 (16 bit only)
93–100	HD8-HD15	I/O	Data bus D8-D15 (16 bit), D0-D7 (8 bit)
101	VSS	–	Ground
102–109	HA0-HA7	O	Address bus A00-A07
110	VCC	–	Power supply
111–118	HA8-HA15	O	Address bus A08-A15
119	VSS	–	Ground
120	HA16	O	Address bus A16

## SECTION 6 TEST MODE

### 6-1. GENERAL DESCRIPTION

The Test Mode allows you to make diagnosis and adjustment easily using the remote commander and monitor TV. The instructions, diagnostic results, etc. are given on the on-screen display (OSD).

### 6-2. STARTING TEST MODE

Press [TITLE], [CLEAR], [POWER] buttons on the remote commander in this order with the power of main unit in OFF status, and the Test Mode starts, then the menu shown below will be displayed on the TV screen. At the bottom of menu screen, the model name and revision number are displayed.

To execute each function, select the desired menu and press its number on the remote commander.

To exit from the Test Mode, press the POWER button.

```

Test Mode Menu
0. Syscon Diagnosis
1. Drive Auto Adjustment
2. Drive Manual Operation
3. Mecha Aging
4. Emergency History
5. Version Information
6. Video Level Adjustment
7. Prog Level Adjustment
                                Exit: Power Key
-
Model      : DPX13xx
Revision   : 1.xxx

```

### 6-3. SYSCON DIAGNOSIS

The same contents as board detail check by serial interface can be checked from the remote commander.

On the Test Mode Menu screen, press [0] key on the remote commander, and the following check menu will be displayed.

```

### Syscon Diagnosis ###
Check Menu
0. Quit
1. All
2. ROM, Model, Region
3. RAM, EEPROM, NFLASH, H2GA
4. Servo, ARP
5. AV Decoder
6. OSD
7. FBI, SACD
8. Video
9. Audio
-

```

#### 0. Quit

Quit the Syscon Diagnosis and return to the Test Mode Menu.

#### 1. All

All items continuous check

This menu checks all diagnostic items continuously. Normally, all items are checked successively one after another automatically unless an error is found, but at a certain item that requires judgment through a visual check to the result, the following screen is displayed for the key entry.

```

### Syscon Diagnosis ###

Diag All Check
No. 2 ROM, Model, Region

2-3. ROM Check Sum
Check Sum = xxxx

Press NEXT Key to Continue
Press PREV Key to Repeat
-

```

For the ROM Check, the check sum calculated by the Syscon is output, and therefore you must compare it with the specified value for confirmation.

Following the message, press [▶▶] key to go to the next item, or [◀◀] key to repeat the same check again. To quit the diagnosis and return to the Check Menu screen, press [■] or [ENTER] key. If an error occurred, the diagnosis is suspended and the error code is displayed as shown below.

```

### Syscon Diagnosis ###

3-3. EEPROM Write/Read
Error 03: EEPROM Write/Read N
Address   : 00000001
Write Data : 2492
Read Data  : 2490
Press NEXT Key to Continue
Press PREV Key to Repeat
-

```

Press [■] key to quit the diagnosis, or [◀◀] key to repeat the same item where an error occurred, or [▶▶] key to continue the check from the item next to faulty item.

#### Submenu

Selecting 2 and subsequent items calls the submenu screen of each item.

For example, if "2. ROM, Model, Region" is selected, the following submenu will be displayed.

```

### Syscon Diagnosis ###
Check Menu
No. 2 ROM, Model, Region
0. Quit
1. All
2. ROM Revision
3. ROM Check Sum
4. Model Type
5. Region
-

```

#### 0. Quit

Quit the submenu and return to the main menu.

#### 1. All

All submenu items continuous check

This menu checks 2 and subsequent items successively. At the item where visual check is required for judgment or an error occurred, the checking is suspended and the message is output for key entry.

Normally, all items are checked successively one after another automatically unless an error is found.

Selecting 2 and subsequent items executes respective menus and outputs the results.

For the contents of each submenu, see “Check Items List”.

## General Description of Checking Method

### 2. ROM, Model, Region

#### (2-2) ROM Revision

ROM revision number is displayed.

Error: Not detected.

The revision number defined in the source file of ROM (IC103) is displayed with four digits.

#### (2-3) ROM Check Sum

Check sum is calculated.

Error: Not detected.

The data are added of ROM (IC103) and the result is displayed with 4-digit hexadecimal number. Error is not detected. Compare the result with the specified value.

#### (2-4) Model Type

Model code is displayed.

Error: Not detected.

The model code is displayed with 2-digit hexadecimal number.

	Model Type	
DVP-S9000ES (US, Canadian)	0	0
DVP-S9000ES (UK)	0	3
DVP-S9000ES (AEP)	0	4
DVP-S9000ES (Hong Kong)	0	7
DVP-S9000ES (Australian)	0	A
DVP-S9000ES (Chinese)	0	6

#### (2-5) Region

Region code is displayed.

Error: Not detected.

The region code determined from the model code is displayed.

### 3. RAM, EEPROM, NFLASH, H2GA

#### (3-2) RAM write/read

Data writing to external RAM (IC105) → read matching check

#### (3-3) EEPROM write/read (IC101)

Data write → read, and accord check

Error 31: EEPROM write/read discord

Before writing, the data are saved, then after checking, they are written to restore the contents of EEPROM.

#### (3-4) NAND FLASH write/read

Data clear → write → read, and accord check

Error 32: Clear error

33: Write error

34: Read data discord

A4: Faulty blocks exceed 10

The data clear, write, read, and check are executed to the block 0 of Flash memory (IC202).

In case of a faulty block, its address is displayed.

#### (3-5) H2GA Register

Data write → read matching check

#### (3-6) H2GA Interrupt

Detection check for interruption from H2GA

#### (3-7) H2GA Reset

Nothing is done. \*Executed only for the serial interface.

### 4. Servo, ARP

#### (4-2) Servo-DSP Driver Test

Test signal data → DSP Driver

Error: Not detected.

#### (4-3) Servo-DSP Register

Nothing is done. \*Executed only for the serial interface.

#### (4-4) Servo-DSP Reset

Nothing is done. \*Executed only for the serial interface.

Caution: Do not conduct this check with a mechanical deck connected.

An access is made to the stream supply and servo control IC (IC303) and external RAM (IC306) using check data.

If mechanical deck is connected, the motor and optics could be damaged. This check is also executed by the “All” menu item.

Supplement: How to disconnect mechanical deck

Disconnect flat cables connected to the CN403 and CN404 of MB-91 board. Also, disconnect harness from the CN102.

#### (4-5) ARP Register (IC303)

Data write → read, and accord check

Error 41: ARP register write, and read data discord

#### (4-6) ARP DRAM

Data write → read, and accord check

Error 44: ARP RAM read data discord

The program code data stored in ROM are copied to all areas of RAM (IC306) connected to the ARP (IC303) through the bus, then they are read and checked if they accord. If the detail check was selected initially, the data are written to all areas and read, then the same test is conducted once again with the data where all bits are inverted between 1 and 0. If discord is detected, faulty address, written data, and read data are displayed following the error code 44, and the test is suspended.

#### (4-7) ARP Reset

Data write → reset → clear check

#### (4-8) ARP Interrupt

Data transfer to ARP → interrupt detection check

### 5. AV Decoder

#### (5-2) AVdec Register (IC602)

Data write → read matching check

#### (5-3) AVdec DRAM

Data write → read, and accord check

Error 51: AVD RAM read data discord

The program code data stored in ROM (IC103) are copied to all areas of RAM (IC603, IC604) connected to the AVD (IC602) through the bus, then they are read and checked if they accord. Further, the same test is conducted once again with the data where all bits are inverted between 1 and 0. If discord is detected, faulty address, written data, and read data are displayed following the error code 51, and the test is suspended.



- (5-4) AVdec DREQ  
Matching check of 5-3 executed via DMA
- (5-5) AVdec Interrupt  
Data transfer to AVD RAM via DMA → interrupt detection check
- (5-6) AVdec Revision  
AVD revision (chip and uCode) display. Error is not detected.
- (5-7) AVdec Reset  
Data write → no reset data

## 6. OSD (IC802)

- (6-2) OSD Register
  - (6-3) OSD DRAM
  - (6-4) OSD Download
  - (6-5) OSD Interrupt
  - (6-6) OSD Reset
- } Nothing is done.  
\*OSD check is executed.  
(Serial interface only)

## 7. FBI, SACD

- (7-2) FBI Register & DRAM (IC702)  
Data writing to FBI DRAM → read matching check
- (7-3) FBI Interrupt  
FBI DVA interrupt detection check
- (7-4) FBI Reset  
Nothing is done. \*Executed only for the serial interface.
- (7-5) SACD Register & DRAM (IC901)  
DRAM of SACD is checked, and whether the checking has successfully completed is detected.

## 8. Video

- (8-2) Venc Video Out  
Venc (IC106) color bar command write → Video OUT  
Error: Not detected.  
The command is transferred to the Venc, and the color bar signals are output from video terminals.  
They are output from all video terminals (Composite, Y/C, Component) except EURO AV terminal.
- (8-3) OSC (check) → Video  
OSD blue screen display About 1.5 seconds
- (8-4) FBI (check) → Video  
FBI multi screen display (9-screen frame) About 1.5 seconds
- (8-5) AVdec\_DRAM → Video  
AVD gradation display (color patterns) About 1.5 seconds
- (8-6) ARP\_DRAM → Video  
Display with ARP color bar data About 1.5 seconds
- (8-7) Progre Video Out  
Output of ARP color bar data for Progre About 3 seconds

- (8-8) Euro Model Check (AEP, UK model)  
Composite Out  
EURO-AV Composite video output check  
AVD color bar command write → Video (EURO-AV Composite) OUT  
Error: Not detected.  
With the Component of video output turned off, the color bar signals are output from the EURO-AV terminal.

### Y/C Out

- EURO-AV Y/C video output check  
AVD color bar command write → Video (EURO-AV Y/C) OUT  
Error: Not detected.  
With the Y/C of video output turned on, the color bar signals are output from the EURO-AV terminal.

### RGB Out

- EURO-AV RGB video output check  
AVD color bar command write → Video (EURO-AV RGB) OUT  
Error: Not detected.  
With the RGB of video output turned on, the color bar signals are output from the EURO-AV terminal.

### Component Out

- EURO-AV Component video output check  
AVD color bar command write → Video (EURO-AV Component) OUT  
Error: Not detected.  
With the Component of video output turned on, the color bar signals are output from the EURO-AV terminal.

### Euro AV Through

- Euro-AV2 input check.  
Check video and audio signal pass through from Euro-AV2 to Euro-AV1.  
Error: Not detected.

## 9. Audio

- (9-2) Analog Out (Dac/Dout)  
AC3 data output → Three-time beeping  
Check first beep for 0dB, second beep for -6dB, and third beep for 0dB.
- (9-3) Analog Out (L/R Check)  
None
- (9-4) SF 44.1 kHz (16.9344 MHz)  
Observe the IC103 pin ⑦ on the AU-226 board with the oscilloscope to check for the frequency and waveform.
- (9-5) SF 48.0 kHz (18.4320 MHz)  
Observe the IC103 pin ⑦ on the AU-226 board with the oscilloscope to check for the frequency and waveform.

## Check Items List

2. ROM, Model, Region
  - (2-2) ROM Revision
  - (2-3) ROM Check Sum
  - (2-4) Model Type
  - (2-5) Region
3. RAM, EEPROM, NFLASH, H2GA
  - (3-2) RAM write/read
  - (3-3) EEPROM write/read
  - (3-4) NAND FLASH write/read
  - (3-5) H2GA Register
  - (3-6) H2GA Interrupt
  - (3-7) H2GA Reset
4. Servo, ARP
  - (4-2) Servo-DSP Driver Test
  - (4-3) Servo-DSP Register
  - (4-4) Servo-DSP Reset
  - (4-5) ARP Register
  - (4-6) ARP DRAM
  - (4-7) ARP Reset
  - (4-8) ARP Interrupt
5. AV Decoder
  - (5-2) AVdec Register
  - (5-3) AVdec DRAM
  - (5-4) AVdec DREQ
  - (5-5) AVdec Interrupt
  - (5-6) AVdec Revision
  - (5-7) AVdec Reset
6. OSD
  - (6-2) OSD Register
  - (6-3) OSD DRAM
  - (6-4) OSD Download
  - (6-5) OSD Interrupt
  - (6-6) OSD Reset
7. FBI, SACD
  - (7-2) FBI Register & DRAM
  - (7-3) FBI Interrupt
  - (7-4) FBI Reset
  - (7-5) SACD Register & DRAM
8. Video
  - (8-2) Venc Video Out
  - (8-3) OSD (check) → Video
  - (8-4) FBI (check) → Video
  - (8-5) AVdec\_DRAM → Video
  - (8-6) ARP\_DRAM → Video
  - (8-7) Progre Video Out
  - (8-8) Composite Out
  - (8-9) Y/C Out
  - (8-10) RGB Out
  - (8-11) Component Out
  - (8-12) Euro AV Through
9. Audio
  - (9-2) Analog Out (Dac/Dout)
  - (9-3) Analog Out (L/R Check)
  - (9-4) SF 44.1 kHz (16.9344 MHz)
  - (9-5) SF 48.0 kHz (18.4320 MHz)

## Error Codes List

- 00: Error not detected
- 30: RAM write/read data discord
- 31: EEPROM NG
- 32: Flash memory clear error
- 33: Flash memory write error
- 34: Flash memory read data discord
- 35: H2GA Register
- 36: H2GA Interrupt
- 37: H2GA Reset
- 40: Servo DSP NG
- 41: ARP register read data discord
- 42: ARP ↔ RAM data bus error
- 43: ARP ↔ RAM address bus error
- 44: ARP RAM read data discord
- 45: ARP Interrupt NG
- 46: ARP Reset NG
- 50: AVD Register NG
- 51: AVD DRAM NG
- 52: AVD DRAM\_DMA NG
- 53: AVD Reset NG
- 60: OSD Register NG
- 61: OSD DRAM NG
- 62: OSD Initial NG
- 63: OSD Interrupt NG
- 70: FBI Register & DRAM NG
- 71: FBI Interrupt NG
- 72: FBI Initial NG
- 73: SACD Register Error
- 74: SACD DRAM CHECK Error
- 80: ARP → 1930 video NG
- 90: ARP → 1930 audio NG
- A0: System call error (function not supported)
- A1: System call error (parameter error)
- A2: System call error (illegal ID number)
- A3: System call error (time out)
- A4: NAND Flash faulty blocks exceed 10
- F0: Error occurred
- F1: User verification NG
- F2: Diagnosis cancelled

## 6-4. DRIVE AUTO ADJUSTMENT

On the Test Mode Menu screen, press **[1]** key on the remote commander, and the drive auto adjustment menu will be displayed.

```
## Drive Auto Adjustment ##

      Adjustment Menu

0. ALL
1. DVD-SL
2. CD
3. DVD-DL
4. SACD

Exit: RETURN
```

Normally, **[0]** is selected to adjust DVD (single layer), CD, DVD (dual layer), and SACD in this order. But, individual items can be adjusted for the case where adjustment is suspended due to an error. In this mode, the adjustment can be made easily through the operation following the message displayed on the screen.

The disc used for adjustment must be the one specified for adjustment. However, for SACD disc, use the player with initial data if the disc is not available.

### 0. ALL

You will be asked if EEPROM data are initialized or not, and for this prompt, select **[0]** and press the **[ENTER]** key, and the servo set data in EEPROM will be initialized. Then, 1. DVD-SL disc, 2. CD disc, 3. DVD-DL disc, and 4. SACD disc are adjusted in this order. Each time one disc was adjusted, it is ejected. Replace it with the specified disc following the message. Though the message to confirm whether discs other than SACD disc are adjusted is not displayed, you can finish the adjustment if pressing the **[■]** button. The S curve level, RF level, and jitter value can be confirmed during adjustment, and if OK, press the **[ENTER]** key and continue adjustment. (If NG, press the **[■]** button) During adjustment of each disc, the measurement for disc type judgment is made. As automatic adjustment does not judge the disc type unlike conventional models, take care not to insert wrong type discs. Also, do not give a shock during adjustment.

### 1. DVD-SL (single layer)

Select **[1]**, insert DVD single layer disc, and press **[ENTER]** key, and the adjustment will be made through the following steps, then adjusted values will be written to the EEPROM.

#### DVD Single Layer Disc Adjustment Steps

1. Sled Tilt Reset
2. Disc Check Memory SL
3. Wait 500 msec
4. Set Disc Type SL
5. LD ON
6. Spdl Start
7. Wait 1 sec
8. Focus Search ON
9. Focus Search OFF
10. Focus Servo ON 1
11. Auto Track Offset Adjust
12. Tracking ON
13. CLVA ON
14. Wait 1 sec
15. Sled ON
16. Check CLV Lock
17. Auto Loop Filter Offset Adjust
18. Auto Focus Offset Adjust
19. Auto Tilt Position Adjust
20. Auto Focus Gain Adjust
21. Auto Focus Offset Adjust
22. EQ Boost Adjust
23. Auto Loop Filter Offset Adjust
24. Auto Track Gain Adjust
25. All Servo Stop
26. Eep Copy Loop Filter Offset

## 2. CD

Select [2], insert CD disc, and press [ENTER] key, and the adjustment will be made through the following steps, then adjusted values will be written to the EEPROM.

### CD Adjustment Steps

1. Sled Tilt Rest
2. Disc Check Memory CD
3. Wait 500 msec
4. Set Disc Type CD
5. LD ON
6. Spdl Start
7. Wait 1 sec
8. Focus Search ON
9. Focus Search OFF
10. Focus Servo ON 1
11. Auto Track Offset Adjust
12. Tracking ON
13. (TC Display Start)
14. CLVA ON
15. Wait 1 sec
16. Jitter Display Start
17. Sled ON
18. Check CLV ON
19. Auto Loop Filter Offset Adjust
20. Auto Focus Offset Adjust
21. Auto Focus Gain Adjust
22. Auto Focus Offset Adjust
23. Eq Boost Adjust
24. Auto Loop Filter Offset Adjust
25. Auto Track Gain Adjust
26. All Servo Stop

## 3. DVD-DL (dual layer)

Select [3], insert DVD dual layer disc, and press [ENTER] key, and the adjustment will be made through the following steps, then adjusted values will be written to the EEPROM.

### DVD Dual Layer Disc Adjustment Steps

1. Sled Tilt Reset
2. Disc Check Memory DL
3. Wait 500 msec
4. Set Disc Type DL
5. LD ON
6. Spdl Start
7. Wait 1 sec  
Layer 1 Adjust
8. Focus Servo ON 1
9. Auto Track Offset Adjust L1
10. Tracking ON
11. CLVA ON
12. Wait 1 sec
13. Sled ON
14. Check CLV Lock
15. Auto Loop Filter Offset Adjust
16. Auto Focus Offset Adjust
17. Auto Focus Gain Adjust
18. Auto Focus Offset Adjust
19. Eq Boost Adjust
20. Auto Loop Filter Offset
21. Auto Track Gain Adjust  
Layer 0 Adjust
22. Fj (L1 → L0)
23. Auto Track Offset Adjust L0
24. Tracking ON
25. CLVA ON
26. Wait 1 sec
27. Sled ON
28. Check CLV Lock
29. Auto Loop Filter Offset Adjust
30. Auto Focus Offset Adjust
31. Auto Focus Gain Adjust
32. Auto Focus Offset Adjust
33. Eq Boost Adjust
34. Auto Loop Filter Offset
35. Auto Track Gain Adjust
36. All Servo Stop

#### 4. SACD

Select [4], insert SACD disc, and press [ENTER] key, and the adjustment will be made through the following steps, then adjusted values will be written to the EEPROM. However, if SACD disc is not available, use the player with initial data, skipping the SACD adjustment. In this case, you can finish the adjustment if pressing the [■] button.

##### SACD Adjustment Steps

1. Sled Tilt Reset
2. Set Disc Type CD
3. LD ON
4. Spdl Start
5. Wait 1 sec
6. Focus Servo ON 0
7. Auto track Offset Adjust
8. Tracking ON
9. CLVA ON
10. Wait 1 sec
11. Sled ON
12. Check CLV ON
13. Auto Loop Filter Offset Adjust
14. Auto Focus Offset Adjust
15. Auto Focus Gain Adjust
16. Auto Focus Offset Adjust
17. Eq Boost Adjust
18. Auto Loop Filter Offset Adjust
19. Auto Track Gain Adjust
20. All Servo Stop

#### 6-5. DRIVE MANUAL OPERATION

On the Test Mode Menu screen, select [2], and the manual operation menu will be displayed. For the manual operation, each servo on/off control and adjustment can be executed manually.

```
## Drive Manual Operation ##

          Operation Menu
1. Disc type
2. Servo Control
3. Track/Layer Jump
4. Manual Adjustment
5. Auto Adjustment
6. Memory Check

0. Disc Check Memory

          Exit: RETURN
```

In using the manual operation menu, take care of the following points. These commands do not provide protection, thus requiring correct operation. The sector address or time code field is displayed when a disc is loaded.

1. Set correctly the disc type to be used on the Disc Type screen.  
The disc type must be set after a disc was loaded.  
The set disc type is cleared when the tray is opened.
2. After power ON, if the Drive Manual Operation was selected, first perform "Reset SLED TILT" by opening 1. Disc Type screen.
3. In case of an alarm, immediately press the [■] button to stop the servo operation, and turn the power OFF.

Basic operation (controllable from front panel or remote commander)

[POWER]	Power OFF
[■]	Servo stop
[▲] (OPEN/CLOSE)	Stop+Eject/Loading
[RETURN]	Return to Operation Menu or Test Mode Menu
[▶▶], [◀◀]	Transition between sub modes of menu
[1] to [9], [0]	Selection of menu items
Cursor [↑]/[↓]	Increase/Decrease in manually adjusted value

## 0. Disc Check Memory

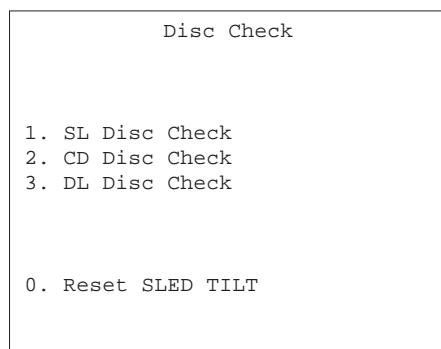

On this screen, the mirror time is measured to judge the disc and it is written to the EEPROM. First load DVD SL disc and press [1], next load CD disc and press [2], and finally load DVD DL disc and press [3].

The adjustment must be executed more than once after default data were written. External vibration or shock to the player must not be given. Reference value for DVD is from 10 to 20, and for CD, from 28 to 4F.

Check that the value of CD is larger than that of DVD.

When those values are beyond a range perform this adjustment again.

From this screen, you can go to another mode by pressing [▶▶] or [◀◀] key, but you cannot enter this mode from another mode. You can enter this mode from the Operation Menu screen only.

### 1. Disc Type

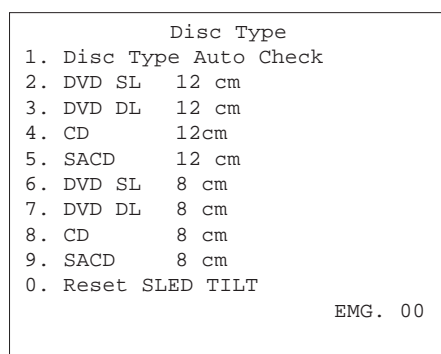

On this screen, select the disc type. To select the disc type, press the number of the loaded disc. The selected disc type is displayed at the bottom. Selecting [1] automatically selects and displays the disc type. In case of wrong display, retry "Disc Check Memory". Also, opening the tray causes the set disc type to be cleared. In this case, set the disc type again after loading.

In performing manual operation, the disc type must be set.

Once the disc type has been selected, the sector address or time code display field will appear as shown below. These values are displayed when PLL is locked.

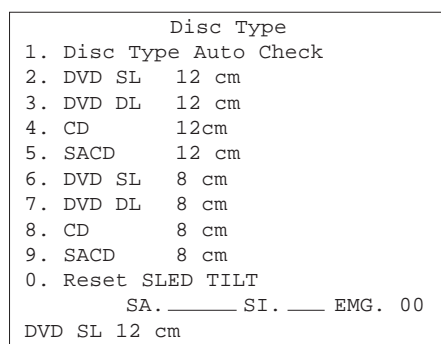

**Display when DVD SL 12cm disc was selected**

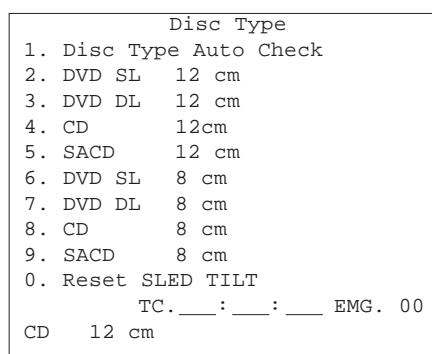

**Display when CD 12cm disc was selected**

[0] Reset SLED TILT      Reset the Sled and Tilt to initial position.

[1] Disk Type Check      Judge automatically the loaded disc. As the judged result is displayed at the bottom of screen, make sure that it is correct.

If Disc Check Memory menu has not been executed after EEPROM default setting, the disc type cannot be judged. In this case, return to the initial menu and make a check for three types of discs (SL, DL, CD).

[2] to [9]      Select the loaded disc. The adjusted value is written to the address of selected disc. No further entry is necessary if [1] was selected.

### 2. Servo Control

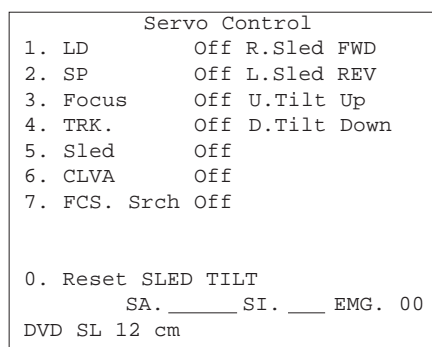

On this screen, the servo on/off control necessary for replay is executed. Normally, turn on each servo from 1 sequentially and when CLVA is turned on, the usual trace mode becomes active. In the trace mode, DVD sector address or CD time code is displayed. This is not displayed where the spindle is not locked.

The spindle could run overriding the control if the spindle system is faulty or RF is not present. In such a case, do not operate CLVA.

- 0 Reset SLED TILT      Reset the Sled and Tilt to initial position.
- 1 LD                    Turn ON/OFF the laser.
- 2 SP                    Turn ON/OFF the spindle.
- 3 Focus                Search the focus and turn on the focus.
- 4 TRK                 Turn ON/OFF the tracking servo.
- 5 Sled                 Turn ON/OFF the sled servo.
- 6 CLVA                Turn ON/OFF normal servo of spindle servo.
- 7 FCS. Srch            Apply same voltage as that of focus search to the focus drive to check the focus drive system.
- Sled FWD            Move the sled outward. Perform this operation with the tracking servo turned off.
- ← Sled REV            Move the sled inward. Perform this operation with the tracking servo turned off.
- ↑ Tilt UP              Move the tilt upward.
- ↓ Tilt DOWN            Move the tilt downward.

The following menus are normally not used.  
The persons who do not know well about these menus should not use them.

**3. Track/Layer Jump**  
**4. Manual Adjustment**  
**5. Auto Adjustment**

**6. Memory Check**

```

EEPROM DATA
          CD      -- DVD --
ID No.  xx      SACL SL  L0  L1
Focus Gain  xx xx  xx xx xx
TRK. Gain  xx xx  xx xx xx
Focus Offset xx xx  xx xx xx
TRK. Offset xx xx  xx xx xx
L. F. Offset xx xx  xx xx xx
EQ Boost  xx xx  xx xx xx
Jitter      xx xx  xx xx xx
Mirror Time  xx    xx xx
-          CLEAR: Default Set

```

This screen displays current servo adjusted data stored in the EEPROM. Though adjusted data can be initialized with the [CLEAR] key, they cannot be restored after initialization. So, before clearing, make a note of the adjusted data. For reference, the drive has been designed so that the gain center value is 20 and offset value is 80. Other values will be in a range of 10 to 80. If extreme value such as 00 or FF is set, adjustment will be faulty. In such a case, check for disc scratch or cable disconnection, then perform adjustment again.

**6-6. MECHA AGING**

```

### Mecha Aging ###

Press OPEN key

Abort: STOP key

```

On the Test Mode Menu screen, selecting [3] executes the aging of mechanism. First, open the tray and load a disc. Press the [▶] key, and the aging will start. When the tray is closed, the disc type and size are judged and displayed. During aging, the repeat cycle is displayed. Aging can be aborted at any time by pressing the [■] key. After the operation has stopped, unload the disc and press again the [■] key or the [RETURN] key to return to the Test Mode Menu.

**6-7. EMERGENCY HISTORY**

```

### EMG. History ###

Laser Hours      CD  xxxxxxxxh
                  DVD xxxxxxxxh

1. 00 00 00 00 00 00 00 00
   00 00 00 00 00 00 00 00

2. 00 00 00 00 00 00 00 00
   00 00 00 00 00 00 00 00

Select: 1 - 9  Scroll: UP/DOWN
(1: Last EMG.) Exit: RETURN

```

On the Test Mode Menu screen, selecting [4] displays the information such as servo emergency history. The history information from last 1 up to 10 can be scrolled with [↑] key or [↓] key. Also, specific information can be displayed by directly entering that number with ten keys.

The upper two lines display the laser ON total hours. Data below minutes are omitted.

**Clearing History Information**

- Clearing laser hours
  - ⊙ Press [DISPLAY] and [CLEAR] keys in this order. Both CD and DVD data are cleared.
- Clearing emergency history
  - ⊙ Press [TITLE] and [CLEAR] keys in this order.
- Initializing set up data
  - ⊙ Press [DVD] and [CLEAR] keys in this order. The data have been initialized when "Set Up Initialized" message is displayed. The EMG. History screen will be restored soon.

## How to see Emergency History

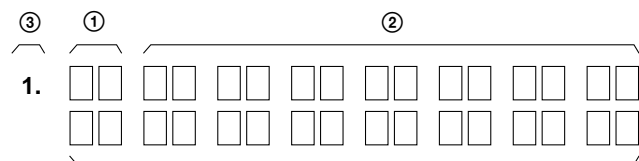

①: Emergency Code

②: Don't Care

These codes are used for verification of software designing.

③: Historical order 1 to 9

## Emergency Codes List

- 10: Communication to IC001 (TK-58 board) failed.
- 11: Each servo for focus, tracking, and spindle is unlocked.
- 12: Communication to EEPROM, IC101 (MB-91 board) failed.
- 13: Writing of hours meter data to EEPROM, IC101 (MB-91 board) failed.
- 14: Communication to Servo DSP IC404 (MB-91 board) failed, or Servo DSP is faulty.
- 20: Initialization of tilt servo and sled servo failed. They are not placed in the initial position.
- 21: Tilt servo operation error
- 22: Syscon made a request to move the tilt servo to wrong position.
- 23: Sled servo operation error
- 24: Syscon made a request to move the sled servo to wrong position.
- 30: Tracking balance adjustment error
- 31: Tracking gain adjustment error
- 32: Focus balance adjustment error
- 33: Focus bias adjustment error
- 34: Focus gain adjustment error
- 35: Tilt servo adjustment error
- 36: RF equalizer adjustment error
- 37: RF group delay adjustment error
- 38: Jitter value after adaptive servo operation is too large.
- 40: Focus servo does not operate.
- 41: With a dual layer (DL) disc, focus jump failed.50: CLV (spindle) servo does not operate.
- 51: Spindle does not stop.
- 60: With a DVD disc, Syscon made a request to seek nonexistent address.
- 61: With a CD disc, Syscon made a request to seek nonexistent address.
- 62: With a CD disc, Syscon made a request to seek nonexistent track No. and index No.
- 63: With a DVD disc, seeking of target address failed.
- 64: With a CD disc, seeking of target address failed.
- 65: With a CD disc, seeking of target index failed.
- 70: With a DVD disc, physical information data could not be read.
- 71: With a CD disc, TOC data could not be read.
- 80: Disc type judgment failed.
- 81: As disc type judgment failed, retry was repeated.
- 82: As disc type judgment failed, a measurement error occurred.
- 83: Disc type could not be judged within the specified time.
- 84: Illegal command code was received from Syscon.
- 85: Illegal command was received from Syscon.

## 6-8. VERSION INFORMATION

```

## Version Information ##
IF con.   Ver. x. xxx (xxxx)
          Group    00

SYScon.   Ver. x. xxx (xxxx)
          Model    xx
          Region   0x
Servo DSP. Ver. 1. xxxxx

Exit: RETURN
    
```

On the Test Mode Menu screen, selecting **[5]** displays the ROM version and region code.

The parenthesized hexadecimal number in version field is checksum value of ROM.

## 6-9. VIDEO LEVEL ADJUSTMENT

On the Test Mode Menu screen, selecting **[7]** displays color bars for prog level adjustment. During display of color bars, OSD disappears but the menu screen will be restored if pressing any key.

### 1. INTERLACE VIDEO LEVEL ADJUSTMENT

Measurement point : VIDEO OUT  
(75 Ω terminating resistance)

Measuring instrument : Oscilloscope  
Adjustment device : RV102 on VP-52 board  
Specified value :  $1.00^{+0.04}_{-0.02}$  Vp-p

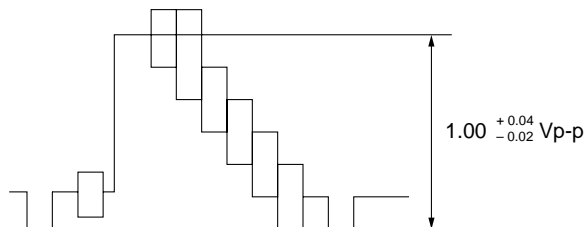

Measurement point : COMPONENT VIDEO OUT (Y)  
(75 Ω terminating resistance)

Measuring instrument : Oscilloscope  
Adjustment device : RV101 on VP-52 board  
Specified value :  $1.00^{+0.04}_{-0.02}$  Vp-p

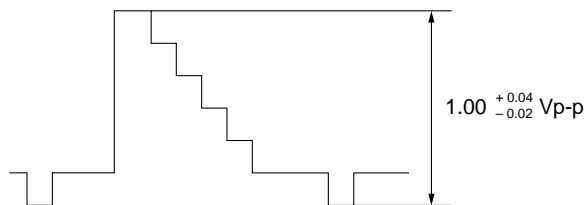



On the Test Mode Menu screen, selecting **[7]** displays color bars for prog level adjustment. During display of color bars, OSD disappears but the menu screen will be restored if pressing any key.

## 2. PROG VIDEO LEVEL ADJUSTMENT

Measurement point : COMPONENT VIDEO OUT (Y)  
(75 Ω terminating resistance)

Measuring instrument: Oscilloscope

Adjustment device : RV401 on VP-52 board

Specified value :  $1.00^{+0.04}_{-0.02}$  Vp-p

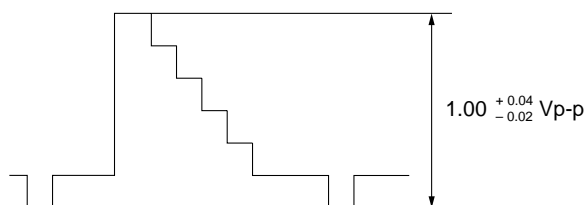

## 6-10. IF CON SELF DIAGNOSTIC FUNCTION

### 1. FL-114 BOARD (IF CON) TEST MODE

The front board test mode is the IF CON self diagnostic mode. The IF CON can diagnose the functions of the front panel boards that the IF CON controls. Normally, the IF CON makes a serial communication with the SYSTEM CONTROL and operates following the commands from the SYSTEM CONTROL, but in the Test mode, the IF CON operates independently from the SYSTEM CONTROL.

In the Test mode, the following functions can be checked.

1. Button function
2. Remocon receiving function
3. SYSTEM CONTROL-IF CON serial communication
4. Click shuttle function
5. Fluorescent display tube lighting check
  - Grid check
  - Anode check
6. LED control function
7. DIMMER test
8. BEEP test
9. SOUND test
10. SCACE test
11. FADE IN/OUT test

In the Test mode, the set operates same as usual, except voltage monitoring, communication monitoring, display of fluorescent display tube, and LED control.

1. The routine that monitors +3.3 V (PCONT) of MB-91 board is not provided.
2. The monitoring timer for serial communication with the SYSTEM CONTROL is not provided. The set is not placed in the Standby mode, even if the communication with SYSTEM CONTROL is normal.
3. Display of fluorescent display tube (normally, display is made following the commands from SYSTEM CONTROL)
4. LED control (normally, control is made following the commands from SYSTEM CONTROL)

### 2. OPERATION OF SELF CHECK MODE

The Self Check mode is the function to conduct the basic test to the FL display and DVD panel section.

#### 2-1. Self Check Mode Transition Processing

At the AC Power ON after IF CON was reset (assuming that the MB-91 board is not connected). While pressing the **[STOP]** key on the main unit with the IF CON in STANDBY mode, enter **[RETURN]** → **[DISPLAY]** (or **[SET UP]**) on the remote commander, and the unit transits to the Self Check Mode. The Self Check mode terminates when the IF CON transits to the STANDBY mode.

## 2-2. Operation of Auto Self Check

When the Self Check mode becomes active at the AC Power ON or by key input, the test display of the following steps (1) to (4) is repeated.

(1) FLD and LED all ON (for 5 seconds)

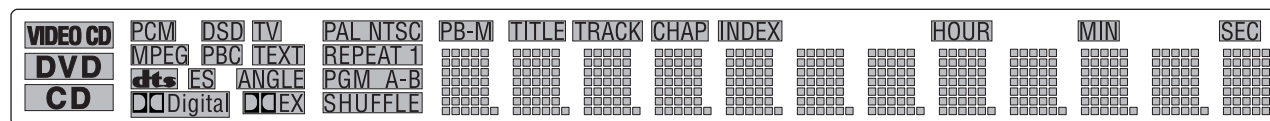

(2) MODEL display (for 2 seconds)

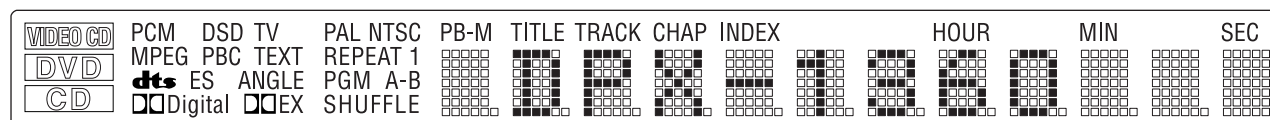

(3) Version display (for 2 seconds)

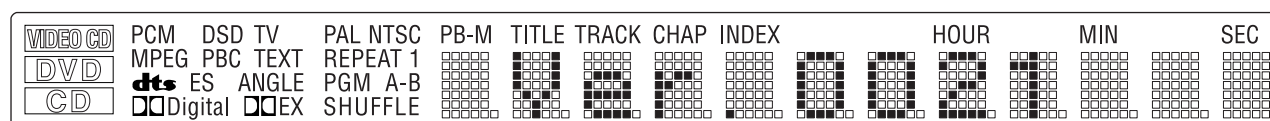

(4) ROM creation date display (for 2 seconds)

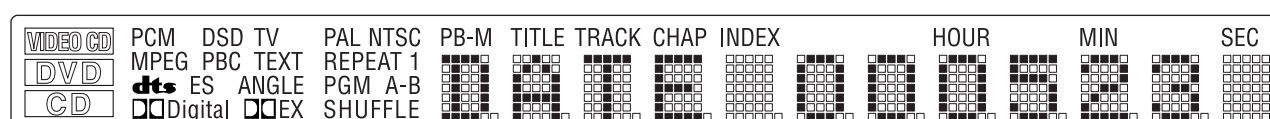

### 2-3. Each Self Check Function

Each Self Check function tests the FLD display, LED display, and key input.

Basic, Entry-DD, Step Up-DD

Input Voltage [V]	IC204: Pin No. (Signal)	
	Pin ⑦⑨ (AN6)	Pin ⑧⑩ (AN7)
0 – 0.150	EJECT	AUDIO DIRECT
0.467 – 0.767	PLAY	NEXT
1.295 – 1.595	PAUSE	PREVIOUS
2.112 – 2.412	STOP	

#### 1-3-1. FLD and LED All ON

##### 1-3-1-1. Transition Keys in Self Check Mode

- Mode Select mode with DVD MENU on remote commander
- Select the TEST ALL mode with the RIGHT or LEFT on the remote commander, and then press the RETURN key on remote commander.

##### 2-3-1-2. Operation and Display

In this mode, all LEDs except STANDBY LED and all segments of FLD turn ON.

Example of FLD all ON

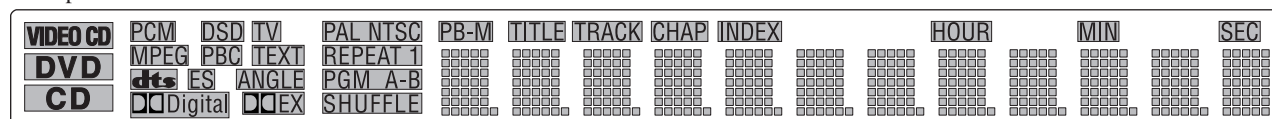

#### 2-3-2. Main Unit Key Name Display and Key Code Display

##### 2-3-2-1. Transition Keys in Self Check Mode

- Mode Select mode with DVD MENU on remote commander
- Select the TEST KEY mode with the RIGHT or LEFT on the remote commander, and then press the RETURN key on remote commander.

##### 2-3-2-2. Operation and Display

When a key on the main unit is pressed in the Self Check mode, the name of that key is displayed on the FLD. Also, the key name display and the key code display can be switched with the [DISPLAY] key on the remote commander. "NOTHING" is displayed when nothing is entered. Also, VIDEO CD, DVD, and CD segments turn on when a communication error occurred.

FLD display (at input of [PLAY] key on the main unit)

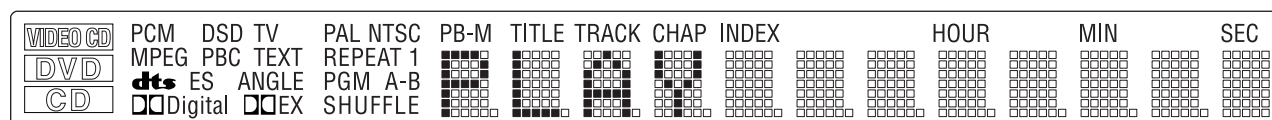

Key code display (at input of **PLAY** key, Key code: 0Ah)

VIDEO CD	PCM	DSD TV	PAL NTSC	PB-M	TITLE	TRACK	CHAP	INDEX		HOUR		MIN		SEC
DVD	MPEG	PBC TEXT	REPEAT 1											
CD	dts	ES ANGLE	PGM A-B											
	Digital	EX	SHUFFLE											

At input of faulty voltage

VIDEO CD	PCM	DSD TV	PAL NTSC	PB-M	TITLE	TRACK	CHAP	INDEX		HOUR		MIN		SEC
DVD	MPEG	PBC TEXT	REPEAT 1											
CD	dts	ES ANGLE	PGM A-B											
	Digital	EX	SHUFFLE											

When two keys are pressed

VIDEO CD	PCM	DSD TV	PAL NTSC	PB-M	TITLE	TRACK	CHAP	INDEX		HOUR		MIN		SEC
DVD	MPEG	PBC TEXT	REPEAT 1											
CD	dts	ES ANGLE	PGM A-B											
	Digital	EX	SHUFFLE											

### 1-3-3. Remote Commander Key Name Display and Key Code Display

#### 1-3-3-1. Transition Keys in Self Check Mode

- Mode Select mode with DVD MENU on remote commander
- Select the TEST REM mode with the RIGHT or LEFT on the remote commander, and then press the RETURN key on remote commander.

#### 2-3-3-2. Operation and Display

When a key on the remote commander is pressed in the Self Check mode, the name of that key is displayed on the FLD. Also, the key name display and the key code display can be switched with the **DISPLAY** key on the remote commander. "NOTHING" is displayed when nothing is entered. Also, VIDEO CD, DVD, and CD segments turn on when a communication error occurred.

Remote commander key name display (at input of **PAUSE** key)

VIDEO CD	PCM	DSD TV	PAL NTSC	PB-M	TITLE	TRACK	CHAP	INDEX		HOUR		MIN		SEC
DVD	MPEG	PBC TEXT	REPEAT 1											
CD	dts	ES ANGLE	PGM A-B											
	Digital	EX	SHUFFLE											

Remote commander key code display (at input of **PAUSE** key, Key code: 39h)

VIDEO CD	PCM	DSD TV	PAL NTSC	PB-M	TITLE	TRACK	CHAP	INDEX		HOUR		MIN		SEC
DVD	MPEG	PBC TEXT	REPEAT 1											
CD	dts	ES ANGLE	PGM A-B											
	Digital	EX	SHUFFLE											

### 2-3-4. Communication Monitoring Display

The communication state is monitored and displayed while the key name on the main unit and the remote commander is displayed. When the communication to the System Controller failed, VIDEO CD, DVD, and CD segments turn on.

Communication error display (at no key input)

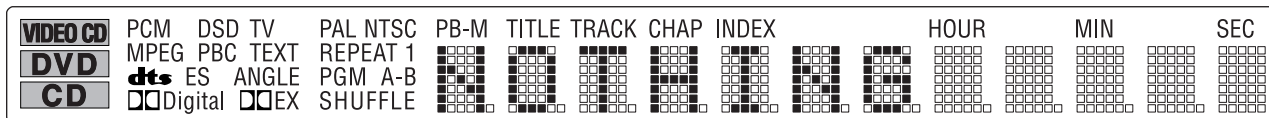

Communication error display (at code display without input of the remote commander)

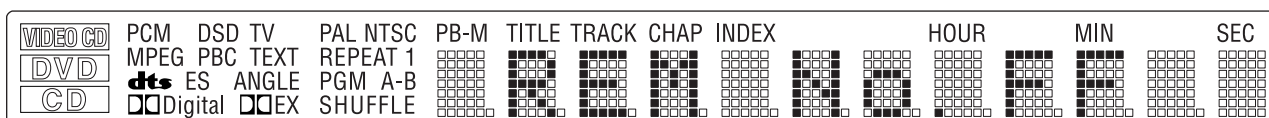

### 2-3-5. FLD Anode Test Display and SHUTTLE Click Operation Test

#### 2-3-5-1. Transition Keys in Self Check Mode

- DVD MENU → RIGHT, LEFT → [TEST ANODE] → RETURN
- SHUTTLE on the main unit and the remote commander during Anode Test display

#### 2-3-5-2. Operation and Display

Only the first segment of each grid of FLD is lit, and the segments of each grid are switched over sequentially by entering the RIGHT or LEFT on the remote commander. The segments are switched to 1-2-3 direction at the input of RIGHT on the remote commander, while they are switched reversely such as 3-2-1 direction at the input of LEFT. This test checks whether each segment makes indication individually.

Display at the start of Anode Test

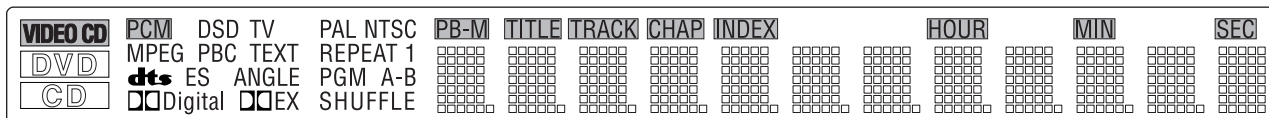

↓ (Input in RIGHT direction)

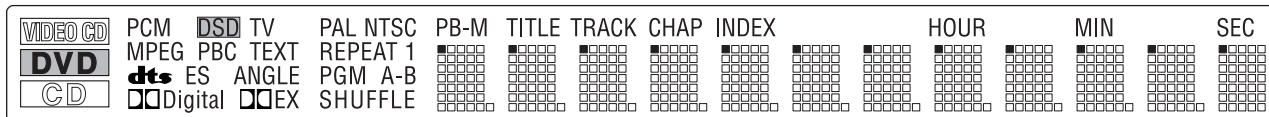

## 2-3-6. FLD Grid Test Display

### 2-3-6-1. Transition Keys in Self Check Mode

- DVD MENU → RIGHT, LEFT → [TEST GRID] → RETURN

### 2-3-6-2. Operation and Display

Only the first grid of FLD is lit, and the grids are switched over sequentially by entering the RIGHT or LEFT on the remote commander. The grids are switched to 1-2-3 direction at the input of RIGHT on the remote commander, while they are switched to 3-2-1 direction at the input of LEFT on the remote commander. This test checks whether each grid makes indication individually.

Display at the start of Grid Test

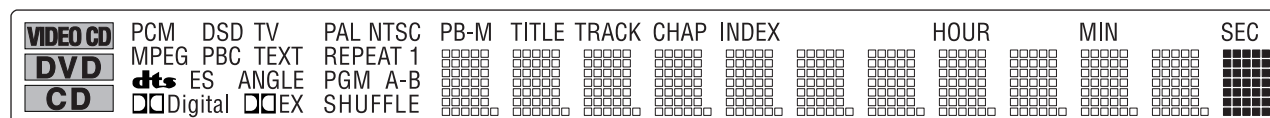

↓ (Input in RIGHT direction)

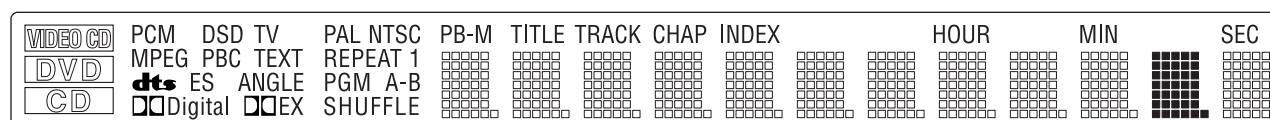

## 2-3-7. LED Test Display

### 2-3-7-1. Transition Keys in Self Check Mode

- DVD MENU → RIGHT, LEFT → [TEST LED] → RETURN
- SHUTTLE on the main unit and the remote commander during LED Test display

### 2-3-7-2. Operation and Display

Grids are switched over sequentially according to the input of RIGHT or LEFT on the remote commander.

FLD display during LED Test

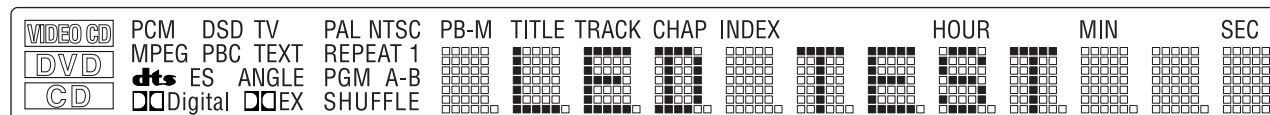

## 2-3-8. Beep Sound Test

### 2-3-8-1. Transition Keys in Self Check Mode

- Input of a key on the set during key test

### 2-3-8-2. Operation and Display

In the Self Check mode, each time a key on the main unit is entered, a beep sound of 2 kHz (100 ms) is generated.

1G		2G			3G	4G	5G	6G	7G	8G	9G	10G	11G	12G	13G	14G	
VIDEO CD	PCM	DSD	TV	PAL	NTSC	PB-M	TITLE	TRACK	CHAP	INDEX			HOUR		MIN		SEC
DVD	MPEG	PBC	TEXT	REPEAT	1												
CD	dt	ES	ANGLE	PGM	A-B												
	Digital	DEX	SHUFFLE														

1-1	2-1	3-1	4-1	5-1	
1-2	2-2	3-2	4-2	5-2	
1-3	2-3	3-3	4-3	5-3	
1-4	2-4	3-4	4-4	5-4	
1-5	2-5	3-5	4-5	5-5	
1-6	2-6	3-6	4-6	5-6	
1-7	2-7	3-7	4-7	5-7	Dp

#### ANODE CONNECTION

	1G	2G	3G	4G	5G	6G	7G	8G	9G	10G	11G	12G	13G	14G
P1	VIDEO	PCM	PB-M	TITLE	TRACK	CHAPT	INDEX	-	-	HOUR	-	MIN	-	SEC
P2	DVD	DSD	1-1	1-1	1-1	1-1	1-1	1-1	1-1	1-1	1-1	1-1	1-1	1-1
P3	CD	MPEG	2-1	2-1	2-1	2-1	2-1	2-1	2-1	2-1	2-1	2-1	2-1	2-1
P4	-	PBC	3-1	3-1	3-1	3-1	3-1	3-1	3-1	3-1	3-1	3-1	3-1	3-1
P5	-	DTS	4-1	4-1	4-1	4-1	4-1	4-1	4-1	4-1	4-1	4-1	4-1	4-1
P6	-	ES	5-1	5-1	5-1	5-1	5-1	5-1	5-1	5-1	5-1	5-1	5-1	5-1
P7	-	D DIG	1-2	1-2	1-2	1-2	1-2	1-2	1-2	1-2	1-2	1-2	1-2	1-2
P8	-	TV	2-2	2-2	2-2	2-2	2-2	2-2	2-2	2-2	2-2	2-2	2-2	2-2
P9	-	TEXT	3-2	3-2	3-2	3-2	3-2	3-2	3-2	3-2	3-2	3-2	3-2	3-2
P10	-	ANGLE	4-2	4-2	4-2	4-2	4-2	4-2	4-2	4-2	4-2	4-2	4-2	4-2
P11	-	DEX	5-2	5-2	5-2	5-2	5-2	5-2	5-2	5-2	5-2	5-2	5-2	5-2
P12	-	PAL	1-3	1-3	1-3	1-3	1-3	1-3	1-3	1-3	1-3	1-3	1-3	1-3
P13	-	NTSC	2-3	2-3	2-3	2-3	2-3	2-3	2-3	2-3	2-3	2-3	2-3	2-3
P14	-	REPEA	3-3	3-3	3-3	3-3	3-3	3-3	3-3	3-3	3-3	3-3	3-3	3-3
P15	-	PGM	4-3	4-3	4-3	4-3	4-3	4-3	4-3	4-3	4-3	4-3	4-3	4-3
P16	-	1	5-3	5-3	5-3	5-3	5-3	5-3	5-3	5-3	5-3	5-3	5-3	5-3
P17	-	A	1-4	1-4	1-4	1-4	1-4	1-4	1-4	1-4	1-4	1-4	1-4	1-4
P18	-	B	2-4	2-4	2-4	2-4	2-4	2-4	2-4	2-4	2-4	2-4	2-4	2-4
P19	-	SHUFF	3-4	3-4	3-4	3-4	3-4	3-4	3-4	3-4	3-4	3-4	3-4	3-4
P20	-	-	4-4	4-4	4-4	4-4	4-4	4-4	4-4	4-4	4-4	4-4	4-4	4-4
P21	-	-	5-4	5-4	5-4	5-4	5-4	5-4	5-4	5-4	5-4	5-4	5-4	5-4
P22	-	-	1-5	1-5	1-5	1-5	1-5	1-5	1-5	1-5	1-5	1-5	1-5	1-5
P23	-	-	2-5	2-5	2-5	2-5	2-5	2-5	2-5	2-5	2-5	2-5	2-5	2-5
P24	-	-	3-5	3-5	3-5	3-5	3-5	3-5	3-5	3-5	3-5	3-5	3-5	3-5
P25	-	-	4-5	4-5	4-5	4-5	4-5	4-5	4-5	4-5	4-5	4-5	4-5	4-5
P26	-	-	5-5	5-5	5-5	5-5	5-5	5-5	5-5	5-5	5-5	5-5	5-5	5-5
P27	-	-	1-6	1-6	1-6	1-6	1-6	1-6	1-6	1-6	1-6	1-6	1-6	1-6
P28	-	-	2-6	2-6	2-6	2-6	2-6	2-6	2-6	2-6	2-6	2-6	2-6	2-6
P29	-	-	3-6	3-6	3-6	3-6	3-6	3-6	3-6	3-6	3-6	3-6	3-6	3-6
P30	-	-	4-6	4-6	4-6	4-6	4-6	4-6	4-6	4-6	4-6	4-6	4-6	4-6
P31	-	-	5-6	5-6	5-6	5-6	5-6	5-6	5-6	5-6	5-6	5-6	5-6	5-6
P32	-	-	1-7	1-7	1-7	1-7	1-7	1-7	1-7	1-7	1-7	1-7	1-7	1-7
P33	-	-	2-7	2-7	2-7	2-7	2-7	2-7	2-7	2-7	2-7	2-7	2-7	2-7
P34	-	-	3-7	3-7	3-7	3-7	3-7	3-7	3-7	3-7	3-7	3-7	3-7	3-7
P35	-	-	4-7	4-7	4-7	4-7	4-7	4-7	4-7	4-7	4-7	4-7	4-7	4-7
P36	-	-	5-7	5-7	5-7	5-7	5-7	5-7	5-7	5-7	5-7	5-7	5-7	5-7
P38	-	-	Dp	Dp	Dp	Dp	Dp	Dp	Dp	Dp	Dp	Dp	Dp	-

### 3. TROUBLESHOOTING

#### 3-1. Test Mode is not activated

With the set assembled in the front panel, the Test mode does not become active if any button was pressed by any reason. Under this condition, the power is not turned on even in the normal status. (The set is kept in Standby status = Red LED is kept on) Not only the buttons are inactive, but also a signal from remote commander is not accepted. To check this condition, with the self check port (pin ② of IF CON) kept in "Low" status, supply the AC power, so that the Test mode is forcibly activated. On the board, short the lands where SELF is printed. The IF CON checks the self check port only after the power on reset (only when AC is supplied; not in Standby status). If any button was pressed, the button name should be displayed on the FL display tube. Though no button is pressed this time, display of other than NOTHING implies that the button was pressed.

#### 3-2. Power is not turned on

- ① Red (STANDBY) LED does not light up when AC was supplied. The power (EVER 3.3 V) is not supplied.  
X201 is oscillating.
- ② Red (STANDBY) LED is kept on though POWER button was pressed. Any button is kept pressed.  
PONCHK (IF CON pin ⑦) is over 0.1 V.
- ③ Green LED lights up when POWER button was pressed, but red LED lights up again after several seconds. PONCHK (IF CON pin ⑦) is abnormal. (Slow rise time from 0.1 V to 1.5 V. Voltage must be less than 1.5 V)  
SYSTEM CONTROL does not operate normally.



## SECTION 7 ELECTRICAL ADJUSTMENT

In making adjustment, refer to 7-4. Adjustment Related Parts Arrangement.

**Note:** During diagnostic check, the characters and color bars can be seen only with the NTSC monitor. Therefore, for diagnostic check, use the monitor that supports both NTSC and PAL modes.

Use the reference disc for PAL for check, and use the reference disc for NTSC for adjustment.

This section describes procedures and instructions necessary for adjusting electrical circuits in this set.

### Instruments required:

- 1) Color monitor TV
- 2) Oscilloscope 1 or 2 phenomena, band width over 100 MHz, with delay mode
- 3) Frequency counter (over 8 digits)
- 4) Digital voltmeter
- 5) Standard commander (RMT-D122A/D122E/D122O/D122P)
- 6) DVD reference disc
  - HLX-501 (J-6090-071-A) (dual layer) (NTSC)
  - HLX-503 (J-6090-069-A) (single layer) (NTSC)
  - HLX-504 (J-6090-088-A) (single layer) (NTSC)
  - HLX-505 (J-6090-089-A) (dual layer) (NTSC)
  - HLX-506 (J-6090-077-A) (single layer) (PAL)
  - HLX-507 (J-6090-078-A)(dual layer) (PAL)
- 7) SACD reference disc
  - HLXA-509 (J-6090-090-A)

## 7-1. POWER SUPPLY CHECK

### 1. AC-113 Board

Mode	E-E
Instrument	Digital voltmeter
EVER + 5 V Check	
Test point	CN106 pin ④
Specification	$5.3 \pm 0.3$ Vdc

#### Checking method:

- 1) Confirm that each voltage satisfies the specification.

### 2. PS-436 Board

Mode	E-E
Instrument	Digital voltmeter
D + 3.3 V Check	
Test point	“CN307 pin ③, ④”
Specification	$3.3 \pm 0.2$ Vdc

#### Checking method:

- 1) Confirm that each voltage satisfies the specification.

### 3. PS-437 Board

Mode	E-E
Instrument	Digital voltmeter
V + SW7 V Check	
Test point	CN201 pin ①
Specification	$7 \pm 0.5$ Vdc
V + 5 V Check	
Test point	CN201 pin ④
Specification	$5.3 \pm 0.3$ Vdc
V -5 V Check	
Test point	CN201 pin ②
Specification	$7 \pm 0.5$ Vdc
+ 12 V Check	
Test point	CN201 pin ⑤
Specification	$12 \pm 0.5$ Vdc
+ 10 V Check	
Test point	“CN203 pin ⑥, ⑦”
Specification	$10.5 \pm 1.0$ Vdc
A + 5 V Check	
Test point	CN203 pin ③
Specification	$5.3 \pm 0.3$ Vdc

#### Checking method:

- 1) Confirm that each voltage satisfies the specification.

## 7-2. ADJUSTMENT OF SYSTEM CONTROL

### 1. System Clock 27 MHz Adjustment (VP-52 BOARD)

#### <Purpose>

27 MHz is the reference clock for the MPEG system, and if it is not adjusted correctly, checking of 22 MHz and 33 MHz lock in the following steps will result in NG.

Mode	E-E
Test point	CN103 pin ①
Instrument	Digital voltmeter
Adjusting element	CT101
Specification	$2.5 \pm 0.1$ V

#### Adjusting method:

- 1) Adjust CT101 to attain  $2.5 \pm 0.1$  V.

## 7-3. ADJUSTMENT OF VIDEO SYSTEM

### 1. Interface Video Output Level Adjustment (VP-52 BOARD)

#### <Purpose>

This adjustment is made to satisfy the NTSC standard, and if not adjusted correctly, the brightness will be too large or small.

Mode	Video level adjustment in test mode
Signal	Color bars
Test point	VIDEO OUT connector (75 $\Omega$ terminated)
Instrument	Oscilloscope
Adjusting element	RV102
Specification	$1.00^{+0.04}_{-0.02}$ Vp-p

#### Adjusting method:

- 1) In the test mode initial menu "6" Video Level Adjustment, set so that color bars are generated.
- 2) Adjust the RV102 to attain  $1.00^{+0.04}_{-0.02}$  Vp-p.



Figure 7-1

### 2. S-terminal Output Check

#### <Purpose>

Check S-terminal video output. If it is incorrect, pictures will not be displayed correctly in spite of connection to the TV with a S-terminal cable.

Mode	Video level adjustment in test mode
Signal	Color bars
Test point	S VIDEO OUT (S-Y) connector (75 $\Omega$ terminated)
Instrument	Oscilloscope
Specification	$1.00 \pm 0.05$ Vp-p

#### Checking method:

- 1) Confirm that the S-Y level is  $1.00 \pm 0.05$  Vp-p.



Figure 7-2

### 3. Checking Component Video Output B-Y

#### <Purpose>

This checks component video output B-Y. If it is incorrect, correct colors will not be displayed when connected to, for instance, projector.

Mode	Video level adjustment in test mode
Signal	Color bars
Test point	COMPONENT VIDEO OUT (B-Y) connector (75 $\Omega$ terminated)
Instrument	Oscilloscope
Specification	$700 \pm 50$ mVp-p

#### Checking method:

- 1) Confirm that the B-Y level is  $700 \pm 50$  mVp-p.

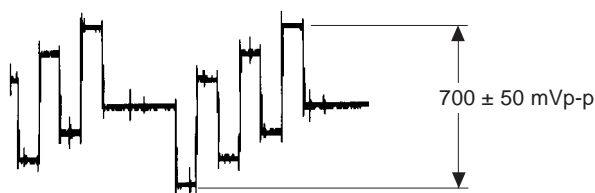

Figure 7-3

#### 4. Checking Component Video Output R-Y

##### <Purpose>

This checks component video output R-Y. If it is incorrect, correct colors will not be displayed when connected to, for instance, projector.

Mode	Video level adjustment in test mode
Signal	Color bars
Test point	COMPONENT VIDEO OUT (R-Y) connector (75 Ω terminated)
Instrument	Oscilloscope
Specification	700 ± 50 mVp-p

##### Checking method:

- 1) Confirm that the R-Y level is 700 ± 50 mVp-p.



Figure 7-4

#### 5. Component Video Output Y Level Adjustment (VP-52 BOARD)

##### <Purpose>

This adjustments component video output Y. If it is incorrect, correct brightness will not be attained when connected to, for instance, projector.

Mode	Video level adjustment in test mode
Signal	Color bars
Test point	COMPONENT VIDEO OUT (Y) connector (75 Ω terminated)
Instrument	Oscilloscope
Adjusting element	RV101
Specification	1.00 <sup>+0.04</sup> / <sub>-0.02</sub> Vp-p

##### Adjusting method:

- 1) In the test mode initial menu "6" Video Level Adjustment, set so that color bars are generated.
- 2) Adjust the RV101 to attain 1.00 <sup>+0.04</sup>/<sub>-0.02</sub> Vp-p

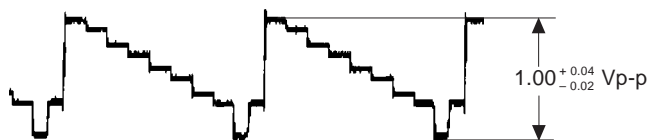

Figure 7-5

#### 6. Progressive Video Output Level Adjustment (VP-52 BOARD)

##### <Purpose>

This adjustments progressive video output. If it is incorrect, correct brightness will not be attained when connected to, for instance, projector.

Mode	Video level adjustment in test mode
Signal	Color bars
Test point	COMPONENT VIDEO OUT (Y) connector (75 Ω terminated)
Instrument	Oscilloscope
Adjusting element	RV401
Specification	1.00 <sup>+0.04</sup> / <sub>-0.02</sub> Vp-p

##### Adjusting method:

- 1) In the test mode initial menu "7" Prog Level Adjustment, set so that color bars are generated.
- 2) Adjust the RV401 to attain 1.00 <sup>+0.04</sup>/<sub>-0.02</sub> Vp-p



Figure 7-6

#### 7. Checking RGB Output R (AEP, UK Model)

##### <Purpose>

This checks RGB output R. If it is incorrect, pictures will not be displayed correctly in spite of connection to the TV with an EURO AV connecting cord.

Mode	In test mode, Push [0] for Syscon Diagnosis and push [8] for Video and push [8] and [ENTER] for Euro TV Check and push [NEXT] twice for RGB out
Signal	Color bars
Test point	EURO AV 1 (RGB)-TV connector pin ⑮ (75 Ω terminated)
Instrument	Oscilloscope
Specification	700 ± 50 mVp-p

##### Checking method:

- 1) Confirm that the R level is 700 ± 50 mVp-p.



Figure 7-7

## 8. Checking RGB Output G (AEP, UK Model)

### <Purpose>

This checks RGB output G. If it is incorrect, pictures will not be displayed correctly in spite of connection to the TV with an EURO AV connecting cord.

Mode	In test mode, Push <b>[0]</b> for Syscon Diagnosis and push <b>[8]</b> for Video and push <b>[8]</b> and <b>[ENTER]</b> for Euro TV Check and push <b>[NEXT]</b> twice for RGB out
Signal	Color bars
Test point	EURO AV 1 (RGB)-TV connector pin <b>⑩</b> (75 Ω terminated)
Instrument	Oscilloscope
Specification	700 ± 50 mVp-p

### Checking method:

- 1) Confirm that the G level is 700 ± 50 mVp-p.

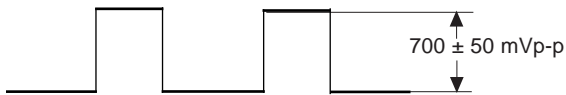

Figure 7-8

## 9. Checking RGB Output B (AEP, UK Model)

### <Purpose>

This checks RGB output B. If it is incorrect, pictures will not be displayed correctly in spite of connection to the TV with an EURO AV connecting cord.

Mode	In test mode, Push <b>[0]</b> for Syscon Diagnosis and push <b>[8]</b> for Video and push <b>[8]</b> and <b>[ENTER]</b> for Euro TV Check and push <b>[NEXT]</b> twice for RGB out
Signal	Color bars
Test point	EURO AV 1 (RGB)-TV connector pin <b>⑦</b> (75 Ω terminated)
Instrument	Oscilloscope
Specification	700 ± 50 mVp-p

### Checking method:

- 1) Confirm that the B level is 700 ± 50 mVp-p.



Figure 7-9

## 10. Checking S Video Output S-C

### <Purpose>

This checks whether the S-C satisfies the NTSC Standard. If it is not correct, the colors will be too dark or light.

Mode	Video level adjustment in test mode
Signal	Color bars
Test point	S VIDEO OUT (S-C) connector (75 Ω terminated)
Instrument	Oscilloscope
Specification	A = 286 ± 30 mVp-p (NTSC) A = 300 ± 100 mVp-p (PAL)

### Checking method:

- 1) In the test mode initial menu "6" Video Level Adjustment, set so that color bars are generated.
- 2) Confirm that the S-C burst is "A".

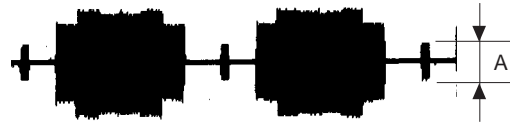
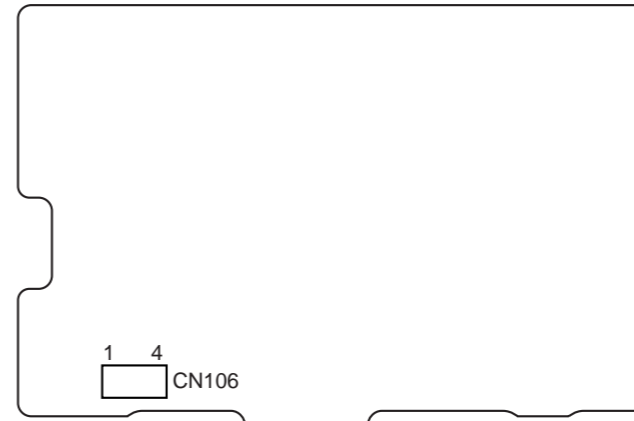

Figure 7-10

7-4. ADJUSTMENT RELATED PARTS ARRANGEMENT

AC-113 BOARD (Side A)



PS-436 BOARD (Side A)

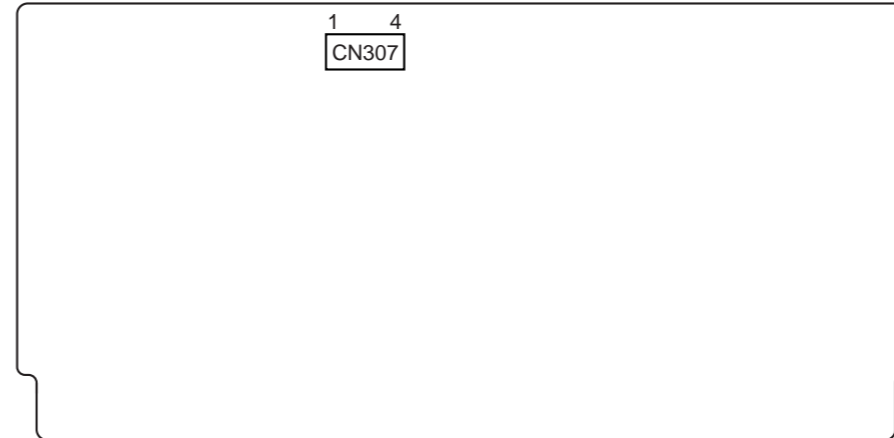

PS-437 BOARD (Side A)

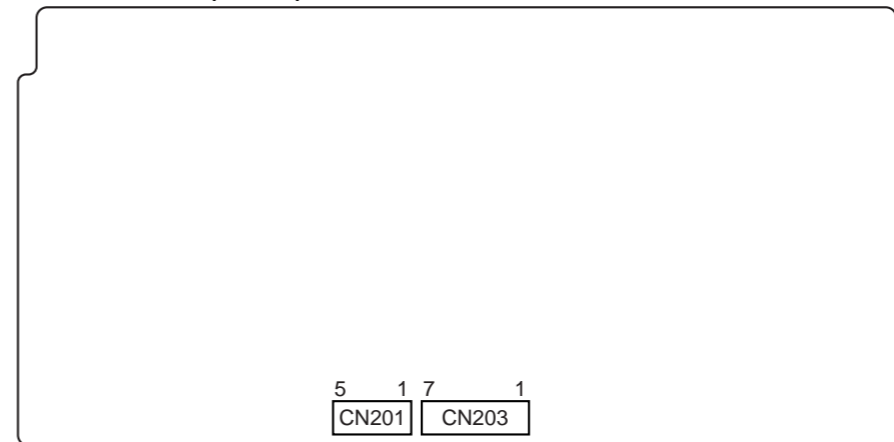

VP-52 BOARD (Side A)

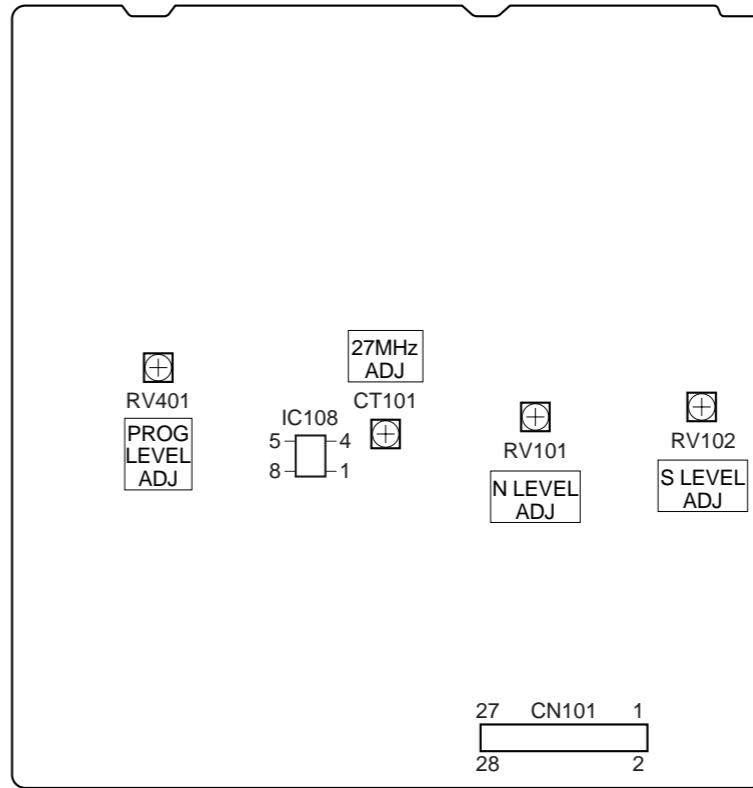

## SECTION 8 REPAIR PARTS LIST

### 8-1. EXPLODED VIEWS

**NOTE:**

- -XX and -X mean standardized parts, so they may have some difference from the original one.
- Items marked "\*" are not stocked since they are seldom required for routine service. Some delay should be anticipated when ordering these items.
- Abbreviation  
 AUS : Australian model    CND : Canadian model  
 CN : Chinese model        HK : Hong Kong model
- The mechanical parts with no reference number in the exploded views are not supplied.
- Hardware (# mark) list and accessories and packing materials are given in the last of the electrical parts list.

The components identified by mark  $\Delta$  or dotted line with mark  $\Delta$  are critical for safety. Replace only with part number specified.

Les composants identifiés par une marque  $\Delta$  sont critiques pour la sécurité. Ne les remplacer que par une pièce portant le numéro spécifié.

#### 8-1-1. CASE ASSEMBLY

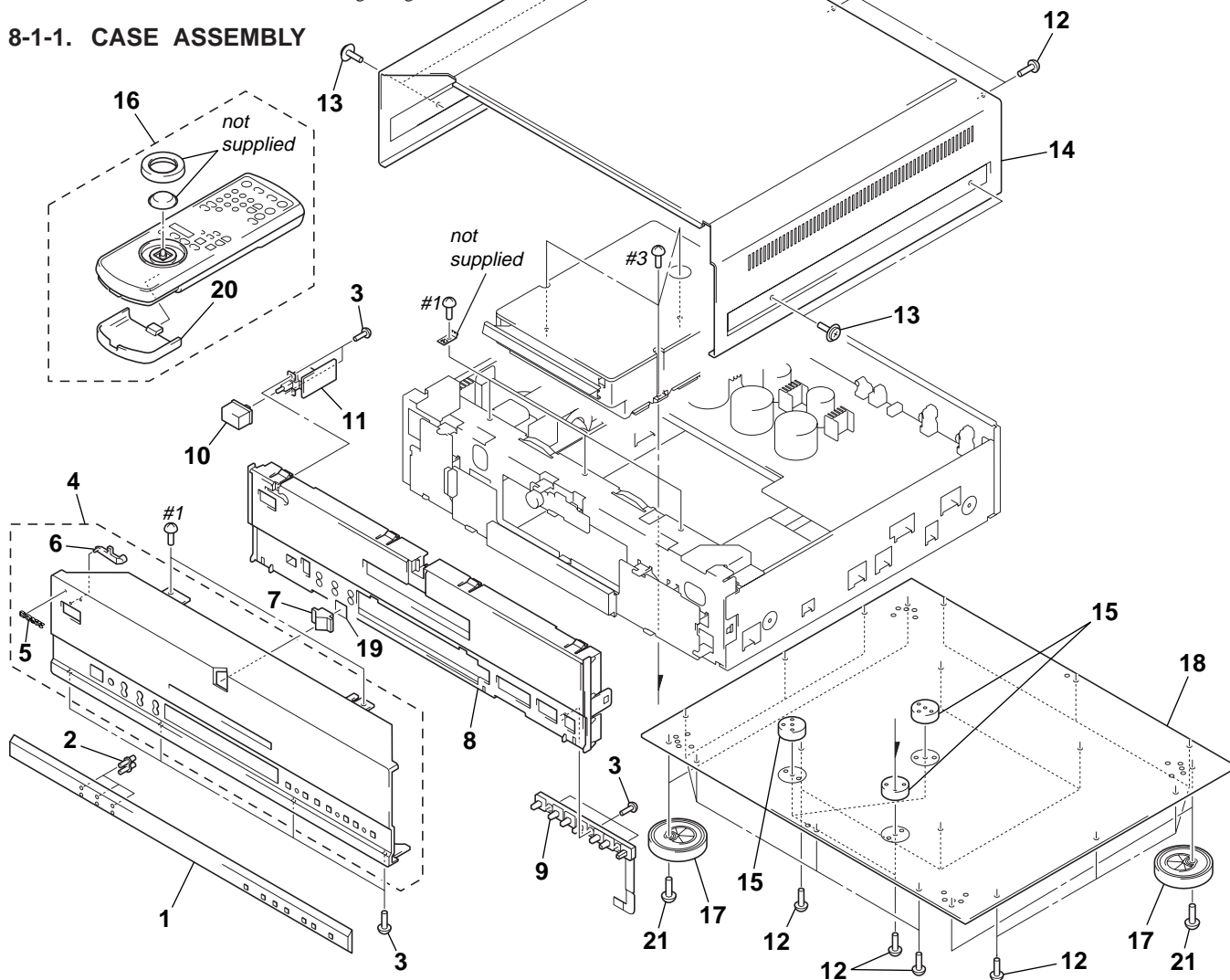

Ref. No.	Part No.	Description	Remark	Ref. No.	Part No.	Description	Remark
1	3-063-216-01	WINDOW, INDICATION (EXCEPT US, CND)		13	3-710-901-61	SCREW, TAPPING (EXCEPT US, CND)	
1	3-063-216-11	WINDOW, INDICATION (US, CND)		14	X-3951-127-3	CASE ASSY, TOP (EXCEPT US, CND)	
2	3-063-214-01	INDICATOR (FU)		14	X-3951-126-3	CASE ASSY, TOP (US, CND)	
3	4-951-620-01	SCREW (2.6X8), +BVTP		15	3-063-189-01	BRACKET, MD	
4	X-3950-874-1	PANEL (AL-G) ASSY, FRONT (EXCEPT US, CND)		16	1-476-249-11	COMMANDER, STANDARD (RMT-D122A) (US, CND)	
4	X-3950-875-1	PANEL (AL-B) ASSY, FRONT (US, CND)		16	1-476-249-31	COMMANDER, STANDARD (RMT-D122P) (AEP, UK)	
5	4-942-568-01	EMBLEM (NO.5), SONY (US, CND)		16	1-476-249-41	COMMANDER, STANDARD (RMT-D122E) (HK, CN)	
5	4-942-568-31	EMBLEM (NO.5), SONY (EXCEPT US, CND)		16	1-476-249-51	COMMANDER, STANDARD (RMT-D122O) (AUS)	
6	3-063-212-01	INDICATOR (POWER)		17	X-3951-082-1	FOOT ASSY	
7	3-063-215-01	INDICATOR (TOP)		18	X-3951-122-3	BASE ASSY	
8	X-3951-113-1	PANEL (M-G) ASSY, FRONT (EXCEPT US, CND)		19	3-063-217-01	ILLUMINATOR (TOP)	
8	X-3951-114-1	PANEL (M-B) ASSY, FRONT (US, CND)		20	3-709-493-01	COVER, BATTERY (for RMT-D122E/D122O/ D122P) (EXCEPT US, CND)	
9	1-476-236-11	SWITCH BLOCK, CONTROL		20	3-709-493-11	COVER, BATTERY (for RMT-D122A) (US, CND)	
10	4-923-520-01	KNOB, POWER (US, CND)		21	3-066-209-01	SCREW	
10	4-923-520-61	KNOB, POWER (EXCEPT US, CND)					
* 11	A-6065-572-A	SW-344 BOARD, COMPLETE					
12	3-053-984-11	SCREW (+BV/CU)					
13	3-710-901-11	SCREW, TAPPING (US, CND)					

## 8-1-2. CHASSIS ASSEMBLY

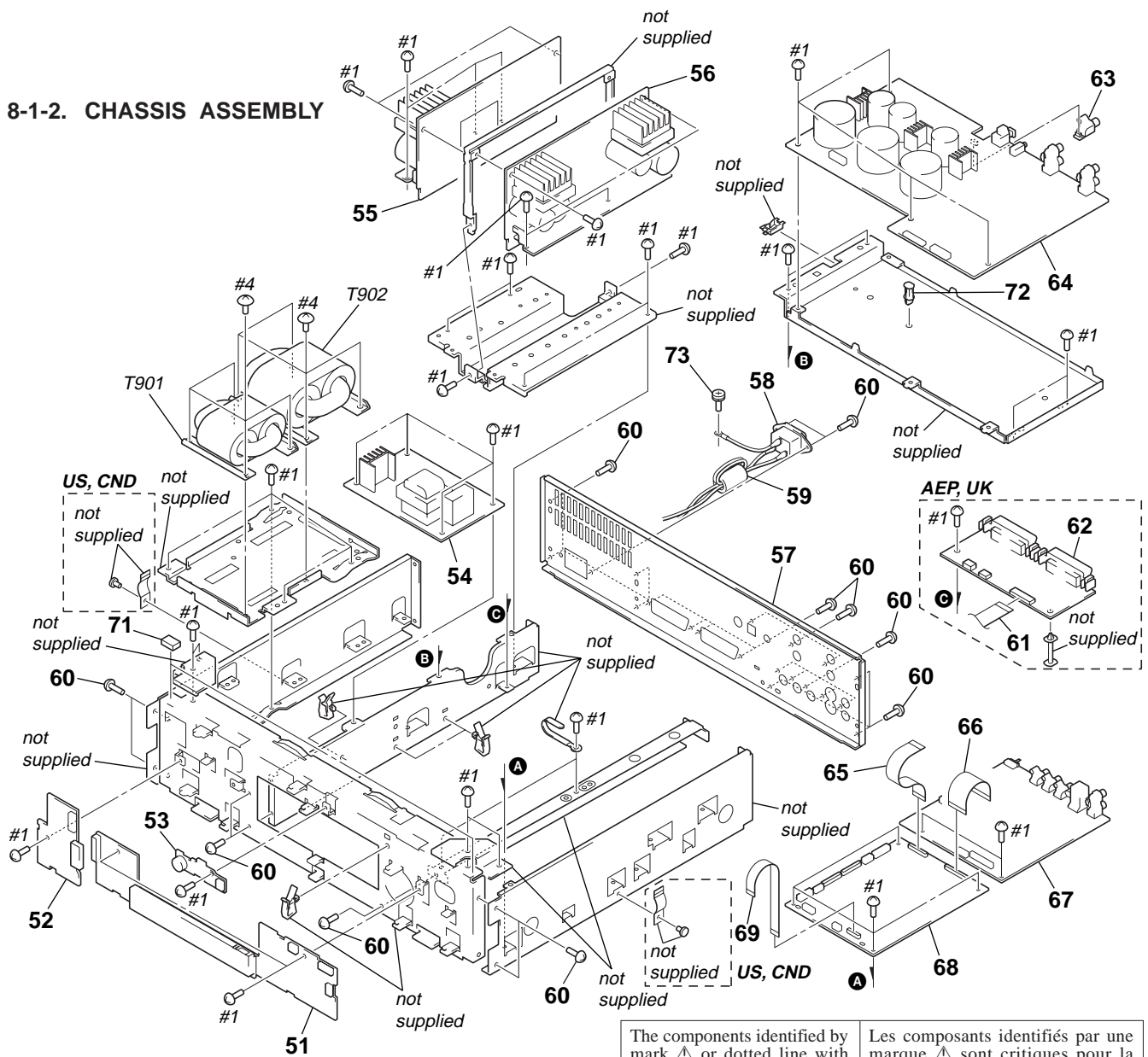

The components identified by mark  $\Delta$  or dotted line with mark  $\Delta$  are critical for safety. Replace only with part number specified.

Les composants identifiés par une marque  $\Delta$  sont critiques pour la sécurité. Ne les remplacer que par une pièce portant le numéro spécifié.

Ref. No.	Part No.	Description	Remark	Ref. No.	Part No.	Description	Remark
* 51	A-6065-569-A	FL-114 BOARD, COMPLETE (US, CND)		* 64	A-6065-580-A	AU-226 BOARD, COMPLETE (AEP, UK)	
* 51	A-6065-586-A	FL-114 BOARD, COMPLETE (EXCEPT US, CND)		* 64	A-6065-588-A	AU-226 BOARD, COMPLETE (HK, CN, AUS)	
* 52	A-6065-570-A	FR-172 BOARD, COMPLETE		* 64	A-6065-593-A	AU-226 BOARD, COMPLETE (US, CND)	
* 53	A-6065-573-A	BZ-1 BOARD, COMPLETE		65	1-757-064-11	CABLE, FLEXIBLE FLAT (FMA-19)	
* 54	A-6065-583-A	AC-114 BOARD, COMPLETE	(EXCEPT US, CND)	66	1-757-067-11	CABLE, FLEXIBLE FLAT (FMV-21)	
* 54	A-6065-595-A	AC-113 BOARD, COMPLETE (US, CND)		* 67	A-6065-581-A	VP-52 BOARD, COMPLETE (AEP, UK)	
* 55	A-6065-577-A	PS-436 BOARD, COMPLETE (US, CND)		* 67	A-6065-594-A	VP-52 BOARD, COMPLETE (EXCEPT AEP, UK)	
* 55	A-6065-584-A	PS-438 BOARD, COMPLETE	(EXCEPT US, CND)	* 68	A-6065-579-A	MB-91 BOARD, COMPLETE (AEP, UK)	
* 56	A-6065-578-A	PS-437 BOARD, COMPLETE (US, CND)		* 68	A-6065-587-A	MB-91 BOARD, COMPLETE (HK)	
* 56	A-6065-585-A	PS-439 BOARD, COMPLETE (AEP, UK)		* 68	A-6065-590-A	MB-91 BOARD, COMPLETE (CN)	
* 56	A-6065-589-A	PS-439 BOARD, COMPLETE (HK, CN, AUS)		* 68	A-6065-591-A	MB-91 BOARD, COMPLETE (AUS)	
57	X-3951-186-1	FRAME ASSY, REAR (US, CND)		* 68	A-6065-592-A	MB-91 BOARD, COMPLETE (US, CND)	
57	X-3951-187-1	FRAME ASSY, REAR (AEP, UK)		69	1-757-066-11	CABLE, FLEXIBLE FLAT (FMF-41)	
57	X-3951-188-1	FRAME ASSY, REAR (HK, CN, AUS)		71	3-312-987-01	CUSHION	
58	1-794-774-11	INLET ASSY, AC (US, CND)		* 72	3-669-610-00	SPACER	
58	1-794-774-21	INLET ASSY, AC (EXCEPT US, CND)		73	3-063-192-01	+PSTT S4	
59	1-500-386-11	FILTER, CLAMP (FERRITE CORE)		$\Delta$ T901	1-435-680-11	TRANSFORMER, POWER (AUDIO) (US, CND)	
60	3-053-984-11	SCREW (+BV/CU)		$\Delta$ T901	1-435-681-11	TRANSFORMER, POWER (AUDIO)	(EXCEPT US, CND)
61	1-757-069-11	CABLE, FLEXIBLE FLAT (FVE-1) (AEP, UK)		$\Delta$ T902	1-435-683-11	TRANSFORMER, POWER (VIDEO/SYSCON)	(US, CND)
* 62	A-6065-582-A	ER-11 BOARD, COMPLETE (AEP, UK)		$\Delta$ T902	1-435-684-11	TRANSFORMER, POWER (VIDEO/SYSCON)	(EXCEPT US, CND)
* 63	A-6065-640-A	CO-26 BOARD, COMPLETE					



### 8-1-3. MECHANISM DECK ASSEMBLY

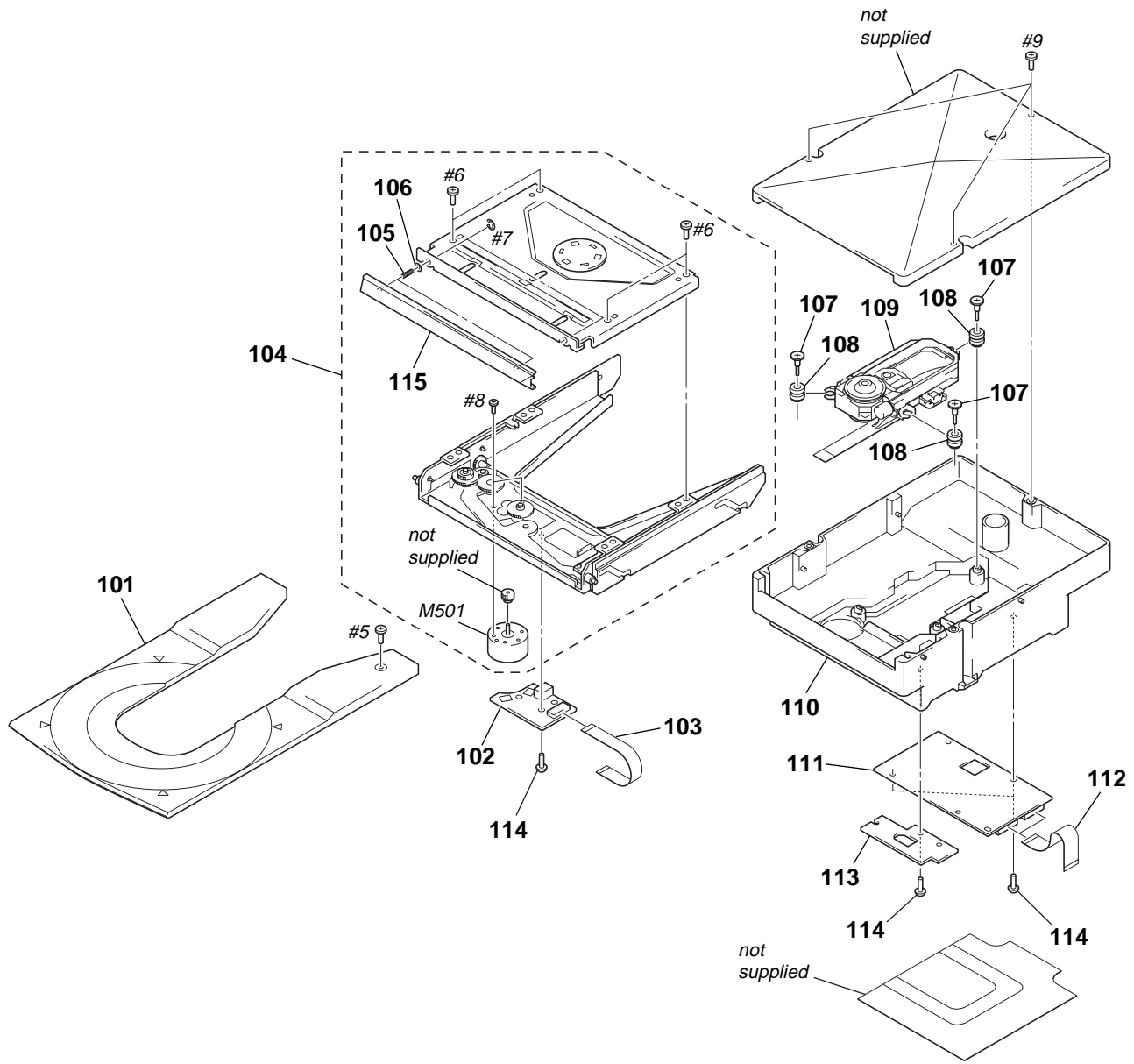

<p>The components identified by mark <math>\triangle</math> or dotted line with mark <math>\triangle</math> are critical for safety. Replace only with part number specified.</p>	<p>Les composants identifiés par une marque <math>\triangle</math> sont critiques pour la sécurité. Ne les remplacer que par une pièce portant le numéro spécifié.</p>
---	--

Ref. No.	Part No.	Description	Remark	Ref. No.	Part No.	Description	Remark
101	X-3950-950-1	TRAY ASSY		$\triangle$ 109	A-6062-397-A	SERVICE ASSY, KHM-220AAA	
* 102	A-6065-574-A	MS-59 BOARD, COMPLETE		110	X-3950-949-1	BASE ASSY, MECHANICAL	
103	1-757-068-11	CABLE, FLEXIBLE FLAT (FCM-13)		* 111	A-6065-566-A	TK-58 BOARD, COMPLETE	
104	A-6062-468-A	LOADING ASSY (EXCEPT US, CND)		112	1-757-065-11	CABLE, FLEXIBLE FLAT (FMT-29)	
104	A-6062-471-A	LOADING ASSY (US, CND)		* 113	A-6065-575-A	CK-95 BOARD, COMPLETE	
105	3-063-621-01	SPRING, DOOR LIMITTER		114	3-058-511-11	+BV 1BR	
106	3-533-073-01	WASHER		115	X-3950-945-1	DOOR ASSY	
107	4-981-923-01	SCREW (M), STEP		M501	1-763-397-21	MOTOR, DC (RF-300FA-12350) (LOADING)	
108	3-064-313-01	INSULATOR (H)					

8-2. ELECTRICAL PARTS LIST

NOTE:

- Due to standardization, replacements in the parts list may be different from the parts specified in the diagrams or the components used on the set.
- -XX and -X mean standardized parts, so they may have some difference from the original one.
- RESISTORS  
All resistors are in ohms.  
METAL: Metal-film resistor.  
METAL OXIDE: Metal oxide-film resistor.  
F: nonflammable
- Abbreviation  
AUS : Australian model  
CN : Chinese model  
CND : Canadian model  
HK : Hong Kong model

- Items marked "\*" are not stocked since they are seldom required for routine service. Some delay should be anticipated when ordering these items.
- SEMICONDUCTORS  
In each case, u:  $\mu$ , for example:  
uA. . :  $\mu$ A. . uPA. . :  $\mu$ PA. .  
uPB. . :  $\mu$ PB. . uPC. . :  $\mu$ PC. .  
uPD. . :  $\mu$ PD. .
- CAPACITORS  
uF:  $\mu$ F
- COILS  
uH:  $\mu$ H

The components identified by mark  $\Delta$  or dotted line with mark  $\Delta$  are critical for safety. Replace only with part number specified.

Les composants identifiés par une marque  $\Delta$  sont critiques pour la sécurité. Ne les remplacer que par une pièce portant le numéro spécifié.

When indicating parts by reference number, please include the board.

Ref. No.	Part No.	Description	Remark	Ref. No.	Part No.	Description	Remark
*	A-6065-595-A	AC-113 BOARD, COMPLETE (US, CND)					
*	A-6065-583-A	AC-114 BOARD, COMPLETE (EXCEPT US, CND)				< FUSE >	
		***** (Ref.No. 2,000 Series)		$\Delta$ F101	1-532-279-11	FUSE, TIME-LAG (0.5A/250V)	(EXCEPT US, CND)
	3-053-984-01	SCREW (+BV/CU)		$\Delta$ F101	1-532-742-11	FUSE, GLASS TUBE (1.6A/125V) (US, CND)	
	3-063-203-01	SHEET (TR), RADIATION				< FUSE HOLDER >	
*	4-363-146-21	HEAT SINK, V.OUT		FH101	1-533-189-11	HOLDER, FUSE	
		< CAPACITOR >		FH102	1-533-189-11	HOLDER, FUSE	
	C101	1-104-652-11 ELECT 470uF 20% 10V				< IC >	
	C102	1-115-339-11 CERAMIC CHIP 0.1uF 10% 50V		IC101	8-759-471-81	IC PQ05RD11	
	C103	1-115-339-11 CERAMIC CHIP 0.1uF 10% 50V				< LINE FILTER >	
	C104	1-107-890-31 ELECT 2200uF 20% 25V		$\Delta$ LF101	1-416-446-11	FILTER, LINE	
	C105	1-163-275-11 CERAMIC CHIP 0.001uF 5% 50V				< TRANSISTOR >	
	C106	1-163-275-11 CERAMIC CHIP 0.001uF 5% 50V		Q101	8-729-230-49	TRANSISTOR 2SC2712-YG-TE85L	
	C108	1-163-275-11 CERAMIC CHIP 0.001uF 5% 50V		Q102	8-729-424-46	TRANSISTOR UN211E-TX	
$\Delta$	C110	1-104-705-11 MYLAR 0.1uF 20% 250V		Q103	8-729-421-22	TRANSISTOR UN2211-TX	
$\Delta$	C111	1-104-705-11 MYLAR 0.1uF 20% 250V				< RESISTOR >	
	C112	1-126-044-11 ELECT 1uF 20% 50V		R101	1-216-049-11	RES-CHIP 1K 5% 1/10W	
	C113	1-126-046-11 ELECT 3.3uF 20% 50V		R102	1-216-001-00	METAL CHIP 10 5% 1/10W	
$\Delta$	C114	1-119-892-51 CERAMIC 470PF 10% 250V		R103	1-216-065-91	RES-CHIP 4.7K 5% 1/10W	
$\Delta$	C115	1-119-892-51 CERAMIC 470PF 10% 250V		R105	1-216-073-00	METAL CHIP 10K 5% 1/10W	
		< CONNECTOR >		R106	1-216-295-11	SHORT 0	
	CN101	1-564-321-00 PIN, CONNECTOR 2P		R107	1-216-295-11	SHORT 0 (EXCEPT US, CND)	
	CN102	1-770-128-11 PIN, CONNECTOR 2P		R108	1-216-295-11	SHORT 0 (EXCEPT US, CND)	
	CN104	1-564-321-00 PIN, CONNECTOR 2P		R109	1-216-295-11	SHORT 0 (US, CND)	
*	CN105	1-564-321-21 PIN, CONNECTOR 2P		R110	1-216-295-11	SHORT 0 (US, CND)	
*	CN106	1-564-706-11 PIN, CONNECTOR (SMALL TYPE) 4P				< RELAY >	
		< DIODE >		$\Delta$ RY101	1-755-407-11	RELAY (AC POWER)	
	D101	8-719-820-05 DIODE 1SS181-TE85L				< TRANSFORMER >	
	D102	8-719-024-99 DIODE 11ES2-NTA2B		$\Delta$ T101	1-435-685-11	TRANSFORMER, POWER (EXCEPT US, CND)	
	D103	8-719-024-99 DIODE 11ES2-NTA2B		$\Delta$ T101	1-435-720-11	TRANSFORMER, POWER (US, CND)	
	D105	8-719-024-99 DIODE 11ES2-NTA2B					
	D106	8-719-024-99 DIODE 11ES2-NTA2B					
	D107	8-719-820-05 DIODE 1SS181-TE85L					
	D108	8-719-024-99 DIODE 11ES2-NTA2B					
	D109	8-719-024-99 DIODE 11ES2-NTA2B					
		< GROUND TERMINAL >					
ET101	1-537-770-21	TERMINAL BOARD, GROUND					

Ref. No.	Part No.	Description	Remark			Ref. No.	Part No.	Description	Remark		
*	A-6065-580-A	AU-226 BOARD, COMPLETE (AEP, UK)				C152	1-119-800-11	ELECT	100uF	20%	25V
*	A-6065-588-A	AU-226 BOARD, COMPLETE (HK, CN, AUS)				C153	1-119-800-11	ELECT	100uF	20%	25V
*	A-6065-593-A	AU-226 BOARD, COMPLETE (US, CND)				C154	1-115-197-11	ELECT	100uF	20%	25V
		*****				C155	1-115-197-11	ELECT	100uF	20%	25V
		(Ref.No. 3,000 Series)									
	2-259-121-01	SCREW, TR				C156	1-119-813-31	ELECT	470uF	20%	35V
	4-902-345-01	HEAT SINK				C157	1-119-813-31	ELECT	470uF	20%	35V
		< CAPACITOR >				C158	1-130-299-91	FILM	0.012uF	5%	100V
						C159	1-130-299-91	FILM	0.012uF	5%	100V
						C160	1-130-299-91	FILM	0.012uF	5%	100V
C101	1-127-956-21	FILM CHIP	0.1uF	5%	16V	C161	1-130-299-91	FILM	0.012uF	5%	100V
C102	1-127-950-21	FILM CHIP	0.01uF	5%	16V	C162	1-130-339-11	FILM	0.0056uF	5%	100V
C103	1-127-956-21	FILM CHIP	0.1uF	5%	16V	C163	1-130-339-11	FILM	0.0056uF	5%	100V
C104	1-119-800-11	ELECT	100uF	20%	25V	C164	1-130-339-11	FILM	0.0056uF	5%	100V
C105	1-127-956-21	FILM CHIP	0.1uF	5%	16V	C165	1-130-339-11	FILM	0.0056uF	5%	100V
C106	1-119-800-11	ELECT	100uF	20%	25V	C166	1-137-268-91	FILM	470PF	5%	100V
C107	1-127-956-21	FILM CHIP	0.1uF	5%	16V	C167	1-137-268-91	FILM	470PF	5%	100V
C108	1-127-956-21	FILM CHIP	0.1uF	5%	16V	C168	1-137-268-91	FILM	470PF	5%	100V
C109	1-127-956-21	FILM CHIP	0.1uF	5%	16V	C169	1-137-268-91	FILM	470PF	5%	100V
C110	1-127-950-21	FILM CHIP	0.01uF	5%	16V	C170	1-130-856-00	FILM	0.0068uF	5%	100V
C111	1-127-971-21	FILM CHIP	0.01uF	5%	50V	C171	1-130-856-00	FILM	0.0068uF	5%	100V
C112	1-119-800-11	ELECT	100uF	20%	25V	C172	1-136-252-00	FILM	0.0015uF	5%	100V
C113	1-127-956-21	FILM CHIP	0.1uF	5%	16V	C173	1-136-252-00	FILM	0.0015uF	5%	100V
C114	1-127-956-21	FILM CHIP	0.1uF	5%	16V	C176	1-137-506-11	ELECT	0.47uF	10%	63V
C115	1-127-956-21	FILM CHIP	0.1uF	5%	16V	C177	1-137-506-11	ELECT	0.47uF	10%	63V
C116	1-127-956-21	FILM CHIP	0.1uF	5%	16V	C178	1-110-495-11	ELECT	220uF	20%	25V
C117	1-119-800-11	ELECT	100uF	20%	25V	C179	1-110-495-11	ELECT	220uF	20%	25V
C118	1-119-800-11	ELECT	100uF	20%	25V	C180	1-127-966-21	FILM CHIP	0.0015uF	5%	50V
C119	1-127-956-21	FILM CHIP	0.1uF	5%	16V	C183	1-163-133-00	CERAMIC CHIP	470PF	5%	50V
C120	1-127-956-21	FILM CHIP	0.1uF	5%	16V	C184	1-163-133-00	CERAMIC CHIP	470PF	5%	50V
C121	1-127-956-21	FILM CHIP	0.1uF	5%	16V	C185	1-126-933-11	ELECT	100uF	20%	16V
C122	1-127-956-21	FILM CHIP	0.1uF	5%	16V	C301	1-137-648-11	ELECT	3900uF	20%	63V
C123	1-127-956-21	FILM CHIP	0.1uF	5%	16V	C302	1-107-611-11	CAPACITOR	100PF	5%	500V
C124	1-163-133-00	CERAMIC CHIP	470PF	5%	50V	C303	1-117-378-81	FILM	1uF	5%	50V
C125	1-163-133-00	CERAMIC CHIP	470PF	5%	50V	C304	1-126-048-81	ELECT	10uF	20%	50V
C126	1-127-956-21	FILM CHIP	0.1uF	5%	16V	C305	1-128-205-11	ELECT	1000uF	20%	63V
C127	1-119-800-11	ELECT	100uF	20%	25V	C306	1-128-205-11	ELECT	1000uF	20%	63V
C128	1-119-800-11	ELECT	100uF	20%	25V	C307	1-126-046-11	ELECT	3.3uF	20%	50V
C129	1-119-800-11	ELECT	100uF	20%	25V	C308	1-104-987-11	MYLAR	0.001uF	5%	50V
C130	1-119-835-11	ELECT	33uF	20%	25V	C309	1-104-987-11	MYLAR	0.001uF	5%	50V
C131	1-119-803-31	ELECT	470uF	20%	25V	C310	1-107-611-11	CAPACITOR	100PF	5%	500V
C132	1-128-197-11	ELECT	10uF	20%	63V	C311	1-107-611-11	CAPACITOR	100PF	5%	500V
C133	1-136-850-11	MYLAR	0.1uF	5%	63V	C312	1-128-197-11	ELECT	10uF	20%	63V
C134	1-128-197-11	ELECT	10uF	20%	63V	C313	1-128-205-11	ELECT	1000uF	20%	63V
C135	1-136-850-11	MYLAR	0.1uF	5%	63V	C314	1-128-197-11	ELECT	10uF	20%	63V
C136	1-136-850-11	MYLAR	0.1uF	5%	63V	C315	1-128-197-11	ELECT	10uF	20%	63V
C137	1-136-850-11	MYLAR	0.1uF	5%	63V	C316	1-119-835-11	ELECT	33uF	20%	25V
C138	1-136-850-11	MYLAR	0.1uF	5%	63V	C317	1-136-850-11	MYLAR	0.1uF	5%	63V
C139	1-136-850-11	MYLAR	0.1uF	5%	63V	C318	1-136-850-11	MYLAR	0.1uF	5%	63V
C140	1-136-850-11	MYLAR	0.1uF	5%	63V	C319	1-115-197-11	ELECT	100uF	20%	25V
C141	1-136-850-11	MYLAR	0.1uF	5%	63V	C320	1-137-648-11	ELECT	3900uF	20%	63V
C142	1-136-850-11	MYLAR	0.1uF	5%	63V	C321	1-137-648-11	ELECT	3900uF	20%	63V
C143	1-136-850-11	MYLAR	0.1uF	5%	63V	C322	1-107-611-11	CAPACITOR	100PF	5%	500V
C144	1-119-800-11	ELECT	100uF	20%	25V	C323	1-117-378-81	FILM	1uF	5%	50V
C145	1-119-800-11	ELECT	100uF	20%	25V	C324	1-136-850-11	MYLAR	0.1uF	5%	63V
C146	1-130-973-00	FILM	0.022uF	5%	100V	C325	1-104-987-11	MYLAR	0.001uF	5%	50V
C147	1-130-973-00	FILM	0.022uF	5%	100V	C327	1-163-009-11	CERAMIC CHIP	0.001uF	10%	50V
C148	1-136-850-11	MYLAR	0.1uF	5%	63V						(US, CND)
C149	1-136-850-11	MYLAR	0.1uF	5%	63V	C353	1-104-664-11	ELECT	47uF	20%	16V
C150	1-136-850-11	MYLAR	0.1uF	5%	63V	C354	1-136-850-11	MYLAR	0.1uF	5%	63V
C151	1-136-850-11	MYLAR	0.1uF	5%	63V	C355	1-163-239-11	CERAMIC CHIP	33PF	5%	50V

# AU-226

Ref. No.	Part No.	Description	Remark	Ref. No.	Part No.	Description	Remark
C356	1-127-963-21	FILM CHIP 470PF 5%	50V	IC111	8-759-443-33	IC OPA2132PA	
		< CONNECTOR >		IC112	8-759-443-33	IC OPA2132PA	
CN101	1-774-863-11	PIN, CONNECTOR (PC BOARD) 8P		IC113	8-759-573-62	IC OPA2134PA	
* CN103	1-764-250-11	PIN, CONNECTOR (PC BOARD) 4P (AEP, UK)		IC114	8-759-573-62	IC OPA2134PA	
* CN351	1-793-115-21	CONNECTOR, FFC/FPC 21P		IC301	8-759-602-01	IC M5220P	
CN352	1-564-509-11	PLUG, CONNECTOR 6P		IC302	8-759-604-35	IC M5F78M05L	
CN353	1-794-509-21	PIN, CONNECTOR (PC BOARD) (3P)		IC351	8-749-017-80	IC GP1FA551TZ (DIGITAL OUT OPTICAL)	
		< DIODE >		IC352	8-759-485-79	IC TC7SET08FU (TE85R)	
D101	8-719-073-01	DIODE MA111-TX		IC353	8-759-485-79	IC TC7SET08FU (TE85R) (AEP, UK)	
D102	8-719-073-01	DIODE MA111-TX				< JACK >	
D103	8-719-073-01	DIODE MA111-TX		J101	1-794-714-11	JACK, PIN 2P (AUDIO OUT R)	
D104	8-719-073-01	DIODE MA111-TX		J102	1-794-715-11	JACK, PIN 2P (AUDIO OUT L)	
D301	8-719-074-58	DIODE FCH10A10		J302	1-764-188-21	JACK (SMALL TYPE) (DIA. 3.5) (CONTROL S IN) (US, CND)	
D302	8-719-067-59	DIODE MAZ9120D0LS0-TX/L (US, CND)				< IC LINK >	
D303	8-719-975-85	DIODE 21DQ04-TA2		△ PS301	1-532-685-00	LINK, IC (0.8A)	
D304	8-719-114-49	DIODE RD7.5JS-T2AB2		△ PS302	1-532-685-00	LINK, IC (0.8A)	
D305	8-719-114-49	DIODE RD7.5JS-T2AB2		△ PS303	1-532-685-00	LINK, IC (0.8A)	
D306	8-719-210-29	DIODE F10P10Q				< TRANSISTOR >	
D307	8-719-210-29	DIODE F10P10Q		Q101	8-729-424-08	TRANSISTOR UN2111-TX	
D308	8-719-210-29	DIODE F10P10Q		Q102	8-729-424-08	TRANSISTOR UN2111-TX	
D309	8-719-210-29	DIODE F10P10Q		Q103	8-729-421-22	TRANSISTOR UN2211-TX	
D310	8-719-024-99	DIODE 11ES2-NTA2B		Q104	8-729-231-55	TRANSISTOR 2SC2878AB-TPE2	
D311	8-719-024-99	DIODE 11ES2-NTA2B		Q105	8-729-231-55	TRANSISTOR 2SC2878AB-TPE2	
D314	8-719-080-52	DIODE FRH10A10		Q106	8-729-421-22	TRANSISTOR UN2211-TX	
		< GROUND TERMINAL >		Q301	8-729-421-22	TRANSISTOR UN2211-TX	
ET103	1-537-770-21	TERMINAL BOARD, GROUND		Q302	8-729-424-46	TRANSISTOR UN211E-TX	
		< FERRITE BEAD >		Q303	8-729-107-53	TRANSISTOR 2SC2275-QP	
FB101	1-414-766-22	INDUCTOR 0uH		Q304	8-729-141-10	TRANSISTOR 2SA985-QP	
FB102	1-414-766-22	INDUCTOR 0uH		Q305	8-729-203-05	TRANSISTOR 2SK30AGR3-TPE2	
FB103	1-414-226-21	INDUCTOR 0uH		Q306	8-729-203-05	TRANSISTOR 2SK30AGR3-TPE2	
FB104	1-414-766-22	INDUCTOR 0uH		Q307	8-729-107-53	TRANSISTOR 2SC2275-QP	
FB105	1-414-766-22	INDUCTOR 0uH				< RESISTOR >	
FB301	1-414-553-11	FERRITE 0uH (US, CND)		R101	1-216-057-00	METAL CHIP 2.2K 5% 1/10W	
FB302	1-414-553-11	FERRITE 0uH (US, CND)		R102	1-216-057-00	METAL CHIP 2.2K 5% 1/10W	
FB303	1-414-766-22	INDUCTOR 0uH		R103	1-216-049-11	RES-CHIP 1K 5% 1/10W	
		< FILTER >		R104	1-216-085-00	METAL CHIP 33K 5% 1/10W	
FL101	1-234-177-21	FILTER, CHIP EMI		R105	1-414-226-21	INDUCTOR 0uH	
FL102	1-234-177-21	FILTER, CHIP EMI		R106	1-414-226-21	INDUCTOR 0uH	
FL103	1-234-177-21	FILTER, CHIP EMI		R107	1-216-295-11	SHORT 0	
FL104	1-234-177-21	FILTER, CHIP EMI		R108	1-216-089-11	RES-CHIP 47K 5% 1/10W	
		< IC >		R109	1-216-097-11	RES-CHIP 100K 5% 1/10W	
IC101	8-759-475-33	IC TC74LXC00FT (EL)		R110	1-249-657-11	CARBON 220 5% 1/2W	
IC102	8-759-680-61	IC FS6008-01TE-L		R111	1-249-782-11	CARBON 150 5% 1/6W	
IC103	8-759-242-70	IC TC7WU04F (TE12R)		R112	1-249-782-11	CARBON 150 5% 1/6W	
IC104	8-759-486-55	IC NJM2370U33-TE2		R113	1-249-782-11	CARBON 150 5% 1/6W	
IC105	8-759-678-29	IC CXD9556AQ		R114	1-249-782-11	CARBON 150 5% 1/6W	
IC106	8-759-231-53	IC M5F7805L		R115	1-249-782-11	CARBON 150 5% 1/6W	
IC107	8-759-371-51	IC CXA8042AS		R116	1-249-782-11	CARBON 150 5% 1/6W	
IC108	8-759-371-51	IC CXA8042AS		R117	1-249-782-11	CARBON 150 5% 1/6W	
IC109	8-759-231-53	IC M5F7805L		R118	1-249-782-11	CARBON 150 5% 1/6W	
IC110	8-759-604-90	IC M5F7907L		R119	1-249-942-11	CARBON 6.2K 5% 1/4W	
				R120	1-249-942-11	CARBON 6.2K 5% 1/4W	
				R121	1-247-706-11	CARBON 330 5% 1/4W	

The components identified by mark  $\Delta$  or dotted line with mark  $\Delta$  are critical for safety. Replace only with part number specified.

Les composants identifiés par une marque  $\Delta$  sont critiques pour la sécurité. Ne les remplacer que par une pièce portant le numéro spécifié.

Ref. No.	Part No.	Description			Remark	Ref. No.	Part No.	Description			Remark
R122	1-247-706-11	CARBON	330	5%	1/4W	R309	1-249-923-11	CARBON	1K	5%	1/4W
R123	1-249-504-11	CARBON	10	5%	1/4W	R310	1-249-923-11	CARBON	1K	5%	1/4W
R124	1-249-504-11	CARBON	10	5%	1/4W	R311	1-247-764-11	CARBON	10K	5%	1/2W
R125	1-249-504-11	CARBON	10	5%	1/4W						
R126	1-249-504-11	CARBON	10	5%	1/4W	R312	1-249-556-11	CARBON	1.5K	5%	1/4W
R127	1-249-504-11	CARBON	10	5%	1/4W	R313	1-249-520-11	CARBON	47	5%	1/4W
R128	1-249-504-11	CARBON	10	5%	1/4W	R314	1-249-923-11	CARBON	1K	5%	1/4W
R129	1-249-504-11	CARBON	10	5%	1/4W	R315	1-249-520-11	CARBON	47	5%	1/4W
R130	1-249-504-11	CARBON	10	5%	1/4W	R316	1-249-923-11	CARBON	1K	5%	1/4W
R131	1-249-522-11	CARBON	56	5%	1/4W	△ R317	1-212-976-11	FUSIBLE	56	5%	1/2W
R132	1-249-522-11	CARBON	56	5%	1/4W	R318	1-249-919-11	CARBON	680	5%	1/4W
R133	1-249-522-11	CARBON	56	5%	1/4W	△ R319	1-212-976-11	FUSIBLE	56	5%	1/2W
R134	1-249-522-11	CARBON	56	5%	1/4W	R320	1-249-923-11	CARBON	1K	5%	1/4W
R135	1-249-542-11	CARBON	390	5%	1/4W	R335	1-216-049-11	RES-CHIP	1K	5%	1/10W (US, CND)
R136	1-249-542-11	CARBON	390	5%	1/4W	R351	1-216-295-11	SHORT	0		
R137	1-249-542-11	CARBON	390	5%	1/4W	R352	1-216-295-11	SHORT	0		
R138	1-249-542-11	CARBON	390	5%	1/4W	R353	1-216-295-11	SHORT	0		
R139	1-249-941-11	CARBON	5.6K	5%	1/4W	R354	1-216-295-11	SHORT	0		
R140	1-249-941-11	CARBON	5.6K	5%	1/4W	R355	1-216-295-11	SHORT	0		
R141	1-249-941-11	CARBON	5.6K	5%	1/4W	R356	1-216-295-11	SHORT	0		
R142	1-249-941-11	CARBON	5.6K	5%	1/4W	R357	1-216-295-11	SHORT	0		
R143	1-249-941-11	CARBON	5.6K	5%	1/4W	R358	1-216-295-11	SHORT	0		
R144	1-249-941-11	CARBON	5.6K	5%	1/4W	R359	1-216-295-11	SHORT	0		
R145	1-249-941-11	CARBON	5.6K	5%	1/4W	R360	1-216-295-11	SHORT	0		
R146	1-249-941-11	CARBON	5.6K	5%	1/4W	R361	1-216-295-11	SHORT	0		
R147	1-247-712-11	CARBON	820	5%	1/4W	R362	1-216-295-11	SHORT	0		
R148	1-247-712-11	CARBON	820	5%	1/4W	R363	1-216-295-11	SHORT	0		
R149	1-247-712-11	CARBON	820	5%	1/4W	R364	1-216-295-11	SHORT	0		
R150	1-247-712-11	CARBON	820	5%	1/4W	R365	1-216-049-11	RES-CHIP	1K	5%	1/10W
R151	1-249-923-11	CARBON	1K	5%	1/4W	R366	1-216-049-11	RES-CHIP	1K	5%	1/10W
R152	1-249-923-11	CARBON	1K	5%	1/4W	R367	1-216-295-11	SHORT	0		
R153	1-249-633-11	CARBON	22	5%	1/2W	R368	1-249-524-11	CARBON	68	5%	1/4W
R154	1-249-633-11	CARBON	22	5%	1/2W	R370	1-216-009-91	RES-CHIP	22	5%	1/10W
R155	1-249-657-11	CARBON	220	5%	1/2W	R371	1-216-295-11	SHORT	0		
R156	1-216-009-91	RES-CHIP	22	5%	1/10W	R372	1-216-295-11	SHORT	0		
R157	1-249-469-11	CARBON	100K	5%	1/4W	R373	1-216-025-11	RES-CHIP	100	5%	1/10W
R158	1-249-469-11	CARBON	100K	5%	1/4W	R374	1-249-524-11	CARBON	68	5%	1/4W
R159	1-249-657-11	CARBON	220	5%	1/2W	R379	1-216-049-11	RES-CHIP	1K	5%	1/10W
R160	1-249-657-11	CARBON	220	5%	1/2W	R380	1-216-049-11	RES-CHIP	1K	5%	1/10W
R161	1-216-097-11	RES-CHIP	100K	5%	1/10W	R381	1-216-049-11	RES-CHIP	1K	5%	1/10W
R162	1-216-097-11	RES-CHIP	100K	5%	1/10W			< RELAY >			
R163	1-216-073-00	METAL CHIP	10K	5%	1/10W						
R164	1-216-041-00	METAL CHIP	470	5%	1/10W (AEP, UK)	RY101	1-755-061-11	RELAY			
R165	1-216-041-00	METAL CHIP	470	5%	1/10W (AEP, UK)			< TRANSFORMER >			
R166	1-216-009-91	RES-CHIP	22	5%	1/10W	T001	1-429-371-11	TRANSFORMER, PULSE			
R167	1-216-295-11	SHORT	0 (AEP, UK)					< VIBRATOR >			
R168	1-216-295-11	SHORT	0								
R170	1-216-009-91	RES-CHIP	22	5%	1/10W	X101	1-781-990-21	OSCILLATOR, CRYSTAL (45.1584MHz)			
R301	1-249-556-11	CARBON	1.5K	5%	1/4W	X102	1-781-989-21	OSCILLATOR, CRYSTAL (49.152MHz)			
R302	1-249-560-91	CARBON	2.2K	5%	1/4W						
R303	1-249-560-91	CARBON	2.2K	5%	1/4W						
R304	1-249-556-11	CARBON	1.5K	5%	1/4W						
R305	1-249-963-11	CARBON	47K	5%	1/4W						
R306	1-249-923-11	CARBON	1K	5%	1/4W						
R307	1-249-405-11	CARBON	100	5%	1/4W						
R308	1-249-405-11	CARBON	100	5%	1/4W						

The components identified by mark △ or dotted line with mark △ are critical for safety. Replace only with part number specified.	Les composants identifiés par une marque △ sont critiques pour la sécurité. Ne les remplacer que par une pièce portant le numéro spécifié.
--	--

<b>BZ-1</b>	<b>CK-95</b>	<b>CO-26</b>	<b>ER-11</b>
-------------	--------------	--------------	--------------

Ref. No.	Part No.	Description	Remark
*	A-6065-573-A	BZ-1 BOARD, COMPLETE ***** (Ref.No. 2,000 Series)	
		< BUZZER >	
BZ301	1-529-080-11	BUZZER, PIEZOELECTRIC	
		< CONNECTOR >	
* CN301	1-564-720-11	PIN, CONNECTOR (SMALL TYPE) 4P	
		< DIODE >	
D301	8-719-080-49	DIODE LNJ951C4B0S0 (DISC IN)	
D302	8-719-080-49	DIODE LNJ951C4B0S0 (DISC IN)	
		< RESISTOR >	
R301	1-216-044-00	METAL CHIP	620 5% 1/10W
R302	1-216-065-91	RES-CHIP	4.7K 5% 1/10W
R303	1-216-044-00	METAL CHIP	620 5% 1/10W

*	A-6065-575-A	CK-95 BOARD, COMPLETE ***** (Ref.No. 1,000 Series)	
		< CONNECTOR >	
CN601	1-564-723-11	PIN, CONNECTOR (SMALL TYPE) 7P	
CN602	1-784-612-11	CONNECTOR, FFC/FPC (ZIF) 7P	

*	A-6065-640-A	CO-26 BOARD, COMPLETE ***** (Ref.No. 1,000 Series)	
		< JACK >	
J501	1-784-432-11	JACK, PIN 1P (DIGITAL OUT COAXIAL)	

*	A-6065-582-A	ER-11 BOARD, COMPLETE (AEP, UK) ***** (Ref.No. 2,000 Series)	
		< CAPACITOR >	
C901	1-128-390-11	ELECT CHIP	220uF 20% 6.3V
C902	1-163-021-91	CERAMIC CHIP	0.01uF 10% 50V
C907	1-126-205-11	ELECT CHIP	47uF 20% 6.3V
C908	1-126-395-11	ELECT	22uF 20% 16V
C909	1-126-395-11	ELECT	22uF 20% 16V
C910	1-126-395-11	ELECT	22uF 20% 16V
C911	1-163-021-91	CERAMIC CHIP	0.01uF 10% 50V
C912	1-126-395-11	ELECT	22uF 20% 16V
C913	1-163-021-91	CERAMIC CHIP	0.01uF 10% 50V
C914	1-163-021-91	CERAMIC CHIP	0.01uF 10% 50V
C920	1-163-021-91	CERAMIC CHIP	0.01uF 10% 50V
C921	1-126-395-11	ELECT	22uF 20% 16V
C922	1-126-395-11	ELECT	22uF 20% 16V
C923	1-163-021-91	CERAMIC CHIP	0.01uF 10% 50V
C924	1-128-390-11	ELECT CHIP	220uF 20% 6.3V
C927	1-163-021-91	CERAMIC CHIP	0.01uF 10% 50V
C938	1-163-133-00	CERAMIC CHIP	470PF 5% 50V
C939	1-163-133-00	CERAMIC CHIP	470PF 5% 50V
C940	1-163-133-00	CERAMIC CHIP	470PF 5% 50V
C941	1-163-133-00	CERAMIC CHIP	470PF 5% 50V

Ref. No.	Part No.	Description	Remark
C942	1-163-133-00	CERAMIC CHIP	470PF 5% 50V
C943	1-163-133-00	CERAMIC CHIP	470PF 5% 50V
C944	1-163-133-00	CERAMIC CHIP	470PF 5% 50V
C945	1-163-133-00	CERAMIC CHIP	470PF 5% 50V
C950	1-163-251-11	CERAMIC CHIP	100PF 5% 50V
C951	1-163-251-11	CERAMIC CHIP	100PF 5% 50V
C962	1-163-251-11	CERAMIC CHIP	100PF 5% 50V
C963	1-163-251-11	CERAMIC CHIP	100PF 5% 50V
C972	1-163-021-91	CERAMIC CHIP	0.01uF 10% 50V
C973	1-126-205-11	ELECT CHIP	47uF 20% 6.3V
		< CONNECTOR >	
CN901	1-794-555-21	CONNECTOR, FFC/FPC 22P	
* CN905	1-750-005-11	PIN, CONNECTOR (PC BOARD) 4P	
* CN906	1-580-057-11	PIN, CONNECTOR (SMD) 4P	
		< JACK >	
CNJ901	1-251-780-11	SOCKET, PIN (21P) (EURO AV2)	
CNJ902	1-251-780-11	SOCKET, PIN (21P) (EURO AV1 (RGB) -TV)	
		< DIODE >	
D901	8-719-988-61	DIODE	1SS355TE-17
D902	8-719-988-61	DIODE	1SS355TE-17
D903	8-719-988-61	DIODE	1SS355TE-17
D904	8-719-988-61	DIODE	1SS355TE-17
D905	8-719-988-61	DIODE	1SS355TE-17
D906	8-719-988-61	DIODE	1SS355TE-17
D907	8-719-988-61	DIODE	1SS355TE-17
D908	8-719-071-15	DIODE	HZM6.8ZWA1TL
D909	8-719-988-61	DIODE	1SS355TE-17
D910	8-719-988-61	DIODE	1SS355TE-17
D911	8-719-988-61	DIODE	1SS355TE-17
D915	8-719-071-15	DIODE	HZM6.8ZWA1TL
D917	8-719-071-15	DIODE	HZM6.8ZWA1TL
D918	8-719-071-15	DIODE	HZM6.8ZWA1TL
D919	8-719-071-15	DIODE	HZM6.8ZWA1TL
D920	8-719-071-15	DIODE	HZM6.8ZWA1TL
D921	8-719-071-15	DIODE	HZM6.8ZWA1TL
D922	8-719-071-15	DIODE	HZM6.8ZWA1TL
D923	8-719-071-15	DIODE	HZM6.8ZWA1TL
D924	8-719-071-15	DIODE	HZM6.8ZWA1TL
D926	8-719-056-82	DIODE	UDZ-TE-17-6.2B
D927	8-719-977-40	DIODE	UDZ-TE-17-13B
D929	8-719-056-82	DIODE	UDZ-TE-17-6.2B
D930	8-719-977-40	DIODE	UDZ-TE-17-13B
		< FERRITE BEAD >	
FB901	1-414-553-11	FERRITE	0uH
FB902	1-414-553-11	FERRITE	0uH
FB903	1-414-553-11	FERRITE	0uH
FB904	1-414-553-11	FERRITE	0uH
FB905	1-414-553-11	FERRITE	0uH
FB906	1-414-553-11	FERRITE	0uH
FB907	1-414-553-11	FERRITE	0uH
FB908	1-414-553-11	FERRITE	0uH
FB909	1-414-553-11	FERRITE	0uH
FB910	1-414-553-11	FERRITE	0uH
FB911	1-414-553-11	FERRITE	0uH
FB912	1-414-553-11	FERRITE	0uH
FB913	1-414-553-11	FERRITE	0uH

Ref. No.	Part No.	Description	Remark			Ref. No.	Part No.	Description	Remark		
FB914	1-414-553-11	FERRITE	0uH			R951	1-216-081-00	METAL CHIP	22K	5%	1/10W
FB915	1-414-553-11	FERRITE	0uH					< RELAY >			
FB916	1-414-553-11	FERRITE	0uH			RY901	1-755-184-11	RELAY			
FB917	1-414-553-11	FERRITE	0uH			RY902	1-755-184-11	RELAY			
FB918	1-414-553-11	FERRITE	0uH			RY903	1-755-184-11	RELAY			
		< IC >				RY904	1-755-184-11	RELAY			
IC901	8-759-684-20	IC LA7104M-TLM				RY905	1-755-184-11	RELAY			
IC902	8-759-446-66	IC MM1113XFBE				RY906	1-755-184-11	RELAY			
IC903	8-759-567-33	IC MM1225XFBE									
		< COIL >									
L901	1-412-064-11	INDUCTOR	100uH								
L904	1-412-064-11	INDUCTOR	100uH								
L905	1-412-064-11	INDUCTOR	100uH								
		< TRANSISTOR >									
Q901	8-729-421-19	TRANSISTOR	UN2213-TX								
Q902	8-729-421-19	TRANSISTOR	UN2213-TX								
Q903	8-729-424-08	TRANSISTOR	UN2111-TX								
Q904	8-729-422-27	TRANSISTOR	2SD601A-QRS-TX								
Q906	8-729-421-19	TRANSISTOR	UN2213-TX								
Q907	8-729-424-08	TRANSISTOR	UN2111-TX								
Q908	8-729-421-22	TRANSISTOR	UN2211-TX								
Q909	8-729-421-19	TRANSISTOR	UN2213-TX								
Q910	8-729-424-08	TRANSISTOR	UN2111-TX								
Q912	8-729-422-27	TRANSISTOR	2SD601A-QRS-TX								(US, CND)
Q913	8-729-422-27	TRANSISTOR	2SD601A-QRS-TX								
Q914	8-729-422-27	TRANSISTOR	2SD601A-QRS-TX								
Q915	8-729-422-27	TRANSISTOR	2SD601A-QRS-TX								
Q916	8-729-422-27	TRANSISTOR	2SD601A-QRS-TX								
		< RESISTOR >									
R902	1-216-089-11	RES-CHIP	47K	5%	1/10W						
R904	1-216-089-11	RES-CHIP	47K	5%	1/10W						
R906	1-216-089-11	RES-CHIP	47K	5%	1/10W						
R907	1-216-049-11	RES-CHIP	1K	5%	1/10W						
R909	1-216-039-00	METAL CHIP	390	5%	1/10W						
R910	1-216-039-00	METAL CHIP	390	5%	1/10W						
R911	1-216-039-00	METAL CHIP	390	5%	1/10W						
R912	1-216-039-00	METAL CHIP	390	5%	1/10W						
R913	1-216-065-91	RES-CHIP	4.7K	5%	1/10W						
R914	1-216-057-00	METAL CHIP	2.2K	5%	1/10W						
R915	1-216-047-91	RES-CHIP	820	5%	1/10W						
R916	1-216-057-00	METAL CHIP	2.2K	5%	1/10W						
R917	1-216-057-00	METAL CHIP	2.2K	5%	1/10W						
R920	1-216-049-11	RES-CHIP	1K	5%	1/10W						
R923	1-216-041-00	METAL CHIP	470	5%	1/10W						
R924	1-216-041-00	METAL CHIP	470	5%	1/10W						
R925	1-216-041-00	METAL CHIP	470	5%	1/10W						
R926	1-216-041-00	METAL CHIP	470	5%	1/10W						
R930	1-216-065-91	RES-CHIP	4.7K	5%	1/10W						
R931	1-216-065-91	RES-CHIP	4.7K	5%	1/10W						
R932	1-216-065-91	RES-CHIP	4.7K	5%	1/10W						
R933	1-216-065-91	RES-CHIP	4.7K	5%	1/10W						
R934	1-216-065-91	RES-CHIP	4.7K	5%	1/10W						
R938	1-216-025-11	RES-CHIP	100	5%	1/10W						
R939	1-216-017-91	RES-CHIP	47	5%	1/10W						
R944	1-216-073-00	METAL CHIP	10K	5%	1/10W						
R950	1-216-081-00	METAL CHIP	22K	5%	1/10W						
		< CAPACITOR >									
C201	1-163-259-91	CERAMIC CHIP	220PF	5%	50V						
C202	1-163-021-91	CERAMIC CHIP	0.01uF	10%	50V						
C203	1-163-259-91	CERAMIC CHIP	220PF	5%	50V						
C204	1-163-259-91	CERAMIC CHIP	220PF	5%	50V						
C205	1-163-259-91	CERAMIC CHIP	220PF	5%	50V						
C206	1-163-259-91	CERAMIC CHIP	220PF	5%	50V						
C207	1-163-009-11	CERAMIC CHIP	0.001uF	10%	50V						
C208	1-163-259-91	CERAMIC CHIP	220PF	5%	50V						(US, CND)
C209	1-163-259-91	CERAMIC CHIP	220PF	5%	50V						
C210	1-163-259-91	CERAMIC CHIP	220PF	5%	50V						
C212	1-163-259-91	CERAMIC CHIP	220PF	5%	50V						
C213	1-164-004-11	CERAMIC CHIP	0.1uF	10%	25V						
C214	1-164-004-11	CERAMIC CHIP	0.1uF	10%	25V						
C217	1-164-004-11	CERAMIC CHIP	0.1uF	10%	25V						
C218	1-163-259-91	CERAMIC CHIP	220PF	5%	50V						
C219	1-163-259-91	CERAMIC CHIP	220PF	5%	50V						
C220	1-163-021-91	CERAMIC CHIP	0.01uF	10%	50V						
C222	1-163-259-91	CERAMIC CHIP	220PF	5%	50V						(US, CND)
C223	1-164-004-11	CERAMIC CHIP	0.1uF	10%	25V						
C224	1-164-004-11	CERAMIC CHIP	0.1uF	10%	25V						
C225	1-163-259-91	CERAMIC CHIP	220PF	5%	50V						
C226	1-115-339-11	CERAMIC CHIP	0.1uF	10%	50V						
C227	1-163-259-91	CERAMIC CHIP	220PF	5%	50V						
		< CONNECTOR >									
CN201	1-750-198-21	CONNECTOR, BOARD TO BOARD	16P								
* CN202	1-564-720-11	PIN, CONNECTOR (SMALL TYPE)	4P								
CN203	1-779-934-11	CONNECTOR, FFC/FPC	9P								
CN204	1-794-506-21	CONNECTOR, FFC/FPC	13P								
		< DIODE >									
D201	8-719-914-43	DIODE	DAN202K-T-146	(US, CND)							
D202	8-719-988-61	DIODE	1SS355TE-17								
D203	8-719-058-00	DIODE	SML-211DT-T86	(VIDEO OFF)							
D204	8-719-058-00	DIODE	SML-211DT-T86	(FL OFF)							
D205	8-719-058-00	DIODE	SML-211DT-T86	(DIGITAL OFF)							
D206	8-719-058-00	DIODE	SML-211DT-T86	(SACD)							
D207	8-719-058-00	DIODE	SML-211DT-T86	(PROGRESSIVE)							
D208	8-719-058-00	DIODE	SML-211DT-T86	(FILM)							

Ref. No.	Part No.	Description	Remark
< IC >			
IC201	8-759-710-82	IC NJM2406F-TE2 (US, CND)	
IC202	8-759-710-82	IC NJM2406F-TE2	
IC203	8-759-673-34	IC PST7030MT	
IC204	8-759-681-64	IC M38B57MCH-1360FP	
IC205	8-759-491-36	IC TC74VHCT244AF (EL)	
IC206	8-759-491-36	IC TC74VHCT244AF (EL)	
IC207	8-759-593-18	IC M35501FP-T2	
< FLUORESCENT INDICATOR >			
ND201	1-518-705-11	INDICATOR TUBE, FLUORESCENT	
< TRANSISTOR >			
Q201	8-729-216-22	TRANSISTOR 2SB709A-QRS-TX (US, CND)	
Q202	8-729-424-18	TRANSISTOR UN2113-TX (US, CND)	
Q203	8-729-424-73	TRANSISTOR UN2219-TX	
Q204	8-729-049-77	TRANSISTOR HN1B01F-GR (T5LSOONY)	
Q205	8-729-902-99	TRANSISTOR UN2215-QRS (TX)	
Q206	8-729-424-08	TRANSISTOR UN2111-TX	
Q208	8-729-421-22	TRANSISTOR UN2211-TX	
< RESISTOR >			
R202	1-216-025-11	RES-CHIP 100 5% 1/10W	
R203	1-216-037-00	METAL CHIP 330 5% 1/10W	
R204	1-216-035-00	METAL CHIP 270 5% 1/10W	
R205	1-216-035-00	METAL CHIP 270 5% 1/10W	
R206	1-216-035-00	METAL CHIP 270 5% 1/10W	
R207	1-216-035-00	METAL CHIP 270 5% 1/10W	
R208	1-216-073-00	METAL CHIP 10K 5% 1/10W	
R209	1-216-073-00	METAL CHIP 10K 5% 1/10W	
R210	1-208-814-91	METAL CHIP 22K 0.5% 1/10W	
R211	1-208-806-11	METAL CHIP 10K 0.5% 1/10W	
R212	1-216-065-91	RES-CHIP 4.7K 5% 1/10W	
R213	1-216-049-11	RES-CHIP 1K 5% 1/10W	
R214	1-216-095-00	METAL CHIP 82K 5% 1/10W	
R215	1-216-095-00	METAL CHIP 82K 5% 1/10W	
R216	1-216-081-00	METAL CHIP 22K 5% 1/10W (US, CND)	
R217	1-216-081-00	METAL CHIP 22K 5% 1/10W (US, CND)	
R218	1-216-073-00	METAL CHIP 10K 5% 1/10W (US, CND)	
R219	1-216-049-11	RES-CHIP 1K 5% 1/10W (US, CND)	
R220	1-216-025-11	RES-CHIP 100 5% 1/10W	
R221	1-216-025-11	RES-CHIP 100 5% 1/10W	
R222	1-216-025-11	RES-CHIP 100 5% 1/10W	
R223	1-216-025-11	RES-CHIP 100 5% 1/10W	
R224	1-216-025-11	RES-CHIP 100 5% 1/10W	
R225	1-216-025-11	RES-CHIP 100 5% 1/10W	
R227	1-216-025-11	RES-CHIP 100 5% 1/10W	
R228	1-216-025-11	RES-CHIP 100 5% 1/10W	
R229	1-216-057-00	METAL CHIP 2.2K 5% 1/10W (US, CND)	
R230	1-216-025-11	RES-CHIP 100 5% 1/10W	
R231	1-216-073-00	METAL CHIP 10K 5% 1/10W	
R232	1-216-049-11	RES-CHIP 1K 5% 1/10W	
R233	1-216-073-00	METAL CHIP 10K 5% 1/10W	
R234	1-216-097-11	RES-CHIP 100K 5% 1/10W	

Ref. No.	Part No.	Description	Remark
R235	1-216-033-00	METAL CHIP 220 5% 1/10W	
R236	1-216-025-11	RES-CHIP 100 5% 1/10W	
R238	1-216-097-11	RES-CHIP 100K 5% 1/10W	
R240	1-216-073-00	METAL CHIP 10K 5% 1/10W	
R241	1-216-073-00	METAL CHIP 10K 5% 1/10W	
R243	1-216-025-11	RES-CHIP 100 5% 1/10W	
R244	1-216-049-11	RES-CHIP 1K 5% 1/10W	
R245	1-216-025-11	RES-CHIP 100 5% 1/10W	
R246	1-216-073-00	METAL CHIP 10K 5% 1/10W	
R249	1-216-073-00	METAL CHIP 10K 5% 1/10W	
R251	1-216-073-00	METAL CHIP 10K 5% 1/10W	
R252	1-216-073-00	METAL CHIP 10K 5% 1/10W	
R253	1-216-025-11	RES-CHIP 100 5% 1/10W	
R254	1-216-031-00	METAL CHIP 180 5% 1/10W	
R255	1-216-025-11	RES-CHIP 100 5% 1/10W	
R256	1-216-049-11	RES-CHIP 1K 5% 1/10W	
R257	1-216-035-00	METAL CHIP 270 5% 1/10W	
R258	1-216-093-91	RES-CHIP 68K 5% 1/10W	
R259	1-216-093-91	RES-CHIP 68K 5% 1/10W	
R260	1-216-093-91	RES-CHIP 68K 5% 1/10W	
R261	1-216-093-91	RES-CHIP 68K 5% 1/10W	
R262	1-216-093-91	RES-CHIP 68K 5% 1/10W	
R263	1-216-093-91	RES-CHIP 68K 5% 1/10W	
R264	1-216-093-91	RES-CHIP 68K 5% 1/10W	
R265	1-216-093-91	RES-CHIP 68K 5% 1/10W	
R266	1-216-093-91	RES-CHIP 68K 5% 1/10W	
R267	1-216-035-00	METAL CHIP 270 5% 1/10W	
R268	1-216-025-11	RES-CHIP 100 5% 1/10W	
R271	1-216-049-11	RES-CHIP 1K 5% 1/10W	
R272	1-216-295-11	SHORT 0	
R273	1-216-093-91	RES-CHIP 68K 5% 1/10W	
R274	1-216-093-91	RES-CHIP 68K 5% 1/10W	
R275	1-216-093-91	RES-CHIP 68K 5% 1/10W	
R276	1-216-093-91	RES-CHIP 68K 5% 1/10W	
< VIBRATOR >			
X201	1-795-040-21	VIBRATOR, CERAMIC (2MHZ)	
*****			
*	A-6065-570-A	FR-172 BOARD, COMPLETE	(Ref.No. 4,000 Series)
*****			
< CAPACITOR >			
C101	1-126-395-11	ELECT 22uF 20% 16V	
C102	1-164-004-11	CERAMIC CHIP 0.1uF 10% 25V	
C103	1-135-600-21	ELECT 22uF 20% 20V	
C104	1-164-004-11	CERAMIC CHIP 0.1uF 10% 25V	
C105	1-164-004-11	CERAMIC CHIP 0.1uF 10% 25V	
C106	1-126-395-11	ELECT 22uF 20% 16V	
C107	1-163-017-00	CERAMIC CHIP 0.0047uF 5% 50V	
C108	1-115-339-11	CERAMIC CHIP 0.1uF 10% 50V	
C109	1-128-405-11	ELECT CHIP 22uF 20% 50V	
C110	1-128-405-11	ELECT CHIP 22uF 20% 50V	
C111	1-115-339-11	CERAMIC CHIP 0.1uF 10% 50V	
C112	1-115-339-11	CERAMIC CHIP 0.1uF 10% 50V	
C113	1-126-205-11	ELECT CHIP 47uF 20% 6.3V	
C114	1-127-971-21	FILM CHIP 0.01uF 5% 50V	



Ref. No.	Part No.	Description	Remark	Ref. No.	Part No.	Description	Remark
		< CONNECTOR >					
* CN101	1-564-724-11	PIN, CONNECTOR (SMALL TYPE) 8P		*	A-6065-579-A	MB-91 BOARD, COMPLETE (AEP, UK)	
CN102	1-750-189-21	CONNECTOR, BOARD TO BOARD 16P		*	A-6065-587-A	MB-91 BOARD, COMPLETE (HK)	
		< DIODE >		*	A-6065-591-A	MB-91 BOARD, COMPLETE (AUS)	
D106	8-719-041-97	DIODE MA113- (TX)		*	A-6065-590-A	MB-91 BOARD, COMPLETE (CN)	
D107	8-719-041-97	DIODE MA113- (TX)		*	A-6065-592-A	MB-91 BOARD, COMPLETE (US, CND)	
D108	8-719-041-97	DIODE MA113- (TX)				*****	
D109	8-719-041-97	DIODE MA113- (TX)				(Ref.No. 1,000 Series)	
D110	8-719-018-12	DIODE MA8330-L-TX				< CAPACITOR >	
D111	8-719-422-80	DIODE MA8075-H-TX		C101	1-107-826-11	CERAMIC CHIP 0.1uF 10% 16V	
D112	8-719-056-11	DIODE SML72423C-TP15 (ON/STANDBY)		C102	1-126-204-11	ELECT CHIP 47uF 20% 16V	
D113	8-719-081-64	DIODE NSCW100-BST (SUPER AUDIO CD)		C103	1-126-205-11	ELECT CHIP 47uF 20% 6.3V	
D114	8-719-023-25	DIODE MA704WK- (TX)		C104	1-162-919-11	CERAMIC CHIP 22PF 5% 50V	
		< FERRITE BEAD >		C105	1-162-919-11	CERAMIC CHIP 22PF 5% 50V	
FB101	1-414-135-11	FERRITE 0uH		C106	1-162-970-11	CERAMIC CHIP 0.01uF 10% 25V	
FB102	1-414-135-11	FERRITE 0uH		C107	1-126-209-11	ELECT CHIP 100uF 20% 4V	
FB103	1-414-135-11	FERRITE 0uH		C109	1-126-607-11	ELECT CHIP 47uF 20% 4V	
FB104	1-469-324-21	FERRITE 0uH		C110	1-107-826-11	CERAMIC CHIP 0.1uF 10% 16V	
FB105	1-414-135-11	FERRITE 0uH		C112	1-126-209-11	ELECT CHIP 100uF 20% 4V	
		< IC >		C113	1-107-826-11	CERAMIC CHIP 0.1uF 10% 16V	
IC101	8-759-486-55	IC NJM2370U33-TE2		C114	1-107-826-11	CERAMIC CHIP 0.1uF 10% 16V	
IC102	8-759-459-85	IC NJL63H400A		C115	1-162-970-11	CERAMIC CHIP 0.01uF 10% 25V	
		< COIL >		C116	1-162-970-11	CERAMIC CHIP 0.01uF 10% 25V	
L101	1-412-533-21	INDUCTOR 47uH		C117	1-162-970-11	CERAMIC CHIP 0.01uF 10% 25V	
		< TRANSISTOR >		C118	1-107-826-11	CERAMIC CHIP 0.1uF 10% 16V	
Q101	8-729-808-42	TRANSISTOR 2SD1624-T-TD		C119	1-162-970-11	CERAMIC CHIP 0.01uF 10% 25V	
Q102	8-729-808-42	TRANSISTOR 2SD1624-T-TD		C120	1-126-209-11	ELECT CHIP 100uF 20% 4V	
Q103	8-729-804-41	TRANSISTOR 2SB1122-ST-TD		C121	1-162-970-11	CERAMIC CHIP 0.01uF 10% 25V	
Q104	8-729-807-51	TRANSISTOR 2SC2873Y-TE12L		C122	1-162-970-11	CERAMIC CHIP 0.01uF 10% 25V	
Q105	8-729-424-08	TRANSISTOR UN2111-TX		C123	1-126-205-11	ELECT CHIP 47uF 20% 6.3V	
Q106	8-729-421-22	TRANSISTOR UN2211-TX		C124	1-107-826-11	CERAMIC CHIP 0.1uF 10% 16V	
Q107	8-729-424-08	TRANSISTOR UN2111-TX		C125	1-107-826-11	CERAMIC CHIP 0.1uF 10% 16V	
Q108	8-729-421-22	TRANSISTOR UN2211-TX		C126	1-162-970-11	CERAMIC CHIP 0.01uF 10% 25V	
Q109	8-729-424-08	TRANSISTOR UN2111-TX		C127	1-162-970-11	CERAMIC CHIP 0.01uF 10% 25V	
Q110	8-729-421-22	TRANSISTOR UN2211-TX		C128	1-107-826-11	CERAMIC CHIP 0.1uF 10% 16V	
Q111	8-729-421-22	TRANSISTOR UN2211-TX		C129	1-107-826-11	CERAMIC CHIP 0.1uF 10% 16V	
		< RESISTOR >		C201	1-162-970-11	CERAMIC CHIP 0.01uF 10% 25V	
R102	1-216-214-00	RES-CHIP 4.7K 5% 1/8W		C202	1-162-970-11	CERAMIC CHIP 0.01uF 10% 25V	
R103	1-216-063-91	RES-CHIP 3.9K 5% 1/10W		C203	1-162-970-11	CERAMIC CHIP 0.01uF 10% 25V	
R105	1-216-073-00	METAL CHIP 10K 5% 1/10W		C204	1-162-970-11	CERAMIC CHIP 0.01uF 10% 25V	
R106	1-216-041-00	METAL CHIP 470 5% 1/10W		C205	1-162-970-11	CERAMIC CHIP 0.01uF 10% 25V	
R107	1-216-035-00	METAL CHIP 270 5% 1/10W		C206	1-162-970-11	CERAMIC CHIP 0.01uF 10% 25V	
R108	1-216-017-91	RES-CHIP 47 5% 1/10W		C302	1-107-826-11	CERAMIC CHIP 0.1uF 10% 16V	
R109	1-216-089-11	RES-CHIP 47K 5% 1/10W		C303	1-107-826-11	CERAMIC CHIP 0.1uF 10% 16V	
R110	1-216-083-00	METAL CHIP 27K 5% 1/10W		C305	1-107-826-11	CERAMIC CHIP 0.1uF 10% 16V	
R111	1-216-049-11	RES-CHIP 1K 5% 1/10W		C306	1-107-826-11	CERAMIC CHIP 0.1uF 10% 16V	
R112	1-216-049-11	RES-CHIP 1K 5% 1/10W		C307	1-110-563-11	CERAMIC CHIP 0.068uF 10% 16V	
R113	1-216-073-00	METAL CHIP 10K 5% 1/10W		C308	1-104-851-11	TANTAL. CHIP 10uF 20% 10V	
R114	1-216-053-00	METAL CHIP 1.5K 5% 1/10W		C309	1-162-970-11	CERAMIC CHIP 0.01uF 10% 25V	
		< TRANSFORMER >		C310	1-162-970-11	CERAMIC CHIP 0.01uF 10% 25V	
T102	1-435-678-11	TRANSFORMER, DC-DC CONVERTER		C311	1-162-927-11	CERAMIC CHIP 100PF 5% 50V	
				C312	1-162-970-11	CERAMIC CHIP 0.01uF 10% 25V	
				C313	1-162-970-11	CERAMIC CHIP 0.01uF 10% 25V	
				C314	1-162-970-11	CERAMIC CHIP 0.01uF 10% 25V	
				C315	1-162-970-11	CERAMIC CHIP 0.01uF 10% 25V	
				C316	1-162-970-11	CERAMIC CHIP 0.01uF 10% 25V	
				C317	1-162-970-11	CERAMIC CHIP 0.01uF 10% 25V	
				C318	1-162-970-11	CERAMIC CHIP 0.01uF 10% 25V	
				C319	1-162-970-11	CERAMIC CHIP 0.01uF 10% 25V	
				C320	1-162-970-11	CERAMIC CHIP 0.01uF 10% 25V	

**MB-91**

Ref. No.	Part No.	Description			Remark	Ref. No.	Part No.	Description			Remark
C321	1-107-826-11	CERAMIC CHIP	0.1uF	10%	16V	C447	1-107-826-11	CERAMIC CHIP	0.1uF	10%	16V
C322	1-162-970-11	CERAMIC CHIP	0.01uF	10%	25V	C448	1-162-968-11	CERAMIC CHIP	0.0047uF	10%	50V
C323	1-162-970-11	CERAMIC CHIP	0.01uF	10%	25V	C449	1-162-968-11	CERAMIC CHIP	0.0047uF	10%	50V
C324	1-162-970-11	CERAMIC CHIP	0.01uF	10%	25V	C450	1-162-968-11	CERAMIC CHIP	0.0047uF	10%	50V
C325	1-126-206-11	ELECT CHIP	100uF	20%	6.3V	C451	1-126-607-11	ELECT CHIP	47uF	20%	4V
C326	1-126-206-11	ELECT CHIP	100uF	20%	6.3V	C452	1-162-970-11	CERAMIC CHIP	0.01uF	10%	25V
C327	1-107-826-11	CERAMIC CHIP	0.1uF	10%	16V	C453	1-162-970-11	CERAMIC CHIP	0.01uF	10%	25V
C328	1-162-970-11	CERAMIC CHIP	0.01uF	10%	25V	C454	1-162-970-11	CERAMIC CHIP	0.01uF	10%	25V
C329	1-162-970-11	CERAMIC CHIP	0.01uF	10%	25V	C455	1-162-970-11	CERAMIC CHIP	0.01uF	10%	25V
C330	1-107-826-11	CERAMIC CHIP	0.1uF	10%	16V	C456	1-107-826-11	CERAMIC CHIP	0.1uF	10%	16V
C331	1-162-970-11	CERAMIC CHIP	0.01uF	10%	25V	C457	1-115-467-11	CERAMIC CHIP	0.22uF	10%	10V
C332	1-162-968-11	CERAMIC CHIP	0.0047uF	10%	50V	C458	1-107-826-11	CERAMIC CHIP	0.1uF	10%	16V
C333	1-162-970-11	CERAMIC CHIP	0.01uF	10%	25V	C459	1-162-964-11	CERAMIC CHIP	0.001uF	10%	50V
C334	1-162-970-11	CERAMIC CHIP	0.01uF	10%	25V	C460	1-162-970-11	CERAMIC CHIP	0.01uF	10%	25V
C335	1-162-970-11	CERAMIC CHIP	0.01uF	10%	25V	C462	1-162-970-11	CERAMIC CHIP	0.01uF	10%	25V
C336	1-162-970-11	CERAMIC CHIP	0.01uF	10%	25V	C463	1-162-970-11	CERAMIC CHIP	0.01uF	10%	25V
C337	1-162-970-11	CERAMIC CHIP	0.01uF	10%	25V	C465	1-107-826-11	CERAMIC CHIP	0.1uF	10%	16V
C338	1-162-970-11	CERAMIC CHIP	0.01uF	10%	25V	C466	1-107-826-11	CERAMIC CHIP	0.1uF	10%	16V
C339	1-162-970-11	CERAMIC CHIP	0.01uF	10%	25V	C469	1-162-970-11	CERAMIC CHIP	0.01uF	10%	25V
C401	1-107-826-11	CERAMIC CHIP	0.1uF	10%	16V	C601	1-107-826-11	CERAMIC CHIP	0.1uF	10%	16V
C405	1-126-204-11	ELECT CHIP	47uF	20%	16V	C602	1-126-209-11	ELECT CHIP	100uF	20%	4V
C407	1-107-826-11	CERAMIC CHIP	0.1uF	10%	16V	C603	1-104-851-11	TANTAL. CHIP	10uF	20%	10V
C408	1-107-826-11	CERAMIC CHIP	0.1uF	10%	16V	C604	1-104-851-11	TANTAL. CHIP	10uF	20%	10V
C409	1-164-315-11	CERAMIC CHIP	470PF	5%	50V	C605	1-104-851-11	TANTAL. CHIP	10uF	20%	10V
C410	1-162-921-11	CERAMIC CHIP	33PF	5%	50V	C606	1-104-851-11	TANTAL. CHIP	10uF	20%	10V
C411	1-107-826-11	CERAMIC CHIP	0.1uF	10%	16V	C607	1-104-851-11	TANTAL. CHIP	10uF	20%	10V
C412	1-110-563-11	CERAMIC CHIP	0.068uF	10%	16V	C608	1-162-970-11	CERAMIC CHIP	0.01uF	10%	25V
C413	1-107-826-11	CERAMIC CHIP	0.1uF	10%	16V	C609	1-162-970-11	CERAMIC CHIP	0.01uF	10%	25V
C414	1-107-826-11	CERAMIC CHIP	0.1uF	10%	16V	C610	1-162-970-11	CERAMIC CHIP	0.01uF	10%	25V
C415	1-107-826-11	CERAMIC CHIP	0.1uF	10%	16V	C611	1-162-970-11	CERAMIC CHIP	0.01uF	10%	25V
C416	1-107-826-11	CERAMIC CHIP	0.1uF	10%	16V	C612	1-162-970-11	CERAMIC CHIP	0.01uF	10%	25V
C417	1-115-467-11	CERAMIC CHIP	0.22uF	10%	10V	C613	1-162-970-11	CERAMIC CHIP	0.01uF	10%	25V
C418	1-162-921-11	CERAMIC CHIP	33PF	5%	50V	C614	1-162-970-11	CERAMIC CHIP	0.01uF	10%	25V
C419	1-110-563-11	CERAMIC CHIP	0.068uF	10%	16V	C615	1-104-851-11	TANTAL. CHIP	10uF	20%	10V
C420	1-162-966-11	CERAMIC CHIP	0.0022uF	10%	50V	C619	1-162-970-11	CERAMIC CHIP	0.01uF	10%	25V
C421	1-107-826-11	CERAMIC CHIP	0.1uF	10%	16V	C620	1-162-970-11	CERAMIC CHIP	0.01uF	10%	25V
C422	1-162-966-11	CERAMIC CHIP	0.0022uF	10%	50V	C621	1-162-970-11	CERAMIC CHIP	0.01uF	10%	25V
C423	1-165-176-11	CERAMIC CHIP	0.047uF	10%	16V	C622	1-162-970-11	CERAMIC CHIP	0.01uF	10%	25V
C424	1-162-966-11	CERAMIC CHIP	0.0022uF	10%	50V	C623	1-162-970-11	CERAMIC CHIP	0.01uF	10%	25V
C425	1-115-467-11	CERAMIC CHIP	0.22uF	10%	10V	C627	1-162-970-11	CERAMIC CHIP	0.01uF	10%	25V
C426	1-164-315-11	CERAMIC CHIP	470PF	5%	50V	C628	1-162-970-11	CERAMIC CHIP	0.01uF	10%	25V
C427	1-162-966-11	CERAMIC CHIP	0.0022uF	10%	50V	C629	1-162-970-11	CERAMIC CHIP	0.01uF	10%	25V
C428	1-165-176-11	CERAMIC CHIP	0.047uF	10%	16V	C630	1-162-970-11	CERAMIC CHIP	0.01uF	10%	25V
C429	1-165-176-11	CERAMIC CHIP	0.047uF	10%	16V	C632	1-162-970-11	CERAMIC CHIP	0.01uF	10%	25V
C430	1-107-826-11	CERAMIC CHIP	0.1uF	10%	16V	C637	1-162-970-11	CERAMIC CHIP	0.01uF	10%	25V
C431	1-107-826-11	CERAMIC CHIP	0.1uF	10%	16V	C638	1-107-826-11	CERAMIC CHIP	0.1uF	10%	16V
C433	1-107-826-11	CERAMIC CHIP	0.1uF	10%	16V	C639	1-162-970-11	CERAMIC CHIP	0.01uF	10%	25V
C434	1-164-315-11	CERAMIC CHIP	470PF	5%	50V	C640	1-107-826-11	CERAMIC CHIP	0.1uF	10%	16V
C435	1-164-315-11	CERAMIC CHIP	470PF	5%	50V	C641	1-162-970-11	CERAMIC CHIP	0.01uF	10%	25V
C436	1-164-677-11	CERAMIC CHIP	0.033uF	10%	16V	C642	1-162-970-11	CERAMIC CHIP	0.01uF	10%	25V
C437	1-107-826-11	CERAMIC CHIP	0.1uF	10%	16V	C643	1-162-970-11	CERAMIC CHIP	0.01uF	10%	25V
C438	1-164-677-11	CERAMIC CHIP	0.033uF	10%	16V	C644	1-162-970-11	CERAMIC CHIP	0.01uF	10%	25V
C439	1-107-826-11	CERAMIC CHIP	0.1uF	10%	16V	C645	1-162-970-11	CERAMIC CHIP	0.01uF	10%	25V
C440	1-107-826-11	CERAMIC CHIP	0.1uF	10%	16V	C646	1-162-970-11	CERAMIC CHIP	0.01uF	10%	25V
C441	1-164-227-11	CERAMIC CHIP	0.022uF	10%	25V	C647	1-162-970-11	CERAMIC CHIP	0.01uF	10%	25V
C442	1-165-176-11	CERAMIC CHIP	0.047uF	10%	16V	C648	1-162-970-11	CERAMIC CHIP	0.01uF	10%	25V
C443	1-165-176-11	CERAMIC CHIP	0.047uF	10%	16V	C649	1-104-851-11	TANTAL. CHIP	10uF	20%	10V
C444	1-126-205-11	ELECT CHIP	47uF	20%	6.3V	C703	1-126-607-11	ELECT CHIP	47uF	20%	4V
C445	1-107-826-11	CERAMIC CHIP	0.1uF	10%	16V	C704	1-162-970-11	CERAMIC CHIP	0.01uF	10%	25V
C446	1-107-826-11	CERAMIC CHIP	0.1uF	10%	16V	C705	1-162-970-11	CERAMIC CHIP	0.01uF	10%	25V

Ref. No.	Part No.	Description	Remark	Ref. No.	Part No.	Description	Remark
C706	1-126-607-11	ELECT CHIP	47uF 20% 4V	CN105	1-573-290-21	PIN, CONNECTOR (1.5mm) (SMD) 4P	(AEP, UK)
C707	1-162-970-11	CERAMIC CHIP	0.01uF 10% 25V	CN106	1-778-274-11	CONNECTOR, FFC/FPC 13P	
C708	1-162-970-11	CERAMIC CHIP	0.01uF 10% 25V	* CN402	1-573-768-21	PIN, CONNECTOR (1.5mm) (SMD) 5P	
C709	1-162-970-11	CERAMIC CHIP	0.01uF 10% 25V	CN403	1-774-333-11	CONNECTOR, FFC/FPC 21P	
C710	1-162-970-11	CERAMIC CHIP	0.01uF 10% 25V	CN404	1-774-333-11	CONNECTOR, FFC/FPC 21P	
C711	1-162-970-11	CERAMIC CHIP	0.01uF 10% 25V	* CN405	1-764-177-11	PIN, CONNECTOR (SMD) (1.5mm) 7P	
C712	1-162-970-11	CERAMIC CHIP	0.01uF 10% 25V	CN801	1-784-327-11	CONNECTOR, FFC/FPC 28P	
C713	1-162-970-11	CERAMIC CHIP	0.01uF 10% 25V	CN901	1-779-992-11	PIN, CONNECTOR (PWB) 8P	
C714	1-162-970-11	CERAMIC CHIP	0.01uF 10% 25V	CN902	1-774-333-11	CONNECTOR, FFC/FPC 21P	
C715	1-107-826-11	CERAMIC CHIP	0.1uF 10% 16V	< DIODE >			
C716	1-126-607-11	ELECT CHIP	47uF 20% 4V	D101	8-719-941-86	DIODE DAN202UT106	
C801	1-126-607-11	ELECT CHIP	47uF 20% 4V	D404	8-719-422-37	DIODE MA8051-TX	
C802	1-126-607-11	ELECT CHIP	47uF 20% 4V	< FUSE >			
C803	1-162-970-11	CERAMIC CHIP	0.01uF 10% 25V	△F401	1-533-771-21	FUSE (SMD) (0.8A/DC24V)	
C804	1-126-607-11	ELECT CHIP	47uF 20% 4V	< FERRITE BEAD >			
C805	1-162-970-11	CERAMIC CHIP	0.01uF 10% 25V	FB101	1-469-324-21	FERRITE 0uH	
C806	1-162-970-11	CERAMIC CHIP	0.01uF 10% 25V	FB102	1-469-324-21	FERRITE 0uH	
C807	1-162-970-11	CERAMIC CHIP	0.01uF 10% 25V	FB103	1-469-324-21	FERRITE 0uH	
C808	1-162-970-11	CERAMIC CHIP	0.01uF 10% 25V	FB104	1-469-324-21	FERRITE 0uH	
C809	1-107-826-11	CERAMIC CHIP	0.1uF 10% 16V	FB106	1-469-324-21	FERRITE 0uH	
C812	1-162-970-11	CERAMIC CHIP	0.01uF 10% 25V	FB107	1-469-324-21	FERRITE 0uH	
C813	1-162-970-11	CERAMIC CHIP	0.01uF 10% 25V	FB108	1-469-324-21	FERRITE 0uH	
C814	1-162-970-11	CERAMIC CHIP	0.01uF 10% 25V	FB110	1-469-324-21	FERRITE 0uH	
C815	1-162-970-11	CERAMIC CHIP	0.01uF 10% 25V	FB113	1-216-864-11	METAL CHIP 0 5% 1/16W	
C816	1-162-970-11	CERAMIC CHIP	0.01uF 10% 25V	FB122	1-216-864-11	METAL CHIP 0 5% 1/16W	
C817	1-107-826-11	CERAMIC CHIP	0.1uF 10% 16V	FB123	1-216-864-11	METAL CHIP 0 5% 1/16W	
C818	1-162-970-11	CERAMIC CHIP	0.01uF 10% 25V	FB124	1-216-864-11	METAL CHIP 0 5% 1/16W	
C819	1-162-970-11	CERAMIC CHIP	0.01uF 10% 25V	FB125	1-469-116-21	FERRITE 0uH	
C821	1-162-970-11	CERAMIC CHIP	0.01uF 10% 25V	FB801	1-469-835-21	FERRITE 0uH	
C822	1-162-970-11	CERAMIC CHIP	0.01uF 10% 25V	FB802	1-216-864-11	METAL CHIP 0 5% 1/16W	
C825	1-162-970-11	CERAMIC CHIP	0.01uF 10% 25V	FB803	1-216-864-11	METAL CHIP 0 5% 1/16W	
C826	1-162-970-11	CERAMIC CHIP	0.01uF 10% 25V	FB804	1-216-864-11	METAL CHIP 0 5% 1/16W	
C827	1-162-970-11	CERAMIC CHIP	0.01uF 10% 25V	FB805	1-216-864-11	METAL CHIP 0 5% 1/16W	
C828	1-162-970-11	CERAMIC CHIP	0.01uF 10% 25V	FB806	1-216-864-11	METAL CHIP 0 5% 1/16W	
C829	1-162-970-11	CERAMIC CHIP	0.01uF 10% 25V	FB807	1-216-864-11	METAL CHIP 0 5% 1/16W	
C830	1-162-970-11	CERAMIC CHIP	0.01uF 10% 25V	FB808	1-216-864-11	METAL CHIP 0 5% 1/16W	
C831	1-162-970-11	CERAMIC CHIP	0.01uF 10% 25V	FB809	1-216-864-11	METAL CHIP 0 5% 1/16W	
C832	1-162-970-11	CERAMIC CHIP	0.01uF 10% 25V	FB810	1-216-864-11	METAL CHIP 0 5% 1/16W	
C833	1-162-970-11	CERAMIC CHIP	0.01uF 10% 25V	FB811	1-216-864-11	METAL CHIP 0 5% 1/16W	
C834	1-162-970-11	CERAMIC CHIP	0.01uF 10% 25V	FB812	1-469-835-21	FERRITE 0uH	
C835	1-162-970-11	CERAMIC CHIP	0.01uF 10% 25V	FB813	1-469-835-21	FERRITE 0uH	
C901	1-126-607-11	ELECT CHIP	47uF 20% 4V	FB814	1-216-864-11	METAL CHIP 0 5% 1/16W	
C902	1-162-970-11	CERAMIC CHIP	0.01uF 10% 25V	FB815	1-216-864-11	METAL CHIP 0 5% 1/16W	
C903	1-162-970-11	CERAMIC CHIP	0.01uF 10% 25V	FB817	1-216-864-11	METAL CHIP 0 5% 1/16W	
C904	1-162-970-11	CERAMIC CHIP	0.01uF 10% 25V	* FB901	1-500-449-21	FERRITE 0uH	
C905	1-162-970-11	CERAMIC CHIP	0.01uF 10% 25V	* FB902	1-500-449-21	FERRITE 0uH	
C906	1-162-970-11	CERAMIC CHIP	0.01uF 10% 25V	FB903	1-216-864-11	METAL CHIP 0 5% 1/16W	
C907	1-162-970-11	CERAMIC CHIP	0.01uF 10% 25V	FB904	1-216-864-11	METAL CHIP 0 5% 1/16W	
C908	1-162-970-11	CERAMIC CHIP	0.01uF 10% 25V	FB905	1-216-864-11	METAL CHIP 0 5% 1/16W	
C909	1-126-607-11	ELECT CHIP	47uF 20% 4V	FB906	1-216-864-11	METAL CHIP 0 5% 1/16W	
C910	1-162-970-11	CERAMIC CHIP	0.01uF 10% 25V	FB907	1-216-864-11	METAL CHIP 0 5% 1/16W	
C911	1-162-970-11	CERAMIC CHIP	0.01uF 10% 25V	FB908	1-216-864-11	METAL CHIP 0 5% 1/16W	
< CONNECTOR >				FB910	1-216-864-11	METAL CHIP 0 5% 1/16W	
* CN101	1-764-250-11	PIN, CONNECTOR (PC BOARD) 4P					
CN102	1-785-728-21	PIN (PC BOARD), CONNECTOR 7P					
CN104	1-573-290-21	PIN, CONNECTOR (1.5mm) (SMD) 4P					

The components identified by mark △ or dotted line with mark △ are critical for safety. Replace only with part number specified.	Les composants identifiés par une marque △ sont critiques pour la sécurité. Ne les remplacer que par une pièce portant le numéro spécifié.
--	--

# MB-91

Ref. No.	Part No.	Description	Remark	Ref. No.	Part No.	Description	Remark
FB912	1-216-864-11	METAL CHIP	0 5% 1/16W	IC401	8-759-660-88	IC LA6553-TE-L	
FB913	1-216-864-11	METAL CHIP	0 5% 1/16W	IC402	8-759-660-88	IC LA6553-TE-L	
FB914	1-216-864-11	METAL CHIP	0 5% 1/16W	IC403	8-759-338-78	IC BA10324AFV-E2	
FB915	1-216-864-11	METAL CHIP	0 5% 1/16W	IC404	8-759-689-72	IC CXD9594R	
FB918	1-216-864-11	METAL CHIP	0 5% 1/16W	IC405	8-759-100-93	IC uPC393G2-E2	
FB919	1-216-864-11	METAL CHIP	0 5% 1/16W	IC406	8-759-083-94	IC TC7W74FU (TE12R)	
FB920	1-469-835-21	FERRITE	0uH	IC601	8-759-582-37	IC PQ2TZ15U	
FB921	1-469-835-21	FERRITE	0uH	IC602	8-759-688-67	IC L64022C	
FB922	1-469-835-21	FERRITE	0uH	IC603	8-759-573-19	IC MT48LC1M16A1TG-7S	
FB923	1-469-835-21	FERRITE	0uH	IC604	8-759-573-19	IC MT48LC1M16A1TG-7S	
FB924	1-469-835-21	FERRITE	0uH	IC702	8-759-694-34	IC CXD9537AR	
FB925	1-216-864-11	METAL CHIP	0 5% 1/16W	IC801	8-759-667-18	IC PQ018EZ01ZP	
FB926	1-216-864-11	METAL CHIP	0 5% 1/16W	IC802	8-752-399-55	IC CXD1932Q	
FB927	1-216-864-11	METAL CHIP	0 5% 1/16W	IC804	8-759-573-19	IC MT48LC1M16A1TG-7S	
< FILTER >				IC805	8-759-573-19	IC MT48LC1M16A1TG-7S	
FL101	1-234-177-21	FILTER, CHIP EMI		IC806	8-759-669-28	IC PQ1R18	
FL102	1-233-893-21	FILTER, CHIP EMI		IC901	8-752-400-60	IC CXD2751Q	
FL103	1-234-177-21	FILTER, CHIP EMI		IC902	8-759-564-31	IC MSM51V17805B-60TKR1	
FL104	1-234-177-21	FILTER, CHIP EMI		IC903	8-759-475-39	IC TC74LCX74FT (EL)	
FL106	1-234-177-21	FILTER, CHIP EMI		IC904	8-759-058-58	IC TC7S04FU (TE85R)	
FL107	1-234-177-21	FILTER, CHIP EMI		< TRANSISTOR >			
FL108	1-234-177-21	FILTER, CHIP EMI		Q401	8-729-402-42	TRANSISTOR UN5213-TX	
FL109	1-234-177-21	FILTER, CHIP EMI		Q402	8-729-402-42	TRANSISTOR UN5213-TX	
FL201	1-234-177-21	FILTER, CHIP EMI		< RESISTOR >			
FL302	1-234-177-21	FILTER, CHIP EMI		R002	1-216-801-11	METAL CHIP 22 5% 1/16W	
FL303	1-234-177-21	FILTER, CHIP EMI		R009	1-216-821-11	METAL CHIP 1K 5% 1/16W	
FL402	1-234-177-21	FILTER, CHIP EMI		R012	1-216-833-11	METAL CHIP 10K 5% 1/16W	
FL601	1-234-177-21	FILTER, CHIP EMI		R013	1-216-833-11	METAL CHIP 10K 5% 1/16W	
FL602	1-234-177-21	FILTER, CHIP EMI		R014	1-216-809-11	METAL CHIP 100 5% 1/16W	
FL603	1-234-177-21	FILTER, CHIP EMI		R015	1-216-809-11	METAL CHIP 100 5% 1/16W	
FL604	1-234-177-21	FILTER, CHIP EMI		R016	1-216-821-11	METAL CHIP 1K 5% 1/16W	
FL605	1-234-177-21	FILTER, CHIP EMI		R017	1-216-821-11	METAL CHIP 1K 5% 1/16W	
FL606	1-234-177-21	FILTER, CHIP EMI		R019	1-216-817-11	METAL CHIP 470 5% 1/16W	
FL607	1-234-177-21	FILTER, CHIP EMI		R020	1-216-295-11	SHORT 0	
FL701	1-234-177-21	FILTER, CHIP EMI		R021	1-216-296-91	SHORT 0	
FL702	1-234-177-21	FILTER, CHIP EMI		R022	1-216-833-11	METAL CHIP 10K 5% 1/16W	
FL703	1-234-177-21	FILTER, CHIP EMI		R041	1-216-797-11	METAL CHIP 10 5% 1/16W	
FL801	1-234-177-21	FILTER, CHIP EMI		R042	1-216-797-11	METAL CHIP 10 5% 1/16W	
FL802	1-234-177-21	FILTER, CHIP EMI		R102	1-216-801-11	METAL CHIP 22 5% 1/16W	
FL803	1-234-177-21	FILTER, CHIP EMI		R103	1-216-845-11	METAL CHIP 100K 5% 1/16W	
FL805	1-234-177-21	FILTER, CHIP EMI		R104	1-216-833-11	METAL CHIP 10K 5% 1/16W	
FL901	1-234-177-21	FILTER, CHIP EMI		R105	1-216-833-11	METAL CHIP 10K 5% 1/16W	
FL902	1-234-177-21	FILTER, CHIP EMI		R107	1-216-833-11	METAL CHIP 10K 5% 1/16W	
< IC >				R108	1-216-833-11	METAL CHIP 10K 5% 1/16W	
IC101	8-759-469-25	IC AK6440AF-E2		R109	1-216-833-11	METAL CHIP 10K 5% 1/16W	
IC102	8-759-663-92	IC MB91107PFV-G-BND		R110	1-216-833-11	METAL CHIP 10K 5% 1/16W	
IC103	Note			R112	1-216-833-11	METAL CHIP 10K 5% 1/16W	
IC104	8-759-680-60	IC FS6308-01TE-L		R113	1-469-835-21	FERRITE 0uH	
IC105	8-759-573-65	IC IDT71V016S20PHAU-TL		R114	1-216-833-11	METAL CHIP 10K 5% 1/16W	
IC107	8-759-427-92	IC PST9126NL		R115	1-216-845-11	METAL CHIP 100K 5% 1/16W	
IC108	8-759-486-55	IC NJM2370U33-TE2		R116	1-216-833-11	METAL CHIP 10K 5% 1/16W	
IC201	8-759-689-58	IC CXD9598R		R119	1-216-817-11	METAL CHIP 470 5% 1/16W	
IC202	8-759-641-58	IC KM29W16000AT-T		R119	1-216-825-11	METAL CHIP 2.2K 5% 1/16W	(AUS)
IC301	8-752-371-18	IC CXD2302Q-T4		R119	1-216-827-11	METAL CHIP 3.3K 5% 1/16W	(HK)
IC302	8-759-486-55	IC NJM2370U33-TE2					(CN)
IC303	8-759-666-84	IC CXD9576R					
IC306	8-759-643-10	IC GM71V18160CT-6TR					

Note: Part number has not been determined yet. It will be noticed later.

Ref. No.	Part No.	Description			Remark	Ref. No.	Part No.	Description			Remark
R119	1-216-831-11	METAL CHIP	6.8K	5%	1/16W (AEP, UK)	R317	1-216-833-11	METAL CHIP	10K	5%	1/16W
R120	1-216-827-11	METAL CHIP	3.3K	5%	1/16W	R319	1-218-855-11	METAL CHIP	2.2K	0.5%	1/16W
R122	1-216-827-11	METAL CHIP	3.3K	5%	1/16W	R320	1-218-847-11	METAL CHIP	1K	0.5%	1/16W
R123	1-216-829-11	METAL CHIP	4.7K	5%	1/16W (CN)	R321	1-218-871-11	METAL CHIP	10K	0.5%	1/16W
R123	1-216-834-11	METAL CHIP	12K	5%	1/16W (AUS)	R322	1-218-871-11	METAL CHIP	10K	0.5%	1/16W
R123	1-216-837-11	METAL CHIP	22K	5%	1/16W (HK)	R323	1-216-833-11	METAL CHIP	10K	5%	1/16W
R123	1-216-841-11	METAL CHIP	47K	5%	1/16W (AEP, UK)	R324	1-216-833-11	METAL CHIP	10K	5%	1/16W
R124	1-216-827-11	METAL CHIP	3.3K	5%	1/16W	R325	1-218-853-11	METAL CHIP	1.8K	0.5%	1/16W
R125	1-216-845-11	METAL CHIP	100K	5%	1/16W	R328	1-216-833-11	METAL CHIP	10K	5%	1/16W
R126	1-216-845-11	METAL CHIP	100K	5%	1/16W	R329	1-216-813-11	METAL CHIP	220	5%	1/16W
R128	1-216-833-11	METAL CHIP	10K	5%	1/16W	R333	1-216-833-11	METAL CHIP	10K	5%	1/16W
R130	1-469-835-21	FERRITE	0uH			R337	1-216-809-11	METAL CHIP	100	5%	1/16W
R131	1-216-864-11	METAL CHIP	0	5%	1/16W	R346	1-216-864-11	METAL CHIP	0	5%	1/16W
R134	1-469-835-21	FERRITE	0uH			R347	1-216-801-11	METAL CHIP	22	5%	1/16W
R137	1-469-835-21	FERRITE	0uH			R348	1-216-833-11	METAL CHIP	10K	5%	1/16W
R141	1-469-835-21	FERRITE	0uH			R401	1-216-821-11	METAL CHIP	1K	5%	1/16W
R148	1-216-821-11	METAL CHIP	1K	5%	1/16W	R402	1-216-821-11	METAL CHIP	1K	5%	1/16W
R149	1-216-864-11	METAL CHIP	0	5%	1/16W	R403	1-216-821-11	METAL CHIP	1K	5%	1/16W
R150	1-216-864-11	METAL CHIP	0	5%	1/16W	R404	1-216-821-11	METAL CHIP	1K	5%	1/16W
R152	1-216-864-11	METAL CHIP	0	5%	1/16W	R405	1-216-821-11	METAL CHIP	1K	5%	1/16W
R153	1-216-864-11	METAL CHIP	0	5%	1/16W	R406	1-216-841-11	METAL CHIP	47K	5%	1/16W
R154	1-216-864-11	METAL CHIP	0	5%	1/16W	R407	1-216-797-11	METAL CHIP	10	5%	1/16W
R155	1-216-864-11	METAL CHIP	0	5%	1/16W	R408	1-216-311-00	METAL CHIP	6.8	5%	1/10W
R157	1-216-864-11	METAL CHIP	0	5%	1/16W	R409	1-216-797-11	METAL CHIP	10	5%	1/16W
R159	1-216-864-11	METAL CHIP	0	5%	1/16W	R410	1-216-841-11	METAL CHIP	47K	5%	1/16W
R162	1-216-833-11	METAL CHIP	10K	5%	1/16W	R411	1-216-835-11	METAL CHIP	15K	5%	1/16W
R163	1-216-833-11	METAL CHIP	10K	5%	1/16W	R412	1-216-797-11	METAL CHIP	10	5%	1/16W
R164	1-469-835-21	FERRITE	0uH			R413	1-216-829-11	METAL CHIP	4.7K	5%	1/16W
R165	1-469-835-21	FERRITE	0uH			R414	1-216-829-11	METAL CHIP	4.7K	5%	1/16W
R166	1-216-833-11	METAL CHIP	10K	5%	1/16W	R415	1-216-829-11	METAL CHIP	4.7K	5%	1/16W
R167	1-216-864-11	METAL CHIP	0	5%	1/16W	R416	1-216-844-11	METAL CHIP	82K	5%	1/16W
R168	1-216-864-11	METAL CHIP	0	5%	1/16W	R417	1-216-843-11	METAL CHIP	68K	5%	1/16W
R169	1-216-864-11	METAL CHIP	0	5%	1/16W	R418	1-216-844-11	METAL CHIP	82K	5%	1/16W
R170	1-216-864-11	METAL CHIP	0	5%	1/16W	R419	1-216-835-11	METAL CHIP	15K	5%	1/16W
R171	1-216-821-11	METAL CHIP	1K	5%	1/16W	R420	1-216-835-11	METAL CHIP	15K	5%	1/16W
R172	1-216-833-11	METAL CHIP	10K	5%	1/16W	R421	1-216-836-11	METAL CHIP	18K	5%	1/16W
R201	1-216-801-11	METAL CHIP	22	5%	1/16W	R422	1-216-825-11	METAL CHIP	2.2K	5%	1/16W
R202	1-216-864-11	METAL CHIP	0	5%	1/16W	R423	1-216-833-11	METAL CHIP	10K	5%	1/16W
R203	1-216-845-11	METAL CHIP	100K	5%	1/16W	R424	1-216-844-11	METAL CHIP	82K	5%	1/16W
R205	1-469-835-21	FERRITE	0uH			R425	1-216-845-11	METAL CHIP	100K	5%	1/16W
R206	1-469-835-21	FERRITE	0uH			R426	1-216-827-11	METAL CHIP	3.3K	5%	1/16W
R208	1-216-809-11	METAL CHIP	100	5%	1/16W	R427	1-216-835-11	METAL CHIP	15K	5%	1/16W
R209	1-469-835-21	FERRITE	0uH			R428	1-216-839-11	METAL CHIP	33K	5%	1/16W
R210	1-216-833-11	METAL CHIP	10K	5%	1/16W	R429	1-216-825-11	METAL CHIP	2.2K	5%	1/16W
R301	1-216-833-11	METAL CHIP	10K	5%	1/16W	R430	1-216-829-11	METAL CHIP	4.7K	5%	1/16W
R302	1-216-833-11	METAL CHIP	10K	5%	1/16W	R431	1-216-821-11	METAL CHIP	1K	5%	1/16W
R307	1-216-801-11	METAL CHIP	22	5%	1/16W	R432	1-216-833-11	METAL CHIP	10K	5%	1/16W
R308	1-218-879-11	METAL CHIP	22K	0.5%	1/16W	R436	1-216-833-11	METAL CHIP	10K	5%	1/16W
R309	1-218-831-11	METAL CHIP	220	0.5%	1/16W	R443	1-216-844-11	METAL CHIP	82K	5%	1/16W
R310	1-218-883-11	METAL CHIP	33K	0.5%	1/16W	R444	1-216-843-11	METAL CHIP	68K	5%	1/16W
R311	1-216-825-11	METAL CHIP	2.2K	5%	1/16W	R445	1-216-829-11	METAL CHIP	4.7K	5%	1/16W
R312	1-216-838-11	METAL CHIP	27K	5%	1/16W	R446	1-216-827-11	METAL CHIP	3.3K	5%	1/16W
R313	1-216-825-11	METAL CHIP	2.2K	5%	1/16W	R447	1-216-835-11	METAL CHIP	15K	5%	1/16W
R314	1-216-822-11	METAL CHIP	1.2K	5%	1/16W	R448	1-216-835-11	METAL CHIP	15K	5%	1/16W
R315	1-216-809-11	METAL CHIP	100	5%	1/16W	R449	1-216-832-11	METAL CHIP	8.2K	5%	1/16W
R316	1-216-833-11	METAL CHIP	10K	5%	1/16W	R450	1-216-833-11	METAL CHIP	10K	5%	1/16W
						R451	1-216-821-11	METAL CHIP	1K	5%	1/16W
						R452	1-216-797-11	METAL CHIP	10	5%	1/16W
						R454	1-216-311-00	METAL CHIP	6.8	5%	1/10W
						R458	1-216-833-11	METAL CHIP	10K	5%	1/16W

Ref. No.	Part No.	Description	Remark
R459	1-216-833-11	METAL CHIP 10K 5%	1/16W
R460	1-216-845-11	METAL CHIP 100K 5%	1/16W
R462	1-216-833-11	METAL CHIP 10K 5%	1/16W
R463	1-216-821-11	METAL CHIP 1K 5%	1/16W
R464	1-218-899-11	METAL CHIP 150K 0.5%	1/16W
R465	1-216-821-11	METAL CHIP 1K 5%	1/16W
R466	1-216-821-11	METAL CHIP 1K 5%	1/16W
R467	1-216-821-11	METAL CHIP 1K 5%	1/16W
R468	1-216-821-11	METAL CHIP 1K 5%	1/16W
R469	1-218-889-11	METAL CHIP 56K 0.5%	1/16W
R470	1-218-850-11	METAL CHIP 1.3K 0.5%	1/16W
R471	1-218-899-11	METAL CHIP 150K 0.5%	1/16W
R472	1-218-847-11	METAL CHIP 1K 0.5%	1/16W
R473	1-218-850-11	METAL CHIP 1.3K 0.5%	1/16W
R474	1-218-889-11	METAL CHIP 56K 0.5%	1/16W
R475	1-216-797-11	METAL CHIP 10 5%	1/16W
R476	1-216-813-11	METAL CHIP 220 5%	1/16W
R477	1-216-829-11	METAL CHIP 4.7K 5%	1/16W
R478	1-216-836-11	METAL CHIP 18K 5%	1/16W
R479	1-216-836-11	METAL CHIP 18K 5%	1/16W
R480	1-216-824-11	METAL CHIP 1.8K 5%	1/16W
R481	1-216-824-11	METAL CHIP 1.8K 5%	1/16W
R482	1-216-803-11	METAL CHIP 33 5%	1/16W
R483	1-216-834-11	METAL CHIP 12K 5%	1/16W
R484	1-216-834-11	METAL CHIP 12K 5%	1/16W
R485	1-216-817-11	METAL CHIP 470 5%	1/16W
R486	1-218-847-11	METAL CHIP 1K 0.5%	1/16W
R487	1-218-847-11	METAL CHIP 1K 0.5%	1/16W
R488	1-218-847-11	METAL CHIP 1K 0.5%	1/16W
R489	1-218-847-11	METAL CHIP 1K 0.5%	1/16W
R490	1-216-817-11	METAL CHIP 470 5%	1/16W
R491	1-216-821-11	METAL CHIP 1K 5%	1/16W
R492	1-216-817-11	METAL CHIP 470 5%	1/16W
R493	1-216-817-11	METAL CHIP 470 5%	1/16W
R494	1-216-817-11	METAL CHIP 470 5%	1/16W
R495	1-216-797-11	METAL CHIP 10 5%	1/16W
R496	1-216-821-11	METAL CHIP 1K 5%	1/16W
R497	1-216-821-11	METAL CHIP 1K 5%	1/16W
R602	1-216-809-11	METAL CHIP 100 5%	1/16W
R608	1-216-797-11	METAL CHIP 10 5%	1/16W
R628	1-216-864-11	METAL CHIP 0 5%	1/16W
R705	1-216-833-11	METAL CHIP 10K 5%	1/16W
R706	1-216-809-11	METAL CHIP 100 5%	1/16W
R707	1-216-864-11	METAL CHIP 0 5%	1/16W
R718	1-216-864-11	METAL CHIP 0 5%	1/16W
R801	1-216-809-11	METAL CHIP 100 5%	1/16W
R802	1-216-833-11	METAL CHIP 10K 5%	1/16W
R804	1-216-864-11	METAL CHIP 0 5%	1/16W
R808	1-216-833-11	METAL CHIP 10K 5%	1/16W
R809	1-216-801-11	METAL CHIP 22 5%	1/16W
R810	1-216-801-11	METAL CHIP 22 5%	1/16W
R811	1-216-801-11	METAL CHIP 22 5%	1/16W
R812	1-216-801-11	METAL CHIP 22 5%	1/16W
R813	1-216-801-11	METAL CHIP 22 5%	1/16W
R814	1-216-801-11	METAL CHIP 22 5%	1/16W
R815	1-216-801-11	METAL CHIP 22 5%	1/16W
R816	1-216-801-11	METAL CHIP 22 5%	1/16W
R819	1-469-835-21	FERRITE 0uH	
R826	1-216-833-11	METAL CHIP 10K 5%	1/16W
R828	1-216-822-11	METAL CHIP 1.2K 5%	1/16W

Ref. No.	Part No.	Description	Remark
R829	1-216-827-11	METAL CHIP 3.3K 5%	1/16W
R831	1-216-821-11	METAL CHIP 1K 5%	1/16W
R833	1-216-833-11	METAL CHIP 10K 5%	1/16W
R834	1-216-833-11	METAL CHIP 10K 5%	1/16W
R837	1-216-833-11	METAL CHIP 10K 5%	1/16W
R838	1-216-797-11	METAL CHIP 10 5%	1/16W
R839	1-216-864-11	METAL CHIP 0 5%	1/16W
R903	1-216-801-11	METAL CHIP 22 5%	1/16W
R904	1-216-833-11	METAL CHIP 10K 5%	1/16W
R905	1-216-801-11	METAL CHIP 22 5%	1/16W
R906	1-469-835-21	FERRITE 0uH	
R907	1-216-801-11	METAL CHIP 22 5%	1/16W
R908	1-216-801-11	METAL CHIP 22 5%	1/16W
R909	1-216-801-11	METAL CHIP 22 5%	1/16W
R910	1-216-801-11	METAL CHIP 22 5%	1/16W
< COMPOSITION CIRCUIT BLOCK >			
* RB101	1-233-270-11	NETWORK, RES (8 GANG) 10K	
* RB102	1-233-270-11	NETWORK, RES (8 GANG) 10K	
< VIBRATOR >			
X101	1-781-185-21	VIBRATOR, CERAMIC (12.5MHz)	
*****			
* A-6065-574-A	MS-59 BOARD, COMPLETE (Ref.No. 1,000 Series)		
*****			
< CAPACITOR >			
C501	1-163-021-91	CERAMIC CHIP 0.01uF 10% 50V	
C502	1-163-021-91	CERAMIC CHIP 0.01uF 10% 50V	
< CONNECTOR >			
CN501	1-573-383-11	PIN, CONNECTOR (PC BOARD) 2P	
CN502	1-784-612-11	CONNECTOR, FFC/FPC (ZIF) 7P	
< JUMPER RESISTOR >			
JR501	1-216-296-91	SHORT 0	
JR502	1-216-296-91	SHORT 0	
JR503	1-216-295-11	SHORT 0	
JR504	1-216-295-11	SHORT 0	
< PHOTO INTERRUPTER >			
PH501	8-749-014-69	IC SPI-238-18 (CHUCK SENSOR)	
PH502	8-749-017-89	IC SPI-237 (TRAY SENSOR)	
< TRANSISTOR >			
Q501	8-729-230-49	TRANSISTOR 2SC2712-YG-TE85L	
< RESISTOR >			
R501	1-216-041-00	METAL CHIP 470 5%	1/10W
R502	1-216-041-00	METAL CHIP 470 5%	1/10W
R503	1-216-095-00	METAL CHIP 82K 5%	1/10W
R504	1-216-095-00	METAL CHIP 82K 5%	1/10W
R505	1-216-095-00	METAL CHIP 82K 5%	1/10W
R506	1-216-073-00	METAL CHIP 10K 5%	1/10W
R507	1-216-061-00	METAL CHIP 3.3K 5%	1/10W
R508	1-216-073-00	METAL CHIP 10K 5%	1/10W

Ref. No.	Part No.	Description	Remark
*	A-6065-577-A	PS-436 BOARD, COMPLETE (US, CND)	
*	A-6065-584-A	PS-438 BOARD, COMPLETE (EXCEPT US, CND)	
***** (Ref.No. 2,000 Series)			
	3-053-984-01	SCREW (+BV/CU)	
	3-063-203-01	SHEET (TR), RADIATION	
	3-063-204-01	SHEET (9X9), RADIATION	
	7-685-651-79	SCREW +BVTP 3X20 TYPE2 IT-3	
< CAPACITOR >			
C301	1-128-959-21	ELECT	1000uF 20% 35V
C303	1-164-005-11	CERAMIC CHIP	0.47uF 25V
C305	1-163-019-00	CERAMIC CHIP	0.0068uF 10% 50V
C306	1-137-649-31	ELECT	220uF 20% 10V
C312	1-128-946-21	ELECT	2200uF 20% 10V
C313	1-115-339-11	CERAMIC CHIP	0.1uF 10% 50V
C316	1-115-339-11	CERAMIC CHIP	0.1uF 10% 50V
C319	1-137-644-11	ELECT (BLOCK)	12000uF 20% 35V
C324	1-163-275-11	CERAMIC CHIP	0.001uF 5% 50V
C325	1-163-275-11	CERAMIC CHIP	0.001uF 5% 50V
C327	1-163-275-11	CERAMIC CHIP	0.001uF 5% 50V
< CONNECTOR >			
* CN307	1-564-706-11	PIN, CONNECTOR (SMALL TYPE) 4P	
* CN309	1-564-506-11	PLUG, CONNECTOR 3P	
< DIODE >			
D301	8-719-073-81	DIODE EC21QS06-TE12L	
D303	8-719-820-05	DIODE 1SS181-TE85L	
D312	8-719-074-58	DIODE FCH10A10	
D313	8-719-074-58	DIODE FCH10A10	
D316	8-719-074-58	DIODE FCH10A10	
D317	8-719-074-58	DIODE FCH10A10	
D318	8-719-422-64	DIODE MA8062-M-TX	
< GROUND TERMINAL >			
ET301	1-537-770-21	TERMINAL BOARD, GROUND	
ET302	1-537-770-21	TERMINAL BOARD, GROUND	
< IC >			
IC301	8-759-688-68	IC LM2596T-ADJ	
IC303	8-759-284-06	IC PQ30RV31	
< COIL >			
L301	1-411-674-11	INDUCTOR	68uH
< TRANSISTOR >			
Q301	8-729-230-49	TRANSISTOR	2SC2712-YG-TE85L
< RESISTOR >			
R301	1-216-089-11	RES-CHIP	47K 5% 1/10W
R303	1-208-782-11	METAL CHIP	1K 0.5% 1/10W
R305	1-208-790-11	METAL CHIP	2.2K 0.5% 1/10W
R306	1-216-073-00	METAL CHIP	10K 5% 1/10W
R307	1-216-073-00	METAL CHIP	10K 5% 1/10W
R311	1-208-772-11	METAL CHIP	390 0.5% 1/10W
R312	1-208-778-11	METAL CHIP	680 0.5% 1/10W

Ref. No.	Part No.	Description	Remark
*	A-6065-578-A	PS-437 BOARD, COMPLETE (US, CND)	
*	A-6065-585-A	PS-439 BOARD, COMPLETE (AEP, UK)	
*	A-6065-589-A	PS-439 BOARD, COMPLETE (HK, CN, AUS)	
***** (Ref.No. 3,000 Series)			
	3-053-984-01	SCREW (+BV/CU)	
	3-063-203-01	SHEET (TR), RADIATION	
	3-063-204-01	SHEET (9X9), RADIATION	
	7-685-651-79	SCREW +BVTP 3X20 TYPE2 IT-3	
< CAPACITOR >			
C201	1-119-782-31	ELECT	1000uF 20% 10V
C202	1-119-782-31	ELECT	1000uF 20% 10V
C203	1-128-954-11	ELECT	1000uF 20% 25V
C204	1-128-954-11	ELECT	1000uF 20% 25V
C205	1-115-339-11	CERAMIC CHIP	0.1uF 10% 50V
C206	1-115-339-11	CERAMIC CHIP	0.1uF 10% 50V
C207	1-115-339-11	CERAMIC CHIP	0.1uF 10% 50V
C208	1-115-339-11	CERAMIC CHIP	0.1uF 10% 50V
C209	1-115-339-11	CERAMIC CHIP	0.1uF 10% 50V
C210	1-115-339-11	CERAMIC CHIP	0.1uF 10% 50V
C211	1-115-339-11	CERAMIC CHIP	0.1uF 10% 50V
C212	1-115-339-11	CERAMIC CHIP	0.1uF 10% 50V
C213	1-128-945-31	ELECT	1000uF 20% 10V
C214	1-128-952-31	ELECT	220uF 20% 25V
C215	1-130-471-00	MYLAR	0.001uF 5% 50V (AEP, UK)
C216	1-115-339-11	CERAMIC CHIP	0.1uF 10% 50V
C217	1-130-471-00	MYLAR	0.001uF 5% 50V
C218	1-137-650-51	ELECT	2200PF 20% 50V
C219	1-115-339-11	CERAMIC CHIP	0.1uF 10% 50V
C220	1-130-471-00	MYLAR	0.001uF 5% 50V (AEP, UK)
C221	1-115-339-11	CERAMIC CHIP	0.1uF 10% 50V (AEP, UK)
C222	1-137-743-21	ELECT	15000uF 20% 25V
C223	1-119-806-21	ELECT	3300uF 20% 25V
C224	1-135-515-11	ELECT	3300uF 20% 50V
C225	1-163-275-11	CERAMIC CHIP	0.001uF 5% 50V
C226	1-163-275-11	CERAMIC CHIP	0.001uF 5% 50V
C227	1-163-275-11	CERAMIC CHIP	0.001uF 5% 50V
C228	1-163-275-11	CERAMIC CHIP	0.001uF 5% 50V
C229	1-163-275-11	CERAMIC CHIP	0.001uF 5% 50V
C230	1-163-275-11	CERAMIC CHIP	0.001uF 5% 50V
< CONNECTOR >			
CN201	1-564-707-11	PIN, CONNECTOR (SMALL TYPE) 5P	
* CN203	1-564-709-11	PIN, CONNECTOR (SMALL TYPE) 7P	
* CN204	1-564-706-21	PIN, CONNECTOR (SMALL TYPE) 4P	
* CN206	1-564-506-11	PLUG, CONNECTOR 3P	
CN207	1-564-506-11	PLUG, CONNECTOR 3P	
< DIODE >			
D201	8-719-210-39	DIODE EC10QS04-TE12L5	
D202	8-719-210-39	DIODE EC10QS04-TE12L5	
D203	8-719-820-05	DIODE 1SS181-TE85L	
D204	8-719-820-05	DIODE 1SS181-TE85L	
D205	8-719-820-05	DIODE 1SS181-TE85L	
D206	8-719-820-05	DIODE 1SS181-TE85L	
D207	8-719-210-39	DIODE EC10QS04-TE12L5	
D208	8-719-051-66	DIODE MA7120-TA (AEP, UK)	

Ref. No.	Part No.	Description	Remark
D209	8-719-820-05	DIODE 1SS181-TE85L	
D210	8-719-074-58	DIODE FCH10A10	
D211	8-719-074-58	DIODE FCH10A10	
D212	8-719-074-58	DIODE FCH10A10	
D213	8-719-074-58	DIODE FCH10A10	
D214	8-719-210-39	DIODE EC10QS04-TE12L5	
D215	8-719-210-39	DIODE EC10QS04-TE12L5	
D216	8-719-074-58	DIODE FCH10A10	
D217	8-719-074-58	DIODE FCH10A10	
D219	8-719-074-58	DIODE FCH10A10	
D220	8-719-074-58	DIODE FCH10A10	
< GROUND TERMINAL >			
ET201	1-537-770-21	TERMINAL BOARD, GROUND	
ET202	1-537-770-21	TERMINAL BOARD, GROUND	
< IC >			
IC202	8-759-471-81	IC PQ05RD11	
IC203	8-759-290-43	IC AN7905F	
IC204	8-759-520-49	IC PQ30RV21	
IC205	8-759-471-81	IC PQ05RD11	
IC206	8-759-671-38	IC AN7910F	
< IC LINK >			
△ PS201	1-532-637-00	LINK, IC (1.0A)	
△ PS202	1-532-637-00	LINK, IC (1.0A)	
△ PS203	1-532-605-00	LINK, IC (0.4A) (AEP, UK)	
< TRANSISTOR >			
Q202	8-729-140-05	TRANSISTOR 2SB1116A-TP-K	
Q203	8-729-111-29	TRANSISTOR 2SD1616A-TP-K	
Q206	8-729-807-51	TRANSISTOR 2SC2873Y-TE12L (AEP, UK)	
Q207	8-729-424-08	TRANSISTOR UN2111-TX	
Q208	8-729-421-22	TRANSISTOR UN2211-TX	
< RESISTOR >			
R217	1-216-049-11	RES-CHIP 1K 5% 1/10W (AEP, UK)	
R218	1-208-792-11	METAL CHIP 2.7K 0.5% 1/10W	
R219	1-208-772-11	METAL CHIP 390 0.5% 1/10W	
R232	1-216-049-11	RES-CHIP 1K 5% 1/10W	
R233	1-216-049-11	RES-CHIP 1K 5% 1/10W	
R234	1-216-049-11	RES-CHIP 1K 5% 1/10W	
*****			
*	A-6065-572-A	SW-344 BOARD, COMPLETE	(Ref.No. 2,000 Series)
*****			
	3-884-171-00	STOPPER	
< CAPACITOR >			
△ C401	1-113-920-11	CERAMIC 0.0022uF 20% 250V	
< SWITCH >			
△ S401	1-786-000-11	SWITCH, POWER (POWER)	

Ref. No.	Part No.	Description	Remark
*	A-6065-566-A	TK-58 BOARD, COMPLETE	(Ref.No. 6,000 Series)
*****			
< CAPACITOR >			
C004	1-107-826-11	CERAMIC CHIP 0.1uF 10% 16V	
C005	1-162-966-11	CERAMIC CHIP 0.0022uF 10% 50V	
C006	1-124-779-00	ELECT CHIP 10uF 20% 16V	
C007	1-162-966-11	CERAMIC CHIP 0.0022uF 10% 50V	
C008	1-162-966-11	CERAMIC CHIP 0.0022uF 10% 50V	
C009	1-162-966-11	CERAMIC CHIP 0.0022uF 10% 50V	
C010	1-107-826-11	CERAMIC CHIP 0.1uF 10% 16V	
C012	1-124-779-00	ELECT CHIP 10uF 20% 16V	
C016	1-162-970-11	CERAMIC CHIP 0.01uF 10% 25V	
C017	1-164-172-11	CERAMIC CHIP 0.0056uF 10% 25V	
C018	1-164-739-11	CERAMIC CHIP 560PF 5% 50V	
C019	1-164-172-11	CERAMIC CHIP 0.0056uF 10% 25V	
C020	1-107-826-11	CERAMIC CHIP 0.1uF 10% 16V	
C021	1-107-826-11	CERAMIC CHIP 0.1uF 10% 16V	
C022	1-107-826-11	CERAMIC CHIP 0.1uF 10% 16V	
C023	1-165-176-11	CERAMIC CHIP 0.047uF 10% 16V	
C024	1-164-730-11	CERAMIC CHIP 0.0012uF 10% 50V	
C025	1-165-176-11	CERAMIC CHIP 0.047uF 10% 16V	
C026	1-162-964-11	CERAMIC CHIP 0.001uF 10% 50V	
C027	1-164-217-11	CERAMIC CHIP 150PF 5% 50V	
C028	1-162-970-11	CERAMIC CHIP 0.01uF 10% 25V	
C029	1-107-826-11	CERAMIC CHIP 0.1uF 10% 16V	
C030	1-107-826-11	CERAMIC CHIP 0.1uF 10% 16V	
C031	1-124-779-00	ELECT CHIP 10uF 20% 16V	
C032	1-107-826-11	CERAMIC CHIP 0.1uF 10% 16V	
C033	1-107-826-11	CERAMIC CHIP 0.1uF 10% 16V	
C034	1-107-826-11	CERAMIC CHIP 0.1uF 10% 16V	
C035	1-107-826-11	CERAMIC CHIP 0.1uF 10% 16V	
C036	1-165-176-11	CERAMIC CHIP 0.047uF 10% 16V	
C037	1-164-739-11	CERAMIC CHIP 560PF 5% 50V	
C038	1-107-826-11	CERAMIC CHIP 0.1uF 10% 16V	
C039	1-107-826-11	CERAMIC CHIP 0.1uF 10% 16V	
C040	1-162-969-11	CERAMIC CHIP 0.0068uF 10% 25V	
C041	1-162-966-11	CERAMIC CHIP 0.0022uF 10% 50V	
C120	1-107-826-11	CERAMIC CHIP 0.1uF 10% 16V	
C121	1-107-826-11	CERAMIC CHIP 0.1uF 10% 16V	
< CONNECTOR >			
CN001	1-785-700-21	CONNECTOR, FPC (ZIF) 23P	
CN002	1-566-529-11	CONNECTOR, FPC (ZIF) 13P	
CN003	1-794-507-21	CONNECTOR, FFC/FPC 21P	
CN004	1-794-507-21	CONNECTOR, FFC/FPC 21P	
< DIODE >			
D003	8-719-988-61	DIODE 1SS355TE-17	
< IC >			
IC001	8-759-567-24	IC SSI33P3722	
IC107	8-759-058-45	IC NJM3403AV (TE2)	
IC109	8-759-523-03	IC TC74HC4066AFT (EL)	

The components identified by mark △ or dotted line with mark △ are critical for safety. Replace only with part number specified.	Les composants identifiés par une marque △ sont critiques pour la sécurité. Ne les remplacer que par une pièce portant le numéro spécifié.
--	--



Ref. No.	Part No.	Description	Remark	Ref. No.	Part No.	Description	Remark
		< COIL >					
L001	1-412-031-11	INDUCTOR CHIP 47uH		C106	1-126-395-11	ELECT 22uF 20% 16V	
		< TRANSISTOR >		C107	1-126-205-11	ELECT CHIP 47uF 20% 6.3V	
Q001	8-729-820-86	TRANSISTOR 2SB1121-T-TD		C108	1-107-826-11	CERAMIC CHIP 0.1uF 10% 16V	
Q005	8-729-402-42	TRANSISTOR UN5213-TX		C109	1-126-205-11	ELECT CHIP 47uF 20% 6.3V	
		< RESISTOR >		C110	1-162-970-11	CERAMIC CHIP 0.01uF 10% 25V	
R001	1-216-815-11	METAL CHIP 330 5% 1/16W		C111	1-162-970-11	CERAMIC CHIP 0.01uF 10% 25V	
R002	1-216-809-11	METAL CHIP 100 5% 1/16W		C112	1-126-205-11	ELECT CHIP 47uF 20% 6.3V	
R003	1-216-809-11	METAL CHIP 100 5% 1/16W		C113	1-162-970-11	CERAMIC CHIP 0.01uF 10% 25V	
R004	1-216-837-11	METAL CHIP 22K 5% 1/16W		C114	1-162-970-11	CERAMIC CHIP 0.01uF 10% 25V	
R005	1-216-013-00	METAL CHIP 33 5% 1/10W		C115	1-162-927-11	CERAMIC CHIP 100PF 5% 50V	
R006	1-216-013-00	METAL CHIP 33 5% 1/10W		C116	1-162-970-11	CERAMIC CHIP 0.01uF 10% 25V	
R007	1-216-841-11	METAL CHIP 47K 5% 1/16W		C117	1-162-970-11	CERAMIC CHIP 0.01uF 10% 25V	
R008	1-216-797-11	METAL CHIP 10 5% 1/16W		C118	1-126-205-11	ELECT CHIP 47uF 20% 6.3V	
R009	1-216-834-11	METAL CHIP 12K 5% 1/16W		C119	1-162-970-11	CERAMIC CHIP 0.01uF 10% 25V	
R011	1-216-864-11	METAL CHIP 0 5% 1/16W		C120	1-117-863-11	CERAMIC CHIP 0.47uF 10% 6.3V	
R015	1-216-833-11	METAL CHIP 10K 5% 1/16W		C121	1-107-826-11	CERAMIC CHIP 0.1uF 10% 16V	
R016	1-216-833-11	METAL CHIP 10K 5% 1/16W		C122	1-126-205-11	ELECT CHIP 47uF 20% 6.3V	
R017	1-216-829-11	METAL CHIP 4.7K 5% 1/16W		C123	1-162-970-11	CERAMIC CHIP 0.01uF 10% 25V	
R018	1-216-833-11	METAL CHIP 10K 5% 1/16W		C124	1-127-956-21	FILM CHIP 0.1uF 5% 16V	
R022	1-216-811-11	METAL CHIP 150 5% 1/16W		C125	1-127-947-21	FILM CHIP 0.0033uF 5% 16V	
R023	1-216-820-11	METAL CHIP 820 5% 1/16W		C126	1-164-230-11	CERAMIC CHIP 220PF 5% 50V	
R025	1-216-813-11	METAL CHIP 220 5% 1/16W		C127	1-162-970-11	CERAMIC CHIP 0.01uF 10% 25V	
R029	1-216-861-11	METAL CHIP 2.2M 5% 1/16W		C128	1-162-964-11	CERAMIC CHIP 0.001uF 10% 50V	
R115	1-216-845-11	METAL CHIP 100K 5% 1/16W		C129	1-162-970-11	CERAMIC CHIP 0.01uF 10% 25V	
R116	1-216-833-11	METAL CHIP 10K 5% 1/16W		C130	1-162-970-11	CERAMIC CHIP 0.01uF 10% 25V	
R117	1-216-833-11	METAL CHIP 10K 5% 1/16W		C131	1-162-970-11	CERAMIC CHIP 0.01uF 10% 25V	
R131	1-216-833-11	METAL CHIP 10K 5% 1/16W		C133	1-162-970-11	CERAMIC CHIP 0.01uF 10% 25V	
R144	1-216-864-11	METAL CHIP 0 5% 1/16W		C134	1-162-970-11	CERAMIC CHIP 0.01uF 10% 25V	
R145	1-216-864-11	METAL CHIP 0 5% 1/16W		C136	1-126-206-11	ELECT CHIP 100uF 20% 6.3V	
R152	1-216-864-11	METAL CHIP 0 5% 1/16W		C138	1-162-970-11	CERAMIC CHIP 0.01uF 10% 25V	
R153	1-216-864-11	METAL CHIP 0 5% 1/16W		C140	1-127-956-21	FILM CHIP 0.1uF 5% 16V	
R156	1-216-851-11	METAL CHIP 330K 5% 1/16W		C141	1-107-826-11	CERAMIC CHIP 0.1uF 10% 16V	
R157	1-216-851-11	METAL CHIP 330K 5% 1/16W		C142	1-162-970-11	CERAMIC CHIP 0.01uF 10% 25V	
R158	1-216-833-11	METAL CHIP 10K 5% 1/16W		C143	1-126-205-11	ELECT CHIP 47uF 20% 6.3V	
R159	1-216-833-11	METAL CHIP 10K 5% 1/16W		C144	1-162-970-11	CERAMIC CHIP 0.01uF 10% 25V	
R160	1-216-837-11	METAL CHIP 22K 5% 1/16W		C145	1-162-970-11	CERAMIC CHIP 0.01uF 10% 25V	
R161	1-216-837-11	METAL CHIP 22K 5% 1/16W		C146	1-135-594-21	ELECT 68uF 20% 6.3V	
R162	1-216-833-11	METAL CHIP 10K 5% 1/16W		C147	1-107-826-11	CERAMIC CHIP 0.1uF 10% 16V	
R163	1-216-833-11	METAL CHIP 10K 5% 1/16W		C148	1-126-395-11	ELECT 22uF 20% 16V	
R164	1-216-851-11	METAL CHIP 330K 5% 1/16W		C149	1-162-970-11	CERAMIC CHIP 0.01uF 10% 25V	
R165	1-216-851-11	METAL CHIP 330K 5% 1/16W		C150	1-162-970-11	CERAMIC CHIP 0.01uF 10% 25V	
R168	1-216-837-11	METAL CHIP 22K 5% 1/16W		C151	1-162-970-11	CERAMIC CHIP 0.01uF 10% 25V	
R169	1-216-837-11	METAL CHIP 22K 5% 1/16W		C152	1-162-970-11	CERAMIC CHIP 0.01uF 10% 25V	
R171	1-216-833-11	METAL CHIP 10K 5% 1/16W		C153	1-162-970-11	CERAMIC CHIP 0.01uF 10% 25V	
R178	1-216-864-11	METAL CHIP 0 5% 1/16W		C154	1-162-970-11	CERAMIC CHIP 0.01uF 10% 25V	
* A-6065-581-A	VP-52 BOARD, COMPLETE (AEP, UK)			C155	1-162-970-11	CERAMIC CHIP 0.01uF 10% 25V	
* A-6065-594-A	VP-52 BOARD, COMPLETE (EXCEPT AEP, UK)			C156	1-162-970-11	CERAMIC CHIP 0.01uF 10% 25V	
	*****			C157	1-162-970-11	CERAMIC CHIP 0.01uF 10% 25V	
	(Ref.No. 5,000 Series)			C158	1-162-970-11	CERAMIC CHIP 0.01uF 10% 25V	
		< CAPACITOR >		C159	1-162-970-11	CERAMIC CHIP 0.01uF 10% 25V	
C101	1-126-205-11	ELECT CHIP 47uF 20% 6.3V		C160	1-162-970-11	CERAMIC CHIP 0.01uF 10% 25V	
C102	1-126-205-11	ELECT CHIP 47uF 20% 6.3V		C161	1-126-205-11	ELECT CHIP 47uF 20% 6.3V	
C103	1-126-205-11	ELECT CHIP 47uF 20% 6.3V		C162	1-126-205-11	ELECT CHIP 47uF 20% 6.3V	
C104	1-162-970-11	CERAMIC CHIP 0.01uF 10% 25V		C163	1-126-205-11	ELECT CHIP 47uF 20% 6.3V	
C105	1-107-826-11	CERAMIC CHIP 0.1uF 10% 16V		C164	1-107-826-11	CERAMIC CHIP 0.1uF 10% 16V	
C301	1-135-594-21	ELECT 68uF 20% 6.3V					
C302	1-162-970-11	CERAMIC CHIP 0.01uF 10% 25V					
C303	1-162-970-11	CERAMIC CHIP 0.01uF 10% 25V					
C304	1-162-970-11	CERAMIC CHIP 0.01uF 10% 25V					
C305	1-135-594-21	ELECT 68uF 20% 6.3V					

Ref. No.	Part No.	Description	Remark	Ref. No.	Part No.	Description	Remark
C306	1-162-970-11	CERAMIC CHIP	0.01uF 10% 25V	C433	1-126-205-11	ELECT CHIP	47uF 20% 6.3V
C307	1-162-970-11	CERAMIC CHIP	0.01uF 10% 25V	C434	1-126-205-11	ELECT CHIP	47uF 20% 6.3V
C308	1-162-970-11	CERAMIC CHIP	0.01uF 10% 25V	C435	1-135-594-21	ELECT	68uF 20% 6.3V
C309	1-162-970-11	CERAMIC CHIP	0.01uF 10% 25V	C436	1-135-594-21	ELECT	68uF 20% 6.3V
C310	1-162-970-11	CERAMIC CHIP	0.01uF 10% 25V	C437	1-127-956-21	FILM CHIP	0.1uF 5% 16V
C311	1-162-970-11	CERAMIC CHIP	0.01uF 10% 25V	C438	1-107-826-11	CERAMIC CHIP	0.1uF 10% 16V (EXCEPT AEP, UK)
C313	1-162-921-11	CERAMIC CHIP	33PF 5% 50V	C439	1-127-956-21	FILM CHIP	0.1uF 5% 16V
C314	1-162-921-11	CERAMIC CHIP	33PF 5% 50V	C440	1-162-970-11	CERAMIC CHIP	0.01uF 10% 25V
C315	1-162-970-11	CERAMIC CHIP	0.01uF 10% 25V	C441	1-162-970-11	CERAMIC CHIP	0.01uF 10% 25V
C316	1-162-970-11	CERAMIC CHIP	0.01uF 10% 25V	C442	1-162-970-11	CERAMIC CHIP	0.01uF 10% 25V
C317	1-162-970-11	CERAMIC CHIP	0.01uF 10% 25V	C443	1-162-970-11	CERAMIC CHIP	0.01uF 10% 25V
C318	1-162-970-11	CERAMIC CHIP	0.01uF 10% 25V	C444	1-162-970-11	CERAMIC CHIP	0.01uF 10% 25V
C319	1-162-970-11	CERAMIC CHIP	0.01uF 10% 25V	C445	1-162-970-11	CERAMIC CHIP	0.01uF 10% 25V
C320	1-162-970-11	CERAMIC CHIP	0.01uF 10% 25V	C452	1-162-907-11	CERAMIC CHIP	2PF 0.25PF 50V
C321	1-162-970-11	CERAMIC CHIP	0.01uF 10% 25V	C453	1-162-907-11	CERAMIC CHIP	2PF 0.25PF 50V
C322	1-162-970-11	CERAMIC CHIP	0.01uF 10% 25V	C454	1-162-907-11	CERAMIC CHIP	2PF 0.25PF 50V
C323	1-162-970-11	CERAMIC CHIP	0.01uF 10% 25V			< CONNECTOR >	
C324	1-162-970-11	CERAMIC CHIP	0.01uF 10% 25V	CN101	1-784-327-11	CONNECTOR, FFC/FPC 28P	
C325	1-135-594-21	ELECT	68uF 20% 6.3V	CN102	1-779-993-11	PIN, CONNECTOR (PWB) 5P	
C326	1-162-970-11	CERAMIC CHIP	0.01uF 10% 25V	* CN103	1-695-320-21	PIN, CONNECTOR (1.5mm) (SMD) 2P	
C327	1-162-970-11	CERAMIC CHIP	0.01uF 10% 25V	CN401	1-774-287-11	CONNECTOR, FFC/FPC 22P (AEP, UK)	
C328	1-162-970-11	CERAMIC CHIP	0.01uF 10% 25V			< TRIMMER >	
C329	1-162-970-11	CERAMIC CHIP	0.01uF 10% 25V	CT101	1-141-423-61	CAP, ADJ 20PF (27MHz ADJ)	
C330	1-162-970-11	CERAMIC CHIP	0.01uF 10% 25V			< DIODE >	
C331	1-162-970-11	CERAMIC CHIP	0.01uF 10% 25V	D101	8-719-988-61	DIODE 1SS355TE-17	
C332	1-162-970-11	CERAMIC CHIP	0.01uF 10% 25V	D102	8-719-081-39	DIODE MA2S30400LSO	
C333	1-162-970-11	CERAMIC CHIP	0.01uF 10% 25V	D401	8-719-988-61	DIODE 1SS355TE-17	
C334	1-162-970-11	CERAMIC CHIP	0.01uF 10% 25V	D402	8-719-988-61	DIODE 1SS355TE-17	
C335	1-162-970-11	CERAMIC CHIP	0.01uF 10% 25V	D403	8-719-071-15	DIODE HZM6.8ZWA1TL (EXCEPT AEP, UK)	
C401	1-162-970-11	CERAMIC CHIP	0.01uF 10% 25V	D404	8-719-071-15	DIODE HZM6.8ZWA1TL	
C402	1-162-970-11	CERAMIC CHIP	0.01uF 10% 25V	D405	8-719-071-15	DIODE HZM6.8ZWA1TL (EXCEPT AEP, UK)	
C403	1-135-594-21	ELECT	68uF 20% 6.3V	D406	8-719-071-15	DIODE HZM6.8ZWA1TL	
C404	1-126-395-11	ELECT	22uF 20% 16V			< FILTER >	
C405	1-162-970-11	CERAMIC CHIP	0.01uF 10% 25V	FL101	1-233-893-21	FILTER, CHIP EMI	
C406	1-107-826-11	CERAMIC CHIP	0.1uF 10% 16V	FL102	1-233-893-21	FILTER, CHIP EMI	
C407	1-162-970-11	CERAMIC CHIP	0.01uF 10% 25V	FL103	1-233-893-21	FILTER, CHIP EMI	
C408	1-162-970-11	CERAMIC CHIP	0.01uF 10% 25V	FL104	1-233-893-21	FILTER, CHIP EMI	
C409	1-127-956-21	FILM CHIP	0.1uF 5% 16V	FL105	1-233-893-21	FILTER, CHIP EMI	
C410	1-162-970-11	CERAMIC CHIP	0.01uF 10% 25V	FL106	1-234-177-21	FILTER, CHIP EMI	
C412	1-162-970-11	CERAMIC CHIP	0.01uF 10% 25V	FL107	1-234-177-21	FILTER, CHIP EMI	
C413	1-162-970-11	CERAMIC CHIP	0.01uF 10% 25V	FL108	1-234-177-21	FILTER, CHIP EMI	
C414	1-126-395-11	ELECT	22uF 20% 16V	FL110	1-234-604-21	FILTER, LOW PASS	
C415	1-126-395-11	ELECT	22uF 20% 16V	FL111	1-234-604-21	FILTER, LOW PASS	
C416	1-127-956-21	FILM CHIP	0.1uF 5% 16V	FL112	1-234-604-21	FILTER, LOW PASS	
C417	1-107-826-11	CERAMIC CHIP	0.1uF 10% 16V	FL113	1-234-604-21	FILTER, LOW PASS	
C418	1-162-970-11	CERAMIC CHIP	0.01uF 10% 25V	FL114	1-234-604-21	FILTER, LOW PASS	
C419	1-107-826-11	CERAMIC CHIP	0.1uF 10% 16V	FL115	1-234-604-21	FILTER, LOW PASS	
C420	1-162-970-11	CERAMIC CHIP	0.01uF 10% 25V	FL301	1-234-177-21	FILTER, CHIP EMI	
C421	1-107-826-11	CERAMIC CHIP	0.1uF 10% 16V	FL302	1-234-177-21	FILTER, CHIP EMI	
C422	1-162-970-11	CERAMIC CHIP	0.01uF 10% 25V	FL303	1-234-177-21	FILTER, CHIP EMI	
C423	1-126-205-11	ELECT CHIP	47uF 20% 6.3V	FL402	1-234-113-21	FILTER, LOW PASS	
C424	1-126-205-11	ELECT CHIP	47uF 20% 6.3V	FL403	1-234-113-21	FILTER, LOW PASS	
C425	1-162-970-11	CERAMIC CHIP	0.01uF 10% 25V	FL404	1-234-113-21	FILTER, LOW PASS	
C426	1-126-205-11	ELECT CHIP	47uF 20% 6.3V	FL405	1-234-177-21	FILTER, CHIP EMI (AEP, UK)	
C427	1-135-594-21	ELECT	68uF 20% 6.3V				
C428	1-127-956-21	FILM CHIP	0.1uF 5% 16V				
C429	1-127-956-21	FILM CHIP	0.1uF 5% 16V				
C430	1-127-956-21	FILM CHIP	0.1uF 5% 16V				
C431	1-162-970-11	CERAMIC CHIP	0.01uF 10% 25V				
C432	1-126-205-11	ELECT CHIP	47uF 20% 6.3V				

Ref. No.	Part No.	Description	Remark	Ref. No.	Part No.	Description	Remark
FL406	1-234-177-21	FILTER, CHIP EMI (AEP, UK)		Q110	8-729-216-22	TRANSISTOR	2SA1162-YG-TE85L
FL407	1-234-177-21	FILTER, CHIP EMI (AEP, UK)		Q111	8-729-216-22	TRANSISTOR	2SA1162-YG-TE85L
		< IC >		Q112	8-729-216-22	TRANSISTOR	2SA1162-YG-TE85L
IC101	8-759-460-72	IC BA033FP-E2		Q113	8-729-216-22	TRANSISTOR	2SA1162-YG-TE85L
IC102	8-759-693-34	IC PQ1R50		Q114	8-729-216-22	TRANSISTOR	2SA1162-YG-TE85L
IC103	8-759-694-20	IC CXD9602R		Q115	8-729-216-22	TRANSISTOR	2SA1162-YG-TE85L
IC104	8-759-497-44	IC TC7WH125FU (TE12R)		Q116	8-729-230-49	TRANSISTOR	2SC2712-YG-TE85L
IC105	8-759-712-27	IC NJM082BV (TE2)		Q117	8-729-230-49	TRANSISTOR	2SC2712-YG-TE85L
IC106	8-759-684-19	IC ADV7190KST		Q118	8-729-230-49	TRANSISTOR	2SC2712-YG-TE85L
IC107	8-759-271-88	IC TC7SHU04FU-TE85R		Q119	8-729-230-49	TRANSISTOR	2SC2712-YG-TE85L
IC108	8-759-531-92	IC TC7WH04FU (TE12R)		Q120	8-729-230-49	TRANSISTOR	2SC2712-YG-TE85L
IC109	8-759-693-34	IC PQ1R50					(AEP, UK)
IC110	8-759-486-55	IC NJM2370U33-TE2					(AEP, UK)
IC301	8-759-082-61	IC TC4W53FU (TE12R)		Q121	8-729-230-49	TRANSISTOR	2SC2712-YG-TE85L
IC302	8-759-684-28	IC GMAFMC					(AEP, UK)
IC303	8-759-684-27	IC GMVLX1A-X		Q301	8-729-421-19	TRANSISTOR	UN2213-TX
IC304	8-759-684-13	IC K4G163222A-PC80		Q401	8-729-230-49	TRANSISTOR	2SC2712-YG-TE85L
IC401	8-759-693-35	IC ADV7196		Q402	8-729-230-49	TRANSISTOR	2SC2712-YG-TE85L
IC402	8-759-693-34	IC PQ1R50		Q403	8-729-230-49	TRANSISTOR	2SC2712-YG-TE85L
IC403	8-759-684-20	IC LA7104M-TLM		Q404	8-729-216-22	TRANSISTOR	2SA1162-YG-TE85L
IC404	8-759-684-23	IC AD8058ARM-REEL		Q405	8-729-216-22	TRANSISTOR	2SA1162-YG-TE85L
IC405	8-759-684-23	IC AD8058ARM-REEL		Q406	8-729-216-22	TRANSISTOR	2SA1162-YG-TE85L
IC406	8-759-684-23	IC AD8058ARM-REEL		Q407	8-729-421-19	TRANSISTOR	UN2213-TX
		< JACK >		Q408	8-729-424-08	TRANSISTOR	UN2111-TX
J401	1-793-475-11	JACK, PIN 2P (VIDEO OUT) (EXCEPT AEP, UK)		Q409	8-729-421-19	TRANSISTOR	UN2213-TX
J402	1-694-484-11	TERMINAL, S (2P.V) (S VIDEO OUT)		Q410	8-729-424-08	TRANSISTOR	UN2111-TX
		(EXCEPT AEP, UK)		Q411	8-729-424-08	TRANSISTOR	UN2111-TX
J402	1-794-198-21	CONNECTOR, S TERMINAL (S VIDEO OUT)		Q412	8-729-424-08	TRANSISTOR	UN2111-TX
		(AEP, UK)		Q413	8-729-424-08	TRANSISTOR	UN2111-TX
J403	1-794-731-11	JACK, PIN 1P (COMPONENT VIDEO OUT Y)		Q414	8-729-422-27	TRANSISTOR	2SD601A-QRS-TX
J404	1-794-732-11	JACK, PIN 1P		Q415	8-729-421-19	TRANSISTOR	UN2213-TX (AEP, UK)
		(COMPONENT VIDEO OUT PB/CB)		Q416	8-729-424-08	TRANSISTOR	UN2111-TX (AEP, UK)
J405	1-794-733-11	JACK, PIN 1P		Q417	8-729-424-08	TRANSISTOR	UN2111-TX
		(COMPONENT VIDEO OUT PR/CR)		Q418	8-729-141-73	TRANSISTOR	2SD1938 (F)-S (TX).SO
J406	1-785-867-21	JACK, PIN 1P (VIDEO OUT) (AEP, UK)		Q419	8-729-141-73	TRANSISTOR	2SD1938 (F)-S (TX).SO
		< COIL >		Q420	8-729-141-73	TRANSISTOR	2SD1938 (F)-S (TX).SO
L101	1-412-064-11	INDUCTOR	100uH			< RESISTOR >	
L102	1-412-064-11	INDUCTOR	100uH	R101	1-216-841-11	METAL CHIP	47K 5% 1/16W
L103	1-412-064-11	INDUCTOR	100uH	R102	1-216-821-11	METAL CHIP	1K 5% 1/16W
L106	1-412-064-11	INDUCTOR	100uH	R103	1-216-821-11	METAL CHIP	1K 5% 1/16W
L107	1-412-064-11	INDUCTOR	100uH	R104	1-216-801-11	METAL CHIP	22 5% 1/16W
L402	1-412-064-11	INDUCTOR	100uH	R105	1-216-817-11	METAL CHIP	470 5% 1/16W
L403	1-412-064-11	INDUCTOR	100uH	R106	1-216-817-11	METAL CHIP	470 5% 1/16W
L404	1-412-064-11	INDUCTOR	100uH	R107	1-216-805-11	METAL CHIP	47 5% 1/16W
L405	1-412-064-11	INDUCTOR	100uH	R108	1-216-821-11	METAL CHIP	1K 5% 1/16W
L406	1-412-064-11	INDUCTOR	100uH	R109	1-216-828-11	METAL CHIP	3.9K 5% 1/16W
L407	1-412-064-11	INDUCTOR	100uH	R110	1-216-828-11	METAL CHIP	3.9K 5% 1/16W
		< TRANSISTOR >		R111	1-216-841-11	METAL CHIP	47K 5% 1/16W
Q101	8-729-424-08	TRANSISTOR	UN2111-TX	R112	1-216-841-11	METAL CHIP	47K 5% 1/16W
Q102	8-729-421-19	TRANSISTOR	UN2213-TX	R113	1-216-841-11	METAL CHIP	47K 5% 1/16W
Q103	8-729-421-19	TRANSISTOR	UN2213-TX	R114	1-216-821-11	METAL CHIP	1K 5% 1/16W
Q104	8-729-230-49	TRANSISTOR	2SC2712-YG-TE85L	R115	1-216-841-11	METAL CHIP	47K 5% 1/16W
Q105	8-729-230-49	TRANSISTOR	2SC2712-YG-TE85L	R116	1-216-831-11	METAL CHIP	6.8K 5% 1/16W
Q106	8-729-230-49	TRANSISTOR	2SC2712-YG-TE85L	R117	1-216-841-11	METAL CHIP	47K 5% 1/16W
Q107	8-729-230-49	TRANSISTOR	2SC2712-YG-TE85L	R118	1-216-821-11	METAL CHIP	1K 5% 1/16W
Q108	8-729-230-49	TRANSISTOR	2SC2712-YG-TE85L	R119	1-216-845-11	METAL CHIP	100K 5% 1/16W
Q109	8-729-230-49	TRANSISTOR	2SC2712-YG-TE85L	R120	1-216-833-11	METAL CHIP	10K 5% 1/16W
				R121	1-216-815-11	METAL CHIP	330 5% 1/16W

Ref. No.	Part No.	Description			Remark
R122	1-216-833-11	METAL CHIP	10K	5%	1/16W
R123	1-216-833-11	METAL CHIP	10K	5%	1/16W
R125	1-216-833-11	METAL CHIP	10K	5%	1/16W
R126	1-216-857-11	METAL CHIP	1M	5%	1/16W
R127	1-211-983-11	RES-CHIP	39	0.5%	1/16W
R128	1-211-983-11	RES-CHIP	39	0.5%	1/16W
R129	1-216-818-11	METAL CHIP	560	5%	1/16W
R131	1-216-805-11	METAL CHIP	47	5%	1/16W
R132	1-216-809-11	METAL CHIP	100	5%	1/16W
R133	1-211-983-11	RES-CHIP	39	0.5%	1/16W
R134	1-211-983-11	RES-CHIP	39	0.5%	1/16W
R135	1-216-809-11	METAL CHIP	100	5%	1/16W
R136	1-216-805-11	METAL CHIP	47	5%	1/16W
R137	1-211-983-11	RES-CHIP	39	0.5%	1/16W
R138	1-211-983-11	RES-CHIP	39	0.5%	1/16W
R139	1-216-829-11	METAL CHIP	4.7K	5%	1/16W
R140	1-216-829-11	METAL CHIP	4.7K	5%	1/16W
R141	1-218-835-11	METAL CHIP	330	0.5%	1/16W
R142	1-218-835-11	METAL CHIP	330	0.5%	1/16W
R143	1-218-835-11	METAL CHIP	330	0.5%	1/16W
R144	1-218-835-11	METAL CHIP	330	0.5%	1/16W
R145	1-218-835-11	METAL CHIP	330	0.5%	1/16W
R146	1-218-835-11	METAL CHIP	330	0.5%	1/16W
R148	1-216-821-11	METAL CHIP	1K	5%	1/16W
R149	1-216-821-11	METAL CHIP	1K	5%	1/16W
R151	1-216-797-11	METAL CHIP	10	5%	1/16W
R153	1-216-797-11	METAL CHIP	10	5%	1/16W
R154	1-216-797-11	METAL CHIP	10	5%	1/16W
R155	1-216-797-11	METAL CHIP	10	5%	1/16W
R156	1-216-801-11	METAL CHIP	22	5%	1/16W
R157	1-216-801-11	METAL CHIP	22	5%	1/16W
R158	1-216-801-11	METAL CHIP	22	5%	1/16W
R159	1-216-801-11	METAL CHIP	22	5%	1/16W
R160	1-216-801-11	METAL CHIP	22	5%	1/16W
R161	1-216-801-11	METAL CHIP	22	5%	1/16W
R162	1-216-821-11	METAL CHIP	1K	5%	1/16W
R163	1-216-821-11	METAL CHIP	1K	5%	1/16W
R164	1-216-821-11	METAL CHIP	1K	5%	1/16W
R165	1-216-821-11	METAL CHIP	1K	5%	1/16W
R166	1-216-821-11	METAL CHIP	1K	5%	1/16W
R167	1-216-821-11	METAL CHIP	1K	5%	1/16W
R168	1-218-829-11	METAL CHIP	180	0.5%	1/16W
R169	1-218-829-11	METAL CHIP	180	0.5%	1/16W
R170	1-218-829-11	METAL CHIP	180	0.5%	1/16W
R171	1-218-829-11	METAL CHIP	180	0.5%	1/16W
R172	1-218-829-11	METAL CHIP	180	0.5%	1/16W
R173	1-218-829-11	METAL CHIP	180	0.5%	1/16W
R180	1-218-855-11	METAL CHIP	2.2K	0.5%	1/16W
R181	1-218-855-11	METAL CHIP	2.2K	0.5%	1/16W
R182	1-218-855-11	METAL CHIP	2.2K	0.5%	1/16W
R183	1-218-855-11	METAL CHIP	2.2K	0.5%	1/16W
R184	1-218-855-11	METAL CHIP	2.2K	0.5%	1/16W
R185	1-218-855-11	METAL CHIP	2.2K	0.5%	1/16W
R186	1-216-821-11	METAL CHIP	1K	5%	1/16W
R187	1-216-821-11	METAL CHIP	1K	5%	1/16W
R188	1-216-821-11	METAL CHIP	1K	5%	1/16W
R189	1-216-821-11	METAL CHIP	1K	5%	1/16W
R190	1-216-821-11	METAL CHIP	1K	5%	1/16W
R191	1-216-821-11	METAL CHIP	1K	5%	1/16W
R192	1-216-801-11	METAL CHIP	22	5%	1/16W

Ref. No.	Part No.	Description			Remark
R193	1-216-801-11	METAL CHIP	22	5%	1/16W (AEP, UK)
R194	1-216-801-11	METAL CHIP	22	5%	1/16W
R195	1-216-801-11	METAL CHIP	22	5%	1/16W (AEP, UK)
R196	1-216-801-11	METAL CHIP	22	5%	1/16W
R197	1-216-801-11	METAL CHIP	22	5%	1/16W (AEP, UK)
R198	1-216-825-11	METAL CHIP	2.2K	5%	1/16W
R199	1-216-825-11	METAL CHIP	2.2K	5%	1/16W
R200	1-216-825-11	METAL CHIP	2.2K	5%	1/16W
R201	1-216-825-11	METAL CHIP	2.2K	5%	1/16W (AEP, UK)
R202	1-216-825-11	METAL CHIP	2.2K	5%	1/16W (AEP, UK)
R203	1-216-825-11	METAL CHIP	2.2K	5%	1/16W (AEP, UK)
R304	1-216-833-11	METAL CHIP	10K	5%	1/16W
R305	1-216-845-11	METAL CHIP	100K	5%	1/16W
R311	1-216-833-11	METAL CHIP	10K	5%	1/16W
R312	1-216-833-11	METAL CHIP	10K	5%	1/16W
R313	1-216-833-11	METAL CHIP	10K	5%	1/16W
R314	1-216-833-11	METAL CHIP	10K	5%	1/16W
R315	1-216-805-11	METAL CHIP	47	5%	1/16W
R316	1-216-833-11	METAL CHIP	10K	5%	1/16W
R318	1-216-833-11	METAL CHIP	10K	5%	1/16W
R320	1-216-833-11	METAL CHIP	10K	5%	1/16W
R322	1-216-833-11	METAL CHIP	10K	5%	1/16W
R324	1-216-864-11	METAL CHIP	0	5%	1/16W
R326	1-216-833-11	METAL CHIP	10K	5%	1/16W
R330	1-216-833-11	METAL CHIP	10K	5%	1/16W
R332	1-216-833-11	METAL CHIP	10K	5%	1/16W
R334	1-216-864-11	METAL CHIP	0	5%	1/16W
R335	1-216-801-11	METAL CHIP	22	5%	1/16W
R336	1-216-833-11	METAL CHIP	10K	5%	1/16W
R338	1-216-801-11	METAL CHIP	22	5%	1/16W
R339	1-216-833-11	METAL CHIP	10K	5%	1/16W
R347	1-216-833-11	METAL CHIP	10K	5%	1/16W
R348	1-216-833-11	METAL CHIP	10K	5%	1/16W
R350	1-216-833-11	METAL CHIP	10K	5%	1/16W
R351	1-216-833-11	METAL CHIP	10K	5%	1/16W
R353	1-216-833-11	METAL CHIP	10K	5%	1/16W
R355	1-216-833-11	METAL CHIP	10K	5%	1/16W
R356	1-216-833-11	METAL CHIP	10K	5%	1/16W
R357	1-216-833-11	METAL CHIP	10K	5%	1/16W
R362	1-216-805-11	METAL CHIP	47	5%	1/16W
R363	1-216-805-11	METAL CHIP	47	5%	1/16W
R364	1-216-801-11	METAL CHIP	22	5%	1/16W
R402	1-216-805-11	METAL CHIP	47	5%	1/16W
R404	1-216-809-11	METAL CHIP	100	5%	1/16W
R405	1-216-809-11	METAL CHIP	100	5%	1/16W
R406	1-216-825-11	METAL CHIP	2.2K	5%	1/16W
R407	1-218-835-11	METAL CHIP	330	0.5%	1/16W
R408	1-218-835-11	METAL CHIP	330	0.5%	1/16W
R409	1-218-835-11	METAL CHIP	330	0.5%	1/16W
R410	1-216-801-11	METAL CHIP	22	5%	1/16W
R411	1-216-801-11	METAL CHIP	22	5%	1/16W
R412	1-216-801-11	METAL CHIP	22	5%	1/16W
R413	1-216-821-11	METAL CHIP	1K	5%	1/16W
R414	1-216-821-11	METAL CHIP	1K	5%	1/16W
R415	1-216-821-11	METAL CHIP	1K	5%	1/16W

Ref. No.	Part No.	Description	Quantity	Power	Remark	Ref. No.	Part No.	Description	Quantity	Power	Remark
R416	1-218-829-11	METAL CHIP	180	0.5%	1/16W	R468	1-218-855-11	METAL CHIP	2.2K	0.5%	1/16W
R417	1-218-829-11	METAL CHIP	180	0.5%	1/16W						(EXCEPT AEP, UK)
R418	1-218-829-11	METAL CHIP	180	0.5%	1/16W	R468	1-218-856-11	RES-CHIP	2.4K	0.5%	1/16W
R419	1-211-983-11	RES-CHIP	39	0.5%	1/16W						(AEP, UK)
R420	1-211-983-11	RES-CHIP	39	0.5%	1/16W	R469	1-218-855-11	METAL CHIP	2.2K	0.5%	1/16W
R421	1-211-983-11	RES-CHIP	39	0.5%	1/16W	R470	1-216-864-11	METAL CHIP	0	5%	1/16W
R422	1-218-855-11	METAL CHIP	2.2K	0.5%	1/16W	R472	1-216-864-11	METAL CHIP	0	5%	1/16W
R423	1-218-855-11	METAL CHIP	2.2K	0.5%	1/16W	R474	1-216-864-11	METAL CHIP	0	5%	1/16W
R424	1-218-855-11	METAL CHIP	2.2K	0.5%	1/16W						
R425	1-216-821-11	METAL CHIP	1K	5%	1/16W	R482	1-243-862-91	METAL CHIP	75	0.5%	1/8W
R426	1-216-821-11	METAL CHIP	1K	5%	1/16W						(EXCEPT AEP, UK)
R427	1-216-821-11	METAL CHIP	1K	5%	1/16W	R483	1-243-862-91	METAL CHIP	75	0.5%	1/8W
R429	1-216-841-11	METAL CHIP	47K	5%	1/16W	R484	1-243-862-91	METAL CHIP	75	0.5%	1/8W
R431	1-216-841-11	METAL CHIP	47K	5%	1/16W	R485	1-243-862-91	METAL CHIP	75	0.5%	1/8W
											(EXCEPT AEP, UK)
R433	1-216-841-11	METAL CHIP	47K	5%	1/16W	R486	1-243-862-91	METAL CHIP	75	0.5%	1/8W
R434	1-216-821-11	METAL CHIP	1K	5%	1/16W	R488	1-243-862-91	METAL CHIP	75	0.5%	1/8W
R435	1-216-821-11	METAL CHIP	1K	5%	1/16W	R490	1-243-862-91	METAL CHIP	75	0.5%	1/8W
R436	1-216-833-11	METAL CHIP	10K	5%	1/16W	R492	1-216-822-11	METAL CHIP	1.2K	5%	1/16W
R437	1-216-833-11	METAL CHIP	10K	5%	1/16W	R493	1-469-117-21	FERRITE	0uH	(EXCEPT AEP, UK)	
						R494	1-469-117-21	FERRITE	0uH		
R438	1-216-833-11	METAL CHIP	10K	5%	1/16W	R495	1-469-117-21	FERRITE	0uH	(EXCEPT AEP, UK)	
R439	1-216-833-11	METAL CHIP	10K	5%	1/16W	R496	1-469-117-21	FERRITE	0uH		
R440	1-216-829-11	METAL CHIP	4.7K	5%	1/16W	R497	1-469-117-21	FERRITE	0uH		
R441	1-216-833-11	METAL CHIP	10K	5%	1/16W	R498	1-469-117-21	FERRITE	0uH	(EXCEPT AEP, UK)	
					(EXCEPT AEP, UK)	R499	1-216-821-11	METAL CHIP	1K	5%	1/16W
R442	1-216-833-11	METAL CHIP	10K	5%	1/16W						
R443	1-216-837-11	METAL CHIP	22K	5%	1/16W	R505	1-216-821-11	METAL CHIP	1K	5%	1/16W
R444	1-216-821-11	METAL CHIP	1K	5%	1/16W	R506	1-216-864-11	METAL CHIP	0	5%	1/16W
					(AEP, UK)	R507	1-216-864-11	METAL CHIP	0	5%	1/16W
R445	1-216-821-11	METAL CHIP	1K	5%	1/16W	R508	1-216-864-11	METAL CHIP	0	5%	1/16W
R446	1-216-841-11	METAL CHIP	47K	5%	1/16W						< VARIABLE RESISTOR >
R447	1-216-807-11	METAL CHIP	68	5%	1/16W						
R448	1-216-833-11	METAL CHIP	10K	5%	1/16W	RV101	1-223-582-11	RES, ADJ, CARBON 470 (N LEVEL ADJ)			
R449	1-216-833-11	METAL CHIP	10K	5%	1/16W	RV102	1-223-582-11	RES, ADJ, CARBON 470 (S LEVEL ADJ)			
R450	1-216-833-11	METAL CHIP	10K	5%	1/16W	RV401	1-223-582-11	RES, ADJ, CARBON 470 (PROG LEVEL ADJ)			
R451	1-216-797-11	METAL CHIP	10	5%	1/16W						< RELAY >
R452	1-216-821-11	METAL CHIP	1K	5%	1/16W						
R453	1-216-797-11	METAL CHIP	10	5%	1/16W	RY401	1-755-184-11	RELAY			
R454	1-216-821-11	METAL CHIP	1K	5%	1/16W	RY402	1-755-184-11	RELAY			
R455	1-216-797-11	METAL CHIP	10	5%	1/16W						< SWITCH >
R456	1-216-821-11	METAL CHIP	1K	5%	1/16W						
R457	1-243-862-91	METAL CHIP	75	0.5%	1/8W	S401	1-692-989-11	SWITCH, SLIDE (SCAN SELECT)			
					(EXCEPT AEP, UK)						< VIBRATOR >
R458	1-243-862-91	METAL CHIP	75	0.5%	1/8W	X101	1-760-626-11	VIBRATOR, CRYSTAL (27MHz)			
R459	1-216-797-11	METAL CHIP	10	5%	1/16W	X301	1-781-994-21	VIBRATOR, CRYSTAL (24.000MHz)			
R460	1-216-797-11	METAL CHIP	10	5%	1/16W						
R461	1-216-797-11	METAL CHIP	10	5%	1/16W						
R462	1-216-833-11	METAL CHIP	10K	5%	1/16W						
											MISCELLANEOUS
R463	1-216-833-11	METAL CHIP	10K	5%	1/16W						*****
					(EXCEPT AEP, UK)	9	1-476-236-11	SWITCH BLOCK, CONTROL			
R464	1-218-855-11	METAL CHIP	2.2K	0.5%	1/16W	58	1-794-774-11	INLET ASSY, AC (US, CND)			
					(EXCEPT AEP, UK)	58	1-794-774-21	INLET ASSY, AC (EXCEPT US, CND)			
R464	1-218-856-11	RES-CHIP	2.4K	0.5%	1/16W	59	1-500-386-11	FILTER, CLAMP (FERRITE CORE)			
					(AEP, UK)	61	1-757-069-11	CABLE, FLEXIBLE FLAT (FVE-1) (AEP, UK)			
R465	1-218-855-11	METAL CHIP	2.2K	0.5%	1/16W						
R466	1-218-855-11	METAL CHIP	2.2K	0.5%	1/16W						
					(EXCEPT AEP, UK)	65	1-757-064-11	CABLE, FLEXIBLE FLAT (FMA-19)			
R466	1-218-856-11	RES-CHIP	2.4K	0.5%	1/16W	66	1-757-067-11	CABLE, FLEXIBLE FLAT (FMV-21)			
					(AEP, UK)	69	1-757-066-11	CABLE, FLEXIBLE FLAT (FMF-41)			
R467	1-218-855-11	METAL CHIP	2.2K	0.5%	1/16W	103	1-757-068-11	CABLE, FLEXIBLE FLAT (FCM-13)			
						△109	A-6062-397-A	SERVICE ASSY, KHM-220AAA			

The components identified by mark △ or dotted line with mark △ are critical for safety. Replace only with part number specified.	Les composants identifiés par une marque △ sont critiques pour la sécurité. Ne les remplacer que par une pièce portant le numéro spécifié.
--	--

Ref. No.	Part No.	Description	Remark
112	1-757-065-11	CABLE, FLEXIBLE FLAT (FMT-29)	
M501	1-763-397-21	MOTOR, DC (RF-300FA-12350) (LOADING)	
△ T901	1-435-680-11	TRANSFORMER, POWER (AUDIO) (US, CND)	
△ T901	1-435-681-11	TRANSFORMER, POWER (AUDIO) (EXCEPT US, CND)	
△ T902	1-435-683-11	TRANSFORMER, POWER (VIDEO/SYSCON) (US, CND)	
△ T902	1-435-684-11	TRANSFORMER, POWER (VIDEO/SYSCON) (EXCEPT US, CND)	

\*\*\*\*\*  
HARDWARE LIST  
\*\*\*\*\*

#1	7-685-646-79	SCREW +BVTP 3X8 TYPE2 IT-3
#3	7-685-648-79	SCREW +BVTP 3X12 TYPE2 IT-3
#4	7-685-880-09	SCREW +BVTT 4X6 (S)
#5	7-682-548-09	SCREW +B 3X8
#6	7-685-645-79	SCREW +BTP 3X6TYPE2 N-S
#7	7-624-102-04	STOP RING 1.5, TYPE -E
#8	7-627-852-38	SCREW, PRECISION +P 1.7X1.8 TYPE3
#9	7-683-405-04	BOLT, HEXAGON SOCKET 3X10

ACCESSORIES & PACKING MATERIALS  
\*\*\*\*\*

	1-476-249-11	COMMANDER, STANDARD (RMT-D122A) (US, CND)
	1-476-249-31	COMMANDER, STANDARD (RMT-D122P) (AEP, UK)
	1-476-249-41	COMMANDER, STANDARD (RMT-D122E) (HK, CN)
	1-476-249-51	COMMANDER, STANDARD (RMT-D1220) (AUS)
△	1-551-631-00	CORD, POWER (AEP)
△	1-551-812-31	CORD, POWER (US, CND)
△	1-558-481-31	CORD, POWER (AUS)
	1-575-334-41	CORD, CONNECTION (STEREO AV CABLE 1.5m)
△	1-757-129-11	CORD, POWER (UK, HK)
△	1-757-130-11	CORD, POWER (CN)
	1-775-454-21	CORD, CONNECTION (STEREO AV S-LINK CABLE 1.5m) (US, CND)
	1-776-078-31	CORD, CONNECTION (S-VIDEO CABLE 1.5m)
	3-063-397-11	MANUAL, INSTRUCTION (ENGLISH) (US, CND)
	3-063-397-21	MANUAL, INSTRUCTION (FRENCH) (US, CND)
	3-063-397-31	MANUAL, INSTRUCTION (ENGLISH) (HK, CN, AUS)
	3-063-397-41	MANUAL, INSTRUCTION (SIMPLIFIED CHINESE) (CN)
	3-063-397-51	MANUAL, INSTRUCTION (TRADITIONAL CHINESE) (HK)
	3-063-398-11	MANUAL, INSTRUCTION (ENGLISH) (AEP, UK)
	3-063-398-21	MANUAL, INSTRUCTION (FRENCH, GERMAN) (AEP)
	3-063-398-31	MANUAL, INSTRUCTION (ITALIAN, DUTCH) (AEP)
	3-063-398-41	MANUAL, INSTRUCTION (SPANISH) (AEP)
*	3-694-922-01	SHEET, PROTECTION

The components identified by mark △ or dotted line with mark △ are critical for safety. Replace only with part number specified.

Les composants identifiés par une marque △ sont critiques pour la sécurité. Ne les remplacer que par une pièce portant le numéro spécifié.

