

DVD LD PLAYER
Lecteur de DVD, LD

DVL-V888

Operating Instructions
Mode d'emploi



Refer pages 6-7 for "Contents".



- First refer to "Before using" on page 8 and "Connecting the Player" on pages 66 - 68.
- Refer to pages 12 - 17 for basic playback.
- Refer to pages 28 - 29 for Karaoke functions.

Thank you for buying this Pioneer product. Please read through these operating instructions so you will know how to operate your model properly. After you have finished reading the instructions, put them away in a safe place for future reference.

- This player is not suitable for commercial use.

IMPORTANT SAFETY INSTRUCTIONS

READ INSTRUCTIONS — All the safety and operating instructions should be read before the product is operated.

RETAIN INSTRUCTIONS — The safety and operating instructions should be retained for future reference.

HEED WARNINGS — All warnings on the product and in the operating instructions should be adhered to.

FOLLOW INSTRUCTIONS — All operating and use instructions should be followed.

CLEANING — Unplug this product from the wall outlet before cleaning. The product should be cleaned only with a polishing cloth or a soft dry cloth. Never clean with furniture wax, benzine, insecticides or other volatile liquids since they may corrode the cabinet.

ATTACHMENTS — Do not use attachments not recommended by the product manufacturer as they may cause hazards.

WATER AND MOISTURE — Do not use this product near water — for example, near a bathtub, wash bowl, kitchen sink, or laundry tub; in a wet basement; or near a swimming pool; and the like.

ACCESSORIES — Do not place this product on an unstable cart, stand, tripod, bracket, or table. The product may fall, causing serious injury to a child or adult, and serious damage to the product. Use only with a cart, stand, tripod, bracket, or table recommended by the manufacturer, or sold with the product. Any mounting of the product should follow the manufacturer's instructions, and should use a mounting accessory recommended by the manufacturer.

CART — A product and cart combination should be moved with care. Quick stops, excessive force, and uneven surfaces may cause the product and cart combination to overturn.



VENTILATION — Slots and openings in the cabinet are provided for ventilation and to ensure reliable operation of the product and to protect it from overheating, and these openings must not be blocked or covered. The openings should never be blocked by placing the product on a bed, sofa, rug, or other similar surface. This product should not be placed in a built-in installation such as a bookcase or rack unless proper ventilation is provided or the manufacturer's instructions have been adhered to.

POWER SOURCES — This product should be operated only from the type of power source indicated on the marking label. If you are not sure of the type of power supply to your home, consult your product dealer or local power company.

LOCATION — The appliance should be installed in a stable location.

NONUSE PERIODS — The power cord of the appliance should be unplugged from the outlet when left unused for a long period of time.

GROUNDING OR POLARIZATION

- If this product is equipped with a polarized alternating current line plug (a plug having one blade wider than the other), it will fit into the outlet only one way. This is a safety feature. If you are unable to insert the plug fully into the outlet, try reversing the plug. If the plug should still fail to fit, contact your electrician to replace your obsolete outlet. Do not defeat the safety purpose of the polarized plug.
- If this product is equipped with a three-wire grounding type plug, a plug having a third (grounding) pin, it will only fit into a grounding type power outlet. This is a safety feature. If you are unable to insert the plug into the outlet, contact your electrician to replace your obsolete outlet. Do not defeat the safety purpose of the grounding type plug.

POWER-CORD PROTECTION — Power-supply cords should be routed so that they are not likely to be walked on or pinched by items placed upon or against them, paying particular attention to cords at plugs, convenience receptacles, and the point where they exit from the product.

OUTDOOR ANTENNA GROUNDING — If an outside antenna or cable system is connected to the product, be sure the antenna or cable system is grounded so as to provide some protection against voltage surges and built-up static charges. Article 810 of the National Electrical Code, ANSI/NFPA 70, provides information with regard to proper grounding of the mast and supporting structure, grounding of the lead-in wire to an antenna discharge unit, size of grounding conductors, location of antenna-discharge unit, connection to grounding electrodes, and requirements for the grounding electrode. See Figure A.

LIGHTNING — For added protection for this product during a lightning storm, or when it is left unattended and unused for long periods of time, unplug it from the wall outlet and disconnect the antenna or cable system. This will prevent damage to the product due to lightning and power-line surges.

POWER LINES — An outside antenna system should not be located in the vicinity of overhead power lines or other electric light or power circuits, or where it can fall into such power lines or circuits. When installing an outside antenna system, extreme care should be taken to keep from touching such power lines or circuits as contact with them might be fatal.

OVERLOADING — Do not overload wall outlets, extension cords, or integral convenience receptacles as this can result in a risk of fire or electric shock.

OBJECT AND LIQUID ENTRY — Never push objects of any kind into this product through openings as they may touch dangerous voltage points or short-out parts that could result in a fire or electric shock. Never spill liquid of any kind on the product.

SERVICING — Do not attempt to service this product yourself as opening or removing covers may expose you to dangerous voltage or other hazards. Refer all servicing to qualified service personnel.

DAMAGE REQUIRING SERVICE — Unplug this product from the wall outlet and refer servicing to qualified service personnel under the following conditions:

- When the power-supply cord or plug is damaged.
- If liquid has been spilled, or objects have fallen into the product.
- If the product has been exposed to rain or water.
- If the product does not operate normally by following the operating instructions. Adjust only those controls that are covered by the operating instructions as an improper adjustment of other controls may result in damage and will often require extensive work by a qualified technician to restore the product to its normal operation.
- If the product has been dropped or damaged in any way.
- When the product exhibits a distinct change in performance — this indicates a need for service.

REPLACEMENT PARTS — When replacement parts are required, be sure the service technician has used replacement parts specified by the manufacturer or have the same characteristics as the original part. Unauthorized substitutions may result in fire, electric shock, or other hazards.

SAFETY CHECK — Upon completion of any service or repairs to this product, ask the service technician to perform safety checks to determine that the product is in proper operating condition.

WALL OR CEILING MOUNTING — The product should not be mounted to a wall or ceiling.

HEAT — The product should be situated away from heat sources such as radiators, heat registers, stoves, or other products (including amplifiers) that produce heat.

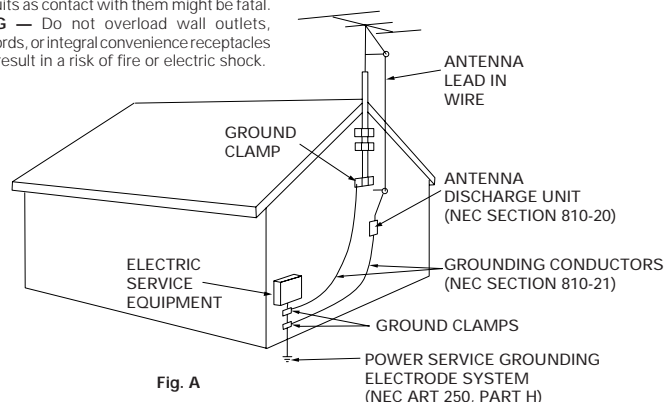

Fig. A

NEC — NATIONAL ELECTRICAL CODE

IMPORTANT



The lightning flash with arrowhead symbol, within an equilateral triangle, is intended to alert the user to the presence of uninsulated "dangerous voltage" within the product's enclosure that may be of sufficient magnitude to constitute a risk of electric shock to persons.

CAUTION
RISK OF ELECTRIC SHOCK
DO NOT OPEN

CAUTION:
TO PREVENT THE RISK OF ELECTRIC SHOCK, DO NOT REMOVE COVER (OR BACK). NO USER-SERVICEABLE PARTS INSIDE. REFER SERVICING TO QUALIFIED SERVICE PERSONNEL.



The exclamation point within an equilateral triangle is intended to alert the user to the presence of important operating and maintenance (servicing) instructions in the literature accompanying the appliance.

IMPORTANT



Ce symbole de l'éclair, placé dans un triangle équilatéral, a pour but d'attirer l'attention de l'utilisateur sur la présence, à l'intérieur du coffret de l'appareil, de "tensions dangereuses" non isolées d'une grandeur suffisante pour représenter un risque d'électrocution pour les êtres humains.

ATTENTION
DANGER D'ELECTROCUTION
NE PAS OUVRIR

ATTENTION: Pour éviter tout risque d'électrocution, ne pas enlever le couvercle (ni le panneau arrière). Aucune pièce réparable par l'utilisateur ne se trouve à l'intérieur. Confier tout entretien à un personnel qualifié uniquement.



Ce point d'exclamation, placé dans un triangle équilatéral, a pour but d'attirer l'attention de l'utilisateur sur la présence, dans les documents qui accompagnent l'appareil, d'explications importantes du point de vue de l'exploitation ou de l'entretien.

WARNING: TO PREVENT FIRE OR SHOCK HAZARD, DO NOT EXPOSE THIS APPLIANCE TO RAIN OR MOISTURE.

IMPORTANT NOTICE

[For U.S. and Canadian models]

The serial number for this equipment is located on the rear panel. Please write this serial number on your enclosed warranty card and keep it in a secure area. This is for your security.

[For Canadian model]

CAUTION: TO PREVENT ELECTRIC SHOCK DO NOT USE THIS (POLARIZED) PLUG WITH AN EXTENSION CORD, RECEPTACLE OR OTHER OUTLET UNLESS THE BLADES CAN BE FULLY INSERTED TO PREVENT BLADE EXPOSURE.

CAUTION: This product satisfies FCC regulations when shielded cables and connectors are used to connect the unit to other equipment. To prevent electromagnetic interference with electric appliances such as radios and televisions, use shielded cables and connectors for connections.

THE POWER SWITCH IS SECONDARY CONNECTED AND THEREFORE DOES NOT SEPARATE THE UNIT FROM MAINS POWER IN STANDBY POSITION.

ATTENTION: AFIN DE PREVENIR TOUS RISQUES DE CHOC ELECTRIQUE OU DE DEBUT D'ENCENDIE, NE PAS EXPOSER CET APPAREIL A L'HUMIDITE OU A LA PLUIE.

REMARQUE IMPORTANTE

Le numéro de série de cet appareil se trouve son panneau arrière. Pour s'y référer en cas de besoin, prière d'inscrire ce numéro sur la carte de garantie incluse et de la conserver dans un endroit sûr.

ATTENTION: POUR PREVENIR LES CHOCES ELECTRIQUES NE PAS UTILISER CETTE FICHE POLARISEE AVEC UN PROLONGATEUR UNE PRISE DE COURANT OU UNE AUTRE SORTIE DE COURANT, SAUF SI LES LAMES PEUVENT ETRE INSEREES A FOND SANS EN LAISSER AUCUNE PARTIE A DECOUVERT.

L'INTERRUPTEUR D'ALIMENTATION EST RACCORDE SECONDAIREMENT ET PAR CONSEQUENT NE SEPARÉ PAS L'APPAREIL DE L'ALIMENTATION SECTEUR SUR LA POSITION D'ATTENTE.

This equipment has been tested and found to comply with the limits for a Class B digital device, pursuant to Part 15 of the FCC Rules. These limits are designed to provide reasonable protection against harmful interference in a residential installation. This equipment generates, uses, and can radiate radio frequency energy and, if not installed and used in accordance with the instructions, may cause harmful interference to radio communications. However, there is no guarantee that interference will not occur in a particular installation. If this equipment does cause harmful interference to radio or television reception, which can be determined by turning the equipment off and on, the user is encouraged to try to correct the interference by one or more of the following measures:

- Reorient or relocate the receiving antenna.
- Increase the separation between the equipment and receiver.
- Connect the equipment into an outlet on a circuit different from that to which the receiver is connected.
- Consult the dealer or an experienced radio/TV technician for help.

Information to User

Alteration or modifications carried out without appropriate authorization may invalidate the user's right to operate the equipment.

CAUTION

- Use of controls or adjustments or performance of procedures other than those specified herein may result in hazardous radiation exposure.
- The use of optical instruments with this product will increase eye hazard.

[For Canadian model]

This Class B digital apparatus meets all requirements of the Canadian Interference-Causing Equipment Regulations.

[Pour le modèle Canadien]

Cet appareil numérique de la Classe B respecte toutes les exigences du Règlement sur le matériel brouilleur du Canada.



Dear Customer:

Selecting fine audio equipment such as the unit you've just purchased is only the start of your musical enjoyment. Now it's time to consider how you can maximize the fun and excitement your equipment offers. This manufacturer and the Electronic Industries Association's Consumer Electronics Group want you to get the most out of your equipment by playing it at a safe level. One that lets the sound come through loud and clear without annoying blaring or distortion—and, most importantly, without affecting your sensitive hearing.

Sound can be deceiving. Over time your hearing "comfort level" adapts to higher volumes of sound. So what sounds "normal" can actually be loud and harmful to your hearing. Guard against this by setting your equipment at a safe level BEFORE your hearing adapts.

To establish a safe level:

- Start your volume control at a low setting.
- Slowly increase the sound until you can hear it comfortably and clearly, and without distortion.

Once you have established a comfortable sound level:

- Set the dial and leave it there.

Taking a minute to do this now will help to prevent hearing damage or loss in the future. After all, we want you listening for a lifetime.

We Want You Listening For A Lifetime

Used wisely, your new sound equipment will provide a lifetime of fun and enjoyment. Since hearing damage from loud noise is often undetectable until it is too late, this manufacturer and the Electronic Industries Association's Consumer Electronics Group recommend you avoid prolonged exposure to excessive noise. This list of sound levels is included for your protection.

Decibel

| <u>Level</u> | <u>Example</u> |
|--------------|---|
| 30 | Quiet library, soft whispers |
| 40 | Living room, refrigerator, bedroom away from traffic |
| 50 | Light traffic, normal conversation, quiet office |
| 60 | Air conditioner at 20 feet, sewing machine |
| 70 | Vacuum cleaner, hair dryer, noisy restaurant |
| 80 | Average city traffic, garbage disposals, alarm clock at two feet. |

THE FOLLOWING NOISES CAN BE DANGEROUS UNDER CONSTANT EXPOSURE

| | |
|-----|---|
| 90 | Subway, motorcycle, truck traffic, lawn mower |
| 100 | Garbage truck, chain saw, pneumatic drill |
| 120 | Rock band concert in front of speakers, thunderclap |
| 140 | Gunshot blast, jet plane |
| 180 | Rocket launching pad |

Information courtesy of the Deafness Research Foundation.



See What You Can Do

SCORING (P.34)

This function grades your singing ability.



Dolby Digital* (P.61)

Connect to a Digital Surround Amp and Surround Processor for 5.1ch Dolby Digital Surround entertainment.

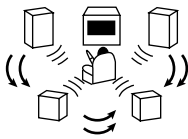

GUI Operation (P.53)

While viewing Pioneer's original GUI on-screen displays, you can perform operations by remote control. Even if there is no menu recorded on a disc, you can still perform GUI operation with the menu provided by the player.

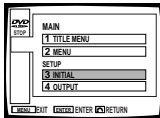

Continuous Play of Both Sides of LDs* (P.12)

You can enjoy continuous playback of both sides of a laserdisc.



Last Memory Play* (P.18)

If you stop video playback, this lets you resume play back from where it was stopped.



Cinema Mode & Animation Mode (P.44)

Lets you select the ideal picture quality for watching movies and animation movies.

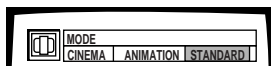

Still Frame* (P.25)

You can view still frames.

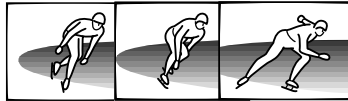

Repeat Play* (P.24)

Wide range of Repeat Play possibilities.

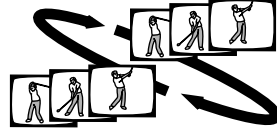

Multi-Aspect* (P.42)

You can select between Regular, Wide, and Letter Box display formats.



PBC Video CD Compatibility (P.14, P.20)

Ready to play Video CDs (Version 2.0) with PBC (Play Back Control). Two types of playback are possible depending on the disc.

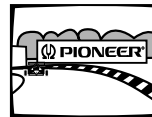

Power On Demo Display

Switching ON the Power On Display provides a wide range of indications.

To switch to power ON demo display, press the power switch while pressing the HI-LITE MEDLAY button. Press any button to cancel the demo indications.

Multi-language Subtitles* (P.50)

You can select a desired subtitle language when watching movies and other videos.

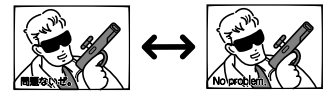

Multi-Angle* (P.50)

Lets you view scenes from different camera angles.

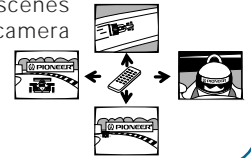

Multi-Languages* (P.49)

With discs that have multiple language soundtracks recorded on them, you can select the desired language.

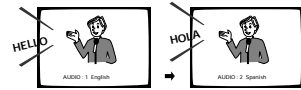

Parental Level* (P.61)

Lets you select a "parental level" (user restriction level) to prevent children from viewing undesirable material.

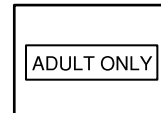

* This mark indicates this may not be possible with certain discs.

This product incorporates copyright protection technology that is protected by method claims of certain U.S. patents and other intellectual property rights owned by Macrovision Corporation and other rights owners. Use of this copyright protection technology must be authorized by Macrovision Corporation, and is intended for home and other limited viewing uses only unless otherwise authorized by Macrovision Corporation. Reverse engineering or disassembly is prohibited.

Contents



| | | DVD | CD | LD | VIDEO CD |
|--|----------------|-----|----|----|----------|
| See What You Can Do | 5 | | | | |
| Contents | 6 | | | | |
| Before Using | 8 | | | | |
| Checking accessories | 8 | | | | |
| Inserting batteries into the remote control | 8 | | | | |
| Caution Before Using | 9 | | | | |
| Disc Types Compatible with this Unit | 10 | | | | |
| Basic Operation | 11 – 18 | | | | |
| Playing LDs | 12 | | | ● | |
| Playing DVDs, CDs, and Video CDs with No PBC | 13 | ● | ● | | ● |
| Playing Video CDs (with PBC) | 14 | | | | ● |
| Chapter (Track) Skip Forward/Skip Back | 16 | ● | ● | ● | ● |
| Stopping Playback & Switching Power OFF | 17 | ● | ● | ● | ● |
| Continuing Playback from where you Stopped | 18 | ● | | ● | ● |
| Detailed Operation | 19 – 25 | | | | |
| Playback by Menu Selection | 20 | ● | | | ● |
| Playing Back CD Graphics | 21 | | ● | | |
| Searching for a Desired Video Scene/Audio Track | 22 | ● | ● | ● | ● |
| Repeat Play | 24 | ● | ● | ● | ● |
| Still Frame | 25 | ● | | ● | ● |
| Karaoke Operation | 27 – 39 | | | | |
| Karaoke Entertainment | 28 | ● | ● | ● | ● |
| SINGLE PLAY | 29 | ● | ● | ● | ● |
| Creating Singing Venue Atmosphere | 29 | ● | ● | ● | ● |
| Karaoke with connected external components | 29 | | | | |
| Adjusting to Create the Desired Sound | 30 | | | | |
| Echo adjustment | 30 | ● | ● | ● | ● |
| Changing performance key | 30 | ● | ● | ● | ● |
| Operation is possible with the mic | 30 | ● | ● | ● | ● |
| Convenient Function for Practicing Karaoke | 31 | | | | |
| Guide Vocal | 31 | ● | ● | ● | ● |
| DUET MODE/CHORUS MODE | 32 | ● | | | |
| VOCAL PARTNER/ONE-TOUCH KARAOKE | 33 | ● | ● | ● | ● |
| SCORING Grades Your Singing Ability | 34 | ● | ● | ● | ● |
| Simultaneous Scoring for Two Singers (COMPETITION) | 36 | ● | ● | ● | ● |
| Consecutive Play of Song Highlights (HI-LITE MEDLEY) | 37 | ● | | | |
| Reserving a Desired Song | 38 | ● | ● | ● | ● |
| One Verse Chorus Play Only (One Chorus) | 39 | ● | | | |
| Sing with Professional Karaoke (GUIDE MELODY) | 39 | ● | | | |

DVD

CD

LD

VIDEO CD



| Setting | 41 – 64 | DVD | CD | LD | VIDEO CD |
|---|----------------|-----|----|----|----------|
| Multi-Aspect Setting for Wide Screen TV Software | 42 | ● | | | |
| Changing Picture and Sound Quality Settings | 43 | ● | ● | ● | ● |
| Changing Picture Quality(mode) | 44 | ● | | ● | ● |
| Switching singing venue atmosphere (KARAOKE SURROUND) | 45 | ● | ● | ● | ● |
| Changing Sound Quality(D.R.COMP) | 45 | ● | | | |
| Changing graphics display position | 46 | | ● | | |
| Changing graphics channel | 47 | | ● | | |
| Memorizing Settings for Often Viewed DVDs (Condition Memory) | 48 | ● | | | |
| Selecting Languages (Multi-Language) | 49 | ● | | | |
| Changing Audio Type | 49 | | ● | ● | ● |
| Selecting Subtitle Language (Multi-Language Subtitles) | 50 | ● | | | |
| Viewing from a Desired Camera Angle (Multi-Angle) | 50 | ● | | | |
| Viewing Information | 51 | ● | ● | ● | ● |
| Quick LD Side Changing(Quick Turn) | 52 | | | ● | |
| Outline of GUI (Graphical User Interface) Operation | 53 | ● | ● | ● | ● |
| Changing Various Settings | 60 | ● | ● | ● | ● |
| Setting the Basic Language and Subtitle Language | 62 | ● | | | |
| Set Up | 65 – 72 | | | | |
| Connecting the Player | | | | | |
| Connection example 1. To a TV with video input (When connecting a cassette deck or other component to the external input) | 66 | | | | |
| Connection example 2. To an amp with Dolby Digital (AC-3) input | 67 | | | | |
| Connection example 3. AV amp | 68 | | | | |
| Names and Functions | | | | | |
| Front panel | 69 | | | | |
| Rear panel | 70 | | | | |
| Display window | 71 | | | | |
| Remote control | 72 | | | | |
| Other Information | 73 – 78 | | | | |
| Troubleshooting | 73 | | | | |
| Terms | 75 | | | | |
| For Proper and Long Use | 77 | | | | |
| Specifications | 78 | | | | |

Before Using

Checking accessories

Audio cord

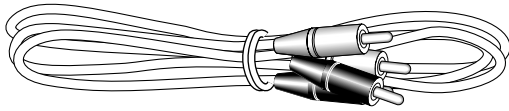

Video cord

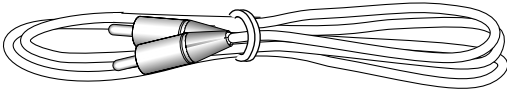

Power cord

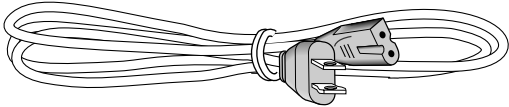

Remote control unit

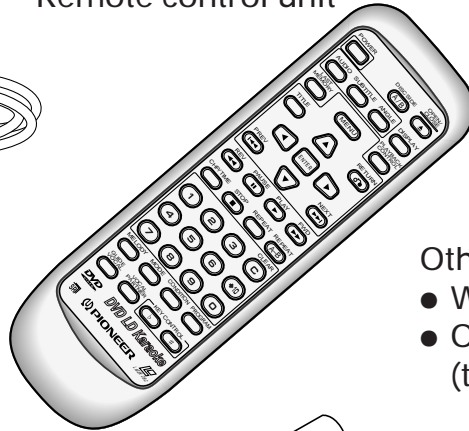

Batteries....2

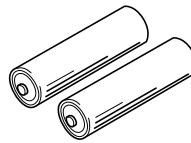

- Other included items
- Warranty card
 - Operating Instructions (this manual)

Inserting batteries into the remote control

1

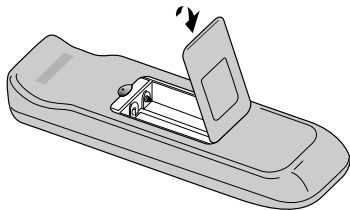

While pressing the back cover, pull out in the direction indicated by the arrow.

2

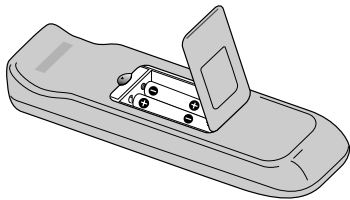

Insert batteries.

Make sure to match the plus (+) and minus (-) polarity guides on the batteries with the marks inside the battery compartment.

3

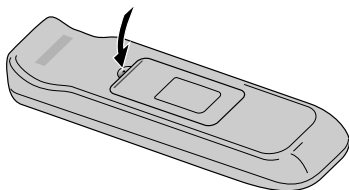

Close the cover.

Notes

- ◆ Do not mix old and new batteries.
- ◆ Even batteries of the same type will differ in voltage. Do not mix old batteries with new batteries.
- ◆ When not using the remote control for a long period of time (over 1 month), remove the batteries to avoid possible damage from battery corrosion. If battery leakage occurs, wipe the battery liquid from the battery compartment, then insert new batteries.

Caution Before Using

CARE OF DISCS

How to hold discs

- Be sure to store discs in their cases, away from high temperatures and humidity, direct sunlight, and extremely low temperatures.
- Be sure to read disc instructions.

Cleaning

- Fingerprints or other dirt on the disc may affect sound and picture quality. Gently wipe from the inside toward the outer edge.
- Discs must not be cleaned with record cleaning sprays, or static prevention sprays, etc. Also do not use volatile liquids such as benzene, or thinner, etc.
- You are recommended to use the separately sold JV-D11 Cleaning Set to clean discs.
- For stubborn dirt, soak the cloth in a weak detergent solution; wring well first and wipe. Use a dry cloth to wipe it dry.
- Never play cracked or warped discs.
- Do not scratch or stick paper or seals on the label side of a disc. Glue may seep out, preventing ejection of a disc or causing other problems. **Rental discs often have labels, so check that no glue is seeping out before playing to avoid such problems.**

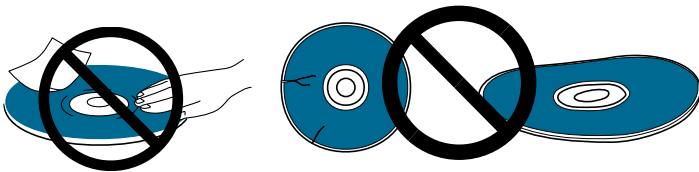
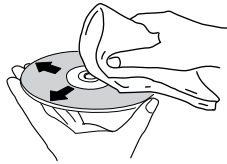

Do not play a CD with a special shape

Do not play a CD having other shape than a circular disc, such as a heart shaped disc. Otherwise malfunction may occur.

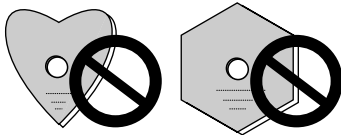

LD/CD lens cleaner

The player's pickup lens should not get dirty in normal use, but if for some reason it should malfunction due to soiling, consult your nearest PIONEER authorized service center. Special care should be exercised as some lens cleaning discs may damage the lens. Ejecting some cleaning discs may also be impossible after use.

CONDENSATION

Moisture will form in the operating section of the player if the player is brought from cool surroundings into a warm room or if the temperature of the room rises suddenly. When this happens, the player's performance will be impaired.

To prevent this, let the player stand in its new surroundings for about an hour before switching it on, or make sure that the room temperature rises gradually.

Condensation may also form during the summer if the player is exposed to the breeze from an air conditioner. In such cases, change the location of the player.

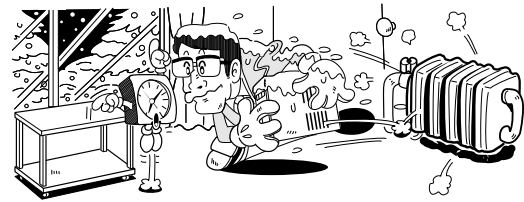

Notes on using the optional optical cable

- Do not route the cable around sharp objects. When storing, wind the cable so that it has a diameter of at least 15 cm.
- When connecting, push the plug all the way into the terminal.
- Please don't use cables with a length of over 3 m.
- If moisture or dust has collected on the plug, wipe it with a soft cloth before connecting.

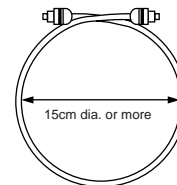

Disc Types Compatible with this Unit

This player is DVD, LD, CD, and Video CD compatible. The marks shown on the right are found on disc labels or on disc jackets.

- This player can play all discs bearing the marks on the right without the need for an adaptor.
- To prevent malfunction, do not use an 8 cm (3 in.) adaptor (for CDs).

This unit is NTSC compatible (TV color system).

You cannot use discs other than those shown on the right.

* During DVD playback, data transfer is at 4.7 MBit per second.

Handling the discs

| | LD | DVD, CD, etc. |
|--------------------------------|----|---------------|
| Holding with both hands | | |
| Holding with one hand | | |

Disc Table

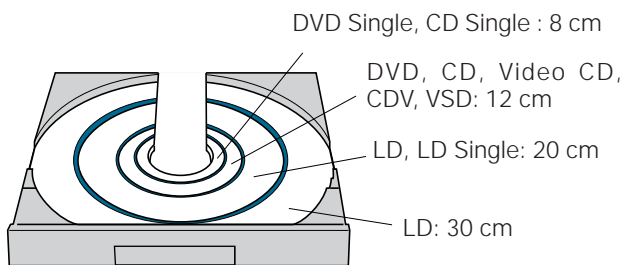

Note

- ◆ You cannot play DVDs that do not bear the Region No. (refer to "Terms" on page 76) indicated on the player's rear panel.

Discs other than those mentioned at right cannot be played.

To prevent damage to the player, do not play a disc type other than those above.

(Ex.) DVD audio, CD-ROM, LD-ROM, DVD-ROM, High Definition LD, CD with a special shape etc.

| Types of playable discs and their marks | Diameter/Playable sides | Playback time |
|---|--|---|
| | DVD VIDEO | Digital audio Digital video (MPEG 2) |
| | 12 cm (5 in.)/ single-sided 1 layer 2 layers | 133 min.* 242 min.* |
| | 12 cm (5 in.)/ double-sided 1 layer 2 layers | 266 min.* 484 min.* |
| | DVD VIDEO | Digital audio Digital video (MPEG 2) |
| | 8 cm (3 in.)/ single-sided 1 layer 2 layers | 41 min.* 75 min.* |
| | 8 cm (3 in.)/ double-sided 1 layer 2 layers | 82 min.* 150 min.* |
| | VIDEO CD 12 cm (5 in.)/single-sided | Digital audio Digital video (MPEG 1) Max. 74 minutes |
| | VIDEO CD single 8 cm (3 in.)/single-sided | Digital audio Digital video (MPEG 1) Max. 20 minutes |
| | CD | Max. 74 minutes |
| | 12 cm (5 in.)/ single-sided | |
| | CD GRAPHICS CD single | Max. 20 minutes |
| | 8 cm (3 in.)/ single-sided | |
| | CDV | Digital audio (max. 20 min.) (Audio part) |
| | 12 cm (5 in.)/ single-sided | Digital audio + video (max. 5 min.) (Video part) |
| | VSD (Video Single Disc) | Digital audio + video (max. 5 min.) (Video part) |
| | 12 cm (5 in.)/ single-sided | In these operating instructions, the VSD is treated as a kind of CDV. |
| | LD | CAV 1 hour on a double-sided disc |
| | 30 cm (12 in.) | CLV 2 hours on a double-sided disc |
| | LD | CAV 28 min. on a double-sided disc |
| | 20 cm (8 in.) | CLV 40 min. on a double-sided disc |
| | LD Single | CAV 14 min. on a single-sided disc |
| | 20 cm (8 in.) | CLV 20 min. on a single-sided disc |

Basic Operation

| | |
|---|----|
| Playing LDs | 12 |
| Playing DVDs, CDs and Video CDs with No PBC | 13 |
| Playing Video CDs (with PBC) | 14 |
| Chapter (Track) Skip Forward/Skip Back | 16 |
| Stopping Playback & Switching Power OFF | 17 |
| Continuing Playback from where you Stopped..... | 18 |

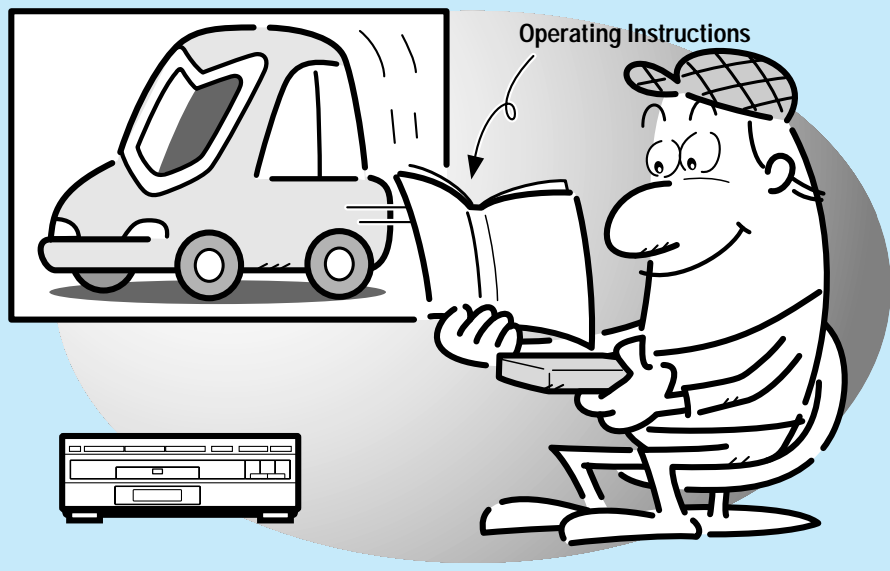

Playing LDs

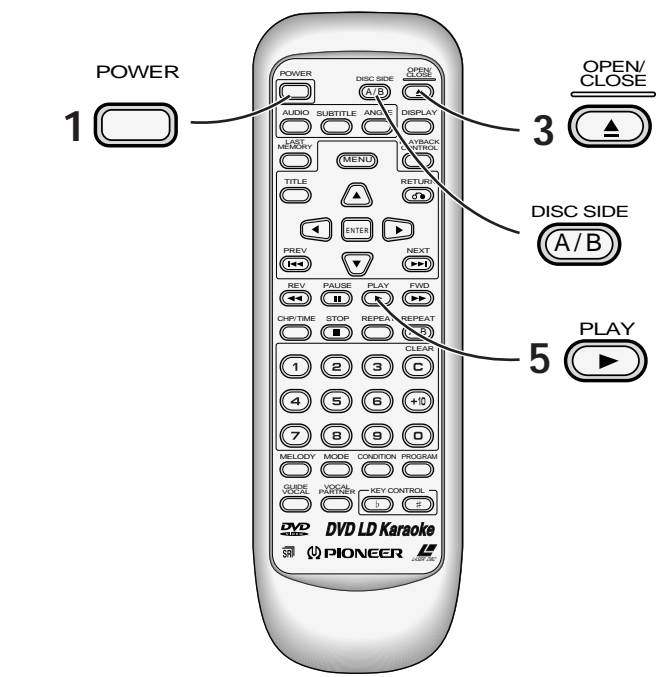
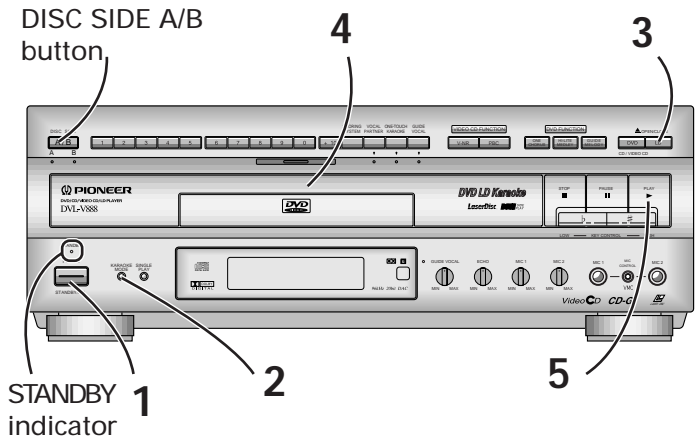

Notes

- ◆ When you switch power to this product ON, it switches to the KARAOKE MODE, and the KARAOKE MODE button lights.
- ◆ Not aligning a disc with the disc guide, or loading two discs at once will result in damage to the disc(s) and player.

1 Press the **POWER** button.

● The **STANDBY** indicator goes out.

2 When playing a Video/Audio disc, press the **KARAOKE MODE** button to select **"NORMAL MODE"**.

Each time you press the button, the setting changes as follows.

KARAOKE MODE → NORMAL MODE → AUX INPUT MODE → KARAOKE MODE

3 Press the **LD OPEN/CLOSE** button.

● The disc table comes out.

4 Load a disc.

● Load a single-sided disc with the label facing up, or load a double-sided disc with the label for the desired side facing up, using the disc table guide to align the disc.

5 Press the **PLAY** button.

● Playback starts.

● When the A side of a double-sided disc has finished playing, playback of the B side automatically starts.

Tips

- Each time you press the Disc side A/B button on the main unit, the disc side changes from A to B or from B to A. The Side A or Side B indicator on the main unit lights to indicate the current disc side.
- With a double-sided LD, load with the A side facing up and the B side facing down. Recorded A and B sides are on opposite sides of the disc itself.



Playing DVDs, CDs and Video CDs with No PBC

Please refer to page 14 for Video CDs with PBC.

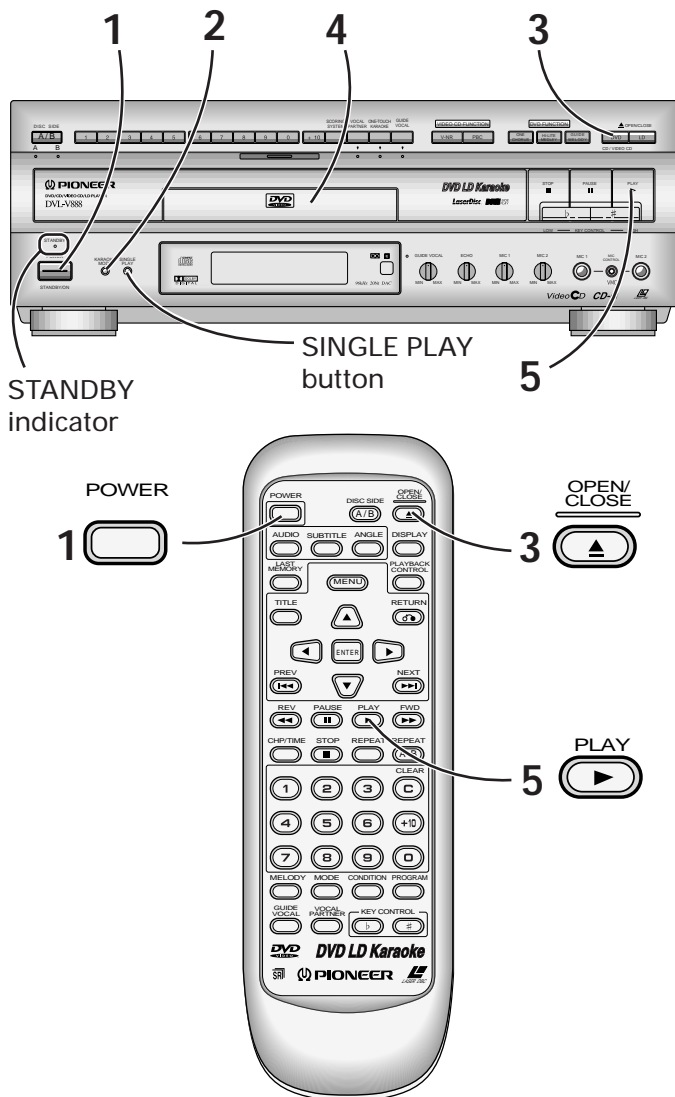

1 Press the **POWER** button.

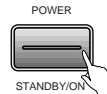

- The STANDBY indicator goes out.

2 When playing a Video/Audio disc, press the **KARAOKE MODE** button to select "NORMAL MODE".



Each time you press the button, the setting changes as follows.

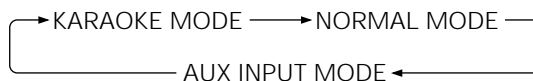

3 Press the **DVD/CD/VIDEO CD OPEN/CLOSE** button.

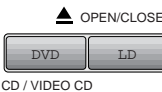

- The disc table comes out.

4 Load a disc.

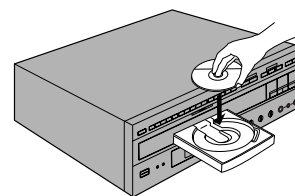

- Load a disc with the label side facing up, using the disc table guide to align the disc.

5 Press the **PLAY** button.

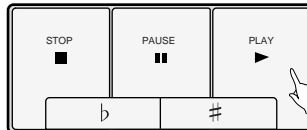

- Playback starts.
- With some DVD disks, a menu may be displayed. If a menu is displayed, refer to page 20.

Notes

- ◆ During operation, the following marks may appear on the TV screen.
 - ⚠: When you perform an operation that is not possible with the player.
 - ⚠: When you perform an operation that is not possible with the disc.
- ◆ After stopping DVD play, if you start play without specifying a title with a menu or other means, the previous title is played.
- ◆ If you press the SINGLE PLAY button on the front panel to switch the indicator OFF, you can cancel SINGLE PLAY so that songs are played continuously, one after another.
- ◆ With the KARAOKE MODE (when the KARAOKE MODE button on the front panel is lit), depending on the TV you're using and mic volume level, there may be distortion when playing DVDs, CDs or Video CDs. To prevent this keep analog output sound volume level low.
- ◆ The time taken for playback to start may differ depending on the type of disc previously played and the type of disc currently loaded.

Convenient functions

Auto power ON

- When power is switched OFF, to eject the disc table, press the OPEN/CLOSE button ▲ on the front panel. Power is automatically switched ON for you, and the disc table comes out.
- If you switch power OFF when a disc is loaded, just pressing the PLAY button ► on the front panel or the PLAY button ► on the remote control automatically switches power ON, and starts play of the loaded disc.

Tips

- DVDs that do not have the matching region No. that allows playback can not be played back (refer to the "Terms" section on page 76).
- DVD discs other than DVD Video discs cannot be played.
- When you switch power to this product ON, it switches to the KARAOKE MODE, and the KARAOKE MODE button lights.

Playing Video CDs (with PBC)

What's a Video CD?

It's a disc that delivers the MD sound quality and VHS picture quality. Thanks to digital signal compression technology (MPEG system), you can enjoy up to 74 minutes of continuous video and audio from a single disc. There are two kinds of Video CD. To control Video CD play, one kind of disc (Version 2.0) features a Playback Control signal (hereafter referred to as PBC). The other kind of disc (Version 1.1) does not feature a recorded PBC signal.

| | |
|---|--|
| Video CD with no PBC (Version 1.1) | Video and audio play is possible with same operations as a CD. |
| Video CD with PBC (Version 2.0) Menu display | <ul style="list-style-type: none"> Using on-screen menus enables easy play of interactive software and software with reference functions. You also get high-resolution video and still picture capability. You can enjoy these discs in the same way as discs with no PBC (Switch PBC OFF with the PLAYBACK CONTROL button on the main unit or remote control.) |

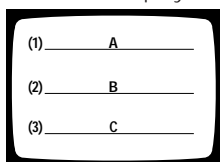

This product enables PBC play using the number, ENTER, Next ►►, Previous ◀◀, and RETURN ↻ buttons. (All operations are possible by remote control)

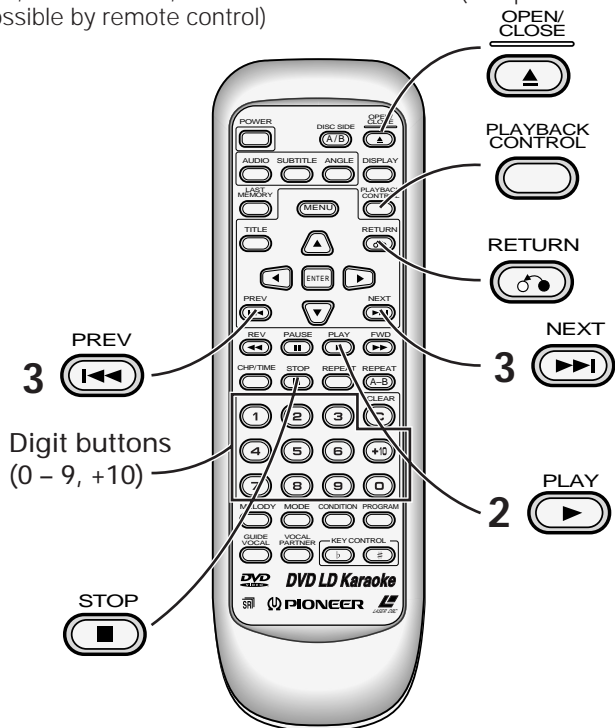

Note

- ◆ **NOISE REDUCTION** button on the main unit
You can use the noise reduction function with Video CDs. It reduces noise on badly recorded discs for a clearer picture. Press the button and it lights, indicating the function is operating. Press again to switch the button light OFF, and cancel noise reduction.

To playback (Video CDs with PBC)

1 Perform steps **1** through **4** on page 13.

2 Press the **PLAY ►** button.

- With Video CDs that have playback control, **PBC** is displayed, and a menu.
- Menus are recorded on discs. Menu displays differ with each disc.

Ex) Menu display

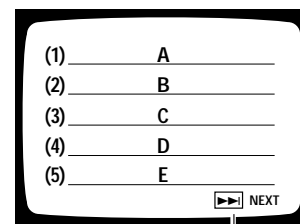

When there's another menu

3 When there's a following menu

Press the **NEXT ►►** button.

- To return to the previous menu

Press the **PREV ◀◀** button.

4 Select numbers in a menu using the digit buttons

- Playback starts.

Ex) To select 3 To select 10 →
To select 21 → →

To stop the player

- Press the **STOP ■** button.
- Press the **OPEN/CLOSE ▲** button.
- Press the **PLAYBACK CONTROL** button.
(In this case, playback control switches OFF, and the mode becomes that for playback of Video CDs with no PBC.)
With discs that have no PBC, play will not stop even if you press the **PLAYBACK CONTROL** button.

Playing Video CDs (with PBC)

Displays shown when the **PLAY** ►, **PREV** ◀◀, **NEXT** ▶▶, or **RETURN** ⌂ buttons are pressed.

Example of operation of a disc with PBC (Playback Control)

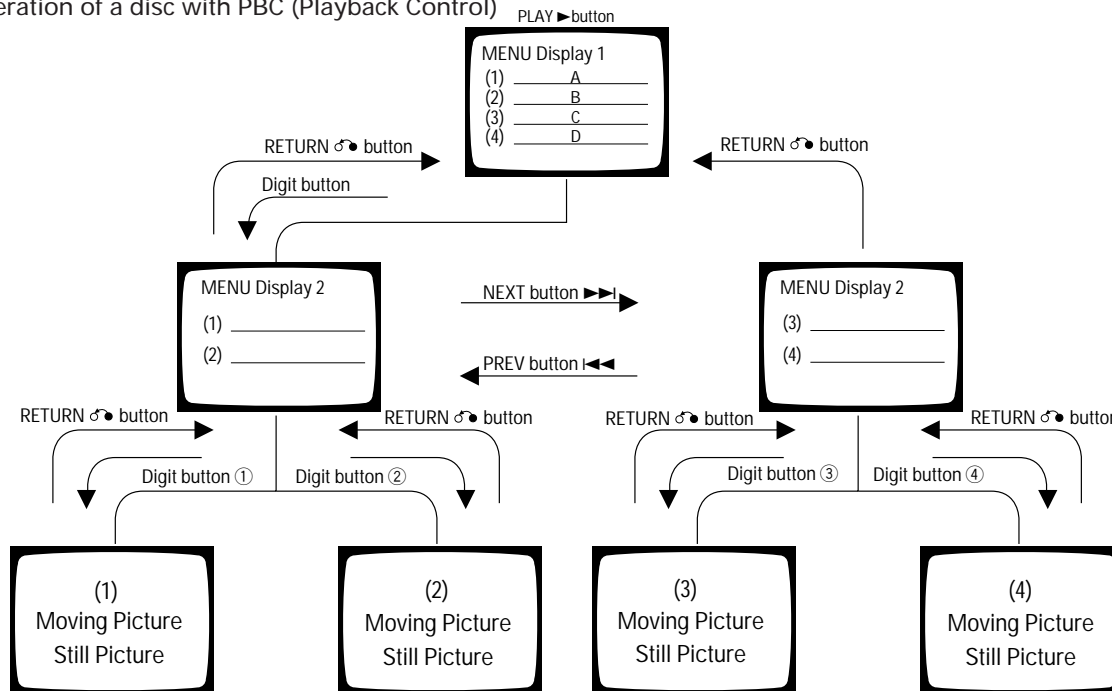

Menu operation

Ⓐ Press the **RETURN** button to move back to the previous menu.



- Each time you press the button, you move back a menu. If you repeat pressing the button, you will eventually return to the first menu.

Ⓑ Press the **▶▶** button to move to the next menu, or the **◀◀** button to move to the previous menu.



Ⓒ Press the **PAUSE** button to pause video play.



- To cancel pause, press the **PAUSE** button once more.

You can play Video CDs without using menu displays

① Press the **PLAYBACK CONTROL** button.

- The **PLAYBACK CONTROL** indicator on the front of the player goes out.

② Press the **PLAY** button, or select using digit buttons.



Example) To select 10 → →

To select 21 → →

The following are functions that do not operate when using menu operation with a Video CD that has PBC. (When **PBC PLAY** is lit in the display window)

- **SINGLE PLAY** (P.29)
- **Track Skip Forward/Skip Back** (P.16)
- **Reservation** (P.38)
- **Repeat** (P.24)

Chapter (Track) Skip Forward/Skip Back

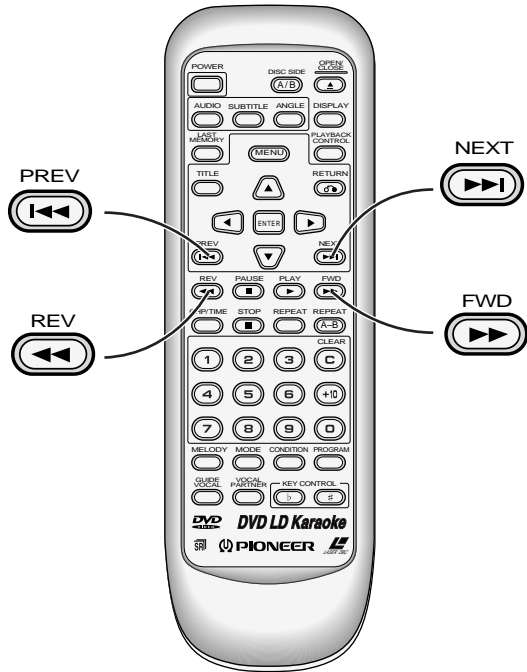

Skipping forward to the next chapter (track)

NEXT
 Press the NEXT ►► button.

- Moves you ahead to the chapter (track) with the number equivalent to the number of times you pressed the button.

Skipping back to the previous chapter (track)

PREV
 Press the PREV ◀◀ button.

- Press once to skip back to the start of the chapter (track) currently playing.
- Press again to skip back to the start of the previous chapter (track).

Fast forward to a desired location

FWD
 Press the FWD ►►► button.

Fast return to a desired location

REV
 Press the REV ◀◀◀ button.

Note
 ♦ With LDs (CLV), when you perform FWD ►►► or REV ◀◀◀ operation, there may be no color but this does not mean the player is malfunctioning.

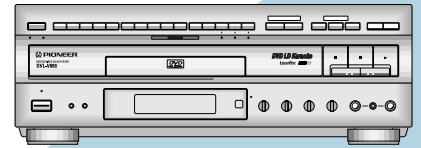
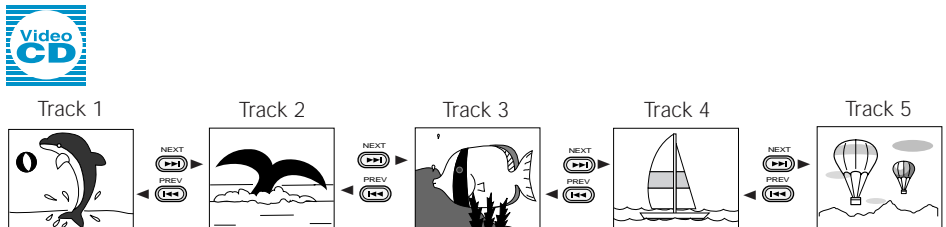
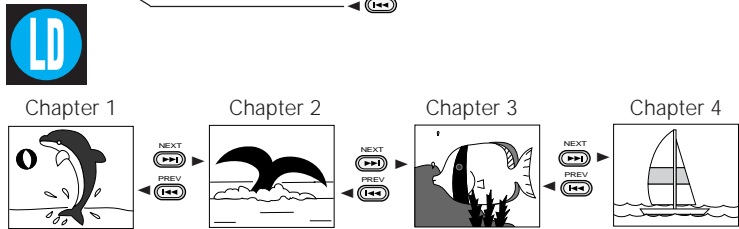
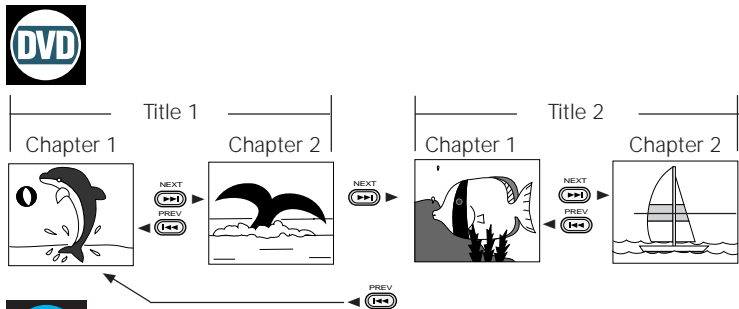

Stopping Playback & Switching Power OFF

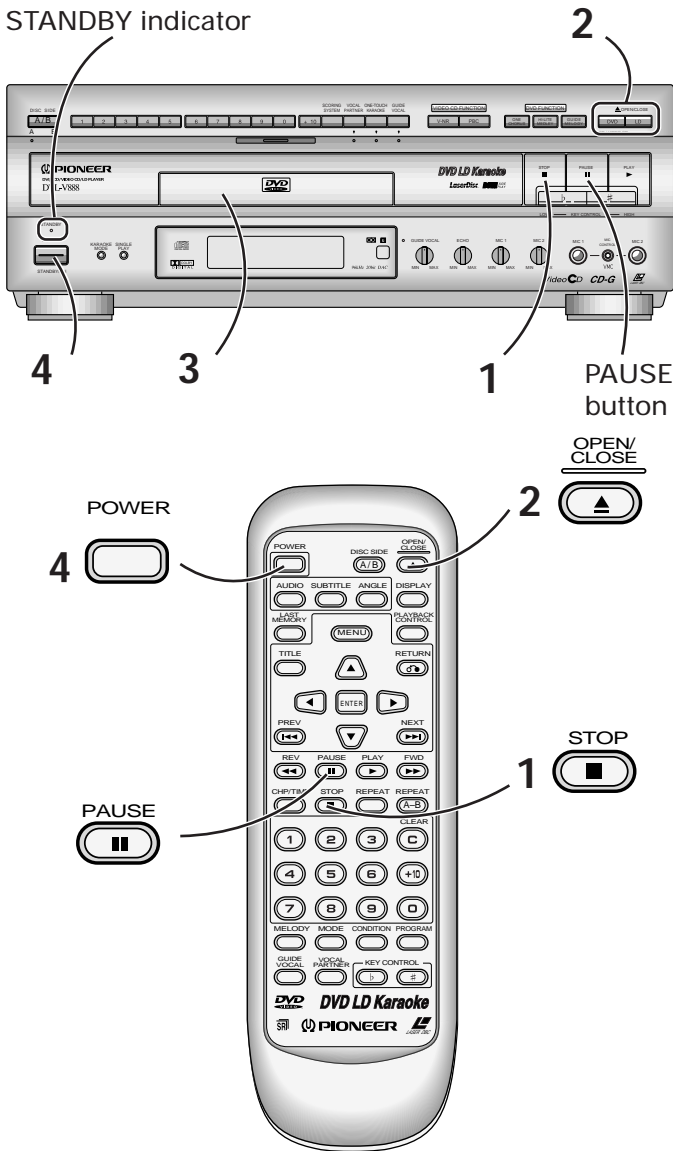

1 Press the STOP ■ button.



- Playback stops.

2 Press the OPEN/CLOSE ▲ button.

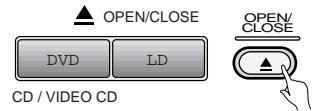

- The disc table comes out.

3 Remove the disc.

When removing a DVD/CD When removing an LD

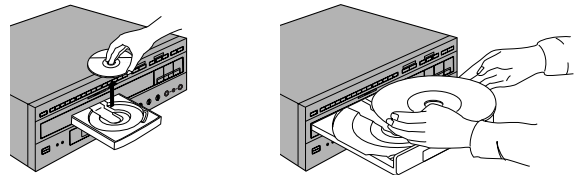

4 Press the POWER button.

Indicator lights → STANDBY POWER



- The disc table goes back in, power switches OFF, and the STANDBY indicator lights.

Pausing play

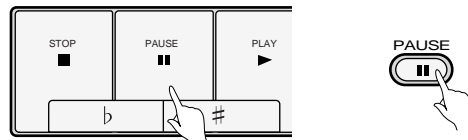

Press the PAUSE button. There's no sound, and PAUSE appears in the display window. Press the PAUSE button again to restart play.

- With DVDs, LDs (CAV only), and Video CDs, pressing PAUSE gives you still picture display (P.25).

Notes

- ◆ You can watch a DVD or LD part way through, eject it, and then when you load it again, start watching from where you left off. For details, refer to "LAST MEMORY" on page 18.
- ◆ When moving the unit, be sure to follow the instructions on page 77 (WHEN MOVING THE UNIT).



Continuing Playback from where you Stopped

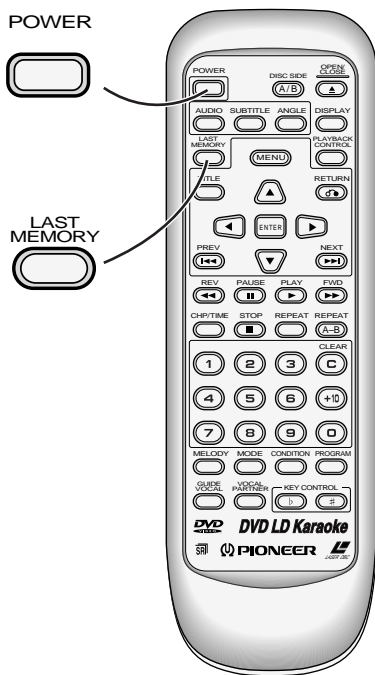

Memorizing the place where you stopped watching (LAST MEMORY)

1 Press the **LAST MEMORY** button during play.

- "LAST MEMORY" indication is displayed and the place is memorized.

2 Press the **POWER** button to switch power OFF, or press the **STOP** button to stop playback.

- With DVDs, even if you eject a disc, the location where play stopped is memorized.

Resuming playback from where you stopped

1 Press the **LAST MEMORY** button during **STOP**.

- With DVDs, operation is possible even while the title menu is displayed.
- When power is switched OFF, if you press the LAST MEMORY button, power is automatically switched ON, and play starts from the point at which you stopped watching.
- When LAST MEMORY is displayed, play resumes from a little before the point at which you stopped watching.

Tips

- With DVDs, LAST MEMORY memorizes ASPECT, audio, POSITION(Wide/Normal), Cinema mode/Animation mode, and other settings as well as the place where playback stopped.
- Even with a disc you have memorized with LAST MEMORY, playback begins at the start of the disc if you press the PLAY button.
- When you continue playback from the point where you stopped, LAST MEMORY is automatically canceled for that disc.
- If you register more than five DVDs in LAST MEMORY, details of the latest disc are memorized, while details of the least recent disc (the disc you registered first) are erased.
- If you eject an LD or Video CD, memorized details are erased.
- With DVDs, LAST MEMORY may not function with certain titles.

Notes

- ◆ If there is a power outage or you disconnect the power cord while the player is operating, LAST MEMORY settings cannot be memorized.
- ◆ Resuming play is not possible with CDs.
- ◆ During Video CD PBC play(P.14), LAST MEMORY play may not be possible.

STOP button

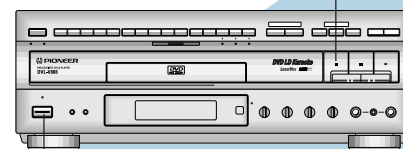

POWER button

Detailed Operation

| | |
|---|----|
| Playback by Menu Selection | 20 |
| Playing Back CD Graphics | 21 |
| Searching for a Desired Video Scene/Audio Track (Search) | 22 |
| Repeat Play | 24 |
| Still Frame | 25 |

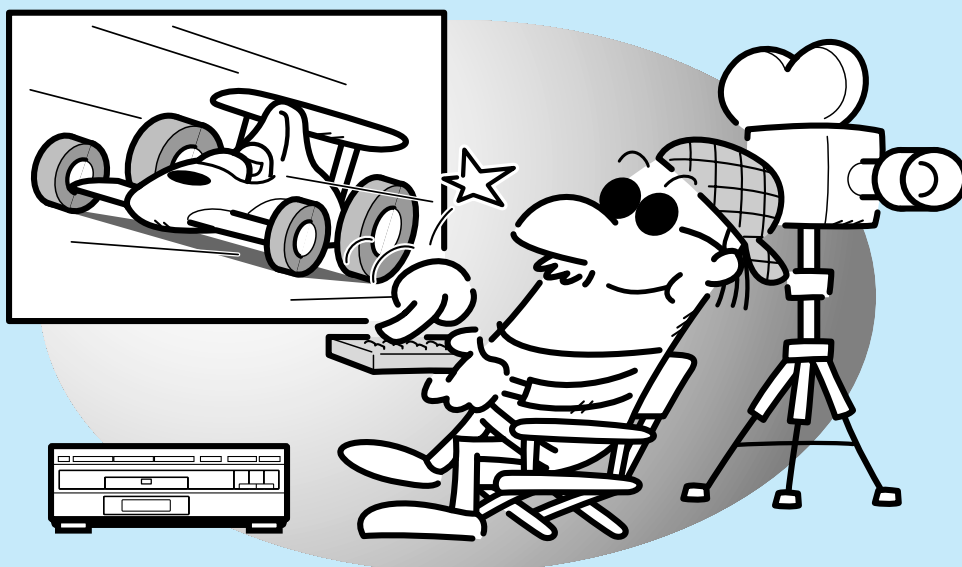



Playback by Menu Selection

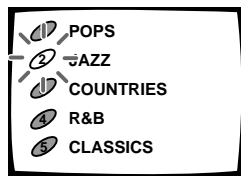

DVDs and Video CDs, depending on the disc, feature selection menus. This player lets you choose a desired title or track by selecting from a menu.

Playing Back from Menu Display

Returning to Menu Display during Playback

1 Press

- A menu is displayed. This menu is recorded on the disc. Menus differ depending on the disc.
- With Video CDs that have Play Back Control (P.14), PBC is indicated in the display window.

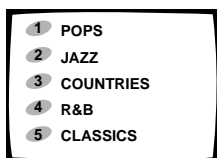

2 Title (track) selection with the digit buttons.

- When selecting a number higher than 10, use the button.
 - When selecting 10, press →
 - When selecting 17, press →
 - When selecting 20, press → →
- The selected title or track starts playing.
- With DVDs, you can also select numbers with the and buttons and then press .



In case of DVDs

1 Press

2 Press

- Press again for a menu of title contents. Perform menu operations following instructions provided in the menu, or those in the disc's instructions.(P.53-P57)

In case of Video CDs

1 Press

- Pressing the button during the PBC play shows the menu.

Tips

- You can play Video CDs without using menu displays. Press the PLAYBACK CONTROL button on the main unit or remote control to switch "PBC" OFF.
- Depending on the title, you can also make a selection using a menu. To do this, press the button when indications are displayed to call up a menu, and select the desired title.

Notes

- ◆ When playing a Video CD with a menu displayed, you cannot use Reserve play, Repeat play, and Track/Time Search functions. This is because interactive operation using the menu is possible.
- ◆ With Video CDs when PBC is ON, player operation differs depending on the disc. For details, read the instructions that come with the disc.
- ◆ With DVDs, menu indications may not be displayed.



Playing Back CD Graphics

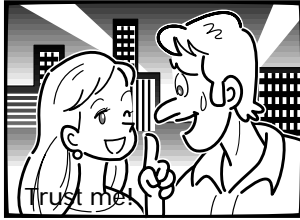

Video and audio information is recorded in different areas on a disc. There's also a subcode area where information such as subtitles and song lyrics can be recorded. Graphics refers to the reading of the signals in this area, and their display.

CD graphics discs bear the **GRAPHICS** mark. You can enjoy graphics when playing discs bearing this mark.

1 Press .

- The STANDBY indicator goes out.

2 Press the .

- The disc table comes out.

3 Load a CD graphics disc.

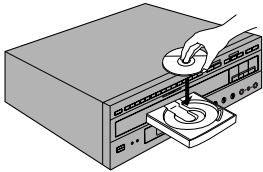

- Load a disc with the label side facing up, using the disc table guide to align the disc.

4 Press button.

- Playback starts.
- Even if the graphics mode is switched OFF, when you play a CD graphics disc, the graphics mode is automatically switched ON, and graphics are displayed.

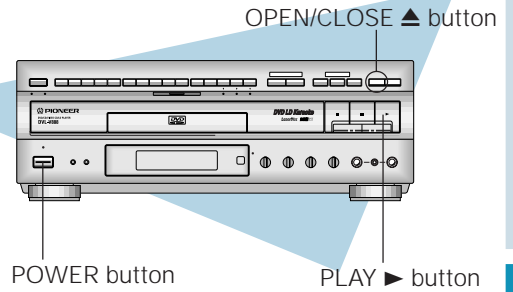

Switching graphics ON

5 Press .

- The mode changes as follows.

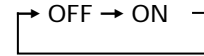

Switching graphics OFF

- When graphics is ON, press .

Notes

- ◆ **There should be graphics but...**
If you play CD graphics discs with the graphics mode switched ON, and still no graphics are displayed, the problem could be due to inappropriate graphics channel setting, or because the graphics display is in the wrong position on the screen. Refer to pages 46 and 47.
- ◆ When playing a disc with no graphics recorded on it, in rare cases erroneous graphics may be displayed, but this does not mean the player is malfunctioning. When playing discs without recorded graphics, be sure to switch the graphics mode OFF.

Tip

During playback of CD graphics discs, performing the following operations may result in missing subtitles and picture and subtitle color changes, but this is not a malfunction. Wait a little, and normal graphics display resumes.

- Fast forward/reverse
- Pause, Search
- Switching graphics ON on the graphics control display
- Displaying a menu



Searching for a Desired Video Scene/Audio Track (Title Search) Part 1

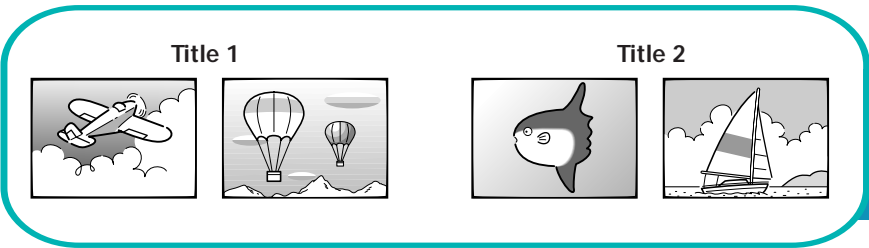

Direct Search with Title Numbers

1 Selecting title numbers directly with the digit buttons.

- When selecting title number 3, press **3**.
- When selecting title number 10, press **+10** → **0**.

You can also select a title in these 2 ways. (Method 1)

1 Press **TITLE**.

- Title number flashes on screen.

2 Press **TITLE** again.

- Continue pressing until you reach the desired number.

3 Press **PLAY**.

- Playback of the selected title starts.

(Method 2)

1 Press **TITLE**.

2 Select title numbers with the digit buttons.

- When selecting title number 5, press **5**.
- When selecting title number 10, press **1** → **0**.

3 Press **PLAY**.

- Playback of the selected title starts.

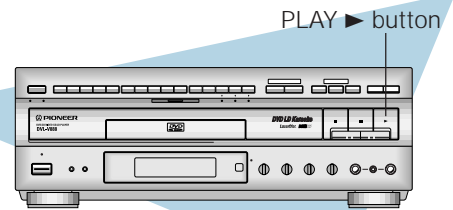

Search with Menu

1 Press **TITLE**.
(Operates during play only.)

2 Press **MENU**.

- Title menu is displayed.
- May not be displayed with some discs.

3 Select a title number using **UP**/**DOWN** buttons.

- You can also make a direct selection using the number buttons. Your selected title soon starts playing.

4 Press **ENTER**.

- Playback of the selected title starts.

Notes

- ◆ With some karaoke DVDs, songs are identified by chapter instead of by title. To select songs with this kind of disc, use Chapter Search (refer to "When the Chapter/Track number is high" on p.23). Perform direct Title Search using the digit buttons on the player or the remote control. (Refer to p.16 for details concerning Title and Chapter.)
- ◆ With certain DVDs, search operation may stop. In this case, the mark appears.
- ◆ Depending on the disc, menu may not be displayed.

Chapter 1



Chapter 2



Chapter 3



Chapter 4



Searching for a Desired Video Scene/Audio Track (Chapter/Track Search) Part2

Three ways to search a DVD or Video CD; normal search, direct search and time search are possible. For CD, direct search only is possible.

Four ways to search an LD; normal search, frame search (CLVs only), direct search and time search are possible.

Chapter Number Search (Normal Search)

Direct search using the digit buttons

Example 1: To select chapter/track number 3, press **3**.

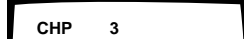

Example 2: To select chapter/track number 17, press **1** → **7**.

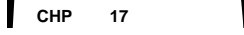

- With DVDs, it becomes Title Search. Refer to "Searching for a Desired Video Scene/Audio Track (Title Search) Part 1" in page 22.

When the Chapter/Track number is high

1 Press **CHP/TIME**.

- Chapter/Track number flashes.
- With DVDs, it becomes Title Search. Refer to "Searching for a Desired Video Scene/Audio Track (Title Search) Part 1" in page 22.

2 Specifying Chapter/Track numbers with the digit buttons.

Example 1: Selecting Chapter/Track 31 press **3** → **1**.

Example 2: Selecting Chapter 187 press **1** → **8** → **7**.

3 Press **PLAY**.

- The selected Chapter/Track starts playing.

Notes

- ◆ Time Search is not possible with CDs.
- ◆ With DVDs, Search may not be possible with certain titles. In this case, the mark is displayed.
- ◆ When performing DVD or Video CD Time Search, playback may start from a slightly different time than that specified.
- ◆ When a DVD is not playing (in the STOP mode), Time Search is not possible.
- ◆ During Video CD PBC play, search operations described above are not possible.

Tips

- To clear Title or Chapter/Track/Time/Frame indications when they are flashing, press the CLEAR button twice.
- Depending on the title, you can also make a selection using a menu. To do this, press the **MENU** when indications are displayed to call up a menu, and select the desired title.



Chapter Number Search with Menu

You can perform this with DVDs only.

1 Press **CHP/TIME**.

- When in the Stop mode, proceed to step **3**.

2 Press **MENU**.

- Chapter menu is displayed.

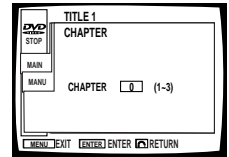

3 Make a selection following on-screen indications.

- With certain titles, there may be no menu display. In this case, perform the operations described at left.

Time Number Search/Frame Number Search

1 Press **CHP/TIME** twice.



- With DVDs or LDs that have no chapters, time is displayed after pressing the button once.

2 Select the desired time number/frame number with the digit buttons.

Example 1: To select 21 minutes 43 seconds, press **2** → **1** → **4** → **3**.

Example 2: To select frame number 4321, press **4** → **3** → **2** → **1**.

- With DVDs, you cannot search for chapters that overlap titles.

3 Press **PLAY**.

- Playback starts from the selected elapsed play time or selected frame.

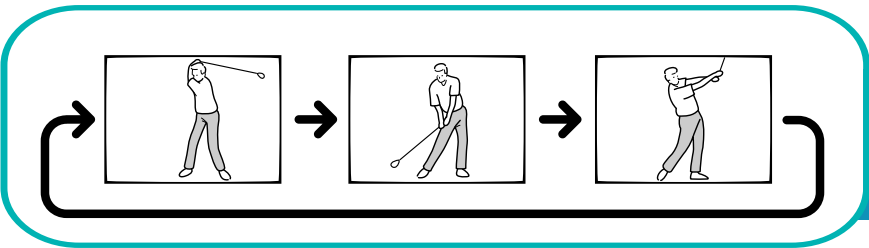

Repeat Play

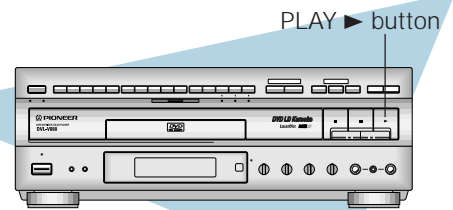

PLAY button

Repeat play of a chapter/track

Press **REPEAT** once during playback of the chapter or track you want to repeat.

Repeat play of a title

Press **REPEAT** twice during playback of the title you want to repeat.

- With DVDs, the title continues playing until the end, and then playback starts once more from the beginning of that title.
- With DVDs, Repeat play within the same title is possible.
- With CDs and Video CDs, the entire disc is repeated.
- With LDs, a single side is repeated.

Repeat play of double-sided LDs

Press **REPEAT** three times.

- Both sides are repeated, starting on Side A.

To Cancel repeat play

Press **CLEAR**.

- The Repeat play mode is canceled, but playback continues.
- With DVDs, everything in the same title is repeated.



Repeat play of a specified section.

Press **REPEAT (A-B)** at the beginning and end of the section you want to repeat.

Return to a specified location

1 Press **REPEAT (A-B)** at the desired location.

2 When you want to return to the selected location, press **PLAY**.

- Press **CLEAR** to clear a specified location.

Notes

- ◆ With DVDs, Repeat play may not be possible with certain titles. In this case, the mark is displayed.
- ◆ With Video CDs, Repeat play is not possible when a menu is displayed (during PBC operation). To perform Repeat play, press the PLAYBACK CONTROL button on the main unit or the remote control to switch "PBC" OFF.

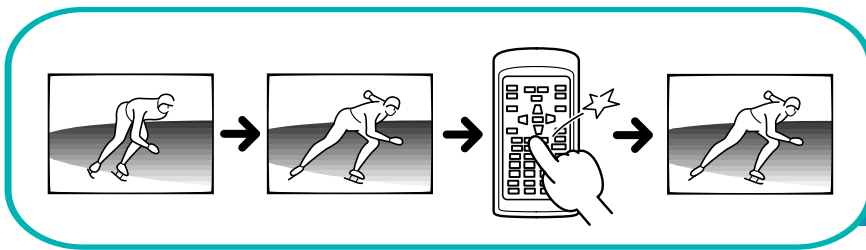

Still Frame

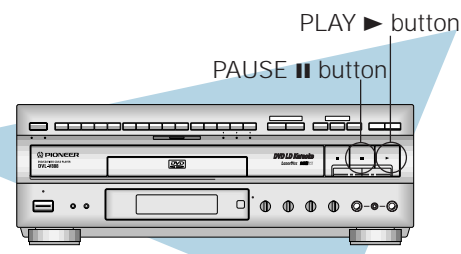

Basic Operation

Detailed Operation

Karaoke Operation

Setting

Set Up

Other Information

Viewing a still frame

Press .

- Press the PAUSE button on the front of the player.



To return to normal playback

Press or .

- Press the PLAY button or PAUSE button on the front of the player.

Tip

- With LDs, this operates only with CAV discs.

Notes

- ◆ There is no sound when viewing still frames.
- ◆ Pause may not be possible with certain discs. In this case, the mark is displayed.
- ◆ With LDs, play automatically stops if still frame display continues for 20 minutes.



Karaoke Operation

| | |
|---|----|
| Karaoke Entertainment | 28 |
| SINGLE PLAY/Creating singing venue atmosphere | 29 |
| Karaoke with connected external components | 29 |
| Adjusting to Create the Desired Sound | 30 |
| Echo adjustment | 30 |
| Changing performance key | 30 |
| Operation is possible with the mic | 30 |
| Convenient Function for Practicing Karaoke | 31 |
| Guide Vocal | 31 |
| DUET MODE/CHORUS MODE | 32 |
| VOCAL PARTNER/ONE-TOUCH KARAOKE | 33 |
| SCORING Grades Your Singing Ability | 34 |
| Simultaneous Scoring for Two Singers (COMPETITION) | 36 |
| Consecutive Play of Song Highlights (HI-LITE MEDLEY) | 37 |
| Reserving a Desired Song | 38 |
| One Verse Chorus Play Only (One Chorus) | 39 |
| Sing with Professional Karaoke (GUIDE MELODY) | 39 |

Karaoke Entertainment

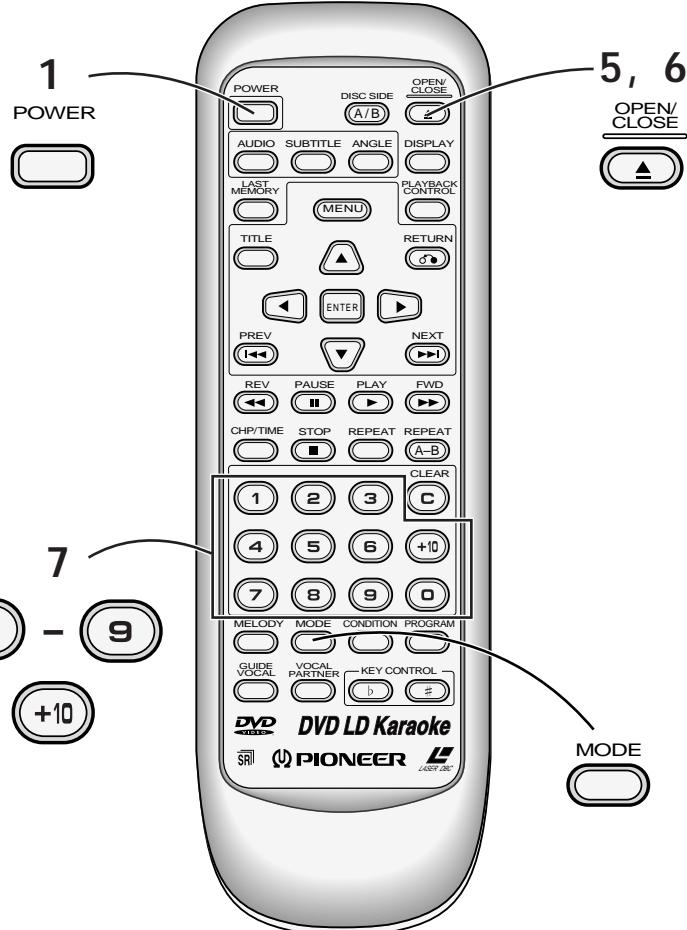
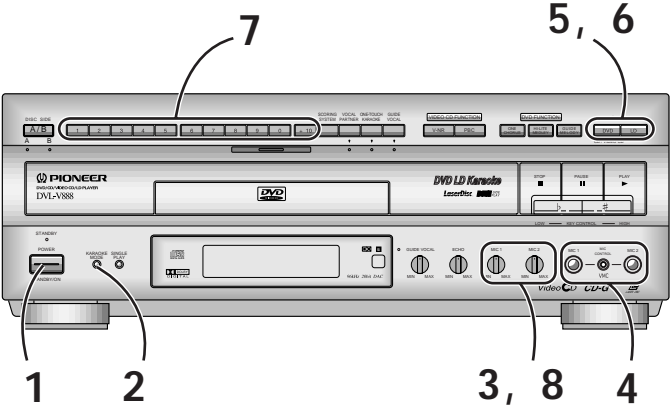

Let's sing!!

1 **POWER** Press the POWER button.



STANDBY/ON

- The KARAOKE MODE button lights, and the mode becomes KARAOKE.

2 **KARAOKE MODE** Press the KARAOKE MODE button to switch the KARAOKE MODE ON.



Each time you press the button, the setting changes as follows.

```

    graph LR
      A[KARAOKE MODE] --> B[NORMAL MODE]
      B --> C[AUX INPUT MODE]
      C --> A
    
```

- When the KARAOKE MODE button lights, skip this step.

3 Set Mic 1 and Mic 2 volume level knobs to "Low".



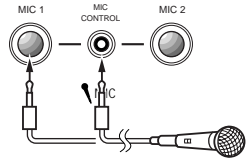

4 Connect the mics, and switch ON.



5 Press the OPEN/CLOSE button.

- The disc table comes out.

CD / VIDEO CD

- Load a disc.
- When loading a DVD/CD/Video CD
- When loading a LD





6 Press the OPEN/CLOSE button.



- The disc table goes back in.



CD / VIDEO CD

7 Select desired songs using the digit buttons.

(Example) Track 3 , track 21   

Remote control operation

(Example) Track 3 

Track 21  →  → 

Tip

After opening and closing the LD disc table, or after playing an LD, you can press the OPEN/CLOSE button on the remote control to eject (open) the LD disc table.

Karaoke Entertainment

8 Turn the Mic volume level knob to adjust volume level.



- Adjust overall volume level with the TV or amp.



Note

- During PBC play of Video CD with PBC (see page 14), after performing steps 1 through 6, press the Play button, and then perform step 7.

Tips

Howling

If sound from the speakers is picked up by a mic and output again through the speakers, the result is a screeching sound known as "howling". Perform the following steps to eliminate howling.

- Move the mic away from speakers.
- Turn the Mic volume knob counterclockwise to lower the volume level.
- Turn the Digital Echo level knob (P.30) counterclockwise to lower the echo level.

Display between songs

(With DVDs, CDs, LDs, and Video CDs.)

When in the KARAOKE MODE (when the KARAOKE MODE indicator on the front panel is lit), during pause or when a disc has stopped playing, karaoke bird characters are displayed.

When no discs loaded

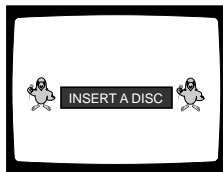

Notes

- With DVDs, some discs may have a Menu function. With this kind of disc, since operations are in line with menu selections, there is no SINGLE PLAY mode, and no entertaining display between songs.
- When playing a Video CD with Playback Control ON (see page 14), you cannot select the SINGLE PLAY mode.

Stopping a song

When the KARAOKE MODE is selected (the KARAOKE MODE indicator lights), play pauses after a selected song finishes. Press the SINGLE PLAY button (the SINGLE PLAY button indicator goes out), and play continues even after a song finishes, without stopping or pausing.



Press the SINGLE PLAY button.

- The SINGLE PLAY mode is ON when the indicator is lit.
- The Continuous play mode is ON when the light is out.

Tip

When the input switch function is set to "NORMAL" and "AUX INPUT MODE", the mode becomes Continuous play.

Creating singing venue atmosphere

- During play in the KARAOKE MODE, press  to select KARAOKE SURROUND.

- Select the desired ambience setting with the   buttons.

The setting changes as follows.

OFF ↔ STUDIO ↔ HALL ↔ ARENA

For details refer to page 45.

Karaoke with connected external components

- Press the KARAOKE MODE button to switch the AUX INPUT MODE ON.



Each time you press the button, the setting changes as follows.

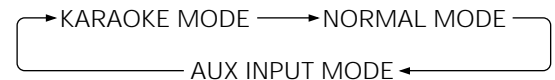

- The KARAOKE MODE indicator and the AUX indicator in the display window lights.

- Connect mics, and switch ON.

- Start play on the externally connected component.

- Adjust Mic 1 and Mic 2 volume levels to assure there's no howling.



Adjusting to Create the Desired Sound

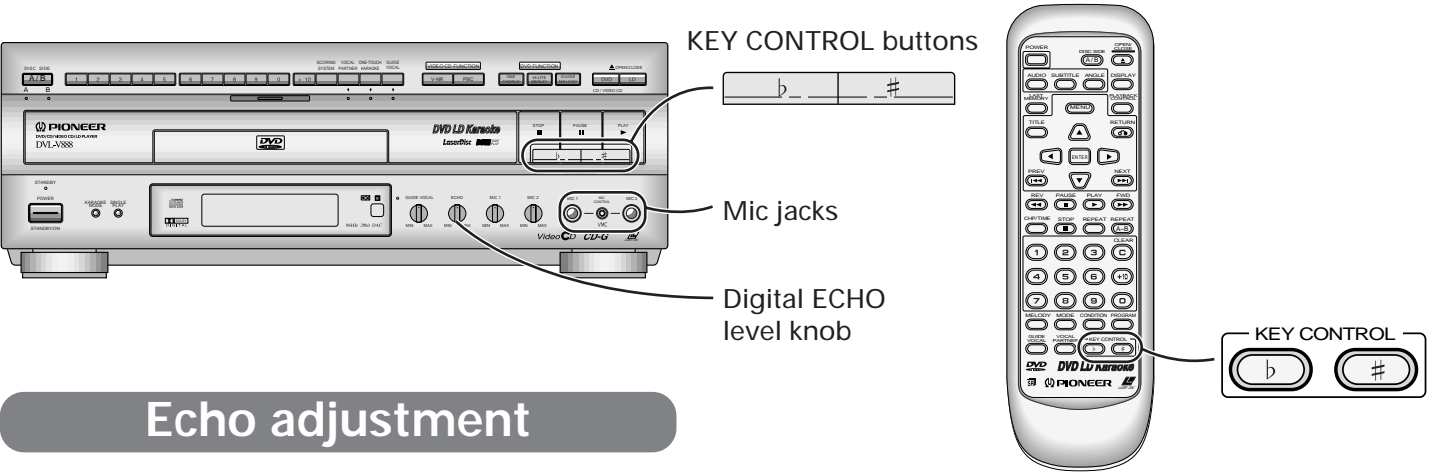

Echo adjustment

Adjust with the Digital Echo level knob.

Tip



Depending on the room, there may be howling if the echo level is too high (see page 29).

Tip

Echo... This provides an echo effect.

Changing performance key

Press a KEY CONTROL button.



Each button can be used to lower or raise the key in 5 steps.

Low — Key control — High

Low: The key is lowered
High: The key is raised

Tips

- When you play song to the end, or if you press the STOP button during play, the key returns to the standard setting. However, with certain discs, this may not happen. (When displaying a DVD disc menu)

Operation is possible with the mic

You can operate Key control and Once more.

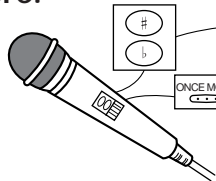

Functions in the same way as the KEY CONTROL button on the main unit.

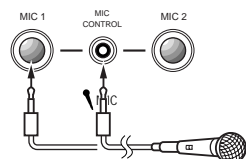

- You can perform these operation with the separately sold DM-920 and DM-820. Refer to the mic's User's Manual for details concerning Key control operation.
- Operation with the mic cannot be performed when the mic is not connected to the Mic control jack.

Tips

- Once more
- Each time you press this during play, you move back a little from the point you are in the song and the video.
 - You can use this to repeat difficult sections in songs you are singing for the first time.
- Once more operation may not be possible with some discs.

Convenient Functions for Practicing Karaoke

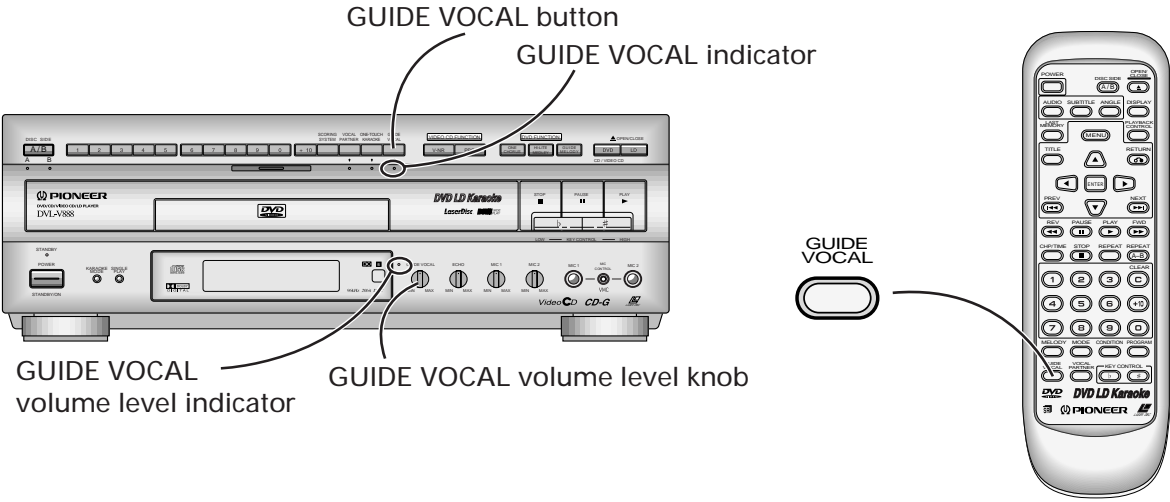

Guide Vocal

With multiplex discs, you can practice karaoke with or without a guide vocal.

<With multiplex karaoke laser discs>

Press the GUIDE VOCAL button.

- When the indicator above the GUIDE VOCAL volume level knob is lit, turn the knob to adjust GUIDE VOCAL volume level.
- To switch OFF, press until the light goes out.

<With multiplex karaoke Video CDs, CD-G's, CDs, and external sources>

Press the GUIDE VOCAL button twice.

- When indicator above the GUIDE VOCAL volume level knob is lit, turn the knob to adjust GUIDE VOCAL volume level.
- To switch OFF, press until the light goes out.

Tips

- The guide vocal is output through the right speaker.
- Guide vocal is not output.
- Guide vocal volume adjustment is not possible even when the GUIDE VOCAL indicator is lit.

If this happens, press the GUIDE VOCAL button once more. You will then be able to use the GUIDE VOCAL volume level knob. Pressing the GUIDE VOCAL button has no effect if the disc you are playing does not have a guide vocal recorded on it (it must be a multiplex disc). With this kind of disc, do not press the GUIDE VOCAL button.

Tips

Concerning the Guide vocal
 With LDs (multiplex, without TOC), CDs, CD-Gs, external sources, and Video CDs, the mode changes each time you press the button as follows.

OFF → Stereo → Multiplex

With non-digital audio sources or LDs with a TOC, the mode changes each time you press the button as follows.
 When Quick Turn is ON, switching is the same as above with discs that have a TOC.

OFF → Stereo or Multiplex

What is TOC
 Refer to the glossary on page 75.

Basic Operation
 Detailed Operation
 Karaoke Operation
 Setting
 Set Up
 Other Information



Convenient Functions for Practicing Karaoke

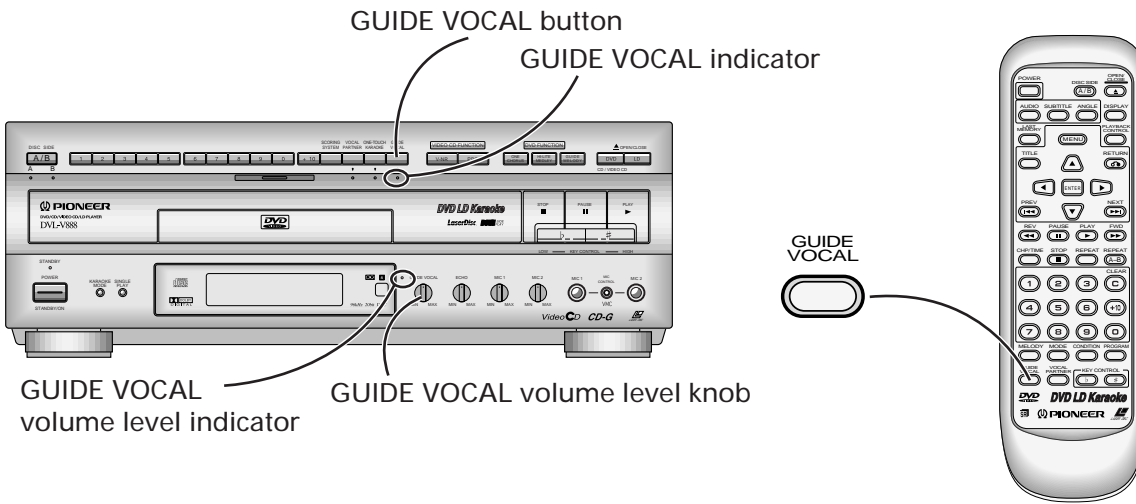

Guide Vocal

With multiplex discs, you can practice karaoke with or without a guide vocal. You can enjoy everything from practicing parts of songs to singing a duet alone, and harmony parts only. All this and more with Dolby Digital multiplex compatible DVD karaoke discs.

<With DVDs>

Press the GUIDE VOCAL button

Lit →

Lower MIN MAX Higher

- When the indicator above the GUIDE VOCAL volume level knob is lit, turn the knob to adjust GUIDE VOCAL volume level.
- If the disc provides only Guide vocal 1(or 2), switching is between ON and OFF.
- Some discs have Guide vocal 1 and Guide vocal 2 recorded on them. The selected vocal changes each time you press the button as follows.

| Guide Vocal Selection | Display |
|-----------------------|-------------|
| ① Guide vocal 1 and 2 | (VOCAL 1&2) |
| ② Guide vocal 1 | (VOCAL1) |
| ③ Guide vocal 2 | (VOCAL2) |
| ④ Guide vocal1&2(mix) | (VOCAL MIX) |
| Off | (VOCAL OFF) |

Tip

- With vocals 1 and 2 in ①, Guide vocal 1 is output through the left channel, and Guide vocal 2 is output through the right channel. With the mixed vocals in ④, output of Guide vocals 1 and 2 is monaural.

Duets DUET MODE

Enjoy duets with songs on DVD discs bearing the mark.

Ex) With discs on which Guide vocal 1 is male vocal, and Guide vocal 2 is female vocal, you can enjoy duet with male vocal when you select guide vocal 1, and when you select guide vocal 2, you can enjoy duet with female vocal.

Karaoke with harmonies CHORUS MODE

Enjoy with this with DVD disc songs bearing the mark.

Ex) With discs on which Guide vocal 1 is a guide vocal, and Guide vocal 2 is a harmony vocal, if you select Guide vocal 2, the guide vocal is switched off, letting you enjoy karaoke with harmony.

- You can also use these functions with some songs that do not bear the above marks.

Convenient Functions for Practicing Karaoke

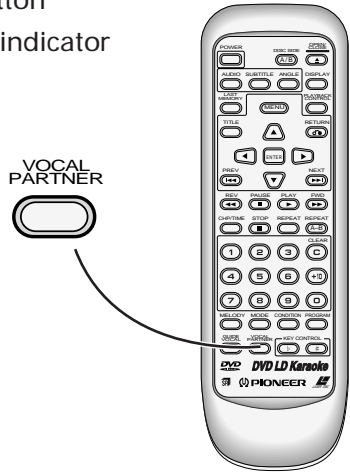
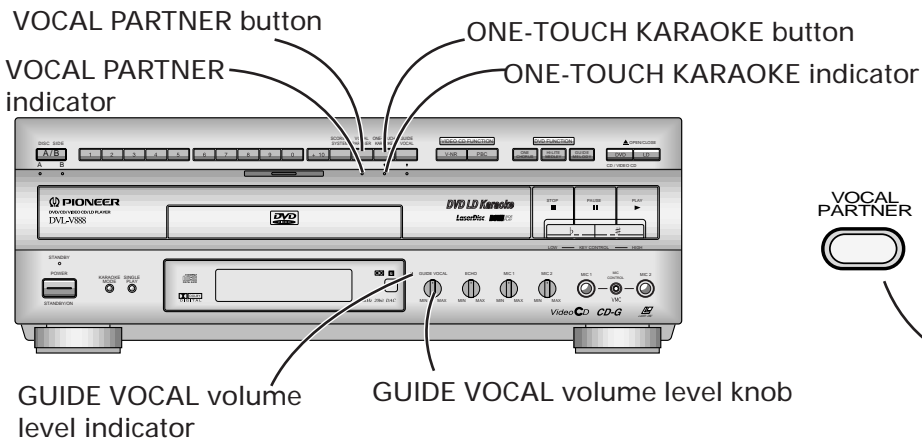

VOCAL PARTNER

With this function, when you sing, the recorded singer's voice cuts out. If you stop singing, the singer's voice cuts back in. This is a handy function when practicing new songs and duets alone.

<With DVDs, LDs (with TOC), and analog audio only LDs >

Press the VOCAL PARTNER button.

- To switch OFF, continue pressing the button until the indicator goes out.

<With multiplex karaoke Video CDs, CD-Gs, CDs and externally input tapes>

Press the VOCAL PARTNER button twice.

- To switch OFF, continue pressing the button until the indicator goes out.

Tips

- With some discs and tapes, even when you sing, the recorded singer's voice volume level does not decrease.
- When the indicator above the GUIDE VOCAL volume level knob is lit, you can turn the knob to adjust guide vocal volume level.
- With LDs (multiplex with no TOC), CDs, CD-Gs, externally input tapes, and Video CDs, the mode changes as follows when you press the VOCAL PARTNER or ONE-TOUCH KARAOKE buttons.

OFF → Stereo → Multiplex

- With non-digital audio sources or LDs with TOC, the mode changes as follows each time you press the button.

OFF → Stereo or Multiplex

- With DVDs, the VOCAL PARTNER function operates with the Guide vocal selected with One-touch Guide-vocal.

ONE-TOUCH KARAOKE

This lets you use regular DVDs, LDs, CDs, and tapes as karaoke software by reducing the volume of the recorded vocals. You can also use this function when you want to sing along with only multiplex CDs, CD-Gs, Video CDs, and externally input tapes.

<With DVDs and LDs>

Press the ONE-TOUCH KARAOKE button.

- To switch OFF, continue pressing the button until the indicator goes out.

<With Video CDs, CD-Gs, CDs, and externally input tapes>

Press the ONE-TOUCH KARAOKE button.

Each time you press the button, the mode changes as follows.

OFF → Stereo → Multiplex

- To switch OFF, continue pressing the button until the indicator goes out.

Tips

- This function may not be very effective with some discs and tapes.
- With karaoke discs and tapes (multiplex discs and tapes), when you can hear the guide vocal from the right channel, press the ONE-TOUCH KARAOKE button twice. You can cancel the guide vocal.

SCORING Grades Your Singing Ability

Enjoy the Scoring function(SCORING/COMPETITION) even with regular CDs (non-multiplex discs).

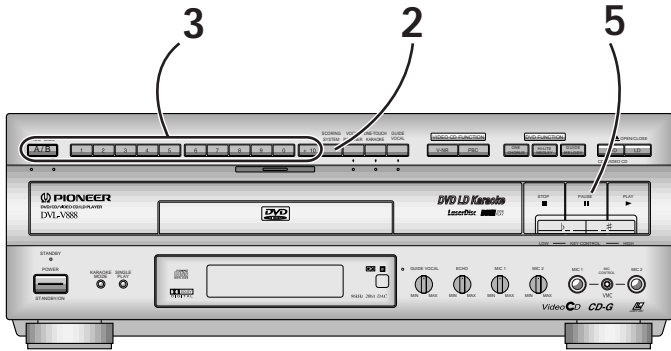

1 Complete steps **1** through **6** (see page 28) to perform settings for disc.

2 Press the SCORING SYSTEM button once.

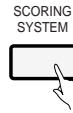

3 Select the desired song number with the digit buttons and DISC SIDE A/B button (LDs only).

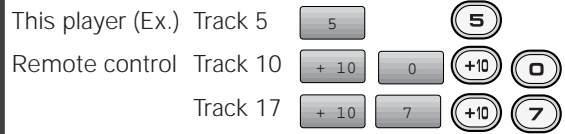

Remote control (Ex.) You can also select songs in this way with DVD.

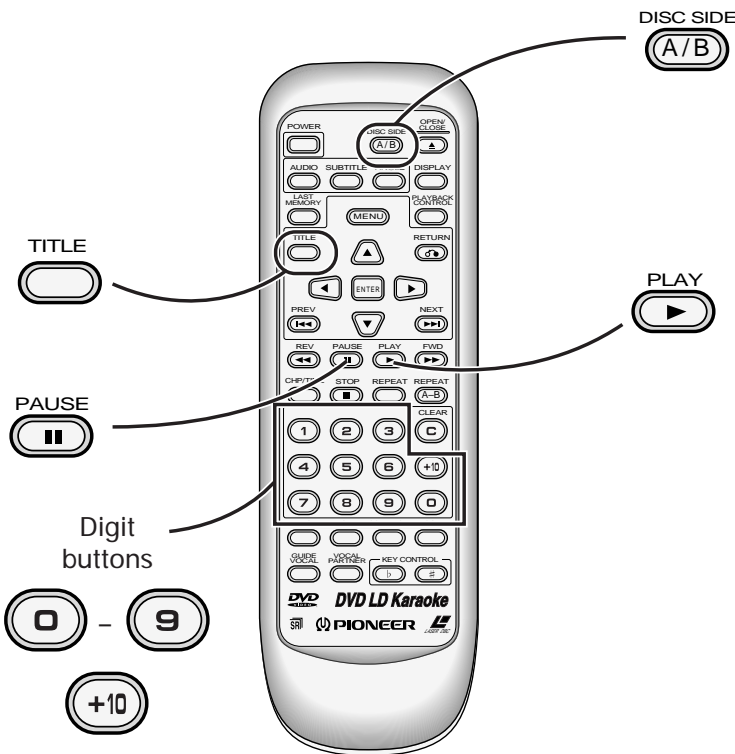
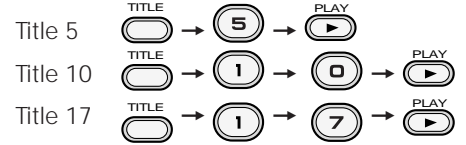

♪♪ Let's sing! ♪♪
(The song you want to sing starts playing)

4 After you have been singing for a minute or so, playback indications, the karaoke bird characters, and "SCORING" are displayed on the TV screen.

Tip

With LDs and CD-Gs, the karaoke bird characters, score and other indications are displayed in black and white.

SCORING Grades Your Singing Ability

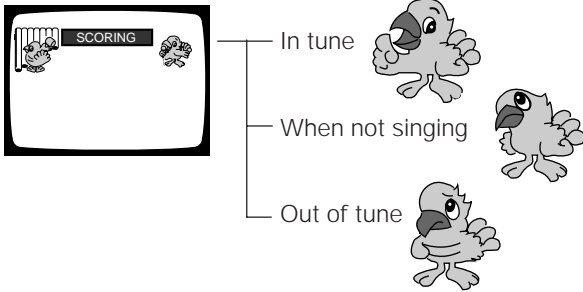

The karaoke bird character's expression changes to match each of the indications.

6 Returning to the regular KARAOKE mode

- Press the KARAOKE SYSTEM button on the main unit to select OFF.

→ SCORING → COMPETITION → OFF →

Tips

- When a score is being displayed, Play, Skip, Fast forward, and Fast reverse operation are not possible.
- With DVDs, audio becomes monaural. And when you select Guide vocal 1 and Guide vocal 2, both vocals are mixed and output through the left and right speakers.

Notes

- ◆ This function operates only when the mode is KARAOKE MODE.
- ◆ With some types of disc, some songs, and even some karaoke discs, accurate vocal key detection may not be possible, making it hard to achieve high scores. However, this does not mean the player is malfunctioning. When there is no vocal, (before a song, during silent passages etc.), if you sing, scoring will not be accurate. On the other hand, if you do not sing when there is a vocal, you will not lose any points.
- ◆ If you use SCORING or have COMPETITION with graphics compatible discs, graphics images and on-screen indications may overlap, depending on the disc. With LDs and CD-Gs, the karaoke bird characters, score and other indications are displayed in black and white.
- ◆ If you are using a projection TV, avoid using SCORING and COMPETITION for extended periods of time. This may lead to vacuum tube burn-in.
- ◆ With SCORING and COMPETITION, you cannot use the surround function.

5 Press the PAUSE button after finishing a song, and your score is displayed.



- Your score is displayed even if you press the PAUSE button during a song.

Tip

If you do not press the PAUSE button, scoring continues. When a song ends, be sure to press the PAUSE button.

If you achieve a new high score, there's applause.

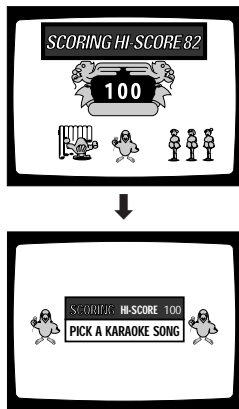

After a few seconds, you return to step 2. You can then repeat steps 3 through 5.

Tip

How are you scored?
As you sing into the mic, your voice is compared with the vocal recorded on the disc.

Tip

Accurate scoring is not possible with discs that do not feature a recorded vocal track.
The bell rings depending on how many points you score. (It doesn't ring if you get less than 59 points.)

Simultaneous Scoring for Two Singers (COMPETITION)

Enjoy the Scoring function(SCORING/COMPETITION) even with regular CDs (non-multiplex discs).

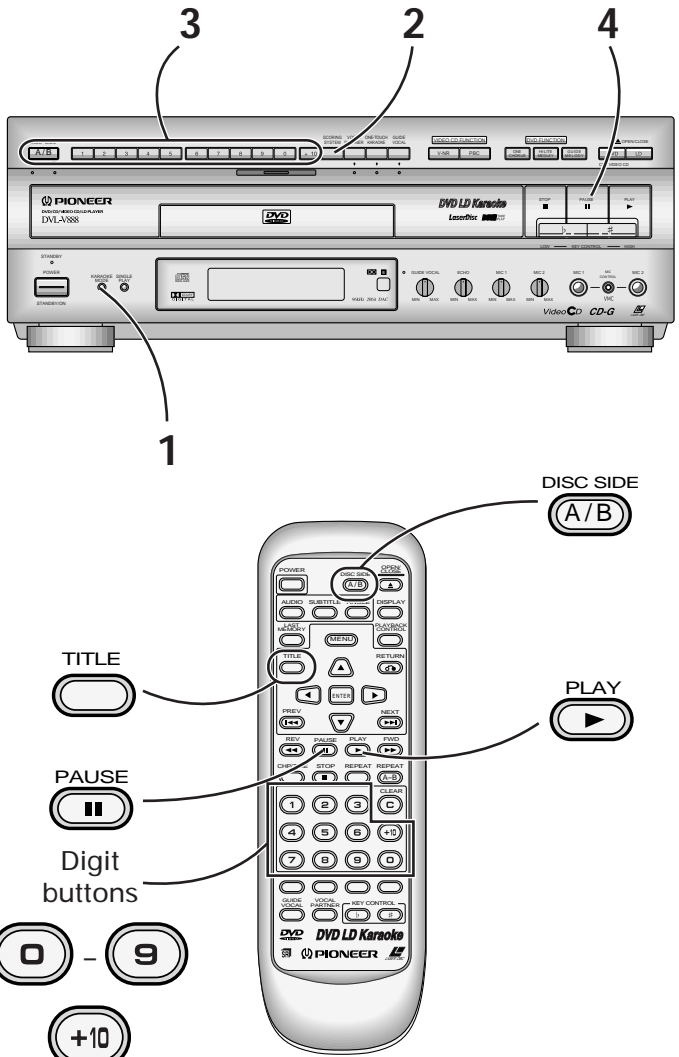

3 Select the desired song number with the digit buttons and DISC SIDE A/B button (LDs only).

♪♪ Let's have a singing competition! ♪♪
Play starts. (COMPETITION begins)

After you have been singing for a minute or so, playback indications, the karaoke bird characters, and scores are displayed on the TV screen.

Scores start from 5,000, with 100 points added or subtracted at a time.



Tip

With LDs and CD-Gs, the karaoke bird characters, scores and other indications are displayed in black and white.

1 Complete steps **1** through **6** (see page 28) to perform settings for disc.

2 Press the **SCORING SYSTEM** button twice.



Each time you press the button, the setting changes as follows.



4 Press the **PAUSE** button, and scores are displayed on left and right scoreboards.

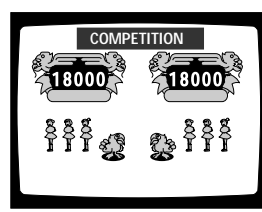
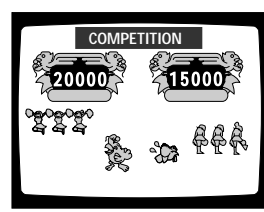
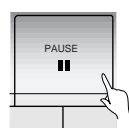

The karaoke bird character and cheerleaders are happy for the winner, just to annoy the loser!

If scores are even, both karaoke bird characters bend their necks, and the cheerleaders clap.

Returning to the regular KARAOKE mode

- Press the SCORING SYSTEM button on the main unit to select OFF.

Tip

If you do not press the PAUSE button, scoring continues. When a song ends, be sure to press the PAUSE button.



Consecutive Play of Song Highlights (HI-LITE MEDLEY)

Playing just the highlights of songs lets you search for desired songs, and is handy for practicing medley karaoke. You can enjoy this function with discs that bear the **HI-LITE MEDLEY** mark on their jackets. (You can also enjoy it with some discs not bearing the mark.)

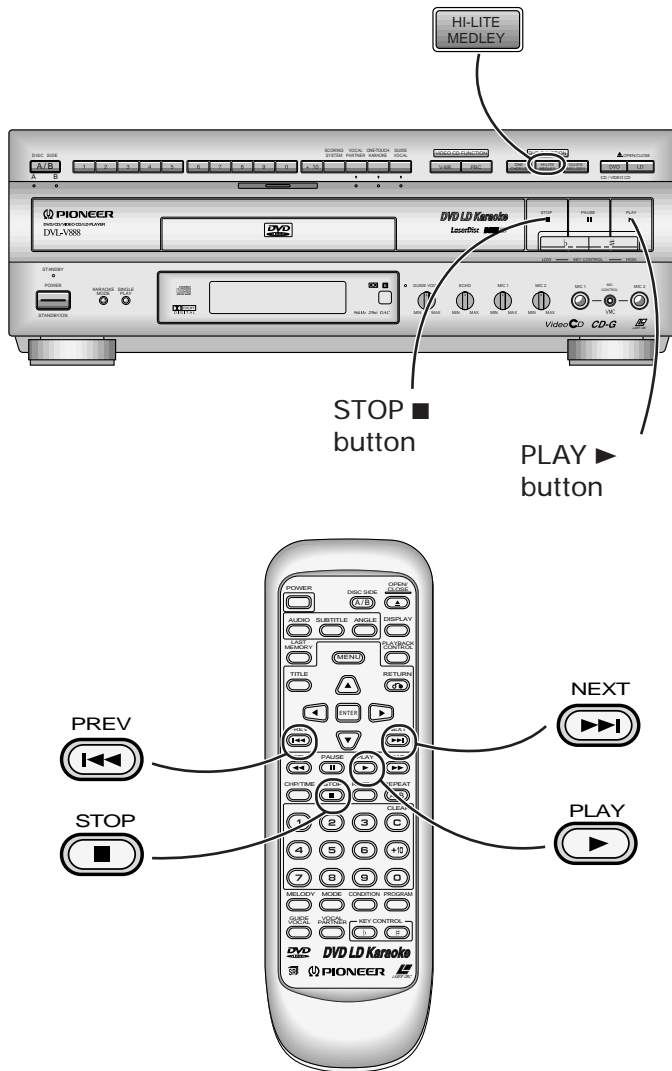

STOP ■ button

PLAY ► button

Load a disc, and press the HI-LITE MEDLEY button.

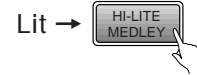

The highlights of each song are played from the first song in order.

To skip highlights, press the Previous or Next button.



- Press the Next ►► button to skip to the next song's highlight section.
- Press the Previous ◀◀ button to return to the start of the highlight section of the song currently playing. Press again to return to the start of the highlight section of the previous song.

To stop HI-LITE MEDLEY play, press the STOP ■ button.

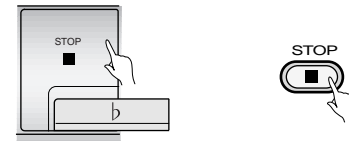

To sing a desired song from the beginning

- During HI-LITE MEDLEY play, if you press the PLAY ► button, the currently playing song starts playing again from the beginning and HI-LITE MEDLEY play is canceled.

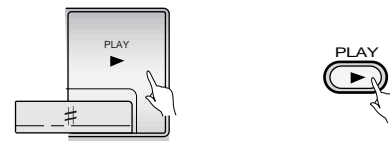

Tips

- The volume level at the end of a highlight section lowers gradually.
- If you press the PLAY ► button after HI-LITE MEDLEY play ends, the final song from which a highlight was played starts playing.

Basic Operation

Detailed Operation

Karaoke Operation

Setting

Set Up

Other Information

Reserving a Desired Song

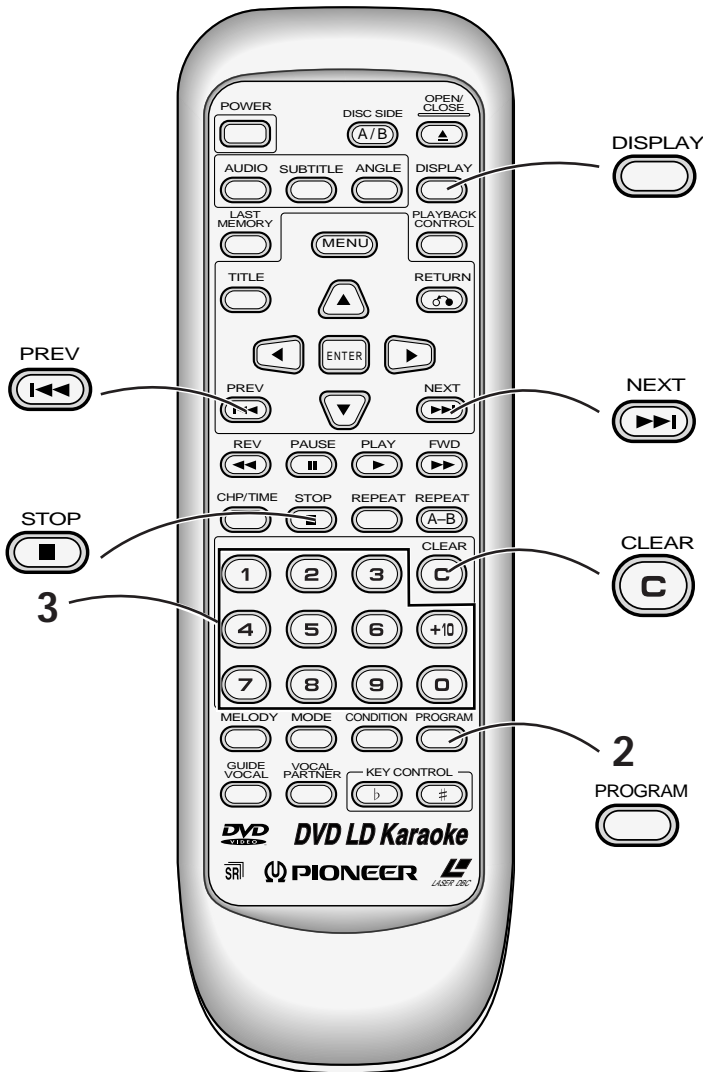

1 For karaoke fun, perform steps **1** through **6** on page 28.

2 Press the PROGRAM button.



- When reserving a song is possible, the indication on the right is displayed.
- Reserving songs is not possible with some DVDs.

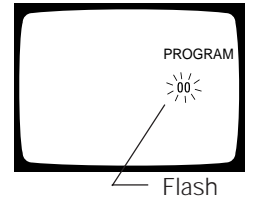

3 Select a song number with the digit buttons.

Example: Reserving song number 9
Input a Title number with DVDs, a Chapter number with LDs, and a Track number with CDs and Video CDs. (Refer to p.16)

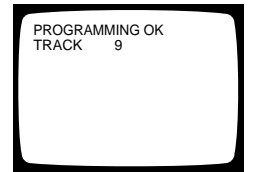

4 Repeat steps **2** and **3** to reserve other songs.

- Up to 24 songs can be reserved.
- Reserved songs play one after the other, without SINGLE PLAY pauses between them.
- When the reserved songs have played, reservation details are erased from memory in the order in which songs were reserved.
- When the last reserved song finishes playing, the player pauses or stops.
- Press the Next button, and the next reserved song starts playing. Even if you press the Previous button, you do not return to the previous reserved song. Instead, you return to the start of the currently playing song.

5 Adjust Mic 1 and 2 volume level.



To stop playback.



Press the STOP button.

To confirm reservation details

DISPLAY



Press the DISPLAY button.

- Press the button once more, and the display is switched OFF.

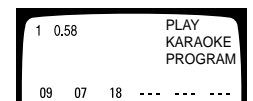

Tips

- Reserving songs is not possible with DVDs that have a Menu function.
- Chapter reservation is not possible with DVDs.
- With Video CDs (Version 2.0 with PBC), if you do not switch Playback Control OFF with the remote control or on the main unit (the PLAYBACK CONTROL indicator on the front panel goes out), you cannot reserve a song. (Refer to page 14)
- If you reserve a song during play, the reserved song starts playing after the current song finishes.



One Verse and Chorus Play Only (One Chorus)

Use this function when enjoying karaoke. This is a handy function when practicing a lot of songs. You can take advantage of it with DVDs bearing the **ONE CHORUS** mark on their disc jackets. (You can also enjoy it with some discs not bearing the mark.)

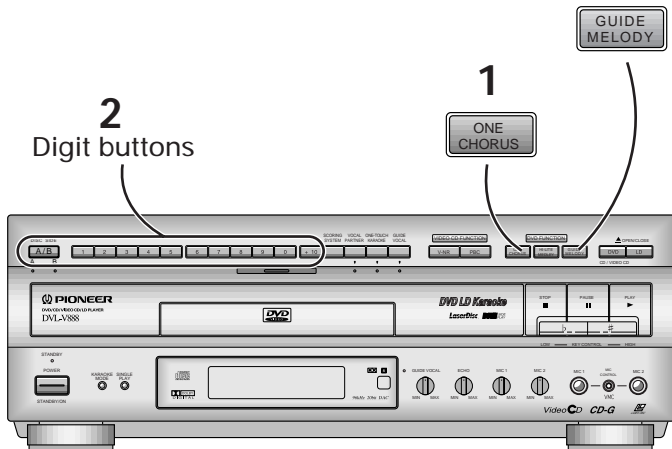

1 Load a disc, and press the **ONE CHORUS** button.



2 Select the desired song number with the digit buttons.

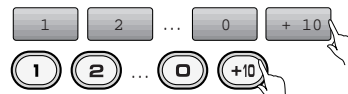

3 The selected song starts playing from the beginning, and then the volume level gradually diminishes after the first chorus.

- When SINGLE PLAY is ON, play pauses.

Tip

Even if you continue selecting and playing songs, One chorus continues operating.

Canceling One chorus...

Press the **ONE CHORUS** button.

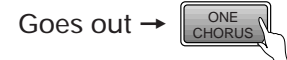

Sing with Professional Karaoke (GUIDE MELODY)

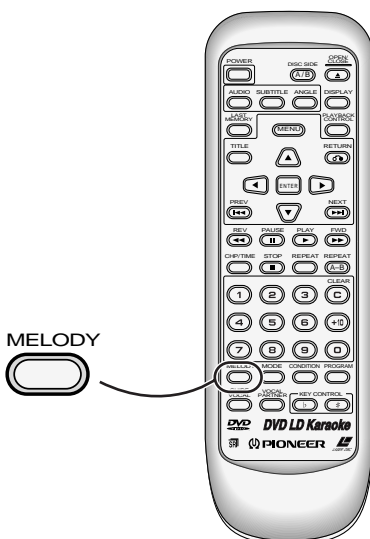

You can switch **GUIDE MELODY** ON/OFF. With it switched ON, you can enjoy singing along with a professional singer.

Press the **GUIDE MELODY button**



- When the indicator goes out, **GUIDE MELODY** is OFF.

Tip

- When you switch power to the unit ON, **GUIDE MELODY** switches ON.
- To switch **GUIDE MELODY** ON after it has been switched OFF, press the **GUIDE MELODY** button once more.
- With discs that do not feature a separately recorded guide melody, the **GUIDE MELODY** cannot be switched ON/OFF.

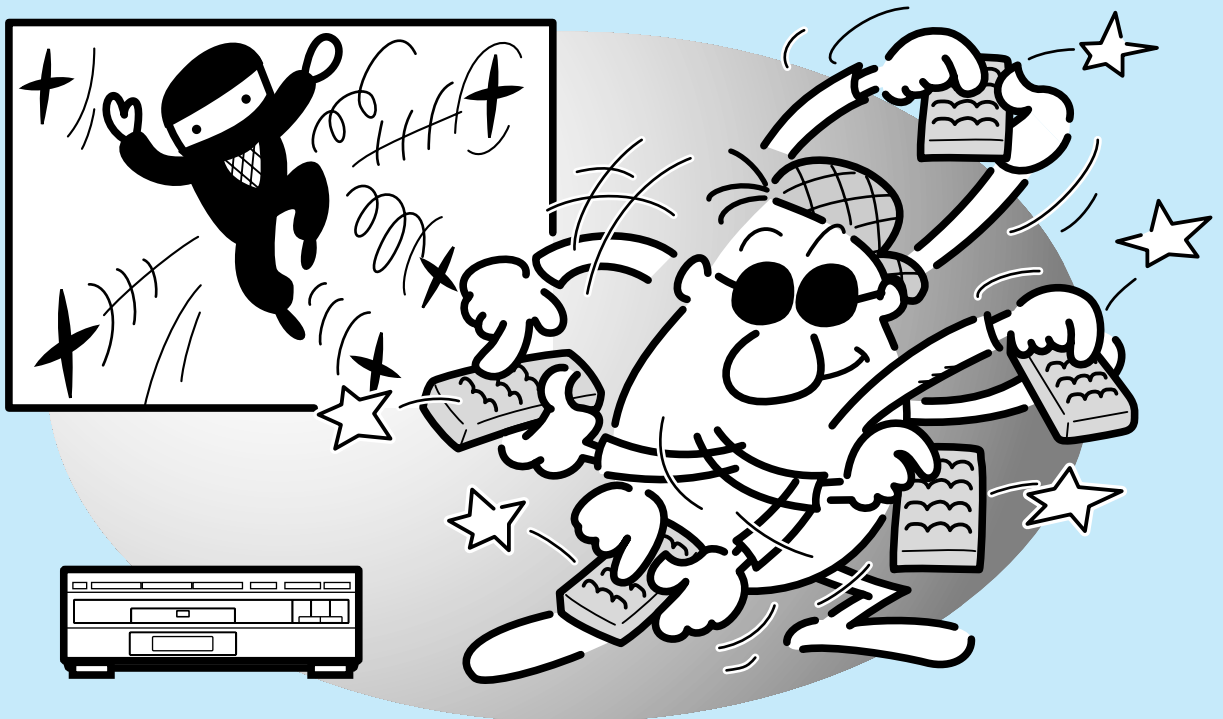

Setting

| | |
|---|----|
| Multi-Aspect Setting for Wide Screen TV Software | 42 |
| Changing Picture, Sound Quality and Graphics Settings | 43 |
| Changing Picture Quality(mode) | 44 |
| Switching singing venue atmosphere(KARAOKE SURROUND) | 45 |
| Changing Sound Quality(D.R.COMP) | 45 |
| Changing graphics display position | 46 |
| Changing graphics channel | 47 |
| Memorizing Settings for Often Viewed DVDs (Condition Memory) | 48 |
| Selecting Languages (Multi-Language) | 49 |
| Changing Audio Type | 49 |
| Selecting Subtitle Language (Multi-Language Subtitles) | 50 |
| Viewing from a Desired Camera Angle (Multi-Angle) | 50 |
| Viewing Information | 51 |
| Quick LD Side Changing(Quick Turn) | 52 |
| Outline of GUI (Graphical User Interface) Operation | 53 |
| Changing Various Settings | 60 |
| Setting the Basic Language and Subtitle Language | 62 |



Multi-Aspect Setting for Wide Screen TV Software

Certain DVDs feature image data recorded with the "squeeze" recording system for wide screen viewing. When watching this kind of DVD on a conventional TV, the picture may appear vertically squeezed. If this occurs, you can use the Multi-Aspect function to achieve a normal picture.

Setting is possible when a DVD is loaded.

1 Press **MENU** when the player is in the STOP mode.

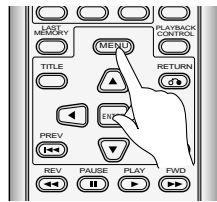
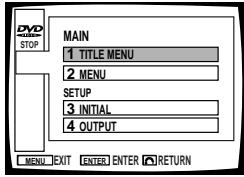

- Main Menu indications are displayed.

5 Press **ENTER**.

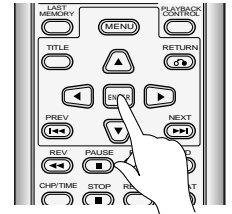
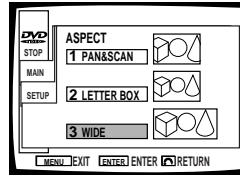

- Aspect indications are displayed.

2 Select initial setting with **▲ ▼**.

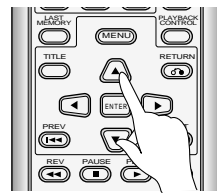
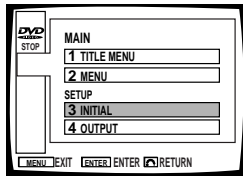

- Initial setting button is blue.

6 Select the desired mode (Pan & Scan, Letterbox, Wide) with **▲ ▼**.

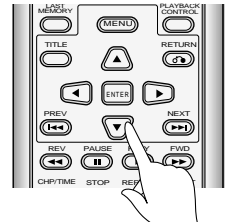
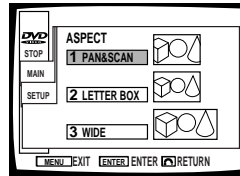

3 Press **ENTER**.

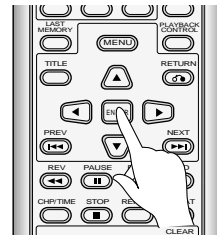
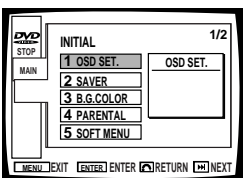

- Initial setting indications are displayed.

7 Press **ENTER**.

- Switch to the desired screen.

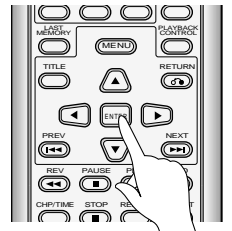

4 Select Aspect with **▲ ▼**.

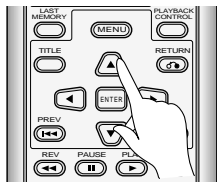
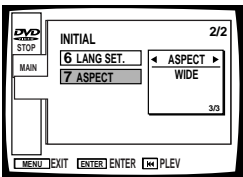



Multi-Aspect Setting for Wide Screen TV Software

With DVDs that enable switching between different aspect ratios, select the appropriate setting for your TV.

| Disc | Aspect switching | Wide TV (16:9) | Regular TV (4:3) |
|--------|------------------|----------------|------------------|
| 16 : 9 | Wide | | |
| | Pan & Scan | | |
| | Letterbox | | |
| 4 : 3 | | | |

Note

- ◆ If there is a power outage or the power cord is disconnected while power to the player is ON, memorized settings are erased. When disconnecting the power cord, be sure to press POWER button on the main unit and the remote control until "-- OFF --" is no longer indicated in the display.

Tip

- The width-to-height ratio of conventional TVs is 4:3, while the width-to-height ratio of wide screen and Hi-Vision TVs is 16:9. This width-to-height ratio is called the aspect ratio.

Selecting in the chart above assures correct aspect ratio for the TV used.
 Whether or not aspect ratio can be changed depends on the disc. Confirm by referring to the disc's jacket.
 With disc not enabling aspect ratio changing, make adjustments with the TV.



Changing Picture, Sound Quality and Graphics Settings

Each time you press settings change as follows.

(When in the KARAOKE MODE)

(With DVDs)



(With CDs)



(With LDs)
Displays with black and white during play

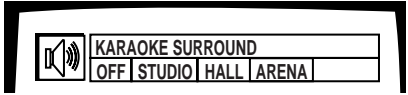

(With Video CDs)



Changing Picture, Sound Quality and Graphics Settings

Each time you press , settings change as follows.

(When in the NORMAL MODE)

(With DVDs)

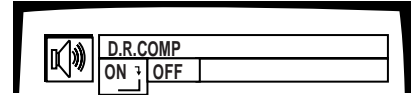
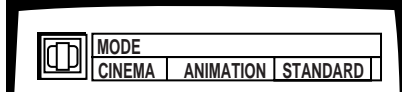

(With LDs)

Displays with black and white during play

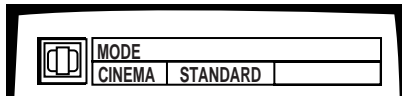

(With CDs)

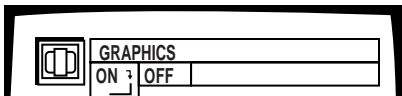

(With Video CDs)

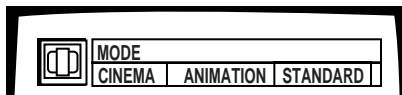

Changing picture quality (mode)

1 Press during play and select **MODE**.

(DVD, Video CD)

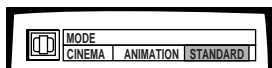

(LD)

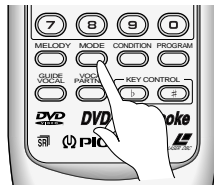
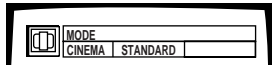

CINEMA:

Picture quality: Provides clear picture with clear black and white definition.

ANIMATION:

Picture quality: Provides beautiful images with bright, clear colors.

STANDARD:

Picture quality: Returns you to standard picture and function settings.

2 Select the desired mode with the and buttons.

Each time you press a button, the mode changes as follows.

DVD, Video CD: CINEMA → ANIMATION → STANDARD
LD: CINEMA → STANDARD

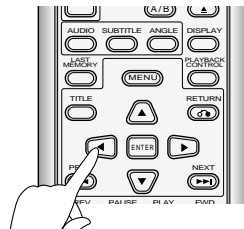

Note

- ◆ Picture quality may be poor depending on the software and the TV used. In this case, select the Standard mode.

Tips

- You cannot use the Animation mode for the video part of LDs and CDVs.
- You can use the same setting for CDV video part as for LDs.
- This operates only when using the NORMAL MODE.

Changing Picture, Sound Quality and Graphics Settings

Switching singing venue atmosphere (KARAOKE SURROUND)



You can select different ambience settings.

1 During play, press to select KARAOKE SURROUND.

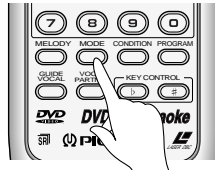

2 Select the desired atmosphere setting with the buttons.

The setting changes as follows.

OFF ↔ STUDIO ↔ HALL ↔ ARENA

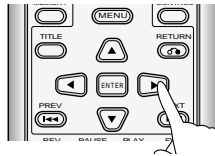

Tip

- This operates only when using the KARAOKE MODE or the AUX INPUT MODE. (Before settings, press the KARAOKE MODE button on the front of this player.)

Changing sound quality (D.R.COMP)



D.R.COMP stands for Dynamic Range Compression. On the DVDs, sound has a wide dynamic range. Use D.R.COMP when sounds such as dialog are hard to hear on your stereo system or TV speakers.

1 Press during play, and select D.R.COMP.

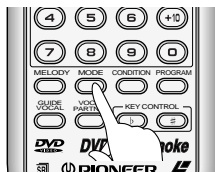
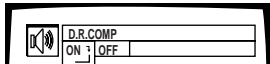

2 Switch ON or OFF with the and buttons.

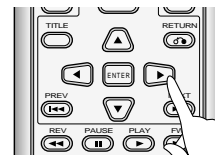

3 If you select ON, press .

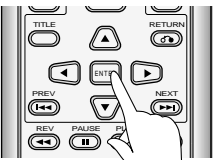
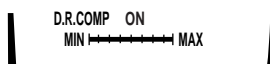

4 Adjust the degree of change with the and buttons.

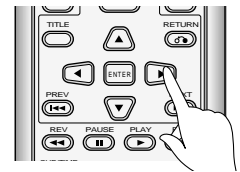
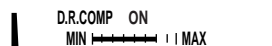

5 Press .

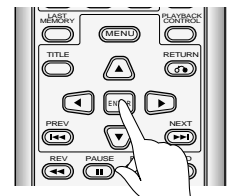

Tip

- Pressing the or button at step 4 switches between ON and OFF.

Basic Operation

Detailed Operation

Karaoke Operation

Setting

Set Up

Other Information

Changing graphics settings



Video and audio information is recorded in different areas on a disc. There's also a subcode area where information such as subtitles and song lyrics can be recorded. Graphics refers to the reading of the signals in this area, and their display.

You can set the graphics channel (between 0 and 15) to select the desired information for display, and set the Scroll setting (from Normal to Step 17) to select the on-screen position of graphics indications.

Changing graphics display position

1 During play, press and select **GRAPHICS**.

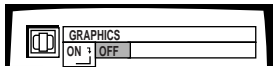

2 Select ON with the buttons.

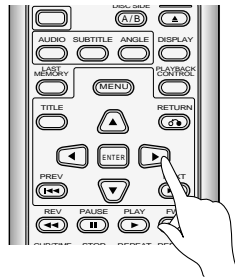
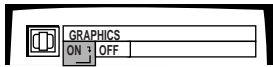

3 Press .

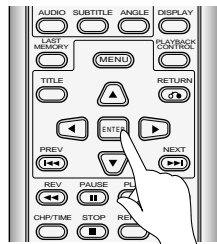
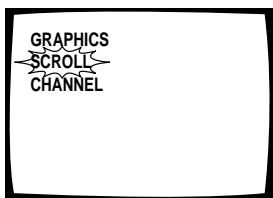

Scroll flashes.

4 Press .

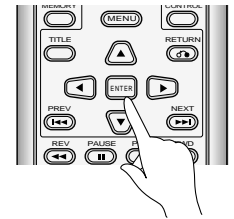
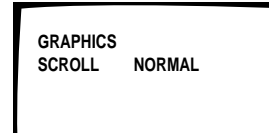

5 Select display position with the buttons.

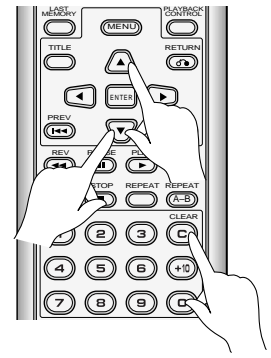
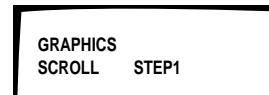

- You can select from 18 positions between Normal and Step 17.
- To return to the normal display position, press .

6 Press **ENTER**.

Graphics are displayed in the selected position.

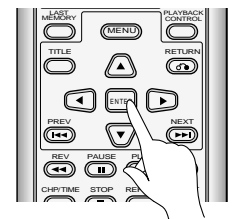

Note

If graphics are not displayed even if you perform these operations, try changing the channel (refer to page 47).

Tip

To return to the previous display, press on the remote control.

Changing Picture, Sound Quality and Graphics Settings

Changing graphics channel

1 During play, press and select GRAPHICS.

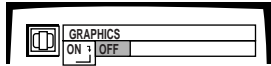

2 Select ON with the buttons.

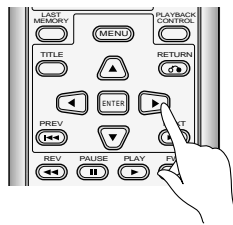
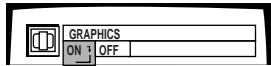

3 Press .

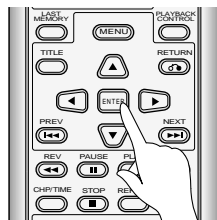

Scroll flashes.

4 Press .



Channel flashes.

5 Press .

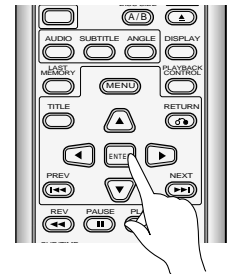
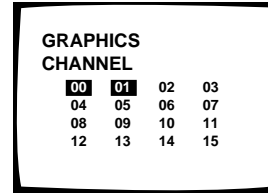

6 Select a channel number with the digit buttons.

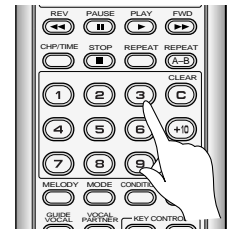
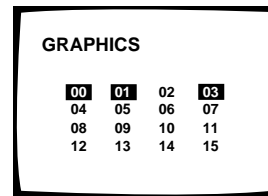

- The selected channel number is displayed in reverse.
- Pressing the same number again switches it OFF.
- To select channel numbers 10 through 15, first press and then through .

7 Press .

The selected channel's graphics are displayed.

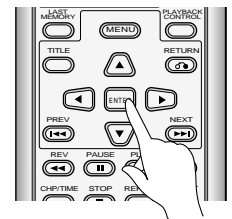

Note

If graphics are not displayed even if you perform these operations, try changing the display position (refer to page 46).

Tips

- If the power to the player is cut, changed graphics scroll and channel setting return to the initial settings. This is to prevent problems such as no display of graphics occurring when a different disc is played.
- To return to the previous display, press on the remote control.



Memorizing Settings for Often Viewed DVDs (Condition Memory)

You can store settings for DVDs you often watch in memory. Settings remain in memory even if you remove the disc from the player, or switch power to the player OFF. If you load a disc that has its settings memorized, the Condition indicator lights. When you start playing the disc, the memorized settings are automatically recalled.

The Condition indicator in the display section lights. You can memorize details for the following five settings.

- Multi-Aspect (page 42)
- Cinema mode/Animation mode (page 44)
- Multi-language (page 49)
- Multi-language subtitles (page 50)
- OSD SET.(POSITION) (page 60)

Notes

- ◆ If there is a power outage or the power cord is disconnected while power to the player is ON, memorized settings are erased. When disconnecting the power cord, be sure to press POWER button on the main unit and the remote control until " OFF " is no longer indicated in the display.
- ◆ This operates only when using the NORMAL MODE.

Tips

- Settings are stored in memory for use any time.
- You can store settings for up to 30 DVDs in memory. If you memorize settings for more than 30 DVDs, previously memorized settings are erased in order from the least recently memorized settings.
- To make changes to ASPECT , Cinema mode/Animation mode, Multi-language subtitles, Multi-language, and POSITION settings, press  during playback.
- This player memorizes multi-language subtitles and multi-languages as languages not numbers. With DVDs that have multiple settings for the same language, playback starts from the first number.

Press  during Play.

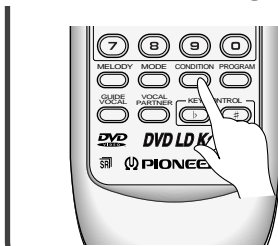

" CONDITION " is indicated in the display.

When a memorized disc is loaded

" CONDITION " is indicated, and previous settings are displayed.

Erasing memorized settings

Load a memorized disc, and while " CONDITION " is indicated, press .

The recorded details for that disc are erased.



Selecting Languages (Multi-Language)

Dolby Digital, PCM, and other audio data is recorded on DVDs in a number of languages, letting you choose the desired language.

1 Press during playback.

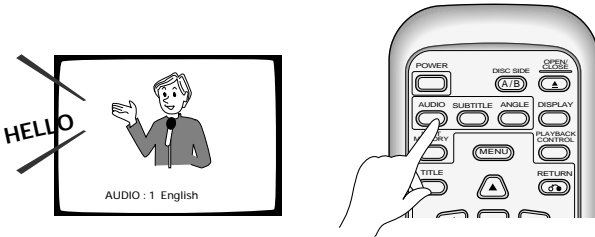

Notes

- ◆ You cannot switch languages if there is only one language recorded on the disc.
- ◆ Language number and setting differ with each disc, so refer to the disc's instructions.
- ◆ Some titles may not enable switching between languages. If this happens, the mark is displayed.

Tip

- Depending on the title, you can also make a selection using a menu. To do this, press the when indications are displayed to call up a menu, and select the desired title.

2 Press to select the desired language.

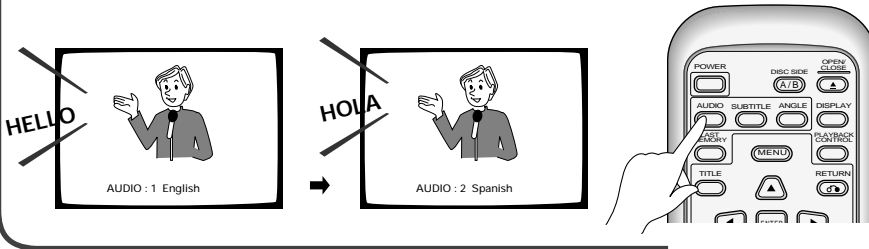

Changing Audio Type

Press during playback.

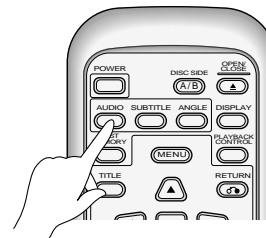
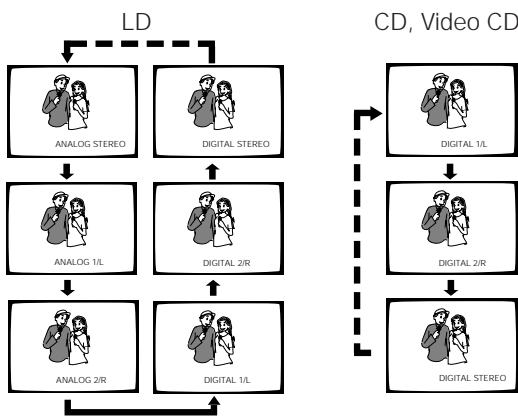

- Audio type changes each time you press the button.

Notes

- ◆ You cannot select digital audio if digital audio data is not recorded on the LD.
- ◆ You cannot switch audio type when using digital output of Video CD output (optical, coaxial) (RF output).
- ◆ With the NORMAL MODE only, you can change audio type.
- ◆ With LDs, switching to the CX System is possible with some discs. In this case, you can perform switching with this operation.



Selecting Subtitle Language (Multi-Language Subtitles)

You can select a desired subtitle language with DVDs that have subtitle data in multiple languages recorded on them.

1 Press during playback.

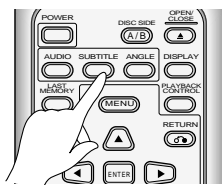

Notes

- ◆ You cannot switch subtitle languages with discs that do not have subtitle data recorded on them, or discs that feature subtitle data in only one language.
- ◆ Some titles may not enable switching between subtitles languages. If this happens, the mark is displayed.

Tips

- To clear subtitles during playback, when there's a display press after first pressing . You can also clear subtitles by selecting OFF in the subtitle menu display.
- If the basic subtitle is set to "OFF" in the initial setting menu, you can cancel subtitles.
- Depending on the title, you can also make a selection using a menu. To do this, press the when indications are displayed to call up a menu, and select the desired title.

2 Press to select the desired language.

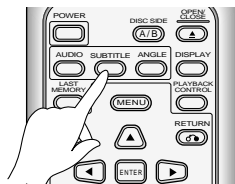

- You can also make your selection from a menu.



Viewing from a Desired Camera Angle (Multi-Angle)

With DVDs featuring recordings of images shot from different angles, you can choose a desired viewing angle.

Press during playback.

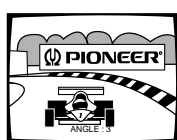
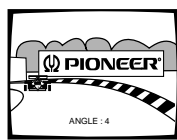
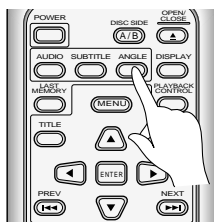
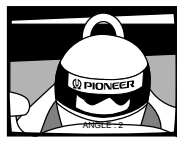
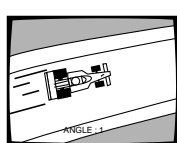

- The camera angle changes each time you press the button.
- You can also make your selection from a menu.

Tips

- You can use the Multi-Angle function only with discs featuring recordings of images shot from different camera angles.
- During Multi-Angle playback, the Angle indicator on the player lights.
- : This mark indicates the disc provides scenes shot from four angles.
- Depending on the title, you can also make a selection using a menu. To do this, press the when indications are displayed to call up a menu, and select the desired title.

To confirm whether multi-angle information is recorded on a disc

The disc jacket bears the mark. When a disc played on this player has sections that include multi-angle information, display of the is also possible.

Setting without displaying angle mark

(When DVD is in the STOP mode.)

1. Press .
2. Select the "INITIAL" setting () by pressing the digit button.
 - The initial setting menu is displayed.
3. Press the .
4. Press the .
 - The angle mark menu is displayed.
5. Press the .

You can turn the displayed logo mark ON by selecting Angle ON at step 5 above. (Press .

Note

- ◆ Some titles may not enable switching between angles. If this happens, the mark is displayed.

Viewing Information

Press  during playback.

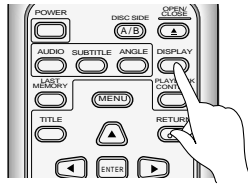

- Each time you press the , setting changes as follows.
- If you press during the Stop mode, all the disc's information is displayed.

Notes

- ◆ To prevent TV screen burn-in, the display automatically switches OFF after about 80 minutes.
- ◆ Not displayed with LDs that do not have a TOC (refer to page 75) or after playback of side B finishes.
- ◆ There is also no display if Quick Turn is switched ON.

< DVD > (With some discs, indications may not be displayed.)

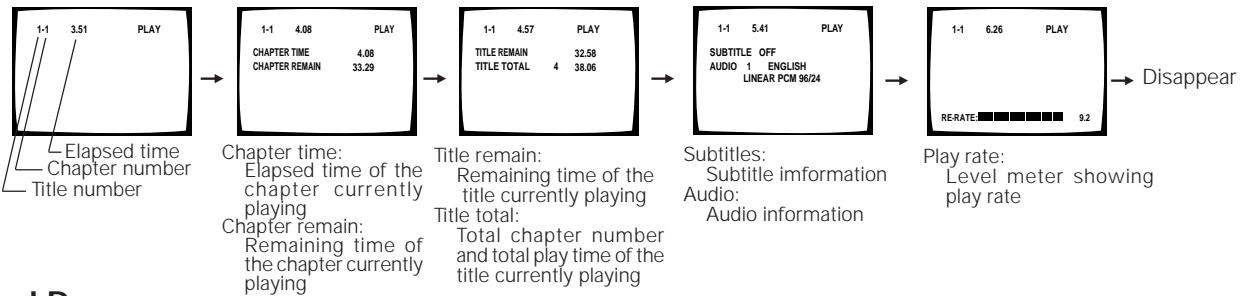

< LD >

CLV: Extended play disc

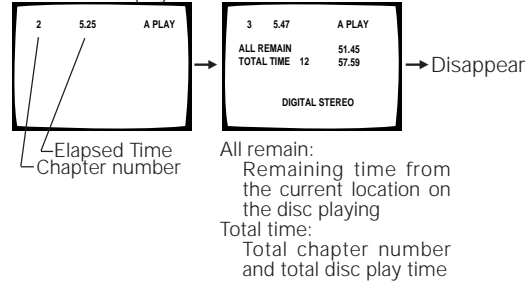

CAV: Standard play disc

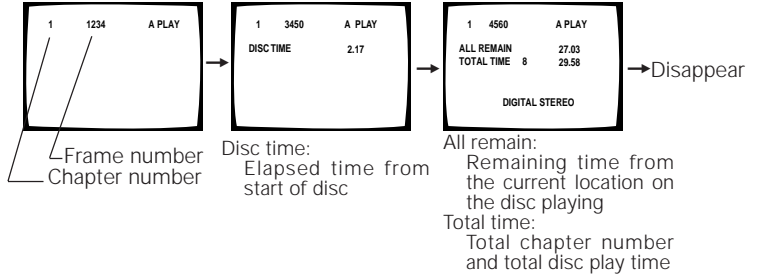

< CD >

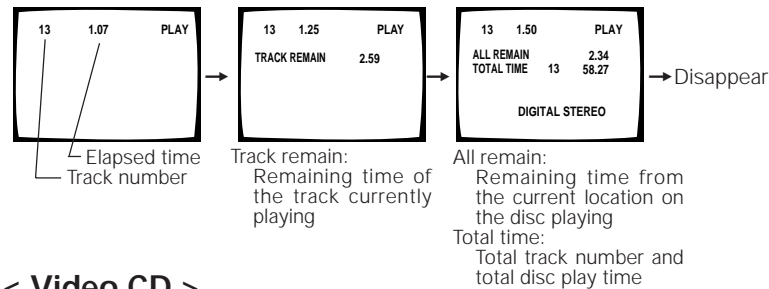

< Video CD >

(PBC off)

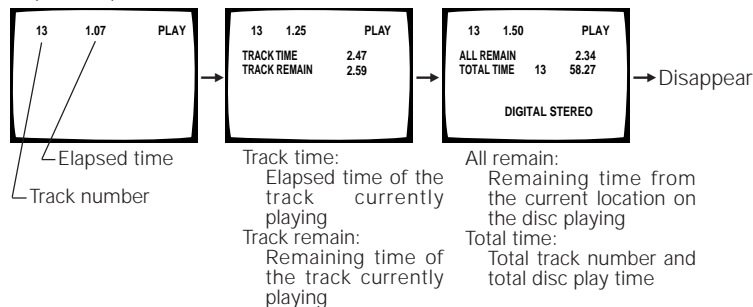

(PBC on)

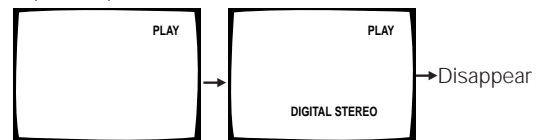

Quick LD Side Changing (Quick Turn)

This function shortens the time required to change from A to the B side, or from the B to the A side when playing an LD.

1 Press **[MENU]** when play has stopped.

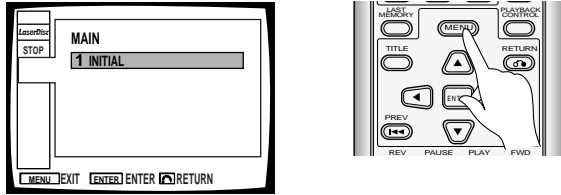

Main Menu indications are displayed.

4 Press **[ENTER]**.

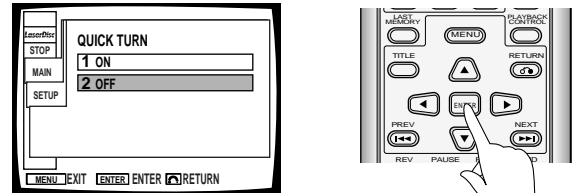

Displays the selection menu of Quick Turn.

2 Press **[ENTER]**.

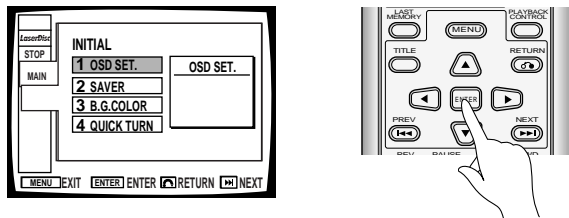

Initial setting indications are displayed.

5 Select ON with the **[▲]** and **[▼]** buttons.

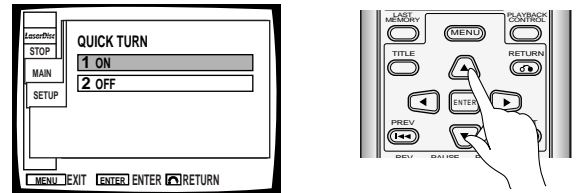

3 Select Quick Turn with the **[▲]** and **[▼]** buttons.

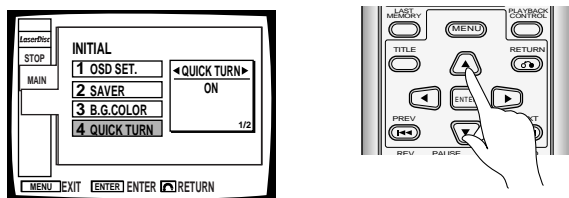

6 Press **[ENTER]**.

Quick Turn is set to ON.

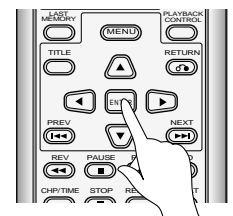

Note

When Quick Turn is ON, On-screen display of remaining and total play time cannot be used.

Outline of GUI (Graphical User Interface) Operation

On this player, various settings can be selected while watching menu screens and using the remote controller.

Here we will explain how to access menu screens. Because menu screen access differs according to the type of disc being used, or the playback mode (playback mode, stop mode etc.), refer to the following menu map when accessing.

LD

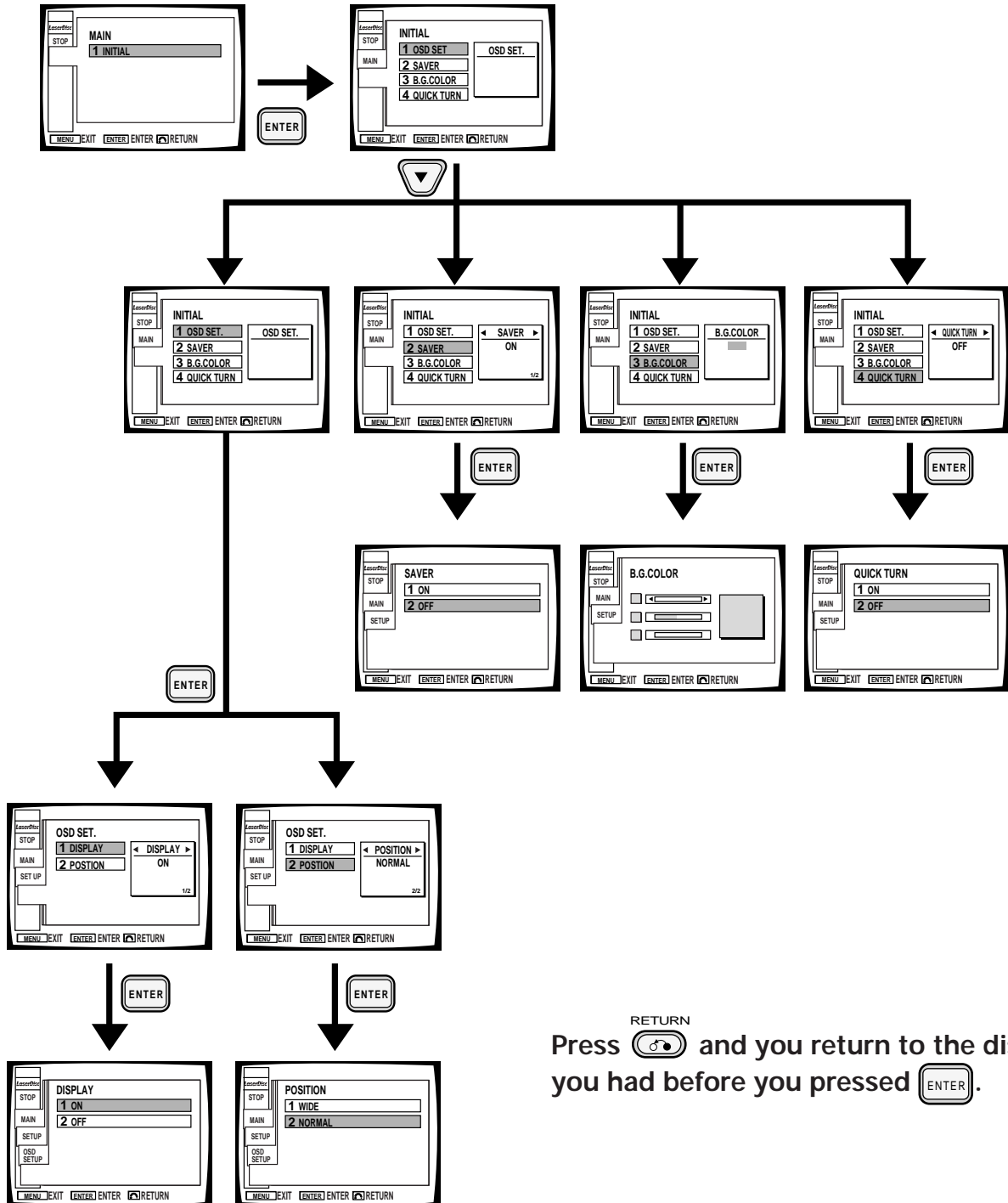

Press **RETURN** and you return to the display you had before you pressed **ENTER**.



Outline of GUI (Graphical User Interface) Operation

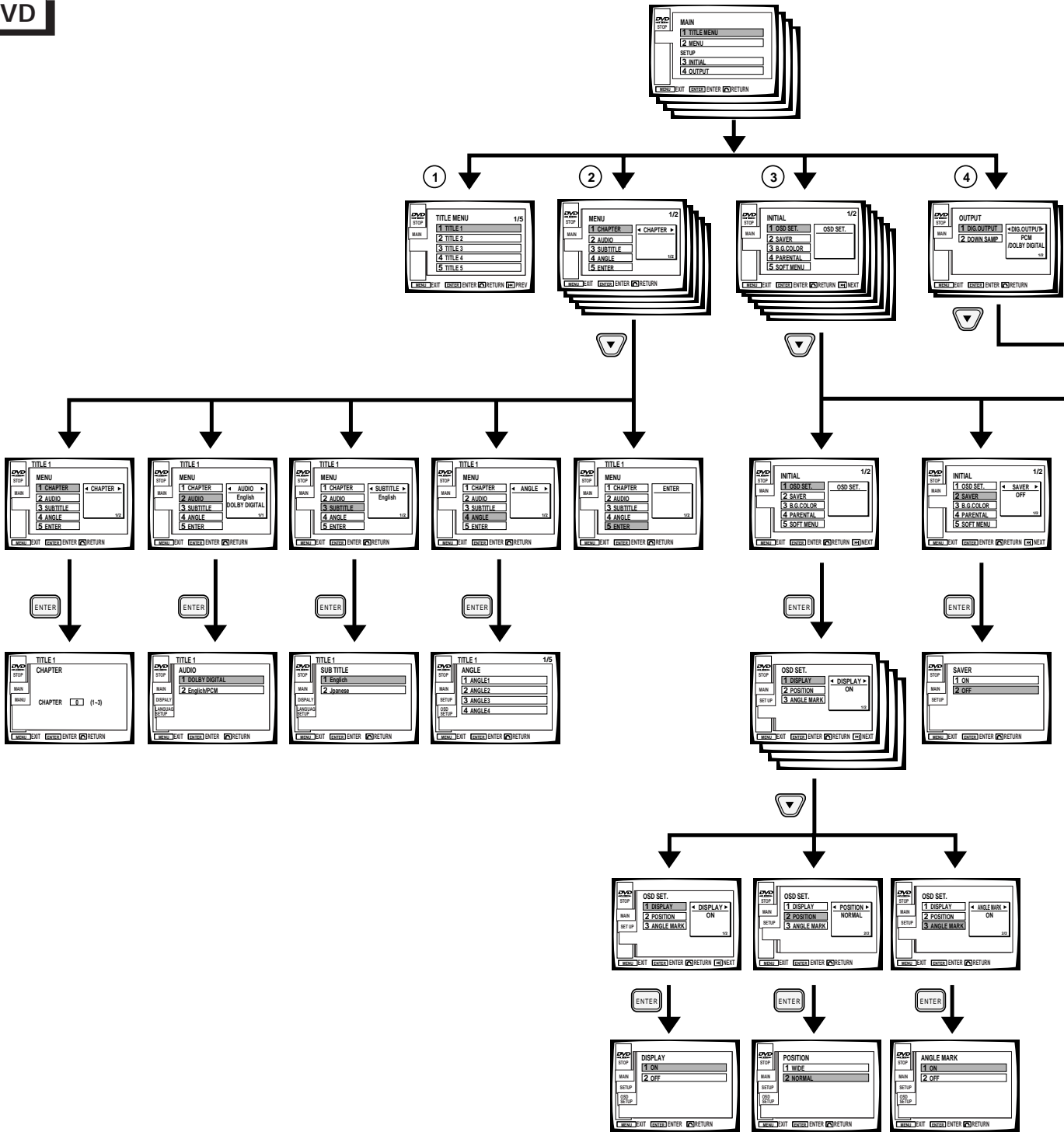

Press and you return to the display you had before you pressed .



Outline of GUI (Graphical User Interface) Operation

Basic Operation

Detailed Operation

Karaoke Operation

Setting

Set Up

Other Information

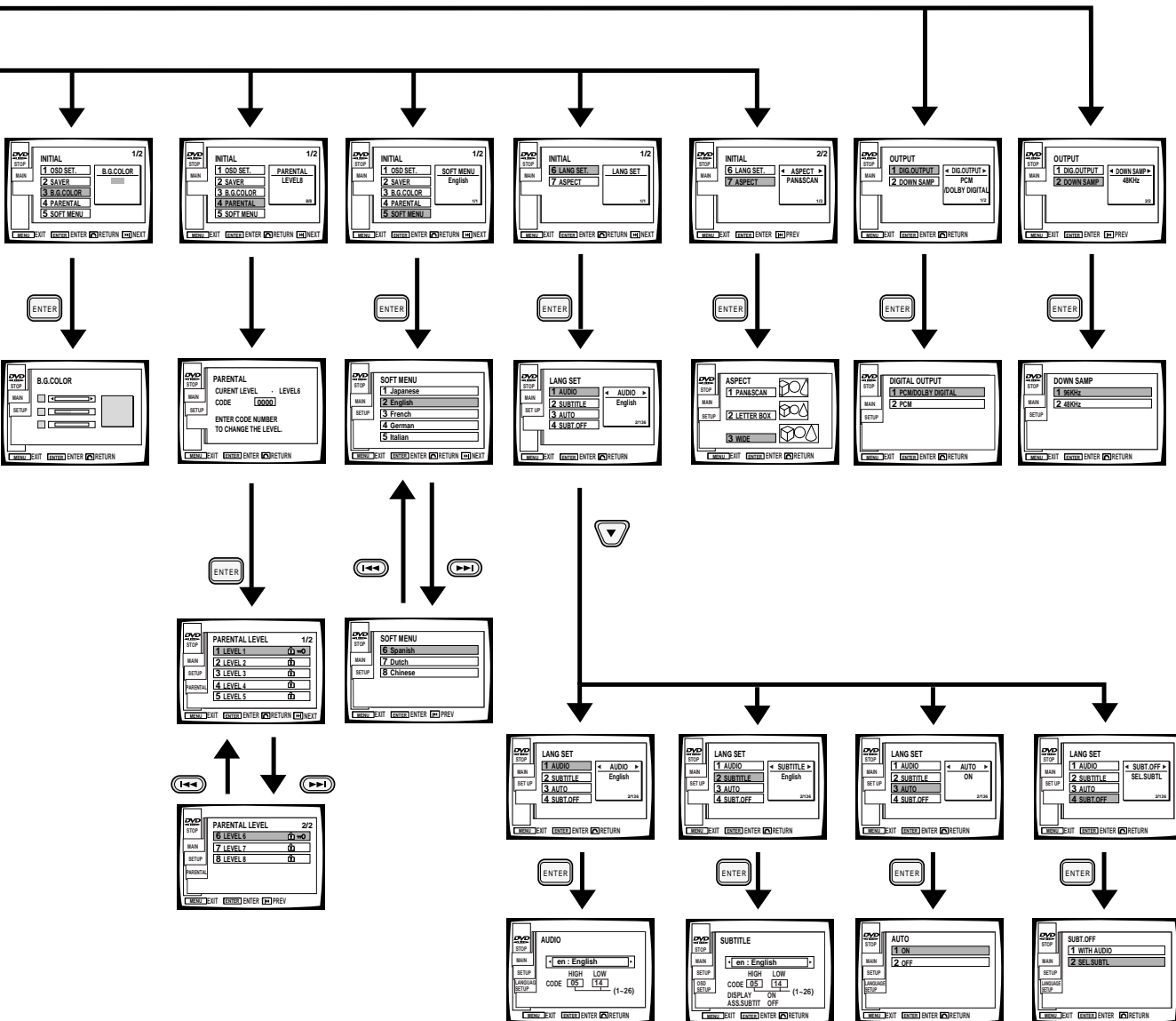

Outline of GUI (Graphical User Interface) Operation

CD, Video CD

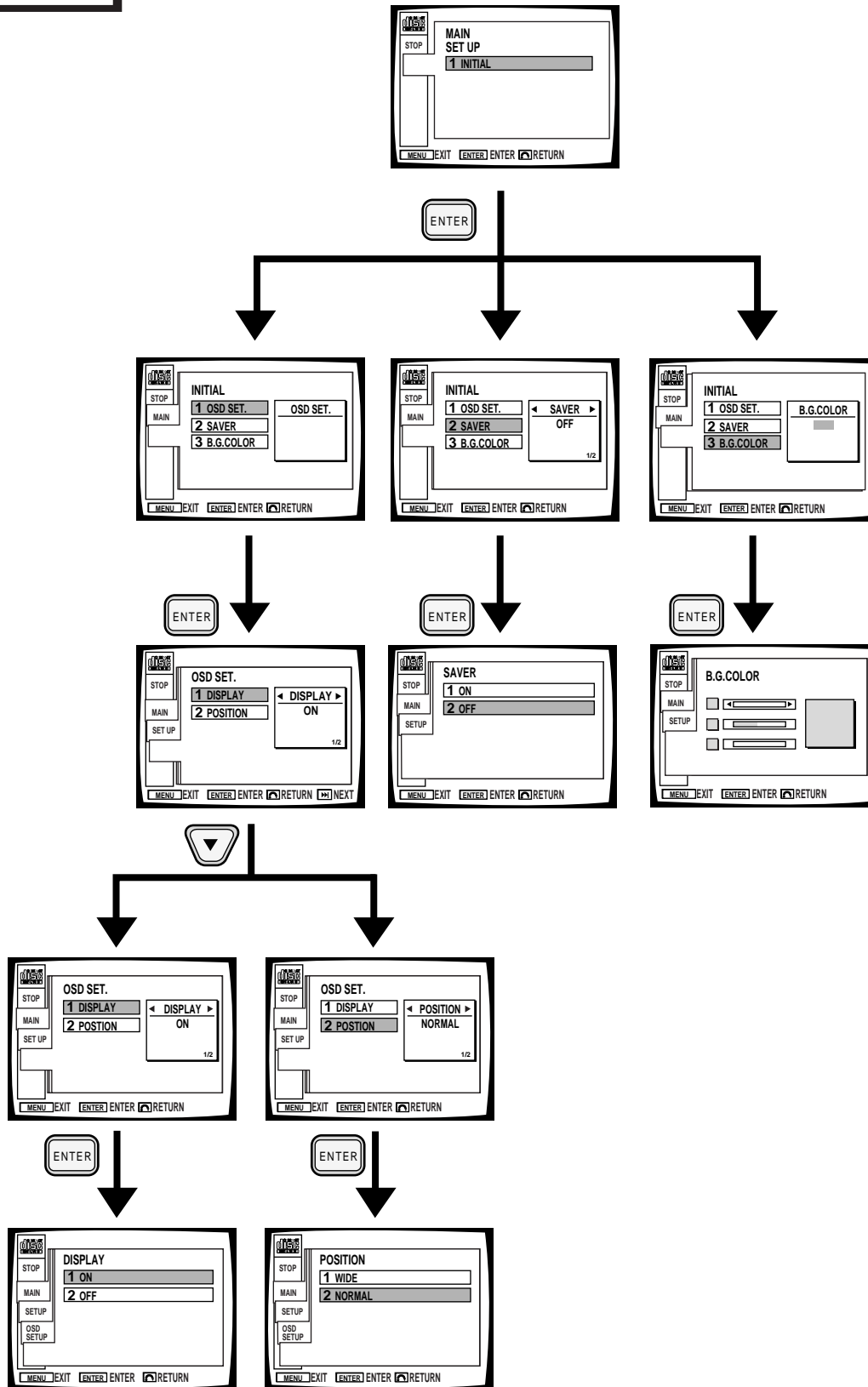

Button operation within each menu

| Button name | Button shape | Operation |
|------------------|--------------|--|
| MENU button | | To leave the menu screen (settings are invalidated) |
| RETURN button | | To return one menu screen back (Set up operation is completed. However, search cannot be performed.) |
| Digit buttons | | Selection and conclusion (In the set up menu, some items only operate for selection.) |
| Direction button | | Selection |
| ENTER button | | Setting and implementation (playback mode is engaged after title or chapter change) |
| PREVIOUS button | | To go to previous menu screen |
| NEXT button | | To go to next menu screen |
| Direct button | | To go to menus (setting selected before moving to a new menu will be invalidated) |

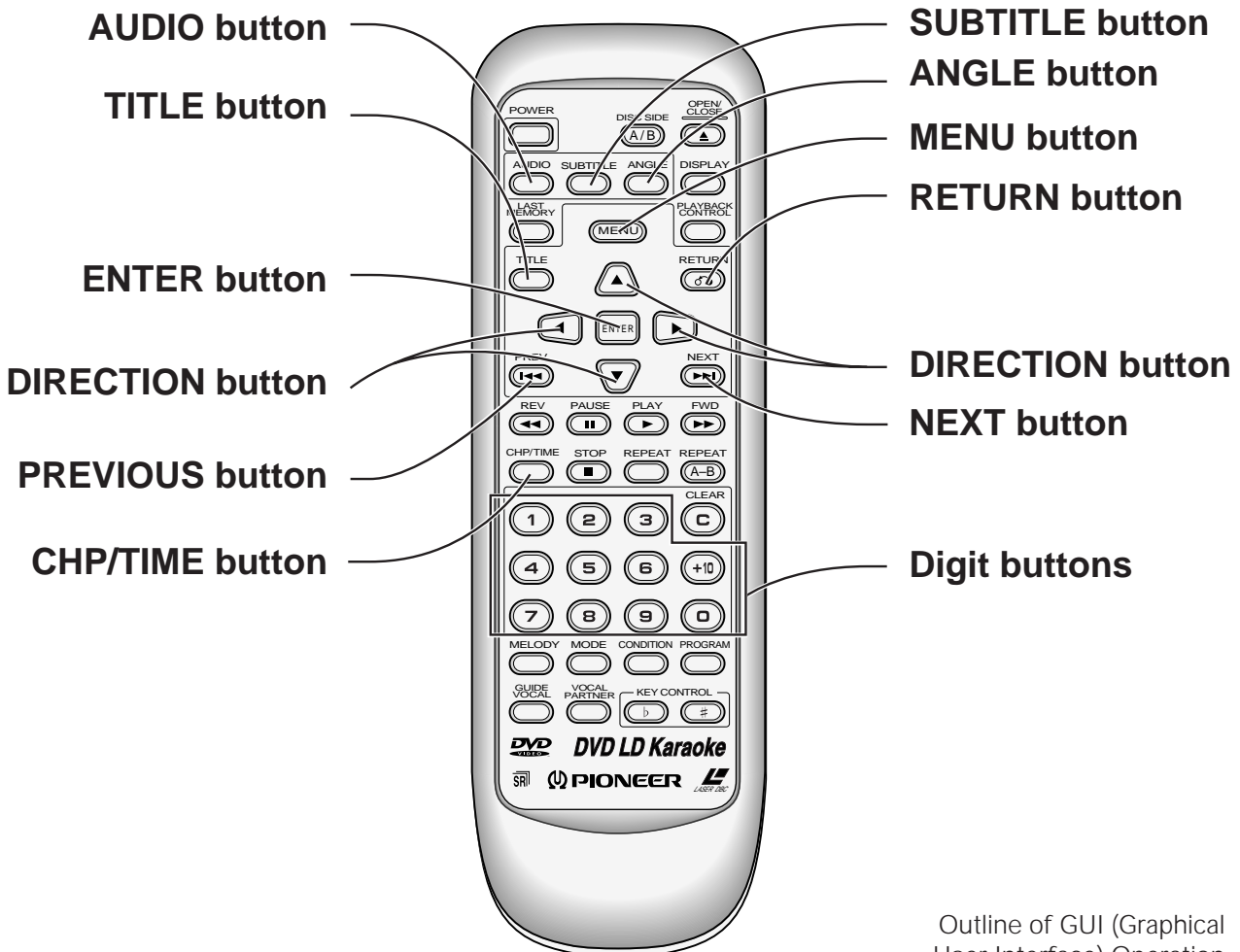

Examples of screen indicators and operation

Ex.1: Display content within menus/Button operation

(Example: DVD)

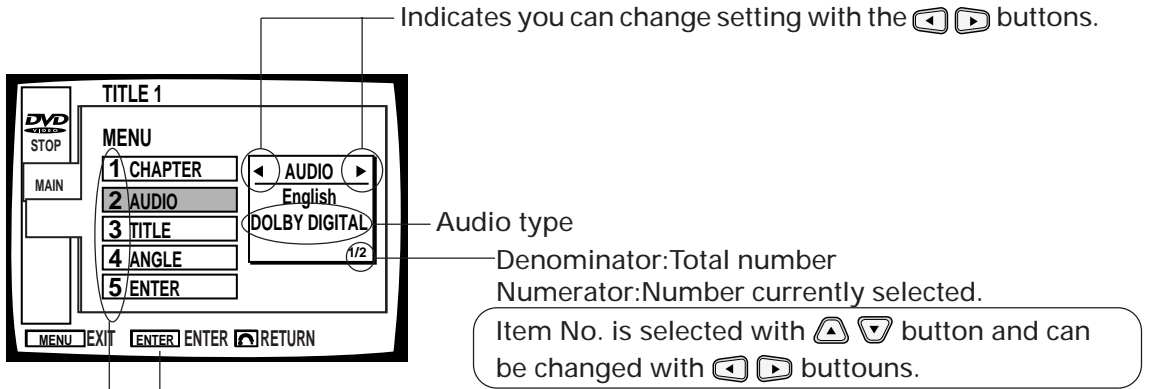

Will switch above settings to new settings if they were changed.

Selection item No.

When selection is made by pressing a **digit button** or the ▲ or ▼ button, and then pressing the **ENTER button**, the selection screens for the various set-up items will be displayed. Selecting 5[ENTER], however, will select the new setting changes and close the screen.

Ex.2: Display content within set up menus/Button operation

(Example: DVD)

● With CDs and LDs, indications may be different.

Current settings

Item numbers can be selected with the ▲ ▼ buttons and settings changed with the ◀ ▶ buttons.

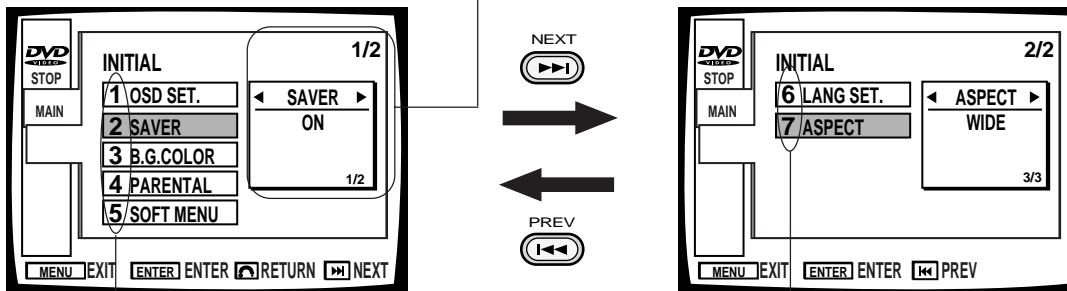

Selection item No.

Selection can also be made with the digit buttons.

- This is displayed if you press **MENU** when the player is in the Stop mode.
- With DVDs, LDs and other discs, displayed details differ depending on the type of disc.

About the main menu

The main menu is the menu used for selecting the Title menu screen, Menu screen and Set up screen.

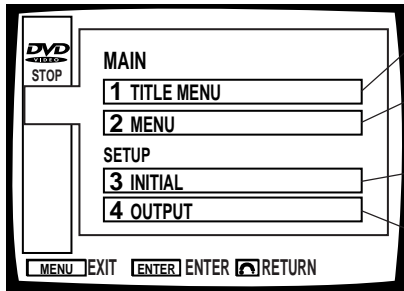

In the Title menu screen:
Titles can be selected and played back. (Title search)

In the Menu screen:
Chapters (songs), subtitles, audio and angles within a title can be selected.

In the initial setting menu:
You can perform on-screen setting of each function.

In the output setting menu:
You can select the audio signal output from the player's digital output jack.

About the title menu

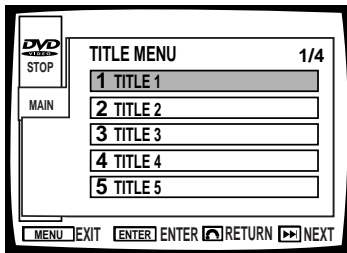

Titles can be selected and played back. This selection screen is the same as the one in "Direct Search with Title Numbers" on page 22.

Menu screen contents

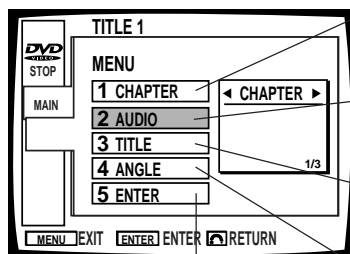

Completes the setting of changes to the above items.

To go to the Chapter screen

In the Chapter screen:
One chapter (song) within a title can be selected and played back.

To go to the Audio screen

In the Audio screen:
Audio contents can be selected on discs that include more than one audio language or audio type.

To go to the Subtitle screen

In the Subtitle screen:
Subtitle contents can be selected on discs that include subtitle information.

To go to the Angle screen

In the Angle screen:
The scene angle that you want can be selected on discs that include scenes that have been filmed from various angles.

Changing Various Settings

Initial setting menu

(Ex: DVD)

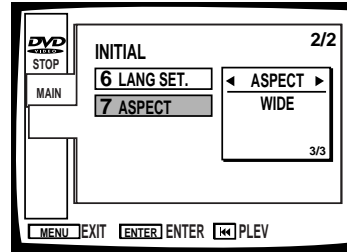
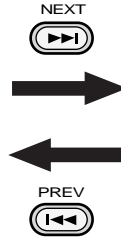
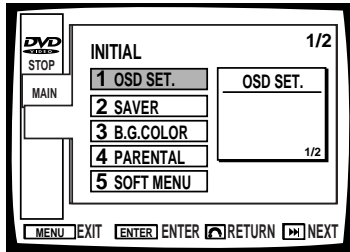

Use to change a wide range of settings. On pages 60 – 61, the details of each item are provided.

Output setting menu

(only with DVD)

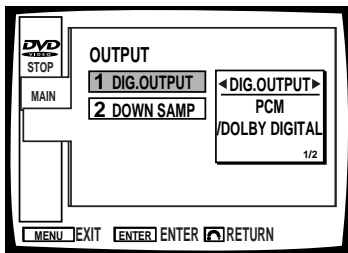

Use when you have selected audio output from the player via the digital output jack. Change the setting to match your amplifier.

On pages 60 – 61, the details of each item are provided.



Settings Chart

| Class | Item | Details | Settings status | |
|-----------------|---|--|--|--|
| | | | Initial settings (factory settings) | |
| Initial setting | OSD setting | DISPLAY Switches between display of operation indications (Play, Stop etc.) (ON), and no display of indications (OFF). | ON Display of operation indications | OFF No display of operation indications |
| | | POSITION When watching regular software on a wide TV, operation indications may be displayed outside the area of the screen, so you can't see them. Changing the on-screen location of the indications lets you see them even when watching a wide TV. | Normal When using a regular (4: 3) TV. | Wide When using a wide TV (Not compatible with menu display) |
| | | ANGLE MARK is displayed to clearly indicate when the scene playing has various recorded angles. | ON is indicated. | OFF No indication |
| | SAVER (Screen saver) Leaving a still image on screen for a prolonged period can result in screen "burn". This player features a screen saver function that prevents screen "burn" due to prolonged display (5 minutes or more) of menus and other indications. It is recommended to leave this function ON. | OFF The screen saver will not operate. | ON The screen saver will operate. | |
| | B.G.COLOR (Background color) Lets you select background color for menus and for screen color when no software is playing. You can set R (red), G (green), and B (blue) independently. Setting for each color is possible in 21 steps. | Blue | Switchable | |



Changing Various Settings

| Class | Item | Details | Settings status | | | |
|---------------------------|------------------|---|---|---|---|--|
| | | | Initial settings (factory settings) | | | |
| Initial setting | PARENTAL LEVEL | This function lets you prevent your children viewing unsuitable material. You can use this handy function if the disc features recorded parental lock coding. With parental lock discs, this function works by skipping violent or other scenes you don't want your children to see. For details, read the disc's instructions. Once the secret number has been set, the restricted viewing level remains the same until the number is reset. Try not to forget the secret number. If you do, you must return to the initial settings. (For detail, see the bottom of this page.) | Level 8 | Switchable between 1-8 | | |
| | | SOFT MENU | This lets you select a desired language for menus on discs that have them in multiple languages. | English | Selection possible depend on the disc | |
| | Language setting | AUDIO (Basic language) | This lets you select and set the usual language for movies in the same way as for subtitles. Even if you change the language during play, or change discs, the language changes to the one set. | English | Select one from 136 languages. (See how to set the language on the next page.) | |
| | | SUBTITLE (Basic subtitle language) | This lets you select and set the usual language for subtitles. Even if you change the subtitle language during play, or change discs, the subtitle language changes to the one set. | English | Select one from 136 languages. (See how to set the language on the next page.) | |
| | | AUTO | <p><input type="checkbox"/> On This sets basic language and basic subtitle language to the same language beforehand. When the basic language and basic subtitle language are not identical, if you switch "DISPLAY" OFF and "ASSIST" ON in the subtitle menu, it's the same as switching Auto <input type="checkbox"/> OFF. With Auto on, the original language and subtitle language are automatically selected. When the language and subtitle language are the same, subtitles are not displayed. Language Selection may not operate in this way with certain discs.</p> <ul style="list-style-type: none"> You can select a language (see page 49) and select a subtitle language (see page 50) part way through a movie. <p><input type="checkbox"/> Off Basic subtitle language and basic language are those selected.</p> | ON | OFF | |
| | | SUBT. OFF (Subtitle Off) | The subtitle which is displayed by discs can be selected, when the subtitle is set to "OFF". W. AUDIO : The selected audio language will be selected. S. SUBTITLE : The selected subtitle language will be selected. | S. SUBTITLE | W. AUDIO | |
| | ASPECT | When watching wide mode software, this lets you adjust aspect ratio to suit your TV. | Wide | Pan&Scan | Letterbox | |
| | QUICK TURN | This shortens the time required to change from A to the B side, or from the B to the A side when playing an LD. If you use this function, display of remaining and total time are not possible. | OFF | ON | | |
| | Graphics | You can select the graphics display position and graphics channel with CD graphics discs. | See how to set the graphics settings on pages 46 - 47. | | | |
| | Output setting | DIG.OUTPUT (Digital output) | Switching between audio output from this product's optical digital output jack or digital output (coaxial) PCM/DIG jack is possible. Dolby Digital (sound system used at cinemas etc.) and Linear PCM (the same digital signal as CDs) are the two standards for DVDs. | PCM/Dolby Digital Automatically selects between Dolby Digital and linear PCM to match the audio signal. This is when using an amp with a Dolby Digital (AC-3) decoder. | PCM Dolby Digital and linear PCM signals are output in line with the linear PCM standard. This is when using a regular amp or Dolby Pro Logic amp. | |
| DOWN SAMP (Down sampling) | | <p>96 kHz: With PCM audio discs that have a sampling frequency of 96 kHz, this assures high sound quality. However, when in the KARAOKE mode or AUX INPUT mode, the sampling frequency is compressed to 48 kHz during play. With discs that have a sampling frequency of 48 kHz, play is performed with sampling frequency unchanged at 48 kHz.</p> <p>48 kHz: During play, this compresses sampling frequency of 96 kHz discs to 48 kHz. 48 kHz discs are played as they are at a sampling frequency of 48 kHz.</p> <ul style="list-style-type: none"> You can select the sampling frequency to match that of the audio signal recorded on a disc. Simultaneous switching between Analog output/Digital output is performed to match your selected sampling frequency. Some 96kHz DVDs are copy protected. With this kind of disc, no signal is output from the digital output terminal. | 96kHz | 48kHz | | |

To return to the initial settings if they have been changed since you purchased the player, perform the following procedures. If power to the player is ON, switch it OFF. While power is OFF, press the  button while pressing the  button. All memorized settings are erased.





Setting the Basic Language and Subtitle Language

Basic language

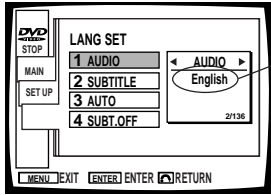

Change in order with the and buttons on the remote control.

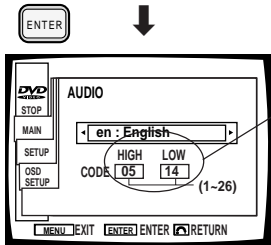

With the remote control number buttons, input the appropriate upper and lower language code input numbers as shown in the chart below.

Basic subtitle language

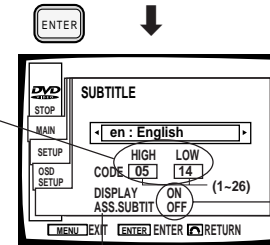
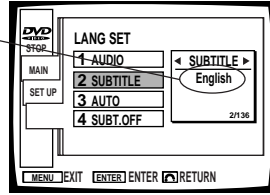

Press the remote control and buttons to make it flash, and then you can switch indication display ON or OFF with the and buttons.

Some discs provide subtitles offering explanations of scenes for those who are hard of hearing. Switching "ASS.SUBTIT" ON assures these subtitles are displayed from the beginning.

Language code chart

| Language | Language code | Input code (upper) | Input code (lower) |
|-------------|---------------|--------------------|--------------------|
| Japanese | ja | 10 | 01 |
| English | en | 05 | 14 |
| French | fr | 06 | 18 |
| German | de | 04 | 05 |
| Italian | it | 09 | 20 |
| Spanish | es | 05 | 19 |
| Dutch | nl | 14 | 12 |
| Russian | ru | 18 | 21 |
| Chinese | zh | 26 | 08 |
| Korean | ko | 11 | 15 |
| Greek | el | 05 | 12 |
| Afar | aa | 01 | 01 |
| Abkhazian | ab | 01 | 02 |
| Afrikaans | af | 01 | 06 |
| Amharic | am | 01 | 13 |
| Arabic | ar | 01 | 18 |
| Assamese | as | 01 | 19 |
| Aymara | ay | 01 | 25 |
| Azerbaijani | az | 01 | 26 |
| Bashkir | ba | 02 | 01 |
| Belorussian | be | 02 | 05 |

| Language | Language code | Input code (upper) | Input code (lower) |
|-----------------|---------------|--------------------|--------------------|
| Bulgarian | bg | 02 | 07 |
| Bihari | bh | 02 | 08 |
| Bislama | bl | 02 | 09 |
| Bengali, Bangla | bn | 02 | 14 |
| Tibetan | bo | 02 | 15 |
| Breton | br | 02 | 18 |
| Catalan | ca | 03 | 01 |
| Corsican | co | 03 | 15 |
| Czech | cs | 03 | 19 |
| Welsh | cy | 03 | 25 |
| Danish | da | 04 | 01 |
| Bhutani | dz | 04 | 26 |
| Esperanto | eo | 05 | 15 |
| Estonian | et | 05 | 20 |
| Basque | eu | 05 | 21 |
| Persian | fa | 06 | 01 |
| Finnish | fi | 06 | 09 |
| Fiji | fj | 06 | 10 |
| Faroese | fo | 06 | 15 |
| Frisian | fy | 06 | 25 |
| Irish | ga | 07 | 01 |



Setting the Basic Language and Subtitle Language

| Language | Language code | Input code (upper) | Input code (lower) |
|------------------|---------------|--------------------|--------------------|
| Scottish Gaelic | gd | 07 | 04 |
| Galician | gl | 07 | 12 |
| Guarani | gn | 07 | 14 |
| Gujarati | gu | 07 | 21 |
| Hausa | ha | 08 | 01 |
| Hindi | hi | 08 | 09 |
| Croatian | hr | 08 | 18 |
| Hungarian | hu | 08 | 21 |
| Armenian | hy | 08 | 25 |
| Interlingua | ia | 09 | 01 |
| Interlingue | ie | 09 | 05 |
| Inupiak | ik | 09 | 11 |
| Indonesian | in | 09 | 14 |
| Icelandic | is | 09 | 19 |
| Hebrew | iw | 09 | 23 |
| Yiddish | ji | 10 | 09 |
| Javanese | jw | 10 | 23 |
| Georgian | ka | 11 | 01 |
| Kazakh | kk | 11 | 11 |
| Greenlandic | kl | 11 | 12 |
| Cambodian | km | 11 | 13 |
| Kannada | kn | 11 | 14 |
| Kashmiri | ks | 11 | 19 |
| Kurdish | ku | 11 | 21 |
| Kirghiz | ky | 11 | 25 |
| Latin | la | 12 | 01 |
| Lingala | ln | 12 | 14 |
| Laotian | lo | 12 | 15 |
| Lithuanian | lt | 12 | 20 |
| Latvian, Lettish | lv | 12 | 22 |
| Malagasy | mg | 13 | 07 |
| Maori | mi | 13 | 09 |
| Macedonian | mk | 13 | 11 |
| Malayalam | ml | 13 | 12 |
| Mongolian | mn | 13 | 14 |
| Moldavian | mo | 13 | 15 |
| Marathi | mr | 13 | 18 |
| Malay | ms | 13 | 19 |
| Maltese | mt | 13 | 20 |
| Burmese | my | 13 | 25 |
| Nauru | na | 14 | 01 |
| Nepali | ne | 14 | 05 |
| Norwegian | no | 14 | 15 |
| Occitan | oc | 15 | 03 |
| (Afan) Oromo | om | 15 | 13 |
| Oriya | or | 15 | 18 |
| Panjabi | pa | 16 | 01 |

| Language | Language code | Input code (upper) | Input code (lower) |
|----------------|---------------|--------------------|--------------------|
| Polish | pl | 16 | 12 |
| Pashto, Pushto | ps | 16 | 19 |
| Portuguese | pt | 16 | 20 |
| Quechua | qu | 17 | 21 |
| Rhaeto-Romance | rm | 18 | 13 |
| Kirundi | rn | 18 | 14 |
| Rumanian | ro | 18 | 15 |
| Kinyarwanda | rw | 18 | 23 |
| Sanskrit | sa | 19 | 01 |
| Sindhi | sd | 19 | 04 |
| Sango | sg | 19 | 07 |
| Serbo-Croatian | sh | 19 | 08 |
| Singhalese | si | 19 | 09 |
| Slovak | sk | 19 | 11 |
| Slovenian | sl | 19 | 12 |
| Samoan | sm | 19 | 13 |
| Shona | sn | 19 | 14 |
| Somali | so | 19 | 15 |
| Albanian | sq | 19 | 17 |
| Serbian | sr | 19 | 18 |
| Siswati | ss | 19 | 19 |
| Sesotho | st | 19 | 20 |
| Sundanese | su | 19 | 21 |
| Swedish | sv | 19 | 22 |
| Swahili | sw | 19 | 23 |
| Tamil | ta | 20 | 01 |
| Telugu | te | 20 | 05 |
| Tajik | tg | 20 | 07 |
| Thai | th | 20 | 08 |
| Tigrinya | ti | 20 | 09 |
| Turkmen | tk | 20 | 11 |
| Tagalog | tl | 20 | 12 |
| Setswana | tn | 20 | 14 |
| Tongan | to | 20 | 15 |
| Turkish | tr | 20 | 18 |
| Tsonga | ts | 20 | 19 |
| Tartar | tt | 20 | 20 |
| Twi | tw | 20 | 23 |
| Ukrainian | uk | 21 | 11 |
| Urdu | ur | 21 | 18 |
| Uzbek | uz | 21 | 26 |
| Vietnamese | vi | 22 | 09 |
| Volapük | vo | 22 | 15 |
| Wolof | wo | 23 | 15 |
| Xhosa | xh | 24 | 08 |
| Yoruba | yo | 25 | 15 |
| Zulu | zu | 26 | 21 |

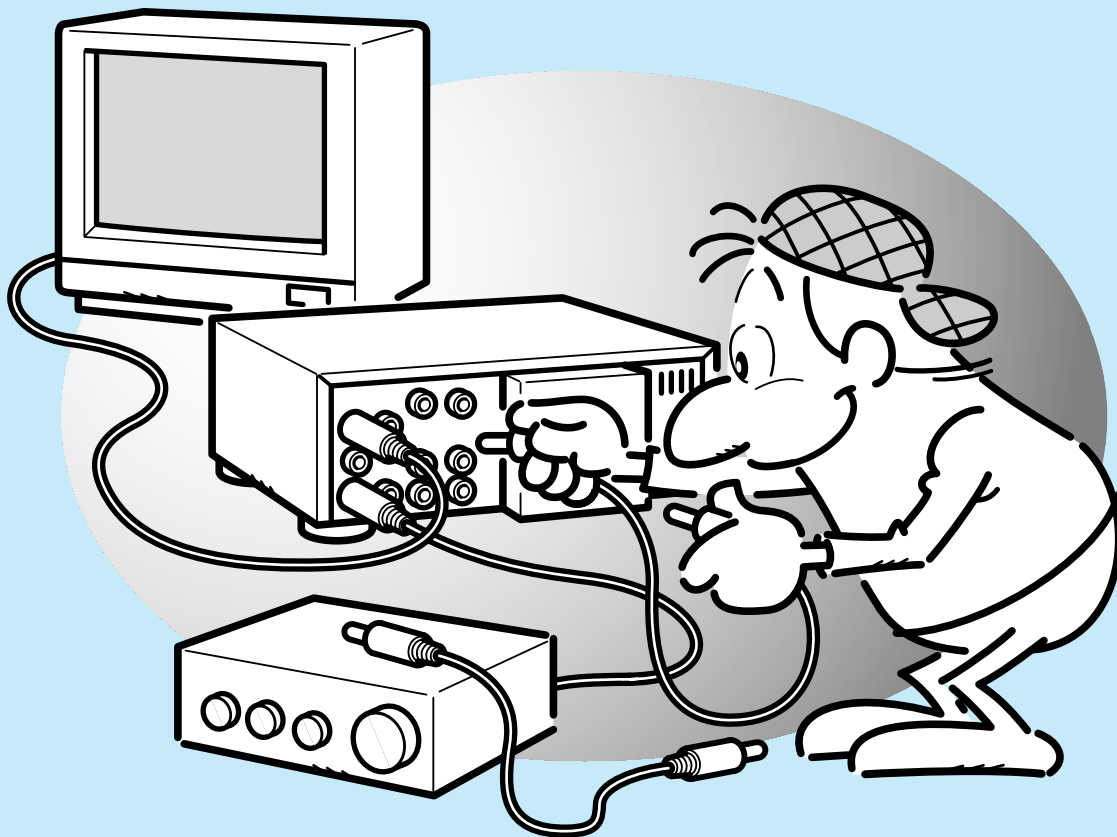

Set Up

Connecting the Player

| | |
|--|----|
| Connection example 1. To a TV with video input | 66 |
| Connection example 2. To an amp with Dolby Digital (AC-3) inputs | 67 |
| Connection example 3. AV amp | 68 |

Names and Functions

| | |
|----------------------|----|
| Front panel | 69 |
| Rear panel | 70 |
| Display window | 71 |
| Remote control | 72 |

Other Information

| | |
|-------------------------------|----|
| Troubleshooting | 73 |
| Terms | 75 |
| For Proper and Long Use | 77 |
| Specifications | 78 |

Connecting the Player

Precautions when connecting the player

This product is compatible with the Copy Guard analog copy protect system. Some discs feature a copy protect signal. If you connect this player to a TV via a VCR, and record this kind of disc and play back the recording on the VCR, the Copy Guard system may prevent you from getting a normal picture. Connect the DVD player either directly to the television or through an A/V amplifier.

Select the appropriate connection for your TV.

Connection example 1.

To a TV with video input

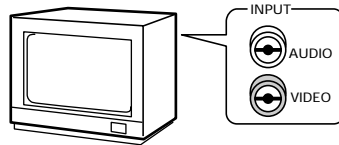

If your TV has a video input, and it is available for use, this is the easiest way to hook up the player. Follow the instructions in the TV's (monitor TV's) User's Manual.

When connecting a cassette deck or other component to the external input

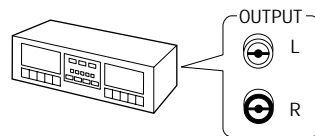

Connect like this when hooking up to the external input jack for karaoke entertainment with another component.

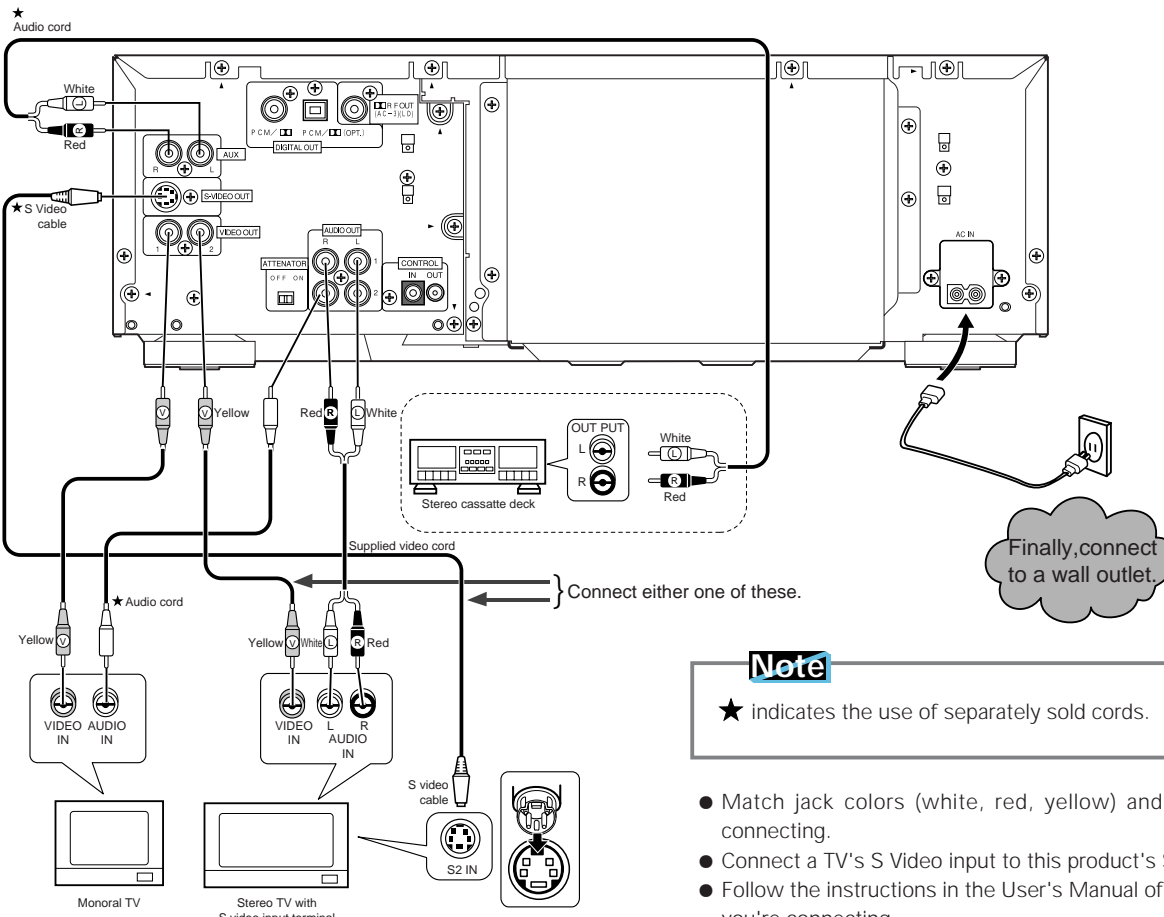

Note

★ indicates the use of separately sold cords.

- Match jack colors (white, red, yellow) and plug colors when connecting.
- Connect a TV's S Video input to this product's S2 Video output.
- Follow the instructions in the User's Manual of the TV (monitor TV) you're connecting.
- When the TV has multiple video inputs, select the desired source (Video 1, Video 2, etc.)

Connection example 2.

To an amp with Dolby Digital (AC-3) input

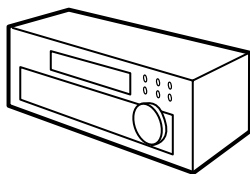

AV amplifier or AV receiver enabling Dolby Digital (AC-3) digital input and RF input in the same function.

- Connect this player's digital output PCM/DIGITAL jack to the Dolby Digital input jack of an amplifier or a receiver with Dolby Digital capability. Use coaxial digital output or optical digital output depending on the amplifier's or receiver's inputs.
- Connect this player's DIGITAL RF output (for LD) jack to the Dolby Digital (AC-3) RF input jack on an amplifier or receiver with Dolby Digital capability.
- **Perform the settings in the "Digital output" section on page 70, making sure to select PCM/DOLBY DIGITAL.** (When shipped from factory, PCM/DOLBY DIGITAL is selected.)
- Digital output of LD analog audio is not possible, so also connect this player's audio output jack and the amp audio input jack.

Note

★ indicates the use of separately sold cords.

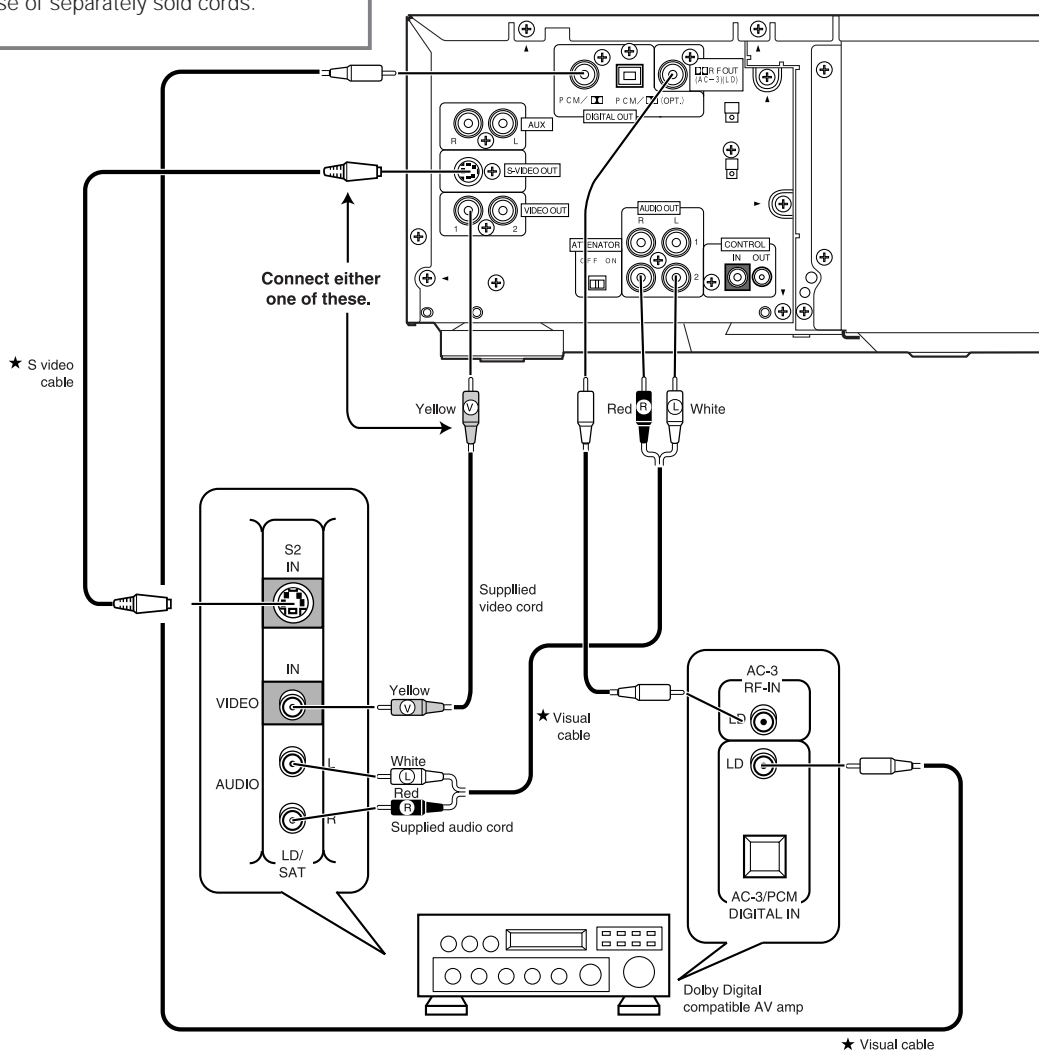

Notes

- Karaoke sound (mic sound, key control etc.) is not output as digital sound. When using for karaoke,
- ◆ Be sure to connect the DVD player's AUDIO OUT to the amplifier's AUDIO IN.
 - ◆ Switch the amplifier's SIGNAL SELECT setting to ANALOG. (When SIGNAL SELECT is set to AUTO, because digital sound is given priority, the karaoke function cannot be used.)

When playing a disc with this player, switch the function to the connected input jack on the player. In the case of diagram above, select LD/SAT terminals.

Some DVD format discs feature copy protect. With this kind of disc, when a sampling frequency of 96 kHz is selected, no signal is output from the digital output (see page 61).

Connection example 3.

AV amplifier

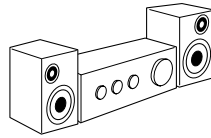

By connecting to a regular AV amp or stereo amp, you can enjoy playback with improved sound quality.

- Connect this player's audio output jacks to an amp's CD, LD, AUX or other audio input jacks. (Do not connect to PHONO jacks.)
- Connect this player's video output jack to the amplifier's or receiver's video input jack.
- When connecting to a digital output, refer to page 70.
- **When connecting to a component bearing the Pioneer SR mark.**
If you use a commercially available cord with mini plugs (no resistance) to connect this player's control input jack to the control output jack of the component bearing the SR mark, you can control the player as though it were a component in a system (system control).
- If you connect for system control, you cannot operate the player directly by pointing the remote control at it and pressing buttons.
- When controlling the unit as part of a system, be sure to connect to the amplifier with audio cord even if you are using only digital components. (System control is not possible if you connect using only cables with mini plugs.)
- If your AV amplifier is a Dolby Pro Logic decoder, you can enjoy surround sound.
- For more details, refer to the connected component's operating instructions.

When connecting to a digital output, refer to page 70.

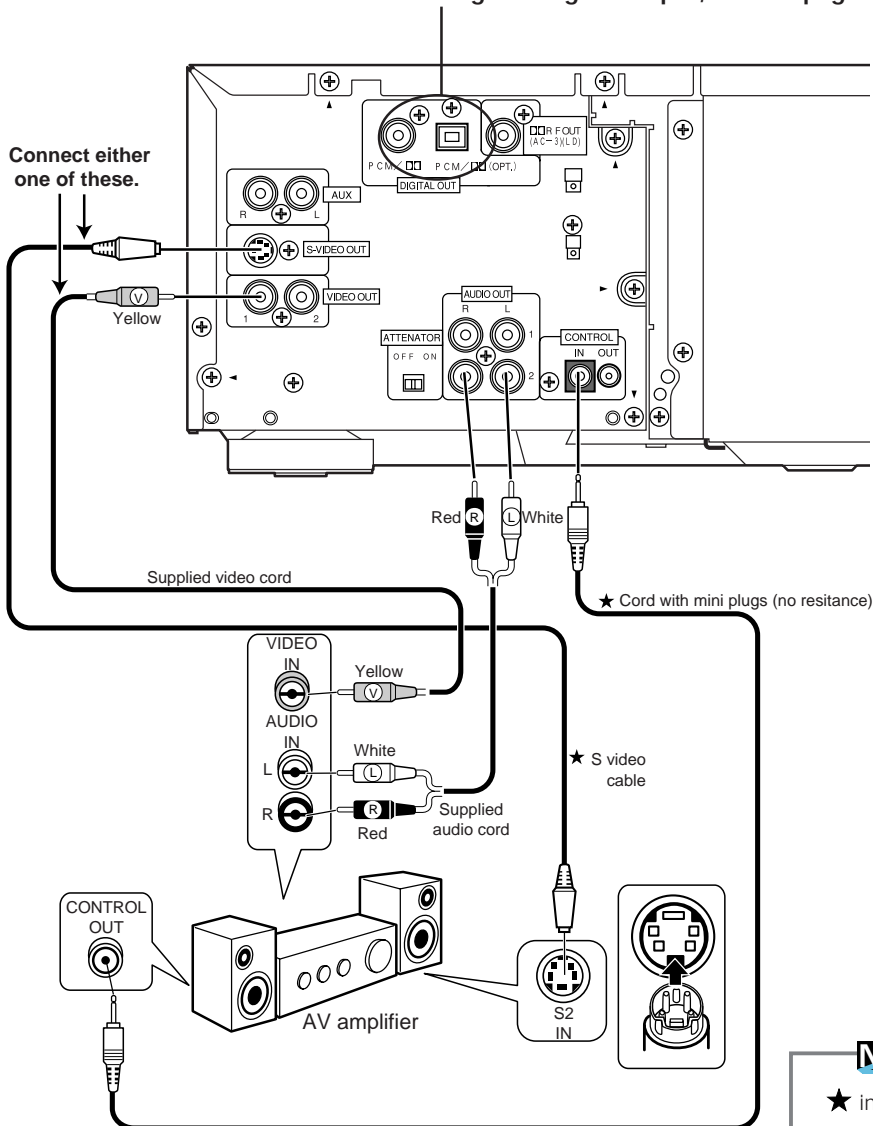

Note

★ indicates the use of separately sold cords.

Names and Functions

Front panel See page (P.) for instructions.

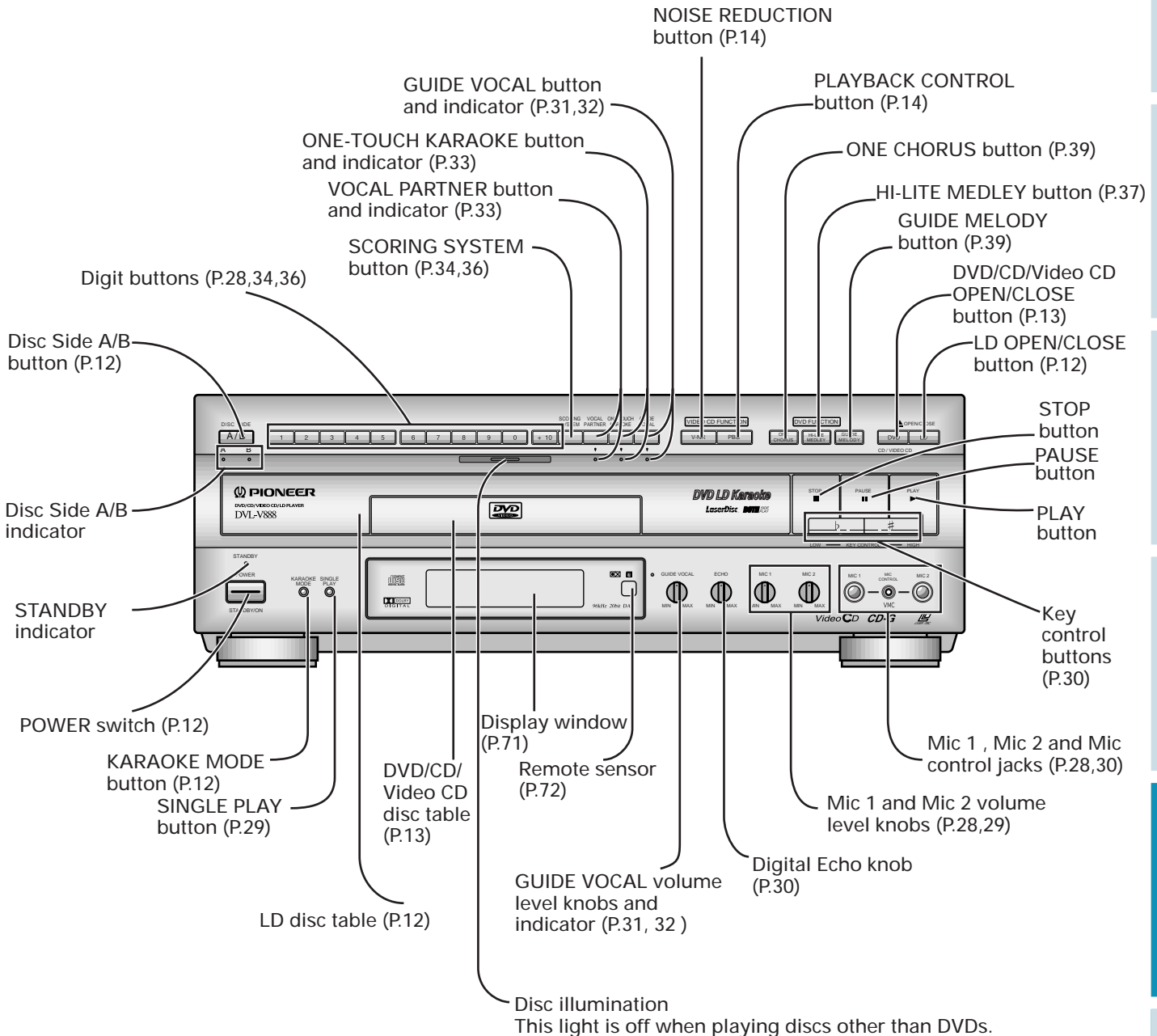

Basic Operation
Detailed Operation
Karaoke Operation
Setting
Set Up
Other Information

Rear panel

Digital Output Jack (Coaxial•Optical)

This is used for output of the digital audio signal recorded on DVDs, CDs, Video CDs and digital audio LDs.

Depending on the components connect, noise may be generated.

| | | | |
|----------|-------------------------------------|---------|--|
| Your amp | Regular AV amp | Coaxial | Connect to the PCM/DIG jack, and select PCM from a menu. |
| | | Optical | Connect to the optical jack, and select PCM from the menu. |
| | Dolby Digital (AC-3) compatible amp | Coaxial | Connect to the PCM/DIG jack, and select PCM/DOLBY DIGITAL from the menu. |
| | | Optical | Connect to the optical jack, and select PCM/DOLBY DIGITAL from the menu. |

Switching between PCM/DIG and PCM output is possible. If your amp is not Dolby Digital(AC-3) compatible, you should switch to PCM output. (Refer to the chart on the right).

Performing settings

- ① Turn amp volume down (to MIN).
- ② Load a DVD disc and set to the Stop mode, press the **(MENU)** button on the remote control.
 - Main menu is displayed.
- ③ Select the **[OUTPUT]** setting with the **(V)** button on the remote control.
- ④ Press digit button **(1)** on the remote control, and select **[DIG.OUTPUT]**.
- ⑤ Press digit button **(2)** on the remote control, and select **[PCM]**.

Note

Output of karaoke sound (sound from mics, Key control etc.) is not digital, so be sure to connect this player's audio output jack to your amp's audio input jack (AUDIO IN).

Tip

When switched for PCM output.... For digital output to a regular amp that is not Dolby Digital(AC-3) compatible, even audio recorded in Dolby Digital is converted to PCM output.
 When switched for PCM/DOLBY DIGITAL output.... PCM audio is output as PCM, and Dolby Digital audio is output as Dolby Digital.

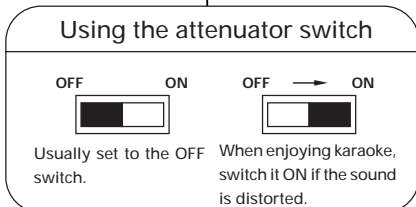
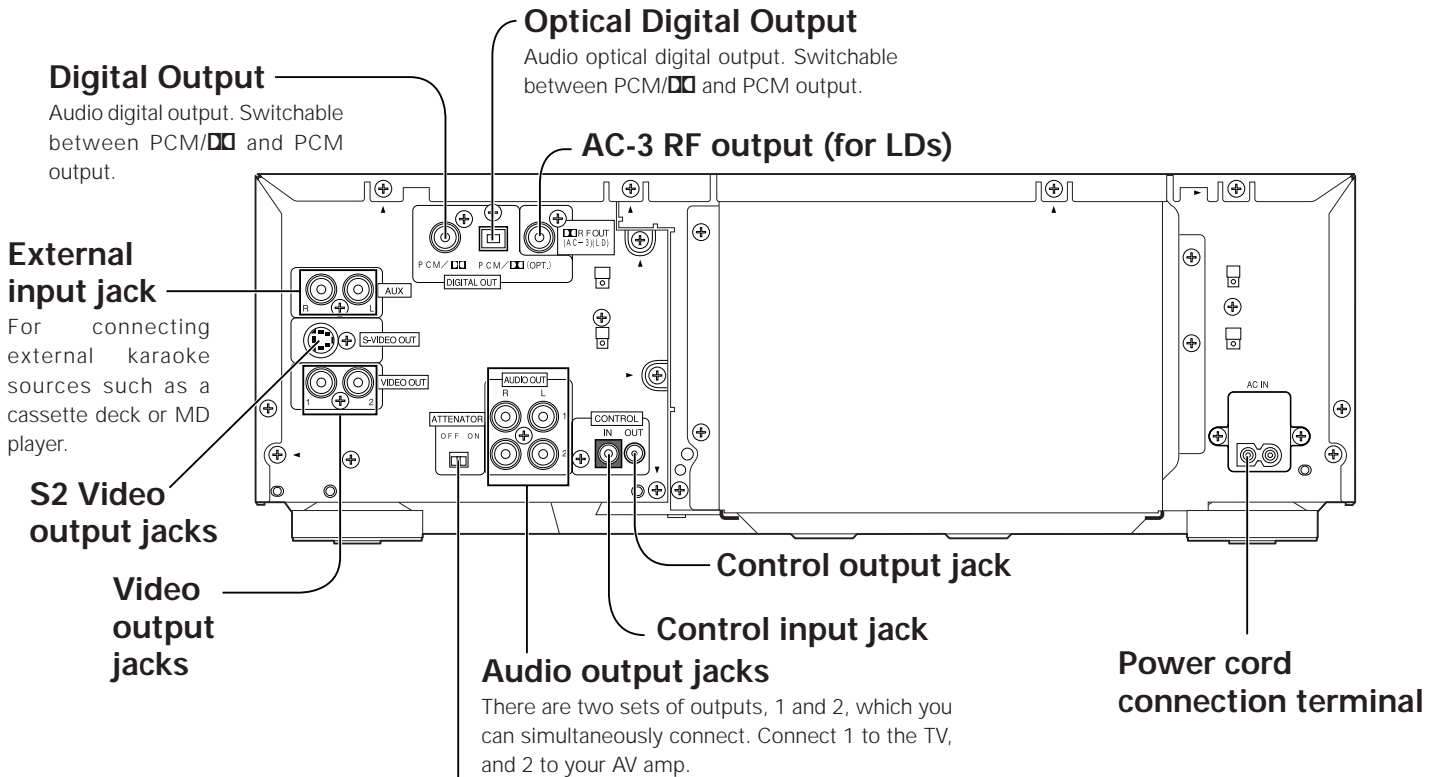

Display window

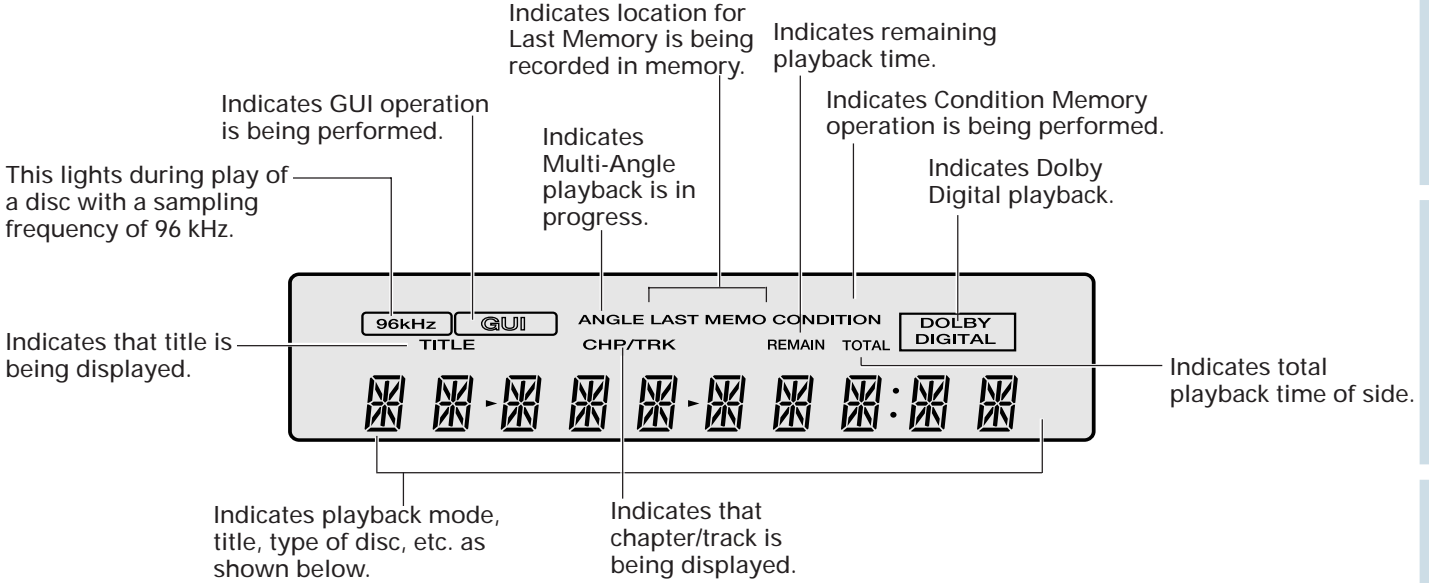

Sample Display



:Laser Disc



:Compact disc

CD V

:CD video

DVD

:DVD

VCD

:Video CD

OPEN

:Disc table is opening or is open

CLOSE

:Disc table is closing

PGM

:Program playback

R - TRK

:Repeat playback of the track

R - A

:Start point of 2 point repeat playback

R - AB

:2 point repeat playback

R - TTL

:Repeat playback of the title

R - CHP

:Repeat playback of the chapter

R - SID

:Both sides of LD repeat playback

STEREO

:Stereo

PBC PLAY

:During Video CD PBC play



:Playback



:Stop



:Pause

NO DISC

:No disc

-- OFF --

:Power is turned off

MENU

:Menu mode

TITLE

:Title menu

SETUP

:Set-up menu

AUX

:AUX function

COND - MEM

:Condition Memory

LAST - MEM

:Last Memory

Remote control

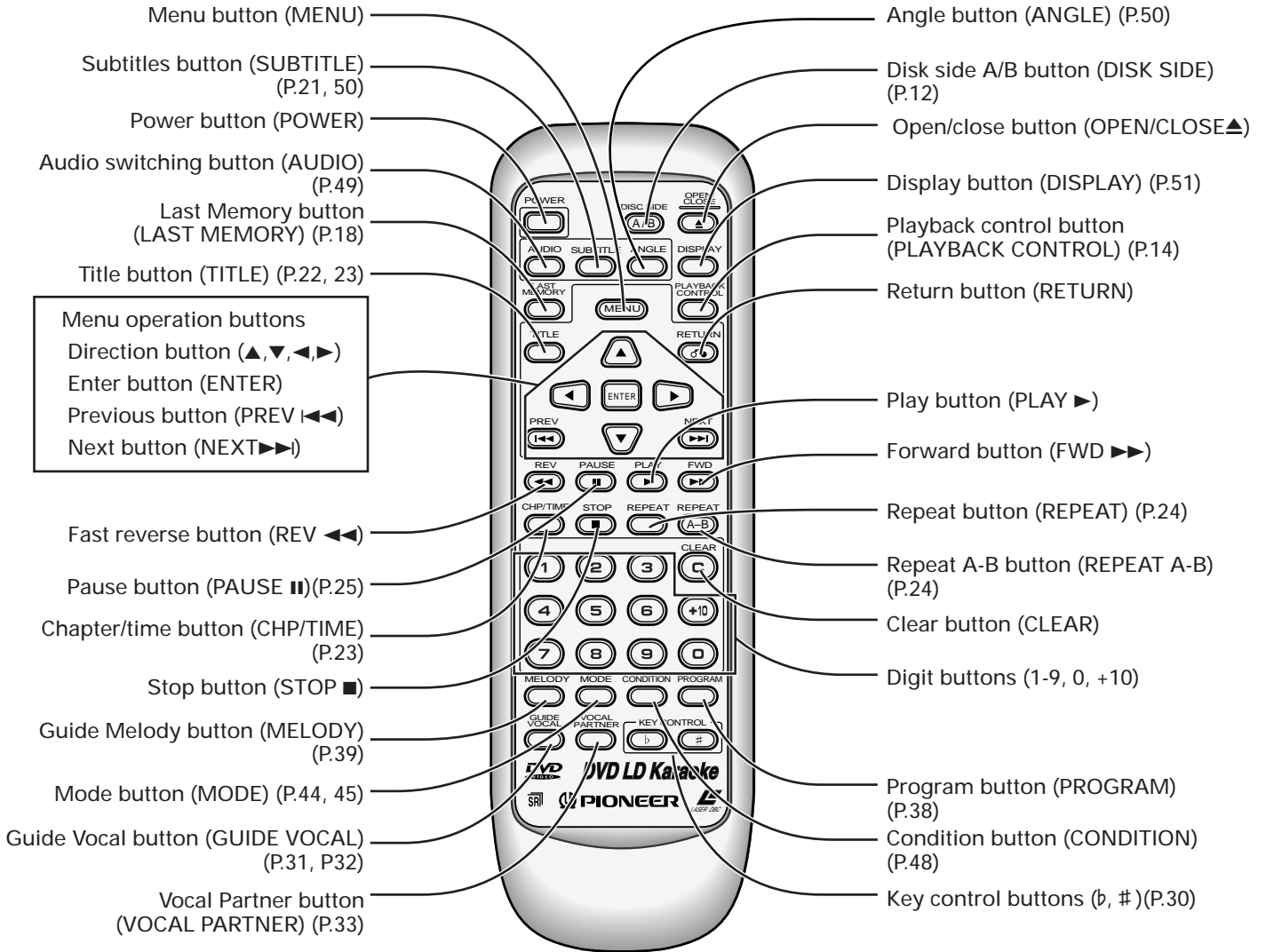

Remote control operation

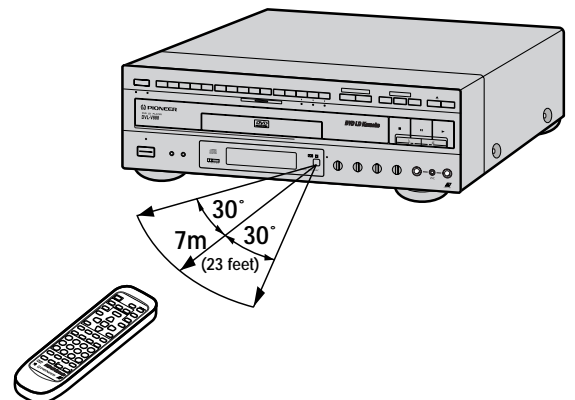

When operating the remote control, point it at the remote sensor located on the player's front panel. The remote control can be used up to 23 feet (7 m) from the player and within a 30° angle each side of the sensor.

- Exposing the remote sensor to direct sunlight or strong light may cause faulty operation.
- If the CONTROL IN jack on the player's rear panel is connected to another component, point the remote control at that component for operation. Operation is not possible when pointed at this player. (Refer to page 68.)
- When using the remote control, first press the POWER switch to turn on the player's power.



Troubleshooting

Incorrect operations are often mistaken for trouble and malfunctions. If you think that there is something wrong with this component, check the points below. Sometimes the trouble may lie in another component. Inspect the other components and electrical appliances being used. If the trouble cannot be rectified even after exercising the checks listed below, ask your nearest PIONEER authorized service center or your dealer to carry out repair work.

| | Symptom | Possible causes | Reference page |
|----------------|--|--|--------------------------------|
| Operation | 1. The disc table doesn't stay in even when it is closed. | <ul style="list-style-type: none"> ● Edges of the disc are dirty. ● The disc is not correctly loaded in the disc table. ● The region number is different. ● There's condensation inside the player. | P.9 P.12, 13 P.76 P.9 |
| | 2. Playback is not possible. | <ul style="list-style-type: none"> ● The TV system setting is not compatible with the application region. | P.10 |
| | 3. The picture is unclear during DVD play. | <ul style="list-style-type: none"> ● This player is compatible with copy guard analog copy protect system. Some discs may feature a copy protect signal. Playing this kind of disc with some TVs may result in horizontal lines in part of the picture and other picture defects, but this does not mean the player is malfunctioning. | P.66 |
| | 4. If I record a DVD on a VCR and play it back, or play a DVD through a VCR, the picture is unclear. | <ul style="list-style-type: none"> ● This player is compatible with copy guard analog copy protect system. Some discs may feature a copy protect signal. If you record this kind of disc on a VCR and play it back, or play this kind of disc through a VCR, the copy guard system prevents normal playback. | P.66 |
| | 5. Even if you play a Video CD with Playback Control, there's no menu displayed. Detailed still images are not possible. | <ul style="list-style-type: none"> ● Playback Control is switched OFF. | P.14 |
| | 6. The  mark appears on screen. | <ul style="list-style-type: none"> ● The selected operation is not possible with that disc. | |
| | 7. The picture stops, and operation buttons do not function. | <ul style="list-style-type: none"> ● Press the STOP  button, and then press PLAY again. | |
| Remote control | 8. The remote control doesn't operate. | <ul style="list-style-type: none"> ● The rear panel control input jack on the player is being used. ● You are too far from the player. Or the angle between the remote control and the remote control reception window is too large. ● The remote control's batteries are dead. | P.68 P.72 |
| | 9. TV and other components operate incorrectly. | <ul style="list-style-type: none"> ● Some TVs with wireless remote capability operate incorrectly with this player's remote control. | |
| Audio | 10. There's no sound. Sound is distorted. | <ul style="list-style-type: none"> ● Plugs are not pushed in sufficiently, or plugs are disconnected. ● Connection plugs and jacks are dirty. ● Audio cable connection is incorrect. ● Stereo amp operation is incorrect. (In particular, check that input selection for CD, LD etc. is correct.) ● The player is connected to a stereo amp's PHONE input jack. ● Play is paused. ● Digital output is set for 96kHz. Digital output may not be possible with certain discs. | P.66 – 68 |
| | 11. DVD, Video CD volume is low. | <ul style="list-style-type: none"> ● In the KARAOKE mode, DVD, CD and Video CD analog sound volume level is low. | P.13 |
| | 12. DVD sound volume level is low. | <ul style="list-style-type: none"> ● DVD sound volume level may sound lower than other discs, but this is due to the disc's recording system, and is not due to the player malfunctioning. | |
| | | | |

Troubleshooting

| Symptom | Possible causes | Reference page |
|--|--|----------------|
| Karaoke operations | | |
| 13.GUIDE VOCAL volume level is low. | <ul style="list-style-type: none"> The GUIDE VOCAL volume knob is set to a low level. | P.31, 32 |
| 14.Key control and Once more are not possible with a mic featuring controls. | <ul style="list-style-type: none"> The mic is not connected to the Mic control jack. | P.30 |
| 15.Even when playing a multiplex disc, the singer's voice cannot be heard. | <ul style="list-style-type: none"> ONE-TOUCH KARAOKE is ON. The GUIDE VOCAL volume knob is set to a low level. | P.33 |
| 16.There's howling. | <ul style="list-style-type: none"> The mic is too close to the speakers. | P.29 |
| 17.The HI-LITE MEDLEY and ONE CHORUS functions do not operate. | <ul style="list-style-type: none"> These are DVD karaoke disc functions only. You can enjoy them with discs bearing the HI-LITE MEDLEY and ONE CHORUS marks. (These functions do not operate with CDs, Video CDs and other discs) | P.37, 39 |
| 18."PICK A KARAOKE SONG" is automatically displayed. | <ul style="list-style-type: none"> The KARAOKE MODE is ON. | P.29 |
| 19.Key control and other karaoke related buttons do not operate. | <ul style="list-style-type: none"> When a menu is open during play, remote control buttons related to karaoke operation do not function. (Only song selection and reservation buttons operate) | P.30 |
| 20.Reserving songs is not possible with a DVD. | <ul style="list-style-type: none"> The DVD playing has a Menu function. | P.38 |
| 21.Song reservation is not possible with a Video CD with Playback Control. | <ul style="list-style-type: none"> Playback Control is switched OFF. | P.38 |
| 22.Karaoke operations aren't possible. | <ul style="list-style-type: none"> The selected mode is NORMAL. Press the KARAOKE MODE button on the main unit to select the KARAOKE MODE. | P.28 |
| 22.There's no sound from the mic. | <ul style="list-style-type: none"> The audio output jack is not connected to an amp with a digital input or the amp's SIGNAL SELECT setting is switched to AUTO. | P.67 |

Caution:

Abnormal functioning of this unit may be caused by static electricity, or other external interference. To restore normal operation, unplug the AC power cord and then plug it in again.

Terms

Dolby Digital (AC-3)*

Dolby Digital (AC-3) delivers up to 5.1 channels of discrete multi-channel audio. This is the same system that is used for surround sound in Dolby Digital equipped movie theaters.

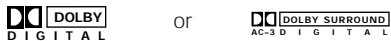

For DVD discs, the digital output PCM/Dolby Digital jack (coaxial or optical) must be connected to the amplifier or processor's digital input AC-3/PCM jack.

For LD discs, the AC-3 RF OUT (LD) jack must be connected to the amplifier's AC-3 RF IN jack.

PCM

PCM stands for Pulse Code Modulation and is digital audio. The digital audio of CD, LD or DVD discs is PCM.

Title number

Title numbers refer to titles of movies etc. As DVD discs have a large capacity, many movies can be recorded on one disc. For example, when 3 different movies are recorded on a disc, they are divided into TITLE 1, TITLE 2 and TITLE 3. Playback can be operated by selecting the title number.

Chapter number

Chapter numbers are the numbers assigned to sections on a title of the disc, similar to chapters in a book. If the disc includes these numbers, you can locate the section you want very quickly using chapter search and other functions.

- Some discs may not include chapter numbers.

Frame number

This is the number recorded in each frame on a standard CAV disc. You can use frame numbers for such operations as Frame Search for a desired frame.

Time number

The time number is the playback lapse time of a title in the disc from its beginning. The scene you want to locate can be searched for with the time number using the time number function etc.

Surround

This is a surround effect for karaoke fun with a more expansive sound and added atmosphere.

Echo

This provides an echo effect.

LD(Laserdisc)

Depending on the signal recording method used, there are two types of Laserdiscs: standard discs (CAV) and extended playing discs (CLV).

CAV

CAV disc jackets or labels are marked with "Standard disc/CAV" or "Standard Play".

CLV

CLV disc jackets or labels are marked with "Extended playing disc/CLV" or "Extended Play".

Laserdiscs with digital audio

These type of discs are recorded with digital audio signals in addition to the analog audio signals. This allows you to enjoy high quality digital sound along with the laser disc's high quality picture.



Multi audio discs with digital sound

These type of discs are recorded with different types of digital audio and analog audio content.



Digital audio or analog audio can be enjoyed by switching between them.

Graphics Discs

Besides video and audio signals, discs feature recorded subcode data. This data includes recorded graphics information.

CD graphics discs: Feature information such as karaoke lyrics and graphics (pictures) for more karaoke fun.

The mark on the right is displayed on the disc jacket or on the disc label.



TOC

TOC (Table Of Contents) information is data other than audio signal data, recorded at the beginning of a disc. As the name implies, it's like the list of contents in a book, with information such as the number of songs and playback time.

- Some LDs also feature a TOC.
- LDs and CDVs with a TOC belong to the "optical digital audio video disc system" family of discs.

* Manufactured under license from Dolby Laboratories. "Dolby", "AC-3" and the double-D symbol are trademarks of Dolby Laboratories. Confidential Unpublished Works. © 1992-1997 Dolby Laboratories, Inc. All rights reserved.

Terms

Video CDs

These discs provide MD quality sound, and VHS quality video images. Thanks to MPEG1, the digital signal compression system, a single disc provides up to 74 minutes of continuous digital audio and video. There are also Video CDs with Playback Control (PBC) that let you select playback of desired scenes using menus, and view still images.

Playback Control (PBC)

This refers to signals recorded on a Video CD (Version 2.0) enabling playback control.

You can use menus recorded on discs with PBC for easy, interactive Search for desired scenes, and playback.

You can also enjoy viewing high-resolution/standard resolution still images.

High-resolution images

If the high-resolution still images are recorded in the Video CD, you can enjoy viewing them with four times the resolution of moving images.

Screen saver

When a still picture is displayed for a long period a phenomena known as "screen burn" may occur.

To avoid this, computers are equipped with screen savers. Although reducing the brightness of the screen will produce the same effect, the screen saver on a computer automatically darkens the screen or produces a moving image that prevents strong light rays (bright colors) from being able to concentrate in one spot on the screen.

Multi-angle

When you watch regular TV programs you are watching the image filmed through the TV camera. Because of this the picture is displayed on your TV from the view point of the TV camera's position. In a TV studio the image is filmed by many cameras at the same time, and one of those images is selected by the program director and transmitted to your household TV. If all the filmed images were transmitted to your TV you would be able to select the camera image you want. Some DVD discs are recorded with the angles of all camera's used for filming and these can be selected using this player. These types of discs are called multi-angle discs.

Aspect ratio

Aspect ratio refers to the length to height ratio of TV screens. The ratio of a normal TV is 4:3, while the ratio of a Hi-vision TV or wide TV is 16:9. This allows you to enjoy a picture with a wider perspective.

Parental level

This function was suggested by parents. Parental level restrictions are restrictions incorporated into scenes that parents do not wish their children to view.

Condition memory

"Condition" refers to the various mode settings etc. On this player, various conditions, such as those set during playback etc. can be memorized. This function allows you to play back the same disc at any time without having to reset the condition settings.

Subtitle

Subtitles are language titles superimposed on movies etc. Up to 32 different subtitle languages can be recorded on a DVD disc. The subtitle function can be used to select the language of your choice.

Regional restriction codes (region number)

Regional restriction codes are built-in to DVD players and DVD discs for each sales region. If the regional code of the DVD player does not match one of the regional codes of the DVD disc, playback will not be possible. At this time an indicator will appear on the screen.

The region number is described on the rear panel.

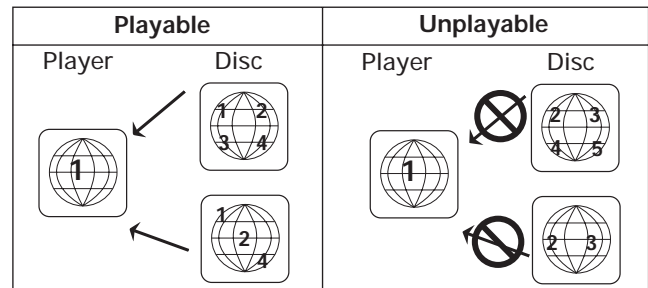

Optical digital output

Normally, audio is converted to an electric signal and transmitted through an electric wire from the player to the amplifier etc. Changing this signal to a digital signal and transmitting it through an optical fibre cable is called optical digital output. (Optical digital input is the side receiving the signal such as the amplifier etc.)

- PCM/DD: Choose this setting when connecting to the Dolby Digital (AC-3) optical digital input of an amp equipped with a Dolby Digital (AC-3) decoder.
- PCM: Choose this setting when connecting to the optical digital input of a regular amp, a Dolby Pro Logic amp etc.

Dynamic range

Dynamic range refers to the difference between the maximum conversion level for transmission/conversion of distortion free signals and noise and/or the minimum level limited by the equipment's characteristics. Decibel units (dB) are used.

For Proper and Long Use

■ DO NOT MOVE THE UNIT DURING PLAYBACK

During playback, the disc rotates at high speed. Do NOT lift or move the unit during playback. Doing so may damage the disc.

■ WHEN MOVING THE UNIT

When changing places of installation or packing the unit for moving, **be sure to remove the disc** and return the disc table to its original position in the player. Then, switch the power OFF. **Check that the "OFF" indication on the display goes off**, then disconnect the power cord. Leaving a disc loaded may result in damage when the unit is moved.

■ INSTALLATION PLACE

- Select a stable place to the side of a TV set or stereo system to be connected to the unit.
- When using the unit with a stereo system, install the speakers a little bit away from the TV.
- Do NOT install the unit on top of a TV or color monitor. Install the unit away from equipment that may be affected by magnetism, such as a cassette deck.

■ AVOID INSTALLING IN A PLACE THAT IS:

- Exposed to direct sunlight
- Exposed to humidity or where ventilation is poor
- Extremely hot or cold
- Exposed to vibration
- Exposed to dust
- Exposed to oily smoke, steam or heat (for example, a kitchen)

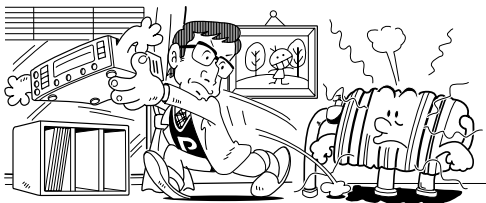

■ DO NOT PLACE AN OBJECT ON TOP

Do NOT place an object on the unit.

■ DO NOT BLOCK VENTS

Do NOT use the player on top of a long-fibered carpet, bed or sofa, and do not cover it with a cloth etc. This will prevent heat radiation and could result in damage.

■ AVOID HEAT

Do NOT place the unit on equipment generating heat, such as an amplifier.

When installing the unit in a rack, place it on the lowest shelf possible (however, not where it is exposed to dust) and separated from the amplifier to avoid the heat generated by the amplifier or other audio equipment.

■ CAUTION: WHEN PLACING THE UNIT IN A STEREO RACK WITH GLASS DOORS

Be sure there is ample space between the unit and the glass doors when opening the disc table using the remote control.

If the disc table opens against strong resistance, **such as a closed glass door**, damage to the unit may result.

■ SWITCH POWER OFF WHEN NOT USING THE UNIT

Depending on the strength of the TV or radio broadcast signal, having the TV or radio ON while power to the unit is ON may result in stripes on the TV screen or noise. However, this is not a malfunction of this unit or the TV or radio. In such a case, switch power to the unit OFF.

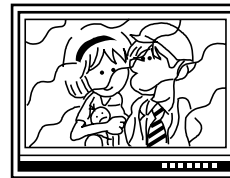

When the DVD/LD player's audio output is connected to a TV, VTR, or other component's audio input, excessively high signal input from a mic when enjoying karaoke may result in distortion and other adverse effects. If this happens, turn mic volume down, or switch the Attenuator switch on the rear of the player ON. (See P.70.)

POWER-CORD CAUTION

Handle the power cord by the plug. Do not pull out the plug by tugging the cord and never touch the power cord when your hands are wet as this could cause a short circuit or electric shock. Do not place the unit, a piece of furniture, etc., on the power cord, or pinch the cord. Never make a knot in the cord or tie it with other cords. The power cords should be routed in such a way that they are not likely to be stepped on. A damaged power cord can cause a fire or give you an electrical shock. Check the power cord once in a while. When you find it damaged, ask your nearest PIONEER authorized service center or your dealer for a replacement.

Specifications

General

System DVD system, LaserVision Disc system and Compact Disc digital audio system
 Laser Semiconductor laser: wavelength 650 nm, 780 nm
 Power requirements: 120V / 60Hz
 Power consumption 57 W
 Weight 8.6 kg (18 lb 15 oz)
 Dimensions 420 (W) x 466 (D) x 146 (H) mm
 (16^{-3/16} (W) x 18^{-3/16} (D) x 5^{-3/4} (H) in.)
 (Not including protruding cables, etc.)
 Operating temperature +5°C to +35°C
 (+41°F to +95°F)
 Operating humidity 5% to 85% (no condensation)

S2-Video Output level

Y (luminance) - Output level 1 Vp-p (75 Ω)
 C (color) - Output level 286 mVp-p (75 Ω)
 Jacks S-VIDEO jacks

Video Output (2 pairs)

Output level 1 Vp-p (75 Ω when loaded, synchronous negative)
 Jacks RCA jacks

Audio Output (2 pairs)

Output level
 During analog audio output 200 mVrms (1 kHz, 40%)
 During digital audio output 200 mVrms (1 kHz, -20 dB)
 Number of channels 2
 Jacks RCA jacks

Parental Lock Secret Number

- Make a record of your secret number in case you forget it.

Digital audio characteristics

| | |
|--------------------|--|
| Frequency response | 4 Hz to 22 kHz (DVD fs: 48 kHz) 4 Hz to 20 kHz (LD, CD) |
| S/N ratio | 115 dB (EIAJ) |
| Dynamic range | 97 dB (EIAJ) |
| Wow and flutter | Limit of measurement (±0.001% W. PEAK) or lower (EIAJ) |

Other Terminals

Optical digital output (PCM/□□(optical)) Optical digital jack
 Coaxial digital output (PCM/□□) RCA jack
 AC-3 RF output (for LD) RCA jack
 CONTROL IN Minijack (3.5Ø)
 CONTROL OUT Minijack (3.5Ø)
 AUX Input RCA jack

Accessories

Remote control unit 1
 AA/R6P dry cell batteries 2
 Audio cord 1
 Video cord 1
 Power cord 1
 Warranty card 2
 Operating Instructions 1

NOTE:

The specifications and design of this product are subject to change without notice, due to improvement.

Should this product require service in the U.S.A. and you wish to locate the nearest Pioneer Authorized Independent Service Company, or if you wish to purchase replacement parts, operating instructions, service manuals, or accessories, please call the number shown below.

1 - 8 0 0 - 8 7 2 - 4 1 5 9

Please do not ship your product to Pioneer without first calling the Customer Service Department at the above listed number for assistance.

PIONEER ELECTRONICS SERVICE, INC.
CUSTOMER SUPPORT DIVISION
P.O. BOX 1760, LONG BEACH,
CA 90801-1760, U.S.A.

For warranty information please see the Limited Warranty sheet included with your product.

Should this product require service in Canada, please contact a Pioneer authorized dealer in Canada to locate the nearest Pioneer Authorized Service Company. Alternatively, please contact or ship your defective product freight prepaid to one of the following Factory Service locations closest to you:

Pioneer Electronics of Canada, Inc.

Factory Service East
300 Allstate Parkway
Markham, ON L3R 0P2
(905) 479-4411

Factory Service West
13911 Bridgeport Road
Richmond, BC V6V 1J6
(604) 278-1014

For warranty information please see the Limited Warranty sheet included with your product.

Si ce produit doit être réparé au Canada, veuillez vous adresser à un distributeur autorisé Pioneer au Canada pour obtenir le nom de la société de service autorisée Pioneer la plus près de chez vous. Ou encore, veuillez communiquer avec le centre de service en usine Pioneer le plus près de chez vous ou faire parvenir l'article défectueux, port payé, à ce centre.

Pioneer électroniques du Canada, Inc.

Service en usine - Est
300 Allstate Parkway
Markham (Ontario) L3R 0P2
(905) 479-4411

Service en usine - Ouest
13911 Bridgeport Road
Richmond (C.-B.) V6V 1J6
(604) 278-1014

Pour obtenir des renseignements sur la garantie, veuillez vous reporter au feuillet sur la Garantie Limitée qui accompagne le produit.

Published by Pioneer Electronic Corporation.
Copyright © 1998 Pioneer Electronic Corporation.
All rights reserved.

LaserDisc is a trademark of Pioneer Electronic Corporation.

PIONEER ELECTRONIC CORPORATION 4-1, Meguro 1-Chome, Meguro-ku, Tokyo 153-8654, Japan

PIONEER NEW MEDIA TECHNOLOGIES, INC.

Headquarters: 2265 East 220th Street, Long Beach, California 90810, U.S.A. TEL: (310)952-2111

PIONEER ELECTRONICS OF CANADA, INC.

Toronto Head Office: 300 Allstate Parkway, Markham, Ontario L3R 0P2, Canada TEL: (905)479-4411