

Pioneer *sound.vision.soul*

Operating Instructions



HDMI



ELITE

Blu-ray Disc PLAYER

BDP-95 FD

Thank you for buying this Pioneer product.

Please read through these operating instructions so you will know how to operate your model properly.

After you have finished reading the instructions, put them away in a safe place for future reference.

IMPORTANT



The lightning flash with arrowhead symbol, within an equilateral triangle, is intended to alert the user to the presence of uninsulated "dangerous voltage" within the product's enclosure that may be of sufficient magnitude to constitute a risk of electric shock to persons.

CAUTION

**RISK OF ELECTRIC SHOCK
DO NOT OPEN**

CAUTION:

TO PREVENT THE RISK OF ELECTRIC SHOCK, DO NOT REMOVE COVER (OR BACK). NO USER-SERVICEABLE PARTS INSIDE. REFER SERVICING TO QUALIFIED SERVICE PERSONNEL.



The exclamation point within an equilateral triangle is intended to alert the user to the presence of important operating and maintenance (servicing) instructions in the literature accompanying the appliance.

D3-4-2-1-1_En-A

IMPORTANT NOTICE – THE SERIAL NUMBER FOR THIS EQUIPMENT IS LOCATED IN THE REAR. PLEASE WRITE THIS SERIAL NUMBER ON YOUR ENCLOSED WARRANTY CARD AND KEEP IN A SECURE AREA. THIS IS FOR YOUR SECURITY.

D1-4-2-6-1_En

NOTE: This equipment has been tested and found to comply with the limits for a Class B digital device, pursuant to Part 15 of the FCC Rules. These limits are designed to provide reasonable protection against harmful interference in a residential installation. This equipment generates, uses, and can radiate radio frequency energy and, if not installed and used in accordance with the instructions, may cause harmful interference to radio communications. However, there is no guarantee that interference will not occur in a particular installation. If this equipment does cause harmful interference to radio or television reception, which can be determined by turning the equipment off and on, the user is encouraged to try to correct the interference by one or more of the following measures:

- Reorient or relocate the receiving antenna.
- Increase the separation between the equipment and receiver.
- Connect the equipment into an outlet on a circuit different from that to which the receiver is connected.
- Consult the dealer or an experienced radio/TV technician for help.

D8-10-1-2_En

Information to User

Alteration or modifications carried out without appropriate authorization may invalidate the user's right to operate the equipment.

D8-10-2_En

This Class B digital apparatus complies with Canadian ICES-003.

Cet appareil numérique de la Classe B est conforme à la norme NMB-003 du Canada.

D8-10-1-3_EF

CAUTION: This product satisfies FCC regulations when shielded cables and connectors are used to connect the unit to other equipment. To prevent electromagnetic interference with electric appliances such as radios and televisions, use shielded cables and connectors for connections.

D8-10-3a_En

FEDERAL COMMUNICATIONS COMMISSION DECLARATION OF CONFORMITY

This device complies with part 15 of the FCC Rules. Operation is subject to the following two conditions: (1) This device may not cause harmful interference, and (2) this device must accept any interference received, including interference that may cause undesired operation.

Product Name: Blu-ray Disc PLAYER

Model Number: BDP-95FD

Responsible Party Name: PIONEER ELECTRONICS SERVICE, INC.

Address: 1925 E. DOMINGUEZ ST. LONG BEACH, CA 90801-1760, U.S.A.

Phone: 800-421-1404

CAUTION : USE OF CONTROLS OR ADJUSTMENTS OR PERFORMANCE OF PROCEDURES OTHER THAN THOSE SPECIFIED HEREIN MAY RESULT IN HAZARDOUS RADIATION EXPOSURE.

CAUTION : THE USE OF OPTICAL INSTRUMENTS WITH THIS PRODUCT WILL INCREASE EYE HAZARD. D6-8-2-1_En

IMPORTANT SAFETY INSTRUCTIONS

- 1) Read these instructions.
- 2) Keep these instructions.
- 3) Heed all warnings.
- 4) Follow all instructions.
- 5) Do not use this apparatus near water.
- 6) Clean only with dry cloth.
- 7) Do not block any ventilation openings. Install in accordance with the manufacturer's instructions.
- 8) Do not install near any heat sources such as radiators, heat registers, stoves, or other apparatus (including amplifiers) that produce heat.
- 9) Do not defeat the safety purpose of the polarized or grounding-type plug. A polarized plug has two blades with one wider than the other. A grounding type plug has two blades and a third grounding prong. The wide blade or the third prong are provided for your safety. If the provided plug does not fit into your outlet, consult an electrician for replacement of the obsolete outlet.
- 10) Protect the power cord from being walked on or pinched particularly at plugs, convenience receptacles, and the point where they exit from the apparatus.
- 11) Only use attachments/accessories specified by the manufacturer.
- 12) Use only with the cart, stand, tripod, bracket, or table specified by the manufacturer, or sold with the apparatus. When a cart is used, use caution when moving the cart/apparatus combination to avoid injury from tip-over.
- 13) Unplug this apparatus during lightning storms or when unused for long periods of time.
- 14) Refer all servicing to qualified service personnel. Servicing is required when the apparatus has been damaged in any way, such as power-supply cord or plug is damaged, liquid has been spilled or objects have fallen into the apparatus, the apparatus has been exposed to rain or moisture, does not operate normally, or has been dropped.



CAUTION

This product is a class 1 laser product, but this product contains a laser diode higher than Class 1. To ensure continued safety, do not remove any covers or attempt to gain access to the inside of the product. Refer all servicing to qualified personnel.



The following caution label appears on your unit.
Location: inside of the unit

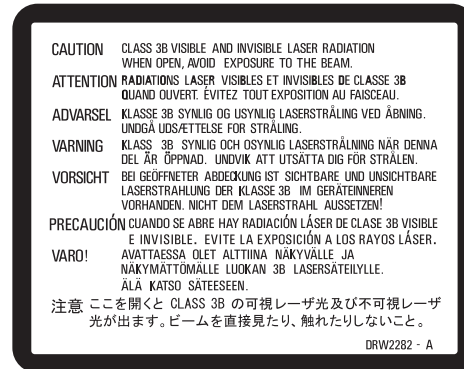

D3-4-2-1-8_B_En

WARNING

To prevent a fire hazard, do not place any naked flame sources (such as a lighted candle) on the equipment.

D3-4-2-1-7a_A_En

VENTILATION CAUTION

When installing this unit, make sure to leave space around the unit for ventilation to improve heat radiation (at least 10 cm at top, 10 cm at rear, and 10 cm at each side).

WARNING

Slots and openings in the cabinet are provided for ventilation to ensure reliable operation of the product, and to protect it from overheating. To prevent fire hazard, the openings should never be blocked or covered with items (such as newspapers, table-cloths, curtains) or by operating the equipment on thick carpet or a bed.

D3-4-2-1-7b_A_En

Operating Environment

Operating environment temperature and humidity: +5 °C to +35 °C (+41 °F to +95 °F); less than 85 %RH (cooling vents not blocked)

Do not install this unit in a poorly ventilated area, or in locations exposed to high humidity or direct sunlight (or strong artificial light)

D3-4-2-1-7c_A_En

WARNING

This equipment is not waterproof. To prevent a fire or shock hazard, do not place any container filled with liquid near this equipment (such as a vase or flower pot) or expose it to dripping, splashing, rain or moisture.

D3-4-2-1-3_B_En

WARNING

Before plugging in for the first time, read the following section carefully.

The voltage of the available power supply differs according to country or region. Be sure that the power supply voltage of the area where this unit will be used meets the required voltage (e.g., 230 V or 120 V) written on the rear panel.

D3-4-2-1-4_A_En

If the AC plug of this unit does not match the AC outlet you want to use, the plug must be removed and appropriate one fitted. Replacement and mounting of an AC plug on the power supply cord of this unit should be performed only by qualified service personnel. If connected to an AC outlet, the cut-off plug can cause severe electrical shock. Make sure it is properly disposed of after removal. The equipment should be disconnected by removing the mains plug from the wall socket when left unused for a long period of time (for example, when on vacation).

D3-4-2-2-1a_A_En

CAUTION

The  STANDBY/ON switch on this unit will not completely shut off all power from the AC outlet. Since the power cord serves as the main disconnect device for the unit, you will need to unplug it from the AC outlet to shut down all power. Therefore, make sure the unit has been installed so that the power cord can be easily unplugged from the AC outlet in case of an accident. To avoid fire hazard, the power cord should also be unplugged from the AC outlet when left unused for a long period of time (for example, when on vacation).

D3-4-2-2-2a_A_En

WARNING: Handling the cord on this product or cords associated with accessories sold with the product will expose you to chemicals listed on proposition 65 known to the State of California and other governmental entities to cause cancer and birth defect or other reproductive harm.

Wash hands after handling

D36-P4_A_En

This product contains mercury. Disposal of this material may be regulated due to environmental considerations. For disposal or recycling information, please contact your local authorities or the Electronics Industries Alliance : www.eiae.org.

K057_En

This product is for general household purposes. Any failure due to use for other than household purposes (such as long-term use for business purposes in a restaurant or use in a car or ship) and which requires repair will be charged for even during the warranty period.

K041_En

POWER-CORD CAUTION

Handle the power cord by the plug. Do not pull out the plug by tugging the cord and never touch the power cord when your hands are wet as this could cause a short circuit or electric shock. Do not place the unit, a piece of furniture, etc., on the power cord, or pinch the cord. Never make a knot in the cord or tie it with other cords. The power cords should be routed such that they are not likely to be stepped on. A damaged power cord can cause a fire or give you an electrical shock. Check the power cord once in a while. If you find it damaged, contact the Pioneer service center on the back cover, or your dealer for a replacement.

This product incorporates copyright protection technology that is protected by method claims of certain U.S. patents and other intellectual property rights owned by Macrovision Corporation and other rights owners. Use of this copyright protection technology must be authorized by Macrovision Corporation, and is intended for home and other limited viewing uses only unless otherwise authorized by Macrovision Corporation. Reverse engineering or disassembly is prohibited.



C67-7-3_En



We Want You Listening For A Lifetime

Since hearing damage from loud noise is often undetectable until it is too late, this manufacturer and the Electronic Industries Association's Consumer Electronics Group recommend you avoid prolonged exposure to excessive noise. This list of sound levels is included for your protection.

Dear Customer:

Selecting fine audio equipment such as the unit you've just purchased is only the start of your musical enjoyment. Now it's time to consider how you can maximize the fun and excitement your equipment offers. This manufacturer and the Electronic Industries Association's Consumer Electronics Group want you to get the most out of your equipment by playing it at a safe level. One that lets the sound come through loud and clear without annoying blaring or distortion-and, most importantly, without affecting your sensitive hearing.

Sound can be deceiving. Over time your hearing "comfort level" adapts to higher volumes of sound. So what sounds "normal" can actually be loud and harmful to your hearing. Guard against this by setting your equipment at a safe level BEFORE your hearing adapts.

To establish a safe level:

- Start your volume control at a low setting.
- Slowly increase the sound until you can hear it comfortably and clearly, and without distortion.

Once you have established a comfortable sound level:

- Set the dial and leave it there.

Taking a minute to do this now will help to prevent hearing damage or loss in the future. After all, we want you listening for a lifetime.

Decibel Level Example

30	Quiet library, soft whispers
40	Living room, refrigerator, bedroom away from traffic
50	Light traffic, normal conversation, quiet office
60	Air conditioner at 20 feet, sewing machine
70	Vacuum cleaner, hair dryer, noisy restaurant
80	Average city traffic, garbage disposals, alarm clock at two feet.

THE FOLLOWING NOISES CAN BE DANGEROUS UNDER CONSTANT EXPOSURE

90	Subway, motorcycle, truck traffic, lawn mower
100	Garbage truck, chain saw, pneumatic drill
120	Rock band concert in front of speakers, thunderclap
140	Gunshot blast, jet plane
180	Rocket launching pad

Information courtesy of the Deafness Research Foundation.



5001_En

Contents

01 Before you start

Features	7
What's in the box	8
Putting the batteries in the remote control	8
Using the remote control	8
Disc/content format playback compatibility	9
File compatibility	9
Titles and chapters	10
DVD-Video regions	10
BD-ROM regions	10

02 Connecting up

Rear panel	11
Easy connections	12
Using other types of video output	12
Connecting for HDMI output	13
Connecting using the component video output	13
Changing the output video resolution	14
Connecting using an S-Video output	14
Connecting for surround sound	15
Network connection	16
Controlling this player via another Pioneer component	16
Using an external IR receiver with this player	17

03 Controls and displays

Front panel	18
Front panel display	18
Remote control	19

04 Getting Started

Switching on and setting up	20
Using the on-screen displays	21
Setting up for network use	21
Playing movies, music and photos	22
Playing BD/DVD movies and Audio CD	22
Playback controls	23
Frequently Asked Questions	26

05 Using the Disc Navigator

Introduction	27
Movie Navigator	27
Photo Navigator	28
Music Navigator	30

06 Using the Home Media Gallery

Introduction	32
About network playback	32
Using the Home Media Gallery	33
Movie Navigator	33
Photo Navigator	35
Music Navigator	36
About Windows Media Player 11/Windows Media Connect	38

07 Video/Audio Adjust menu

Video Adjust	39
Audio Adjust	40

08 Initial Setup menu

Using the Initial Setup menu	41
About the audio output settings	44
Speaker Setup	45
Software updating	45

09 Additional information

Taking care of your player and discs	46
Screen sizes and disc formats	47
Resetting the player	47
Setting up the remote to control your TV	48
TV Preset code list	48
BD/DVD language code list	49
BD/DVD country/area code list	49
Troubleshooting	49
Glossary	54
License	56
Specifications	65

Chapter 1

Before you start

Features

BD-ROM playback

Blu-ray Disc is a next-generation video disc format featuring far higher disc capacity than conventional DVD. The higher capacity makes a whole range of new and enhanced features possible, such as support for high-definition video up to 1920 x 1080 pixels, high quality, surround sound audio, greater interactivity and richer content.

BD-ROM discs are commercially produced discs (Video Distribution format) that can contain movie and other video content, interactive content, enhanced menu features such as pop-up menus (press **POPUP MENU/MENU** during playback for these), full-color, high-definition animated buttons and animated menu transition effects, button sounds (sounds are played when menu buttons are selected or activated), high-definition bitmap subtitles supporting full-color images with frame-accurate animation effects up to full video frame rate, and so on.

While BD capacity is enough for most applications, the BD-ROM standard allows for content to be spread across several discs, removing the limit of one physical disc. Follow the on-screen instructions during playback when using these special kinds of discs.

BD-J application



esmertec

The BD-ROM specification supports Java for interactive content. The Java specification for BD-ROM is known as BD-J. This allows content providers to put games and other interactive material linked to specific titles on to BD-ROM discs. (This player does not support downloadable BD-J content, direct connection to the Internet or the retrieval of content through the Internet.)

- *Java and all Java-based trademarks and logos are trademarks or registered trademarks of Sun Microsystems, Inc. in the U.S. and other countries.*
- © 2000-2007 Esmertec AG
Esmertec and Jbed are trademarks and/or registered trademarks of Esmertec AG.

Connect to a local area network

Connect this player to one or more computers in your house via Ethernet and use them as media servers, streaming audio, video and still image files for playback on your TV and/or audio system.

HDMI digital interface

The HDMI (High-Definition Multimedia Interface) interconnect provides high quality digital audio and video, all from a single user-friendly connector. HDMI is the first consumer electronics interface to support uncompressed standard, enhanced, or high-definition video plus standard to multi-channel surround sound audio, all using one interface. You can easily connect to an HDMI-equipped AV receiver or audio-visual device for high quality audio and video.

- *HDMI, the HDMI logo and High-Definition Multimedia Interface are trademarks or registered trademarks of HDMI Licensing LLC.*

HDMI Control

By connecting this unit to a Pioneer plasma display or AV system (amplifier or AV receiver etc.) with an HDMI cable, you can control this unit from the connected plasma display, as well as have the connected plasma display or AV system automatically change inputs in response to this unit starting playback or having the GUI screen (ex. Disc Navigator) displayed (known as the Auto-select function). The connected plasma display can thereby have its power turned from off to on by this function.

You can also have this unit turn on automatically when you control this unit from a connected plasma display that is turned on (Simultaneous power function).

Additionally, when the language information from a connected plasma display is received, you can have this unit's on-screen display language change automatically to that of the plasma display (only when playback is stopped and GUI screen is not displayed).

Refer to your plasma display's operating manual for more information regarding how your plasma display transmits language information.

For more information about which operations can be carried out by connecting via HDMI cable, refer to the operating manual for your plasma display or AV system.

PureCinema

When you playback film material (24 frames/second) on a BD-ROM or DVD-Video disc, the progressive scan line automatically converts the film material to optimum quality (see *PureCinema* on page 39).

1080/60p and 1080/24p output video

This player supports a variety of output video resolutions, up to 1080 lines/60 frames per second, progressive (HDMI only), making it ideal for playing high-definition Blu-ray Discs.

High quality audio



This player is compatible with Dolby TrueHD, Dolby Digital Plus, DTS-HD High Resolution Audio, Dolby Digital and DTS.

To enjoy Dolby TrueHD, Dolby Digital Plus or DTS-HD High Resolution Audio at the maximum performance, connect this player to a Dolby TrueHD, Dolby Digital Plus or DTS-HD High Resolution Audio-compatible AV amplifier using an HDMI cable. Then, after placing a Blu-ray Disc recording a material with Dolby TrueHD, Dolby Digital Plus or DTS-HD High Resolution Audio, open the disc menu and select "Dolby TrueHD", "Dolby Digital Plus" or "DTS-HD High Resolution Audio" from the menu.

For the output conditions of various audio types, see *About the audio output settings* on page 44.

- *Manufactured under license from Dolby Laboratories. "Dolby" and the double-D symbol are trademarks of Dolby Laboratories.*
- *"DTS" and "DTS Digital Surround" are registered trademarks of DTS, Inc.*

Movie file playback

Video files encoded in the Windows Media™ Video (WMV), MPEG-1/2 formats are playable from DVD-R/-RW, or from a connected media server.

Music file playback

This player supports various audio formats, including Windows Media Audio (WMA), MP3 and WAV. You can play files stored on DVD-R/-RW, or from a connected media server.

Photo file playback

PNG, GIF and JPEG image files — including the popular EXIF format used by most digital cameras to store picture shooting information together with the JPEG image — are playable from DVD-R/-RW, or from a connected media server.

- *Windows Media™ is a trademark of Microsoft Corporation.*
- *This product includes technology owned by Microsoft Corporation and cannot be used or distributed without a license from Microsoft Licensing, Inc.*

What's in the box

Please confirm that the following accessories are in the box along with these operating instructions when you open it:

- Remote control
- AA/R6P dry cell batteries x2
- Stereo audio cable (red/white plugs)
- Video cable (yellow plugs)
- LAN cable
- Power cable
- Warranty card

Putting the batteries in the remote control

- Insert two AA/R6P batteries into the battery compartment following the indications (+, -) inside the compartment.

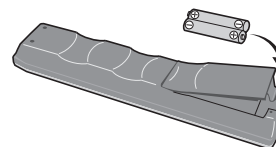

Important

Incorrect use of batteries can result in hazards such as leakage and bursting. Please observe the following:

- Don't mix new and old batteries together.
- Don't use different kinds of batteries together — although they may look similar, different batteries may have different voltages.
- Make sure that the plus and minus ends of each battery match the indications in the battery compartment.
- Remove batteries from equipment that isn't going to be used for a month or more.
- When disposing of used batteries, please comply with governmental regulations or environmental public instruction's rules that apply in your country/area.

WARNING

Do not use or store batteries in direct sunlight or other excessively hot place, such as inside a car or near a heater. This can cause batteries to leak, overheat, explode or catch fire. It can also reduce the life or performance of batteries.

D3-4-2-3-3_En

Using the remote control

Please keep in mind the following when using the remote control:

- Make sure that there are no obstacles between the remote and the remote sensor on the unit.
- The remote has a range of about 23 feet (at an angle of 30° from either side of the sensor). Use within this range in front of the remote control sensor on the front panel.
- Remote operation may become unreliable if strong sunlight or fluorescent light is shining on the unit's remote sensor.
- Remote controllers for different devices can interfere with each other. Avoid using remotes for other equipment located close to this unit.
- Replace the batteries when you notice a fall off in the operating range of the remote.
- When the batteries run down or you change the batteries, the TV preset codes are automatically reset. See *Resetting the player* on page 47 to reset them.

Disc/content format playback compatibility

General disc compatibility

This player is compatible with a range of disc types (media) and formats. Compatible discs will usually feature one of the following logos on the disc and/or disc packaging. Note however that some disc types, such as recordable BD, DVD or CD, may be in an unplayable format — see below for further compatibility information.

Blu-ray Disc (BD)



DVD-Video



DVD-R





DVD-R DL



DVD-RW



- “Blu-ray Disc” and  are trademarks.
-  is a trademark of DVD Format/Logo Licensing Corporation.
- This player may not be able to play perfectly every disc that features one of the logos listed above. Please contact Pioneer if you find a disc that won't play properly.

BD compatibility

- This player can play BD-ROM discs.
 - BD-ROM discs should conform to BD-ROM Profile 1.
- This player can play BD-R discs.
 - This player is compatible with Blu-ray Disc Recordable format Ver. 2¹.
 - This player is not compatible with Blu-ray Disc Recordable format Ver. 1².
- This player can play BD-RE discs.
 - This player is compatible with Blu-ray Disc Rewritable format Ver. 3¹.
 - This player is not compatible with Blu-ray Disc Rewritable format Ver. 1³ and Ver. 2².
- This player can play 12 cm discs, but cannot play 8 cm discs.

DVD compatibility

- This player can play DVD-ROM (DVD-Video)/-R/-RW discs.
 - This player can play DVD-R/-RW discs recorded as DVD-Video format.
 - This player cannot play unfinalized DVD discs and VR mode DVD discs.

– This player can also play DVD discs containing PC data. See below for the file compatibility.

- This player cannot play DVD-Audio and DVD-RAM discs.

CD compatibility

- This player can play CD-DA discs.
- PC files stored on CDs cannot be played back.
- Regarding copy protected CDs: This product is designed to conform to the specifications of the Audio CD format. This player does not support the playback or function of discs that do not conform to these specifications.
- The audio signals of a CD output at the **DIGITAL AUDIO OUT (COAXIAL/OPTICAL)** jacks of this player are protected from copying and cannot be copied on other external components.

DualDisc playback

A DualDisc is a new two-sided disc, one side of which contains DVD content – video, audio, etc. – while the other side contains non-DVD content such as digital audio material.

The DVD side of a DualDisc will play in this product (excluding any DVD-Audio content).

The non-DVD, audio side of the disc is not compatible with this player.

It is possible that when loading or ejecting a DualDisc, the opposite side to that being played will be scratched. Scratched discs may not be playable.

For more detailed information on the DualDisc specification, please refer to the disc manufacturer or disc retailer.

PC-created disc compatibility

Discs recorded using a personal computer may not be playable in this unit due to the settings of the application software used to create the disc. Check with the software publisher for more detailed information.



Important

- This player cannot play discs other than the ones listed in this chapter.
- Do not use 8 cm disc adapters with this player. 8 cm discs can be played directly by placing them in the 8 cm disc depression in the center of the disc tray.

File compatibility

- Compatible media: DVD-R, DVD-RW, media server on network (some formats may not be supported depending on the media server type).
- Even when they are in a supported format, some files may not play or display depending on the content.
- Even when playing a supported format, some functions may not operate properly depending on the content.
- DRM-protected contents on DVD-R/-RW discs or on media servers that do not support WMDRM, and otherwise incompatible files are skipped.

Note

- 1 The standard for recording of BDMV format data.
- 2 The standard for recording of BDAV format data.
- 3 The standard that uses the provided cartridge.

- Please note, the following file naming structure needs to be adhered to when creating/renaming any digital media to be played on the unit (either through computer-created disc media, or the Home Media Gallery connection). This disclaimer does not apply to any media purchased at retail locations: Due to the coding system used, this player will only read/play files named using standard alphanumeric characters. Any other characters or symbols (e.g. characters with accents) used in naming the file will render it unreadable/unplayable by the unit. If you encounter any difficulties with playback of media, please rename the file in accordance to this standard.

Supported video formats

- **Windows Media Video 9 (WMV9)¹**
– MP@HL
- **Windows Media Video 9 (WMV9) Advanced Profile (VC-1)**
– AP@L3
- **MPEG-2 (PS/TS)**
– MP@HL
- **MPEG-1**

Supported audio formats

- **Windows Media Audio 9 (WMA9)**
– Bit rate: up to 192 kbps (constant bit-rate (CBR));
up to 384 kbps (variable bit-rate (VBR))
– Sampling rates: 44.1 kHz or 48 kHz
- **Windows Media Audio 9 Professional (WMA9 Pro)**
– Bit rate: up to 768 kbps
– Sampling rates: 44.1 kHz or 48 kHz
– Channels: up to 5.1ch
- **MPEG-1 Audio Layer 3 (MP3)**
– Sampling rates: 32 kHz, 44.1 kHz or 48 kHz
– Bit rate: up to 320 kbps
- **Linear PCM (WAV)**
– Sampling rates: 44.1 kHz or 48 kHz

Supported image formats

- **JPEG**
– File format: JFIF or Exif
– Resolution: up to 4096 x 4096 pixels
Baseline JPEG and progressive JPEG are supported
- **PNG**
– Resolution: up to 4096 x 4096 pixels
- **GIF**
– Resolution: up to 4096 x 4096 pixels

File extensions

The following file extensions should be used with this player:

- **Video**
' .wmv' ' .mpg' ' .mpeg'
- **Audio**
' .wma' ' .mp3' ' .wav'
- **Image**
' .jpg' ' .jpeg' ' .png' ' .gif'

Even when files have a supported file extension, some files may not play or display depending on the content or media server type.

Titles and chapters

BD and DVD movie discs are divided into one or more titles. Titles may be further subdivided into chapters.

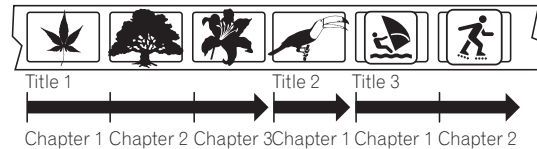

DVD-Video regions

All commercially produced DVD movies (DVD-Video discs) carry a region mark on the case somewhere that indicates which region(s) of the world the disc is compatible with. This player also has a region mark, which you can find on the rear panel. Discs from incompatible regions will not play in this player. Discs marked **ALL** will play in any player.

The diagram below shows the various DVD regions of the world.

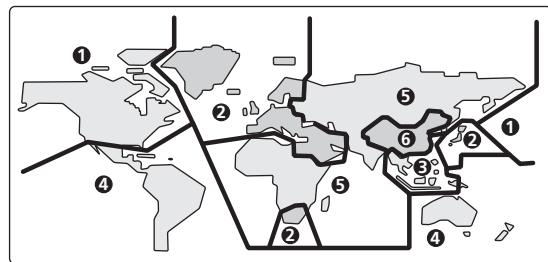

This player is region 1.

BD-ROM regions

Like DVD movies, BD movie discs (BD-ROM) also carry a region mark that indicates which region(s) of the world the disc is compatible with. This player also has a region mark, which you can find on the rear panel. Discs from incompatible regions will not play in this player. Discs marked **ALL** will play in any player.

The diagram below shows the various BD-ROM regions of the world.



This player is region A.

Rear panel

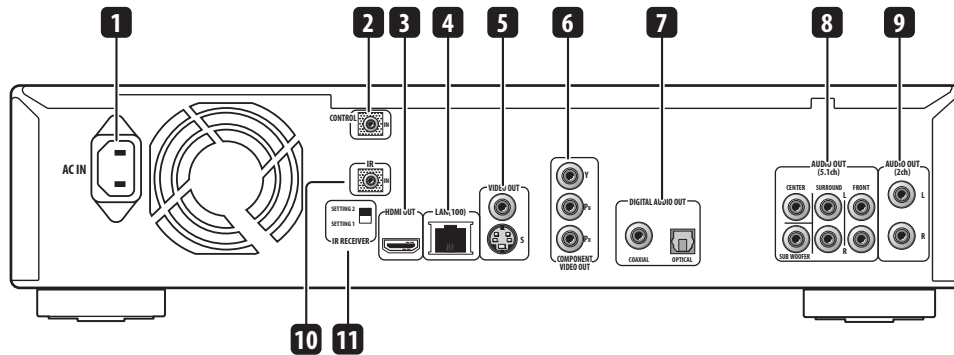
**1 AC IN**

Connect the supplied power cord here, then plug into a power outlet.

2 CONTROL IN

Use to control this player from the remote sensor of another Pioneer component with a **CONTROL OUT** terminal and bearing the  mark. Connect the **CONTROL OUT** of the other component to the **CONTROL IN** of this player using a mini-plug cord (page 16).

3 HDMI OUT

HDMI output providing a high quality interface for digital audio and video (page 13).

4 LAN (100)

Ethernet port for 100BASE-TX (100 Mbps) network connection (page 16).

5 VIDEO OUT and S-VIDEO OUT

Video output (composite) that you can connect to your TV or AV receiver using the supplied video cable (page 12).

S-Video output that you can use instead of the **VIDEO OUT** jacks (page 14).

6 COMPONENT VIDEO OUT

High quality video output for connection to a TV, monitor or AV receiver that has component video inputs.

Connect using a commercially available three-way component video cable (page 13).

7 DIGITAL AUDIO OUT (COAXIAL/OPTICAL)

Digital audio outputs for connection to a PCM, Dolby Digital, and/or DTS-compatible AV receiver (page 15).

8 AUDIO OUT (5.1ch)

Multi-channel (5.1ch) analog audio outputs for connection to an AV receiver with multi-channel analog audio inputs (page 15).

9 AUDIO OUT (2ch)

Stereo analog audio outputs for connection to your TV, AV receiver or stereo system (page 12).

10 IR IN

Jack for an external IR (infrared) remote control receiver (page 17).

11 IR RECEIVER switch

Switch to the setting compatible with your external IR remote control receiver (page 17).

**Tip**

- When connecting this player to your TV, AV receiver or other equipment, make sure that all components are **'switched off'** and **'unplugged'**.
- You may find it useful to have the manuals supplied with your other components handy when connecting this player.

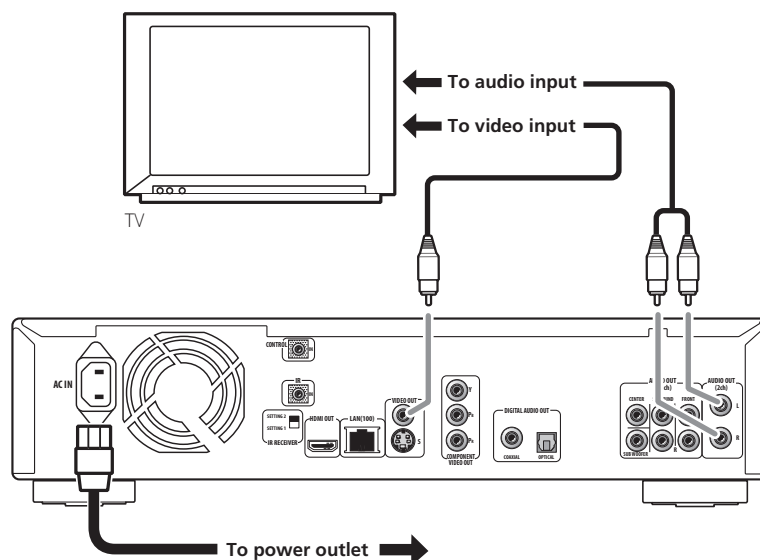

This is a basic setup that allows you to watch discs on your TV using just the cables supplied.

Important

- This player is equipped with copy protection technology. Do not connect this player to your TV via a VCR using AV cables, as the picture from this player will not appear properly on your TV. (This player may also not be compatible with some combination TV/VCRs for the same reason; refer to the manufacturer for more information.)
- Do not unplug the player from the power outlet while it is switched on.
- Do not plug this player into a switched power supply found on some amplifiers and AV receivers.

1 Connect the VIDEO OUT and one pair of AUDIO OUT (2ch) jacks to a set of audio/video inputs on your TV.

Use the supplied red/white stereo audio and yellow video cables. Make sure you match up the left and right audio outputs with their corresponding inputs for correct stereo sound.

See *Using other types of video output* below if you want to use a different type of connection.

2 Connect the supplied AC power cord to the AC IN inlet, then plug into a power outlet.

Using other types of video output

This player has standard (composite), S-Video and component video outputs, as well as an HDMI connector (for digital video/audio).

In order to be able to watch HD (high definition) BDs at their full resolution, you should connect the player to your TV using either the component video output, or (even better) the HDMI output.

An HDMI connection will additionally give you HD output when watching DVDs.

If your display has neither of these connection types, an S-Video jack is also provided, which should give slightly better video quality than using the standard video output.

Connecting for HDMI output

If you have an HDMI or DVI (with HDCP) equipped monitor or display, you can connect it to this player using a commercially available HDMI cable that supports the HDMI 1.3 specification (Category 2) or later.

The HDMI connector outputs uncompressed digital video, as well as most digital audio formats.

Important

- This unit has been designed to be compliant with HDMI (High-Definition Multimedia Interface). Depending on the component you have connected, using a DVI connection may result in unreliable signal transfers.
- If you change the display connected to the HDMI output, you will also need to change the output video resolution settings to match the new display (see *Changing the output video resolution* on page 14 to do this).
- The HDMI connection is compatible with 8-channel linear PCM signals (44.1 kHz to 192 kHz¹, 16 bit/20 bit/24 bit), Dolby Digital, Dolby TrueHD, Dolby Digital Plus, DTS-HD High Resolution Audio and DTS (5.1 channel signals) bitstreams.
- Depending on the HDMI cable being used, 1080p output may not appear correctly.
- If you connect a DVI device to the HDMI output of this player, ensure that it is compliant with High-bandwidth Digital Content Protection (HDCP). If you choose to connect to a DVI connector, you will need a separate adaptor (DVI → HDMI) to do so. A DVI connection, however, does not support audio signals. Consult your local audio dealer for more information.
- **Use an HDMI cable (not supplied) to connect the HDMI OUT interconnect on this player to an HDMI interconnect on an HDMI-compatible display.**

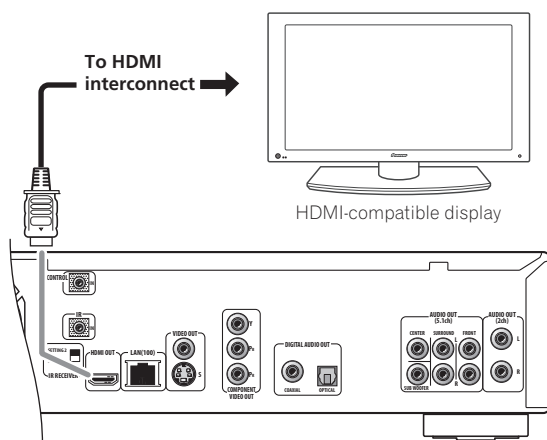

- The arrow on the cable connector body should be face up for correct alignment with the connector on the player.

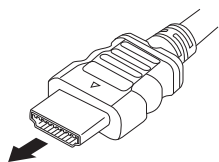

After switching on the player you may need to set the output video resolution and HDMI color space for compatibility with your display. See *Changing the output video resolution* on page 14 and **HDMI Color Space** in *Using the Initial Setup menu* on page 41.

About HDMI

HDMI supports both standard and high-definition video, plus standard and multi-channel surround-sound audio. HDMI features include uncompressed digital video, one connector (instead of several cables and connectors), and communication between the AV source and AV devices such as DTVs.

HDMI was developed to provide the technologies of High-bandwidth Digital Content Protection (HDCP) as well as Digital Visual Interface (DVI) in one specification. HDCP is used to protect digital content transmitted and received by DVI-compliant displays.

About HDMI Control

You can enable HDMI Control by turning the **HDMI Control** setting to **On** for all components connected via HDMI cable. Check the video output from this unit once you have completed making connections and settings for all components. You will need to check the video output each time you change connected components or remove the HDMI cable.

The HDMI Control functions may not operate properly if you do not use an HDMI cable that supports the HDMI 1.3 specification (Category 2) or later.

Connecting using the component video output

You can use the component video output instead of the standard video out jack to connect this player to your TV (or other equipment).

- **Use a component video cable (not supplied) to connect the COMPONENT VIDEO OUT jacks to a component video input on your TV, monitor or AV receiver.**

Be careful to match up the colors of the three jacks for correct connection.

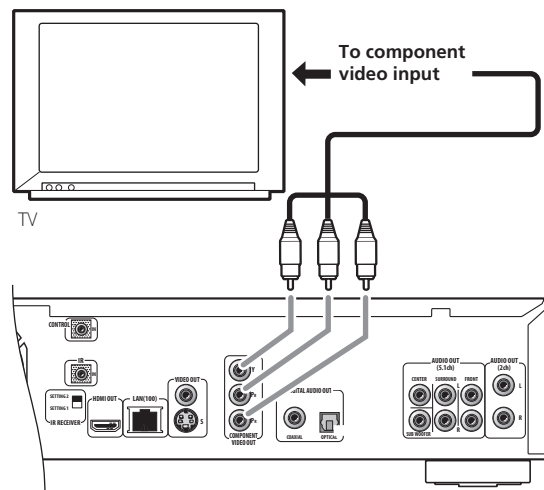

Note

¹ There are some restrictions depending on the sampling rate. For more information see *About the audio output settings* on page 44.

02 Changing the output video resolution

Use the **OUTPUT RESOLUTION** button located on both the front panel and the remote control to switch the output video resolution for the HDMI and component video outputs.

The table below shows the output settings.

Setting	HDMI output	Component output	Video/S-Video output
AUTO	TV's preferred resolution ^{1,2}	TV's preferred resolution ³	480/60i
480i	480/60i	480/60i	480/60i
480p	480/60p	480/60p	480/60i
720p	720/60p	720/60p ^{4,5}	480/60i
1080i	1080/60i	1080/60i ^{4,5}	480/60i
1080p	1080/60p	480/60i	480/60i
Source Direct	Dependent on source ^{1,2}	Dependent on source ^{2,5,6}	480/60i

1. Refer to 24p output below for conditions.
2. The video output will be interrupted when switching the video output.
3. For resolutions that cannot be output by component output, video is output in the following resolutions: 480/60i
4. Video output is 480i during copy protected DVD-Video playback.
5. Video output during BD-ROM playback is 480i depending on the disc.
6. The frame frequency for 1080/24p is still 60 Hz.

Note

- Depending on your display, some of the settings may result in the picture disappearing. In this case, press **OUTPUT RESOLUTION** repeatedly until the picture re-appears.
- 1080/60p and 1080/24p output is only compatible with HDMI displays. They are not compatible with the component video output.
- When output video resolution is set to **720p**, **1080i** or **1080p**, video is output in 16:9 format even if **TV Aspect Ratio** (page 41) is set to **4:3 (Standard)**.
- If the contours of the displayed subjects look jagged or blurred, try setting the output video resolution to **480i**. (If you connected this player to your TV with the HDMI connection and the picture disappears when you switch the output video resolution to **480i**, use the component connection with the **480i** output video resolution or S-Video, the standard composite connection instead.)
- Note that when using a Component Video connection with a TV or other AV component (*not* using HDMI), 480/60i video may be output in 480/60p.

24p output

For smooth presentation of 1080/24p or 720/24p video with an HDMI-equipped display compatible with 1080/24p input, set **24p Direct Out** (page 41) on this player to **On**.

This player will output 1080/24p video over HDMI in the following cases:

- 1080/24p video: When the output video resolution is set to **Auto** or **Source Direct**.
- 720/24p video: When the output video resolution is set to **Auto**.

Note

- Even when **24p Direct Out** is set to **On**, if a TV not compatible with 1080/24p video is connected, the actual frame frequency of the video output will be 60 Hz.
- The video output will be interrupted when switching the video output from 1080/24p or 720/24p to other output video resolutions, or when switching to 1080/24p or 720/24p from other output video resolutions.

Connecting using an S-Video output

You can use the S-Video output instead of the **VIDEO OUT** jack to connect this player to your TV (or other equipment).

- **Use an S-Video cable (not supplied) to connect the S-VIDEO OUT to an S-Video input on your TV, monitor or AV receiver.** Line up the small triangle above the jack with the same mark on the plug before plugging in.

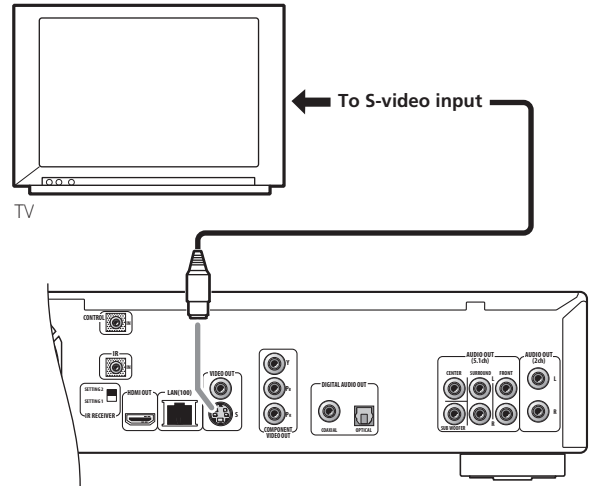

Connecting for surround sound

This player offers both analog and digital connections for surround sound. The digital outputs (coaxial and optical) provide a convenient way to connect this player to an AV receiver with built-in Dolby Digital and/or DTS decoders. The 5.1ch analog outputs can be used to connect to an AV receiver with multi-channel analog audio inputs. Check the operating instructions that came with your AV receiver for more on these connections.

Digital connections

- Connect one of the **DIGITAL AUDIO OUT (COAXIAL/OPTICAL)** jacks on this player to a digital input on your AV receiver.

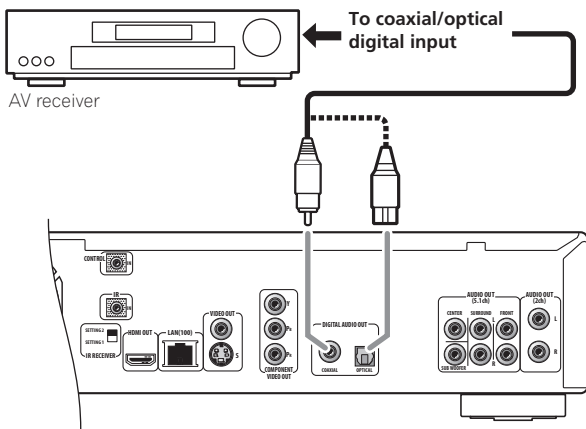

Optical connection: Use an optical cable (not supplied) to connect the **DIGITAL AUDIO OUT OPTICAL** jack to an optical input on your AV receiver.

- When inserting the plug, the protective shutter will open and you should hear the plug click into position when fully inserted. Take care not to force the plug as this may damage the shutter, the cable and/or the player.

Coaxial connection: Use a coaxial cable (not supplied) to connect the **DIGITAL AUDIO OUT COAXIAL** jack to a coaxial input on your AV receiver.

Note

- Linear PCM audio output over the **DIGITAL AUDIO OUT (COAXIAL/OPTICAL)** jacks is limited to 2ch, 48 kHz.

Analog connections

- Connect the **AUDIO OUT (5.1ch)** jacks on this player to the **multi-channel analog inputs** on your AV receiver.

Use a dedicated six-way cable (not supplied), or three sets of stereo cables (not supplied) to connect the six channels.

Check carefully that each channel is connected to its corresponding channel on the AV receiver.

After connecting, you can make settings for the number of speakers connected to your system — see the **Speakers** section of the Initial Setup menu on page 43 and *Speaker Setup* on page 45.

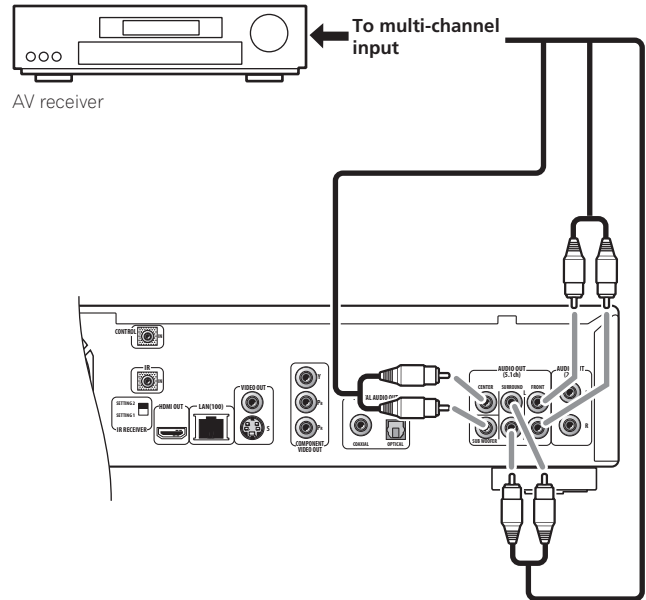

Network connection

This player can be connected to a local area network (LAN) via the Ethernet port on the rear panel.

After making the physical connection the player needs to be set up for network communication. This is done from the Initial Setup menu — see *Setting up for network use* on page 21 for detailed instructions.

For best performance, we recommend using a 100BASE-TX compatible PC and Ethernet hub.

Connecting via an Ethernet hub

If you already operate one or more PCs on a local area network, you can integrate this player by connecting it to the Ethernet hub using the included LAN cable.

In the example configuration below, this player would be able to access content from either of the PCs.

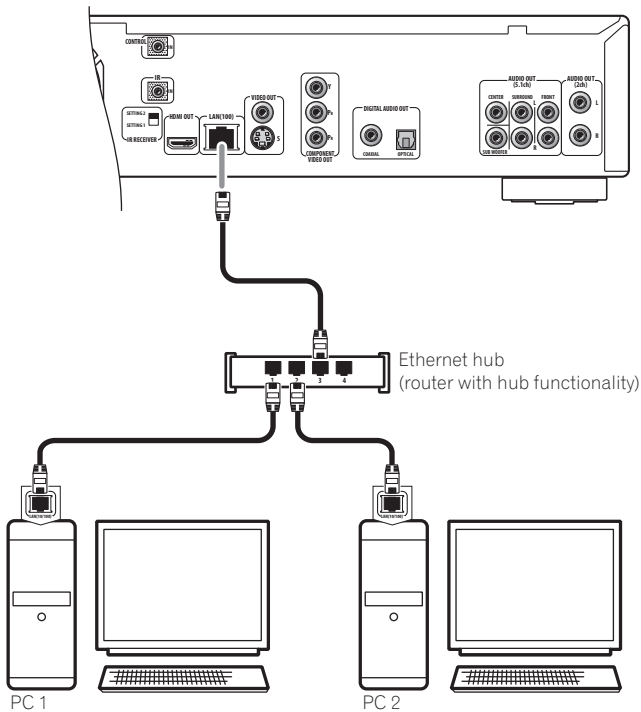

Connecting directly to a PC

If you only need to use one PC to act as a media server, you can connect this player directly to the PC using the included LAN cable.

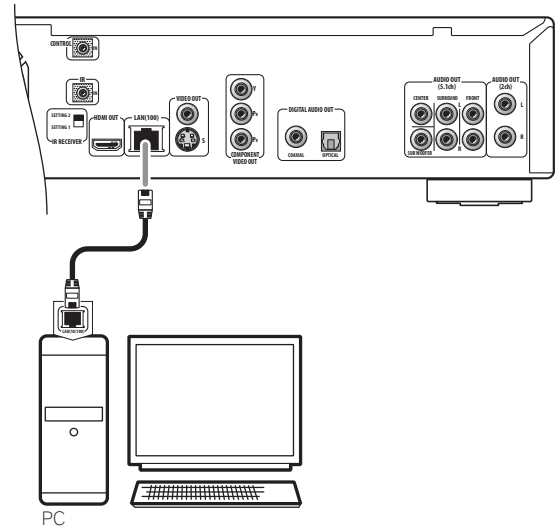

Controlling this player via another Pioneer component

The **CONTROL IN** jack allows you to control this player via the remote control sensor of another Pioneer component — typically an AV receiver — that has a **CONTROL OUT** jack. Remote control signals are passed through to the player from the remote sensor of the other component, allowing you greater freedom in the placement of your player.

- Use a miniplug cord (not supplied) to connect the **CONTROL IN** jack of this player with the **CONTROL OUT** jack of your other Pioneer component.

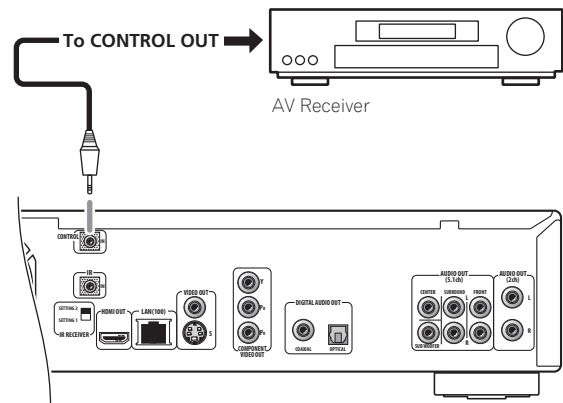

- You will also need to connect a coaxial digital cable, analog audio cable, or video cable.
- When connected via System Control, point the remote control toward the connected component (such as an AV receiver). The remote will not work correctly when pointed at this unit.
- You cannot connect use System Control with components that do not have a System Control jack or with components manufactured by companies other than Pioneer.

Using an external IR receiver with this player

If you prefer to keep your AV equipment in a closed cabinet, you can use an external IR receiver connected to the **IR IN** jack. You can thus have just the receiver outside of the cabinet and still be able to control the player.

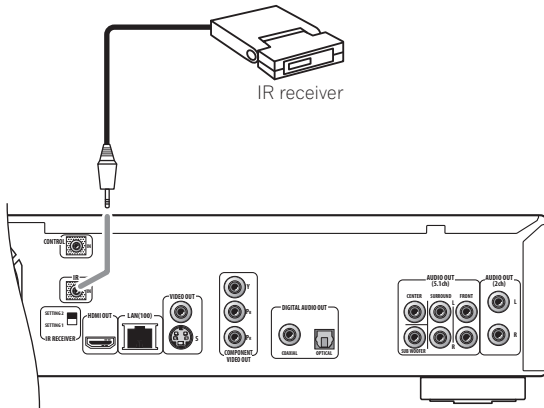

Tip

- You may need to set the **IR RECEIVER** switch (located under the **IR IN** jack) for this player to recognize the IR receiver correctly.
- This player does not supply power to the external IR receiver. Please see the operating instructions of the IR receiver for the power requirements.

03 Chapter 3 Controls and displays

Front panel

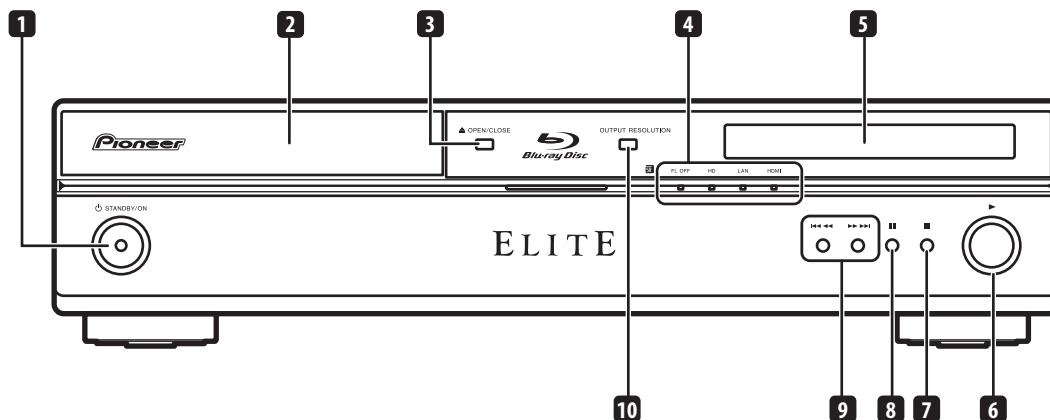

1 STANDBY/ON

Press to switch the player on (the power indicator and indicator in the middle of the unit light up when the power is on) or into standby.

2 Disc tray

3 OPEN/CLOSE

Press to open or close the disc tray.

4 Indicators

- **FL OFF** – Lights when the display and other indicators are switched off.
- **HD** – Lights when the video output is 720p, 1080i or 1080p (HDMI), or 720p or 1080i (component).
- **LAN** – Lights when there is an active local area network (LAN) connection.
- **HDMI** – Lights when a device is connected via HDMI.

5 Display

Shows disc status and playback information.

Front panel display

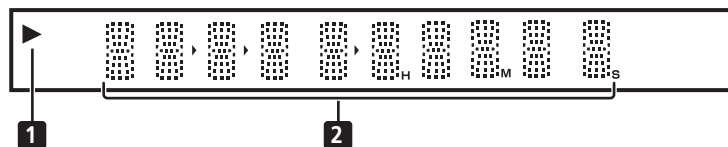

1

Lights during playback of a disc.

2 Character display

Shows various playback information — disc time, chapter and title number, etc.

6 (play)

Press to start or resume playback.

7 (stop)

Press to stop playback (you can resume playback by pressing).

8 (pause)

Press to pause playback. Press again to restart.

9 Skip/scan buttons

- – Press to jump to the next chapter, track, etc. Press and hold for fast forward scanning.
- – Press to jump back to the beginning of the current chapter, track, etc. then to previous chapters, tracks, etc. Press and hold for fast reverse scanning.

10 OUTPUT RESOLUTION

Press to switch the output resolution over HDMI and component video outputs. See *Changing the output video resolution* on page 14.

Remote control

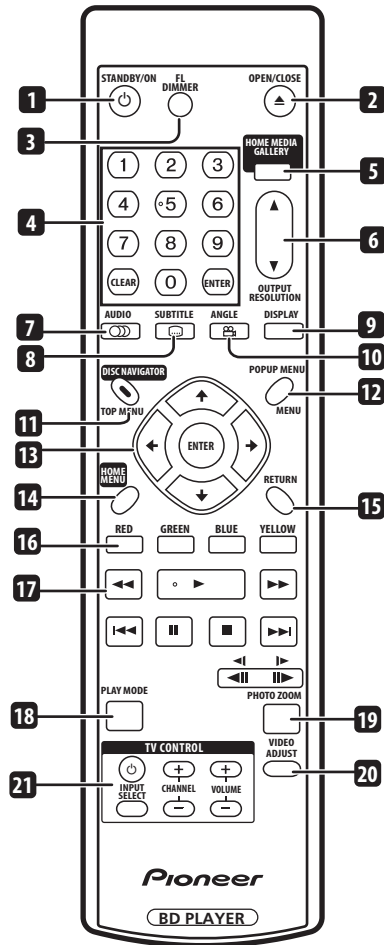

1 STANDBY/ON

Press to switch the player on or into standby.

2 OPEN/CLOSE

Press to open or close the disc tray.

3 **FL DIMMER**

Press to change the brightness of the display. When the display and other indicators are off, the **FL OFF** indicator (page 18) lights.

4 **Number buttons**

Use to enter title, chapter or track numbers, etc.

CLEAR: Press to clear a numeric entry, etc.

ENTER: Press to select an option or execute a command.

5 **HOME MEDIA GALLERY**

Press to display the Home Media Gallery screen (see page 32).

6 **OUTPUT RESOLUTION**

Press to switch the output resolution over HDMI and component video outputs (see pages 14 and 25).

7 **AUDIO**

Press to select the audio channel or language (see page 25).

8 **SUBTITLE**

Press to select a subtitle display (see page 25).

9 **DISPLAY**

Press to display information (see page 25).

10 **ANGLE**

Press to change the camera angle during BD-ROM or DVD-Video movie multi-angle scene playback (see page 25).

11 **DISC NAVIGATOR/TOP MENU**

Press to display the top menu of a BD-ROM or DVD-Video disc. When playing a DVD-R/-RW disc, press to display/exit the Disc Navigator.

12 **POPOP MENU/MENU**

BD-ROM: Press to display/hide the pop-up menu.
DVD-Video: Press to display the disc menu (if there is one).

13 and **ENTER**

Use to navigate on-screen displays and menus. Press **ENTER** to select an option or execute a command.

14 **HOME MENU**

Press to display the player's Home Menu, from which you can access most of the player's functions.

15 **RETURN**

Press to return to a previous screen.

16 **Red/Green/Blue/Yellow**

Use to navigate BD-ROM menus.

17 **Playback controls**

: Press to start reverse/forward scanning.

: Press to start or resume playback.

: Press to pause playback; press again to restart.

: Press to stop playback (you can resume playback by pressing).

: Press to jump to the start of the previous/next chapter/track.

: Use for slow motion and step frame (see page 24).

18 **PLAY MODE**

Press to change the Play Mode (repeat play, for example) (see page 24).

19 **PHOTO ZOOM**

Press to zoom the screen when displaying a still image (see page 25).

20 **VIDEO ADJUST**

Press to display the **Video Adjust** screen (see page 39).

21 **TV CONTROL buttons**

See also *Setting up the remote to control your TV* on page 48.

: Press to turn the TV on or into standby.

VOLUME +/-: Use to adjust the volume.

CHANNEL +/-: Use to select TV channel.

INPUT SELECT: Press to change the input function of the TV.

Getting Started

Switching on and setting up

When you switch the player on for the first time the Setup Navigator screen appears. We recommend using this to make a few basic player settings.

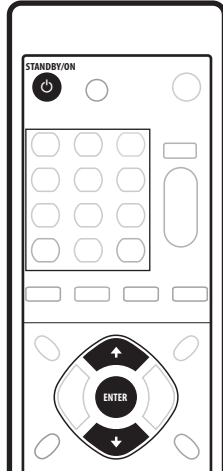

- 1 **Switch on your TV and set the video input to this player.**
- 2 **Press the STANDBY/ON button on the remote control or the front panel to switch on.**
 - It can take up to one minute for the unit to turn on.
 - When you switch on for the first time, your TV should display the Setup Navigator screen. (If the Setup Navigator doesn't appear, you can also access it from the Initial Setup menu; see page 43).
 - When you have this unit connected to a plasma display that is compatible with HDMI Control, language settings are imported from the plasma display's OSD settings before Setup Navigator begins.
- 3 **Use the / buttons to choose a language, then press ENTER.**

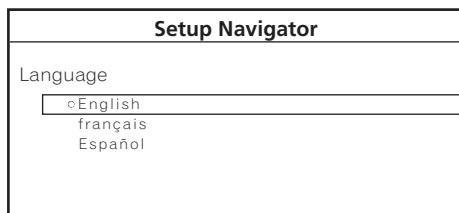

- 4 **Press ENTER to start setting up using the Setup Navigator.**

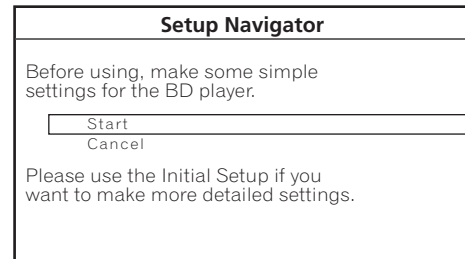

If you don't want to use the Setup Navigator, press to select **Cancel**, then press **ENTER** to exit the Setup Navigator.

- 5 **Use the / buttons to select the output video resolution then press ENTER.**

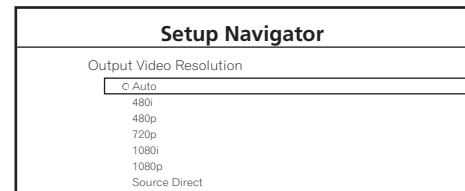

If you connected this player to your TV using the HDMI connector, select from **Auto**, **480i** (interlaced), **480p** (progressive), **720p**, **1080i**, **1080p**, or **Source Direct**, then skip to step 7 (the aspect ratio will automatically be set to **16:9 (Widescreen)**). Generally, the **Auto** setting is recommended.

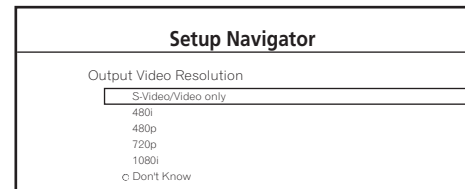

If you're using an S-Video or composite video connection, select **S-Video/Video only**.

If you're using a component video connection, match the output setting with the capabilities of your TV. Select from: **480i**, **480p**, **720p**, **1080i** or **Don't Know**. If you select **720p** or **1080i**, skip the next step since the aspect ratio will automatically be set to **16:9 (Widescreen)**.

- 6 **Use the / buttons to select the aspect ratio of your TV then press ENTER.**

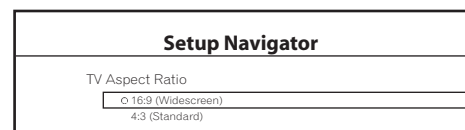

If you have a widescreen TV, select **16:9 (Widescreen)**; if you have a standard size TV, select **4:3 (Standard)**.

7 Select 'Finish Setup' to accept the settings and exit the Setup Navigator, or 'Go Back' to go through the settings again.

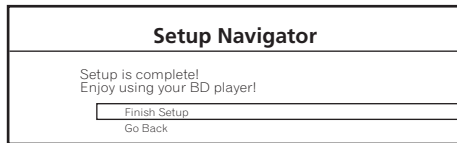

You can run the Setup Navigator at any time by selecting it from the **Options** menu — see page 43.

About the screen saver

If the player is stopped or paused for more than five minutes with no other operation, the screen saver starts.

Once the screen saver has started, pressing any button on the front panel or remote will clear it and return the player to normal operation.

The screen saver starts for CDs and music files after five minutes pass without any commands input, whether or not playback has been paused or stopped.

Using the on-screen displays

This player makes extensive use of graphical on-screen displays (OSDs). You should get used to the way these work as you'll need to use them when setting up the player, using some of the playback features, and when making more advanced settings for audio and video.

All the screens are navigated in basically the same way, using the cursor buttons (↑/↓/←/→) to change the highlighted item and pressing **ENTER** to select it.

Button	What it does
HOME MENU	Display/exit the on-screen display
↑/↓/←/→	Changes the highlighted menu item
ENTER	Selects the highlighted menu item
RETURN	Returns to the previous menu or screen without saving changes



Tip

- Information at the bottom of an OSD screen explains the currently selected menu item and shows which buttons can be used for that screen.

Setting up for network use

If you've connected this player to a local area network (LAN) you may need to make a few settings before you can use the Home Media Gallery feature over the network.

- 1 Press **HOME MENU** and select 'Initial Setup'.
- 2 Select 'Network'.
- 3 Select 'Device Name' then 'Next Screen'.

4 Use the on-screen keypad to enter a name for the player.

This is how the player will appear to connected devices on the local area network.

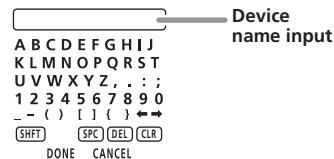

- Use the ↑/↓/←/→ buttons and **ENTER** to select characters from the keypad.
- Select **SHFT** to toggle between upper and lower case.
- Select **SPC** to insert a space.
- Select **DEL** to delete the character at the current cursor position in the name field.
- Select **CLR** to clear the name field.

5 Select 'DONE' to register the name and exit the input screen.

Select **CANCEL** to close the keypad without registering the name.

6 Select 'IP Configuration' then 'Next Screen' to display the IP configuration screen.

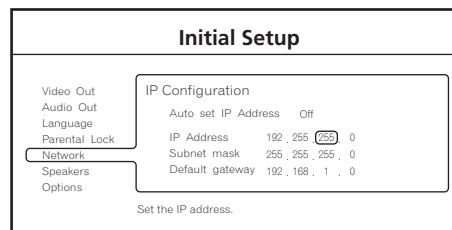

7 Set 'Auto set IP Address' to 'On'.

If there is a DHCP server on the local area network (LAN), this player will automatically be allocated an IP address. If you're using a broadband router or broadband modem that has a DHCP (Dynamic Host Configuration Protocol) server function, select **On**. The IP address will automatically be determined.

If there is no DHCP server on the network and you select **On**, this player will use its own Auto IP function to determine the IP address.

- If you want to set the IP address manually, select **Off** then set the IP Address, Subnet mask and Default gateway: Use the ↑/↓/←/→ buttons to select a field; use the number buttons to enter a value. Press **ENTER** to finish and exit the screen.

8 Press HOME MENU to exit the Initial Setup menu.

You should now be able to use the Home Media Gallery (accessible from the Home Menu). See *Using the Home Media Gallery* on page 32 for more.

- For information on DHCP refer to the network device's operating instructions.
- You may need to contact your service provider or network administrator when manually entering an IP address.

Playing movies, music and photos

Using this player, you can enjoy watching movies, listening to music and browsing photos, from DVD discs or from a media server on the network. How you navigate, browse and play content varies according to the format of the content and the media:

- To play a DVD movie disc (i.e., one containing DVD-Video application format), see *Playing BD/DVD movies and Audio CD* below.
- To play a DVD-R/-RW disc recorded with movie, music or photo files, turn to *Using the Disc Navigator* on page 27.
- To play content from a media server, please refer to *Using the Home Media Gallery* on page 32.

Playing BD/DVD movies and Audio CD

The basic playback controls for playing BD/DVD movies and Audio CD discs are covered here. Further functions are detailed in the next chapter.

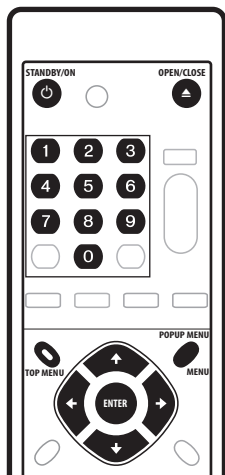

1 If the player isn't already on, press **⏻ STANDBY/ON** to switch it on.

Also turn on your TV and make sure that it is set to the correct video input.

2 Press **⏏ OPEN/CLOSE** to open the disc tray.

3 Load a disc.

Load a disc with the label side facing up, using the disc tray guide to align the disc (if you're loading a double-sided DVD-Video disc, load it with the side you want to play face down).

The player will take a short while to read the disc, after which the disc type will show up in the front panel display.

4 Press **▶** to start playback.

- Use the **⏸** (pause) and **■** buttons to pause or stop playback. You can resume playback in either case by pressing **▶**. See also *Resuming playback* on page 23.
- See *Playback controls* on page 23 for other controls available during playback.

When playing BD-ROM discs:

- Commercially produced BD-ROM movie discs often go straight to the disc menu when playback is started (sometimes preceded by an opening sequence). Navigate through the disc menu using the cursor keys (**↑/↓/←/→**) and the **ENTER** button. You can also use the number buttons to select numbered items in some menus.
- To get back to the top menu, press **TOP MENU**.
- Some BD-ROM discs feature pop-up menus that do not interrupt playback; press **POPUP MENU/MENU** to access these.

When playing DVD-Video discs:

- Commercially produced DVD movies often go straight to the disc menu when playback is started (sometimes preceded by an opening sequence). Navigate the disc menu using the cursor (**↑/↓/←/→**) and **ENTER** buttons. You can also use the number buttons to select numbered items in some menus.
- To get back to the top menu, press **TOP MENU**.
- To get back to the disc menu, press **POPUP MENU/MENU**.

When playing Audio CDs:

- For more information see *Playback controls* on page 23.

5 When you've finished using the player, eject the disc and switch the player back into standby.

- To open/close the disc tray, press **⏏ OPEN/CLOSE**. Remove the disc before putting the player into standby.
- Press **⏻ STANDBY/ON** to switch the player into standby.

Playback controls

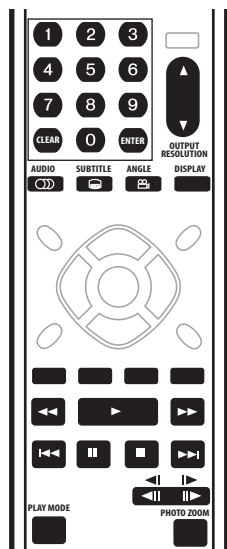

Resuming playback



The resume function offers a convenient way to restart playback from where you stopped it previously.

Resuming playback of BD/DVD movies and Audio CDs

If you stop playback before the end of the disc, the playback stop position is stored so that you can resume watching the disc from the same place later.

- To resume playback, press ►. Playback will start from the stored resume position. For Audio CDs, playback resumes from the beginning of the track.
- Press ■ again to cancel the resume function.

Note

In the following case, the resume position is cleared:

- Eject the disc.
- Use Home Media Gallery/Disc Navigator.
- Switch the player off (DVD resume position remains saved).
- Certain BD-ROM discs cannot be restarted from the position in which they are paused.

Resuming playback of movie, music and photo files

Movie and music files are resumed from the start of the title/track (rather than the stop position within the title/track): photo slideshow playback is resumed from the photo file within the slideshow.

- If you interrupt playback of a movie or slideshow by pressing **RETURN** to display the Disc Navigator or Home Media Gallery screen, you can still resume playback of the same title/slideshow photo using the ► button, regardless of what is highlighted on the screen. (Use the **ENTER** button to start playback of the currently highlighted item in the Disc Navigator/Home Media Gallery.)

- Some actions in the Disc Navigator/Home Media Gallery (such as changing the Browse category) will cause the resume position to be lost.

Scanning video and audio



You can fast-scan BD/DVD movies or Audio CDs, forward or backward at various speeds.

1 During playback, press ◀◀ or ▶▶ to start scanning.

There is no sound while scanning video and audio.

2 Press repeatedly to increase the scanning speed.

The scanning speed is shown on-screen.

3 To resume normal playback, press ►.

Depending on the disc, normal playback may automatically resume when a new chapter is reached on a BD/DVD movie disc.

Selecting titles, chapters and tracks directly

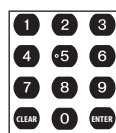

You can select titles, chapters and tracks directly with BD, DVD movies and Audio CDs¹.

- **Use the number buttons to select a title, chapter or track.**
 - If the disc is stopped, playback starts from the selected title or track.
 - If the disc is playing, playback jumps to the start of the selected chapter or track.

Skipping content



You can skip over content during playback of BD and DVD movies, Audio CDs, movie and song files, and photo slideshows.

- **During playback, press ◀◀ or ▶▶ to skip content.**¹
 - When playing a BD or DVD movie, playback jumps to the start of the previous/next title, chapter or track. (If the disc is stopped, playback will start.)
 - During movie or song file playback, the previous or next file will start playing.
 - During photo slideshow playback, you can skip to the previous or next photo.

Note

¹ With some titles on BD-ROM or DVD-Video discs it is not possible to jump to the start of the selected title or chapter.

Playing video in slow motion



You can play BD and DVD movies at different forward slow motion speeds.

1 During playback, press **II▶** to start slow motion playback.

- The slow motion speed is shown on-screen.
- There is no sound during slow motion playback.

2 Press repeatedly to change the slow motion speed.

3 To resume normal playback, press **▶**.

Depending on the disc, normal playback may automatically resume when a new chapter is reached.

Video step forward and step reverse



You can use step forward and step reverse when playing a BD or DVD movie.

1 During playback, press **II** (pause).

2 Press **◀** or **▶** to move the video forward or back one step.

3 To resume normal playback, press **▶**.

When playing a BD or DVD movie, normal playback may automatically resume when a new chapter is reached.

Changing the Play Mode



Use the **PLAY MODE** button on the remote control to select one of the various playback modes for BD and DVD movie discs, Audio CD discs, movie and music files and photo slideshows.

You can't select a Play Mode while a BD or DVD disc menu is being displayed, or while playing some BD/DVD movie titles, Audio CD, or movie and music files and photo slideshows.

• During playback, press **PLAY MODE** to change the Play Mode.

See *Play Mode option compatibility* below for the options available with the disc/file you're playing.

- **Time Search** (see *Using time search* below)
- **Title Search** (see *Using title search* below)
- **Repeat Chapter** (repeats the current chapter)
- **Repeat Title** (repeats the current title)
- **Repeat Track** (repeats the current track)
- **Repeat All** (repeats the current browse list)
- **Random** (play tracks from an Audio CD, music files, or photo files in a random order)
- **Repeat Off** (cancels the repeat and random modes)

The current Play Mode is displayed on-screen. Press **CLEAR** to resume normal playback.

Play Mode option compatibility

The available options depend on what kind of disc/file is playing (✓ = available/✗ = unavailable):¹

Play Mode Option	Disc/file type					
	BD-ROM	DVD -Video	PC File (Music)	PC File (Movie)	PC File (Photo)	Audio CD
Time Search	✓	✓	✗	✓	✗	✗
Title Search	✓	✓	✗	✗	✗	✗
Repeat Chapter	✓	✓	✗	✗	✗	✗
Repeat Title	✓	✓	✗	✓	✗	✗
Repeat Track	✗	✗	✓	✗	✗	✓
Repeat All	✗	✗	✓	✗	✓	✓
Random	✗	✗	✓	✗	✓	✓
Repeat Off	✓	✓	✓	✓	✓	✓

Using time search



You can navigate directly to a certain point in a BD or DVD movie, or in a movie file.^{1,2}

1 During playback, press **PLAY MODE** and select 'Time Search'.

2 Use the number buttons to enter a time in hours, minutes and seconds for playback to resume from.

For a BD or DVD movie, the time you enter should be the time into the currently playing title. For a movie file it will be the playback time into the file.

- For example, press **4, 5, 0, 0** to have playback start from 45 minutes into the title/file. For 1 hour, 20 minutes, press **1, 2, 0, 0, 0**.
- Press **CLEAR** to clear the input.

3 Press **ENTER** to start playback from the time you entered.

Using title search



You can directly jump to the start of any title on a BD-ROM or DVD-Video.^{1,2}

1 During playback, press **PLAY MODE** and select 'Title Search'.

2 Use the number buttons to select a title.

Press **CLEAR** to clear the input.

3 Press **ENTER** to start playback of the title you selected.

Note

¹ With some BD-ROM and DVD-Video titles, it is not possible to select any Play Mode options.

² This function may not be supported depending on the content or server software.

Switching camera angles



Some BD and DVD movies feature scenes shot from two or more angles — check the disc box for details.

- **During playback, press ANGLE to switch the angle.**
 - There may be a short delay after pressing the button before the angle changes.
 - Playback resumes if the angle is changed while paused.

Zooming the screen



During playback of a photo slideshow you can zoom the screen to 2x view or 4x view.

- 1 **During playback, press PHOTO ZOOM to change the zoom.** Press repeatedly to cycle through: normal → 2x zoom → 4x zoom.
- 2 **Use the cursor keys (↑/↓/←/→) to move the zoomed area of the screen.** The zoom mode is canceled when you stop playback.

Switching subtitles



Some BD and DVD movie discs have subtitles in one or more languages; the disc box will usually tell you which subtitle languages are available.

- 1 **Press SUBTITLE repeatedly to select a subtitle option.**¹ The current subtitle language/option is displayed on-screen and in the front panel display.

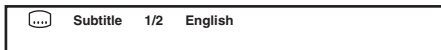

- 2 **To switch the subtitle display off, press SUBTITLE then CLEAR.** There may be a short delay after pressing the button before the subtitles change.



Tip

- To set subtitle language preferences, see page 42.

Switching audio streams/channels



Some BD and DVD movie discs contain multiple audio streams that you can select on playback. These might be different audio languages and/or different audio formats (such as a DTS 5.1-channel sound track and a Dolby Digital 2-channel sound track).

- **Press AUDIO repeatedly to select an audio channel/stream option.**² The current option is shown on-screen.



Switching audio languages on a BD/DVD movie

- There may be a short delay after pressing the button for the audio channel to change.



Tip

- Even when multiple audio streams are included in a movie file, you cannot select from among them while playing back of a movie file.
- To set audio language preferences, see page 42.

Displaying disc or file information



Various track, chapter and title information, as well as the video transmission rate for DVD and BD movies, can be displayed on-screen. The information available depends on the type disc or file, and whether it's playing or stopped.

- **Press DISPLAY to show/switch the information displayed.** Press DISPLAY repeatedly to change the displayed information.³

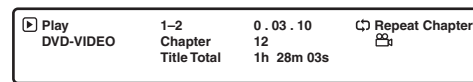

DVD-Video Play display 1

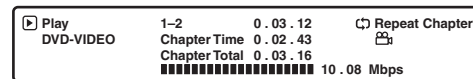

DVD-Video Play display 2

Switching the output video resolution



You can switch the output video resolution for HDMI and component output.

- **Press OUTPUT RESOLUTION repeatedly to select an output video resolution.**

The current source and output video resolution are shown on-screen.

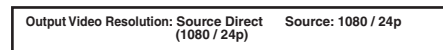

Note

- Depending on your display, some of the settings may result in the picture disappearing. In this case, press **OUTPUT RESOLUTION** repeatedly until the picture re-appears.
- See *Changing the output video resolution* on page 14 for more information.

Note

- 1 Some discs only allow you to change the subtitle language from the disc menu. Press **POPOP MENU/MENU** to access.
- 2 Some discs only allow you to change the audio language from the disc menu. Press **POPOP MENU/MENU** to access.
- 3 There may be instances with some discs where no information can be displayed.

Frequently Asked Questions

- *Why won't the disc I loaded play?*

First check that you loaded the disc the right way up (label side up), and that it's clean and not damaged. See *Taking care of your player and discs* on page 46 for information on cleaning discs.

If a disc loaded correctly won't play, it's probably an incompatible format or disc type. See *Disc/content format playback compatibility* on page 9 for more on disc compatibility.

- *There's no picture!*

Your TV is probably not compatible with the selected video output resolution. Check your TV for compatibility with progressive scan video and higher resolutions. Press the **OUTPUT RESOLUTION** button to switch the video output. See also *Changing the output video resolution* on page 14.

- *I can't see any picture, or get high definition video output when playing some BDs!*

When playing some discs, there may be no composite video, S-Video and/or component video output, or high-definition content may be converted to standard-definition 480i or 480p component output. This is for content protection. To view the disc, connect the player to an HDMI-compatible display. See *Connecting for HDMI output* on page 13.

- *I have a widescreen TV so why are there black bars at the top and bottom of the screen when I play some discs?*

Some movie formats are such that even when played on a widescreen TV, black bars appear at the top and bottom of the screen. This is not a malfunction.

- *I've connected to a HDMI/DVI compatible component but I can't get any signal and the front panel HDMI indicator won't light!*

Make sure that you've selected this player as the HDMI input in the settings for the component you're using. You may need to refer to the instruction manual of the component to do this.

An HDMI connection can only be made with other HDMI components, or a High-bandwidth Digital Content Protection (HDCP)-compatible DVI component. See *Connecting for HDMI output* on page 13 for more on HDMI compatibility.

- *There's no picture from the HDMI output!*

Make sure the output resolution of this player matches that of the component you have connected using HDMI. See *Changing the output video resolution* on page 14.

- *Why is the playback sample rate of the DVD only 48 kHz instead of 96 kHz?*

Playback sample rate of the audio is downsampled to 48 kHz.

- *My AV receiver is definitely compatible with 96 kHz Linear PCM audio, but it doesn't seem to work with this player. What's wrong?*

192 kHz/96 kHz BD and 96 kHz DVD discs only output digital audio downsampled to 48 kHz through the optical and coaxial outputs.

96 kHz 7.1ch BD discs only output digital audio downsampled to 48 kHz through HDMI output when video output is 480i or 480p over HDMI. These are not malfunctions.

- *Why is the mono audio on some discs rather quiet compared to other discs?*

When mono audio is split into the L and R channels, there may be a small loss of volume.

- *There's no sound when connected using HDMI!*

You won't hear any sound from the HDMI output if your component is only DVI/HDCP-compatible.

- *I can't connect to my local area network!*

First of all check the settings of the media server you're using. Make sure that if you made the network settings automatically on this player then you also select auto setup on the server. (Likewise, if you made the settings manually on the server, you should set up this player manually.)

Chapter 5 Using the Disc Navigator

Use the Disc Navigator to browse through the PC files on a DVD-R/-RW disc to find what you want to play. You can use the Disc Navigator when a disc is playing or stopped.

Important

- It's not possible to use the Disc Navigator with DVD-Video discs, or with Audio CDs.

Introduction

Most of the features described in this chapter make use of on-screen displays. Navigate these using the **↑/↓/←/→** and **ENTER**. To go back to the previous menu or screen, use the **RETURN** button. The button guide at the bottom of every screen shows which buttons do what.

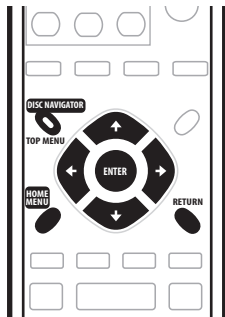

- 1 Press **HOME MENU** and select 'Disc Navigator' from the on-screen display. Alternatively, press **DISC NAVIGATOR**.

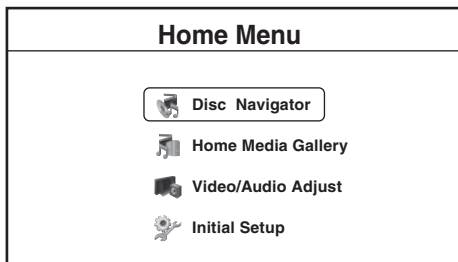

- 2 Select 'Movies', 'Photos' or 'Music'. See the sections below for more information on each of these.

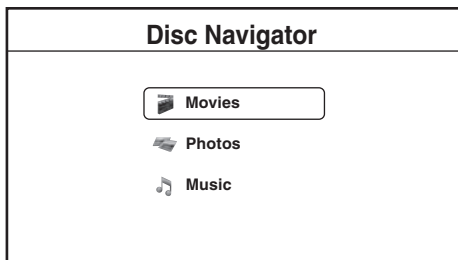

- 3 Press **HOME MENU** to exit the Disc Navigator screen.

Movie Navigator

The movie section of the Disc Navigator allows you to browse and play all the compatible movie files stored on the loaded DVD-R/-RW disc (non-movie files are not displayed).

See also *File compatibility* on page 9 for more on compatible file types.

- 1 If you haven't already done so, select 'Disc Navigator' from the Home Menu, then 'Movies'.

You should see a list of all the movie files found on the disc, together with their playing times.

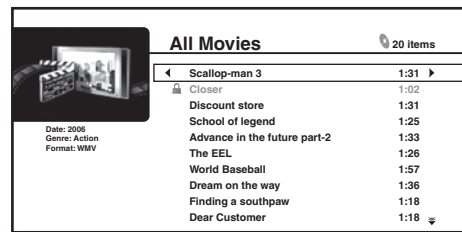

- When the movie length cannot be determined, it is displayed as ":-:-".

- 2 Use the **↑/↓** buttons to change the current selection (highlighted in yellow).

On the left side of the screen you can see file information, such as the genre, date and file format, for the current selection.

- 3 Press **ENTER** to play the currently highlighted movie. Press **▶** to start or resume playback from the last title played.

Displaying the Movie Options menu

- Press **⇒** to display the Movie Options menu:

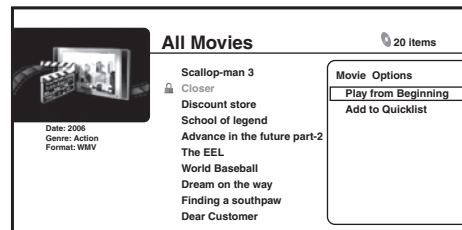

- **Play from Beginning:** Play the selected movie from the beginning.
- **Add to Quicklist:** Add the selected movie to your Quicklist. The Quicklist feature is a useful way to organize movie files for handy selection and playback. The Quicklist can contain up to 25 movies.¹

Note

¹ Quicklists are lost when you exit Movie Navigator.

Displaying the browse menu

- Press **←** to display the browse menu:

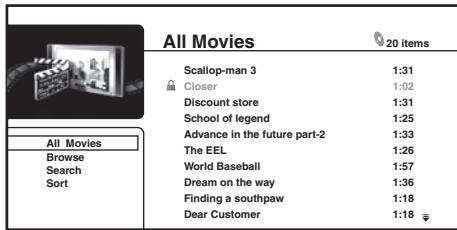

Depending on the browse menu, certain options may not be selectable.

- All Movies:** Display all movie files found on the disc.
- Browse:** Browse movies by **Genre**, **Quicklist**, or **Folders**. See also *Browsing movies* below.
- Search:** Find a movie by entering a name (or a few letters) to search for. The search results are narrowed down as you enter more letters. See also *Searching movies* below.
- Sort:** Sort movies by date (oldest first or most recent first) or alphabetically by title or genre ('A' first or 'Z' first).

Browsing movies

The browse sub-menu gives you three ways to browse movies.

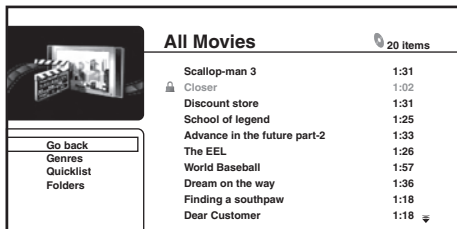

- Go back:** Return to the previous menu.
- Genre:** Display all movie genres and how many movies are in each one. Select a genre and press **ENTER** to see the list of movies in that genre.
- Quicklist:** Display a list of all the movies currently in your Quicklist. Press **→** to display the **Movie Options** menu, where you can start playback or remove movies from the **Quicklist**:

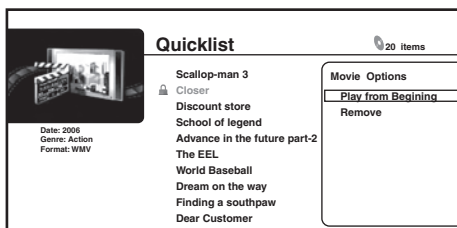

- Folders:** Display a list of folders and movie files. Select a folder and press **ENTER** to see the list of subfolders/movies files in that folder.

Searching movies

From the Search sub-menu you can enter a few (up to 20) characters of a movie title or genre. As each character is entered into the search field the search results are dynamically updated, narrowing down the list of movies until you can see the one you're looking for.

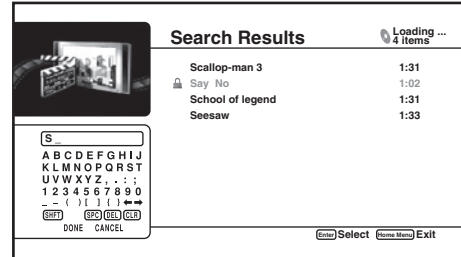

- Use the **↑/↓/←/→** and **ENTER** buttons to select characters from the keypad.
- Select **SHIFT** to toggle between upper and lower case.
- Select **SPC** to insert a space.
- Select **DEL** to delete the character at the current cursor position in the search field.
- Select **CLR** to clear the search field.
- Select **DONE** to close the keypad and select movies or genres from the search results; select **CANCEL** to close the keypad and clear the search results.

Photo Navigator

The photo section of the Disc Navigator allows you to browse and display all the compatible photo files found on the loaded DVD-R/-RW disc (non-photo files are not displayed).

See also *File compatibility* on page 9 for more on compatible file types.

- If you haven't already done so, select **'Disc Navigator'** from the Home Menu, then **'Photos'**.

You should see a list of folders/photo files from the disc.

- Use the **↑/↓** buttons to change the current selection (highlighted in yellow).



- Select a folder and press **ENTER** to see the list of photos and subfolders within the folder.

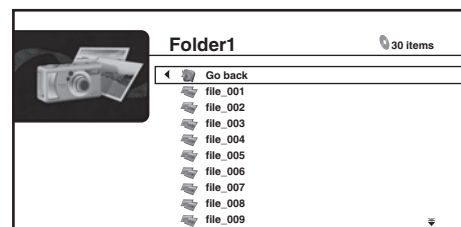

4 Use the ↑/↓ buttons to change the current selection (highlighted in yellow).

- Press **ENTER** to start full-screen slideshow playback from the currently selected photo.
- Press **▶** to start or resume slideshow playback from the last photo displayed.

Displaying the Photo Options menu

- Press **➡** to display the **Photo Options** menu.
- Press **ENTER** to display the **Photo Options** menu when displaying photos in thumbnail view.

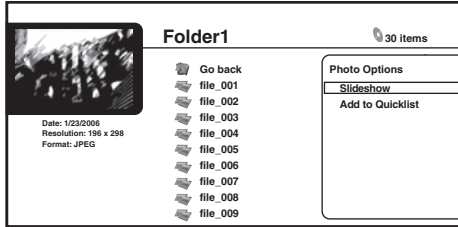

- **Slideshow:** Start full-screen slideshow playback from the currently selected photo. During the slideshow, press **▶▶** to advance to the next photo; **◀◀** to go back to the previous photo; **||** (pause) to pause the slideshow; **■** to stop and exit the slideshow; **PHOTO ZOOM** to enlarge the picture on the screen.
- **Add to Quicklist:** Add the selected photo to your Quicklist. The Quicklist feature is a useful way to organize photos for handy selection and slideshow playback. The Quicklist can contain up to 25 photos.¹

Displaying the browse menu

- Press **←** to display the browse menu.
- From the left-most column, press **←** to display the browse menu when displaying photos in thumbnail view:

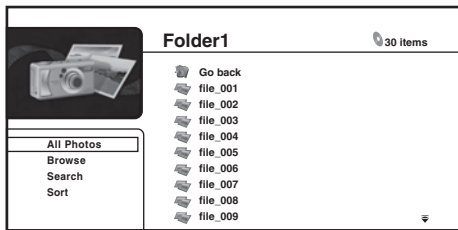

Depending on the browse menu, certain options may not be selectable.

- **All Photos:** Display all photos found on the disc as thumbnail files.
- **Browse:** Browse photos by **Date**, **Quicklist** or **Folders**. See also *Browsing photos* below.
- **Search:** Find a photo by entering a name (or a few letters) to search for. The search results are narrowed down as you enter more letters. See also *Searching photos* on page 29.
- **Sort:** Sort photos by date (oldest first or most recent first), or alphabetically by name ('A' first or 'Z' first).

Browsing photos

The browse sub-menu gives you several ways to browse photos.

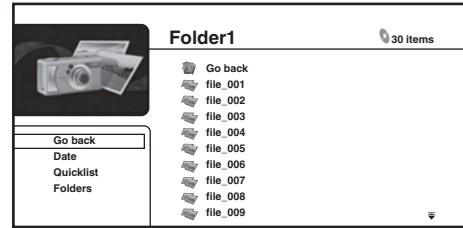

- **Go back:** Return to the previous menu.
- **Date:** Browse photos as thumbnails by date (year and month). Select a year then press **ENTER** to further browse by month. Select a month and press **ENTER** to see the photos taken that month.
- **Quicklist:** Display thumbnails of all the photos currently in your Quicklist. Press **ENTER** to display the **Photo Options** menu, from where you can start slideshow playback or remove photos from the Quicklist:

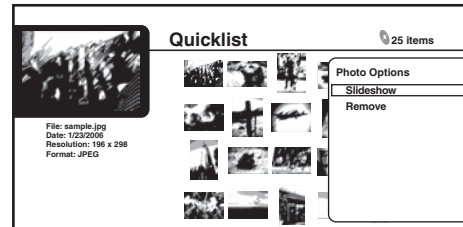

- **Folders:** Display a list of folders and photo files on the disc. Select a folder and press **ENTER** to see the subfolders/photos.

Searching photos

From the Search sub-menu you can enter a few (up to 20) characters of a photo title. As each character is entered into the search field the search results are dynamically updated, narrowing down the list of photos until you can see the one you're looking for.

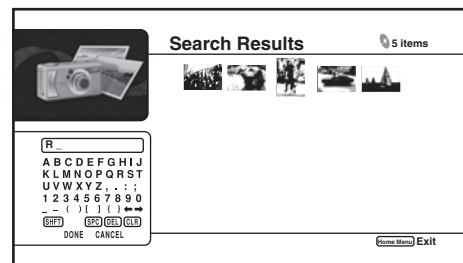

See *Searching movies* on page 28 for how to use the screen keypad.

Note

¹ Quicklists are lost when you exit Photo Navigator.

Music Navigator

The music section of the Disc Navigator allows you to browse and play all the compatible music files found on the loaded DVD-R/-RW disc (non-music files are not displayed).

See also *File compatibility* on page 9 for more on compatible file types.

1 If you haven't already done so, select 'Disc Navigator' from the Home Menu, then 'Music'.

You should see a list of the artist names on the disc.

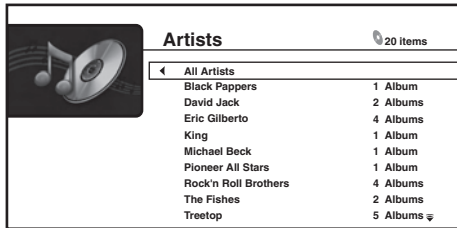

2 Use the ↑/↓ buttons to change the current selection (highlighted in yellow).

3 Press ENTER to display the album list.

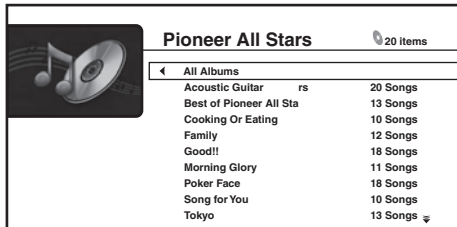

4 Select the album you want to listen to and press ENTER to display the song list.



- When the song length cannot be determined, it is displayed as “:-:”.

5 Use the ↑/↓ buttons to change the current selection (highlighted in yellow).

On the left side of the screen you can see file information, such as the artist and album name, genre and file format, for the current selection.

6 Press ENTER to play the currently highlighted music.

The display shows the **Now Playing** screen.

- Press ► to start or resume playback from the last track played on the **Now Playing** screen.

Displaying the Song Options menu

- Press → to display Song Options menu:



- Play Song:** Play the selected song from the beginning.
- Add to Quicklist:** Add the selected song to your Quicklist. The Quicklist feature is a useful way to organize music files for handy selection and playback. The Quicklist can contain up to 25 songs.¹

Displaying the browse menu

- Press ← to display the browse menu:

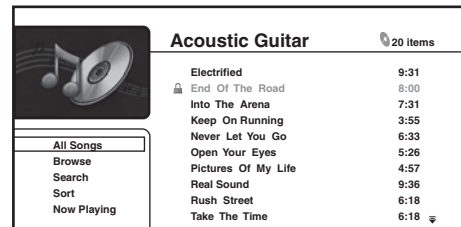

Depending on the browse menu, certain options may not be selectable.

- All Songs:** Display all songs (files/tracks) found on the disc.
- Browse:** Browse songs by **Artists**, **Albums**, **Genres**, **Quicklist** or **Folders**. See also *Browsing songs* on page 31.
- Search:** Find a song by entering a name (or a few letters) to search for. The search results are narrowed down as you enter more letters. See also *Searching songs* on page 31.
- Sort:** Sort songs by date (oldest first or most recent first), or alphabetically by song title, artist, album or genre ('A' first or 'Z' first).
- Now Playing:** Display song information (track name, artist, album, genre, etc.) and playback information. See also *Now playing song information* on page 31.

Browsing songs

The browse sub-menu gives you various ways to browse songs.

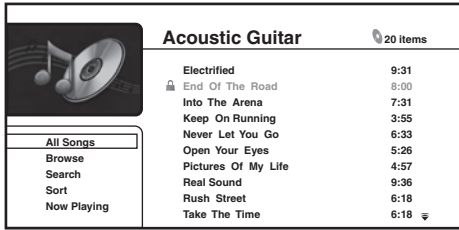

- **Go back:** Return to the previous menu.
- **Artists:** Display a list of artists, and how many albums are associated with each. Select an artist and press **ENTER** to see the album list by that artist.
- **Albums:** Display a list of albums, and how many songs are associated with each. Select an album and press **ENTER** to see the list of songs on that album.
- **Genres:** Display all music genres, and how many songs are in each one. Select a genre and press **ENTER** to see the list of artists in that genre.
- **Quicklist:** Display a list of all the songs currently in your Quicklist. Press **➡** to display the **Song Options** menu, where you can start playback or remove songs from the Quicklist:

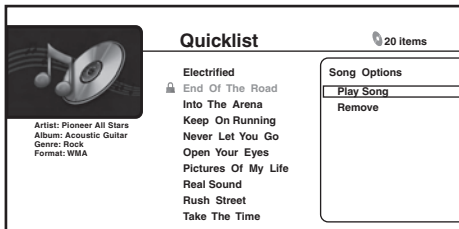

- **Folders:** Display a list of folders and song files. Select a folder and press **ENTER** to see the list of subfolders/songs.

Searching songs

From the Search sub-menu you can enter a few characters (up to 20) of a song title, genre, artist, or album. As each character is entered into the search field the search results are dynamically updated, narrowing down the list until you can see the one you're looking for.

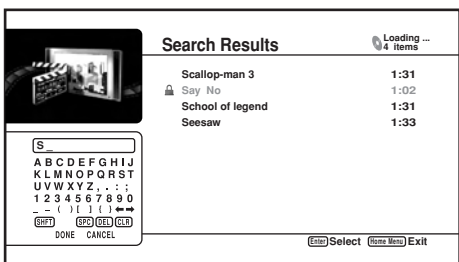

See *Searching movies* on page 28 for how to use the screen keypad.

Now playing song information

The Now Playing screen shows detailed information about the song playing, including:

- Artist and song title
- Progress bar (elapsed time and song length)
- Album name
- Genre
- File format
- Browse menu
- Play status
- Play mode
- Next/Previous song names

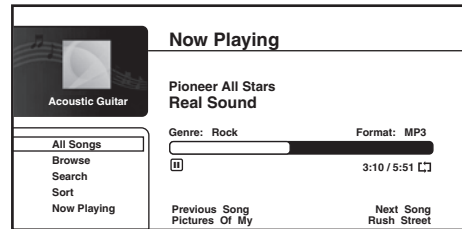

Using the Home Media Gallery



Introduction

The Home Media Gallery allows you to browse and play movies, music and photos stored on media servers connected on an identical Local Area Network (LAN) as the player. This unit allows for the playing of files stored on the following:

- PCs running Microsoft Windows XP with Windows Media Connect installed
- PCs running Microsoft Windows Vista or XP with Windows Media Player 11 installed
- DLNA-compatible digital media servers (on PCs or other components)

About network playback

The network playback function of this unit uses the following technologies:

Windows Media Player 11/Windows Media Connect

See *About Windows Media Player 11/Windows Media Connect* on page 38 for details.

Windows Media DRM

Microsoft Windows Media Digital Rights Management (WMDRM) is a platform to protect and securely deliver content for playback on computers, portable devices and network devices. Home Media Gallery functions as a WMDRM 10 for networked devices. WMDRM-protected content can only be played on media servers supporting WMDRM.

- *Content owners use WMDRM technology to protect their intellectual property, including copyrights. This device uses WMDRM software to access WMDRM-protected content. If the WMDRM software fails to protect the content, content owners may ask Microsoft to revoke the software's ability to use WMDRM to play or copy protected content. Revocation does not affect unprotected content. When you download licenses for protected content, you agree that Microsoft may include a revocation list with the licenses. Content owners may require you to upgrade WMDRM to access their content. If you decline an upgrade, you will not be able to access content that requires the upgrade.*
- *This product is protected by certain intellectual property rights of Microsoft. Use or distribution of such technology outside of this product is prohibited without a license from Microsoft.*

DLNA



- *DLNA CERTIFIED™ Audio/Video/Image Player*

The Digital Living Network Alliance (DLNA) is a cross-industry organization of consumer electronics, computing industry and mobile device companies. Digital Living provides consumers with easy sharing of digital media through a wired or wireless network in the home.

The DLNA certification logo makes it easy to find products that comply with the DLNA Interoperability Guidelines. This unit complies with DLNA Interoperability Guidelines v1.0.

When a PC running DLNA server software or other DLNA-compatible device is connected to this player, some setting changes of software or other devices may be required. Please refer to the operating instructions for the software or device for more information.

- *DLNA and DLNA CERTIFIED™ are trademarks and/or service marks of Digital Living Network Alliance.*

Content playable over a network

Even when encoded in a compatible format, some files may not play correctly. See *File compatibility* on page 9. Some functions may not be supported depending on the server type or version used.

Supported file formats vary by server. As such, files not supported by your server are not displayed on this unit.

For more information check with the manufacturer of your server.

About playback behavior over a network

- Playback may stall when the PC is switched off or any media files stored on it are deleted while playing content.
- If there are problems within the network environment (heavy network traffic, etc.) content may not be displayed or played properly (playback may be interrupted or stalled). For best performance, a 100BASE-TX connection between player and PC is recommended.
- Playback performance will vary with the power and condition (seek time of the hard disk, etc.) of the PC being used.
- If several clients are playing simultaneously, as the case may be, playback is interrupted or stalled.
- Depending on the security software installed on a connected PC and the setting of such software, network connection may be blocked.
- Problems with the PC may cause malfunctions.

Pioneer is not responsible for any malfunction of the player and/or the Home Media Gallery features due to communication error/malfunctions associated with your network connection and/or your PC, or other connected equipment. Please contact your PC manufacturer or Internet service provider.

About the network settings

This unit uses DHCP and Auto IP functionality to make all the network settings automatically.

If you are using a broadband router or a broadband modem with a DHCP server function, setup should be completely automatic with no manual settings required.

Using the Home Media Gallery

Before using the Home Media Gallery, make sure that you have connected the player to the network and made the necessary settings. See *Network connection* on page 16 and *Setting up for network use* on page 21 for more information.

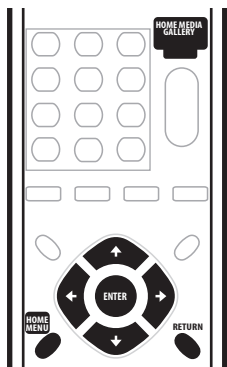

- 1 Press **HOME MENU** and select 'Home Media Gallery' from the on-screen display.

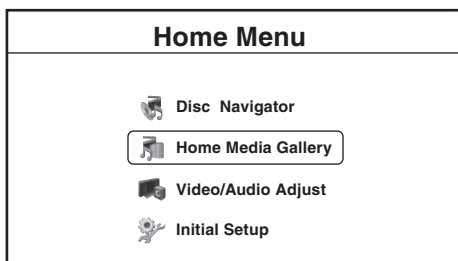

- Alternatively, press **HOME MEDIA GALLERY**.
- The Home Media Gallery is only available when the network or server contains movies, photos or music files.

- 2 Select 'Movies', 'Photos' or 'Music'.

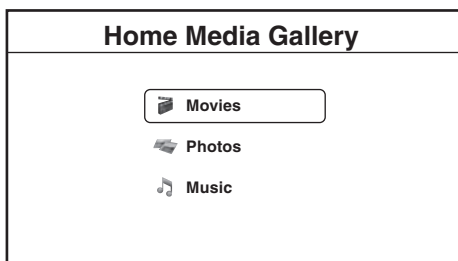

- On selecting an option, a list of movies, photos or music files that the player finds on the selected server is displayed. From here you can browse, play and sort network files.
- See the sections below for more information on each part of the Home Media Gallery.

- 3 Press **HOME MENU** to exit the Home Media Gallery screen.

Movie Navigator

From the movie section of the Home Media Gallery you can browse and play all the compatible movie files found on your local area network (non-movie files are not displayed).

See also *File compatibility* on page 9 for more on compatible file types.

- 1 If you haven't already done so, select 'Home Media Gallery' from the Home Menu, then 'Movies'.

You should see a list of all the movie files found on the selected server, together with their playing times.

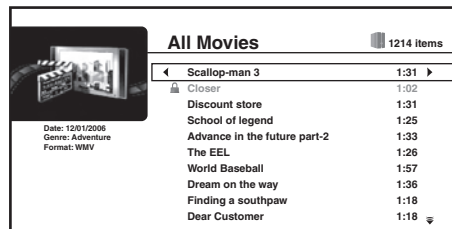

- When the movie length cannot be determined, it is displayed as "-:--".

- 2 Use the **↑/↓** buttons to change the current selection (highlighted in yellow).

On the left side of the screen you can see file information, such as the genre, date and file format, for the current selection.

- 3 Press **ENTER** to play the currently highlighted movie.

Press **▶** to start or resume playback from the last title played.

Displaying the Movie Options menu

- Press **→** to display the Movie Options menu:

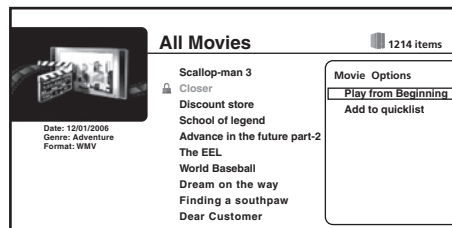

- **Play from Beginning:** Play the selected movie from the beginning.
- **Add to Quicklist:** Add the selected movie to your Quicklist. The Quicklist feature is a useful way to organize movie files for handy selection and playback. The Quicklist can contain up to 25 movies.¹

Note

¹ Quicklists are lost in the following instances:

- When you exit Movie Navigator.
- When you change the server to which you are connected.

Displaying the browse menu

- Press **←** to display the browse menu:

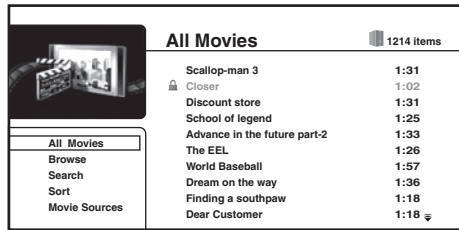

Depending on the browse menu, certain options may not be selectable.

- All Movies:** Display all movie files found on the selected server.
- Browse:** Browse movies by **Genre**, **Quicklist** or **Folders**. See also *Browsing movies* below.
- Search:** Find a movie by entering a name (or a few letters) to search for. The search results are narrowed down as you enter more letters. See also *Searching movies* below.
- Sort:** Sort movies by date (oldest first or most recent first), or alphabetically by title or genre ('A' first or 'Z' first).
- Movie Sources:** Display servers on the network. See also *Movie sources* below.

Browsing movies

The Browse sub-menu gives you three ways to browse movies.



- Go back:** Return to the previous menu.
- Genres:** Display all movie genres and how many movies are in each one. Select a genre and press **ENTER** to see the list of movies in that genre.
- Quicklist:** Display a list of all the movies currently in your Quicklist. Press **→** to display the **Movie Options** menu, where you can start playback or remove movies from the Quicklist:

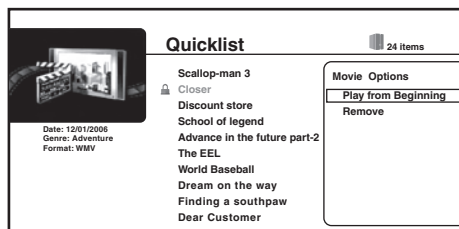

- Folders:** Display a list of folders and movie files. Select a folder and press **ENTER** to see the list of movies and subfolders within the folder. (The folder configuration may change depending on the server type.)

Searching movies

From the Search sub-menu you can enter a few (up to 20) characters of a movie title or genre. As each character is entered into the search field the search results are dynamically updated, narrowing down the list of movies until you can see the one you're looking for.

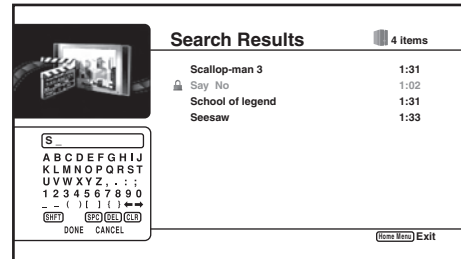

- Use the **↑/↓/←/→** and **ENTER** buttons to select characters from the keypad.
- Select **SHIFT** to toggle between upper and lower case.
- Select **SPC** to insert a space.
- Select **DEL** to delete the character at the current cursor position in the search field.
- Select **CLR** to clear the search field.
- Select **DONE** to close the keypad and select a movie or genre from the search results; select **CANCEL** to close the keypad and clear the search results.

Movie sources

From the movie sources window you can see all the servers found on the network and change the selected server.

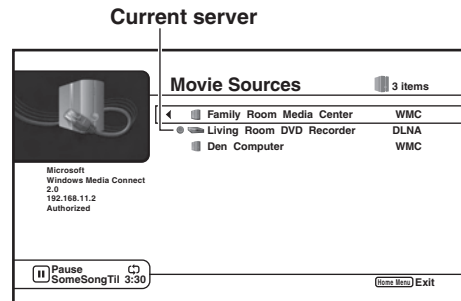

- Some servers found on the network may not be available for the following reasons:
 - The player is collecting file information from the server.
 - There are no playable movie files on the server.
 - This player is not authorized for the server. See also *Authorizing this player* on page 38.
- Servers not currently available appear with a lock icon (✗) in the server list.

Photo Navigator

The photo section of the Home Media Gallery allows you to browse and display all the compatible photo files found on your local area network (non-photo files are not displayed).

See also *File compatibility* on page 9 for more on compatible file types.

1 If you haven't already done so, select 'Home Media Gallery' from the Home Menu, then 'Photos'.

You should see a list of albums from the selected server.

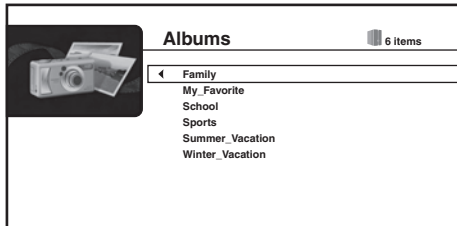

2 Use the ↑/↓ buttons to change the current selection (highlighted in yellow).

3 Press ENTER to display the selected photo list.

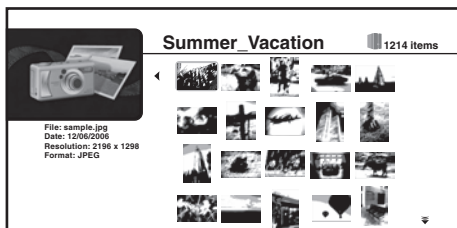

4 Use the ↑/↓/←/→ buttons to change the current thumbnail selection (highlighted in yellow).

Press ► to start or resume slideshow playback from the last photo displayed.

Displaying the Photo Options menu

• Press ENTER to display the Photo Options menu:

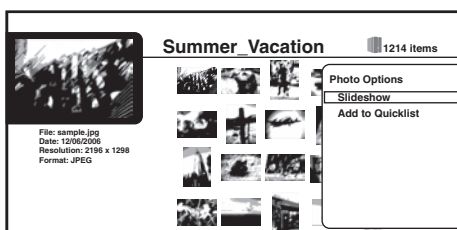

- **Slideshow:** Starts full-screen slideshow playback from the currently selected photo. During the slideshow, press ►► to advance to the next photo; ◀◀ to go back to the previous photo; || (pause) to pause the slideshow; ■ to stop and exit the slideshow; **PHOTO ZOOM** to enlarge the picture on the screen.
- **Add to Quicklist:** Add the selected photo to your Quicklist. The Quicklist feature is a useful way to organize photos for handy selection and slideshow playback. The Quicklist can contain up to 25 photos.¹

Note

¹ Quicklists are lost in the following instances:

- When you exit Photo Navigator.
- When you change the server to which you are connected.

Displaying the browse menu

- From the left-most column, press ← to display the Browse menu:

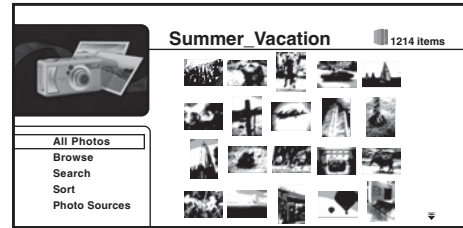

Depending on the browse menu, certain options may not be selectable.

- **All Photos:** Display all photos found on the server.
- **Browse:** Browse photos by **Albums**, **Date**, **Quicklist** or **Folders**. See also *Browsing photos* below.
- **Search:** Find a photo by entering a name (or a few letters) to search for. The search results are narrowed down as you enter more letters. See also *Searching photos* on page 36.
- **Sort:** Sort photos by date (oldest first or most recent first), or alphabetically by name ('A' first or 'Z' first).
- **Photo Sources:** Display servers on the network. See also *Photo sources* on page 36.

Browsing photos

The Browse sub-menu gives you several ways to browse photos.

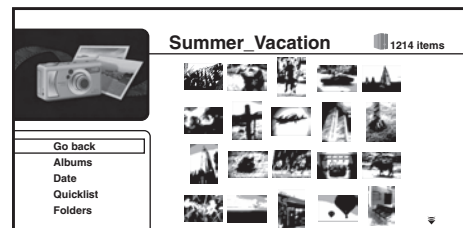

- **Go back:** Return to the previous menu.
- **Albums:** Display a list of server albums.
- **Date:** Browse photos by date (year and month). Select a year then press **ENTER** to further browse by month. Select a month and press **ENTER** to see the photos taken that month.
- **Quicklist:** Display thumbnails of all the photos currently in your Quicklist. Press **ENTER** to display the **Photo Options** menu, where you can start slideshow playback or remove photos from the Quicklist:

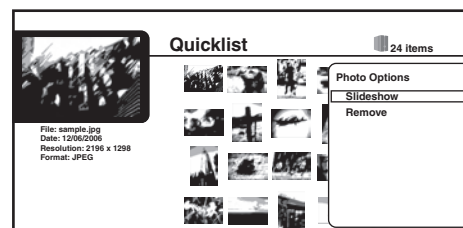

- **Folders:** Display a list of folders and photo files. Select a folder and press **ENTER** to see a list of photos and subfolders within the folder. (The folder configuration may change depending on the server type.)

Searching photos

From the Search sub-menu you can enter a few (up to 20) characters of a photo title. As each character is entered into the search field the search results are dynamically updated, narrowing down the list of photos until you can see the one you're looking for.

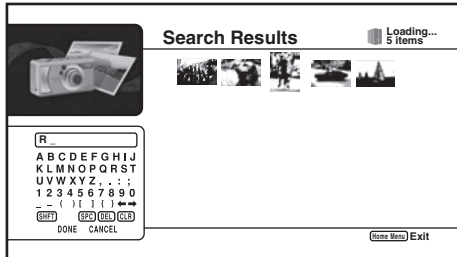

See *Searching movies* on page 34 for how to use the screen keypad.

Photo sources

From the photo sources window you can see all the servers found on the network and change the selected server. See *Movie sources* on page 34 for more information.

Music Navigator

From the music section of the Home Media Gallery you can browse and play all the compatible song files found on your local area network (non-music files are not displayed).

See also *File compatibility* on page 9 for more on compatible file types.

1 If you haven't already done so, select 'Home Media Gallery' from the Home Menu, then 'Music'.

You should see a list of all the artist names found on the selected server.

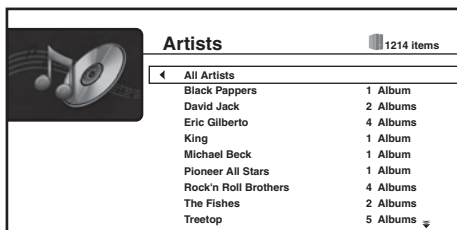

2 Use the ↑/↓ buttons to change the current selection (highlighted in yellow).

3 Press ENTER to display the album list.

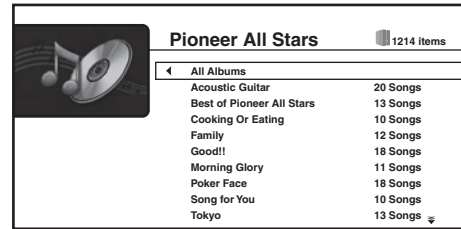

4 Select the album you want to listen to and press ENTER to display the song list.



- When the song length cannot be determined, it is displayed as “-:-:-”.

5 Use the ↑/↓ buttons to change the current selection (highlighted in yellow).

On the left side of the screen you can see file information, such as the artist and album name, genre and file format, for the current selection.

6 Press ENTER to play the currently highlighted music.

The display shows the **Now Playing** screen.

- Press ► to start or resume playback from the last track played on the **Now Playing** screen.

Displaying the Song Options menu

- Press → to display Song Options menu:

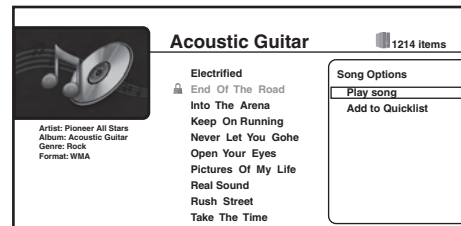

- **Play Song:** Play the selected song from the beginning.
- **Add to Quicklist:** Add the selected song to your Quicklist. The Quicklist feature is a useful way to organize music files for handy selection and playback. The Quicklist can contain up to 25 songs.¹

Note

¹ Quicklists are lost in the following instances:

- When you exit Music Navigator.
- When you change the server to which you are connected.

Displaying the browse menu

- Press **←** to display the browse menu:



Depending on the browse menu, certain options may not be selectable.

- **All Songs:** Display all songs (files/tracks) found on the server.
- **Browse:** Browse songs by **Artists, Albums, Genres, Playlists, Quicklist** or **Folders**. See also *Browsing songs* below.
- **Search:** Find a song by entering a name (or a few letters) to search for. The search results are narrowed down as you enter more letters. See also *Searching songs* below.
- **Sort:** Sort songs by date (oldest first or most recent first), or alphabetically by song title, artist, album or genre ('A' first or 'Z' first).
- **Now Playing:** Display song information (track name, artist, album, genre, etc.) and playback information. See also *Now playing song information* on page 37.
- **Music Sources:** Display servers on the network. See also *Music sources* on page 37.

Browsing songs

The browse sub-menu gives you various ways to browse songs.

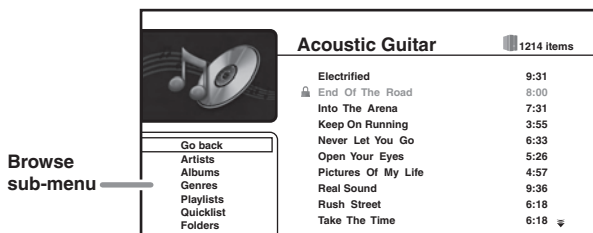

- **Go back:** Return to the previous menu.
- **Artists:** Display a list of artists, and how many albums are associated with each. Select an artist and press **ENTER** to see the album list by that artist.
- **Albums:** Display a list of albums, and how many songs are associated with each. Select an album and press **ENTER** to see the list of songs on that album.
- **Genres:** Display all music genres, and how many songs are in each one. Select a genre and press **ENTER** to see the list of artists in that genre.
- **Playlists:** Display the server Playlists.

- **Quicklist:** Display a list of all the songs currently in your Quicklist. Press **→** to display the **Song Options** menu, where you can start playback or remove songs from the Quicklist:



- **Folders:** Display a list of folders and song files. Select a folder and press **ENTER** to see the list of songs and subfolders within the folder. (The folder configuration may change depending on the server type.)

Searching songs

From the Search sub-menu you can enter a few characters (up to 20) of a song title, genre, artist or album. As each character is entered into the search field the search results are dynamically updated, narrowing down the list of songs until you can see the one you're looking for.

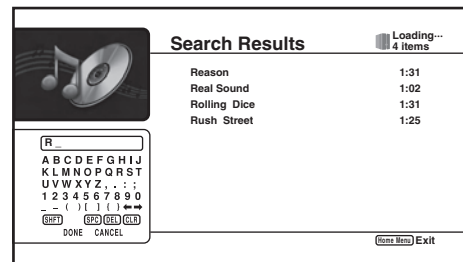

See *Searching movies* on page 34 for how to use the screen keypad.

Now playing song information

The **Now Playing** screen shows detailed information about the song playing, including:

- Artist and song title
- Progress bar (elapsed time and song length)
- Album name
- Genre
- File format
- Browse menu
- Play status
- Play mode
- Next/Previous song names

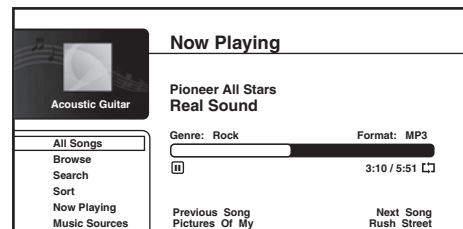

Music sources

From the music sources window you can see all the servers found on the network and change the selected server. See *Movie sources* on page 34 for more information.

06 About Windows Media Player 11/Windows Media Connect

Windows Media Player 11/Windows Media Connect is software to deliver music, photos and movies from a Microsoft Windows XP computer to home stereo systems and TVs. The same function is also available in Windows Media Player 11.

With this software, you can play back files stored on the PC through various devices wherever you like in your home.

At this time you cannot download the Windows Media Connect software from Microsoft's website. If your server currently does not have Windows Media Connect installed, install Windows Media Player 11 (for Windows XP) instead. This software can be downloaded from Microsoft's website.

For more information check the official Microsoft website.

Authorizing this player

In order to be able to browse and play files from a server this player must be authorized or registered. This happens automatically when the player makes a connection over the network to the server. If not, please authorize or register this player manually on the server.

For more information on authorizing this player, refer to the instruction manual of your server.



FAQ

- *Some files don't show up. Where are they?*
 - File names that don't end with one of the permitted extensions won't be recognized by this player. See also *File compatibility* on page 9.
 - Supported file formats vary by server. As such, files not supported by your server are not displayed on this unit.
- For more information check with the manufacturer of your server.

First entering Movie, Photo or Music Navigator

After powering on this player and entering the Movie, Music or Photo Navigator, you may be presented with the **Folders** screen. This is due to this player compiling a list of the available media on your media servers. This list will vary depending on the media sharing software you are using, but you will be able to navigate through the list using the **↑/↓** buttons, the **ENTER** key to select a folder, or the **ENTER** key on the **Go back** selection found in each folder.

If you come to a folder containing content that you wish to play, you may press **→** to display the **Movie Options**, **Photo Options**, or **Song Options** as illustrated in pages 33, 35 and 36).

Pressing **←** to display the browse menu (as illustrated in, pages 34, 35 and 37) will may a browse menu with the **All Movies**, **All Photos** or **All Songs** options grayed out. If this is the case, this means that this player has not finished compiling the list of available media, and you may continue to browse through the folders and play media while this list completes. When this player has finished compiling this list, the **All Movies**, **All Photos** or **All Songs** options will no longer be grayed out, and you will be able to select these and continue navigating as described in this chapter:

If you are not presented with a folders menu as described above, this means that this player has finished compiling a list of available media on your media servers, and you can navigate through the Movie, Photo or Music Navigator screens as described in this manual.

Changing content on your Media Server

If you change the available content on your media server (by adding or removing shared files) while you are in the Movie, Photo or Music Navigators, the Movie, Photo or Music Navigator screen you are on will change to the Folders menu. From here, you can browse the folders and play content as described in the first section. Once this player has finished compiling a new list of available media, the **All Movies**, **All Photos** or **All Songs** options of the browse menu will become highlighted an accessible.

Chapter 7

Video/Audio Adjust menu

From the **Video/Audio Adjust** menu you can make various settings that affect how video is presented on your TV and how the sounds. Items in the **Video/Audio Adjust** menu can only be changed during playback.

Video Adjust

- Default setting: **Standard**

From the **Video Adjust** screen you can select the **Standard** or **Cinema** video presentation or define presets of your own in **Memory 1** to **Memory 3**.

1 Press HOME MENU and select 'Video/Audio Adjust' from the on-screen display.

You can press **VIDEO ADJUST** on the remote to display the **Video Adjust** screen.

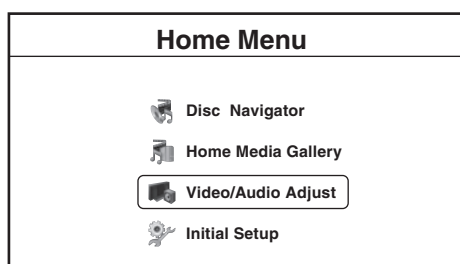

2 Select 'Video Adjust'.

3 Use the ←/→ buttons to select a preset.

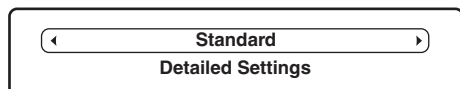

- **Standard** – Standard setting
- **Cinema**¹ – Optimized for watching movies
- **Memory 1/Memory 2/Memory 3** – Use for saving your own presets (see *Creating your own presets* below)

4 Press ENTER or RETURN to make the setting and exit the Video Adjust screen.

PureCinema

There are two types of video signals: Video interlace material, with a frame rate of 30 frames/second; and film progressive material, that has a frame rate of 24 frames/second.

In PureCinema mode film progressive material is converted to 60 frames/second progressive, which matches more closely the picture quality of a cinema screen. (24 frames/second source is converted to 60 frames/second.)

When you have **Video Adjust** set to **Standard**, **Cinema**, or **Memory 1**, **Memory 2** or **Memory 3** and play a BD-ROM or DVD disc video that can be identified as film progressive or video interlace material, PureCinema mode is automatically activated.

If you notice problems with the images projected when set to **Cinema** (images appear to motion-blurred, or jagged), set the **Video Adjust** to **Standard** or **Memory 1**, **Memory 2** or **Memory 3**.

Creating your own presets

You can create up to three presets of your own.

1 Select one of the Memory presets.

2 Press ↓ to select 'Detailed Settings' then press ENTER.

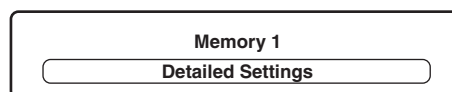

3 Adjust the picture quality settings.

- Use the ↑/↓ buttons to select a setting.
- Use the ←/→ buttons to adjust the current setting.

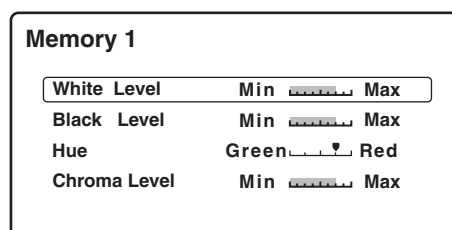

Select a setting then press **ENTER** to display just that setting. This gives you more screen area in which to see the effects of changes you make.

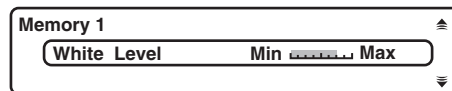

- Press **ENTER** or **RETURN** to go back to full-screen display.
- You can adjust any or all of the following picture quality settings:
 - **White Level**¹ – Adjusts the intensity of white.
 - **Black Level**¹ – Adjusts the intensity of black.
 - **Hue**¹ – Adjusts the overall color balance between red and green.
 - **Chroma Level**¹ – Adjusts how saturated colors appear.

4 Press RETURN to save the preset and exit the Detailed Settings screen.

Note

¹ Effective only for video output from **HDMI OUT** or **COMPONENT VIDEO OUT** connections (settings do not affect video output from **VIDEO OUT** or **S-VIDEO OUT**).

Audio Adjust

From the **Audio Adjust** menu you can set the **Audio DRC** (Dynamic Range control).

Audio DRC

- Default setting: **Off**

When watching Dolby Digital BD and DVD discs, as well as PC files with Dolby Digital audio, at low volume, it's easy to lose the quieter sounds completely — including some of the dialog. Switching **Audio DRC** to **On** can help by bringing up the quieter sounds, while controlling loud peaks.

How much of a difference you hear depends on the material you're listening to. If the material doesn't have wide variations in volume, you may not notice much change.



Important

- Audio DRC is effective with the following types of audio:
 - Analog audio from the **AUDIO OUT (2ch)** and **AUDIO OUT (5.1ch)** jacks.
 - PCM audio from the **DIGITAL AUDIO OUT (COAXIAL/OPTICAL)** and **HDMI OUT** jacks (see also *About the audio output settings* on page 44).

1 Press HOME MENU and select 'Video/Audio Adjust' from the on-screen display.

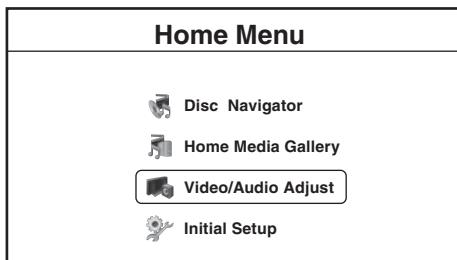

2 Select 'Audio Adjust'.

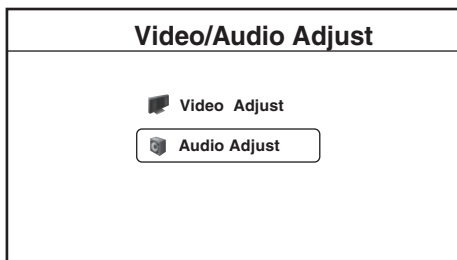

3 Highlight Audio DRC, then use the ◀/▶ buttons to change to 'Off', 'Level 1', 'Level 2' or 'Max' as required.

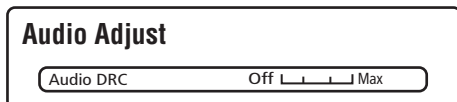

4 Press ENTER or RETURN to make the setting and exit the Audio Adjust screen.

Chapter 8

Initial Setup menu

Using the Initial Setup menu

The **Initial Setup** menu is where you can set various player options for sound, picture, language and so on. Note that settings can only be changed when the player is stopped.

If you disconnect the player from the wall outlet before switching the player off, any new settings made during that session will be lost.

- **Press HOME MENU and select 'Initial Setup'.**

In the table below, the default option is marked with a •

Setting	Options	Explanation
Video Out		
TV Aspect Ratio	4:3 (Standard)	Select if you have a standard 4:3 TV. See <i>Changing the output video resolution</i> . When the output video resolution is set to 720p , 1080i or 1080p , video is output in 16:9 widescreen format even if TV Aspect Ratio is set to 4:3 (Standard) . When connected to a 4:3 TV, set the output video resolution to 480i or 480p . See also <i>Changing the output video resolution</i> on page 14.
	16:9 (Widescreen) •	Select if you have a widescreen 16:9 TV.
4:3 Video Out	Full	4:3 video material is output without black bars on either side of the picture if the TV Aspect Ratio (above) is set to 16:9 (Widescreen) .
	Normal •	4:3 video material is output with black bars on either side of the picture if the TV Aspect Ratio setting (above) is set to 16:9 (Widescreen) .
DVD 16:9 Video Out	Letter Box •	If the TV Aspect Ratio setting (above) is set to 4:3 (Standard) , select this if you prefer letterbox presentation of 16:9 format DVDs.
	Pan & Scan	If the TV Aspect Ratio setting (above) is set to 4:3 (Standard) , select this if you prefer Pan & Scan presentation of 16:9 format DVDs.
<i>Some discs contain only Letter Box or Pan & Scan presentation so the video output will depend on the disc.</i>		
HDMI Color Space	YCbCr •	This is the standard setting for HDMI-compatible devices.
	RGB (16-235)	Use this setting if colors appear overly rich and the black too deep on the RGB (0-255) setting.
	RGB (0-255)	Use if colors are weak and black appears to 'float' on the RGB (16-235) setting.
<i>When using an HDMI monitor that accepts only RGB input, this player outputs RGB video even if this setting is set to YCbCr. If the monitor is DVI-compatible, the player outputs RGB (0-255) color space. If however the picture looks unnatural, set it to RGB (16-235).</i>		
24p Direct Out	On	Gives smooth movement in BD film material video. This setting is only effective when the player is connected to a 1080/24p-compatible TV using HDMI.
	Off •	Choose this setting if you notice picture disturbance when the video switches between video and film material.
<i>When 24p Direct Out is On, you may experience some picture disturbance when the video switches between video and film material. See also <i>Changing the output video resolution</i> on page 14.</i>		

Setting	Options	Explanation
Audio Out		
Dolby Digital Out	Dolby Digital •	Outputs a Dolby Digital signal when a Dolby Digital source is being played.
	Dolby Digital → PCM	Converts Dolby Digital sources to Linear PCM output. Use if your connected equipment doesn't support Dolby Digital audio.
<i>This setting is effective in digital audio outputs.</i>		
DTS Out	DTS •	Outputs a DTS signal when a DTS source is being played.
	DTS → PCM	Converts sources with DTS audio to Linear PCM output. Use if your connected equipment doesn't support DTS audio.
<i>This setting is effective in digital audio outputs.</i>		
DTS Downmix	Stereo •	If you've selected DTS → PCM in DTS Out above, you can choose the way the DTS signal is downmixed PCM audio. Stereo downmixes the signal to 2-channel stereo.
	Lt/Rt	Downmixes to a 2-channel signal compatible with Dolby surround matrix decoders. (This allows you to hear surround sound if your AV receiver or amplifier has Dolby Pro Logic capability.)
HDMI Audio Out	Auto •	Outputs a bitstream of Dolby TrueHD, Dolby Digital Plus, Dolby Digital, DTS-HD High Resolution Audio or DTS. However, if the player is connected to an HDMI device that is incompatible with the output of Dolby TrueHD, Dolby Digital Plus or DTS-HD High Resolution Audio, it outputs the Dolby Digital or DTS bitstream. Depending on the HDMI device connected and the content being played, Linear PCM audio may be output. See <i>About the audio output settings</i> on page 44 for details.
	PCM	All audio signals are converted to Linear PCM. This player can output up to 7.1 ch Linear PCM if the connected HDMI devices are capable of the output of Dolby TrueHD, Dolby Digital Plus or DTS-HD High Resolution Audio. See <i>About the audio output settings</i> on page 44 for details.
Language		
OSD Language	English •	Sets the language of the on-screen displays to English.
	<i>available languages</i>	Choose from the languages displayed for the on-screen displays.
Audio Language	English •	Sets both the BD-ROM and DVD-Video default audio language to English.
	<i>available languages</i>	Choose from the languages displayed to set the default audio language for BD-ROM and DVD-Video playback.
	Other	Continue to the next screen to set the default audio language for BD-ROM and DVD-Video disc playback. You can select the language name or enter the code number (see on page 49 for the code list).
<i>Discs do not necessarily have audio in your selected language. Also, some discs override the Audio Language preference.</i>		
Subtitle Language	English •	Sets the default subtitle language for BD-ROM and DVD-Video playback to English.
	<i>available languages</i>	Choose from the languages displayed to set the default subtitle language for BD-ROM and DVD-Video playback.
	Other	Continue to the next screen to set the default subtitle language for BD-ROM and DVD-Video disc playback. You can select the language name or enter the code number (see on page 49 for the code list).
<i>Discs do not necessarily have subtitles in your selected language. Also, some discs override the Subtitle Language preference.</i>		
BD/DVD Menu Language	w/Subtitle Language •	Sets the language of BD-ROM and DVD-Video menus to the same as that set for the subtitle language.
	<i>available languages</i>	Choose from the displayed languages to set the default language for BD-ROM and DVD-Video menus.
	Other	Continue to the next screen to set the default menu language for BD-ROM and DVD-Video disc menus. You can select the language name or enter the code number (see on page 49 for the code list).
<i>Discs do not necessarily have menus in your selected menu language.</i>		
Subtitle Display	On •	Select to have BD-ROM and DVD-Video discs display subtitles.
	Off	Select to switch off subtitle display.
<i>Some discs may override these settings.</i>		

Setting	Options	Explanation
Parental Lock		
Change Password (Set Password)	Next Screen	Set or change the password necessary to play BD or DVD discs that have level/age restrictions. In order to change the password, you'll need to first enter your existing one.
DVD Parental Lock	Change Level	Enter your password and then set the parental lock level. Discs with a lock level higher than that set in the player will require the password to play.
	DVD Country Code	Enter your password and then set a country/area code. This ensures that you see the scenes intended for your country or area. See <i>BD/DVD country/area code list</i> on page 49.
BD Parental Lock	Change Age Restriction	Enter your password and then set the age restriction. "255" indicates no parental control.
	BD Country Code	Enter your password and then set a country/area code. This ensures that you see the scenes intended for your country or area. See <i>BD/DVD country/area code list</i> on page 49.
<i>Only certain discs have parental lock features. Check the disc packaging to see what features the disc has. If you forget your password you can reset it by resetting the player to its factory settings. See <i>BD/DVD language code list</i> on page 49.</i>		
Network		
IP Configuration	Next Screen	Continue to the next screen to input IP address details. See <i>Setting up for network use</i> on page 21 for more detailed information.
Device Name	Next Screen	Continue to the next screen to set the name of this player as it will appear to other devices on the network. See <i>Setting up for network use</i> on page 21 for more detailed information.
Display Network Config.	Next Screen	Continue to the next screen to see a summary of your network settings.
Speakers		
Audio Output Mode	2 Channel •	Set if you connected this player to an amplifier using only the front left/right channels of the AUDIO OUT (5.1ch) outputs.
	5.1 Channel	Set if you connected this player to an amplifier using all 5.1 channels of the AUDIO OUT (5.1ch) outputs. On this setting the audio output from the AUDIO OUT (2ch) jacks will be incorrect.
Speaker Setup	Next Screen	Continue to the next screen to specify which speakers are connected to your system. This setting affects how audio is output from the multi-channel analog outputs. See <i>Speaker Setup</i> on page 45 for more detailed information.
Options		
On Screen Display	On •	The player displays operation displays ("Stop", "Play", etc.) on-screen.
	Off	Switches off the on-screen operation displays.
Auto Power Off	On •	If the player is stopped or paused for more than 30 minutes with no operation by the user, the player automatically switches itself off.
	Off	No automatic power off.
Setup Navigator	Start	Select to start the Setup Navigator. See also <i>Switching on and setting up</i> on page 20.
HDMI Control	On •	Select when using the HDMI Control function. See <i>HDMI Control</i> on page 7.
	Off	Select when not using the HDMI Control function. See <i>HDMI Control</i> on page 7.
Set hybrid disc playback layer	BD •	Playback the BD portion.
	DVD	Playback the DVD portion. When no DVD portion is present, the BD portion is played back.
	CD	Playback the CD portion. When no CD portion is present, the BD portion is played back.
<i>This setting cannot be changed when a disc is inserted in the disc tray.</i>		
Software Update	Start	The Software Update function can check for and download updated system software from the network server. See <i>Software updating</i> on page 45.

About the audio output settings

The table below shows how the audio settings you make in the Initial Setup menu (page 41) affect the output to the analog (2ch/5.1ch), digital and HDMI outputs with various types of disc/files.

Disc audio format		Analog outputs		Digital outputs		HDMI output ¹	
		2ch ²	5.1ch ²	PCM convert ³	Bitstream ^{4,5}	PCM ⁶	Auto ^{5,6,7}
BD-ROM	Dolby Digital	2ch downmix PCM	5.1ch PCM	2ch downmix PCM	Dolby Digital	5.1ch PCM	Dolby Digital
	Dolby Digital Plus ⁸	2ch downmix PCM	5.1ch PCM	2ch downmix PCM	Dolby Digital	7.1ch PCM ⁹	Dolby Digital Plus
	Dolby TrueHD ⁸	2ch downmix PCM	5.1ch PCM	2ch downmix PCM	Dolby Digital	7.1ch PCM ^{9,10,11,12,13}	Dolby TrueHD ¹⁴
	DTS	2ch downmix PCM	5.1ch PCM	2ch downmix PCM	DTS	5.1ch PCM ^{10,15,16}	DTS
	DTS-HD High Resolution Audio ¹⁷	2ch downmix PCM	5.1ch PCM	2ch downmix PCM	DTS	7.1ch PCM ^{9,10,12,15}	DTS-HD High Resolution Audio
	DTS-HD Master Audio ¹⁸	2ch downmix PCM	5.1ch PCM	2ch downmix PCM	DTS	5.1ch PCM ^{10,15,16}	DTS
	Linear PCM	2ch downmix PCM	5.1ch downmix PCM ¹¹	2ch downmix PCM	2ch downmix PCM	7.1ch PCM ^{10,11,15}	7.1ch PCM
DVD-Video	Dolby Digital	2ch downmix PCM	5.1ch PCM	2ch downmix PCM	Dolby Digital	5.1ch PCM	Dolby Digital
	DTS	2ch downmix PCM	5.1ch PCM	2ch downmix PCM	DTS	5.1ch PCM	DTS
	MPEG	2ch PCM	2ch PCM	2ch PCM	2ch PCM	2ch PCM	2ch PCM
	Linear PCM	2ch PCM	2ch PCM	2ch PCM	2ch PCM	2ch PCM	2ch PCM

1. If the connected HDMI device is compatible with fewer channels of Linear PCM audio than this player, the output will be adjusted to be compatible with the HDMI device.

2. When **Audio Output Mode** is set to **2 Channel** or **5.1 Channel** (see **Audio Output Mode** on page 43).

3. **Dolby Digital** → **PCM** or **DTS** → **PCM** setting (see **Dolby Digital Out** and **DTS Out** on page 42).

4. **Dolby Digital** or **DTS** setting (see **Dolby Digital Out** and **DTS Out** on page 42).

5. Even if there is interactive audio, interactive audio is not mixed.

6. When **HDMI Audio Out** is set to **PCM** or **Auto** (see **HDMI Audio Out** on page 42).

7. If the connected HDMI device is not compatible with Dolby Digital Plus, Dolby TrueHD or DTS-HD High Resolution Audio, the signal will be output as Dolby Digital or DTS. If the HDMI device is not compatible with Dolby Digital or DTS, the signal is output as Linear PCM. If Dolby TrueHD, Dolby Digital Plus or DTS-HD High Resolution Audio is converted and output as Linear PCM, the output signal is Linear PCM of each source signal.

8. **AUDIO OUT (2ch)**, **AUDIO OUT (5.1ch)** and **DIGITAL AUDIO OUT (COAXIAL/OPTICAL)** output Dolby Digital.

9. Audio is output in 7.1ch/6.1ch with Surround Back output sources only. With other sources, audio is output in 5.1ch. The 6.1 Surround Back audio is output in 7.1ch.

10. Interactive audio is not mixed when the sampling rate is 192 kHz or 96 kHz.

11. Outputs 2ch downmix PCM when the sampling rate is 192 kHz.

12. Outputs max. 5.1ch audio when the disc contains 96 kHz audio and the resolution is set to **720p**, **1080i** or **1080p**.

13. Outputs 2ch audio when the disc contains 96 kHz audio and the resolution is set to **480i** or **480p**.

14. Outputs a Dolby Digital bitstream when the resolution is set to **480i** or **480p**.

15. Outputs 48 kHz audio when the disc contains 96 kHz audio and the resolution is set to **480i** or **480p**.

16. Outputs 7.1ch audio when the source is the DTS-ES 6.1 Discrete audio.

17. **AUDIO OUT (2ch)**, **AUDIO OUT (5.1ch)** and **DIGITAL AUDIO OUT (COAXIAL/OPTICAL)** output DTS.

18. DTS sound is output.



Note

- Output sampling rate is 48 kHz through the digital audio outputs.
- MPEG audio is always output as linear PCM.

Speaker Setup

You only need to make this setting if you connected this player to your amplifier using the 5.1 channel analog outputs.

This setting does not affect any digital audio output.

Use the **Speaker Setup** screen to tell the player what kinds of speakers you have connected.

- 1 Press **HOME MENU** and select **'Initial Setup'**.
- 2 Select **'Speakers'**.
- 3 Select **'Speaker Setup'**, then **'Next Screen'**.
- 4 Use the **↑/↓** buttons to select a speaker.

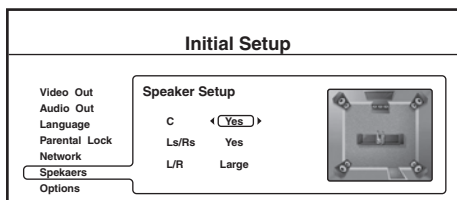

- 5 Use the **←/→** buttons to change the speaker setup.

Specify which speakers you have in your setup:

- **C (Center): Yes or No**
- **Ls/Rs (Surround): Yes or No**
- **L/R (Main): Small or Large** (This setting is only applicable if the **C** and **Ls/Rs** speakers are present.)

- 6 Press **ENTER** to save the settings and exit the **Speaker Setup** screen.

Software updating

The software of the player can be updated by connecting it to the Internet using a LAN cable.



Important

- Depending on the Internet connection conditions, software updating may take a certain period of time (certain time is also required for downloading of software). Other operations are defeated during software updating.
- As the disc tray opens automatically when software updating starts, it is recommended to open the rack door if the player is installed in a rack with front doors. When the disc tray is open, never attempt to push close it by force (leave the disc tray open).
- Do not unplug the power cord during software updating. Otherwise, the updating will be aborted and malfunction may occur with the player.



Note

- Steps **1** to **3** are the operations performed by the user (they are intended to download the software from the Internet).
- Steps **4** to **6** are the operations performed (automatically) by the player (they are intended to update the software).

- 1 Press **HOME MENU** and select **'Initial Setup'**.
- 2 Select **'Options'**, then **'Software Update'**.
- 3 Select **'Start'**, then **'Yes'**.

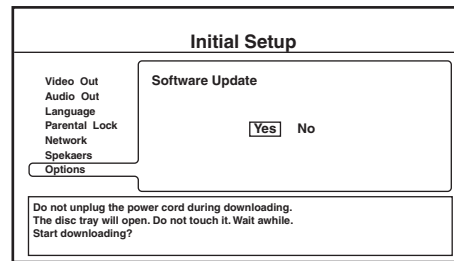

- The player turns off automatically.
- If the player is already running the latest software, a help message will be displayed.
- Depending on the Internet connection conditions, software updating may take a certain period of time (certain time is also required for downloading of software). Other operations are defeated during software updating.

- 4 **Downloading and updating of the software start.**

The front panel display shows the following messages, and the player produces an operating sound (it does not output audio or video).

```

"POWER OFF"
↓
"POWER ON"
↓
"NET"
↓
"NET-DWLD"
↓
"DOWNLOAD"

```

- 5 **Updating starts.**

- The front panel display shows messages such as **"DATA CHECK"**, **"WRT FLASH1"**, **"WRT DRIVE"** and **"WRT SUBCON"**.
- Do not unplug the power cord during software updating.

- 6 **The disc tray opens automatically when updating completes.**

- The front panel display shows **"DL OK"** and the player turns off automatically.
- When the disc tray is open, never attempt to push close it by force (leave the disc tray open).

- 7 **Verify that the software is updated properly.**

- Step **7** is the operation performed by the user.
- Turn the player on. If the front panel display shows **"DL OK"**, the software has been updated successfully.

Additional information

Taking care of your player and discs

Handling discs

When holding discs of any type, take care not to leave fingerprints, dirt or scratches on the disc surface. Hold the disc by its edge or by the center hole and edge.

Damaged or dirty discs can affect playback performance. Take care also not to scratch the label side of the disc. Although not as fragile as the recorded side, scratches can still result in a disc becoming unusable.

Should a disc become marked with fingerprints, dust, etc., clean using a soft, dry cloth, wiping the disc lightly from the center to the outside edge as shown in the diagram below.

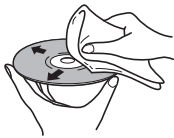

Wipe lightly from the center of the disc using straight strokes.



Don't wipe the disc surface using circular strokes.

If necessary, use a cloth soaked in alcohol, or a commercially available DVD/BD cleaning kit to clean a disc more thoroughly. Never use benzine, thinner or other cleaning agents, including products designed for cleaning vinyl records.

Storing discs

Although BD and DVD discs are more durable than vinyl records, you should still take care to handle and store discs correctly. When you're not using a disc, return it to its case and store upright. Avoid leaving discs in excessively cold, humid, or hot environments (including under direct sunlight).

Don't glue paper or put stickers onto the disc, or use a pencil, ball-point pen or other sharp-tipped writing instrument. These could all damage the disc.



For more detailed care information see the instructions that come with discs.

Do not load more than one disc into the player at a time.

Damaged and odd-shaped discs

Discs spin at high speed inside the player. If you can see that a disc is cracked, chipped, warped, or otherwise damaged, don't risk using it in your player — you could end up damaging it.

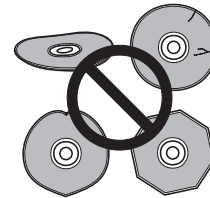

This player is designed for use with conventional, fully circular discs only. Use of shaped discs is not recommended for this product. Pioneer disclaims all liability arising in connection with the use of shaped discs.

Do not use any kind of adapter when playing 8 cm DVD discs. This size disc can be played in this player without an adapter; just use the smaller disc guide in the disc tray.

Cleaning the pickup lens

The player's lens should not become dirty in normal use, but if for some reason it should malfunction due to dust or dirt, consult your nearest Pioneer-authorized service center. Although lens cleaners for DVD players are commercially available, we advise against using them since some may damage the lens.

Problems with condensation

Condensation may form inside the player if it is brought into a warm room from outside, or if the temperature of the room rises quickly. Although the condensation won't damage the player, it may temporarily impair its performance. For this reason you should leave it to adjust to the warmer temperature for about an hour before switching on and using.

Hints on installation

We want you to enjoy using this product for years to come, so please bear in mind the following points when choosing a suitable location for it:

Do...

- Use in a well-ventilated room.
- Place on a solid, flat, level surface, such as a table, shelf or stereo rack.

Don't...

- Use in a place exposed to high temperatures or humidity, including near radiators and other heat-generating appliances.
- Place on a window sill or other place where the player will be exposed to direct sunlight.
- Use in an excessively dusty or damp environment.
- Place directly on top of an amplifier, or other component in your stereo system that becomes hot in use.
- Place the player on top of or immediately next to the television or monitor as you may experience interference.
- Use in a kitchen or other room where the player may be exposed to smoke or steam.
- Use on a thick rug or carpet, or cover with cloth — this may prevent proper cooling of the unit.
- Place on an unstable surface, or one that is not large enough to support all four of the unit's feet.

Moving the player

If you need to move this unit, first remove the disc, if there's one loaded, and close the disc tray. Next, press **⏻ STANDBY/ON** to switch the power to standby, checking that the power off indication in the display goes off. Wait at least 10 seconds. Lastly, disconnect the power cord.

Never lift or move the unit during playback — discs rotate at a high speed and may be damaged.

Caution for when the unit is installed in a rack with a glass door

Do not press the **▲ OPEN/CLOSE** button on the remote control to open the disc table while the glass door is closed. The door will hamper movement of the disc table, and the disc table could be damaged.

Screen sizes and disc formats

BD-ROM and DVD-Video discs come in several different screen aspect ratios, ranging from TV programs, which are generally 4:3, to CinemaScope widescreen movies, with an aspect ratio of up to about 7:3.

Televisions, too, come in different aspect ratios; 'standard' 4:3 and 'widescreen' 16:9.

Widescreen TV users

If you have a widescreen TV, the **TV Aspect Ratio** setting (page 41) of this player should be set to **16:9 (Widescreen)**.

When you watch discs recorded in 4:3 format, you can use the TV controls to select how the picture is presented. Your TV may offer various zoom and stretch options; see the instructions that came with your TV for details.

Please note that some movie aspect ratios are wider than 16:9, so even though you have a widescreen TV, these discs will still play in a 'letter box' style with black bars at the top and bottom of the screen.

Standard TV users

If you have a standard TV, the **TV Aspect Ratio** setting (page 41) of this player should be set to **4:3 (Standard)**.

Resetting the player

Use this procedure to reset all the player's settings to the factory default.

- 1 Make sure that the player is turned on.**
- 2 Press **■** to stop playback when a disc is being played back.**
- 3 Press and hold **■** and press **⏻ STANDBY/ON**.**
 - Use the control buttons on the front panel.
 - The player turns off with all settings reset.

1 Input the manufacturer code.

While holding down the **TV CONTROL**  button, input the two digit code from the table below that corresponds to the make of your TV.

For example, if you have a Pioneer TV, press and hold **TV CONTROL** , then press **0, 0** on the remote control.

2 Confirm that the TV is responding to the programmed code.

On the remote, press the **TV CONTROL**  button. If the TV switches on (or into standby if it was on previously), then you have the correct code.

If nothing happens when you press the **TV CONTROL**  button, start again from step 1 using a different code. Some manufacturers have several codes. Try each one until you find the one that works.

TV Preset code list

Please note that there are cases where only certain functions may be controllable after assigning the proper preset code, or the codes for the manufacturer in the list will not work for the model that you are using.

Manufacturer Code(s)

ACURA 44	FRONTECH 31, 42, 46	MAGNAVOX 07, 10, 03, 12, 29	SALORA 31, 32, 42, 43
ADMIRAL 31	FRONTECH/PROTECH 32	MANESTH 39, 46	SAMBERS 49
AIWA 60	FUJITSU 48	MARANTZ 07	SAMSUNG 07, 38, 44, 46, 69, 70
AKAI 32, 35, 42	FUNAI 40, 46, 58	MARK 07	SANYO 35, 45, 48, 21, 14, 91
AKURA 41	GBC 32, 42	MATSUI 07, 39, 40, 42, 44, 47, 48	SBR 07, 34
ALBA 07, 39, 41, 44	GE 00, 01, 08, 07, 10, 11, 17, 02, 28, 18	MCMICHAEL 34	SCHAUB LORENZ 42
AMSTRAD 42, 44, 47	GEC 07, 34, 48	MEDIATOR 07	SCHNEIDER 07, 41, 47
ANITECH 44	GELOSO 32, 44	MEMOREX 44	SEG 42, 46
ASA 45	GENERAL 29	METZ 31	SEI 32, 40, 49
ASUKA 41	GENEXXA 31, 41	MINERVA 31, 53	SELECO 31, 42
AUDIOGONIC 07, 36	GOLDSTAR 10, 23, 21, 02, 07, 50	MITSUBISHI 09, 10, 02, 21, 31	SHARP 02, 19, 27, 67, 90
BASIC LINE 41, 44	GOODMANS 07, 39, 47, 48, 56	MULTITECH 44, 49	SIAREM 32, 49
BAUR 31, 07, 42	GORENJE 38	NEC 59	SIEMENS 31
BEKO 38	GPM 41	NECKERMANN 31, 07	SINUDYNE 32, 39, 40, 49
BEON 07	GRAETZ 31, 42	NEI 07, 42	SKANTIC 43
BLAUPUNKT 31	GRANADA 07, 35, 42, 43, 48	NIKKAI 05, 07, 41, 46, 48	SOLAVOX 31
BLUE SKY 41	GRADIENTE 30, 57	NOBLIKO 49	SONOKO 07, 44
BLUE STAR 18	GRANDIN 18	NOKIA 32, 42, 52	SONOLOR 31, 35
BPL 18	GRUNDIG 31, 53	NORDMENDE 32, 36, 51, 52	SONTEC 07
BRANDT 36	HANSEATIC 07, 42	OCEANIC 31, 32, 42	SONY 04
BTC 41	HCM 18, 44	ORION 32, 07, 39, 40	SOUNDWAVE 07
BUSH 07, 41, 42, 44, 47, 56	HINARI 07, 41, 44	OSAKI 41, 46, 48	STANDARD 41, 44
CASCADE 44	HISAWA 18	OSO 41	STERN 31
CATHAY 07	HITACHI 31, 33, 34, 36, 42, 43, 54, 06, 10, 24, 25, 18	OSUME 48	SUSUMU 41
CENTURION 07	HUANYU 56	OTTO VERSAND 31, 32, 07, 42	SYSLINE 07
CGB 42	HYPSON 07, 18, 46	PALLADIUM 38	TANDY 31, 41, 48
CIMLINE 44	ICE 46, 47	PANAMA 46	TASHIKO 34
CLARIVOX 07	IMPERIAL 38, 42	PANASONIC 31, 07, 08, 42, 22	TATUNG 07, 48
CLATRONIC 38	INDIANA 07	PATHO CINEMA 42	TEC 42
CONDOR 38	INGELEN 31	PAUSA 44	TELEAVIA 36
CONTEC 44	INTERFUNK 31, 32, 07, 42	PHILCO 32, 42	TELEFUNKEN 36, 37, 52
CROSLEY 32	INTERVISION 46, 49	PHILIPS 31, 07, 34, 56, 68	TELETECH 44
CROWN 38, 44	ISUKAI 41	PHOENIX 32	TENSAI 40, 41
CRYSTAL 42	ITC 42	PHONOLA 07	THOMSON 36, 51, 52, 63
CYBERTRON 41	ITT 31, 32, 42	PROFEX 42, 44	THORN 31, 07, 42, 45, 48
DAEWOO 07, 44, 56	JEC 05	PROTECH 07, 42, 44, 46, 49	TOMASHI 18
DAINICHI 41	JVC 13, 23	QUELLE 31, 32, 07, 42, 45, 53	TOSHIBA 05, 02, 26, 21, 53
DANSAI 07	KAISUI 18, 41, 44	R-LINE 07	TOWADA 42
DAYTON 44	KAPSCH 31	RADIOLA 07	ULTRAVOX 32, 42, 49
DECCA 07, 48	KENDO 42	RADIOSHACK 10, 23, 21, 02	UNIDEN 92
DIXI 07, 44	KENNEDY 32, 42	RBM 53	UNIVERSUM 31, 07, 38, 42, 45, 46, 54
DUMONT 53	KORPEL 07	RCA 01, 10, 15, 16, 17, 18, 61, 62, 09	VESTEL 07
ELIN 07	KOYODA 44	REDIFFUSION 32, 42	VICTOR 13
ELITE 41	LEYCO 07, 40, 46, 48	REX 31, 46	VOXSON 31
ELTA 44	LIESEN&TTER 07	ROADSTAR 41, 44, 46	WALTHAM 43
EMERSON 42	LOEWE 07	SABA 31, 36, 42, 51	WATSON 07
ERRES 07	LUXOR 32, 42, 43	SAISHO 39, 44, 46	WATT RADIO 32, 42, 49
FERGUSON 07, 36, 51	M-ELECTRONIC 31, 44, 45, 54, 56, 07, 36, 51		WHITE WESTINGHOUSE 07
FINLANDIA 35, 43, 54			YOKO 07, 42, 46
FINLUX 32, 07, 45, 48, 53, 54			ZENITH 03, 20
FIRSTLINE 40, 44			PIONEER 00, 31, 32, 07, 36, 42, 51
FISHER 32, 35, 38, 45			
FORMENTI 32, 07, 42			

BD/DVD language code list

Language (Language code letter), **Language code**

Japanese (ja), 1001	Catalan (ca), 0301	Indonesian (in), 0914	Burmese (my), 1325	Serbian (sr), 1918
English (en), 0514	Corsican (co), 0315	Icelandic (is), 0919	Nauru (na), 1401	Siswati (ss), 1919
French (fr), 0618	Czech (cs), 0319	Hebrew (iw), 0923	Nepali (ne), 1405	Sesotho (st), 1920
German (de), 0405	Welsh (cy), 0325	Yiddish (ji), 1009	Norwegian (no), 1415	Sundanese (su), 1921
Italian (it), 0920	Danish (da), 0401	Javanese (jw), 1023	Occitan (oc), 1503	Swedish (sv), 1922
Spanish (es), 0519	Bhutani (dz), 0426	Georgian (ka), 1101	Oromo (om), 1513	Swahili (sw), 1923
Dutch (nl), 1412	Esperanto (eo), 0515	Kazakh (kk), 1111	Oriya (or), 1518	Tamil (ta), 2001
Russian (ru), 1821	Estonian (et), 0520	Greenlandic (kl), 1112	Panjabi (pa), 1601	Telugu (te), 2005
Chinese (zh), 2608	Basque (eu), 0521	Cambodian (km), 1113	Polish (pl), 1612	Tajik (tg), 2007
Korean (ko), 1115	Persian (fa), 0601	Kannada (kn), 1114	Pashto, Pushto (ps), 1619	Thai (th), 2008
Greek (el), 0512	Finnish (fi), 0609	Kashmiri (ks), 1119	Portuguese (pt), 1620	Tigrinya (ti), 2009
Afar (aa), 0101	Fiji (fj), 0610	Kurdish (ku), 1121	Quechua (qu), 1721	Turkmen (tk), 2011
Abkhazian (ab), 0102	Faroese (fo), 0615	Kirghiz (ky), 1125	Rhaeto-Romance (rm), 1813	Tagalog (tl), 2012
Afrikaans (af), 0106	Frisian (fy), 0625	Latin (la), 1201	Kirundi (rn), 1814	Setswana (tn), 2014
Amharic (am), 0113	Irish (ga), 0701	Lingala (ln), 1214	Romanian (ro), 1815	Tonga (to), 2015
Arabic (ar), 0118	Scots-Gaelic (gd), 0704	Laothian (lo), 1215	Kinyarwanda (rw), 1823	Turkish (tr), 2018
Assamese (as), 0119	Galician (gl), 0712	Lithuanian (lt), 1220	Sanskrit (sa), 1901	Tsonga (ts), 2019
Aymara (ay), 0125	Guarani (gn), 0714	Latvian (lv), 1222	Sindhi (sd), 1904	Tatar (tt), 2020
Azerbaijani (az), 0126	Gujarati (gu), 0721	Malagasy (mg), 1307	Sangho (sg), 1907	Twi (tw), 2023
Bashkir (ba), 0201	Hausa (ha), 0801	Maori (mi), 1309	Serbo-Croatian (sh), 1908	Ukrainian (uk), 2111
Byelorussian (be), 0205	Hindi (hi), 0809	Macedonian (mk), 1311	Sinhalese (si), 1909	Urdu (ur), 2118
Bulgarian (bg), 0207	Croatian (hr), 0818	Malayalam (ml), 1312	Slovak (sk), 1911	Uzbek (uz), 2126
Bihari (bh), 0208	Hungarian (hu), 0821	Mongolian (mn), 1314	Slovenian (sl), 1912	Vietnamese (vi), 2209
Bislama (bi), 0209	Armenian (hy), 0825	Moldavian (mo), 1315	Samoan (sm), 1913	Volapük (vo), 2215
Bengali (bn), 0214	Interlingua (ia), 0901	Marathi (mr), 1318	Shona (sn), 1914	Wolof (wo), 2315
Tibetan (bo), 0215	Interlingue (ie), 0905	Malay (ms), 1319	Somali (so), 1915	Xhosa (xh), 2408
Breton (br), 0218	Inupiak (ik), 0911	Maltese (mt), 1320	Albanian (sq), 1917	Yoruba (yo), 2515
				Zulu (zu), 2621

BD/DVD country/area code list

Country/Area, **Country/Area code**, **Country/Area code letter**

Argentina, 0118, ar	Finland, 0609, fi	Malaysia, 1325, my	Singapore, 1907, sg
Australia, 0121, au	France, 0618, fr	Mexico, 1324, mx	Spain, 0519, es
Austria, 0120, at	Germany, 0405, de	Netherlands, 1412, nl	Switzerland, 0308, ch
Belgium, 0205, be	Hong Kong, 0811, hk	New Zealand, 1426, nz	Sweden, 1905, se
Brazil, 0218, br	India, 0914, in	Norway, 1415, no	Taiwan, 2023, tw
Canada, 0301, ca	Indonesia, 0904, id	Pakistan, 1611, pk	Thailand, 2008, th
Chile, 0312, cl	Italy, 0920, it	Philippines, 1608, ph	United Kingdom, 0702, gb
China, 0314, cn	Japan, 1016, jp	Portugal, 1620, pt	United States of America, 2119, us
Denmark, 0411, dk	Republic of Korea, 1118, kr	Russian Federation, 1821, ru	

Troubleshooting

Incorrect operation is often mistaken for trouble or malfunction. If you think that there is something wrong with this component, check the points below. Sometimes the trouble may lie in another component. Inspect the other components and electrical appliances being used. If the trouble cannot be rectified after checking the items below, please contact customer services. In the US, call Toll Free (800) 421-1404. (Telephone lines are open Monday through Friday 6:00 AM to 4:30 PM (Pacific Time) and Saturday 8:00 AM to 4:30 PM (Pacific Time).) In Canada, call Local (905) 479-4411, or Long distance +1(877) 283-5901. (Telephone lines are open Monday through Friday 9:00 AM to 5:15 PM (EST).)

Playback troubleshooting

Problem	Remedy
The disc won't play or is automatically ejected after loading.	<ul style="list-style-type: none"> • Make sure the disc is free from dirt and dust and is not damaged (see <i>Taking care of your player and discs</i> on page 46). • Make sure the disc is loaded with the label side face-up and aligned properly in the disc tray guide. • Incompatible region: If the region on a BD-ROM or DVD-Video disc does not match the region on the player, the disc cannot be used (see <i>BD-ROM regions</i> and <i>DVD-Video regions</i> on page 10). • Condensation inside the player: Allow time for condensation to evaporate. Avoid using the player near an air-conditioning unit. • Make sure the disc is compatible with this player (see <i>Disc/content format playback compatibility</i> on page 9).

Picture freezes and the front panel and remote control buttons stop working.

- Press **■** (stop), then start playback again (**▶** (play)).
- Press the front panel **⏻** **STANDBY/ON** button to switch the power off, then switch back on and restart playback. If the power fails to switch off, press and hold **⏻** **STANDBY/ON** for 20 seconds until the power switches off. Then switch on again by pressing **⏻** **STANDBY/ON**.
- Unplug from the wall socket, then plug back in and switch on again by pressing **⏻** **STANDBY/ON** to switch the player on.

No picture/No color.

- Incorrect video connections: Check that connections are correct and that plugs are inserted fully. Also check the video cable for damage.
- TV/monitor or AV amplifier settings are incorrect: Check the instruction manual of the connected equipment.
- Depending on your display, some of the settings may result in the picture disappearing. In this case, press **OUTPUT RESOLUTION** repeatedly until the picture re-appears (see *Changing the output video resolution* on page 14).
- Some BD-ROM discs output video only over HDMI.

The video output is set to 720p/1080i/1080p, but the actual output is 480i or 480p.

- For copy-protection purposes, DVD-Video and some BD-ROM discs output 480i or 480p over the component output.

Screen is stretched or aspect does not change.

- The **TV Aspect Ratio** or **4:3 Video Out** setting in the Initial Setup menu is incorrect. See **TV Aspect Ratio** and **4:3 Video Out** on page 41 for how to set these correctly for your TV/monitor.
- When output video resolution is set to **720p**, **1080i** or **1080p**, video is output in 16:9 Widescreen format even if **TV Aspect Ratio** is set to **4:3 (Standard)**.

Picture disturbance during playback or dark image.

- This player is compatible with Macrovision System copy guard. Some discs include a copy prevention signal, and when this type of disc is played back, stripes etc., may appear on some sections of the picture depending on the TV. This is not a malfunction.
- Due to the player's copy protection circuits, connection of this device through a VCR or an AV selector may cause picture problems. This is not a malfunction.

No audio, or audio is distorted.

- No audio is output during slow motion playback or when scanning contents.
- Check your amplifier/receiver's settings (volume, input function, speaker settings, etc.).
- Check that the disc is free from dust and dirt, and that it is not damaged (*Taking care of your player and discs* on page 46).
- Check that all interconnects are firmly inserted.
- Check that the plugs and terminals are free of dirt, oxide, etc. and clean if necessary. Also check the cable for damage.
- Make sure the player's output is not connected to the amplifier's phono (turntable) inputs.
- Check the **Audio Output Mode** on page 43. If this is set to **5.1 Channel**, output from the **AUDIO OUT (2ch)** jacks will be incorrect.
- Check the *Speaker Setup* on page 45.
- For copy-protection purposes, some BD-ROM discs only output audio over optical/coaxial and HDMI.
- When Audio CDs containing text files or such data are played back, sound is muted.

The analog audio is OK, but there appears to be no optical/coaxial digital audio signal.

- Check that the **Dolby Digital Out** and **DTS Out** settings (page 42) are suitable for your amplifier/receiver — check the instruction manual that came with your amplifier/receiver (also check that the output settings on your amplifier/receiver are correct).

Cannot play multi-channel audio.

- Check the audio options available from the disc menu.
- Multi-channel 192 kHz audio is output in 2 channels.
- Check that the **Dolby Digital Out** and **DTS Out** settings (page 42) are suitable for your amplifier/receiver — check the instruction manual that came with your amplifier/receiver.
- If you connected this player to your amplifier/receiver using the 5.1 channel analog outputs, make sure the **Audio Output Mode** (page 43) and **Speaker Setup** (page 45) are set correctly.
- If you connected this player to your amplifier/receiver using HDMI, or the optical/coaxial digital outputs, make sure that the output settings on your amplifier/receiver are correct (refer to the instruction manual that came with your amplifier/receiver).
- To use the 7.1ch setting for **Dolby Digital Out**, set **Dolby Digital** → **PCM** (page 42).

Noise is output when DTS audio is played.

- If this unit is connected to a non-DTS compatible amplifier or decoder using a digital audio cable, set **DTS Out** to **DTS** → **PCM** (page 42). If you do not do this, noise will be output when you play a DTS disc.

Cannot output 96 kHz or 192 kHz digital audio from optical/coaxial digital output.

- The player does not output digital audio from the optical/coaxial jacks at this sampling rate. The digital output is automatically downsampled.

Problem	Remedy
Disc containing PC files won't play.	<ul style="list-style-type: none"> • Make sure the disc is compatible with this player (see <i>Disc/content format playback compatibility</i> on page 9). • This player is compatible with multi-border discs, but only plays the first border. • Check that the file complies to one of the supported formats, bit rates or profiles (see <i>File compatibility</i> on page 9). Also check that the file is not damaged. • If the message 'Cannot play this format' is displayed when you try to play PC files, check the file formats. • This player cannot play DRM-protected content on DVD and DRM-protected titles appear in the Disc Navigator with a lock icon (🔒).
No picture or High Definition video output when watching a BD.	<ul style="list-style-type: none"> • For copy-protection purposes, composite, S-Video and component video output may not be possible. See <i>Connecting for HDMI output</i> on page 13 to connect using HDMI.
Image is blurred when you begin playback of a disc.	<ul style="list-style-type: none"> • Certain televisions cause blur effects when playback of a disc begins. This is not a malfunction.
Tracks/files are repeated during random play.	<ul style="list-style-type: none"> • Because tracks/files are selected entirely at random, same tracks/files may be played in quick succession. For example, 'Track 1' may be followed by 'Track 5,' only to have 'Track 1' play again next. This is not a malfunction.
SlideShows do not play.	<ul style="list-style-type: none"> • If you have selected a single file and select Slideshow from the Photo Options menu, then only that single file is played back. To play a slideshow you must select All Photos from the browse menu.
Images no longer displayed when you change the 24p Direct Out setting to On .	<ul style="list-style-type: none"> • Depending on your display, some of the settings may result in the picture disappearing. In this case, press OUTPUT RESOLUTION repeatedly until the picture re-appears (see <i>Changing the output video resolution</i> on page 14).
CDs cannot be copied on other external components.	<ul style="list-style-type: none"> • The audio signals of a CD output at the jacks of this player are protected from copying and cannot be copied on other external components. • To copy the audio signals recorded on a CD, connect your external components to the AUDIO OUT (2ch) jacks of this player.

HDMI troubleshooting

Problem	Remedy
No HDMI video output. (A connected HDMI component doesn't work with this player.)	<ul style="list-style-type: none"> • This unit has been designed to be compliant with HDMI (High-Definition Multimedia Interface). Depending on the component you have connected, unreliable signal transfers may result. • If you connect a DVI device to the HDMI output of this player, ensure that it is compliant with High-bandwidth Digital Content Protection (HDCP). • If the front panel HDMI indicator is unlit then: <ul style="list-style-type: none"> – Make sure that you've selected this player as the HDMI input in the settings for the component you're using. You may need to refer to the instruction manual of the component to do this. – Check that the HDMI cable is connected properly and that the cable isn't damaged. • If the front panel HDMI indicator is lit: <ul style="list-style-type: none"> – Depending on your display, some of the settings may result in the picture disappearing. In this case, press OUTPUT RESOLUTION repeatedly until the picture re-appears (see <i>Changing the output video resolution</i> on page 14). • Depending on the HDMI cable being used, 1080p output may not appear correctly.
Colors are too rich or too weak, or black is too deep or appears to 'float'.	<ul style="list-style-type: none"> • Use a different HDMI Color Space setting (page 41).
No HDMI audio output.	<ul style="list-style-type: none"> • If you have connected to an HDCP-compatible DVI component, there won't be any audio output from the HDMI terminal. Connect using the optical/coaxial digital outputs (or the analog outputs). • Verify that the connected HDMI device is compatible with Dolby TrueHD or Dolby Digital Plus (i.e. if bitstream output is allowed). If the HDMI device is not compatible, the audio will be converted into Dolby Digital or Linear PCM.

Problem	Remedy
HDMI Control does not function.	<ul style="list-style-type: none"> • Verify that the HDMI cable is firmly connected. • Make sure that this unit's HDMI Control is set to On (page 43). • Make sure that the HDMI Control for the connected components is set to On. For more information, refer to the operating manual for the connected component. • This function may not work properly if you have multiple components connected to a single plasma display or AV system (amplifier or AV receiver etc.). For more information refer to the operating manual of your plasma display or AV system. • You can enable HDMI Control by turning the HDMI Control setting to On for all components connected via HDMI cable. Check the video output from this unit once you have completed making connections and settings for all components. You will need to check the video output each time you change connected components or remove the HDMI cable. • Check whether the connected component supports HDMI Control or not. For more information refer to the operating manual of your plasma display or AV system (amplifier or AV receiver etc.). • Certain functions are not supported on some plasma displays. • This player does not support HDMI Control-compatible components other than those made by Pioneer. • This unit will not function properly with components that do not support HDMI Control, or when connected with components other than those made by Pioneer. • The HDMI Control functions may not operate properly if you do not use an HDMI cable that supports the HDMI 1.3 specification (Category 2) or later.

Network troubleshooting

Problem	Remedy
Home Media Gallery is not available.	<ul style="list-style-type: none"> • LAN indicator is unlit: <ul style="list-style-type: none"> – Check the physical connections (hub, 100BASE-TX, or other cable quality). • LAN indicator is lit: <ul style="list-style-type: none"> – If this player's IP address is set automatically, make sure that the media server's address is also set automatically. If the IP address of the media server has been set manually, set the IP address of the player manually too (see Network on page 43). – Check the logical connections (IP address setup, DHCP, etc.). Confirm that the IP address is correct if acquired using DHCP or Auto-IP in the Network Config. screen that follows the Initial Setup menu (see page 43). – Confirm that the media server is on and not in standby or sleep mode. – Check the network and other settings on the media server. – Check that this player and the media server are on the same Local Area Network (LAN). – Check if the media server (Windows Media Player 11, Windows Media Connect or DLNA-compliant) is running. Restart if necessary. – Check if the media server is setup correctly for file sharing, if the target folder has been deleted or if one or more folders has become corrupted on the server. – Check if the PC is operating properly. Reboot the PC after confirming its specifications and setup.
A connected media server does not show up in the source list in the Home Media Gallery.	<ul style="list-style-type: none"> • Confirm that the media server is on and not in standby or sleep mode. • Check the network and other settings on the media server. • Check that this player and the media server are on the same Local Area Network (LAN). • Check if the media server (Windows Media Player 11, Windows Media Connect or DLNA-compliant) is running. Restart if necessary. • Check if the media server is setup correctly for file sharing, if the target folder has been deleted or if one or more folders has become corrupted on the server. • Check if the PC is operating properly. Reboot the PC after confirming its specifications and setup. • Check that there are playable files on the media server. • After adding a new media server, exit the Home Media Gallery then, after a few moments, re-enter it.
A media server shows up in the source list but is not available (a lock icon (🔒) appears).	<ul style="list-style-type: none"> • Check the media server setup. If a client is registered (authorized) manually, the setup procedure may have to be run again. • Check that there are playable files on the media server. • After adding a new media server, exit the Home Media Gallery then, after a few moments, re-enter it.
Content different from last time appears on the network (missing items, etc.).	<ul style="list-style-type: none"> • If the player cannot connect to the same server as last time (because it is switched off, for example), the player will connect to another server on the network. To see content on a particular server, make sure it is running and then select it as the source in the Home Media Gallery (see <i>Movie sources</i> on page 34).

Problem	Remedy
Cannot play or display.	<ul style="list-style-type: none"> • Check the physical connections (hub, 100BASE-TX, or other cable quality). • Check if the file complies to the supported format, bit rate or profile (see <i>File compatibility</i> on page 9). Also check if the file is damaged. • If the message 'Cannot play this format' is displayed when you try to play PC files, check the file formats. • It takes time to capture and display a large-sized image; during this time you may have to wait to operate the player. • This player cannot play DRM-protected content stored on a DLNA server (not a Windows Media Player 11 or Windows Media Connect server). • Some files that comply with one of the supported formats may not play or be displayed. • Check if there are too many files on the server. • Check if the PC is operating properly. Reboot the PC after confirming its specification and setup.
Image or sound is interrupted or distorted (block noise appears).	<ul style="list-style-type: none"> • Check the physical connections (hub, 100BASE-TX, or other cable quality). It is strongly recommended to use 100BASE-TX for playback quality and display speed. • When connected by a wireless LAN, check if the bit rate is sufficient. • Check that the file complies with the supported format, bit rate or profile (see <i>File compatibility</i> on page 9). Also check if the file is damaged. • Some files that comply with one of the supported formats may not play or be displayed. • Check if the PC is operating properly. Reboot the PC after confirming its specification and setup.
Genre (movie), Playlist (music), Album (photo) or folder configuration differs from one server to another.	<ul style="list-style-type: none"> • The configuration may change depending on server type. This is not a malfunction.
An available server is selected but cannot be navigated.	<ul style="list-style-type: none"> • Check if the server is correctly set up for file sharing, if the target folder has been deleted, or if one or more folders have been corrupted on the server. • Check if there are too many files on the server.
'Cannot connect to server.' is displayed when network downloading is attempt.	<ul style="list-style-type: none"> • The message is displayed when connection to the server failed. Verify that the network cable is connected properly before retrying.
"WRT FAILED" is displayed on the front panel display during network downloading.	<ul style="list-style-type: none"> • The message is displayed when downloading failed. As the player may be failed, contact your local Pioneer Customer Service Center.

Miscellaneous troubleshooting

Problem	Remedy
It is taking a long time for the unit to start up.	<ul style="list-style-type: none"> • It can take up to one minute for the system to start up once you press the STANDBY/ON button. This does not mean that the player is experiencing problems.
The power automatically turns off.	<ul style="list-style-type: none"> • The Auto Power Off function switches the player into standby if no operation is performed for 30 minutes while the player is stopped or paused (page 43). • This unit's power may be turned off when you control this unit from a connected TV. If you do not want this unit to be turned off in this way, set this unit's HDMI Control (page 43) to Off.
Your TV and AV system automatically change inputs.	<ul style="list-style-type: none"> • The connected TV and AV system automatically may change inputs in response to this unit starting playback or having the GUI screen (ex. Disc Navigator) displayed. If you do not want your TV and AV system to change inputs in this way, set this unit HDMI Control (page 43) to Off.
The remote control doesn't seem to work.	<ul style="list-style-type: none"> • The CONTROL IN jack on the rear panel is connected: Point the remote control at the connected component to control this player. • The remote control is too far from the player, or the angle with the remote sensor is too wide: Use the remote within its operating range (see <i>Using the remote control</i> on page 8). • The batteries are exhausted: Put in new ones (see <i>Putting the batteries in the remote control</i> on page 8). • If you are using an external IR receiver, you may need to set the IR RECEIVER switch (see <i>Using an external IR receiver with this player</i> on page 17).
Settings are canceled.	<ul style="list-style-type: none"> • When the power is cut due to power failure or by unplugging the power cord during operation, settings will be canceled. See <i>Moving the player</i> on page 47 for proper shutdown instructions.
After inserting a disc, a 'Loading' message is displayed but playback does not begin.	<ul style="list-style-type: none"> • When you have inserted a disc containing PC files, the time necessary to load the files contained on the disc varies by how many files are present. The process can take anywhere from a few minutes to upwards of ten minutes.
On hybrid discs with BD and DVD layers, the DVD layer cannot be played back.	<ul style="list-style-type: none"> • Change the Set hybrid disc playback layer to DVD (page 43).

Problem	Remedy
On hybrid discs with BD and CD layers, the CD layer cannot be played back.	<ul style="list-style-type: none"> Change the Set hybrid disc playback layer to CD (page 43).
When the Set hybrid disc playback layer is set to DVD and you insert a hybrid disc with BD and CD layers, the BD layer is played back.	<ul style="list-style-type: none"> When the layer set to playback at <i>Set hybrid disc playback layer</i> is not present on an inserted hybrid disc, the BD layer is played back.
The Set hybrid disc playback layer setting cannot be changed (it is grayed out).	<ul style="list-style-type: none"> You cannot change the Set hybrid disc playback layer when a disc is inserted. Eject the disc to make changes.
A '■' appears in the file name.	<ul style="list-style-type: none"> A character that cannot be displayed on this unit is included in the file name. Use only alphanumeric characters if you want file names to be displayed correctly on this player.
The power automatically turns on.	<ul style="list-style-type: none"> This unit's power may be turned on when you control this unit from a connected plasma display. If you do not want this unit to be turned on in this way, set this unit's HDMI Control to Off (page 43).

Glossary

Analog audio

An electrical signal that directly represents sound. Compare this to digital audio which can also be an electrical signal, but is an indirect representation of sound. See also *Digital audio*.

Aspect ratio

The width of a TV screen relative to its height. Conventional TVs are 4:3 (in other words, the screen is almost square); widescreen models are 16:9 (the screen is almost twice as wide as it is high).

BD-J

BD-J is the Java specification for BD-ROM, allowing content providers to put interactive material linked to specific titles on the disc.

BDAV

BDAV is one of the application formats used by writable Blu-ray Discs (BD-R or BD-RE). It corresponds to the VR mode of the DVD standard.

BDMV

BDMV is one of the Blu-ray Disc standards (application standard for BD-ROM). It corresponds to the Video mode of the DVD standard.

Default Gateway

Default Gateway is a node on a computer network that serves as an access point to another network. A default gateway (such as a computer and router) is used to forward all traffic that is not addressed to a station within the local subnet.

DHCP (Dynamic Host Configuration Protocol) Server

A DHCP server is a server that allocates IP addresses to hosts (network devices). In most cases, a broadband router serves as a DHCP server in a home network.

Digital audio

An indirect representation of sound by numbers. During recording, the sound is measured at discrete intervals by an analog-to-digital converter, generating a stream of numbers. On playback, a digital-to-analog converter generates an analog signal based on these numbers. See also *Sampling frequency* and *Analog audio*.

Dolby Digital Plus

Dolby Digital Plus is the next-generation audio technology for all high-definition programming and media. It combines the efficiency to meet future broadcast demands with the power and flexibility to realize the full audio potential expected in the upcoming high-definition era. Built on Dolby Digital, the multi-channel audio standard for BD and DVD, Dolby Digital Plus has been designed for the next-generation AV Systems (amplifier or AV receiver) but remains fully compatible with all current AV Systems.

Dolby Digital Plus delivers multi-channel audio programs of up to 7.1 channels and supports multiple programs in a single encoded bitstream with the maximum bit rate potential of 6 Mbps and the maximum bit rate performance of 1.7 Mbps on BD, and it outputs Dolby Digital bitstreams for playback on existing Dolby Digital systems. Dolby Digital Plus can accurately reproduce the sound originally intended by directors and producers.

It also features multi-channel sound with discrete channel output, interactive mixing and streaming capability in advanced systems.

Supported by HDMI (High-Definition Multimedia Interface), a single-cable digital connection is possible for high-definition audio and video.

Dolby TrueHD

Dolby TrueHD is the next-generation lossless encoding technology developed for high-definition optical discs in the upcoming era.

Dolby TrueHD delivers tantalizing sound that is bit-for-bit identical to the studio master, unlocking the true high-definition entertainment experience on high-definition optical discs in the next generation.

When coupled with high-definition video, Dolby TrueHD offers an unprecedented home theater experience with stunning sound and high-definition picture.

It supports bit rates of up to 18 Mbps and records up to 8 full-range channels individually with 24-bit/96 kHz audio. It also features extensive metadata including dialogue normalization and dynamic range control. Supported by HDMI (High-Definition Multimedia Interface), a single-cable digital connection is possible for high-definition audio and video. BD standards currently limit their maximum number of audio channels to eight, whereas Dolby Digital Plus and Dolby TrueHD support more than eight audio channels.

DRM (Digital Rights Management)

DRM is one of several technologies that controls access to and use of digital data, such as music, movies and other copyrighted contents.

DTS-HD High Resolution Audio

DTS-HD High Resolution Audio provides sound quality which far outpaces that of the current DVD discs with constant data rates from 1.5 Mbps to 6.0 Mbps for Blu-ray Disc. DTS-HD High Resolution Audio is capable of up to 7.1 channels of audio at a sampling frequency of 96 kHz/24 bits so the original sound is finely and faithfully reproduced with less disc space compared to DTS-HD Master Audio. The result of using DTS-HD High Resolution Audio use is especially significant when watching high definition video as the sound that is clearer than ever creates the whole new movie experience right at home.

Dynamic range

The difference between the quietest and loudest sounds possible in an audio signal (without distorting or getting lost in noise). Dolby Digital and DTS soundtracks are capable of a very wide dynamic range, delivering dramatic cinema-like effects.

Ethernet

A frame-based computer networking technology for local area networks (LANs). This player supports 100BASE-TX.

File extension

A tag added to the end of a filename to indicate the type of file. For example, ".jpg" indicates an JPEG image file.

HDMI

HDMI (High-Definition Multimedia Interface) is a high-speed digital interface which has the capability to support standard or high-definition video plus standard to multi-channel surround-sound audio on a single digital connection.

Interactive audio

Interactive audio is Linear PCM (LPCM) audio activated by a BD-ROM application and mixed with the primary audio. It is typically used to provide dynamic sounds associated with interactive applications, such as button sounds.

Interlaced video

A method of displaying a picture in which odd-numbered lines are updated in one pass, then even-numbered lines updated in the next. See also *Progressive scan video*.

IP (Internet Protocol) address

A unique number that devices use in order to identify and communicate with each other on a network utilizing the Internet Protocol standard, such as '192.168.0.1'. No duplicate numbers are allowed in the network.

LAN cable

A cable that has an 8-pin modular plug on each end and is different from a telephone plug which has 4-pins.

MAC (Media Access Control) address

An address attached to the port of any device. The MAC address cannot be changed.

PCM (Pulse Code Modulation)

A common system of encoding digital audio. Excellent quality, but requires a lot of data compared to formats such as Dolby Digital and MPEG audio. For compatibility with digital audio recorders and AV amplifiers with digital inputs, this unit can convert Dolby Digital, DTS and MPEG audio to PCM. See also *Digital audio*.

Pop-up menu (BD only)

A context-sensitive menu that can be used without interrupting playback of a BD.

Progressive scan video

Also called non-interlaced video, this method of displaying a picture updates all the lines in one pass, resulting in a more stable, flicker-free image than interlaced video (for a given scanning rate). See also *Interlaced video*.

Regions (DVD-Video and BD-ROM)

These associate discs and players with particular areas of the world. This unit will only play discs that have a compatible region code (i.e., the same code as your player). You can find the region code of your unit by looking on the rear panel. Some discs are compatible with more than one region (or all regions).

Note that the region systems for DVD and BD are not the same.

Sampling frequency

The rate at which sound is measured to be turned into digital audio data. The higher the rate, the better the sound quality, but the more digital information is generated. For example, a sampling frequency of 44.1 kHz means 44 100 samples (measurements) per second. See also *Digital audio*.

Subnet mask

The IP address is divided into the network address part and the host address part. The subnet mask is expressed as '255.255.255.0'. In most cases, the subnet mask is automatically assigned by the DHCP server.

[MPEG4IP]

This software is based in part on Mozilla Public License 1.1 see <http://www.mozilla.org/MPL/> for information.

[OpenSSL]**OpenSSL License**

Copyright © 1998-2004 The OpenSSL Project. All rights reserved.

Redistribution and use in source and binary forms, with or without modification, are permitted provided that the following conditions are met:

1. Redistributions of source code must retain the above copyright notice, this list of conditions and the following disclaimer.
2. Redistributions in binary form must reproduce the above copyright notice, this list of conditions and the following disclaimer in the documentation and/or other materials provided with the distribution.
3. All advertising materials mentioning features or use of this software must display the following acknowledgment: "This product includes software developed by the OpenSSL Project for use in the OpenSSL Toolkit. (<http://www.openssl.org/>)".
4. The names "OpenSSL Toolkit" and "OpenSSL Project" must not be used to endorse or promote products derived from this software without prior written permission. For written permission, please contact openssl-core@openssl.org.
5. Products derived from this software may not be called "OpenSSL" nor may "OpenSSL" appear in their names without prior written permission of the OpenSSL Project.
6. Redistributions of any form whatsoever must retain the following acknowledgment: "This product includes software developed by the OpenSSL Project for use in the OpenSSL Toolkit (<http://www.openssl.org/>)".

THIS SOFTWARE IS PROVIDED BY THE OpenSSL PROJECT "AS IS" AND ANY EXPRESSED OR IMPLIED WARRANTIES, INCLUDING, BUT NOT LIMITED TO, THE IMPLIED WARRANTIES OF MERCHANTABILITY AND FITNESS FOR A PARTICULAR PURPOSE ARE DISCLAIMED. IN NO EVENT SHALL THE OpenSSL PROJECT OR ITS CONTRIBUTORS BE LIABLE FOR ANY DIRECT, INDIRECT, INCIDENTAL, SPECIAL, EXEMPLARY, OR CONSEQUENTIAL DAMAGES (INCLUDING, BUT NOT LIMITED TO, PROCUREMENT OF SUBSTITUTE GOODS OR SERVICES; LOSS OF USE, DATA, OR PROFITS; OR BUSINESS INTERRUPTION) HOWEVER CAUSED AND ON ANY THEORY OF LIABILITY, WHETHER IN CONTRACT, STRICT LIABILITY, OR TORT (INCLUDING NEGLIGENCE OR OTHERWISE) ARISING IN ANY WAY OUT OF THE USE OF THIS SOFTWARE, EVEN IF ADVISED OF THE POSSIBILITY OF SUCH DAMAGE.

This product includes cryptographic software written by Eric Young (ey@cryptsoft.com). This product includes software written by Tim Hudson (tjh@cryptsoft.com).

Original SLeay License

Copyright © 1995-1998 Eric Young (ey@cryptsoft.com)

All rights reserved.

This package is an SSL implementation written by Eric Young (ey@cryptsoft.com). The implementation was written so as to conform with Netscapes SSL.

This library is free for commercial and non-commercial use as long as the following conditions are adhered to. The following conditions apply to all code found in this distribution, be it the RC4, RSA, lhash, DES, etc., code; not just the SSL code. The SSL documentation included with this distribution is covered by the same copyright terms except that the holder is Tim Hudson (tjh@cryptsoft.com).

Copyright remains Eric Young's, and as such any Copyright notices in the code are not to be removed. If this package is used in a product, Eric Young should be given attribution as the author of the parts of the library used. This can be in the form of a textual message at program startup or in documentation (online or textual) provided with the package.

Redistribution and use in source and binary forms, with or without modification, are permitted provided that the following conditions are met:

1. Redistributions of source code must retain the copyright notice, this list of conditions and the following disclaimer.
2. Redistributions in binary form must reproduce the above copyright notice, this list of conditions and the following disclaimer in the documentation and/or other materials provided with the distribution.
3. All advertising materials mentioning features or use of this software must display the following acknowledgement: "This product includes cryptographic software written by Eric Young (ey@cryptsoft.com)"
The word 'cryptographic' can be left out if the routines from the library being used are not cryptographic related:-).
4. If you include any Windows specific code (or a derivative thereof) from the apps directory (application code) you must include an acknowledgement: "This product includes software written by Tim Hudson (tjh@cryptsoft.com)"

THIS SOFTWARE IS PROVIDED BY ERIC YOUNG "AS IS" AND ANY EXPRESS OR IMPLIED WARRANTIES, INCLUDING, BUT NOT LIMITED TO, THE IMPLIED WARRANTIES OF MERCHANTABILITY AND FITNESS FOR A PARTICULAR PURPOSE ARE DISCLAIMED. IN NO EVENT SHALL THE AUTHOR OR CONTRIBUTORS BE LIABLE FOR ANY DIRECT, INDIRECT, INCIDENTAL, SPECIAL, EXEMPLARY, OR CONSEQUENTIAL DAMAGES (INCLUDING, BUT NOT LIMITED TO, PROCUREMENT OF SUBSTITUTE GOODS OR SERVICES; LOSS OF USE, DATA, OR PROFITS; OR BUSINESS INTERRUPTION) HOWEVER CAUSED AND ON ANY THEORY OF LIABILITY, WHETHER IN CONTRACT, STRICT LIABILITY, OR TORT (INCLUDING NEGLIGENCE OR OTHERWISE) ARISING IN ANY WAY OUT OF THE USE OF THIS SOFTWARE, EVEN IF ADVISED OF THE POSSIBILITY OF SUCH DAMAGE.

The licence and distribution terms for any publicly available version or derivative of this code cannot be changed. i.e. this code cannot simply be copied and put under another distribution licence [including the GNU Public Licence.]

[tiff]

Copyright © 1988-1997 Sam Leffler

Copyright © 1991-1997 Silicon Graphics, Inc.

THE SOFTWARE IS PROVIDED "AS-IS" AND WITHOUT WARRANTY OF ANY KIND, EXPRESS, IMPLIED OR OTHERWISE, INCLUDING WITHOUT LIMITATION, ANY WARRANTY OF MERCHANTABILITY OR FITNESS FOR A PARTICULAR PURPOSE. IN NO EVENT SHALL SAM LEFFLER OR SILICON GRAPHICS BE LIABLE FOR ANY SPECIAL, INCIDENTAL, INDIRECT OR CONSEQUENTIAL DAMAGES OF ANY KIND, OR ANY DAMAGES WHATSOEVER RESULTING FROM LOSS OF USE, DATA OR PROFITS, WHETHER OR NOT ADVISED OF THE POSSIBILITY OF DAMAGE, AND ON ANY THEORY OF LIABILITY, ARISING OUT OF OR IN CONNECTION WITH THE USE OR PERFORMANCE OF THIS SOFTWARE.

[Howl]

Copyright © 2003, 2004 Porchdog Software All rights reserved.

THIS SOFTWARE IS PROVIDED BY THE COPYRIGHT HOLDERS AND CONTRIBUTORS "AS IS" AND ANY EXPRESS OR IMPLIED WARRANTIES, INCLUDING, BUT NOT LIMITED TO, THE IMPLIED WARRANTIES OF MERCHANTABILITY AND FITNESS FOR A PARTICULAR PURPOSE ARE DISCLAIMED. IN NO EVENT SHALL THE COPYRIGHT OWNER OR CONTRIBUTORS BE LIABLE FOR ANY DIRECT, INDIRECT, INCIDENTAL, SPECIAL, EXEMPLARY, OR CONSEQUENTIAL DAMAGES (INCLUDING, BUT NOT LIMITED TO, PROCUREMENT OF SUBSTITUTE GOODS OR SERVICES; LOSS OF USE, DATA, OR PROFITS; OR BUSINESS INTERRUPTION) HOWEVER CAUSED AND ON ANY THEORY OF LIABILITY, WHETHER IN CONTRACT, STRICT LIABILITY, OR TORT (INCLUDING NEGLIGENCE OR OTHERWISE) ARISING IN ANY WAY OUT OF THE USE OF THIS SOFTWARE, EVEN IF ADVISED OF THE POSSIBILITY OF SUCH DAMAGE.

This software is based in part on Apple Public Source License or the recent's rights thereunder see <http://developer.apple.com/> for information.

[UPNPLib/Intel Stack]

This software is based in part on Intel License see <http://www.intel.com/> for information.

[JPEG image compression]

If only executable code is distributed, then the accompanying documentation must state that "this software is based in part on the work of the Independent JPEG Group".

[libpng]

COPYRIGHT NOTICE, DISCLAIMER, and LICENSE:

If you modify libpng you may insert additional notices immediately following this sentence. libpng version 1.2.6, December 3, 2004, is Copyright © 2004 Glenn Randers-Pehrson, and is distributed according to the same disclaimer and license as libpng-1.2.5 with the following individual added to the list of Contributing Authors

Cosmin Truta

libpng versions 1.0.7, July 1, 2000, through 1.2.5 - October 3, 2002, are Copyright © 2000-2002 Glenn Randers-Pehrson, and are distributed according to the same disclaimer and license as libpng-1.0.6 with the following individuals added to the list of Contributing Authors

Simon-Pierre Cadieux

Eric S. Raymond

Gilles Vollant

and with the following additions to the disclaimer:

There is no warranty against interference with your enjoyment of the library or against infringement. There is no warranty that our efforts or the library will fulfill any of your particular purposes or needs. This library is provided with all faults, and the entire risk of satisfactory quality, performance, accuracy, and effort is with the user.

libpng versions 0.97, January 1998, through 1.0.6, March 20, 2000, are Copyright © 1998, 1999 Glenn Randers-Pehrson, and are distributed according to the same disclaimer and license as libpng-0.96, with the following individuals added to the list of Contributing Authors:

Tom Lane

Glenn Randers-Pehrson

Willem van Schaik

libpng versions 0.89, June 1996, through 0.96, May 1997, are Copyright © 1996, 1997 Andreas Dilger Distributed according to the same disclaimer and license as libpng-0.88, with the following individuals added to the list of Contributing Authors:

John Bowler

Kevin Bracey

Sam Bushell

Magnus Holmgren

Greg Roelofs

Tom Tanner

libpng versions 0.5, May 1995, through 0.88, January 1996, are Copyright © 1995, 1996 Guy Eric Schalnat, Group 42, Inc.

For the purposes of this copyright and license, "Contributing Authors" is defined as the following set of individuals:

Andreas Dilger

Dave Martindale

Guy Eric Schalnat

Paul Schmidt

Tim Wegner

The PNG Reference Library is supplied "AS IS". The Contributing Authors and Group 42, Inc. disclaim all warranties, expressed or implied, including, without limitation, the warranties of merchantability and of fitness for any purpose. The Contributing Authors and Group 42, Inc. assume no liability for direct, indirect, incidental, special, exemplary, or consequential damages, which may result from the use of the PNG Reference Library, even if advised of the possibility of such damage.

Permission is hereby granted to use, copy, modify, and distribute this source code, or portions hereof, for any purpose, without fee, subject to the following restrictions:

1. The origin of this source code must not be misrepresented.
2. Altered versions must be plainly marked as such and must not be misrepresented as being the original source.
3. This Copyright notice may not be removed or altered from any source or altered source distribution.

The Contributing Authors and Group 42, Inc. specifically permit, without fee, and encourage the use of this source code as a component to supporting the PNG file format in commercial products. If you use this source code in a product, acknowledgment is not required but would be appreciated.

A "png_get_copyright" function is available, for convenient use in "about" boxes and the like: `printf("%s", png_get_copyright(NULL));` Also, the PNG logo (in PNG format, of course) is supplied in the files "pngbar.png" and "pngbar.jpg (88x31)" and "pngnow.png" (98x31).

Libpng is OSI Certified Open Source Software. OSI Certified Open Source is a certification mark of the Open Source Initiative.

Glenn Randers-Pehrson
glennrp at users.sourceforge.net
December 3, 2004

[zlib]

This software is based in part on zlib see <http://www.zlib.net> for information.

[FreeType]

The FreeType Project is Copyright © 1996-2000 by David Turner, Robert Wilhelm, and Werner Lemberg. All rights reserved except as specified below. THE FREETYPE PROJECT IS PROVIDED "AS IS" WITHOUT WARRANTY OF ANY KIND, EITHER EXPRESS OR IMPLIED, INCLUDING, BUT NOT LIMITED TO, WARRANTIES OF MERCHANTABILITY AND FITNESS FOR A PARTICULAR PURPOSE. IN NO EVENT WILL ANY OF THE AUTHORS OR COPYRIGHT HOLDERS BE LIABLE FOR ANY DAMAGES CAUSED BY THE USE OR THE INABILITY TO USE, OF THE FREETYPE PROJECT.

[GIFLIB]

The GIFLIB distribution is Copyright © 1997 Eric S. Raymond

THE SOFTWARE IS PROVIDED "AS IS", WITHOUT WARRANTY OF ANY KIND, EXPRESS OR IMPLIED, INCLUDING BUT NOT LIMITED TO THE WARRANTIES OF MERCHANTABILITY, FITNESS FOR A PARTICULAR PURPOSE AND NONINFRINGEMENT. IN NO EVENT SHALL THE AUTHORS OR COPYRIGHT HOLDERS BE LIABLE FOR ANY CLAIM, DAMAGES OR OTHER LIABILITY, WHETHER IN AN ACTION OF CONTRACT, TORT OR OTHERWISE, ARISING FROM, OUT OF OR IN CONNECTION WITH THE SOFTWARE OR THE USE OR OTHER DEALINGS IN THE SOFTWARE.

[libhttp]

Copyright © 2000-2004 Dag-Erling Smørgrav

All rights reserved.

Redistribution and use in source and binary forms, with or without modification, are permitted provided that the following conditions are met:

1. Redistributions of source code must retain the above copyright notice, this list of conditions and the following disclaimer in this position and unchanged.
2. Redistributions in binary form must reproduce the above copyright notice, this list of conditions and the following disclaimer in the documentation and/or other materials provided with the distribution.
3. The name of the author may not be used to endorse or promote products derived from this software without specific prior written permission.

THIS SOFTWARE IS PROVIDED BY THE AUTHOR "AS IS" AND ANY EXPRESS OR IMPLIED WARRANTIES, INCLUDING, BUT NOT LIMITED TO, THE IMPLIED WARRANTIES OF MERCHANTABILITY AND FITNESS FOR A PARTICULAR PURPOSE ARE DISCLAIMED. IN NO EVENT SHALL THE AUTHOR BE LIABLE FOR ANY DIRECT, INDIRECT, INCIDENTAL, SPECIAL, EXEMPLARY, OR CONSEQUENTIAL DAMAGES (INCLUDING, BUT NOT LIMITED TO, PROCUREMENT OF SUBSTITUTE GOODS OR SERVICES; LOSS OF USE, DATA, OR PROFITS; OR BUSINESS INTERRUPTION) HOWEVER CAUSED AND ON ANY THEORY OF LIABILITY, WHETHER IN CONTRACT, STRICT LIABILITY, OR TORT (INCLUDING NEGLIGENCE OR OTHERWISE) ARISING IN ANY WAY OUT OF THE USE OF THIS SOFTWARE, EVEN IF ADVISED OF THE POSSIBILITY OF SUCH DAMAGE.

The following copyright applies to the base64 code:

Copyright 1997 Massachusetts Institute of Technology

Permission to use, copy, modify, and distribute this software and its documentation for any purpose and without fee is hereby granted, provided that both the above copyright notice and this permission notice appear in all copies, that both the above copyright notice and this permission notice appear in all supporting documentation, and that the name of M.I.T. not be used in advertising or publicity pertaining to distribution of the software without specific, written prior permission. M.I.T. makes no representations about the suitability of this software for any purpose. It is provided "as is" without express or implied warranty.

THIS SOFTWARE IS PROVIDED BY M.I.T. "AS IS". M.I.T. DISCLAIMS ALL EXPRESS OR IMPLIED WARRANTIES WITH REGARD TO THIS SOFTWARE, INCLUDING, BUT NOT LIMITED TO, THE IMPLIED WARRANTIES OF MERCHANTABILITY AND FITNESS FOR A PARTICULAR PURPOSE. IN NO EVENT SHALL M.I.T. BE LIABLE FOR ANY DIRECT, INDIRECT, INCIDENTAL, SPECIAL, EXEMPLARY, OR CONSEQUENTIAL DAMAGES (INCLUDING, BUT NOT LIMITED TO, PROCUREMENT OF SUBSTITUTE GOODS OR SERVICES; LOSS OF USE, DATA, OR PROFITS; OR BUSINESS INTERRUPTION) HOWEVER CAUSED AND ON ANY THEORY OF LIABILITY, WHETHER IN CONTRACT, STRICT LIABILITY, OR TORT (INCLUDING NEGLIGENCE OR OTHERWISE) ARISING IN ANY WAY OUT OF THE USE OF THIS SOFTWARE, EVEN IF ADVISED OF THE POSSIBILITY OF SUCH DAMAGE.

[Vera.ttf/VeraMono.ttf]

Copyright © 2003 by Bitstream, Inc. All Rights Reserved. Bitstream Vera Sans Bitstream Vera Sans Roman Release 1.10 Copyright © 2003 by Bitstream, Inc. All Rights Reserved. Bitstream Vera is a trademark of Bitstream, Inc.

[TinyLogin]

This software is Copyright 1988 - 1994, Julianne Frances Haugh. All rights reserved.

[Shadow Utilities]

This software is Copyright 1988 - 1994, Julianne Frances Haugh. All rights reserved.
Bigelow & Holmes Inc and URW++ GmbH Luxi font license

[Luxi fonts]

Luxi fonts Copyright © 2001 by Bigelow & Holmes Inc. Luxi font instruction code Copyright © 2001 by URW++ GmbH. All Rights Reserved. Luxi is a registered trademark of Bigelow & Holmes Inc.

THE FONT SOFTWARE IS PROVIDED "AS IS", WITHOUT WARRANTY OF ANY KIND, EXPRESS OR IMPLIED, INCLUDING BUT NOT LIMITED TO ANY WARRANTIES OF MERCHANTABILITY, FITNESS FOR A PARTICULAR PURPOSE AND NONINFRINGEMENT OF COPYRIGHT, PATENT, TRADEMARK, OR OTHER RIGHT. IN NO EVENT SHALL BIGELOW & HOLMES INC. OR URW++ GMBH. BE LIABLE FOR ANY CLAIM, DAMAGES OR OTHER LIABILITY, INCLUDING ANY GENERAL, SPECIAL, INDIRECT, INCIDENTAL, OR CONSEQUENTIAL DAMAGES, WHETHER IN AN ACTION OF CONTRACT, TORT OR OTHERWISE, ARISING FROM, OUT OF THE USE OR INABILITY TO USE THE FONT SOFTWARE OR FROM OTHER DEALINGS IN THE FONT SOFTWARE.

[GNU GENERAL PUBLIC LICENSE]

Version 2, June 1991

Copyright © 1989, 1991 Free Software Foundation, Inc., 51 Franklin Street, Fifth Floor, Boston, MA 02110-1301 USA

Everyone is permitted to copy and distribute verbatim copies of this license document, but changing it is not allowed.

Preamble

The licenses for most software are designed to take away your freedom to share and change it. By contrast, the GNU General Public License is intended to guarantee your freedom to share and change free software – to make sure the software is free for all its users. This General Public License applies to most of the Free Software Foundation's software and to any other program whose authors commit to using it. (Some other Free Software Foundation software is covered by the GNU Lesser General Public License instead.) You can apply it to your programs, too.

When we speak of free software, we are referring to freedom, not price. Our General Public Licenses are designed to make sure that you have the freedom to distribute copies of free software (and charge for this service if you wish), that you receive source code or can get it if you want it, that you can change the software or use pieces of it in new free programs; and that you know you can do these things.

To protect your rights, we need to make restrictions that forbid anyone to deny you these rights or to ask you to surrender the rights. These restrictions translate to certain responsibilities for you if you distribute copies of the software, or if you modify it.

For example, if you distribute copies of such a program, whether gratis or for a fee, you must give the recipients all the rights that you have. You must make sure that they, too, receive or can get the source code. And you must show them these terms so they know their rights.

We protect your rights with two steps: (1) copyright the software, and (2) offer you this license which gives you legal permission to copy, distribute and/or modify the software.

Also, for each author's protection and ours, we want to make certain that everyone understands that there is no warranty for this free software. If the software is modified by someone else and passed on, we want its recipients to know that what they have is not the original, so that any problems introduced by others will not reflect on the original authors' reputations.

Finally, any free program is threatened constantly by software patents. We wish to avoid the danger that redistributors of a free program will individually obtain patent licenses, in effect making the program proprietary. To prevent this, we have made it clear that any patent must be licensed for everyone's free use or not licensed at all.

The precise terms and conditions for copying, distribution and modification follow.

GNU GENERAL PUBLIC LICENSE

TERMS AND CONDITIONS FOR COPYING, DISTRIBUTION AND MODIFICATION

0. This License applies to any program or other work which contains a notice placed by the copyright holder saying it may be distributed under the terms of this General Public License. The "Program", below, refers to any such program or work, and a "work based on the Program" means either the Program or any derivative work under copyright law: that is to say, a work containing the Program or a portion of it, either verbatim or with modifications and/or translated into another language. (Hereinafter, translation is included without limitation in the term "modification".) Each licensee is addressed as "you". Activities other than copying, distribution and modification are not covered by this License; they are outside its scope. The act of running the Program is not restricted, and the output from the Program is covered only if its contents constitute a work based on the Program (independent of having been made by running the Program). Whether that is true depends on what the Program does.
1. You may copy and distribute verbatim copies of the Program's source code as you receive it, in any medium, provided that you conspicuously and appropriately publish on each copy an appropriate copyright notice and disclaimer of warranty; keep intact all the notices that refer to this License and to the absence of any warranty; and give any other recipients of the Program a copy of this License along with the Program.
You may charge a fee for the physical act of transferring a copy, and you may at your option offer warranty protection in exchange for a fee.
2. You may modify your copy or copies of the Program or any portion of it, thus forming a work based on the Program, and copy and distribute such modifications or work under the terms of Section 1 above, provided that you also meet all of these conditions:
 - a) You must cause the modified files to carry prominent notices stating that you changed the files and the date of any change.

- b) You must cause any work that you distribute or publish, that in whole or in part contains or is derived from the Program or any part thereof, to be licensed as a whole at no charge to all third parties under the terms of this License.
- c) If the modified program normally reads commands interactively when run, you must cause it, when started running for such interactive use in the most ordinary way, to print or display an announcement including an appropriate copyright notice and a notice that there is no warranty (or else, saying that you provide a warranty) and that users may redistribute the program under these conditions, and telling the user how to view a copy of this License. (Exception: if the Program itself is interactive but does not normally print such an announcement, your work based on the Program is not required to print an announcement.)

These requirements apply to the modified work as a whole. If identifiable sections of that work are not derived from the Program, and can be reasonably considered independent and separate works in themselves, then this License, and its terms, do not apply to those sections when you distribute them as separate works. But when you distribute the same sections as part of a whole which is a work based on the Program, the distribution of the whole must be on the terms of this License, whose permissions for other licensees extend to the entire whole, and thus to each and every part regardless of who wrote it.

Thus, it is not the intent of this section to claim rights or contest your rights to work written entirely by you; rather, the intent is to exercise the right to control the distribution of derivative or collective works based on the Program.

In addition, mere aggregation of another work not based on the Program with the Program (or with a work based on the Program) on a volume of a storage or distribution medium does not bring the other work under the scope of this License.

- 3. You may copy and distribute the Program (or a work based on it, under Section 2) in object code or executable form under the terms of Sections 1 and 2 above provided that you also do one of the following:
 - a) Accompany it with the complete corresponding machine-readable source code, which must be distributed under the terms of Sections 1 and 2 above on a medium customarily used for software interchange; or,
 - b) Accompany it with a written offer, valid for at least three years, to give any third party, for a charge no more than your cost of physically performing source distribution, a complete machine-readable copy of the corresponding source code, to be distributed under the terms of Sections 1 and 2 above on a medium customarily used for software interchange; or,
 - c) Accompany it with the information you received as to the offer to distribute corresponding source code. (This alternative is allowed only for noncommercial distribution and only if you received the program in object code or executable form with such an offer, in accord with Subsection b above.)

The source code for a work means the preferred form of the work for making modifications to it. For an executable work, complete source code means all the source code for all modules it contains, plus any associated interface definition files, plus the scripts used to control compilation and installation of the executable. However, as a special exception, the source code distributed need not include anything that is normally distributed (in either source or binary form) with the major components (compiler, kernel, and so on) of the operating system on which the executable runs, unless that component itself accompanies the executable.

If distribution of executable or object code is made by offering access to copy from a designated place, then offering equivalent access to copy the source code from the same place counts as distribution of the source code, even though third parties are not compelled to copy the source along with the object code.

- 4. You may not copy, modify, sublicense, or distribute the Program except as expressly provided under this License. Any attempt otherwise to copy, modify, sublicense or distribute the Program is void, and will automatically terminate your rights under this License. However, parties who have received copies, or rights, from you under this License will not have their licenses terminated so long as such parties remain in full compliance.
- 5. You are not required to accept this License, since you have not signed it. However, nothing else grants you permission to modify or distribute the Program or its derivative works. These actions are prohibited by law if you do not accept this License. Therefore, by modifying or distributing the Program (or any work based on the Program), you indicate your acceptance of this License to do so, and all its terms and conditions for copying, distributing or modifying the Program or works based on it.
- 6. Each time you redistribute the Program (or any work based on the Program), the recipient automatically receives a license from the original licensor to copy, distribute or modify the Program subject to these terms and conditions. You may not impose any further restrictions on the recipients' exercise of the rights granted herein.

You are not responsible for enforcing compliance by third parties to this License.

- 7. If, as a consequence of a court judgment or allegation of patent infringement or for any other reason (not limited to patent issues), conditions are imposed on you (whether by court order, agreement or otherwise) that contradict the conditions of this License, they do not excuse you from the conditions of this License. If you cannot distribute so as to satisfy simultaneously your obligations under this License and any other pertinent obligations, then as a consequence you may not distribute the Program at all. For example, if a patent license would not permit royalty-free redistribution of the Program by all those who receive copies directly or indirectly through you, then the only way you could satisfy both it and this License would be to refrain entirely from distribution of the Program.

If any portion of this section is held invalid or unenforceable under any particular circumstance, the balance of the section is intended to apply and the section as a whole is intended to apply in other circumstances.

It is not the purpose of this section to induce you to infringe any patents or other property right claims or to contest validity of any such claims; this section has the sole purpose of protecting the integrity of the free software distribution system, which is implemented by public license practices. Many people have made generous contributions to the wide range of software distributed through that system in reliance on consistent application of that system; it is up to the author/donor to decide if he or she is willing to distribute software through any other system and a licensee cannot impose that choice.

This section is intended to make thoroughly clear what is believed to be a consequence of the rest of this License.

- 8. If the distribution and/or use of the Program is restricted in certain countries either by patents or by copyrighted interfaces, the original copyright holder who places the Program under this License may add an explicit geographical distribution limitation excluding those countries, so that distribution is permitted only in or among countries not thus excluded. In such case, this License incorporates the limitation as if written in the body of this License.

9. The Free Software Foundation may publish revised and/or new versions of the General Public License from time to time. Such new versions will be similar in spirit to the present version, but may differ in detail to address new problems or concerns.
- Each version is given a distinguishing version number. If the Program specifies a version number of this License which applies to it and "any later version", you have the option of following the terms and conditions either of that version or of any later version published by the Free Software Foundation. If the Program does not specify a version number of this License, you may choose any version ever published by the Free Software Foundation.
10. If you wish to incorporate parts of the Program into other free programs whose distribution conditions are different, write to the author to ask for permission. For software which is copyrighted by the Free Software Foundation, write to the Free Software Foundation; we sometimes make exceptions for this. Our decision will be guided by the two goals of preserving the free status of all derivatives of our free software and of promoting the sharing and reuse of software generally.

NO WARRANTY

11. BECAUSE THE PROGRAM IS LICENSED FREE OF CHARGE, THERE IS NO WARRANTY FOR THE PROGRAM, TO THE EXTENT PERMITTED BY APPLICABLE LAW. EXCEPT WHEN OTHERWISE STATED IN WRITING THE COPYRIGHT HOLDERS AND/OR OTHER PARTIES PROVIDE THE PROGRAM "AS IS" WITHOUT WARRANTY OF ANY KIND, EITHER EXPRESSED OR IMPLIED, INCLUDING, BUT NOT LIMITED TO, THE IMPLIED WARRANTIES OF MERCHANTABILITY AND FITNESS FOR A PARTICULAR PURPOSE. THE ENTIRE RISK AS TO THE QUALITY AND PERFORMANCE OF THE PROGRAM IS WITH YOU. SHOULD THE PROGRAM PROVE DEFECTIVE, YOU ASSUME THE COST OF ALL NECESSARY SERVICING, REPAIR OR CORRECTION.
12. IN NO EVENT UNLESS REQUIRED BY APPLICABLE LAW OR AGREED TO IN WRITING WILL ANY COPYRIGHT HOLDER, OR ANY OTHER PARTY WHO MAY MODIFY AND/OR REDISTRIBUTE THE PROGRAM AS PERMITTED ABOVE, BE LIABLE TO YOU FOR DAMAGES, INCLUDING ANY GENERAL, SPECIAL, INCIDENTAL OR CONSEQUENTIAL DAMAGES ARISING OUT OF THE USE OR INABILITY TO USE THE PROGRAM (INCLUDING BUT NOT LIMITED TO LOSS OF DATA OR DATA BEING RENDERED INACCURATE OR LOSSES SUSTAINED BY YOU OR THIRD PARTIES OR A FAILURE OF THE PROGRAM TO OPERATE WITH ANY OTHER PROGRAMS), EVEN IF SUCH HOLDER OR OTHER PARTY HAS BEEN ADVISED OF THE POSSIBILITY OF SUCH DAMAGES.
- END OF TERMS AND CONDITIONS

How to Apply These Terms to Your New Programs

If you develop a new program, and you want it to be of the greatest possible use to the public, the best way to achieve this is to make it free software which everyone can redistribute and change under these terms.

To do so, attach the following notices to the program. It is safest to attach them to the start of each source file to most effectively convey the exclusion of warranty; and each file should have at least the "copyright" line and a pointer to where the full notice is found.

<one line to give the program's name and a brief idea of what it does.>

Copyright © <year> <name of author>

This program is free software; you can redistribute it and/or modify it under the terms of the GNU General Public License as published by the Free Software Foundation; either version 2 of the License, or (at your option) any later version.

This program is distributed in the hope that it will be useful, but WITHOUT ANY WARRANTY; without even the implied warranty of MERCHANTABILITY or FITNESS FOR A PARTICULAR PURPOSE. See the GNU General Public License for more details.

You should have received a copy of the GNU General Public License along with this program; if not, write to the Free Software Foundation, Inc., 51 Franklin Street, Fifth Floor, Boston, MA 02110-1301 USA.

Also add information on how to contact you by electronic and paper mail.

If the program is interactive, make it output a short notice like this when it starts in an interactive mode:

Gnomovision version 69, Copyright © year name of author

Gnomovision comes with ABSOLUTELY NO WARRANTY; for details type 'show w'. This is free software, and you are welcome to redistribute it under certain conditions; type 'show c' for details.

The hypothetical commands 'show w' and 'show c' should show the appropriate parts of the General Public License. Of course, the commands you use may be called something other than 'show w' and 'show c'; they could even be mouse-clicks or menu items – whatever suits your program.

You should also get your employer (if you work as a programmer) or your school, if any, to sign a "copyright disclaimer" for the program, if necessary. Here is a sample; alter the names:

Yoyodyne, Inc., hereby disclaims all copyright interest in the program 'Gnomovision' (which makes passes at compilers) written by James Hacker.

<signature of Ty Coon>, 1 April 1989

Ty Coon, President of Vice

This General Public License does not permit incorporating your program into proprietary programs. If your program is a subroutine library, you may consider it more useful to permit linking proprietary applications with the library. If this is what you want to do, use the GNU Lesser General Public License instead of this License.

[GNU LESSER GENERAL PUBLIC LICENSE]

Version 2.1, February 1999

Copyright © 1991, 1999 Free Software Foundation, Inc.

51 Franklin Street, Fifth Floor, Boston, MA 02110-1301 USA

Everyone is permitted to copy and distribute verbatim copies of this license document, but changing it is not allowed.

[This is the first released version of the Lesser GPL. It also counts as the successor of the GNU Library Public License, version 2, hence the version number 2.1.]

Preamble

The licenses for most software are designed to take away your freedom to share and change it. By contrast, the GNU General Public Licenses are intended to guarantee your freedom to share and change free software – to make sure the software is free for all its users. This license, the Lesser General Public License, applies to some specially designated software packages – typically libraries – of the Free Software Foundation and other authors who decide to use it. You can use it too, but we suggest you first think carefully about whether this license or the ordinary General Public License is the better strategy to use in any particular case, based on the explanations below.

When we speak of free software, we are referring to freedom of use, not price. Our General Public Licenses are designed to make sure that you have the freedom to distribute copies of free software (and charge for this service if you wish); that you receive source code or can get it if you want it; that you can change the software and use pieces of it in new free programs; and that you are informed that you can do these things.

To protect your rights, we need to make restrictions that forbid distributors to deny you these rights or to ask you to surrender these rights. These restrictions translate to certain responsibilities for you if you distribute copies of the library or if you modify it.

For example, if you distribute copies of the library, whether gratis or for a fee, you must give the recipients all the rights that we gave you. You must make sure that they, too, receive or can get the source code. If you link other code with the library, you must provide complete object files to the recipients, so that they can relink them with the library after making changes to the library and recompiling it. And you must show them these terms so they know their rights. We protect your rights with a two-step method: (1) we copyright the library, and (2) we offer you this license, which gives you legal permission to copy, distribute and/or modify the library.

To protect each distributor, we want to make it very clear that there is no warranty for the free library. Also, if the library is modified by someone else and passed on, the recipients should know that what they have is not the original version, so that the original author's reputation will not be affected by problems that might be introduced by others.

Finally, software patents pose a constant threat to the existence of any free program. We wish to make sure that a company cannot effectively restrict the users of a free program by obtaining a restrictive license from a patent holder. Therefore, we insist that any patent license obtained for a version of the library must be consistent with the full freedom of use specified in this license.

Most GNU software, including some libraries, is covered by the ordinary GNU General Public License. This license, the GNU Lesser General Public License, applies to certain designated libraries, and is quite different from the ordinary General Public License. We use this license for certain libraries in order to permit linking those libraries into non-free programs.

When a program is linked with a library, whether statically or using a shared library, the combination of the two is legally speaking a combined work, a derivative of the original library. The ordinary General Public License therefore permits such linking only if the entire combination fits its criteria of freedom. The Lesser General Public License permits more lax criteria for linking other code with the library.

We call this license the “Lesser” General Public License because it does Less to protect the user's freedom than the ordinary General Public License. It also provides other free software developers Less of an advantage over competing non-free programs. These disadvantages are the reason we use the ordinary General Public License for many libraries. However, the Lesser license provides advantages in certain special circumstances.

For example, on rare occasions, there may be a special need to encourage the widest possible use of a certain library, so that it becomes a de-facto standard. To achieve this, non-free programs must be allowed to use the library. A more frequent case is that a free library does the same job as widely used non-free libraries. In this case, there is little to gain by limiting the free library to free software only, so we use the Lesser General Public License.

In other cases, permission to use a particular library in non-free programs enables a greater number of people to use a large body of free software. For example, permission to use the GNU C Library in non-free programs enables many more people to use the whole GNU operating system, as well as its variant, the GNU Linux operating system.

Although the Lesser General Public License is Less protective of the users' freedom, it does ensure that the user of a program that is linked with the Library has the freedom and the wherewithal to run that program using a modified version of the Library.

The precise terms and conditions for copying, distribution and modification follow. Pay close attention to the difference between a “work based on the library” and a “work that uses the library”. The former contains code derived from the library, whereas the latter must be combined with the library in order to run.

GNU LESSER GENERAL PUBLIC LICENSE

TERMS AND CONDITIONS FOR COPYING, DISTRIBUTION AND MODIFICATION

0. This License Agreement applies to any software library or other program which contains a notice placed by the copyright holder or other authorized party saying it may be distributed under the terms of this Lesser General Public License (also called “this License”). Each licensee is addressed as “you”.

A “library” means a collection of software functions and/or data prepared so as to be conveniently linked with application programs (which use some of those functions and data) to form executables.

The “Library”, below, refers to any such software library or work which has been distributed under these terms. A “work based on the Library” means either the Library or any derivative work under copyright law: that is to say, a work containing the Library or a portion of it, either verbatim or with modifications and/or translated straightforwardly into another language. (Hereinafter, translation is included without limitation in the term “modification”.)

“Source code” for a work means the preferred form of the work for making modifications to it. For a library, complete source code means all the source code for all modules it contains, plus any associated interface definition files, plus the scripts used to control compilation and installation of the library.

Activities other than copying, distribution and modification are not covered by this License; they are outside its scope. The act of running a program using the Library is not restricted, and output from such a program is covered only if its contents constitute a work based on the Library (independent of the use of the Library in a tool for writing it). Whether that is true depends on what the Library does and what the program that uses the Library does.

1. You may copy and distribute verbatim copies of the Library's complete source code as you receive it, in any medium, provided that you conspicuously and appropriately publish on each copy an appropriate copyright notice and disclaimer of warranty; keep intact all the notices that refer to this License and to the absence of any warranty; and distribute a copy of this License along with the Library.

You may charge a fee for the physical act of transferring a copy, and you may at your option offer warranty protection in exchange for a fee.

2. You may modify your copy or copies of the Library or any portion of it, thus forming a work based on the Library, and copy and distribute such modifications or work under the terms of Section 1 above, provided that you also meet all of these conditions:

- a) The modified work must itself be a software library.
- b) You must cause the files modified to carry prominent notices stating that you changed the files and the date of any change.
- c) You must cause the whole of the work to be licensed at no charge to all third parties under the terms of this License.
- d) If a facility in the modified Library refers to a function or a table of data to be supplied by an application program that uses the facility, other than as an argument passed when the facility is invoked, then you must make a good faith effort to ensure that, in the event an application does not supply such function or table, the facility still operates, and performs whatever part of its purpose remains meaningful. (For example, a function in a library to compute square roots has a purpose that is entirely well-defined independent of the application. Therefore, Subsection 2d requires that any application-supplied function or table used by this function must be optional: if the application does not supply it, the square root function must still compute square roots.) These requirements apply to the modified work as a whole. If identifiable sections of that work are not derived from the Library, and can be reasonably considered independent and separate works in themselves, then this License, and its terms, do not apply to those sections when you distribute them as separate works. But when you distribute the same sections as part of a whole which is a work based on the Library, the distribution of the whole must be on the terms of this License, whose permissions for other licensees extend to the entire whole, and thus to each and every part regardless of who wrote it.

Thus, it is not the intent of this section to claim rights or contest your rights to work written entirely by you; rather, the intent is to exercise the right to control the distribution of derivative or collective works based on the Library.

In addition, mere aggregation of another work not based on the Library with the Library (or with a work based on the Library) on a volume of a storage or distribution medium does not bring the other work under the scope of this License.

- 3. You may opt to apply the terms of the ordinary GNU General Public License instead of this License to a given copy of the Library. To do this, you must alter all the notices that refer to this License, so that they refer to the ordinary GNU General Public License, version 2, instead of to this License. (If a newer version than version 2 of the ordinary GNU General Public License has appeared, then you can specify that version instead if you wish.) Do not make any other change in these notices.

Once this change is made in a given copy, it is irreversible for that copy, so the ordinary GNU General Public License applies to all subsequent copies and derivative works made from that copy. This option is useful when you wish to copy part of the code of the Library into a program that is not a library.

- 4. You may copy and distribute the Library (or a portion or derivative of it, under Section 2) in object code or executable form under the terms of Sections 1 and 2 above provided that you accompany it with the complete corresponding machine-readable source code, which must be distributed under the terms of Sections 1 and 2 above on a medium customarily used for software interchange.

If distribution of object code is made by offering access to copy from a designated place, then offering equivalent access to copy the source code from the same place satisfies the requirement to distribute the source code, even though third parties are not compelled to copy the source along with the object code.

- 5. A program that contains no derivative of any portion of the Library, but is designed to work with the Library by being compiled or linked with it, is called a "work that uses the Library". Such a work, in isolation, is not a derivative work of the Library, and therefore falls outside the scope of this License.
- 6. However, linking a "work that uses the Library" with the Library creates an executable that is a derivative of the Library (because it contains portions of the Library), rather than a "work that uses the library". The executable is therefore covered by this License. Section 6 states terms for distribution of such executables.

When a "work that uses the Library" uses material from a header file that is part of the Library, the object code for the work may be a derivative work of the Library even though the source code is not. Whether this is true is especially significant if the work can be linked without the Library, or if the work is itself a library. The threshold for this to be true is not precisely defined by law.

- 7. If such an object file uses only numerical parameters, data structure layouts and accessors, and small macros and small inline functions (ten lines or less in length), then the use of the object file is unrestricted, regardless of whether it is legally a derivative work. (Executables containing this object code plus portions of the Library will still fall under Section 6.)

Otherwise, if the work is a derivative of the Library, you may distribute the object code for the work under the terms of Section 6. Any executables containing that work also fall under Section 6, whether or not they are linked directly with the Library itself.

- 8. As an exception to the Sections above, you may also combine or link a "work that uses the Library" with the Library to produce a work containing portions of the Library, and distribute that work under terms of your choice, provided that the terms permit modification of the work for the customer's own use and reverse engineering for debugging such modifications.

You must give prominent notice with each copy of the work that the Library is used in it and that the Library and its use are covered by this License. You must supply a copy of this License. If the work during execution displays copyright notices, you must include the copyright notice for the Library among them, as well as a reference directing the user to the copy of this License. Also, you must do one of these things:

- a) Accompany the work with the complete corresponding machine-readable source code for the Library including whatever changes were used in the work (which must be distributed under Sections 1 and 2 above); and, if the work is an executable linked with the Library, with the complete machine-readable "work that uses the Library", as object code and/or source code, so that the user can modify the Library and then relink to produce a modified executable containing the modified Library. (It is understood that the user who changes the contents of definitions files in the Library will not necessarily be able to recompile the application to use the modified definitions.)
- b) Use a suitable shared library mechanism for linking with the Library. A suitable mechanism is one that (1) uses at run time a copy of the library already present on the user's computer system, rather than copying library functions into the executable, and (2) will operate properly with a modified version of the library, if the user installs one, as long as the modified version is interface-compatible with the version that the work was made with.
- c) Accompany the work with a written offer, valid for at least three years, to give the same user the materials specified in Subsection 6a, above, for a charge no more than the cost of performing this distribution.
- d) If distribution of the work is made by offering access to copy from a designated place, offer equivalent access to copy the above specified materials from the same place.
- e) Verify that the user has already received a copy of these materials or that you have already sent this user a copy.

For an executable, the required form of the “work that uses the Library” must include any data and utility programs needed for reproducing the executable from it. However, as a special exception, the materials to be distributed need not include anything that is normally distributed (in either source or binary form) with the major components (compiler, kernel, and so on) of the operating system on which the executable runs, unless that component itself accompanies the executable.

It may happen that this requirement contradicts the license restrictions of other proprietary libraries that do not normally accompany the operating system. Such a contradiction means you cannot use both them and the Library together in an executable that you distribute.

9. You may place library facilities that are a work based on the Library side-by-side in a single library together with other library facilities not covered by this License, and distribute such a combined library, provided that the separate distribution of the work based on the Library and of the other library facilities is otherwise permitted, and provided that you do these two things:
 - a) Accompany the combined library with a copy of the same work based on the Library, uncombined with any other library facilities. This must be distributed under the terms of the Sections above.
 - b) Give prominent notice with the combined library of the fact that part of it is a work based on the Library, and explaining where to find the accompanying uncombined form of the same work.
10. You may not copy, modify, sublicense, link with, or distribute the Library except as expressly provided under this License. Any attempt otherwise to copy, modify, sublicense, link with, or distribute the Library is void, and will automatically terminate your rights under this License. However, parties who have received copies, or rights, from you under this License will not have their licenses terminated so long as such parties remain in full compliance.
11. You are not required to accept this License, since you have not signed it. However, nothing else grants you permission to modify or distribute the Library or its derivative works. These actions are prohibited by law if you do not accept this License. Therefore, by modifying or distributing the Library (or any work based on the Library), you indicate your acceptance of this License to do so, and all its terms and conditions for copying, distributing or modifying the Library or works based on it.
12. Each time you redistribute the Library (or any work based on the Library), the recipient automatically receives a license from the original licensor to copy, distribute, link with or modify the Library subject to these terms and conditions. You may not impose any further restrictions on the recipients' exercise of the rights granted herein. You are not responsible for enforcing compliance by third parties with this License.
13. If, as a consequence of a court judgment or allegation of patent infringement or for any other reason (not limited to patent issues), conditions are imposed on you (whether by court order, agreement or otherwise) that contradict the conditions of this License, they do not excuse you from the conditions of this License. If you cannot distribute so as to satisfy simultaneously your obligations under this License and any other pertinent obligations, then as a consequence you may not distribute the Library at all. For example, if a patent license would not permit royalty-free redistribution of the Library by all those who receive copies directly or indirectly through you, then the only way you could satisfy both it and this License would be to refrain entirely from distribution of the Library. If any portion of this section is held invalid or unenforceable under any particular circumstance, the balance of the section is intended to apply, and the section as a whole is intended to apply in other circumstances.
It is not the purpose of this section to induce you to infringe any patents or other property right claims or to contest validity of any such claims; this section has the sole purpose of protecting the integrity of the free software distribution system which is implemented by public license practices. Many people have made generous contributions to the wide range of software distributed through that system in reliance on consistent application of that system; it is up to the author donor to decide if he or she is willing to distribute software through any other system and a licensee cannot impose that choice.
This section is intended to make thoroughly clear what is believed to be a consequence of the rest of this License.
14. If the distribution and/or use of the Library is restricted in certain countries either by patents or by copyrighted interfaces, the original copyright holder who places the Library under this License may add an explicit geographical distribution limitation excluding those countries, so that distribution is permitted only in or among countries not thus excluded. In such case, this License incorporates the limitation as if written in the body of this License.
15. The Free Software Foundation may publish revised and/or new versions of the Lesser General Public License from time to time. Such new versions will be similar in spirit to the present version, but may differ in detail to address new problems or concerns.
Each version is given a distinguishing version number. If the Library specifies a version number of this License which applies to it and “any later version”, you have the option of following the terms and conditions either of that version or of any later version published by the Free Software Foundation. If the Library does not specify a license version number, you may choose any version ever published by the Free Software Foundation.
16. If you wish to incorporate parts of the Library into other free programs whose distribution conditions are incompatible with these, write to the author to ask for permission. For software which is copyrighted by the Free Software Foundation, write to the Free Software Foundation; we sometimes make exceptions for this. Our decision will be guided by the two goals of preserving the free status of all derivatives of our free software and of promoting the sharing and reuse of software generally.

NO WARRANTY

17. BECAUSE THE LIBRARY IS LICENSED FREE OF CHARGE, THERE IS NO WARRANTY FOR THE LIBRARY, TO THE EXTENT PERMITTED BY APPLICABLE LAW. EXCEPT WHEN OTHERWISE STATED IN WRITING THE COPYRIGHT HOLDERS AND/OR OTHER PARTIES PROVIDE THE LIBRARY “AS IS” WITHOUT WARRANTY OF ANY KIND, EITHER EXPRESSED OR IMPLIED, INCLUDING, BUT NOT LIMITED TO, THE IMPLIED WARRANTIES OF MERCHANTABILITY AND FITNESS FOR A PARTICULAR PURPOSE. THE ENTIRE RISK AS TO THE QUALITY AND PERFORMANCE OF THE LIBRARY IS WITH YOU. SHOULD THE LIBRARY PROVE DEFECTIVE, YOU ASSUME THE COST OF ALL NECESSARY SERVICING, REPAIR OR CORRECTION.
 18. IN NO EVENT UNLESS REQUIRED BY APPLICABLE LAW OR AGREED TO IN WRITING WILL ANY COPYRIGHT HOLDER, OR ANY OTHER PARTY WHO MAY MODIFY AND/OR REDISTRIBUTE THE LIBRARY AS PERMITTED ABOVE, BE LIABLE TO YOU FOR DAMAGES, INCLUDING ANY GENERAL, SPECIAL, INCIDENTAL OR CONSEQUENTIAL DAMAGES ARISING OUT OF THE USE OR INABILITY TO USE THE LIBRARY (INCLUDING BUT NOT LIMITED TO LOSS OF DATA OR DATA BEING RENDERED INACCURATE OR LOSSES SUSTAINED BY YOU OR THIRD PARTIES OR A FAILURE OF THE LIBRARY TO OPERATE WITH ANY OTHER SOFTWARE), EVEN IF SUCH HOLDER OR OTHER PARTY HAS BEEN ADVISED OF THE POSSIBILITY OF SUCH DAMAGES.
- END OF TERMS AND CONDITIONS

How to Apply These Terms to Your New Libraries

If you develop a new library, and you want it to be of the greatest possible use to the public, we recommend making it free software that everyone can redistribute and change. You can do so by permitting redistribution under these terms (or, alternatively, under the terms of the ordinary General Public License).

To apply these terms, attach the following notices to the library. It is safest to attach them to the start of each source file to most effectively convey the exclusion of warranty; and each file should have at least the "copyright" line and a pointer to where the full notice is found.

<one line to give the library's name and a brief idea of what it does.>

Copyright © <year> <name of author>

This library is free software; you can redistribute it and/or modify it under the terms of the GNU Lesser General Public License as published by the Free Software Foundation; either version 2.1 of the License, or (at your option) any later version.

This library is distributed in the hope that it will be useful, but WITHOUT ANY WARRANTY; without even the implied warranty of MERCHANTABILITY or FITNESS FOR A PARTICULAR PURPOSE. See the GNU Lesser General Public License for more details.

You should have received a copy of the GNU Lesser General Public License along with this library; if not, write to the Free Software Foundation, Inc., 51 Franklin Street, Fifth Floor, Boston, MA 02110-1301 USA

Also add information on how to contact you by electronic and paper mail.

You should also get your employer (if you work as a programmer) or your school, if any, to sign a "copyright disclaimer" for the library, if necessary. Here is a sample; alter the names:

Yoyodyne, Inc., hereby disclaims all copyright interest in the library 'Frob' (a library for tweaking knobs) written by James Random Hacker.

<signature of Ty Coon>, 1 April 1990

Ty Coon, President of Vice

That's all there is to it!

[Linux Source Notice]

The software programs used on this product include the Linux operating system. The Linux contains software licensed for use based on the terms of a GNU General Public License. The machine readable copy of the corresponding source code is available for the cost of distribution.

For more information or to obtain a copy, contact your local Pioneer Customer Service center.

Details of the GNU General Public License can be found at the GNU website (<http://www.gnu.org>).

Specifications

General

System	Blu-ray Disc PLAYER (BD-ROM, DVD-Video, DVD-R/-RW, CD, network file playback)
Power requirements	AC 120 V, 60 Hz
Power consumption	35 W
Power consumption (standby)	0.5 W
Weight	6.6 kg (14 lb 9 oz)
Dimensions	420 mm (W) x 103 mm (H) x 353 mm (D) (16 9/16 in. (W) x 4 1/16 in. (H) x 13 15/16 in. (D))
Operating temperature	+5 °C to +35 °C (+41 °F to +95 °F)
Operating humidity	.5 % to 85 % (no condensation)

HDMI output

HDMI output	19-pin
-------------	--------

Component Video output (Y, Pb, Pr)

Output level	Y: 1.0 Vp-p (75 Ω) Pb, Pr: 0.7 Vp-p (75 Ω)
Jacks	RCA jacks

S-Video output

Y (luminance) - Output level	1 Vp-p (75 Ω)
C (color) - Output level	286 mVp-p (75 Ω)
Jack	S-Video jack

Video output

Output level	1 Vp-p (75 Ω)
Jack	RCA jack

Audio output (1 stereo pair)

Output level	During audio output 200 mVrms (1 kHz, -20 dB)
Number of channels	2
Jacks	RCA jack

Audio output (multi-channel/L, R, C, SW, LS, RS)

Output level	During audio output 200 mVrms (1 kHz, -20 dB)
Number of channels	6
Jacks	RCA jack

Audio characteristics

Frequency response	4 Hz to 22 kHz
S/N ratio	115 dB
Dynamic range	108 dB
Total harmonic distortion	0.0015 %
Wow and flutter	Limit of measurement (0.001 % W. PEAK) or lower

Digital output

Optical digital output	Optical digital jack
Coaxial digital output	RCA jack

Other terminals

LAN terminal	Ethernet jack (100BASE-TX)
Control in	Minijack (3.5 ø)
IR in	Minijack (3.5 ø)

Accessories

Remote control	1
AA/R6P dry cell batteries	2
Stereo audio cable (red/white plugs)	1
Video cable (yellow plugs)	1
LAN cable	1
Power cable	1
Warranty card	1
Operating instructions	1

The specifications and design of this product are subject to change without notice.



Should this product require service in the U.S.A. and you wish to locate the nearest Pioneer Authorized Independent Service Company, or if you wish to purchase replacement parts, operating instructions, service manuals, or accessories, please call the number shown below.

1-800-421-1404

Please do not ship your product to Pioneer without first calling the Customer Support at the above listed number for assistance.

Pioneer Electronics Service, Inc.
P.O. BOX 1760, Long Beach,
CA 90801-1760, U.S.A.

For warranty information please see the Limited Warranty sheet included with your product.

Should this product require service in Canada, please contact a Pioneer Canadian Authorized Dealer to locate the nearest Pioneer Authorized Service Company in Canada. Alternatively, please contact the Customer Satisfaction Department at the following address:

Pioneer Electronics of Canada, Inc.
Customer Satisfaction Department
300 Allstate Parkway, Markham, Ontario L3R 0P2
1-877-283-5901
905-479-4411

For warranty information please see the Limited Warranty sheet included with your product.

Si ce produit doit être réparé au Canada, veuillez vous adresser à un distributeur autorisé Pioneer du Canada pour obtenir le nom du Centre de Service Autorisé Pioneer le plus près de chez-vous. Vous pouvez aussi contacter le Service à la clientèle de Pioneer:

Pioneer Électroniques du Canada, Inc.
Service Clientèle
300, Allstate Parkway, Markham, Ontario L3R 0P2
1-877-283-5901
905-479-4411

Pour obtenir des renseignements sur la garantie, veuillez vous reporter au feuillet sur la garantie restreinte qui accompagne le produit.

S018_C_EF

Register Your Product on

<http://www.pioneerelectronics.com> (US)

<http://www.pioneerelectronics.ca> (Canada)

PIONEER CORPORATION

4-1, Meguro 1-Chome, Meguro-ku, Tokyo 153-8654, Japan

PIONEER ELECTRONICS (USA) INC.

P.O. BOX 1540, Long Beach, California 90801-1540, U.S.A. TEL: (800) 421-1404

PIONEER ELECTRONICS OF CANADA, INC.

300 Allstate Parkway, Markham, Ontario L3R 0P2, Canada TEL: 1-877-283-5901, 905-479-4411

PIONEER EUROPE NV

Haven 1087, Keetberglaan 1, B-9120 Melsele, Belgium TEL: 03/570.05.11

PIONEER ELECTRONICS ASIACENTRE PTE. LTD.

253 Alexandra Road, #04-01, Singapore 159936 TEL: 65-6472-7555

PIONEER ELECTRONICS AUSTRALIA PTY. LTD.

178-184 Boundary Road, Braeside, Victoria 3195, Australia, TEL: (03) 9586-6300

PIONEER ELECTRONICS DE MEXICO S.A. DE C.V.

Blvd.Manuel Avila Camacho 138 10 piso Col.Lomas de Chapultepec, Mexico,D.F. 11000 TEL: 55-9178-4270

K002_B_En

PIONEER, ELITE, SOUND.VISION.SOUL, and the Pioneer, Elite and sound.vision.soul logos are trademarks of Pioneer Corporation.

Published by Pioneer Corporation.
Copyright © 2007 Pioneer Corporation.
All rights reserved.