

Service Manual

DVD Video Recorder

DMR-ES20P

DMR-ES20PC

Vol. 1

Colour

(K).....Black Type (ES20P only)

(S).....Silver Type



Notes: This model's DVD Drive is VXY1867.

Panasonic

© 2005 Matsushita Electric Industrial Co., Ltd. All rights reserved. Unauthorized copying and distribution is a violation of law.

TABLE OF CONTENTS

	PAGE
1 Safety Precaution	3
1.1. General guidelines	3
1.2. Caution for fuse replacement	3
2 Warning	4
2.1. Prevention of Electrostatic Discharge (ESD) to Electrostatic Sensitive (ES) Devices	4
2.2. Precaution of Laser Diode	5
2.3. Handling the Lead-free Solder	5
3 Service Navigation	6
3.1. Service Information	6
3.2. Flow chart for confirmation	6
3.3. Confirm "RAM-Drive Last Error" in Service Mode	7
4 Specifications	9
5 Features	10
5.1. Quick start function(REC)	10
6 Location of Controls and Components	11
7 Operation Instructions	12
7.1. Taking out the Disc from RAM-Drive Unit when the Disc cannot be ejected by OPEN/ CLOSE button	12
8 Service Mode	13
8.1. Self-Diagnosis and Special Mode Setting	13
9 Service Fixture & Tools	20
10 Disassembly and Assembly Instructions	21
10.1. Disassembly Flow Chart	21
10.2. P.C.B. Positions	21
10.3. Top Cover	22
10.4. Front Panel	22
10.5. Digital P.C.B.	22
10.6. DV Javk P.C.B.	23
10.7. DVD-RAM Drive	23
10.8. Rear Panel & Fan Motor	24
10.9. Main P.C.B.	25
10.10. Front (L) P.C.B.	25
11 Measurements and Adjustments	26
11.1. Service Positions	26
11.2. After replacing the RAM Drive with new one	29
11.3. When the unit does not operate normally after replacing the Timer Microprocessor or Main P.C.B.	29
11.4. Standard Inspection Specifications after Making Repairs	29
12 Miscellaneous	30
12.1. Abbreviations	30

PAGE

1 Safety Precaution

1.1. General guidelines

1. When servicing, observe the original lead dress. If a short circuit is found, replace all parts which have been overheated or damaged by the short circuit.
2. After servicing, see to it that all the protective devices such as insulation barriers, insulation papers shields are properly installed.
3. After servicing, make the following leakage current checks to prevent the customer from being exposed to shock hazards.

1.1.1. Leakage current cold check

1. Unplug the AC cord and connect a jumper between the two prongs on the plug.
2. Measure the resistance value, with an ohmmeter, between the jumpered AC plug and each exposed metallic cabinet part on the equipment such as screwheads, connectors, control shafts, etc. When the exposed metallic part has a return path to the chassis, the reading should be between $1M\Omega$ and $5.2M\Omega$.

When the exposed metal does not have a return path to the chassis, the reading must be ∞ .

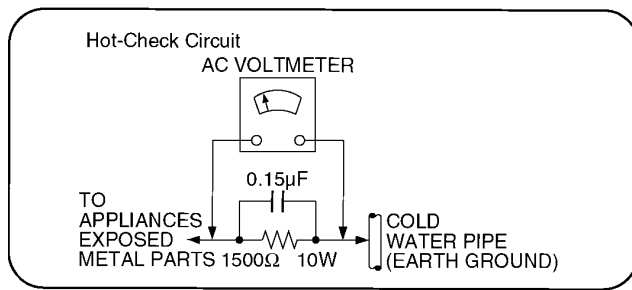

Figure 1

1.1.2. Leakage current hot check (See Figure 1.)

1. Plug the AC cord directly into the AC outlet. Do not use an isolation transformer for this check.
2. Connect a $1.5k\Omega$, 10 watts resistor, in parallel with a $0.15\mu F$ capacitors, between each exposed metallic part on the set and a good earth ground such as a water pipe, as shown in Figure 1.
3. Use an AC voltmeter, with 1000 ohms/volt or more sensitivity, to measure the potential across the resistor.
4. Check each exposed metallic part, and measure the voltage at each point.
5. Reverse the AC plug in the AC outlet and repeat each of the above measurements.
6. The potential at any point should not exceed 0.75 volts RMS. A leakage current tester (Simpson Model 229 or equivalent) may be used to make the hot checks, leakage current must not exceed 1/2 milliampere. In case a measurement is outside of the limits specified, there is a possibility of a shock hazard, and the equipment should be repaired and rechecked before it is returned to the customer.

1.2. Caution for fuse replacement

(For English)

CAUTION:

Replace with the same type fuse:
(Manufacturer: Hollyland, Type: 50T, 1.6A, 250V)

(For Canadian French)

ATTENTION:

Utiliser un fusible de rechange de même type:
(Fabricant: Hollyland, Type: 50T, 1.6A, 250V)

2 Warning

2.1. Prevention of Electrostatic Discharge (ESD) to Electrostatic Sensitive (ES) Devices

Some semiconductor (solid state) devices can be damaged easily by static electricity. Such components commonly are called Electrostatic Sensitive (ES) Devices. Examples of typical ES devices are integrated circuits and some field-effect transistor-and semiconductor "chip" components. The following techniques should be used to help reduce the incidence of component damage caused by electrostatic discharge (ESD).

1. Immediately before handling any semiconductor component or semiconductor-equipped assembly, drain off any ESD on your body by touching a known earth ground. Alternatively, obtain and wear a commercially available discharging ESD wrist strap, which should be removed for potential shock reasons prior to applying power to the unit under test.
2. After removing an electrical assembly equipped with ES devices, place the assembly on a conductive surface such as aluminum foil, to prevent electrostatic charge buildup or exposure of the assembly.
3. Use only a grounded-tip soldering iron to solder or unsolder ES devices.
4. Use only an anti-static solder removal device. Some solder removal devices not classified as "anti-static (ESD protected)" can generate electrical charge sufficient to damage ES devices.
5. Do not use freon-propelled chemicals. These can generate electrical charges sufficient to damage ES devices.
6. Do not remove a replacement ES device from its protective package until immediately before you are ready to install it. (Most replacement ES devices are packaged with leads electrically shorted together by conductive foam, aluminum foil or comparable conductive material).
7. Immediately before removing the protective material from the leads of a replacement ES device, touch the protective material to the chassis or circuit assembly into which the device will be installed.

Caution

Be sure no power is applied to the chassis or circuit, and observe all other safety precautions.

8. Minimize bodily motions when handling unpackaged replacement ES devices. (Otherwise harmless motion such as the brushing together of your clothes fabric or the lifting of your foot from a carpeted floor can generate static electricity sufficient to damage an ES device).

IMPORTANT SAFETY NOTICE

There are special components used in this equipment which are important for safety. These parts are marked by \triangle in the schematic diagrams, Exploded Views and replacement parts list. It is essential that these critical parts should be replaced with manufacturer's specified parts to prevent shock, fire, or other hazards. Do not modify the original design without permission of manufacturer.

2.2. Precaution of Laser Diode

CAUTION:

This product utilizes a laser diode with the unit turned “on”, invisible laser radiation is emitted from the pickup lens.
 Wave length: 662 nm (DVDs)/780 nm (CDs)
 Maximum output radiation power from pickup: 100 μ W/VDE

Laser radiation from the pickup lens is safety level, but be sure the followings:

1. Do not disassemble the optical pickup unit, since radiation from exposed laser diode is dangerous.
2. Do not adjust the variable resistor on the pickup unit. It was already adjusted.
3. Do not look at the focus lens using optical instruments.
4. Recommend not to look at pickup lens for a long time.

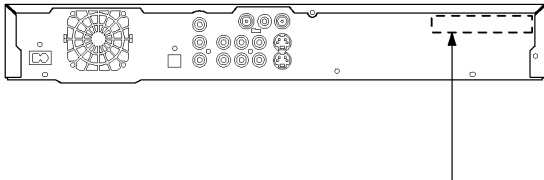

Product complies with DHHS Rules 21 CFR Subchapter J in effect at date of manufacture. Matsushita Electric Industrial Co., Ltd. Kadoma, Osaka, Japan

ACHTUNG:

Dieses Produkt enthält eine Laserdiode.
 Im eingeschalteten Zustand wird unsichtbare Laserstrahlung von der Lasereinheit abgestrahlt.
 Wellenlänge: 780 nm (DVDs)/795 nm (CDs)
 Maximale Strahlungsleistung der Lasereinheit: 100 μ W/VDE

Die Strahlung der Lasereinheit ist ungefährlich, wenn folgende Punkte beachtet werden:

1. Die Lasereinheit nicht zerlegen, da die Strahlung an der freigelegten Laserdiode gefährlich ist.
2. Den werkseitig justierten Einstellregler der Lasereinheit nicht verstellen.
3. Nicht mit optischen Instrumenten in die Fokussierlinse blicken.
4. Nicht über längere Zeit in die Fokussierlinse blicken.

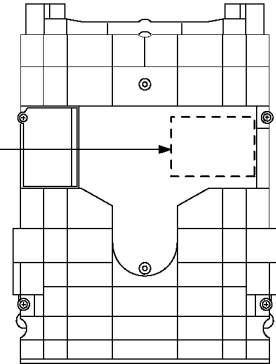

DANGER	- VISIBLE AND INVISIBLE LASER RADIATION WHEN OPEN. AVOID DIRECT EXPOSURE TO BEAM. (FDA 21 CFR)
CAUTION	- VISIBLE AND INVISIBLE LASER RADIATION WHEN OPEN. AVOID EXPOSURE TO BEAM. (IEC60825-1)
ATTENTION	- RAYONNEMENT LASER VISIBLE ET INVISIBLE EN CAS D'OUVERTURE. EXPOSITION DANGEREUSE AU FAISCEAU.
ADVARSEL	- SYNLIG OG USYNLIG LASERSTRÅLING VED ÅBNING. UNDGÅ UDSÆTTELSE FOR STRÅLING.
VARO!	- AVATTAESSA OLET ALTTIINA NÄKYVÄÄ JA NÄKYMÄTÖN LASERSTRÄLTYLLE. ÄLÄ KATSO SÄTEESEEN.
VARNING	- SYNLIG OCH OSYNLIG LASERSTRÅLING NÄR DENNA DEL ÄR ÖPPNAD. BETRakta EJ STRÅLEN.
ADVARSEL	- SYNLIG OG USYNLIG LASERSTRÅLING NÄR DEKSEL ÅPNES. UNNGÅ EKSPONERING FOR STRÅLEN.
VORSICHT	- SICHTBARE UND UNSICHTBARE LASERSTRÄHLUNG, WENN ABDECKUNG GEÖFFNET. NICHT DEN STRAHL AUSSETZEN.
注意	- 打开时有可见及不可见激光辐射。避免激光束照射。
注意	- ここを開くと可視及び不可視のレーザー光が出ます。ビームを直接照らす、眺めたりしないでください。 RGLS0233

CAUTION!
 THIS PRODUCT UTILIZES A LASER.
 USE OF CONTROLS OR ADJUSTMENTS OR PERFORMANCE OF PROCEDURES OTHER THAN THOSE SPECIFIED HEREIN MAY RESULT IN HAZARDOUS RADIATION EXPOSURE.

2.3. Handling the Lead-free Solder

2.3.1. About lead free solder (PbF)

Distinction of PbF P.C.B.:

P.C.B.s (manufactured) using lead free solder will have a PbF stamp on the P.C.B.

Caution:

- Pb free solder has a higher melting point than standard solder; Typically the melting point is 50 - 70°F (30 - 40°C) higher. Please use a high temperature soldering iron. In case of the soldering iron with temperature control, please set it to 700 ± 20°F (370 ± 10°C).
- Pb free solder will tend to splash when heated too high (about 1100°F/600°C).
- When soldering or unsoldering, please completely remove all of the solder on the pins or solder area, and be sure to heat the soldering points with the Pb free solder until it melts enough.

3 Service Navigation

3.1. Service Information

This service manual contains technical information which will allow service personnel's to understand and service this model.

Please place orders using the parts list and not the drawing reference numbers.

If the circuit is changed or modified, this information will be followed by supplement service manual to be filed with original service manual.

1) This service manual does not contain the following information, because of the impossibility of servicing at component level.

- * Schematic Diagram, Block Diagram and P.C.B. layout of Digital P.C.B.
- * Parts List for individual parts of Digital P.C.B.
- * Exploded View and Parts List for individual parts of RAM drive.

2) The following category are recycle module part. Please send them to Central Repair Center.

- * Digital P.C.B. (ES20P:VEP79115A, ES20PC: RFKBES20PC)
- * RAM drive (VXY1867)

3.2. Flow chart for confirmation

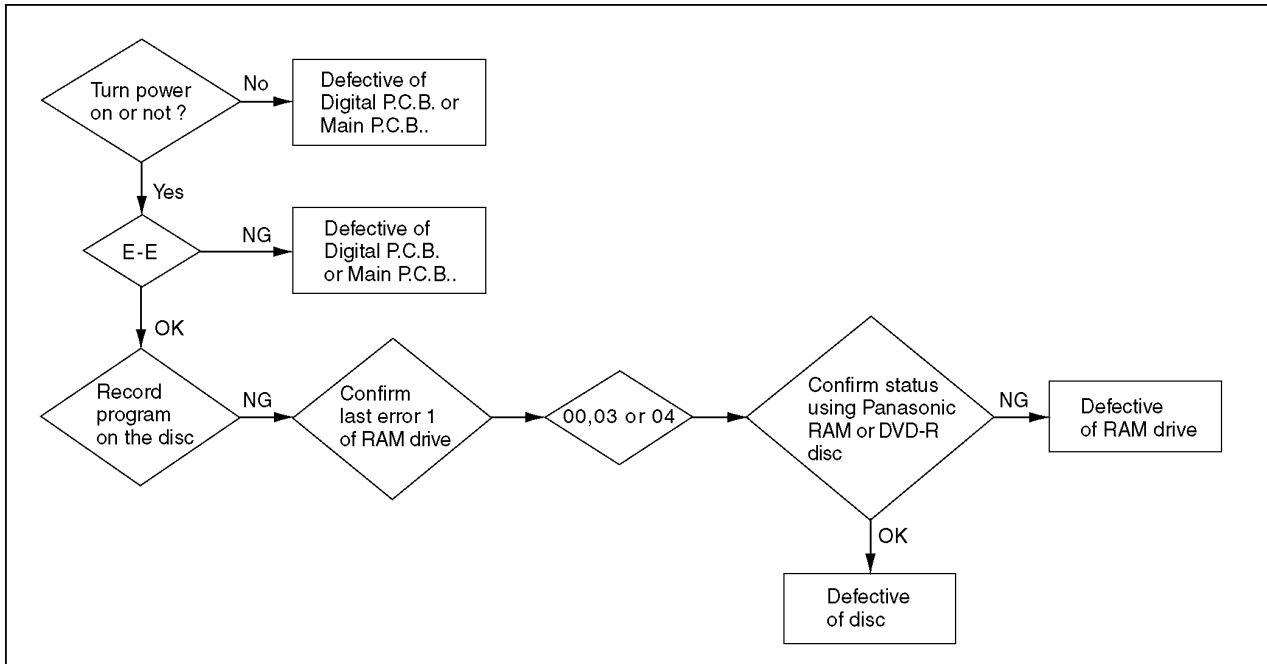

3.3. Confirm “RAM-Drive Last Error” in Service Mode

Execute Service Mode

1. Press [REC], [CH UP] and [OPEN/CLOSE] simultaneously for 5 seconds when P-off.
FL Display:



*After finishing display “(9). Factor of Drive Error occurring”, press [0] [2] ~[1] [9] keys of the Remote Controller so that 19 memories can be displayed as maximum.

2. Press [4] [2] keys of remote controller.

Example of FL Display:

- (1) Error Number is displayed for 5 seconds.

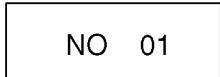

- (2) Time when the error has occurred (1/2) is displayed for 5 seconds.

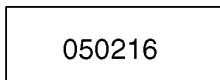

The error has occurred at 2005(year)/Feb.(month)/16(day)

- (3) Time when the error has occurred (2/2) is displayed for 5 seconds.

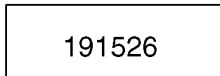

19(hour):15(minute):26(second)

- (4) Last Drive Error code No.1 is displayed for 5 seconds.

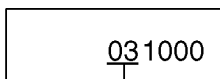

Error Sense
Key

- { 00: Bad disc
- { 03: Bad disc
- { 04: Bad disc or RAM-Drive malfunction

When above error codes are displayed, confirm operation with Panasonic RAM disc or Panasonic DVD-R disc.
***If the operation is OK, judge the error is due to media.**
***If the operation is NG and symptom as BLOCK NOISES and so on that are particular symptom of Digital appears, judge the error is due to RAM-Drive or Digital PCB.**

- (5) Last Drive Error code No2. (1/2) is displayed for 5 seconds.

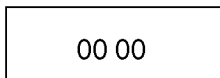

*This error code is unnecessary for service.

(6) Last Drive Error code No2. (2/2) is displayed for 5 seconds.

00 00

*This error code is unnecessary for service.

(7) Error occurring Disc type is displayed for 5 seconds.

DISC *

DISC 1: DVD
 DISC 2: CD
 DISC 3: DVD - RAM 2.6GB
 DISC 4: DVD - RAM 4.7GB
 DISC 5: DVD - R
 DISC : Unknown Disc

(8) Unused (No display).

(9) Factor of Drive Error occurring is left displayed

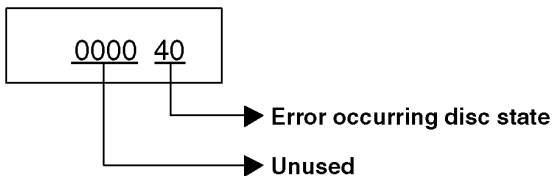

Error Occurring Disc State

FL Displays (Hexadecimal)	Description			
	Disc distinction state	Cartridge disc state	Cartridge disc state	Disc size
00	OK	With cartridge	Has not been opened yet.	12 cm
10	OK	With cartridge	Has not been opened yet.	8 cm
20	OK	With cartridge	Has been opened.	12 cm
30	OK	With cartridge	Has been opened.	8 cm
40	OK	Bare	Has not been opened yet.	12 cm
50	OK	Bare	Has not been opened yet.	8 cm
60	OK	Bare	Has been opened.	12 cm
70	OK	Bare	Has been opened.	8 cm
80	NG	With cartridge	Has not been opened yet.	12 cm
90	NG	With cartridge	Has not been opened yet.	8 cm
A0	NG	With cartridge	Has been opened.	12 cm
B0	NG	With cartridge	Has been opened.	8 cm
C0	NG	Bare	Has not been opened yet.	12 cm
D0	NG	Bare	Has not been opened yet.	8 cm
E0	NG	Bare	Has been opened.	12 cm
F0	NG	Bare	Has been opened.	8 cm

4 Specifications

Specifications

Power supply	AC120 V, 60 Hz
Power consumption	Approx. 22 W
Power consumption in standby mode	Approx. 15.7 W
Recording system	DVD Video Recording format (DVD-RAM) DVD Video format (DVD-R) DVD Video format (DVD-RW)
Optical pick-up	System with 1 lens, (662 nm wavelength for DVDs, 780 nm wavelength for CDs)
Recordable discs	<ul style="list-style-type: none"> • DVD-RAM: Ver.2.0 Ver.2.1/ 3X-SPEED DVD-RAM Revision 1.0 Ver.2.2/ 5X-SPEED DVD-RAM Revision 2.0 • DVD-R: for General Ver. 2.0 / 4X-SPEED DVD-R Revision 1.0 for General Ver. 2.x/ 8X-SPEED DVD-R Revision 3.0 DVD-RW: Ver. 1.1 Ver. 1.1/ 2X-SPEED DVD-RW Revision 1.0 Ver. 1.2/ 4X-SPEED DVD-RW Revision 2.0 • +R: Ver. 1.0 Ver. 1.1 Ver. 1.2
Quick Start for Recording (Quick Start: ON)	1 Sec. Quick Start for Recording on DVD-RAM* *From the power off state, for recording on DVD-RAM starts about 1 second after first pressing the power button and then sequentially pressing the REC button (Quick Start Mode).
Recording time	Max. 8 hours (using 4.7 GB disc) XP: 60 minutes SP: 120 minutes LP: 240 minutes EP: 360 minutes or 480 minutes
Region number	Region No.1
Playable discs	DVD-RAM, DVD-R, DVD-RW, +R, +RW DVD-VIDEO, CD-Audio (CD-DA), Video CD, CD-R/ CD-RW (CD-DA, Video CD, MP3, JPEG formatted discs)
Compression Method	<p>MP3</p> <p>Format: ISO9660 level1 or 2 (except for extended formats), Joliet Compatible compression rate: 32kbps ~ 320kbps Compatible sampling rate: 16kHz, 22.05kHz, 24kHz, 32kHz, 44.1kHz, 48kHz This unit not compatible with ID3 tags.</p> <p>CD (JPEG)</p> <p>Format: ISO9660 level1 or 2 (except for extended formats), Joliet Compatible pixels: between 34 × and 3840 × 2160 pixels Sab sampling 4:2:2 or 4:2:0 This unit not compatible with MOTION JPEG.</p> <p>MP3, CD (JPEG) Common Items</p> <p>Maximum number of folders :99 (one disc) Maximum number of files :999 (one disc) This unit is compatible with multi-session This unit is not compatible with packet writing.</p>
Telecigion system	
TV system	NTSC system, 525 lines, 60 fields
Antenna reception input	TV Channel: 2ch - 69ch, 75Ω CATV Channel: 1ch - 125ch, 75Ω
RF converter output	Not provided
Video system	
Recording system	MPEG2 (Hybrid VBR)

Input	<ul style="list-style-type: none"> • LINE (pin jack × 2), 1.0 Vp-p; 75 Ω • S connector × 2 Y: 1.0 Vp-p; 75 Ω C: 0.286 Vp-p; 75 Ω
Output	<ul style="list-style-type: none"> • LINE (pin jack × 1), 1.0 Vp-p; 75 Ω • S connector × 1 Y: 1.0 Vp-p; 75 Ω C: 0.286 Vp-p; 75 Ω
Component video output (480P/480i)	<ul style="list-style-type: none"> Y: 1.0 Vp-p; 75 Ω P_B: 0.7 Vp-p; 75 Ω P_R: 0.7 Vp-p; 75 Ω
Audio system	
Recording system	Dolby Digital (2ch)
Input	LINE (pin jack) × 2 Reference input: 309 mVrms FS: 2 Vrms (1 kHz, 0 dB) Input impedance: 47 kΩ
Output	LINE (pin jack) × 1 Reference output: 309 mVrms FS: 2 Vrms (1 kHz, 0 dB) Output impedance: 1 kΩ (Load impedance: 10 kΩ)
Number of channels	Recording: 2 channels Playback: 2 channels
Other input/output connector	Digital audio optical output connector (PCM, Dolby Digital, DTS)
DV Input IEEE 1394 Standard, 4pin	
Others	
Dimensions	Approx. 430 (W) × 63 (H) × 250 (D) mm [Approx. 16 15/16 "(W) × 2 1/2" (H) × 9 27/32" (D)] (excluding protrusions)
Mass	Approx. 2.55 kg (5.62 lbs)
Operating Temperature range	5°C - 40°C (41°F - 104°F)
Operating Humidity range	10 %-80 % RH (no condensation)
Clock unit	Quartz-controlled 12-hour digital display
LASER Specification (Class I LASER Product)	
Wave Length	780 nm(CDs), 662 nm(DVDs)
Laser Power	No hazardous radiation is emitted with the safety protection.
Solder	These models use lead free solder (PbF)

Notes : Mass and dimensions are approximate.
Specifications are subject to change without notice.

5 Features

5.1. Quick start function(REC)

1. General

A few seconds after tuning on the unit, you can start recording to DVD-RAM.

You can switch the operation of this function (ON/OFF) on the menu screen. .

2. Quick start (REC) principle

In the power-off at Quick start, only power supplies for video IC, tuner and storage media are cut off.

- ① When the REC button is pushed a few second after the power button is pushed, Audio and Video data are stored in DDR SDRAM before a storage media (DVD-RAM) preparation.
 - *Preparation time → DVD-RAM: About 8seconds
- ② After a storage media (DVD-RAM) preparation, Audio and Video data are transfer from DDR SDRAM to the storage media.

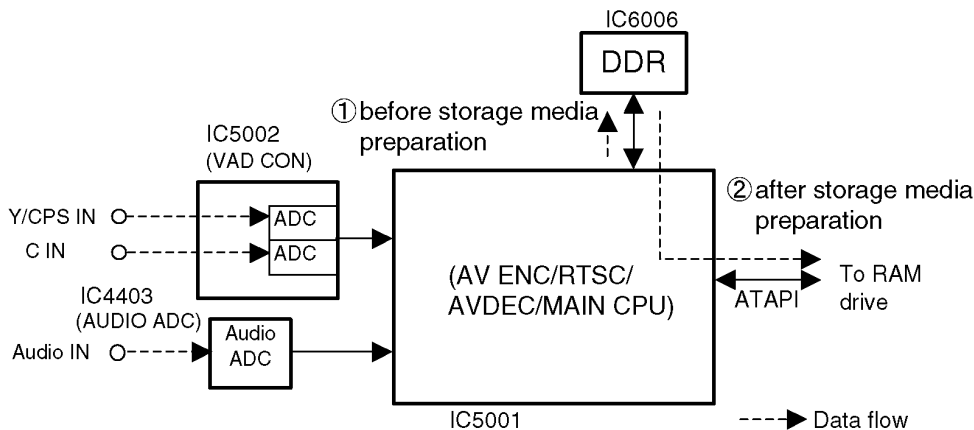

Quick start(REC) explanation chart

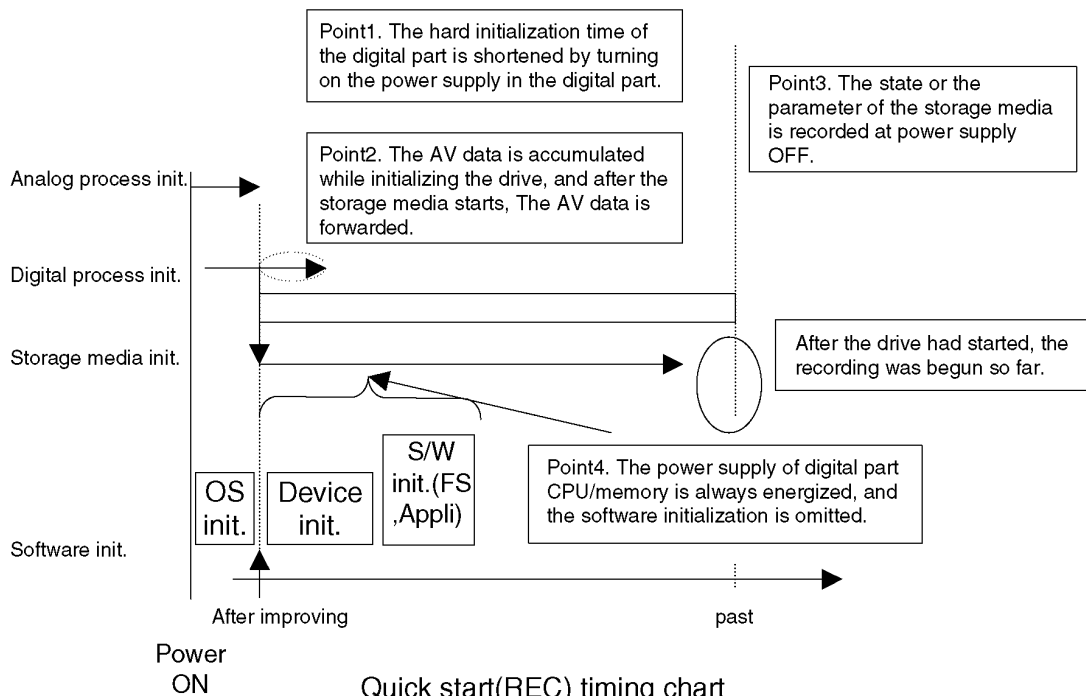

Quick start(REC) timing chart

6 Location of Controls and Components

Remote control

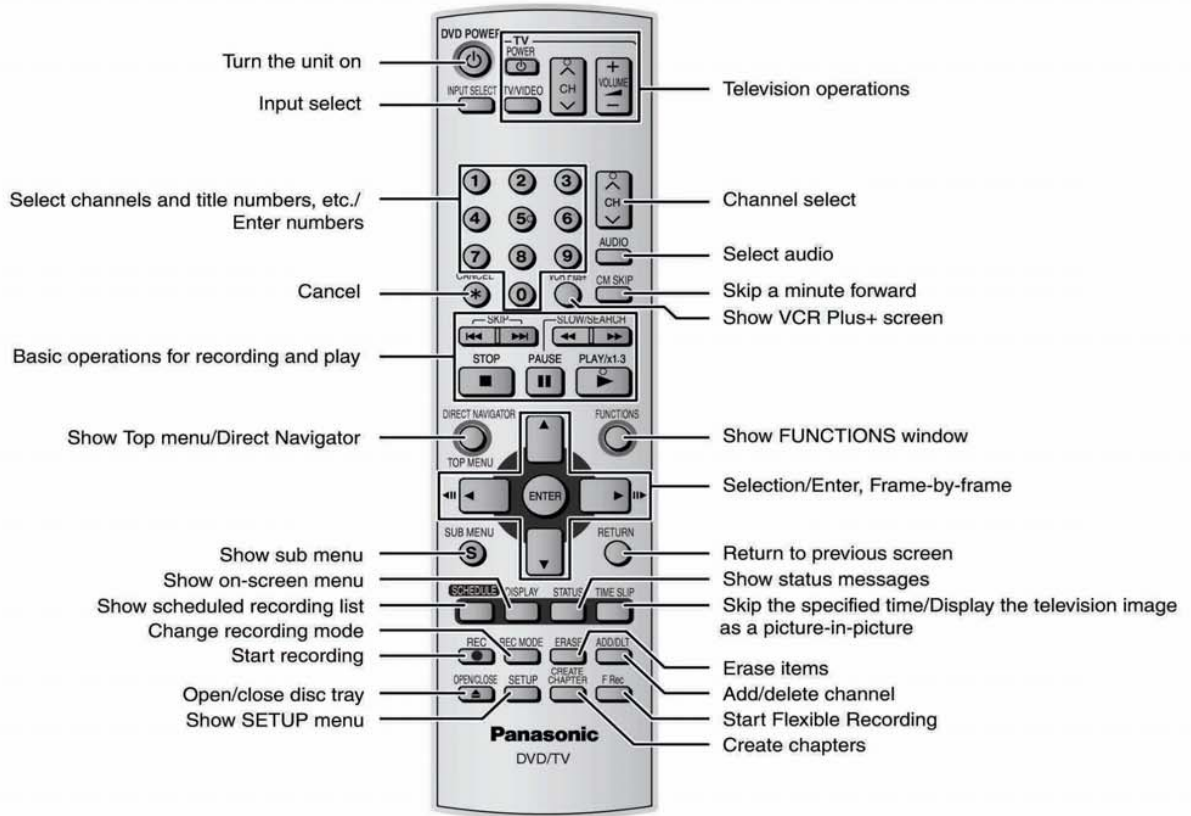

Main unit

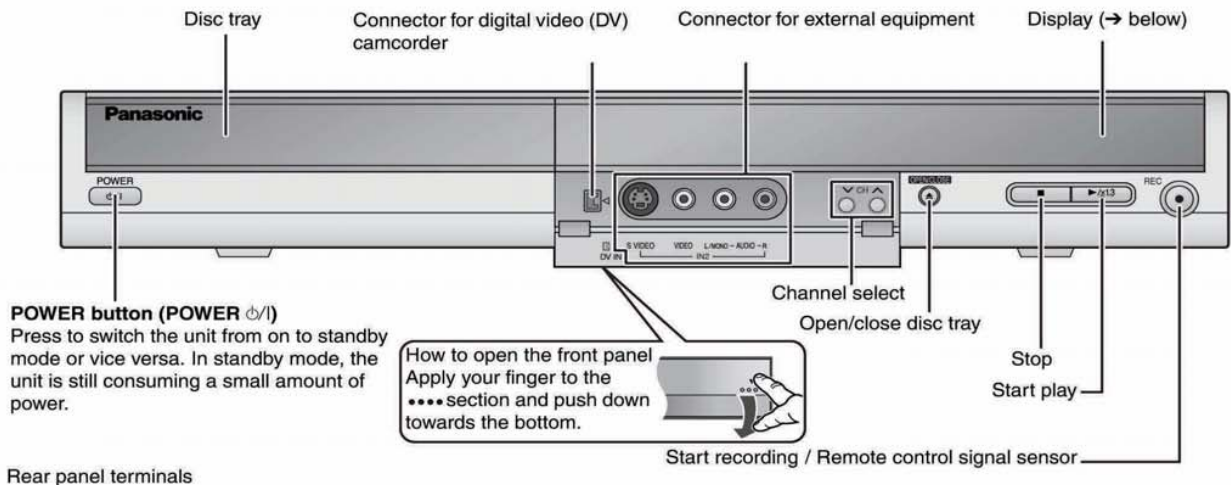

The unit's display

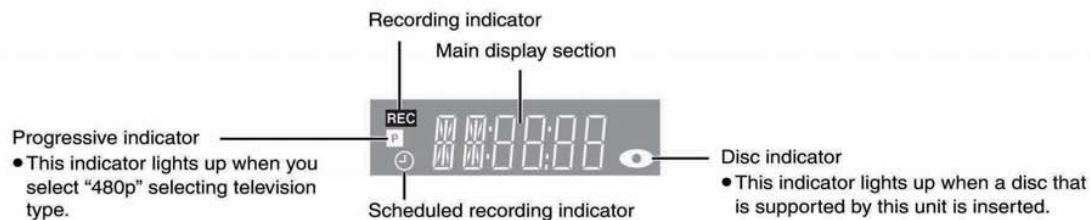

7 Operation Instructions

7.1. Taking out the Disc from RAM-Drive Unit when the Disc cannot be ejected by OPEN/CLOSE button

7.1.1. Forcible Disc Eject

7.1.1.1. When the power can be turned off.

1. Turn off the power and press [STOP] [CH UP] keys on the front panel simultaneously for 5 seconds.

7.1.1.2. When the power can not be turned off.

1. Press [POWER] key on the front panel for over 10 seconds to turn off the power forcibly, and press [STOP] [CH UP] keys on the front panel simultaneously for 5 seconds.

7.1.2. When the Forcible Disc Eject can not be done.

1. Turn off the power and pull out AC cord.
2. Remove the Top Case.
3. Remove the Front Panel.
4. Remove 4 screws and Upper Base Unit from DVD-RAM Drive.
5. Take out the disc and put the Opener Roller on fully position for direction of Arrow.
6. Put the Upper Base Unit so that the Opener Roller is inserted into the groove.
7. Check Opener Roller is seen through the Opener position Checking Hole, and tighten 4 screws.

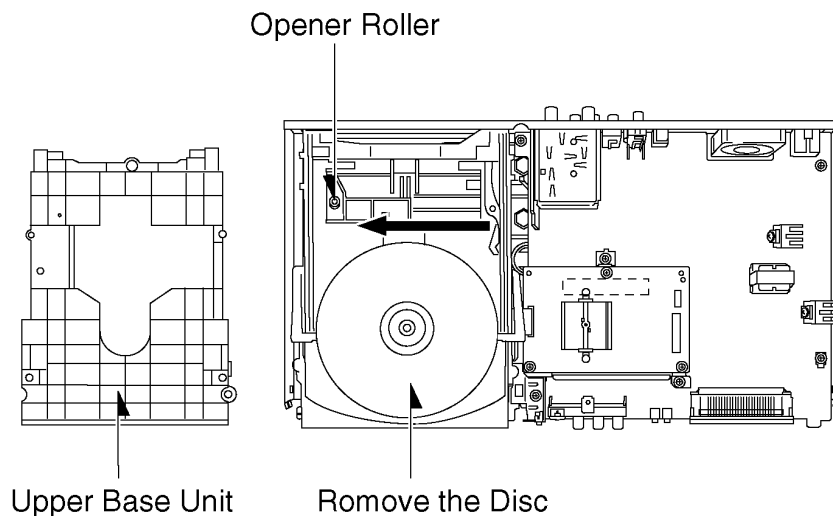
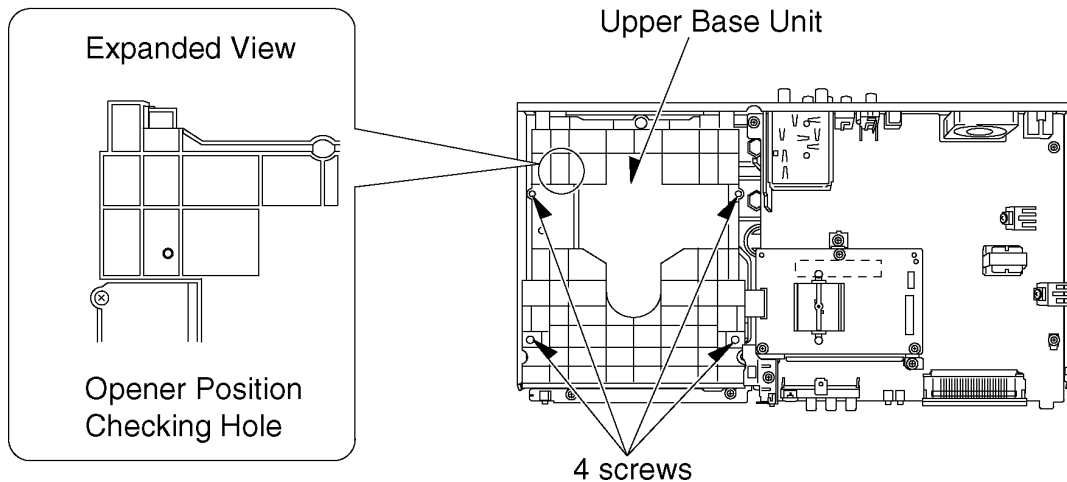

8 Service Mode

8.1. Self-Diagnosis and Special Mode Setting

8.1.1. Self-Diagnosis Functions

Self-Diagnosis Function provides information for errors to service personnel by “Self-Diagnosis Display” when any error has occurred.

U, H** and F** are stored in memory and held.**



You can check latest error code by transmitting [0] [1] of Remote Controller in Service Mode.

Automatic Display on FL will be cancelled when the power is turned off or AC input is turned off during self-diagnosis display is ON.

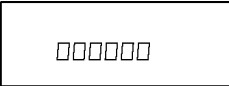
Error Code	Diagnosis contents	Description	Monitor Display	Automatic FL display
U30	Remote control code error	Display appears when main unit and remote controller codes are not matched.	No display	<div style="border: 1px solid black; padding: 5px; width: fit-content; margin: 0 auto;">RC *</div> <p>“*” is remote controller code of the main unit. Display for 5 seconds.</p>
U59	Abnormal inner temperature detected	Display appears when the drive temperature exceeds 70°C. The power is turned off forcibly. For 30 minutes after this, all key entries are disabled. (Fan motor operates at the highest speed for the first 5 minutes. For the remaining 25 minutes, fan motor is also stopped.) The event is saved in memory as well.	No display	<div style="border: 1px solid black; padding: 5px; width: fit-content; margin: 0 auto;">U59</div> <p>“U59 is displayed for 30 minutes.</p>
U99	Hang-up	Displayed when communication error has occurred between Main microprocessor and Timer microprocessor.	No display	<div style="border: 1px solid black; padding: 5px; width: fit-content; margin: 0 auto;">U99</div> <p>Displayed is left until the [POWER] key is pressed.</p>
F00	No error information	Initial setting for error code in memory (Error code Initialization is possible with error code initialization and main unit initialization.)	No display	No display
F58	Drive hardware error	When drive unit error is detected, the event is saved in memory.	No display	No display
F34	Initialization error when main microprocessor is started up for program recording	When initialization error is detected after starting up main microprocessor for program recording, the power is turned off automatically. The event is saved in memory.	No display	No display
UNSUPPORT	Unsupported disc error	*An unsupported format disc was played, although the drive starts normally. *The data format is not supported, although the media type is supported. *Exceptionally in case of the disc is dirty.	“This disc is incompatible.”	<div style="border: 1px solid black; padding: 5px; width: fit-content; margin: 0 auto;">Err</div> <p>Display for 5 seconds.</p>
NO READ	Disc read error	*A disc is flawed or dirty. *A poor quality failed to start. *The track information could not be read.		
HARD ERR	Drive error	The drive detected a hard error.	No display	<p>Display for 5 seconds.</p> <div style="border: 1px solid black; padding: 5px; width: fit-content; margin: 0 auto;">Err</div>
SELF CHECK	Restoration operation	Since the power cord fell out during a power failure or operation, it is under restoration operation. *It will OK, if a display disappears automatically. If a display does not disappear, there is the possibility that defective Digital P.C.B. / RAM drive.	No display	<div style="border: 1px solid black; padding: 5px; width: fit-content; margin: 0 auto;">□□□□□□</div>
UNFORMAT	Unformatted disc error	You have inserted an unformatted DVD-RAM or DVD-RW that is unformatted or recorded on other equipment.	This disc is not formatted properly. Do you want to format the disc in Disc Management?	<div style="border: 1px solid black; padding: 5px; width: fit-content; margin: 0 auto;">Err</div>

Error Code	Diagnosis contents	Description	Monitor Display	Automatic FL display
PLEASE WAIT	Unit is in termination process	Unit is in termination process now. "BYE" is displayed and power will be turned off. In case "Quick Start" of setup menu is ON, it is displayed in restoration operation for AC off.	No display	

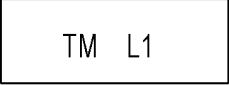

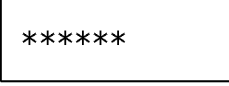

8.1.2. Special Modes Setting

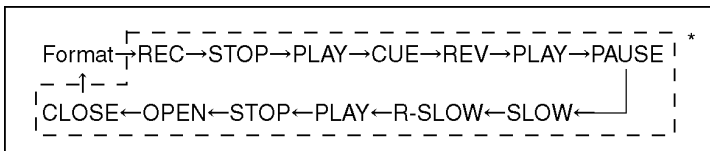
Item		FL display	Key operation
Mode name	Description		Front Key
TEST Mode	*All the main unit's parameters (include tuner) are initialized.		Press [STOP], [CH UP] and [OPEN/CLOSE] keys simultaneously for five seconds when power is off.
Service Mode	Setting every kind of modes for servicing. *Details are described in "8.1.3. Service Mode at a glance".		When the power is off, press [CH UP], [OPEN/CLOSE] and [REC] keys simultaneously for 5 seconds.
Forced disc eject	Removing a disc that cannot be ejected. The tray will open and unit will shift to P-off mode. *When Timer REC is ON, execute " Forced disc eject " after releasing Timer REC. While Demonstration Lock is being set, this Forced disc eject function is not accepted. <div style="border: 1px solid black; padding: 2px; width: fit-content;">If this command was executed while TIMER REC is being set, TIMER REC setting will turn to OFF.</div>	The display before execution leaves. 	When the power is off, press [STOP] and [CH UP] keys simultaneously for 5 seconds.
Forced power-off	When the power button is not effective while power is ON, turn off the power forcibly. *When Timer REC is ON, execute "Forced Power-off" after releasing Timer REC.	Display in P-off mode.	Press [Power] key over than 10 seconds.
Aging	Perform sequence of modes as * Aging Description shown below continually. <div style="border: 1px solid black; padding: 2px; width: fit-content;">Caution: All programs in DVD-RAM disc will be deleted because Formatting is done once in Aging process.</div>	Display following the then mode.	When the power is ON, press [STOP], [POWER] and [OPEN/CLOSE] simultaneously for over 5 seconds and less than 10 seconds. NOTE1: If Unit has not turned into Aging mode by operations shown above, execute TEST MODE once and re-execute operation shown above. (*All the main unit's parameters include tuner are initialized by TEST mode.) NOTE2: If the unit has hung-up because of pressing keys for over 10 seconds, once turn off the power, and re-execute this command. *When releasing Aging mode, press [POWER] key.

Aging Contents (Example):



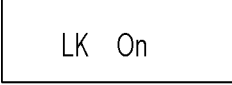







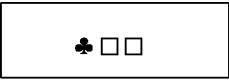
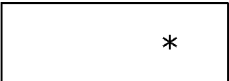



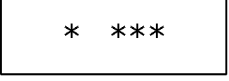
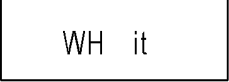

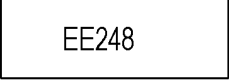
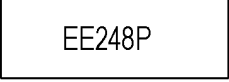

- *XP mode repeat twice
- SP mode repeat 4 times
- LP mode repeat 8 times
- EP mode repeat 12 times

Item		FL display	Key operation
Mode name	Description		Front Key
Demonstration lock/unlock	Ejection of the disc is prohibited. The lock setting is effective until unlocking the tray and not released by "Main unit initialization" of service mode.	*When lock the tray.  "LOCK" is displayed for 3 seconds.	When the power is on, press [STOP] and [POWER] keys simultaneously for 5 seconds.
		*When unlock the tray.  "UNLOCK" is displayed for 3 seconds.	When the power is on, press [STOP] and [POWER] keys simultaneously for 5 seconds.
		*When press OPEN/CLOSE key while the tray being locked.  Display "LOCK" for 3 seconds.	Press [OPEN/CLOSE] key while the tray being locked.
ATP Initialization	ATP setting is initialized, and the unit turns off automatically.	It is same with display in stop mode. 	When the power is on (E-E mode), press [CH UP] and [CH DOWN] simultaneously for 5 seconds.
Progressive initialization	The progressive setting is initialized to Interface.	The display before execution leaves. 	When the power is on (E-E mode), press [STOP] and [PLAY] simultaneously for 5 seconds.

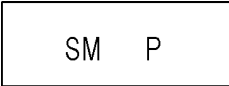
8.1.3. Service Modes at a glance

Service mode setting: While the power is off, press **REC**, **CH UP** and **OPEN / CLOSE** simultaneously for five seconds.

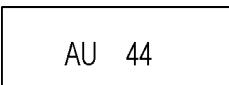
Mode name	Item Description	FL display	Key operation (Remote controller key)
Release Items	Item of Service Mode executing is cancelled.	SM	Press [0] [0] or [Return] in service mode.
Error Code Display	Last Error Code of U/H/F held by Timer is displayed on FL. *Details are described in "8.1.1. Self-Diagnosis Functions".	 * ♣ shows U/H/F. □□ shows number.	Press [0] [1] in service mode
ROM Version Display	Region code, MAIN firm version, TIMER firm version and DRIVE firmware versions are displayed on FL for five seconds per each version in order, but ROM version will be left displayed.	Region code  MAIN firm version  TIMER firm version  DRIVE firm version  ROM version  " * " are version displays.	Press [0] [2] in service mode
White Picture Output	White picture is output as component Output from AV Decoder. *White picture (Saturation rate : 100%) *It is enable to switch Interlace/Progressive by "I/P switch: [1] [4]"	*Initial mode is "Interlace". 	Press [1] [1] in service mode.
		Switch Interlace/Progressive 	Press [1] [4] in White Picture Output mode. *I/P are switched alternately.
Magenta Picture Output	Magenta picture is output with Component Output from AV Decoder. *Magenta picture (Saturation rate: 100%) *It is enable to switch Interlace/Progressive by "I/P switch: [1] [4]"	*Initial mode is "Interlace". 	Press [1] [2] in service mode.
		Switch Interlace/Progressive 	Press [1] [4] in Magenta Picture Output mode. *I/P are switched alternately.
RTSC Return in XP (A & V)	L1 input signal is encoded (XP), decoded (XP) and output decoded signal to external without DISC recording and DISC playback.	Initial mode: EE2/ Interlace/ XP/ Audio 48kHz 	Press [1] [3] in service mode.
		Switch Interlace/Progressive 	Press [1] [4] in RTSC Return XP mode. *I/P are switched alternately.

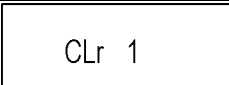
Item		FL display	Key operation
Mode name	Description		(Remote controller key)
I/P Switch	Switch Interlace and Progressive in EE mode. *Initial setting is "Interlace". *This command is effective during executing "White Picture Output", "Magenta Picture Output" and "RTSC Return in XP (A & V)" modes.	Initial mode is Interlace  Switch Interlace/Progressive 	Press [1] [4] in I/P Switch mode. *I/P are switched alternately.
Audio Mute (XTMUTE)	Check whether mute is applied normally by the timer microprocessor.		Press [2] [1] in service mode.
Audio Mute (XDMUTE)	Check whether mute is applied normally by the Digital P.C.B..		Press [2] [2] in service mode.
Audio Pattern Output	The audio pattern stored in the internal memory is output (Lch: 1kHz/-18dB) (Rch: 400Hz/-18dB) *Audio sound clock switching operation of DAC can be confirmed by sub command [2] [4].	Initial mode (Audio 48kHz)  Audio 44.1kHz/48kHz switching 	Press [2] [3] in service mode. Press [2] [4] in Audio Pattern Output mode. *48 kHz / 44.1 kHz are switched alternately.
Laser Used Time Indication	Check laser used time (hours) of drive.	 I(*****) is the used time display in hour. ILaser used time of DVD/ CD in Playback/Recording mode is counted.	Press [4] [1] in service mode.
Delete the Laser Used Time	Laser used time stored in the memory of the unit is deleted.		Press [9] [5] in service mode.

Item		FL display	Key operation
Mode name	Description		(Remote controller key)
RAM Drive Last Error	RAM Drive error code display. *For details about the drive error code, refer to the Service Manual for the specific RAM Drive. *Details are described in "3.3. Confirm "RAM-Drive Last Error" in Service Mode".	<p>1. Error Number is displayed for 5 seconds.</p> <div style="border: 1px solid black; padding: 5px; text-align: center;">NO **</div> <p>2. Time when the error has occurred (1/2) is displayed for 5 seconds.</p> <div style="border: 1px solid black; padding: 5px; text-align: center;">YYMMDD</div> <p>YY: Year MM: Month DD: Day</p> <p>3. Time when the error has occurred (2/2) is displayed for 5 seconds.</p> <div style="border: 1px solid black; padding: 5px; text-align: center;">hhmmss</div> <p>hh: Hour mm: Minute ss: Second</p> <p>4. Last Drive Error code No.1 is displayed for 5 seconds.</p> <div style="border: 1px solid black; padding: 5px; text-align: center;">*****</div> <p>5. Last Drive Error code No.2 (1/2) is displayed for 5 seconds.</p> <div style="border: 1px solid black; padding: 5px; text-align: center;">****</div> <p>6. Last Drive Error code No.2 (2/2) is displayed for 5 seconds.</p> <div style="border: 1px solid black; padding: 5px; text-align: center;">****</div> <p>7. Error occurring Disc type is displayed for 5 seconds.</p> <div style="border: 1px solid black; padding: 5px; text-align: center;">DISC *</div> <p>DISC 1: DVD DISC 2: CD DISC 3: DVD-RAM 2.6GB DISC 4: DVD-RAM 4.7GB DISC 5: DVD-R DISC : Unknown Disc</p> <p>8. Unused (No display)</p> <div style="border: 1px solid black; padding: 5px; text-align: center;"> </div> <p>9. Factor of Drive Error occurring is left displayed</p> <div style="border: 1px solid black; padding: 5px; text-align: center;">*****</div>	Press [4] [2] in service mode. When "INFO*****" is being displayed, past 99 error histories can be displayed by pressing [0] [1] - [9] [9]
Delete the Last Drive Error	Delete the Last Drive Error information stored on the DVD RAM-Drive.	<div style="border: 1px solid black; padding: 5px; text-align: center;">CLr 2</div>	Press [9] [6] in service mode.
Turn on all FL/LEDs	All segments of FL and all LEDs are turned on.	All segments are turned on.	Press [5] [1] in service mode.

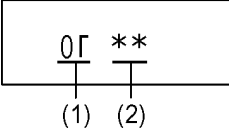
Item		FL display	Key operation
Mode name	Description		(Remote controller key)
S1 signal output	Forcibly superimpose the S1 signal (approx. 4.5V DC) on the EE chroma signal, and check the output on the S terminal.	S1	Press [5] [2] in service mode.
S2 signal output	Forcibly superimpose the S2 signal (approx. 2V DC) on the EE chroma signal, and check the output on the S terminal.	S2	Press [5] [3] in service mode.
Front connection inspection	Press all front keys and check the connection between Main P.C.B. and Front key Switches.	<div style="text-align: center;">  <p>(1) (2)</p> </div> <p>(1) Each time a key is pressed, segment turned on increases one by one. (2) Total number of keys that have been pressed.</p>	Press [5] [4] in service mode.
Display the accumulated working time	Display the accumulated unit's working time.	***** (Indicating unit: hour)	Press [6] [4] in service mode.
Delete the Error History	Delete Error History information stored on the unit.	CLr 3	Press [9] [7] in service mode.
Tray OPEN/CLOSE Test	The RAM drive tray is opened and closed repeatedly.	***** ** is number of open/close cycle times.	Press [9] [1] in service mode *When releasing this mode, pull off AC plug.
Error code initialization	Initialization of the last error code held by timer (Write in F00)	CLr 4	Press [9] [8] in service mode.
Initialize Service	Last Drive Error, Error history and Error Codes stored on the unit are initialized to factory setting.	CLr S	Press [9] [9] in service mode.
Finishing service mode	Release Service Mode.	Display in STOP (E-E) mode. *****	Press power button on the front panel or Remote controller in service mode.

9 Service Fixture & Tools

Part Number	Description	Compatibility
RFKZ0125	Extension FFC (Digital P.C.B. - DVD-RAM Drive / 40 Pin)	Same as E50/ E55/ ES10 series
RFKZ0126	Extension Cable (MainP.C.B. - DVD-RAM Drive/ 4 Pin)	Same as E30/ HS2/ ES10 series
RFKZ0260	Extension Cable (MainP.C.B. - Digital P.C.B. / 88 Pin)	Same as ES10 series

10 Disassembly and Assembly Instructions

10.1. Disassembly Flow Chart

The following chart is the procedure for disassembling the casing and inside parts for internal inspection when carrying out the servicing.

To assemble the unit, reverse the steps shown in the chart below.

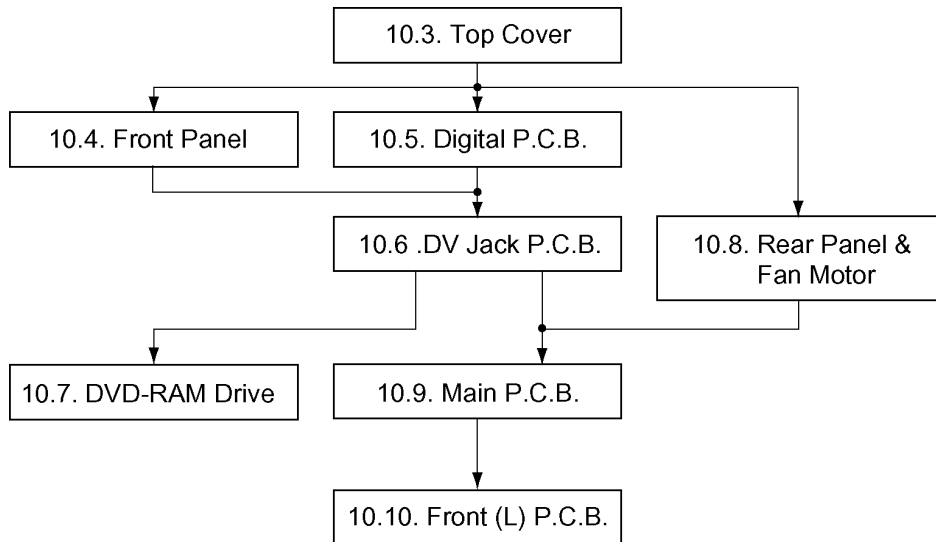

10.2. P.C.B. Positions

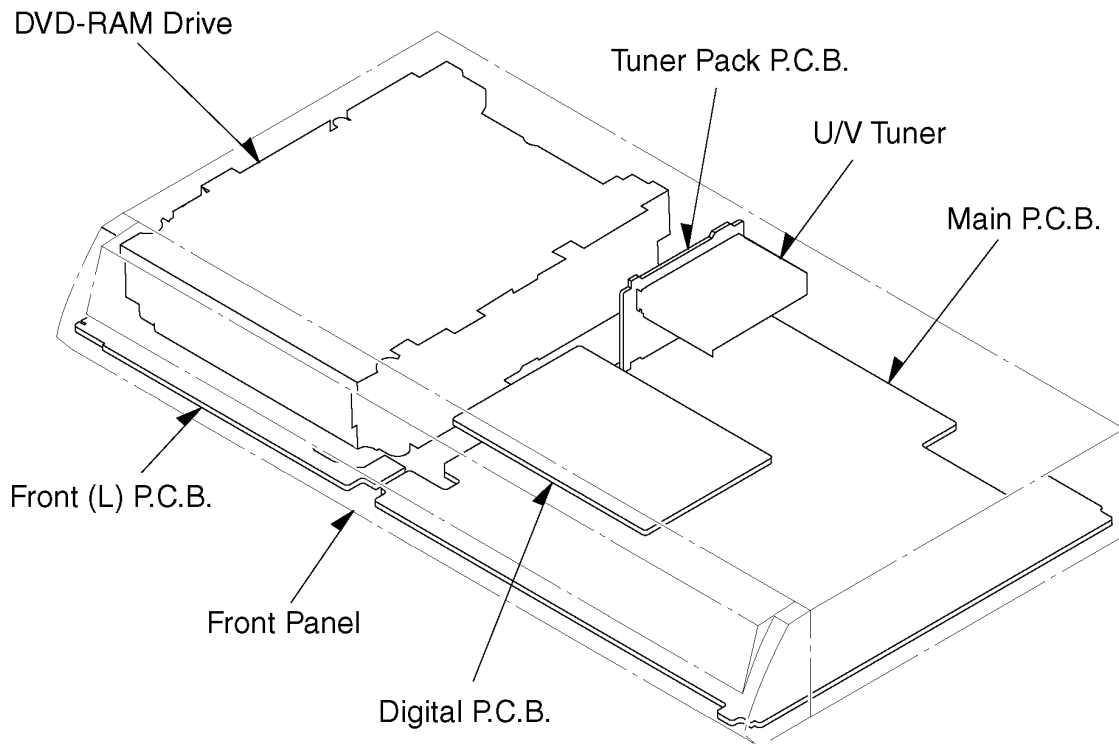

10.3. Top Cover

1. Remove the 2 Screws (A) and 3 Screws (B).
2. Slide Top Cover rearward and open the both ends at rear side of the Top Cover a little and lift the Top Cover in the Direction of the arrows.

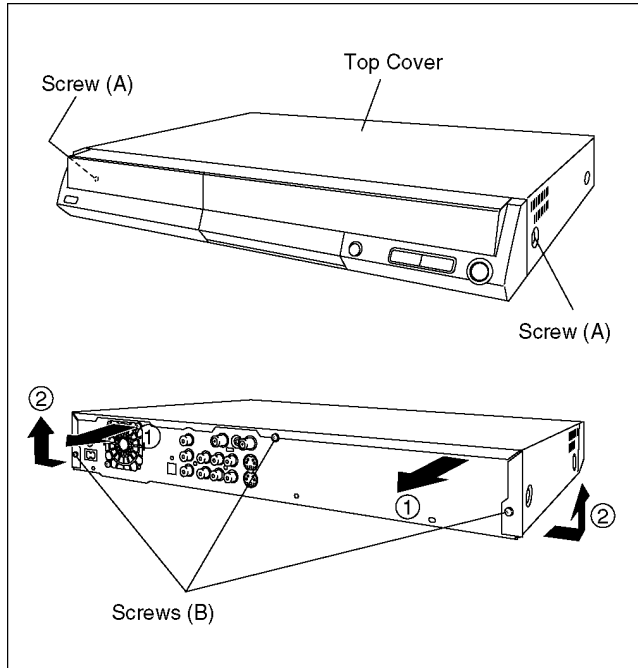

10.4. Front Panel

1. Unlock 3 tabs (A) and 2 tabs (B) in this order to remove Front Panel.
(The tab (A) and (B) should be unlocked at the same time, respectively.)

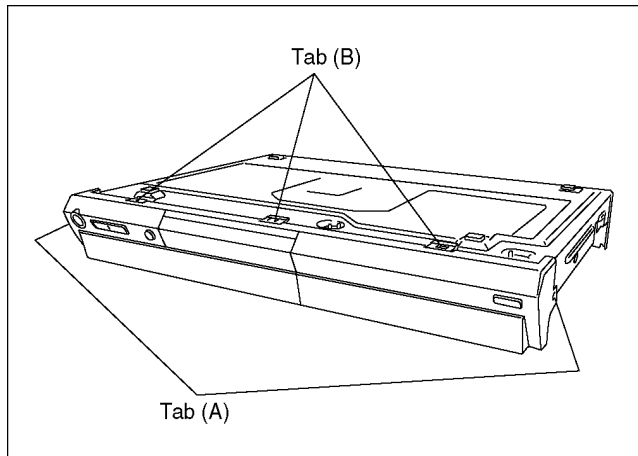

10.5. Digital P.C.B.

1. Remove FFC and 3 Screws (A).
2. Lift up Digital P.C.B. slightly so to disconnect 2 Connectors to remove Digital P.C.B.

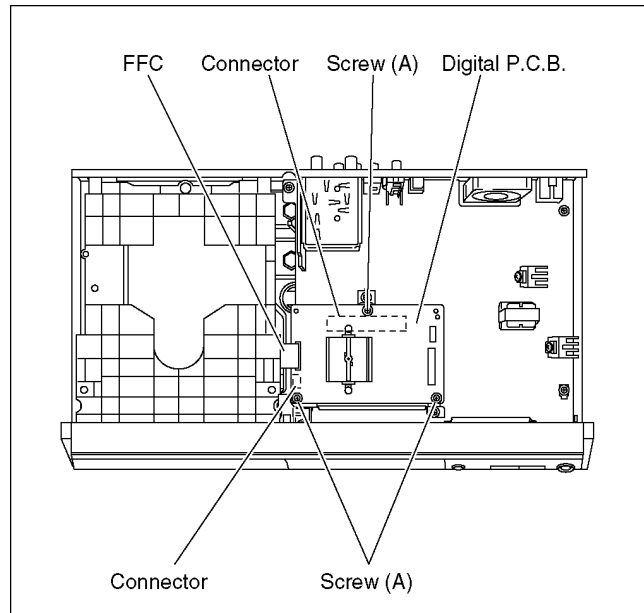

CAUTION 1:

When replacing Digital P.C.B., pay attention as below.

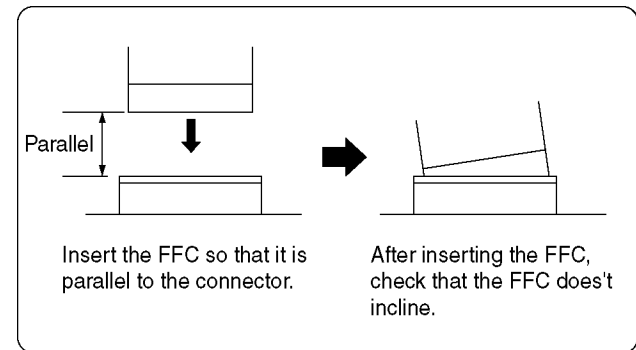

CAUTION 2:

Be careful to do not touch surface of CSP ICs.
If you have touched surface of CSP IC, clean up with alcohol and so on to prevent oxidation.

10.5.1. Removing and attaching Heat Sink Unit for IC5001

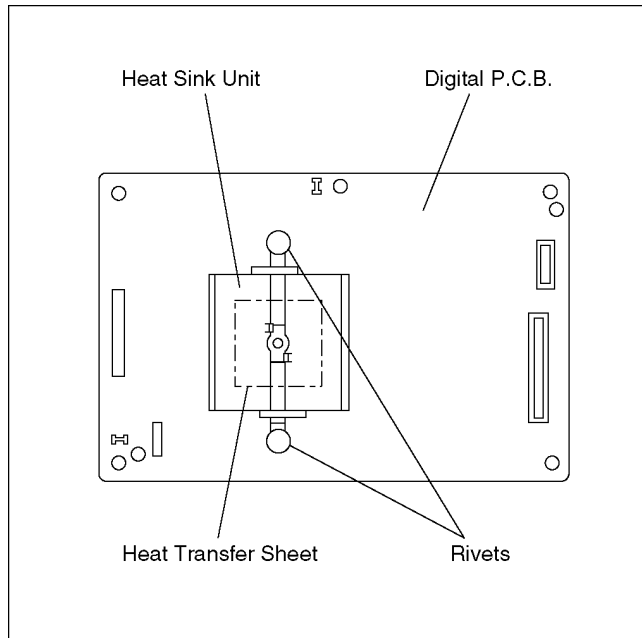

(Removing)

1. Push Rivets by finger as shown below.
2. Pull off Pin of Rivets.

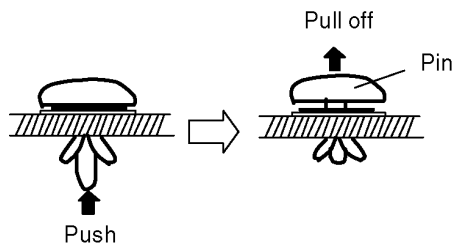

3. Remove Heat Sink Unit.
4. Remove Heat Transfer Sheet.

(Attaching)

1. Paste Heat Transfer Sheet on to IC5001.
2. Put Heat Sink Unit on to Heat Transfer Sheet.
3. Insert Housing of rivets through Spring of Heat sink Unit as shown below.
4. Insert Pin of Rivets.

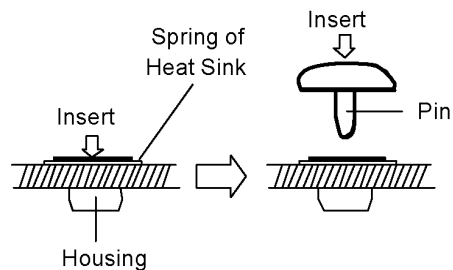

10.6. DV Javk P.C.B.

1. Remove 2 Screws (A) to remove SD Card Angle with DV Jack P.C.B.

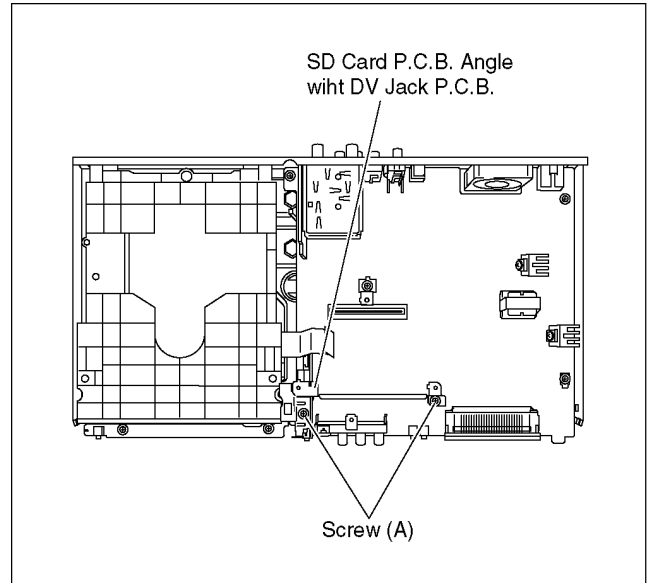

10.7. DVD-RAM Drive

1. Remove 3 Screws (A) to remove DVD-RAM Drive.
2. Lift up DVD-RAM Drive slightly and remove Cable between DVD-RAM Drive and Main P.C.B.

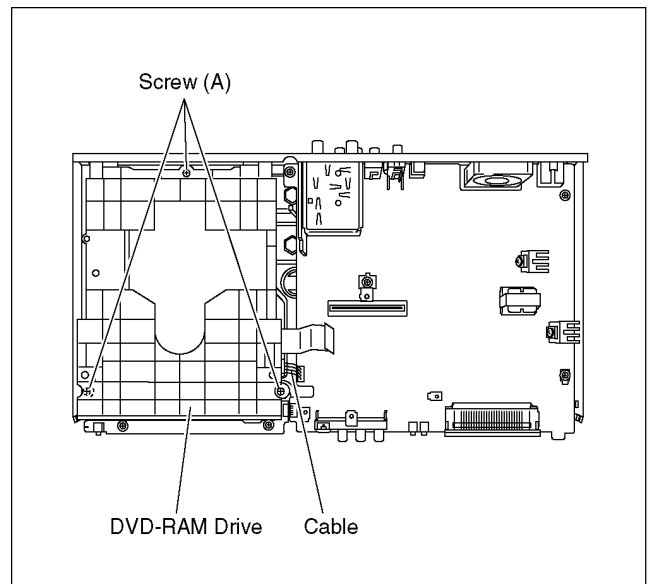

10.8. Rear Panel & Fan Motor

10.8.1. Rear Panel with Fan Motor

1. Disconnect Fan Connector.

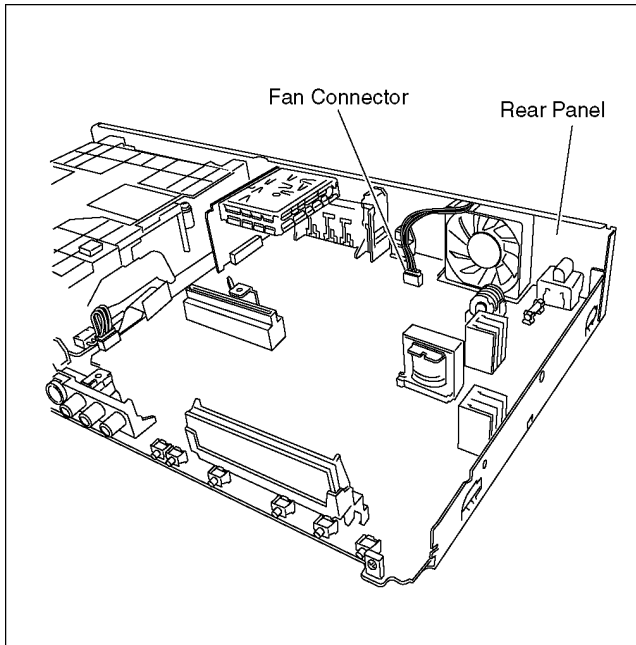

2. Remove 5 Screws (A) and 1 Screw (B).

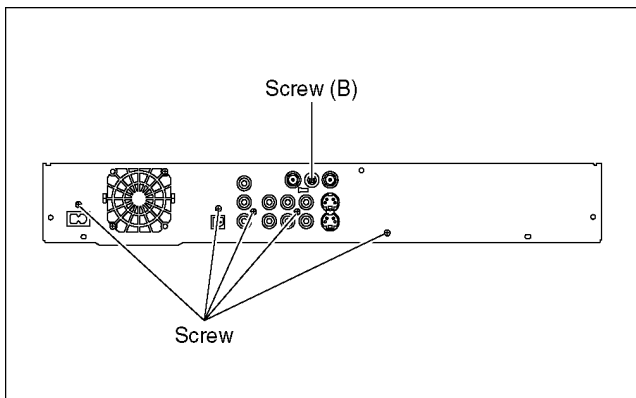

3. Unlock 2 Locking Tabs (A) to remove Rear Panel.

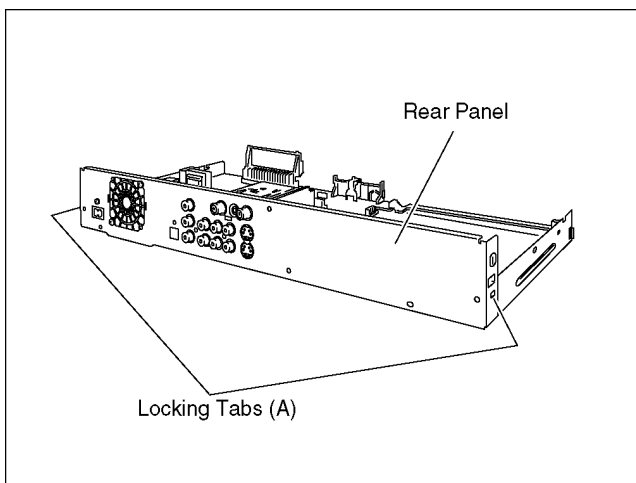

10.8.2. Only Fan Motor

1. Disconnect Fan Connector.

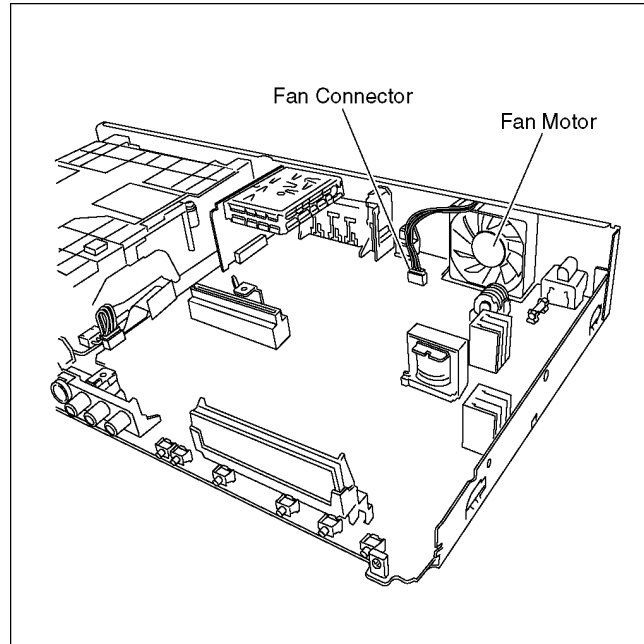

2. Remove 2 Screws (A) to Remove Fan Motor.

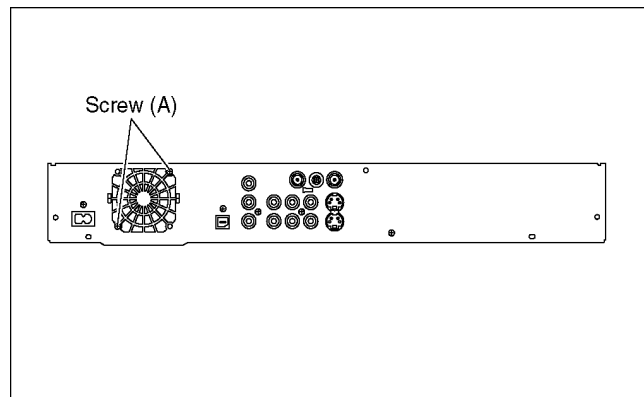

10.9. Main P.C.B.

1. Disconnect Connector (A) for Front (L) P.C.B.
2. Remove 4 Screws (A).
3. Remove Digital P.C.B. Angle to remove Main P.C.B.

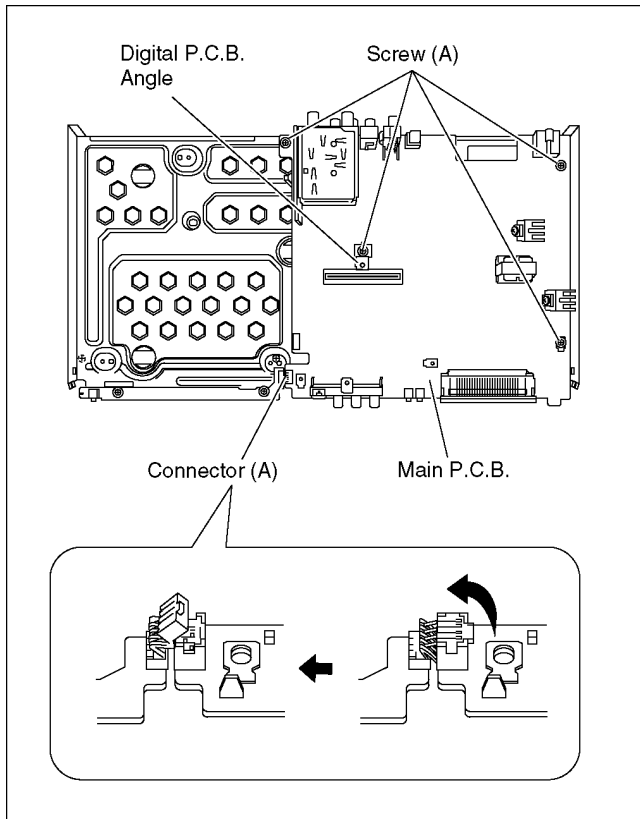

10.10. Front (L) P.C.B.

1. Remove 2 Screws (A).
2. Front (L) P.C.B. is removed in the direction of the arrow.

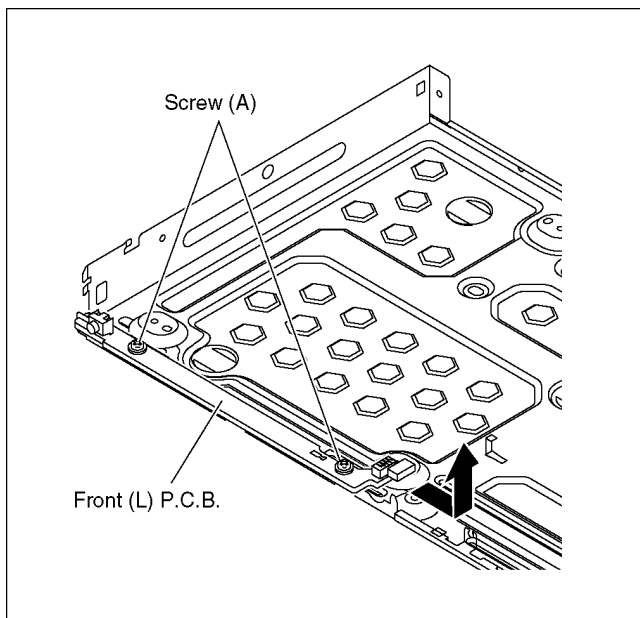

11 Measurements and Adjustments

11.1. Service Positions

Note:

For description of the disassembling procedure, see the section 10.

11.1.1. Checking and Repairing of Digital P.C.B.

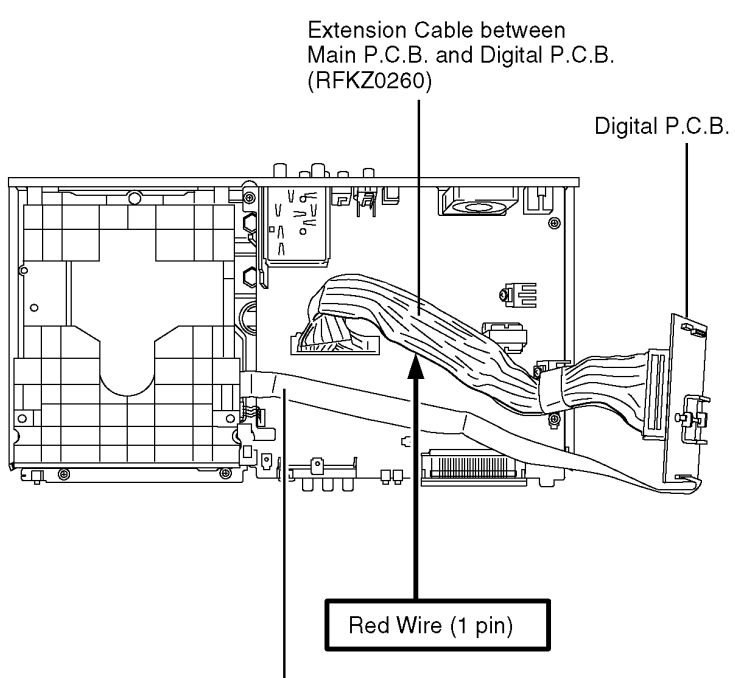
<p>1. Top Case</p> <p>Remove 2 Screws (A) on side</p> <p>Remove 3 rear Screws (B) on rear</p> <p>Remove Top Case</p> <p>↓</p> <p>2. Front Panel</p> <p>Unlock 2 Locking Tabs on side</p> <p>Unlock 3 Locking Tabs on bottom</p> <p>Remove Front Panel</p> <p>↓</p> <p>3. Digital P.C.B.</p> <p>Remove FFC from Digital P.C.B.</p> <p>Remove 3 Screws fixing Digital P.C.B.</p> <p>Lift up Digital P.C.B. to remove it</p> <p>↓</p> <p>4. SD Card P.C.B. Angle with DV Jack P.C.B.</p> <p>Remove 2 Screws to remove SD Card P.C.B. Angle with DV Jack and remove FFC from DVD RAM Drive.</p> <p>↓</p> <p>Remove 3 Screws fixing RAM Drive. Lift up DVD-RAM Drive slightly and connect Extension Cables between DVD-RAM Drive and Digital P.C.B. (RFKZ0125). Connect Extension Cable between Main P.C.B. and Digital P.C.B. (RFKZ0260).</p>	<p>Caution: Red wire in the extension cable should be connected to (1) pin.</p>  <p>Extension Cable between Main P.C.B. and Digital P.C.B. (RFKZ0260)</p> <p>Digital P.C.B.</p> <p>Red Wire (1 pin)</p> <p>Extension Cable between Digital P.C.B. and DVD-RAM Drive (RFKZ0125)</p>
---	--

11.1.2. Checking and Repairing of Main P.C.B.

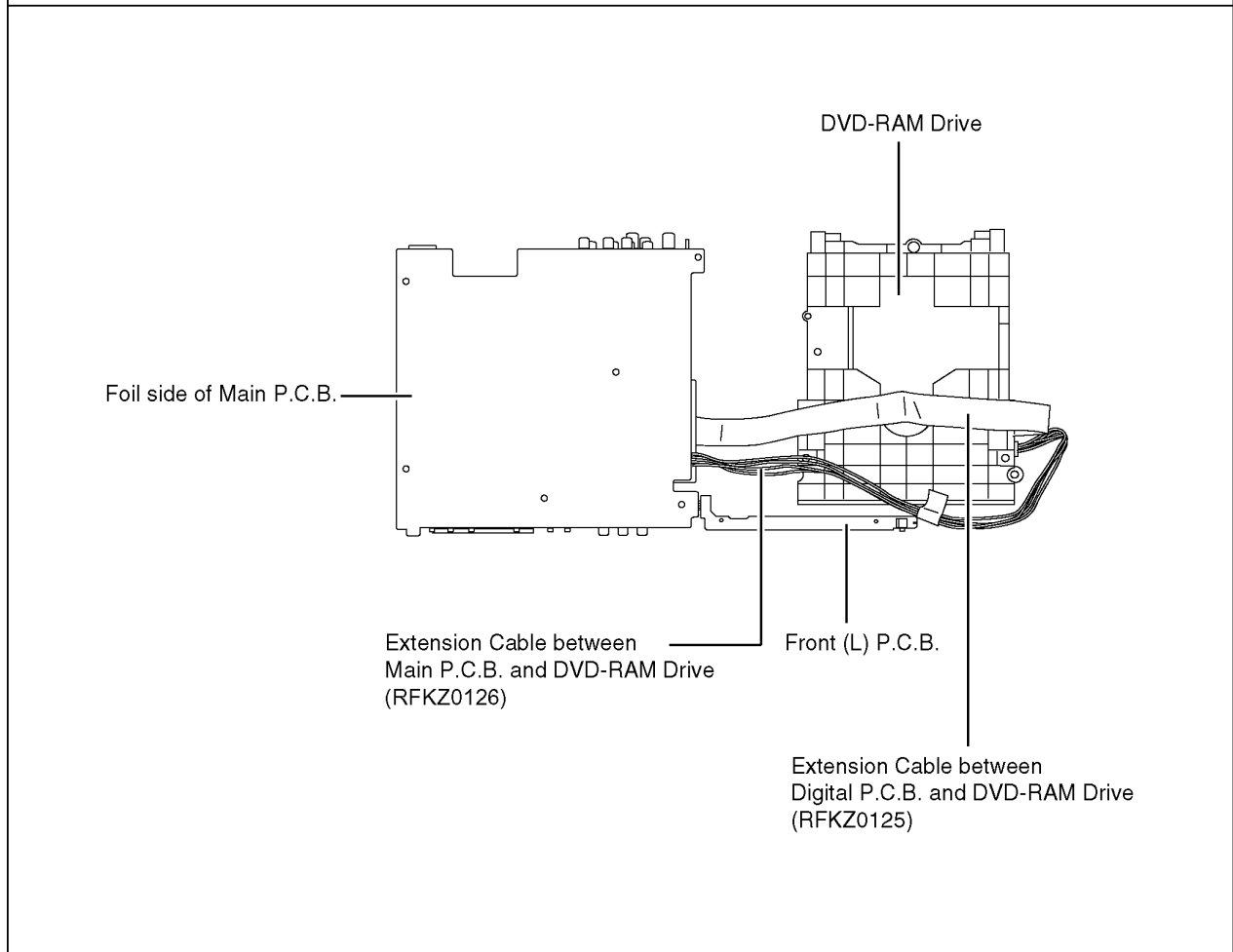
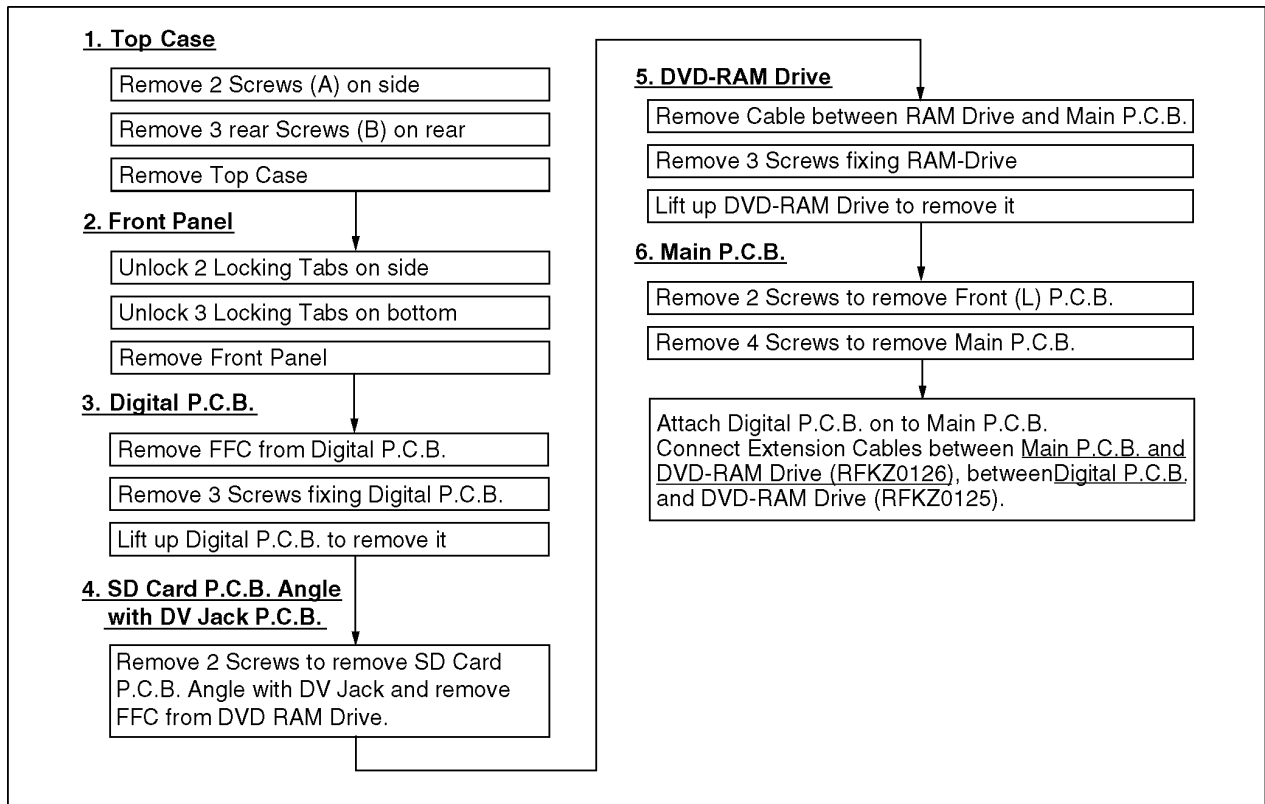

11.1.3. Checking and Repairing of DVD-RAM Drive

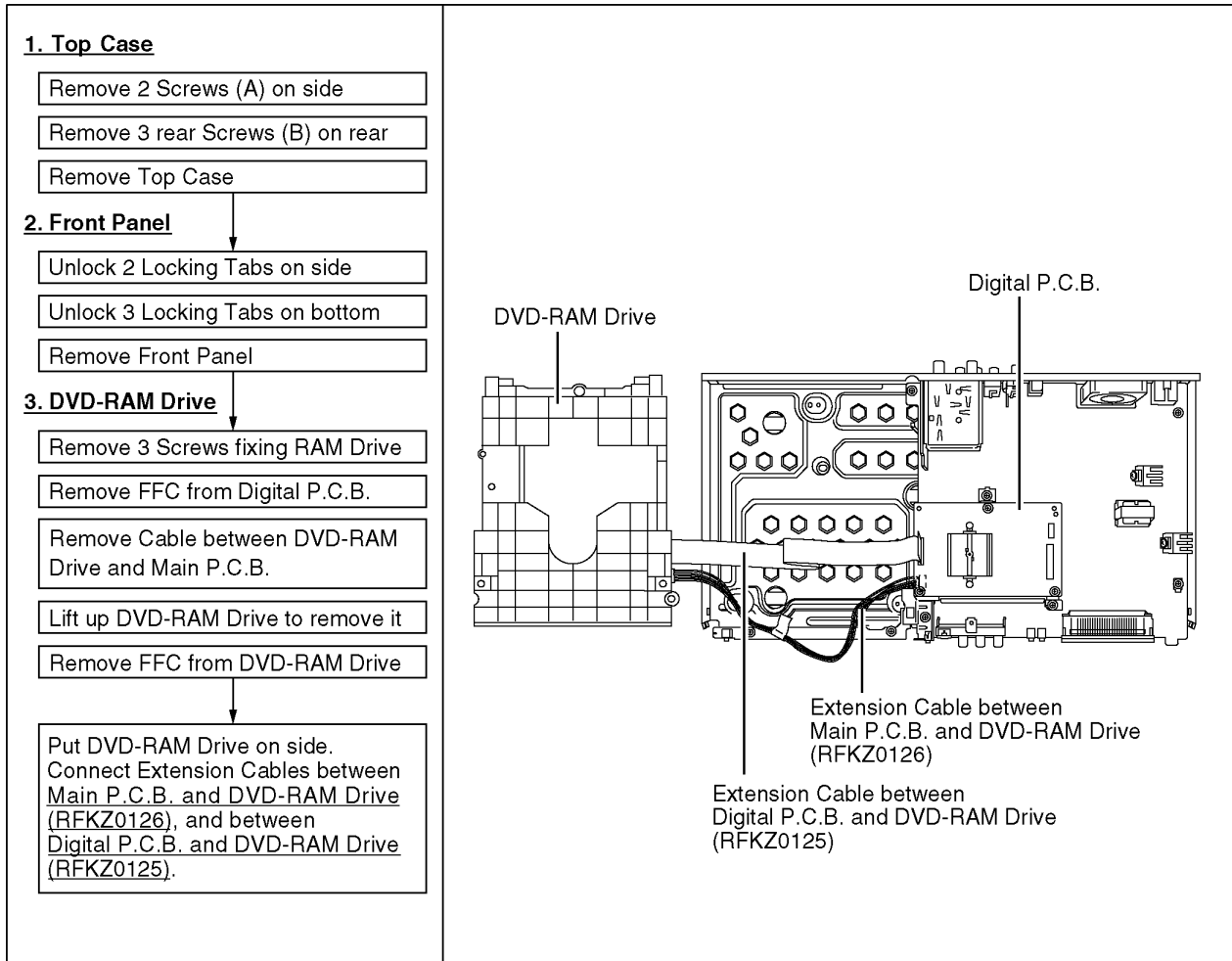

11.2. After replacing the RAM Drive with new one

After replacing RAM drive unit, TEST mode is not necessary. Please confirm operation for RAM drive

11.3. When the unit does not operate normally after replacing the Timer Microprocessor or Main P.C.B.

When the unit does not operate normally after replacing the Timer Microprocessor or Main P.C.B. with new one, reset Timer Microprocessor.

Step	Operation	Descriptions
1	While power is OFF, short IC7502-4 pin (RESET) and the GND momentarily.	"RESET (L)" is transmitted to the NRST of Timer Microprocessor (IC7505-15 pin), then the unit operates normally.

11.4. Standard Inspection Specifications after Making Repairs

After making repairs, we recommend performing the following inspection, to check normal operation.

No.	Procedure	Item to Check
1	Turn on the power, and confirm items pointed out.	Items pointed out should reappear.
2	Insert RAM disc.	The Panasonic RAM disc should be recognized.
3	Enter the EE (TU IN / AV IN - AV OUT) mode.	No abnormality should be seen in the picture, sound or operation.
4	Perform auto recording and playback for one minute using the RAM disc.	No abnormality should be seen in the picture, sound or operation. *Panasonic DVD-RAM disc should be used when recording and playback.
5	If a problem is caused by a VCD, DVD-R, DVD-Video, Audio-CD, or MP3, playback the test disc.	No abnormality should be seen in the picture, sound or operation.
6	After checking and making repairs, upgrade the firmware to the latest version.	Make sure that [FIRM_SUCCESS] appears in the FL displays. *[UNSUPPORT] display means the unit is already updated to newest same version. Then version up is not necessary.
7	Transfer [9][9] in the service mode setting, and initialize the service settings (return various settings and error information to their default values. The laser time is not included in this initialization).	Make sure that [CLr S] appears in the FL display. After checking it, turn the power off.
8	When replacing of RAM drive, transfer [9] [5] in the service mode setting to delete Laser used time.	Make sure that [CLr 1] appears in the FL display. After that, turn power off.

Use the following checklist to establish the judgement criteria for the picture and sound.

Item	Contents	Check	Item	Contents	Check
Picture	Block noise		Sound	Distorted sound	
	Crosscut noise			Noise (static, background noise, etc.)	
	Dot noise			The sound level is too low.	
	Picture disruption			The sound level is too high.	
	Not bright enough			The sound level changes.	
	Too bright				
	Flickering color				
Color fading					

12 Miscellaneous

12.1. Abbreviations

INITIAL/LOGO		ABBREVIATIONS
A	A0~UP	ADDRESS
	ACLK	AUDIO CLOCK
	AD0~UP	ADDRESS BUS
	ADATA	AUDIO PES PACKET DATA
	ALE	ADDRESS LATCH ENABLE
	AMUTE	AUDIO MUTE
	AREQ	AUDIO PES PACKET REQUEST
	ARF	AUDIO RF
	ASI	SERVO AMP INVERTED INPUT
	ASO	SERVO AMP OUTPUT
	ASYNC	AUDIO WORD DISTINCTION SYNC
	B	BCK
BCKIN		BIT CLOCK INPUT
BDO		BLACK DROP OUT
BLKCK		SUB CODE BLOCK CLOCK
BOTTOM		CAP. FOR BOTTOM HOLD
BYP		BYPATH
BYTCK	BYTE CLOCK	
C	CAV	CONSTANT ANGULAR VELOCITY
	CBDO	CAP. BLACK DROP OUT
	CD	COMPACT DISC
	CDSCK	CD SERIAL DATA CLOCK
	CDSRDATA	CD SERIAL DATA
	CDRF	CD RF (EFM) SIGNAL
	CDV	COMPACT DISC-VIDEO
	CHNDATA	CHANNEL DATA
	CKSL	SYSTEM CLOCK SELECT
	CLV	CONSTANT LINEAR VELOCITY
	COFTR	CAP. OFF TRACK
	CPA	CPU ADDRESS
	CPCS	CPU CHIP SELECT
	CPDT	CPU DATA
	CPUADR	CPU ADDRESS LATCH
	CPUADT	CPU ADDRESS DATA BUS
	CPUIRQ	CPU INTERRUPT REQUEST
	CPRD	CPU READ ENABLE
	CPWR	CPU WRITE ENABLE
	CS	CHIP SELECT
	CSYNCIN	COMPOSITE SYNC IN
CSYNCOUT	COMPOSITE SYNC OUT	
D	DACCK	D/A CONVERTER CLOCK
	DEEMP	DEEMPHASIS BIT ON/OFF
	DEMPH	DEEMPHASIS SWITCHING
	DIG0~UP	FL DIGIT OUTPUT
	DIN	DATA INPUT
	DMSRCK	DM SERIAL DATA READ CLOCK
	DMUTE	DIGITAL MUTE CONTROL
	DO	DROP OUT
	DOUT0~UP	DATA OUTPUT
	DRF	DATA SLICE RF (BIAS)
	DRPOUT	DROP OUT SIGNAL
	DREQ	DATA REQUEST
	DRESP	DATA RESPONSE
	DSC	DIGITAL SERVO CONTROLLER
	DSLIF	DATA SLICE LOOP FILTER
	DVD	DIGITAL VIDEO DISC

INITIAL/LOGO		ABBREVIATIONS
E	EC	ERROR TORQUE CONTROL
	ECR	ERROR TORQUE CONTROL REFERENCE
	ENCSEL	ENCODER SELECT
	ETMCLK	EXTERNAL M CLOCK (81MHz/40.5MHz)
	ETSCLK	EXTERNAL S CLOCK (54MHz)
F	FBAL	FOCUS BALANCE
	FCLK	FRAME CLOCK
	FE	FOCUS ERROR
	FFI	FOCUS ERROR AMP INVERTED INPUT
	FEO	FOCUS ERROR AMP OUTPUT
	FG	FREQUENCY GENERATOR
	FSC	FREQUENCY SUB CARRIER
FSCK	FS (384 OVER SAMPLING) CLOCK	
G	GND	COMMON GROUNDING (EARTH)
H	HA0~UP	HOST ADDRESS
	HD0~UP	HOST DATA
	HINT	HOST INTERRUPT
	HRXW	HOST READ/WRITE
I	IECOUT	IEC958 FORMAT DATA OUTPUT
	IPFRAG	INTERPOLATION FLAG
	IREF	I (CURRENT) REFERENCE
	ISEL	INTERFACE MODE SELECT
L	LDON	LASER DIODE CONTROL
	LPC	LASER POWER CONTROL
	LRCK	L CH/R CH DISTINCTION CLOCK
M	MA0~UP	MEMORY ADDRESS
	MCK	MEMORY CLOCK
	MCKI	MEMORY CLOCK INPUT
	MCLK	MEMORY SERIAL COMMAND CLOCK
	MDATA	MEMORY SERIAL COMMAND DATA
	MDQ0~UP	MEMORY DATA INPUT/OUTPUT
	MDQM	MEMORY DATA I/O MASK
	MLD	MEMORY SERIAL COMMAND LOAD
MPEG	MOVING PICTURE EXPERTS GROUP	
O	ODC	OPTICAL DISC CONTROLLER
	OFTR	OFF TRACKING
	OSCI	OSCILLATOR INPUT
	OSCO	OSCILLATOR OUTPUT
	OSD	ON SCREEN DISPLAY
P	P1~UP	PORT
	PCD	CD TRACKING PHASE DIFFERENCE
	PCK	PLL CLOCK
	PDVD	DVD TRACKING PHASE DIFFERENCE
	PEAK	CAP. FOR PEAK HOLD
	PLLCLK	CHANNEL PLL CLOCK
	PLLOK	PLL LOCK
	PWMCTL	PWM OUTPUT CONTROL
	PWMDA	PULSE WAVE MOTOR DRIVE A
	PWMOA, B	PULSE WAVE MOTOR OUT A, B

INITIAL/LOGO		ABBREVIATIONS
R	RE	READ ENABLE
	RFENV	RF ENVELOPE
	RFO	RF PHASE DIFFERENCE OUTPUT
	RS	(CD-ROM) REGISTER SELECT
	RSEL	RF POLARITY SELECT
	RST	RESET
S	RSV	RESERVE
	SBI0, 1	SERIAL DATA INPUT
	SBO0	SERIAL DATA OUTPUT
	SBT0, 1	SERIAL CLOCK
	SCK	SERIAL DATA CLOCK
	SCKR	AUDIO SERIAL CLOCK RECEIVER
	SCL	SERIAL CLOCK
	SCLK	SERIAL CLOCK
	SDA	SERIAL DATA
	SEGO~UP	FL SEGMENT OUTPUT
	SELCLK	SELECT CLOCK
	SEN	SERIAL PORT ENABLE
	SIN1, 2	SERIAL DATA IN
	SOUT1, 2	SERIAL DATA OUT
	SPDI	SERIAL PORT DATA INPUT
	SPDO	SERIAL PORT DATA OUTPUT
	SPEN	SERIAL PORT R/W ENABLE
	SPRCLK	SERIAL PORT READ CLOCK
	SPWCLK	SERIAL PORT WRITE CLOCK
	SQCK	SUB CODE Q CLOCK
	SQCX	SUB CODE Q DATA READ CLOCK
	SRDATA	SERIAL DATA
	SRMADR	SRAM ADDRESS BUS
	SRMDT0~7	SRAM DATA BUS 0~7
	SS	START/STOP
	STAT	STATUS
	STCLK	STREAM DATA CLOCK
	STD0~UP	STREAM DATA
	STENABLE	STREAM DATA INPUT ENABLE
	STSEL	STREAM DATA POLARITY SELECT
	STVALID	STREAM DATA VALIDITY
	SUBC	SUB CODE SERIAL
	SBCK	SUB CODE CLOCK
SUBQ	SUB CODE Q DATA	
SYSCLK	SYSTEM CLOCK	
T	TE	TRACKING ERROR
	TIBAL	BALANCE CONTROL
	TID	BALANCE OUTPUT 1
	TIN	BALANCE INPUT
	TIP	BALANCE INPUT
	TIS	BALANCE OUTPUT 2
	TPSN	OP AMP INPUT
	TPSO	OP AMP OUTPUT
	TPSP	OP AMP INVERTED INPUT
	TRCRS	TRACK CROSS SIGNAL
	TRON	TRACKING ON
	TRSON	TRAVERSE SERVO ON

INITIAL/LOGO		ABBREVIATIONS
V	VBLANK	V BLANKING
	VCC	COLLECTOR POWER SUPPLY VOLTAGE
	VCDCONT	VIDEO CD CONTROL (TRACKING BALANCE)
	VDD	DRAIN POWER SUPPLY VOLTAGE
	VFB	VIDEO FEED BACK
	VREF	VOLTAGE REFERENCE
	VSS	SOURCE POWER SUPPLY VOLTAGE
W	WAIT	BUS CYCLE WAIT
	WDCK	WORD CLOCK
	WEH	WRITE ENABLE HIGH
	WSR	WORD SELECT RECEIVER
X	X	X' TAL
	XALE	X ADDRESS LATCH ENABLE
	XAREQ	X AUDIO DATA REQUEST
	XCDROM	X CD ROM CHIP SELECT
	XCS	X CHIP SELECT
	XCSYNC	X COMPOSITE SYNC
	XDS	X DATA STROBE
	XHSYNCO	X HORIZONTAL SYNC OUTPUT
	XHINT	XH INTERRUPT REQUEST
	XI	X' TAL OSCILLATOR INPUT
	XINT	X INTERRUPT
	XMW	X MEMORY WRITE ENABLE
	XO	X' TAL OSCILLATOR OUTPUT
	XRE	X READ ENABLE
	XSRMCE	X SRAM CHIP ENABLE
	XSRMOE	X SRAM OUTPUT ENABLE
	XSRMWE	X SRAM WRITE ENABLE
	XVCS	X V-DEC CHIP SELECT
	XVDS	X V-DEC CONTROL BUS STROBE
XVSYNCO	X VERTICAL SYNC OUTPUT	

Service Manual

Diagrams and Replacement Parts List

DVD Video Recorder

DMR-ES20P DMR-ES20PC

Vol. 1
Colour
(K).....Black Type (ES20P only)
(S).....Silver Type

S1. About Indication of The Schematic Diagrams

S1.1. Important Safety Notice

COMPONENTS IDENTIFIED WITH THE MARK \triangle HAVE THE SPECIAL CHARACTERISTICS FOR SAFETY. WHEN REPLACING ANY OF THESE COMPONENTS USE ONLY THE SAME TYPE.

1. Although reference number of the parts is indicated on the P.C.B. drawing and/or schematic diagrams, it is NOT mounted on the P.C.B. when it is displayed with "\$" mark.
2. It is only the "Test Round" and no terminal (Pin) is available on the P.C.B. when the TP (Test Point) indicated as "●" mark.
3. The voltage being indicated on the schematic diagram is measured in "Standard-Playback" mode when there is no specify mode is mentioned.
4. Although the voltage and waveform available on here is measured with standard frame, it may be differ from actual measurement due to modification of circuit and so on.
5. The voltage being indicated here may be include observational-error (deviation) due to internal-resistance and/or reactance of equipment. Therefore, handle the value indicated on here as reference.
6. Use the parts number indicated on the Replacement Parts List .
7. Indication on Schematic diagrams:

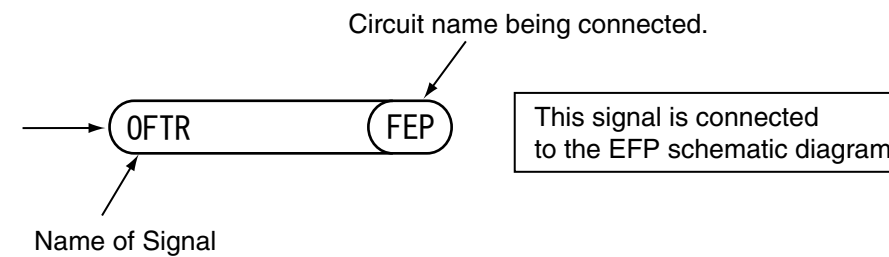

Table of contents

S1. About Indication of The Schematic Diagrams S-1	S4.2. AV_I/O(A) Schematic Diagram S-14	S6. Replacement Parts List..... S-37
S1.1. Important Safety Notice S-1	S4.3. Power Section(P) Schematic Diagram..... S-18	S7. Exploded Views..... S-43
S2. Voltage and Waveform Chart..... S-2	S4.4. Timer Section(T) Schematic Diagram S-22	S7.1. Frame and Casing Section S-43
S2.1. Main P.C.B. S-2	S4.5. Tuner Pack Schematic Diagram S-26	S7.2. Packing Parts & Accessories Section S-44
S2.2. DV_Jack P.C.B..... S-3	S4.6. DV_Jack Schematic Diagram S-27	
S3. Block Diagram..... S-4	S4.7. Front_L Schematic Diagram S-27	
S3.1. Power Supply Block Diagram (1) S-4	S5. Print.Circuit.Board..... S-28	
S3.2. Power Supply Block Diagram (2) S-5	S5.1. Main P.C.B. S-28	
S3.3. Analog Video Block Diagram..... S-6	S5.1.1. Main P.C.B.(Component Side)..... S-28	
S3.4. Analog Audio Block Diagram..... S-7	S5.1.2. Main P.C.B.(Foil Side)..... S-28	
S3.5. Analog Timer Block Diagram..... S-8	S5.1.3. Main P.C.B. Address Information S-32	
S4. Schematic Diagram..... S-10	S5.2. DV_Jack P.C.B..... S-33	
S4.1. Interconnection Diagram..... S-10	S5.3. Tuner Pack P.C.B..... S-34	
	S5.4. Front_L P.C.B..... S-35	

S2.2. DV_Jack P.C.B.

REF No.	PIN No.	REC	PB	EE	REF No.	PIN No.	REC	PB	EE
IC7505	2	0	1.8	0	P7401	59	0.5	0.5	0.5
IC7505	3	0	1.8	0	P7401	60	0	0	0
IC7505	4	0	0	0	P7401	61	0	0	0
IC7505	5	0	1.8	0	P7401	62	0	0	0
IC7505	6	0	1.8	0	P7401	63	0.7	0.7	0.7
IC7505	7	0	1.8	0	P7401	64	0	0	0
IC7505	8	12	12	12	P7401	65	0	0	0
P7401	1	5	5	5	P7401	66	0	0	0
P7401	2	5	5	5	P7401	67	0	0	0
P7401	3	3.3	3.3	3.3	P7401	68	3.3	3.3	3.3
P7401	4	3.3	3.3	3.3	P7401	69	0	0	0
P7401	5	3.3	3.3	3.3	P7401	70	3.3	3.3	3.3
P7401	6	5	5	5	P7401	71	0	0	0
P7401	7	0	0	0	P7401	72	3.3	3.3	3.3
P7401	8	5	5	5	P7401	73	0	0	0
P7401	9	0	0	0	P7401	74	3.3	3.3	3.3
P7401	10	3.1	3.1	3.1	P7401	75	0	0	0
P7401	11	0	0	0	P7401	76	0	0	0
P7401	12	0	5	0	P7401	77	0	0	0
P7401	13	0	0	0	P7401	78	4.9	0	0
P7401	14	5	5	5	P7401	79	0	0	0
P7401	15	0	2.3	0	P7401	80	0	0	0
P7401	16	0	0	0	P7401	81	0	0	0
P7401	17	5	5	5	P7401	82	1.8	1.8	1.8
P7401	18	0	0	0	P7401	83	3.4	3.4	3.4
P7401	19	0	0	0	P7401	84	1.8	1.8	1.8
P7401	20	4.8	4.8	4.8	P7401	85	0	0	0
P7401	21	0	0	0	P7401	86	1.8	1.8	1.8
P7401	22	0	0	0	P7401	87	0.7	0.7	0.7
P7401	23	0	0	0	P7401	88	1.8	1.8	1.8
P7401	24	0	0	0	Q1200	1	6	6	6
P7401	25	0	0	0	Q1200	2	5	5	5
P7401	26	0	0	0	Q1200	3	0	0	0
P7401	27	0	0	0	Q1200	4	1.8	1.8	1.8
P7401	28	0	0	0	Q3001	E	1.9	2.7	2.7
P7401	29	2.5	2.5	2.5	Q3001	C	0	0	0
P7401	30	0	0	0	Q3001	B	1.3	2.1	2.1
P7401	31	2.5	2.5	2.5	Q3002	E	1.4	1.4	1.4
P7401	32	0	0	0	Q3002	C	4.9	4.9	4.9
P7401	33	0	0	0	Q3002	B	2	2	2
P7401	34	0	0	0	Q4002	E	0	0	0
P7401	35	0	0	0	Q4002	C	0	0	0
P7401	36	1.4	1.4	1.4	Q4002	B	0.7	0	0.7
P7401	37	0	0	0	Q4003	E	0	0	0
P7401	38	3.3	3.3	3.3	Q4003	C	0	0	0
P7401	39	2.4	2.4	2.4	Q4003	B	0.7	0	0.7
P7401	40	0	0	0	Q7502	E	0	0	0
P7401	41	2.4	2.4	2.4	Q7502	C	11.3	11	11
P7401	42	3.3	3.3	3.3	Q7502	B	-0.1	-0.1	0
P7401	43	0	0	0	Q7503	E	0	0	0
P7401	44	0	0	0	Q7503	C	-0.1	-0.1	-0.1
P7401	45	0	0	0	Q7503	B	-0.2	-0.2	-0.2
P7401	46	0	0	0	Q7504	E	0	5.2	0
P7401	47	0.5	0.5	0.5	Q7504	C	12	12	12
P7401	48	0	0	0	Q7504	B	0.4	5.8	0.4
P7401	49	0	0	0	QR4001	E	0	0	0
P7401	50	0	0	0	QR4001	C	2.9	0	2.9
P7401	51	0.6	0.6	0.6	QR4001	B	0	2.3	0
P7401	52	5	5	5	QR4002	E	0	0	0
P7401	53	0	0	0	QR4002	C	0	5.2	0
P7401	54	0	0.3	0	QR4002	B	2.9	0	2.9
P7401	55	0.7	0.7	0.7	QR4003	E	5.2	5.2	5.2
P7401	56	0	3.2	3.2	QR4003	C	5.1	-0.7	5.1
P7401	57	0	0	0	QR4003	B	0	5.2	0
P7401	58	3.2	3.2	3.2					

<P7401>

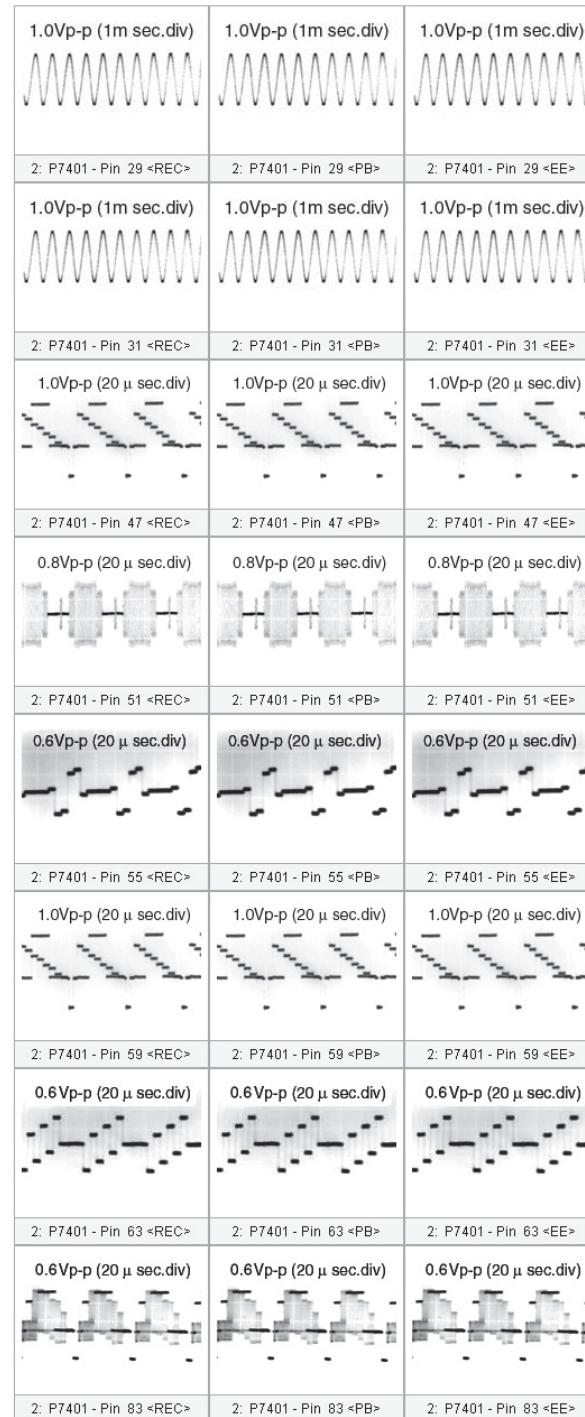

REF No.	PIN No.	REC	PB	EE	REF No.	PIN No.	REC	PB	EE
IC7801	1	-	-	-	IC7801	21	2.3	2.3	2.3
IC7801	2	0.7	0.7	0.7	IC7801	22	2.9	2.9	2.9
IC7801	3	2.8	2.8	2.9	IC7801	23	2.2	2.2	2.2
IC7801	4	0.8	0.8	0.8	IC7801	24	5	5	5
IC7801	5	2.4	2.4	2.4	IC7801	25	0	0	0
IC7801	6	2.4	2.4	2.4	IC7801	26	-	-	-
IC7801	7	4.5	4.5	4.4	IC7801	27	5	5	5
IC7801	8	-	-	-	IC7801	28	2.3	2.3	2.3
IC7801	9	-	-	-	IC7801	29	2.3	2.3	2.3
IC7801	10	-	-	-	IC7801	30	2.3	2.3	2.3
IC7801	11	-	-	-	IC7801	31	-	-	-
IC7801	12	-	-	-	IC7801	32	2.5	2.5	2.5
IC7801	13	2.7	2.7	2.7	Q7801	E	2.4	2.4	2.4
IC7801	14	2.6	2.7	2.6	Q7801	C	0	0	0
IC7801	15	2.3	2.3	2.3	Q7801	B	1.6	1.6	1.6
IC7801	16	-	-	-					
IC7801	17	0	0	0					
IC7801	18	0	0	0					
IC7801	19	5	5	5					
IC7801	20	-	-	-					

S3. Block Diagram

S3.1. Power Supply Block Diagram (1)

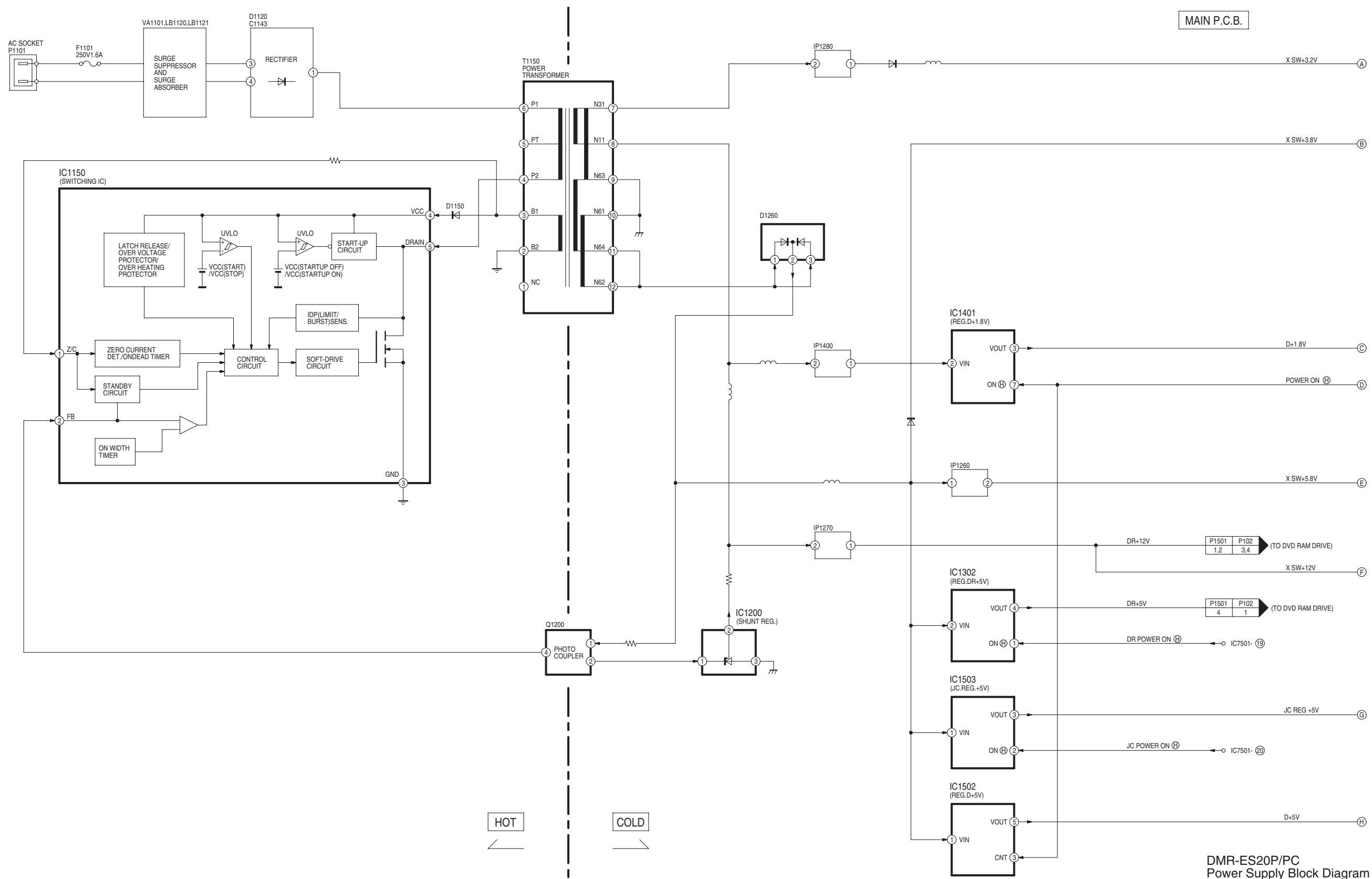

DMR-ES20P/PC
Power Supply Block Diagram

S3.2. Power Supply Block Diagram (2)

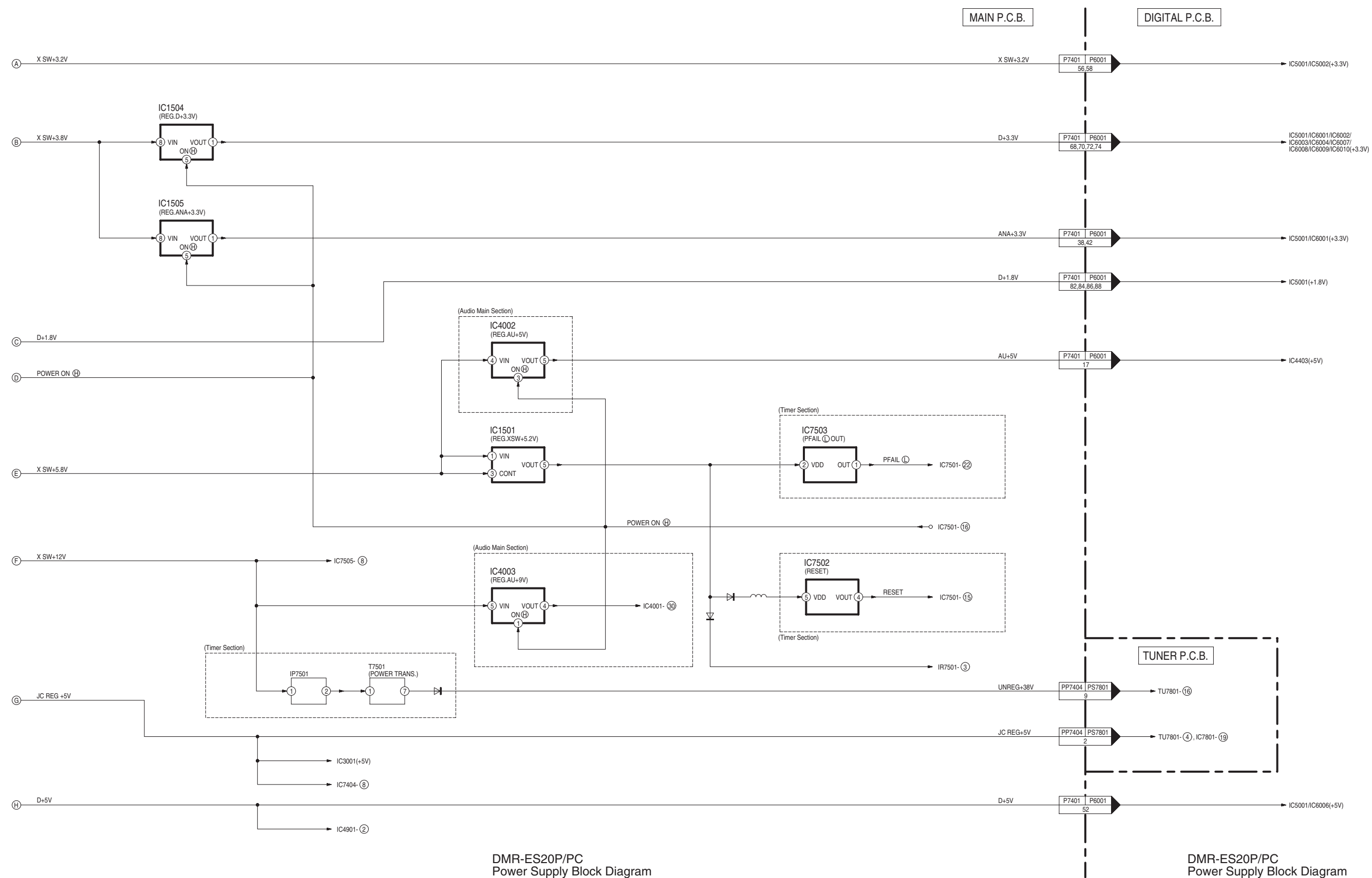

DMR-ES20P/PC
Power Supply Block Diagram

DMR-ES20P/PC
Power Supply Block Diagram

S3.3. Analog Video Block Diagram

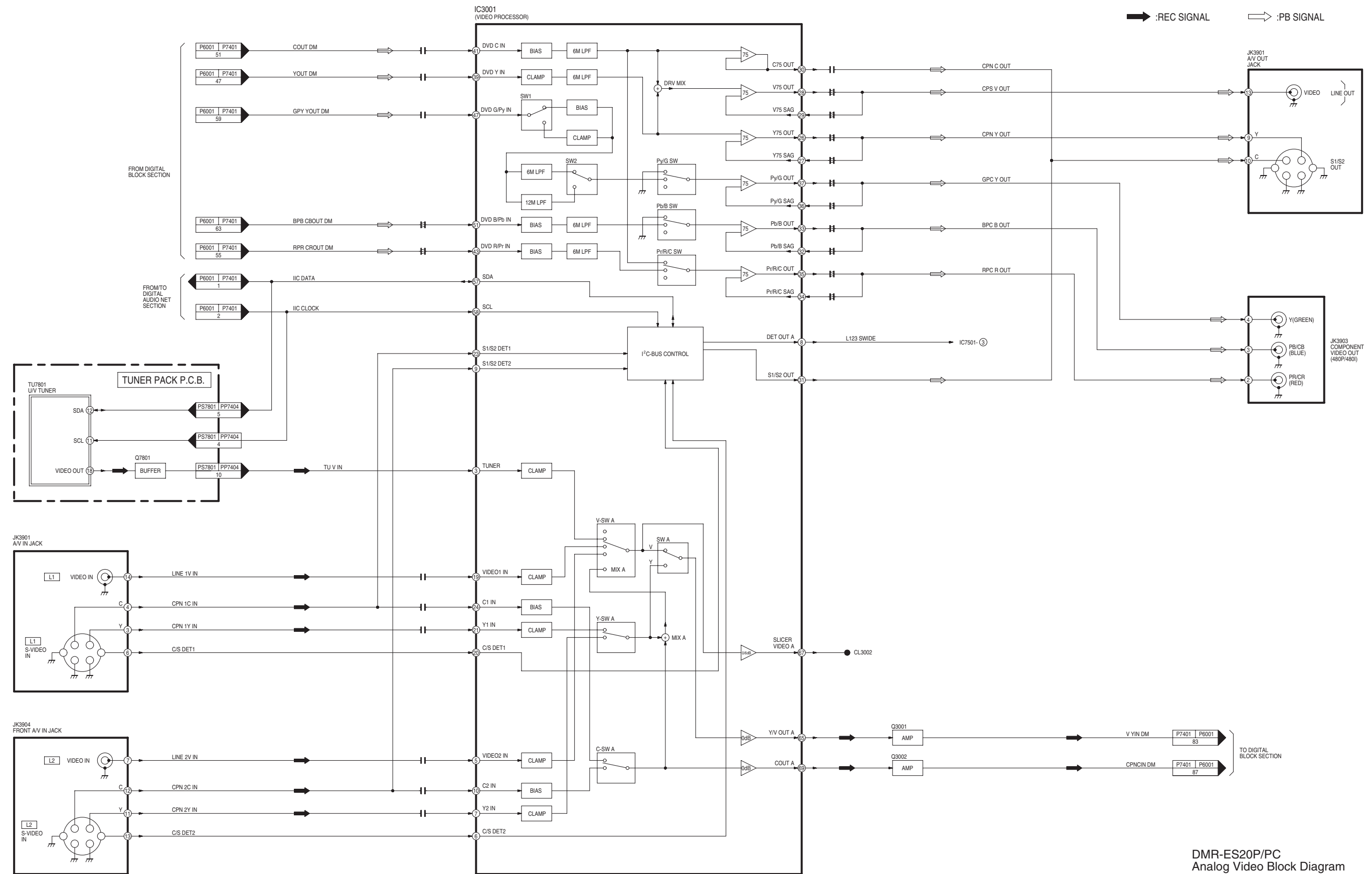

DMR-ES20P/PC
Analog Video Block Diagram

S3.4. Analog Audio Block Diagram

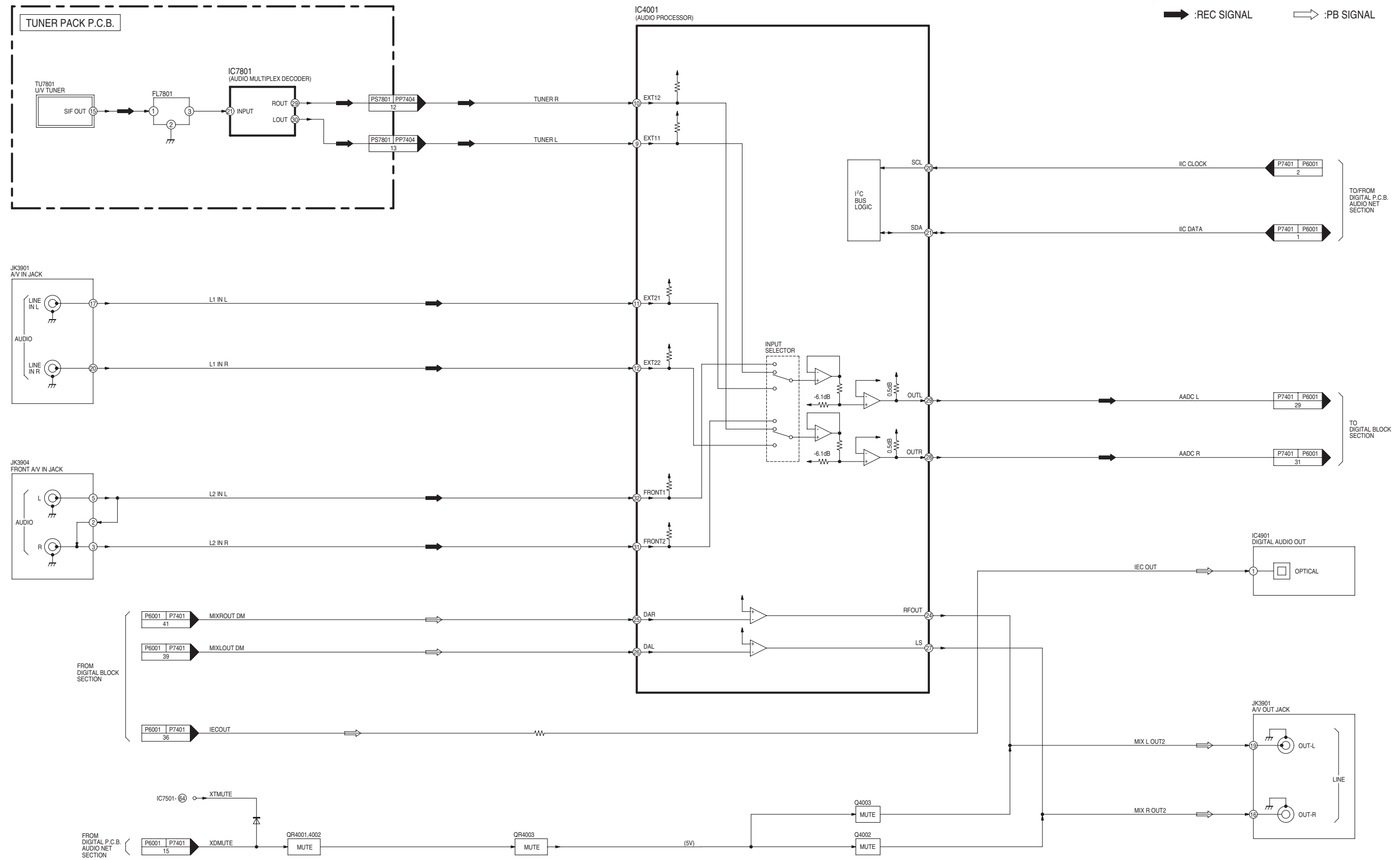

DMR-ES20P/PC
Analog Audio Block Diagram

S3.5. Analog Timer Block Diagram

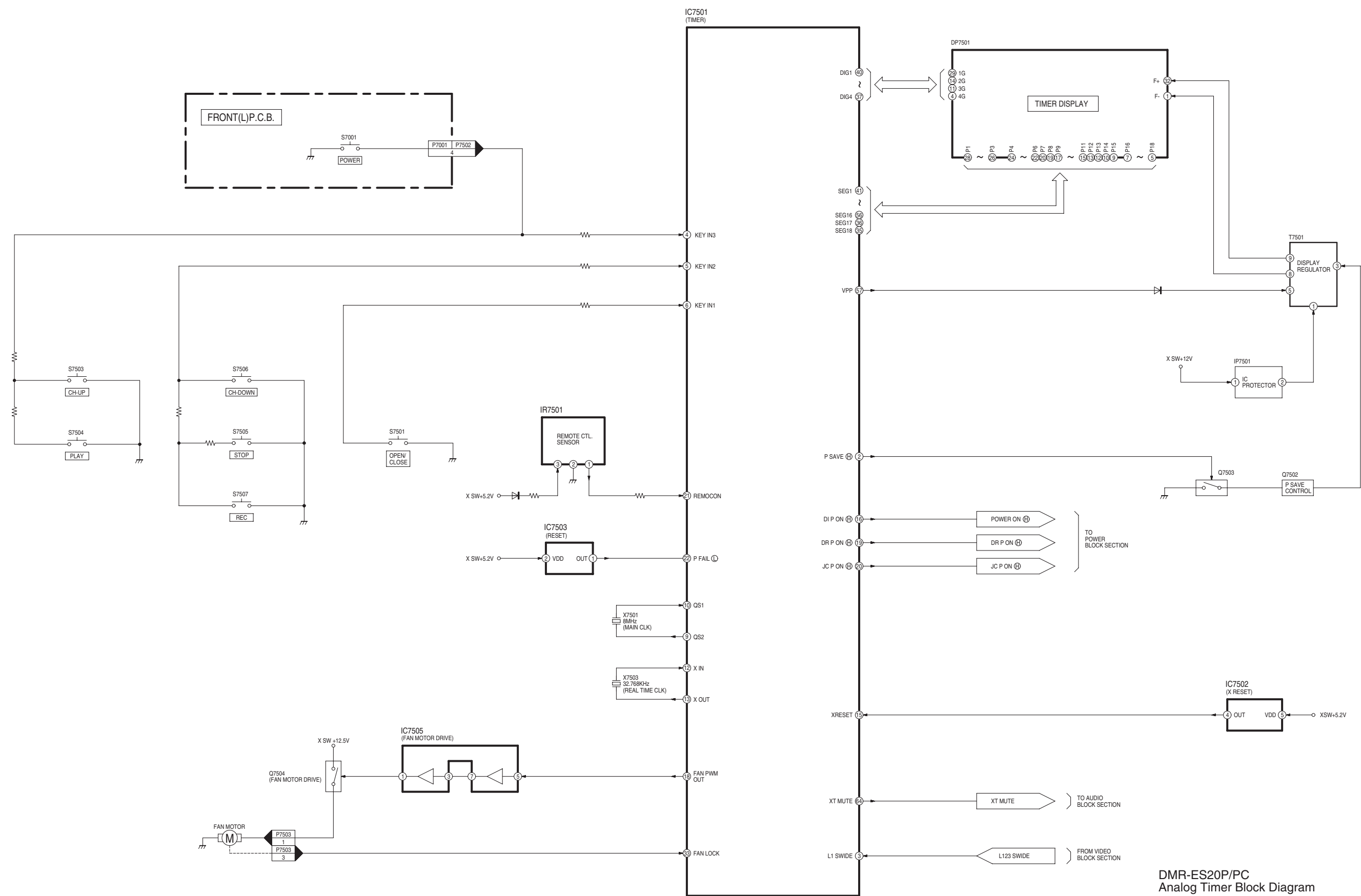

DMR-ES20P/PC
Analog Timer Block Diagram

S4. Schematic Diagram

S4.1. Interconnection Diagram

N
M
L
K
J
I
H
G

1/4	

DMR-ES20P/PC
Interconnection Diagram



P7503

1	FAN2OUT
2	GND
3	FAN2LOCK

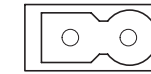

P1101

P7502

4	KEY1NG
3	GND
2	GND
1	GND

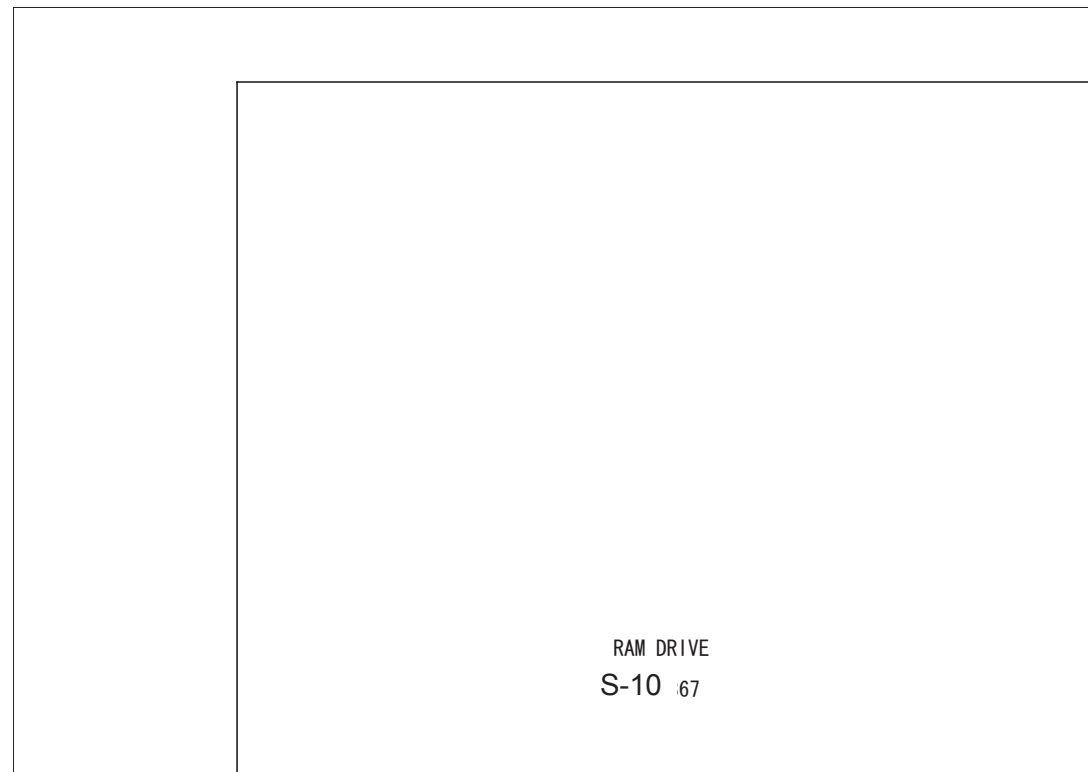

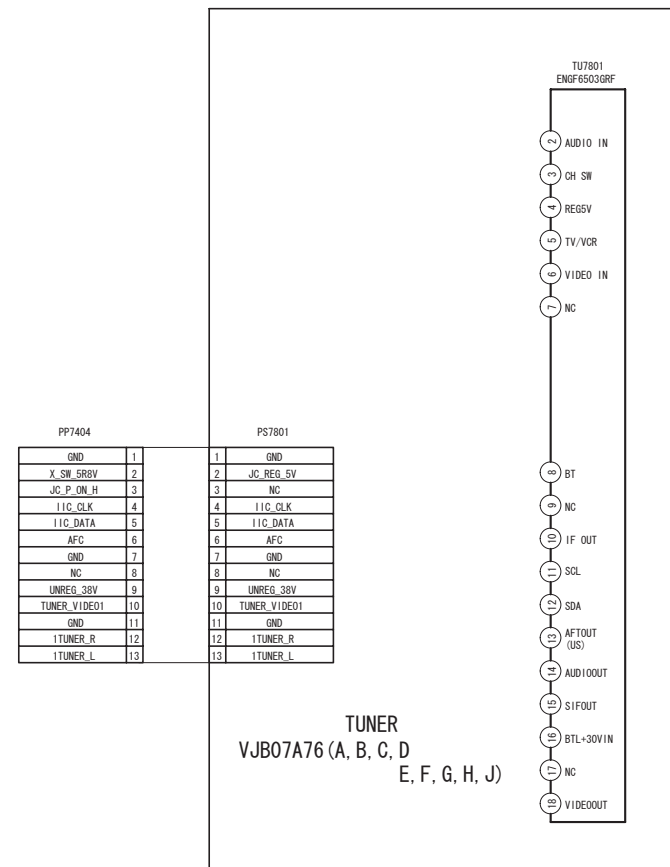

MAIN
VJB79113



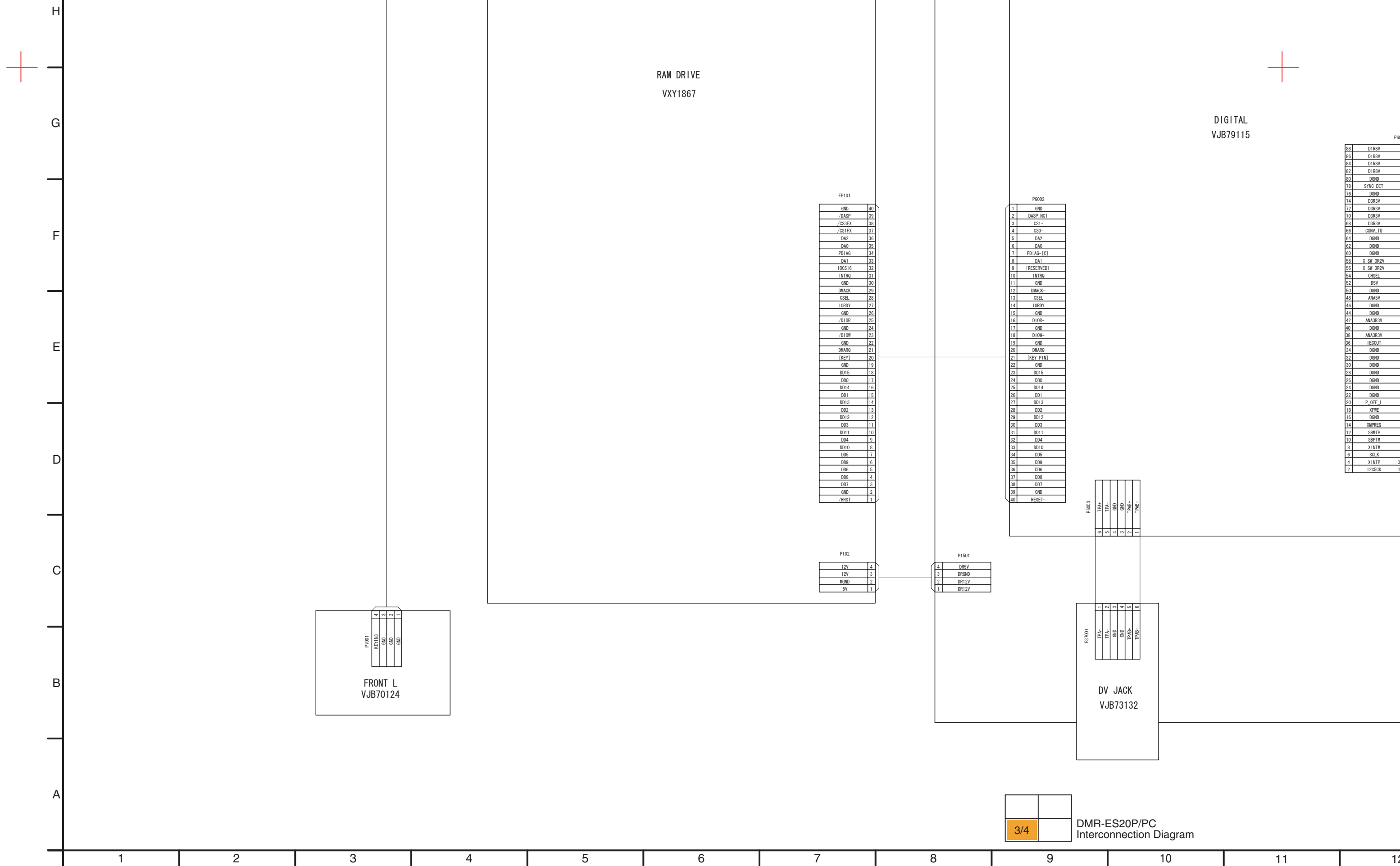

P60

88	D1R8V
86	D1R8V
84	D1R8V
82	D1R8V
80	DGND
78	SYNC_DET
76	DGND
74	D3R3V
72	D3R3V
70	D3R3V
68	D3R3V
66	CONV_TU
64	DGND
62	DGND
60	DGND
58	X_SW_3R2V
56	X_SW_3R2V
54	CHSEL
52	D5V
50	DGND
48	ANA5V
46	DGND
44	DGND
42	ANA3R3V
40	DGND
38	ANA3R3V
36	IECOUT
34	DGND
32	DGND
30	DGND
28	DGND
26	DGND
24	DGND
22	DGND
20	P_OFF_L
18	XFWE
16	DGND
14	XMPREQ
12	SBMTP
10	SBPTM
8	XINTM
6	SCLK
4	XINTP
2	I2C5CK

P6001			P7401		
88	D1R8V	CPNC1N_DM	87	D1R8V	CPNC1N_DM
86	D1R8V	DGND	85	D1R8V	DGND
84	D1R8V	V_Y1N_DM	83	D1R8V	V_Y1N_DM
82	D1R8V	DGND	81	D1R8V	DGND
80	DGND	DGND	79	DGND	DGND
78	SYNC_DET	DGND	77	SYNC_DET	DGND
76	DGND	DGND	75	DGND	DGND
74	D3R3V	DGND	73	D3R3V	DGND
72	D3R3V	DGND	71	D3R3V	DGND
70	D3R3V	DGND	69	D3R3V	DGND
68	D3R3V	DGND	67	D3R3V	DGND
66	CONV_TU	DGND	65	CONV_TU	DGND
64	DGND	BPBOUT_DM	63	DGND	BPBOUT_DM
62	DGND	DGND	61	DGND	DGND
60	DGND	GPYOUT_DM	59	DGND	GPYOUT_DM
58	X_SW_3R2V	DGND	57	X_SW_3R2V	DGND
56	X_SW_3R2V	RPROUT_DM	55	X_SW_3R2V	RPROUT_DM
54	CHSEL	DGND	53	CHSEL	DGND
52	D5V	COUOUT_DM	51	D5V	COUOUT_DM
50	DGND	DGND	49	DGND	DGND
48	ANASV	YOUT_DM	47	ANASV	YOUT_DM
46	DGND	DGND	45	DGND	DGND
44	DGND	DGND	43	DGND	DGND
42	ANA3R3V	MIXROUT_DM	41	ANA3R3V	MIXROUT_DM
40	DGND	MIXROUT_DM	39	DGND	MIXROUT_DM
38	ANA3R3V	AUGND	37	ANA3R3V	AUGND
36	IECOUT	AUGND	35	IECOUT	AUGND
34	DGND	AUGND	33	DGND	AUGND
32	DGND	AAADC_R	31	DGND	AAADC_R
30	DGND	AAADC_L	29	DGND	AAADC_L
28	DGND	AUGND	27	DGND	AUGND
26	DGND	AUGND	25	DGND	AUGND
24	DGND	DGND	23	DGND	DGND
22	DGND	DGND	21	DGND	DGND
20	P_OFF_L	DGND	19	P_OFF_L	DGND
18	XFWE	AUSV	17	XFWE	AUSV
16	DGND	XMUTE	15	DGND	XMUTE
14	XMPREQ	DGND	13	XMPREQ	DGND
12	SBMTP	DGND	11	SBMTP	DGND
10	SBPTM	DGND	9	SBPTM	DGND
8	XINTM	DGND	7	XINTM	DGND
6	SCLK	SCURVE1	5	SCLK	SCURVE1
4	XINTP	3 SCURVE0	3	XINTP	3 SCURVE0
2	I2CSCK	1 I2CS0T	1	I2CSCK	1 I2CS0T

S4.2. AV_I/O(A) Schematic Diagram

1/4 DMR-ES20P/PC
AV_I/O Section
(Main P.C.B.(1/3))
Schematic Diagram(A)

N
M
L
K
J
I
H
G

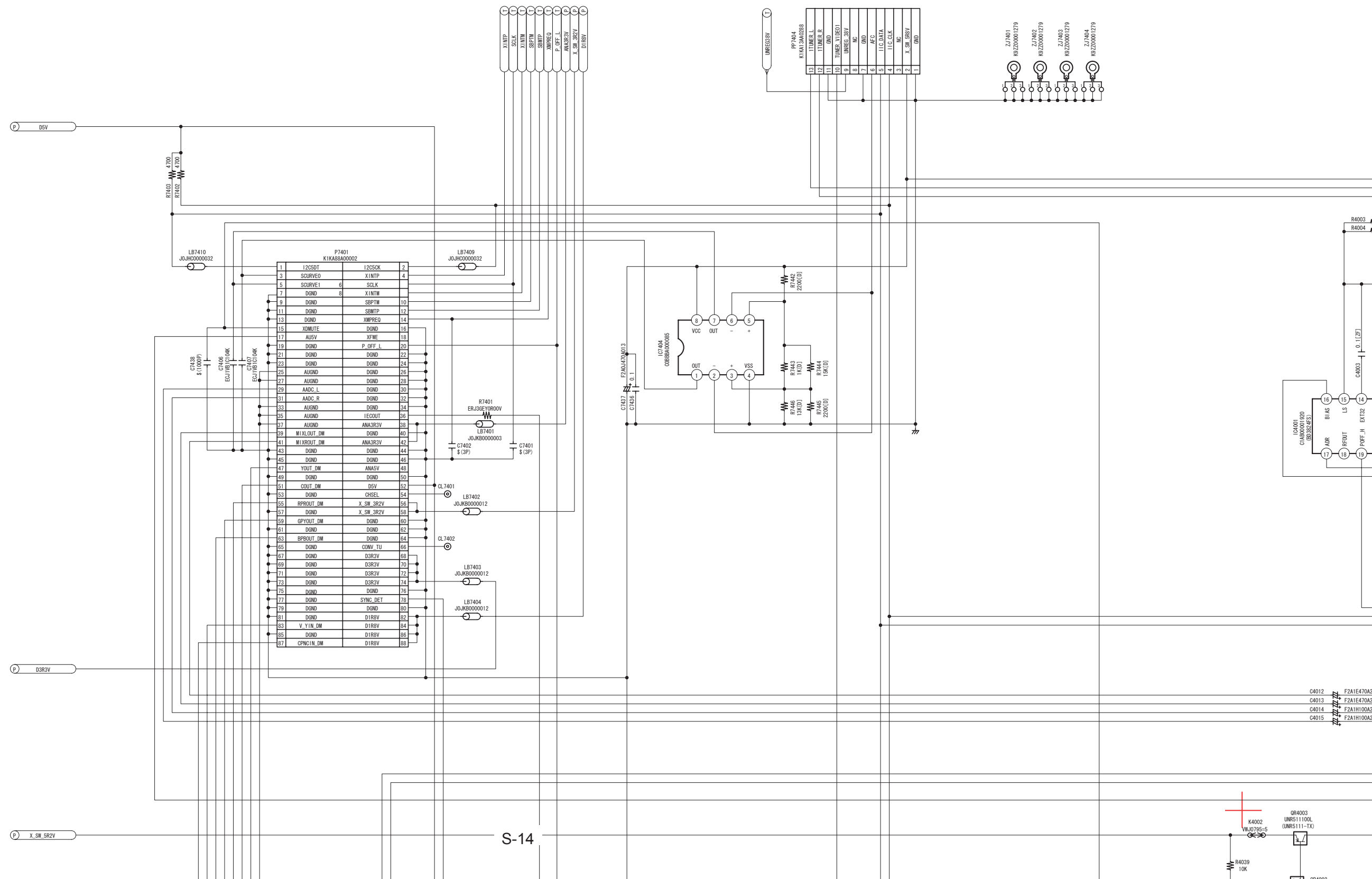

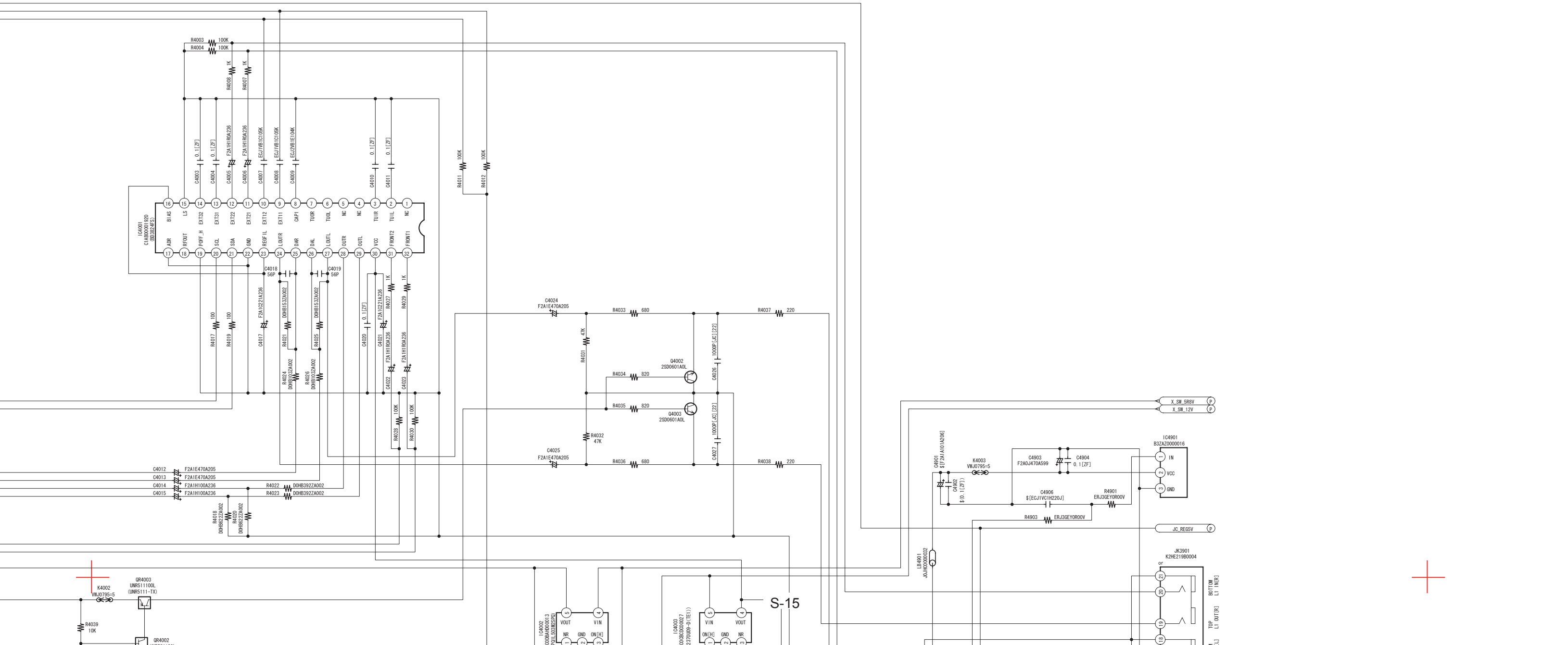



H
G
F
E
D
C
B
A

1

2

3

4

5

6

7

8

9

10

11

12

(P) X_SW_SR2V

(T) XT MUTE

(T) SYNC_DET

(T) L123_SWIDE

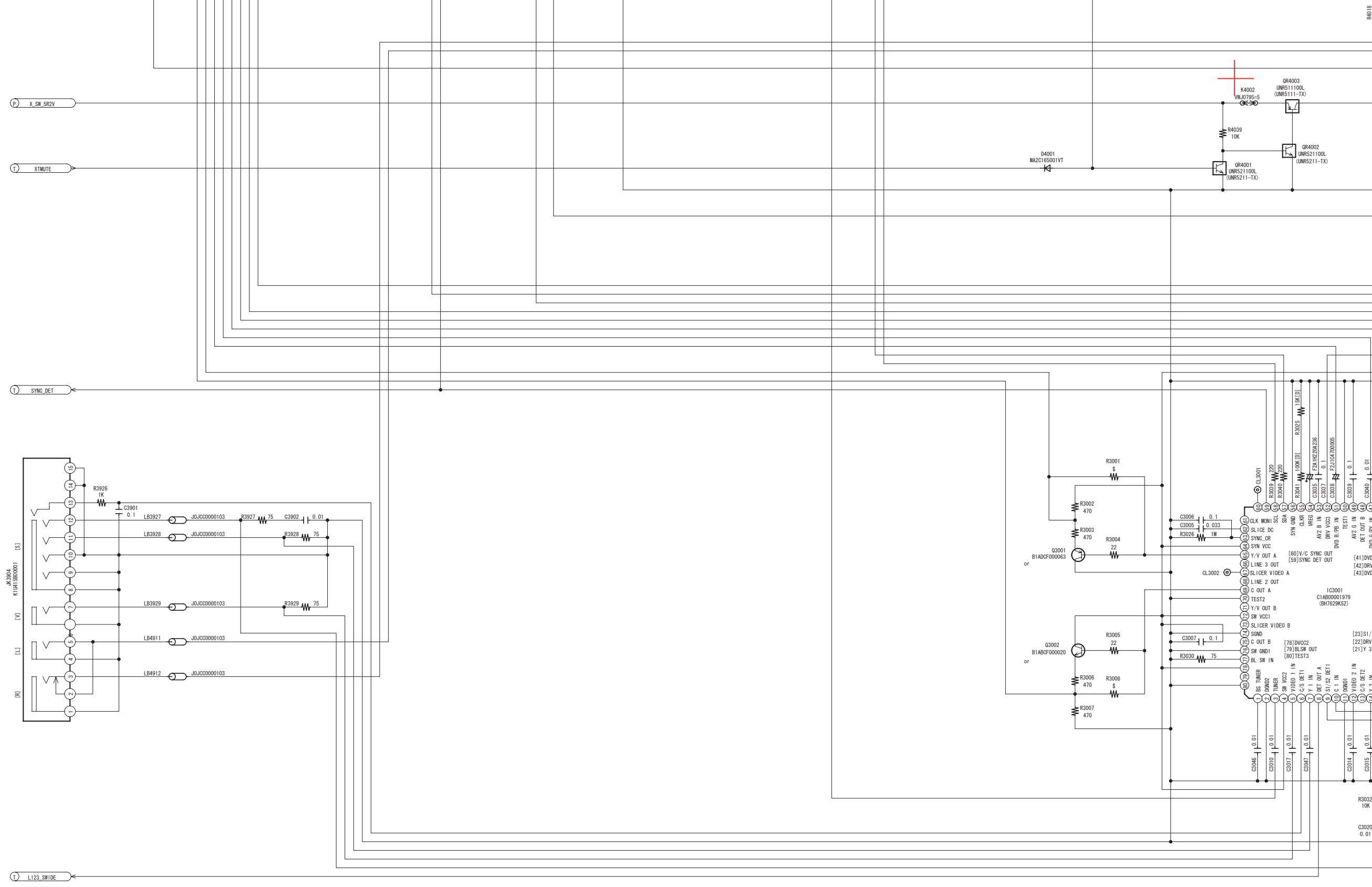

DMR-ES20P/PC
AV I/O Section
(Main P.C.B.(1/3))
Schematic Diagram(A)

3/4



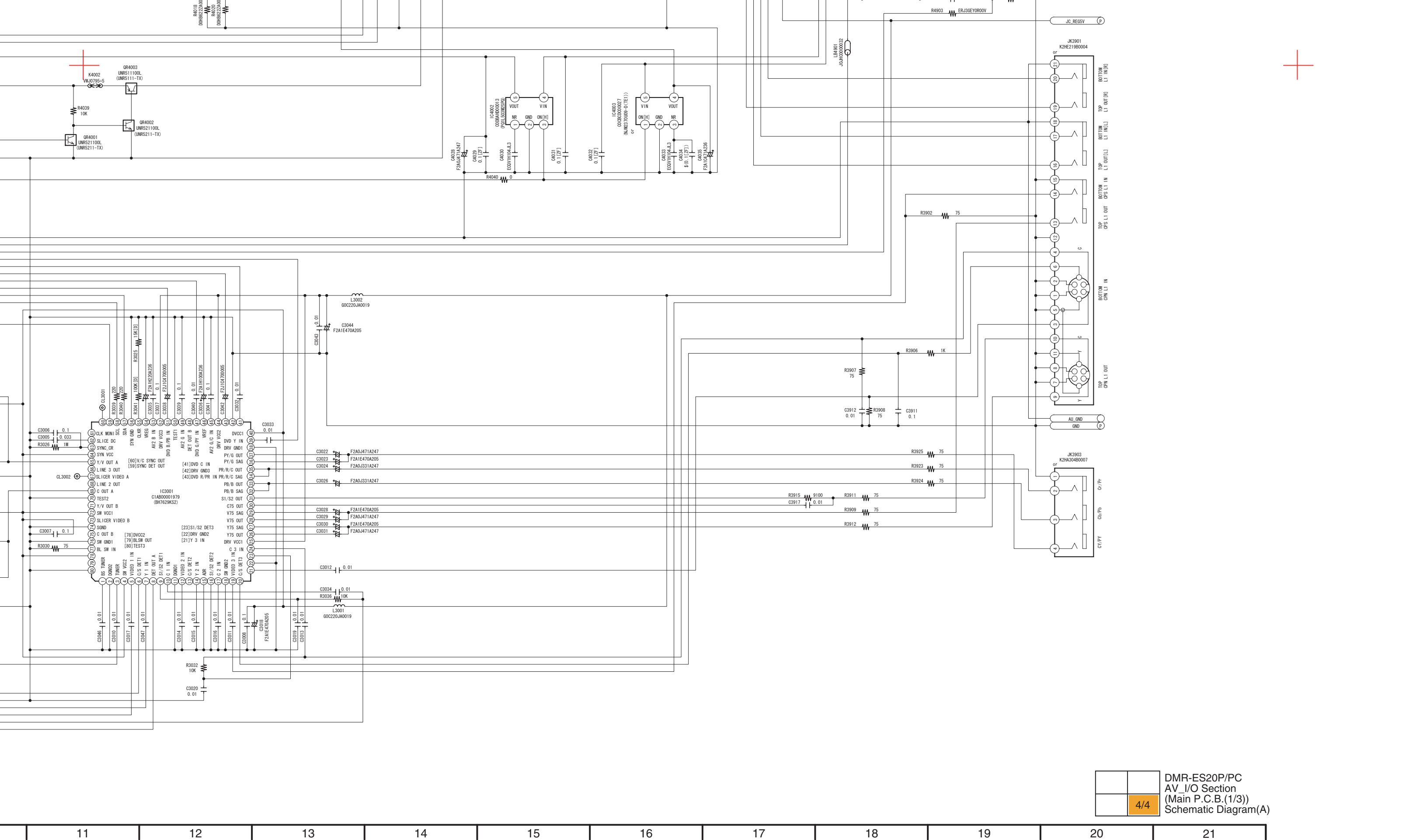

S4.3. Power Section(P) Schematic Diagram

CAUTION: FOR CONTINUED PROTECTION AGAINST FIRE HAZARD, REPLACE ONLY WITH THE SAME TYPE 1.6A 250V FUSE.
ATTENTION: POUR UNE PROTECTION CONTINUE LES RISQUES D'INCENDIE N'UTILISERQUE DES FUSIBLE DE MEME TYPE 1.6A 250V.

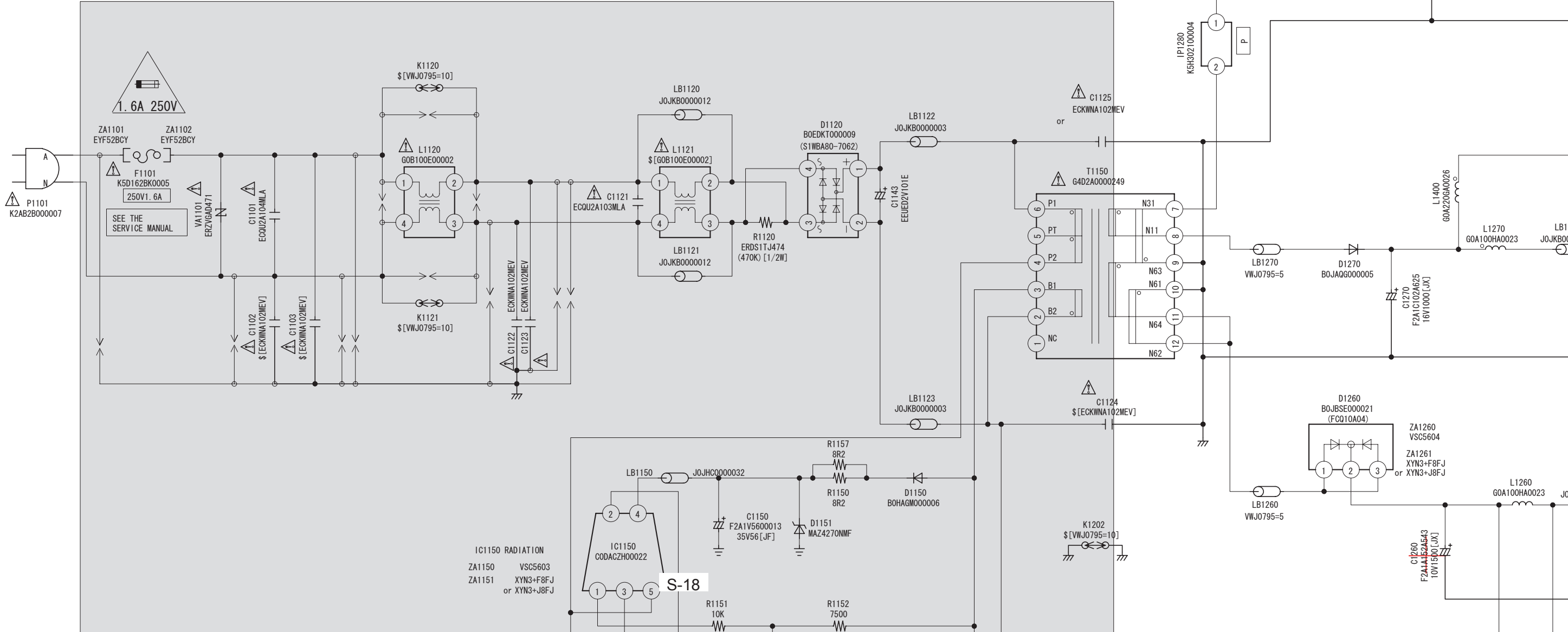

IC1150 RADIATION
 ZA1150 VSC5603
 ZA1151 XYN3+F8FJ
 or XYN3+J8FJ

S-18

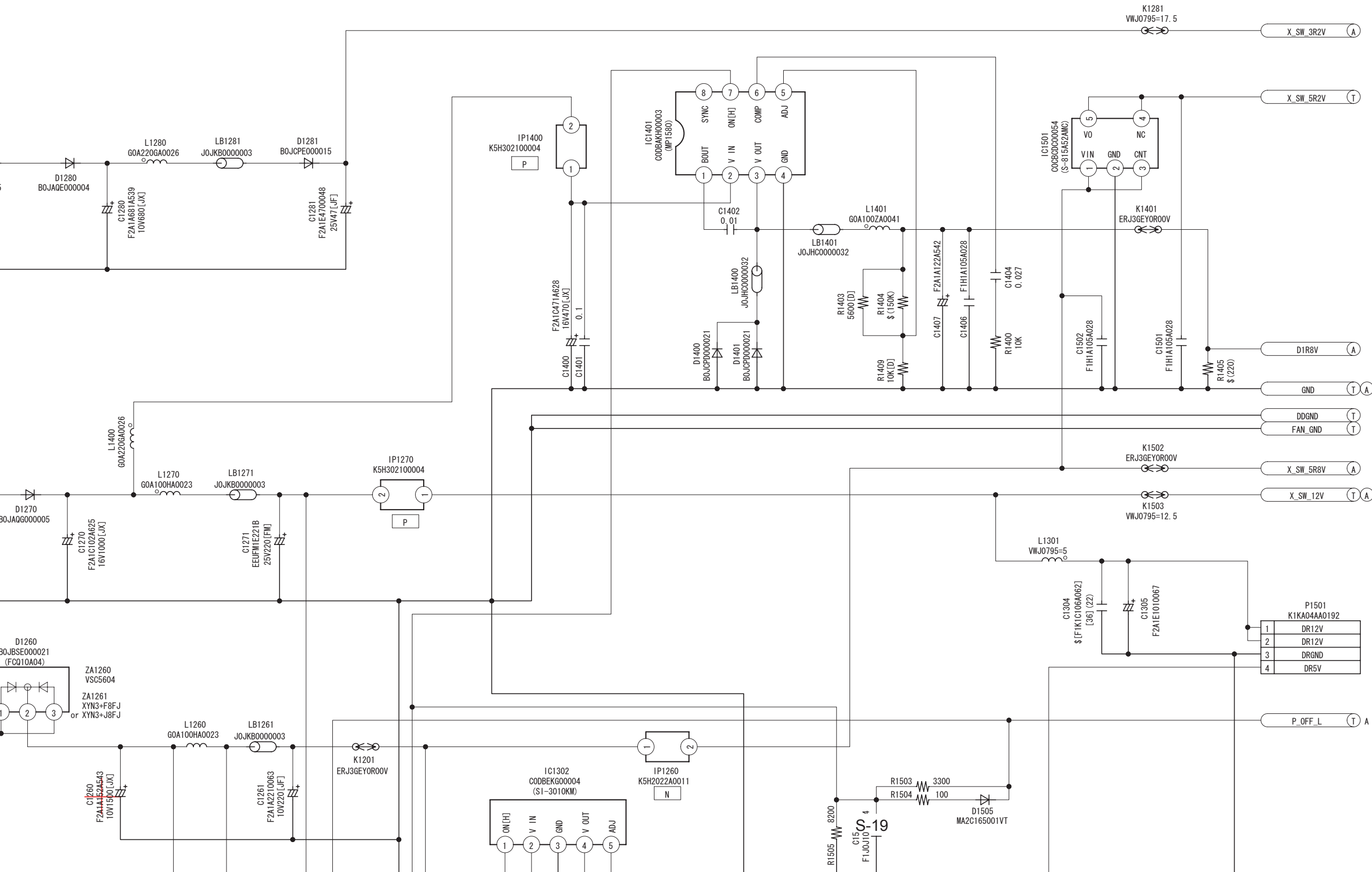

H
G
F
E
D
C
B
A

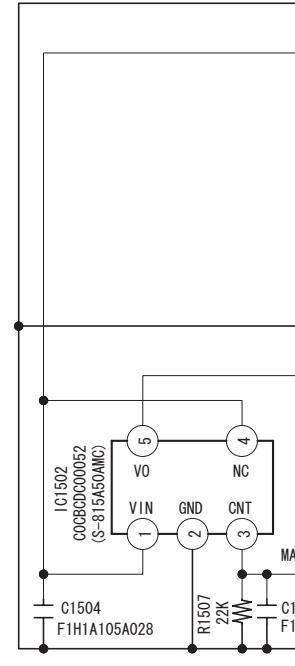
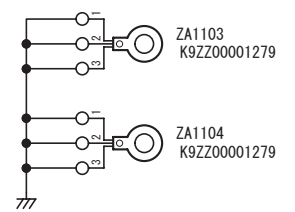
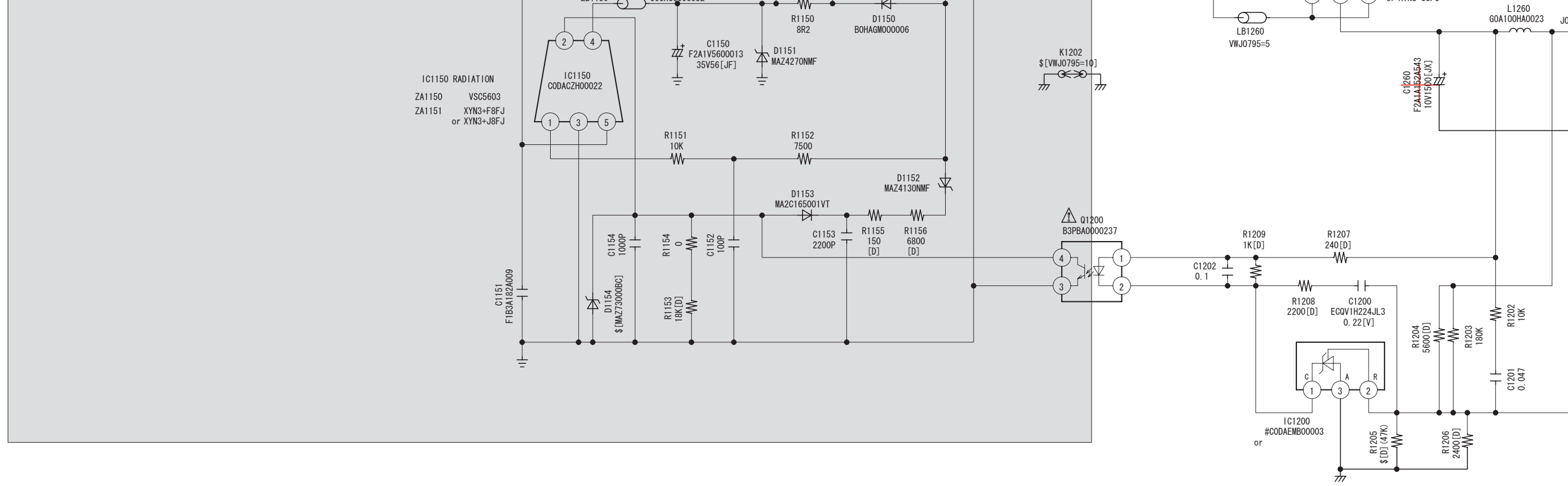

DMR-ES20P/PC
Power Section
(Main P.C.B.(2/3))
Schematic Diagram(P)

1 2 3 4 5 6 7 8 9 10 11 12

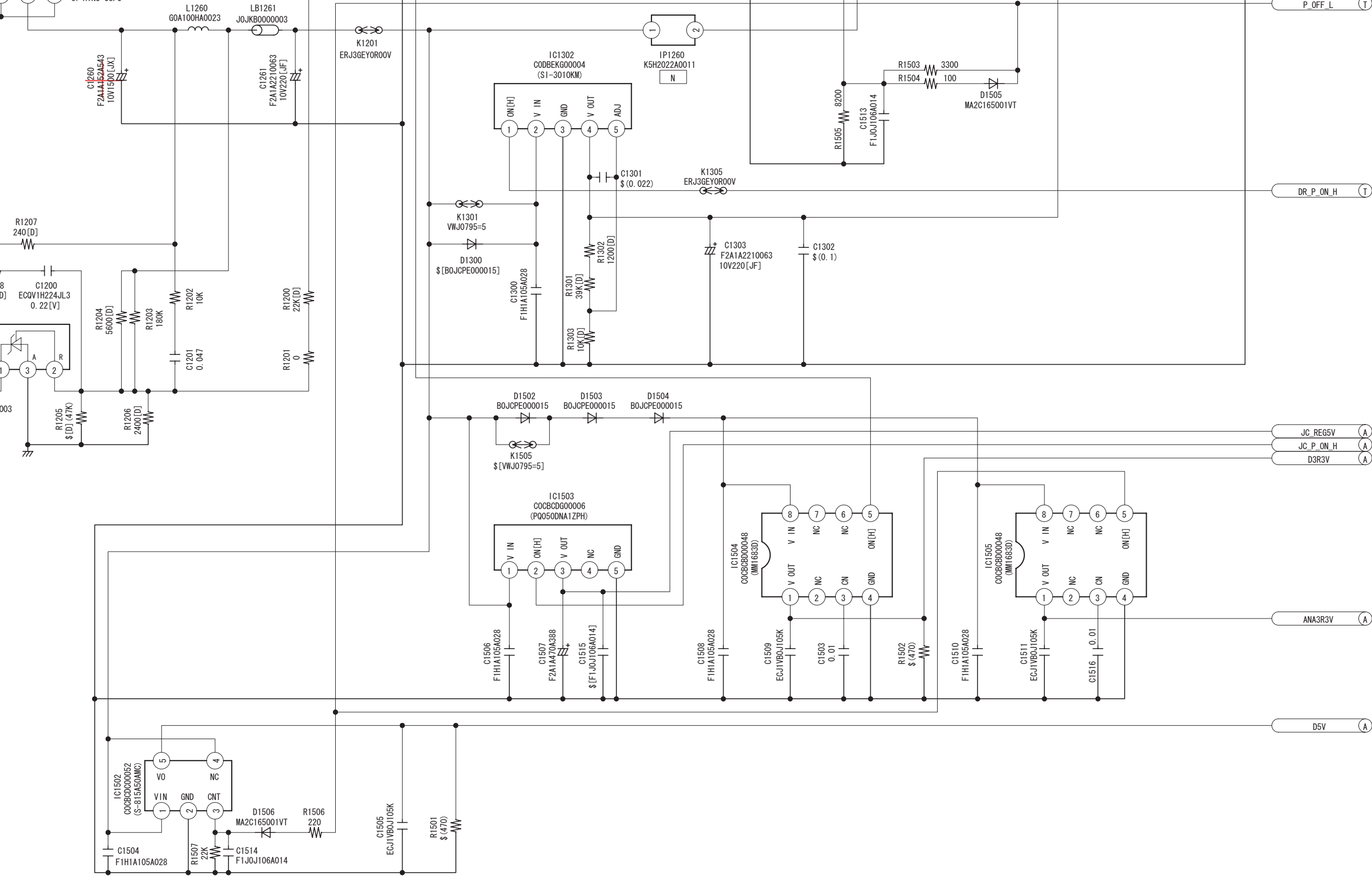

S4.4. Timer Section(T) Schematic Diagram

N
M
L
K
J
I
H
G

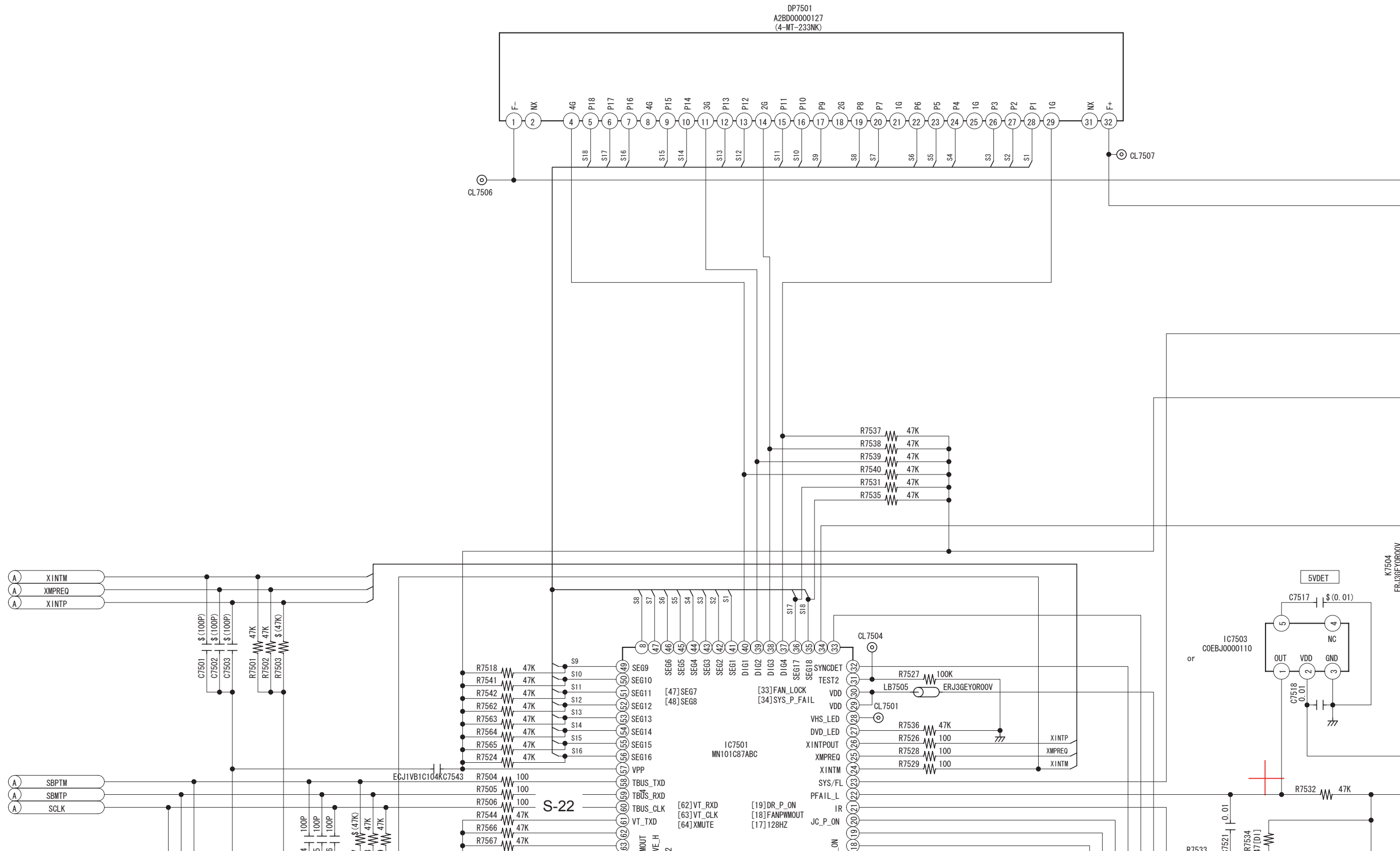

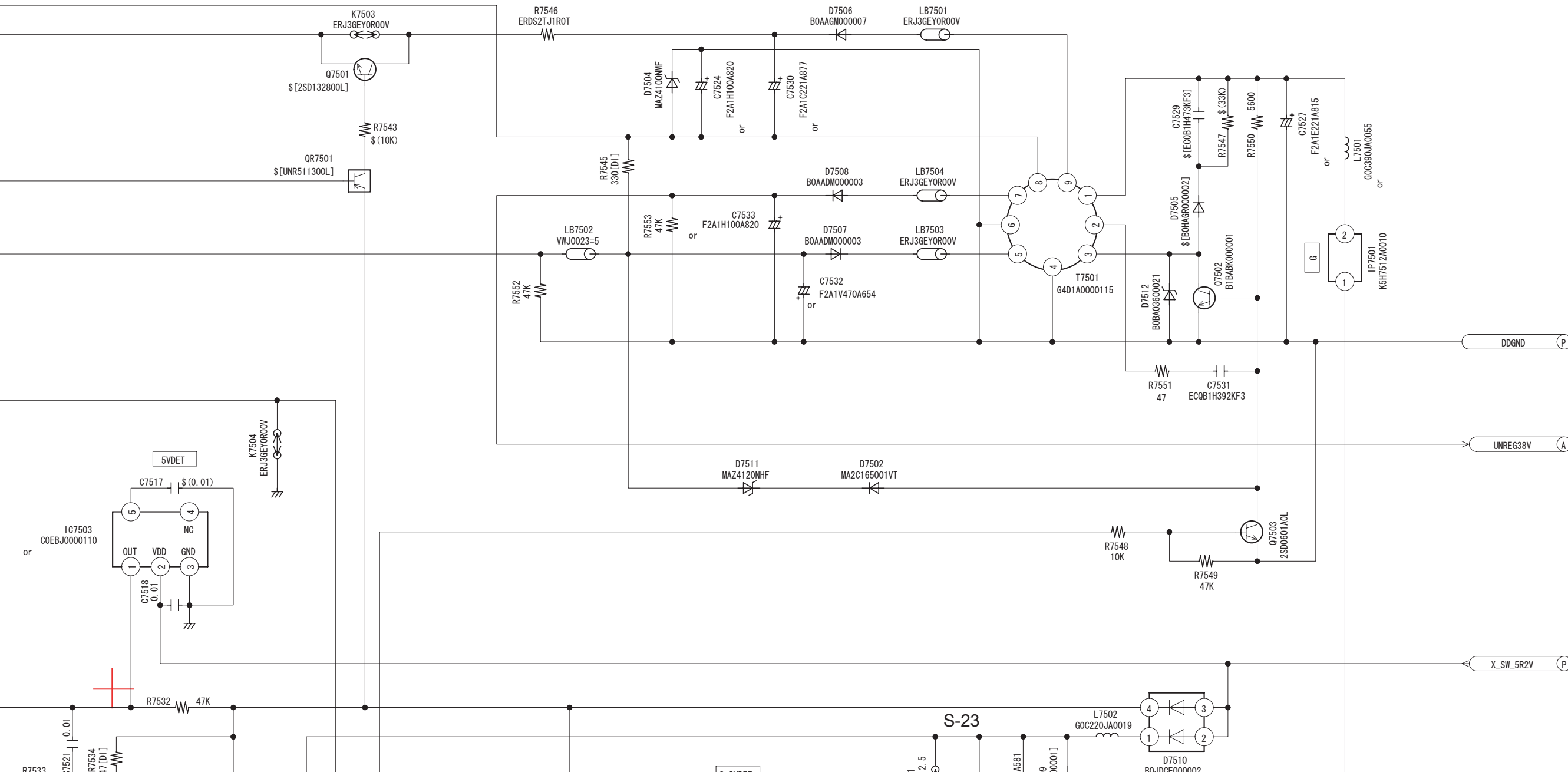

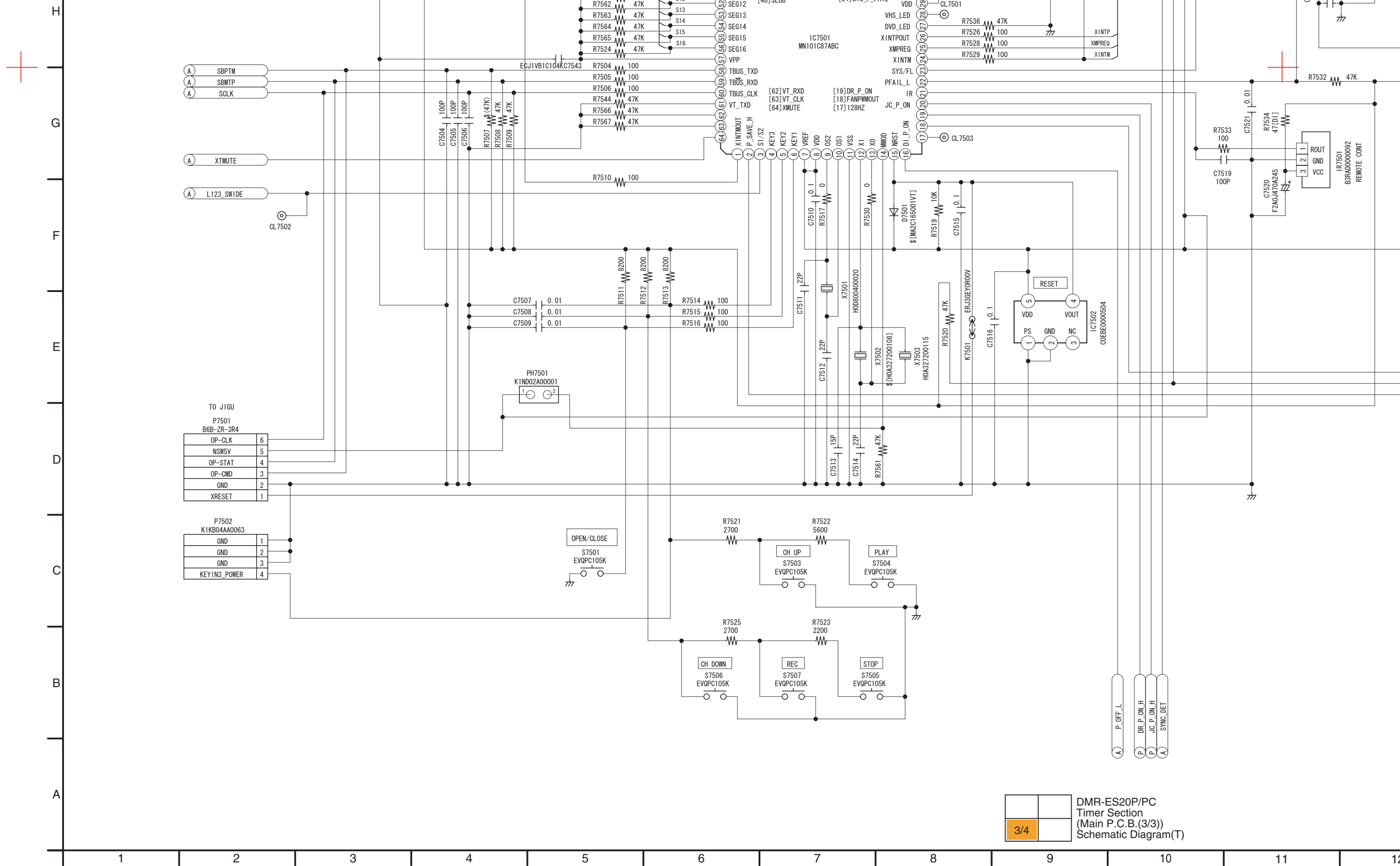

DMR-ES20P/PC
Timer Section
(Main P.C.B.(3/3))
Schematic Diagram(T)

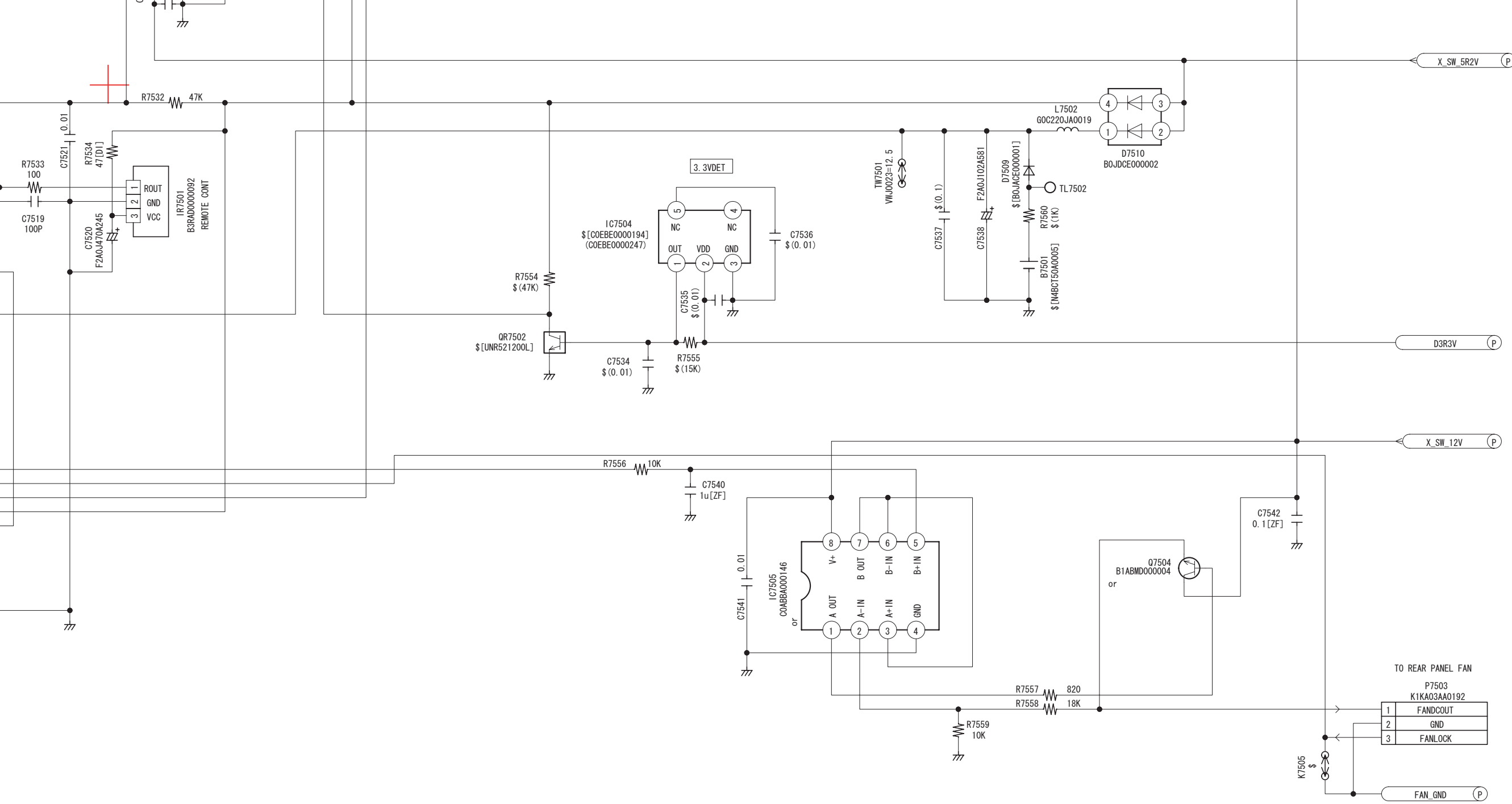

S4.5. Tuner Pack Schematic Diagram

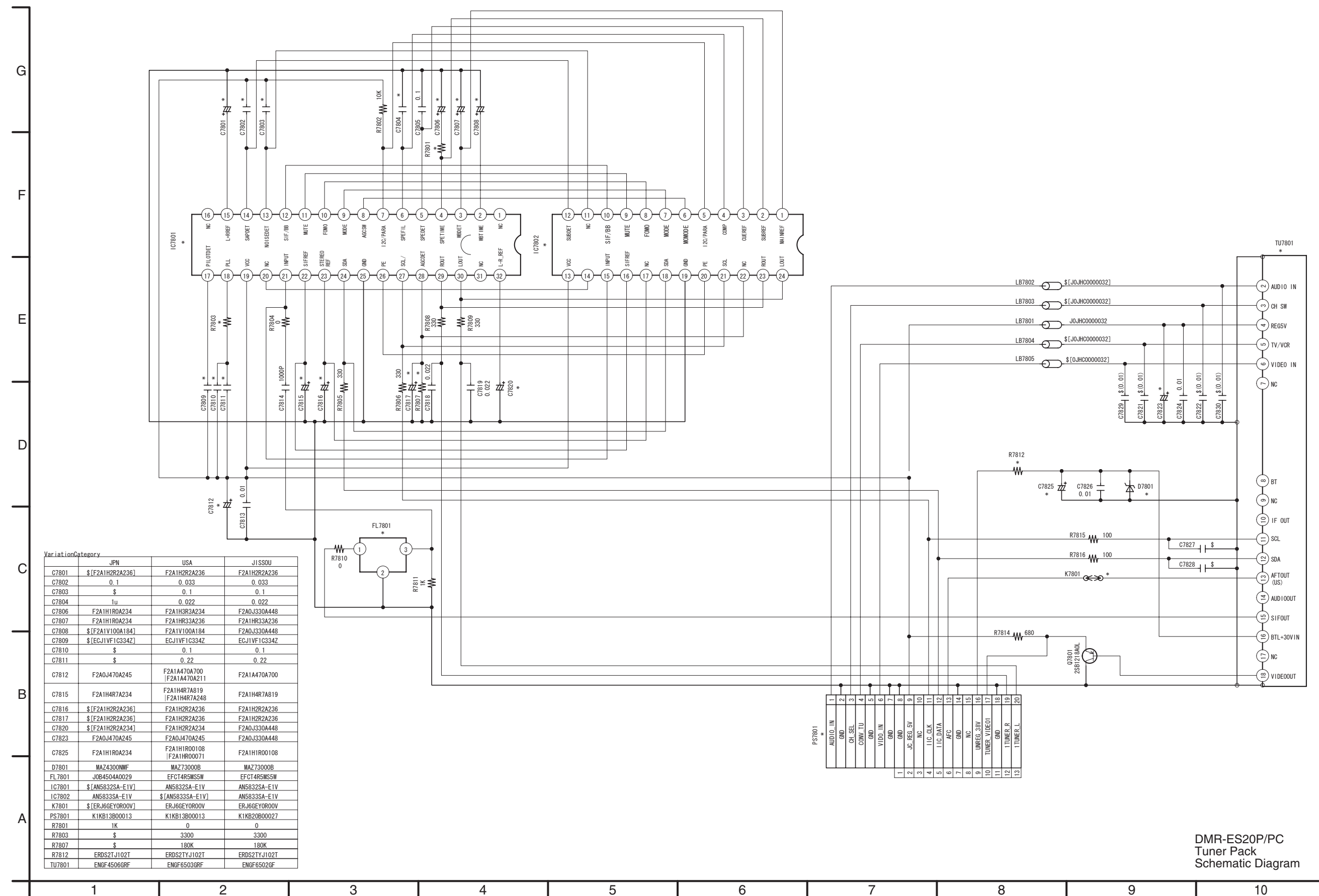

DMR-ES20P/PC
Tuner Pack
Schematic Diagram

S4.6. DV_Jack Schematic Diagram / S4.7. Front_L Schematic Diagram

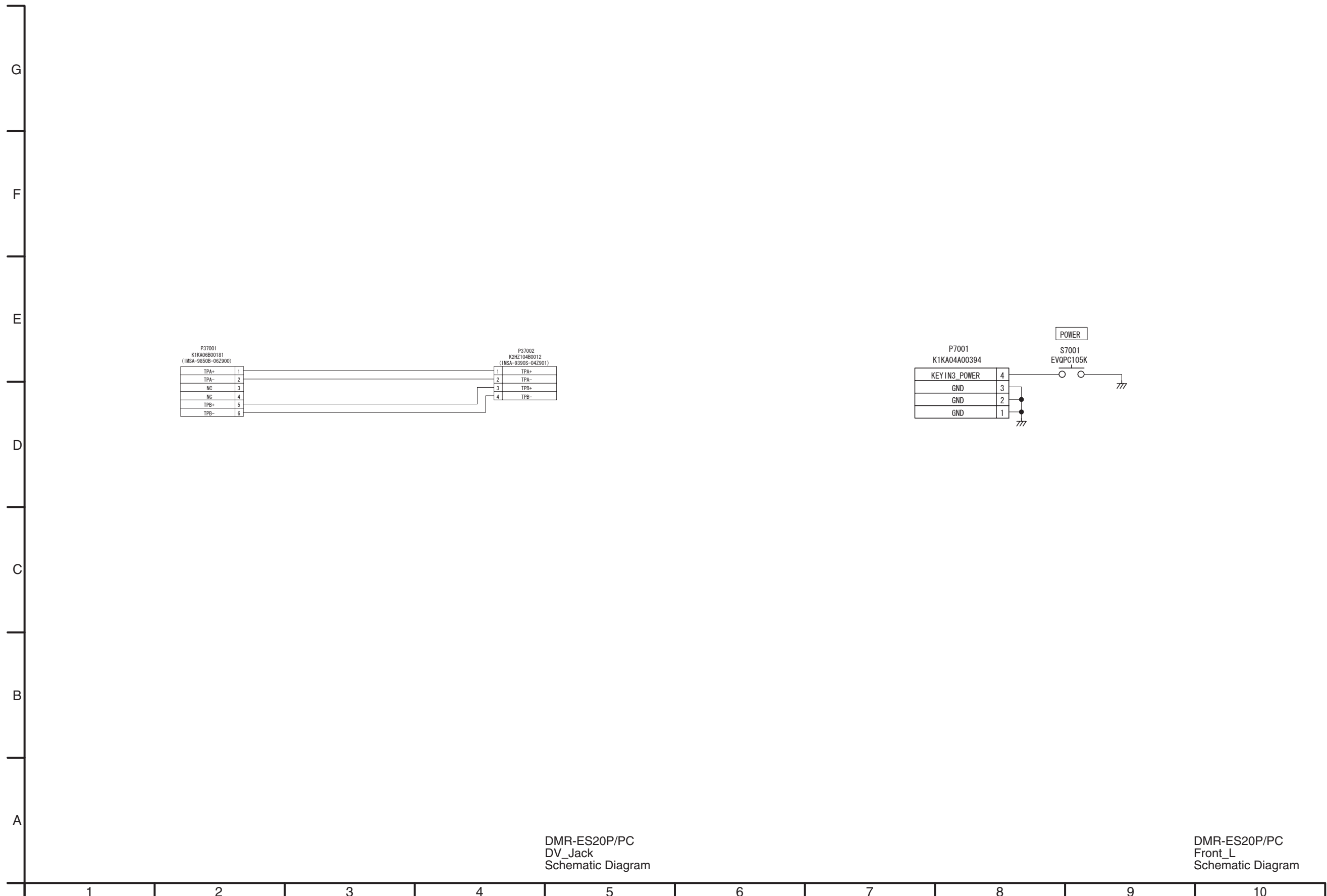

DMR-ES20P/PC
DV_Jack
Schematic Diagram

DMR-ES20P/PC
Front_L
Schematic Diagram

S5. Print.Circuit.Board.

S5.1. Main P.C.B.

S5.1.1. Main P.C.B.(Component Side) / S5.1.2. Main P.C.B.(Foil Side)

1/4	

DMR-ES20P/PC
Main P.C.B.



N
M
L
K
J
I
H
G

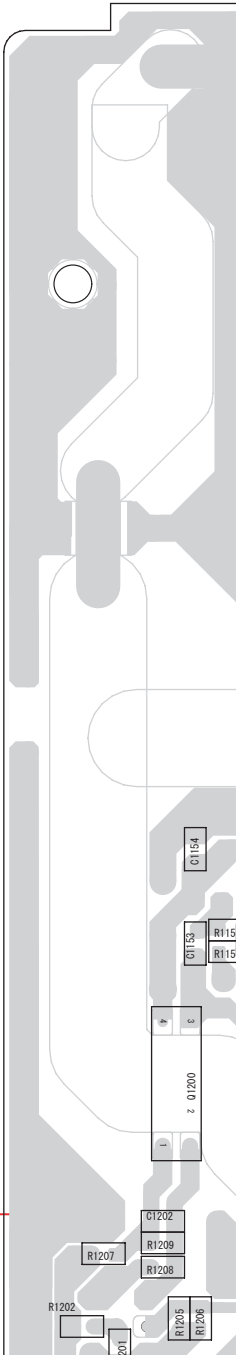
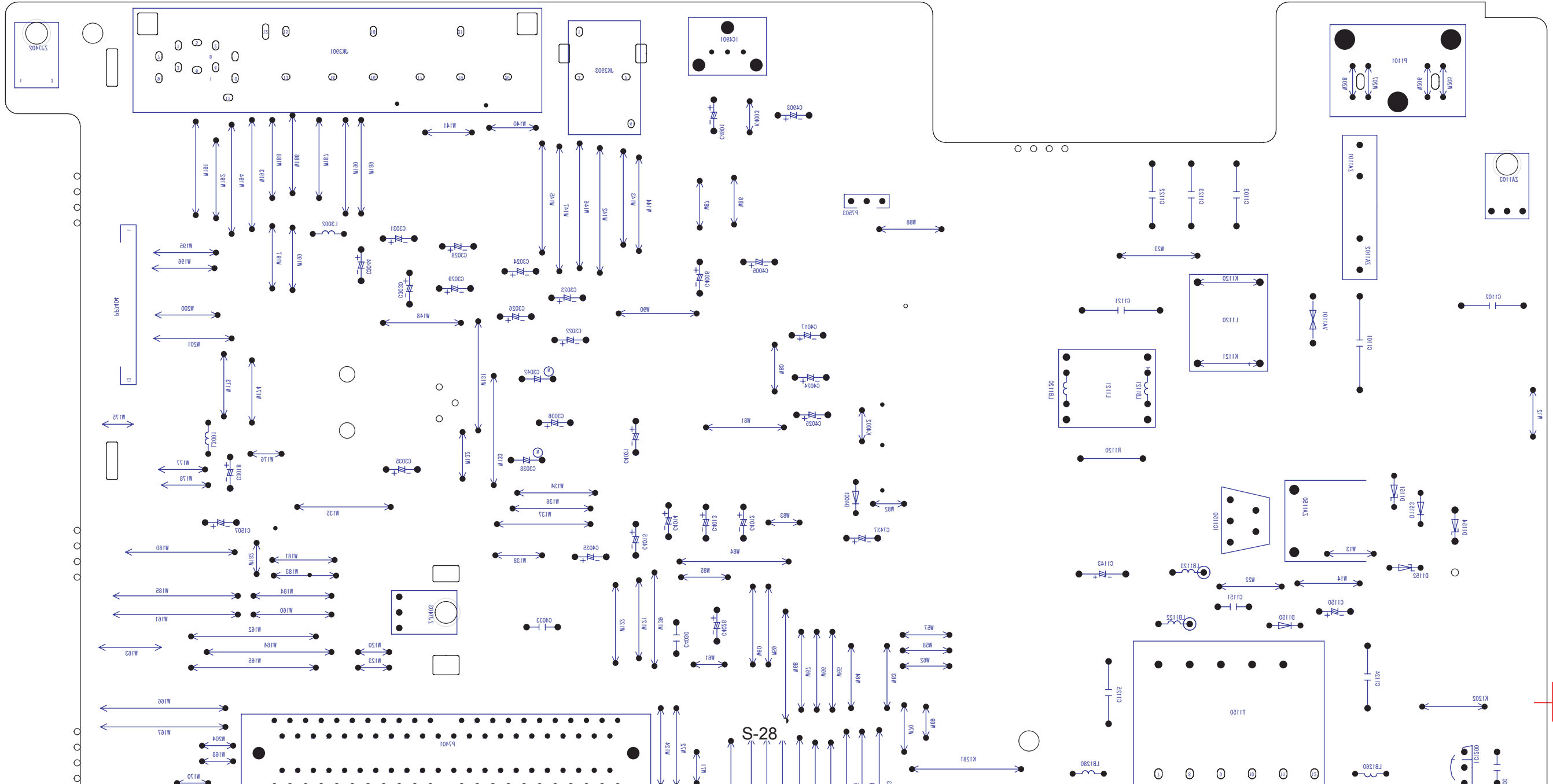

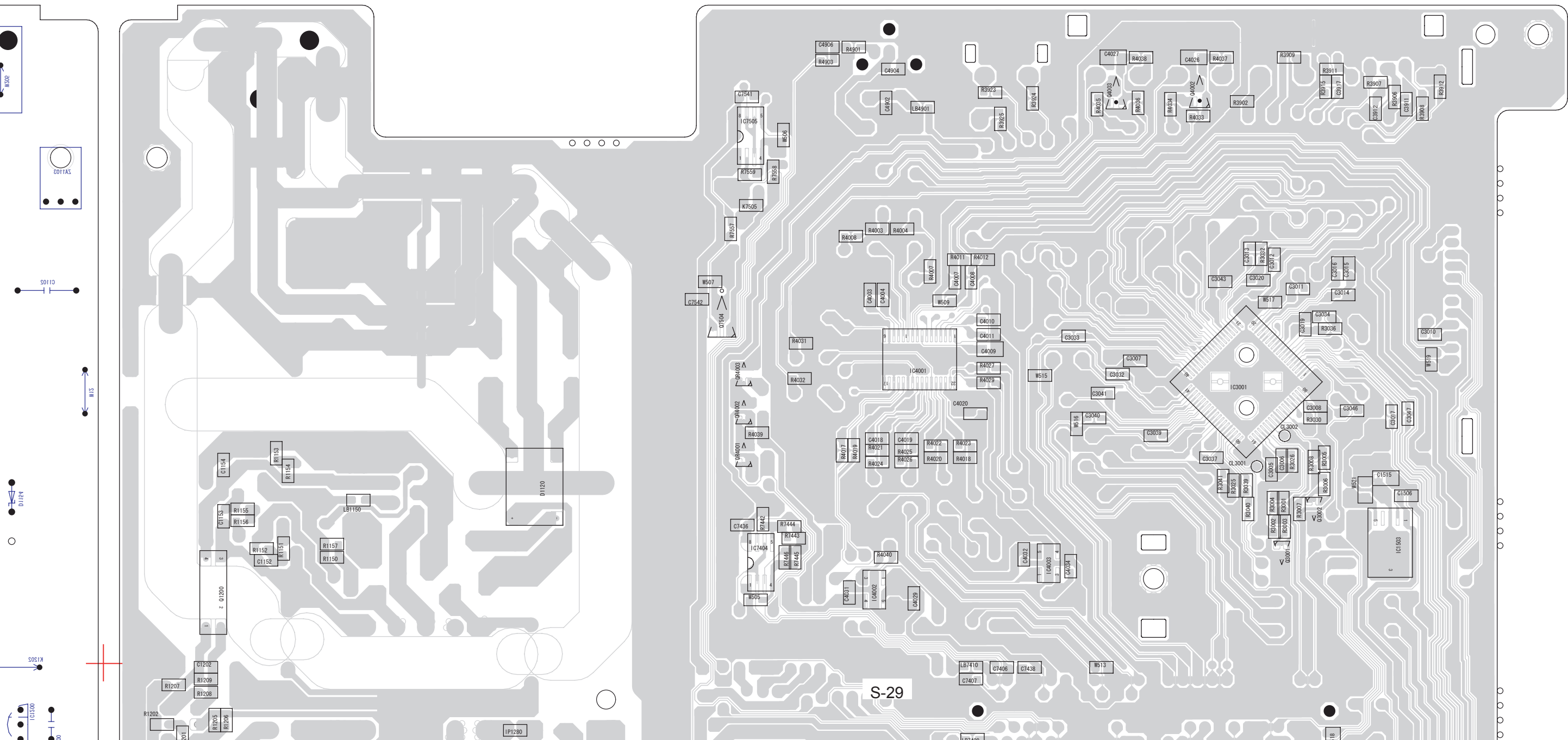

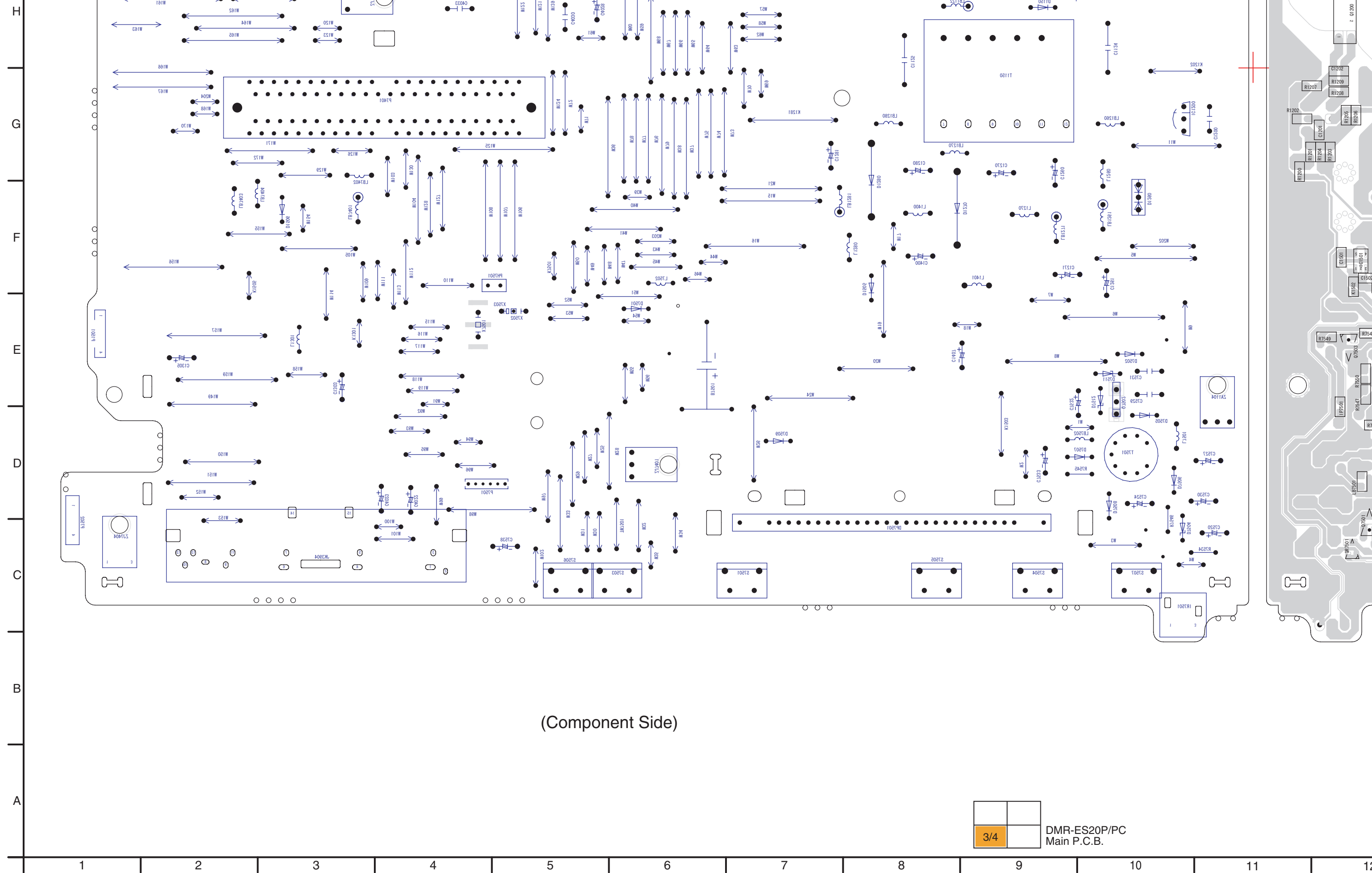

(Component Side)

3/4 DMR-ES20P/PC
Main P.C.B.



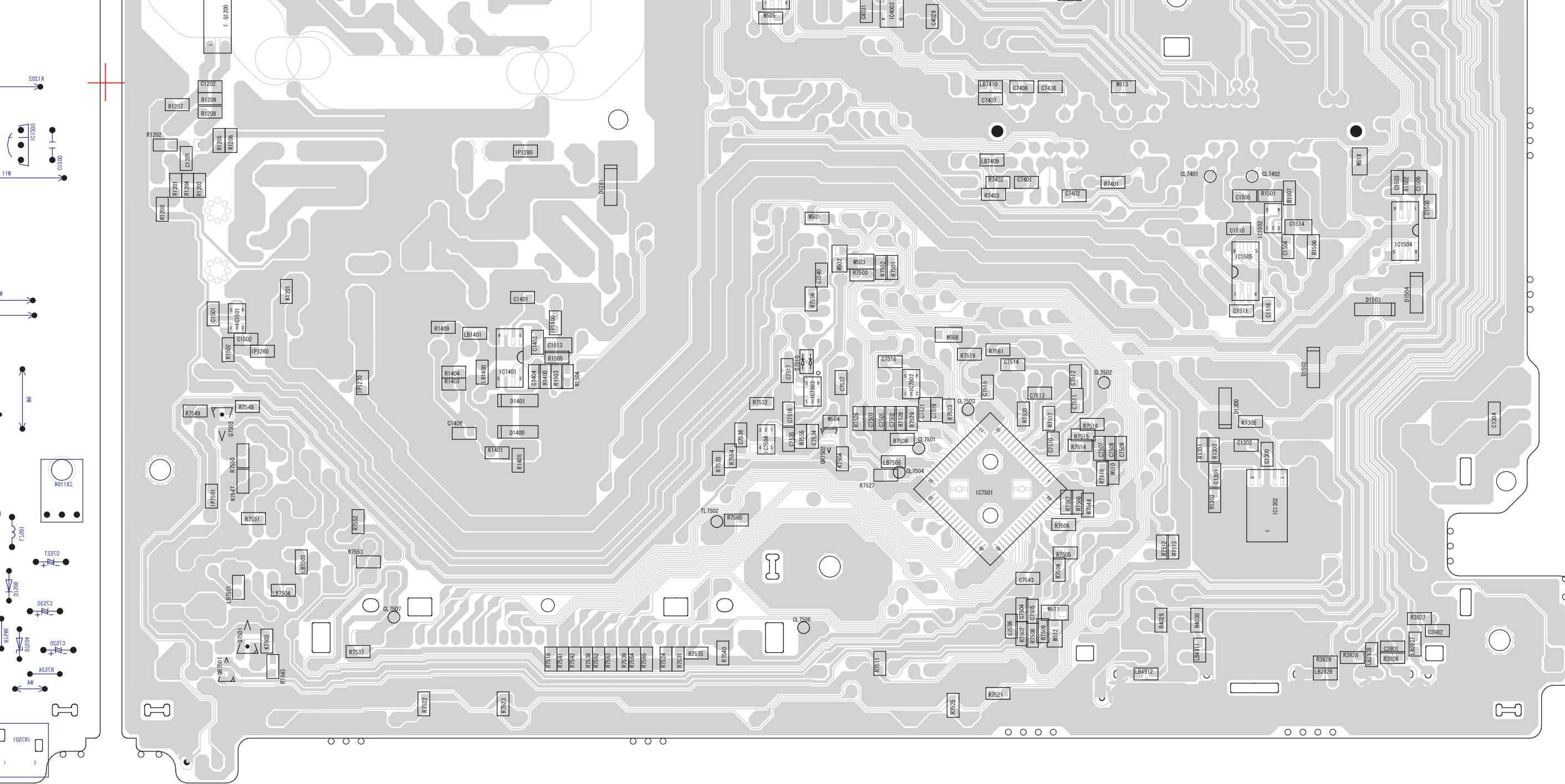

(Foil Side)

S5.2. DV_Jack P.C.B.

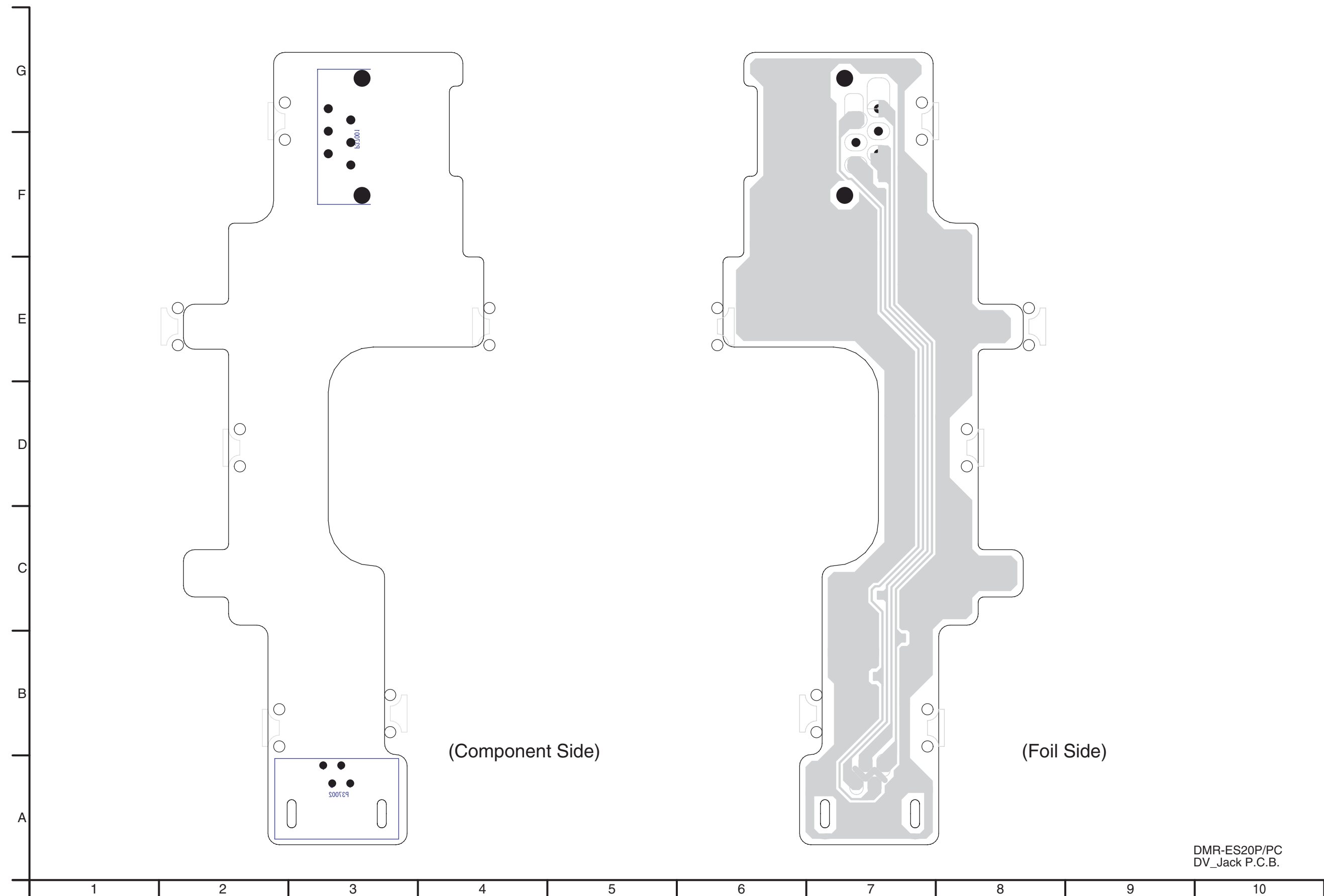

S5.3. Tuner Pack P.C.B.

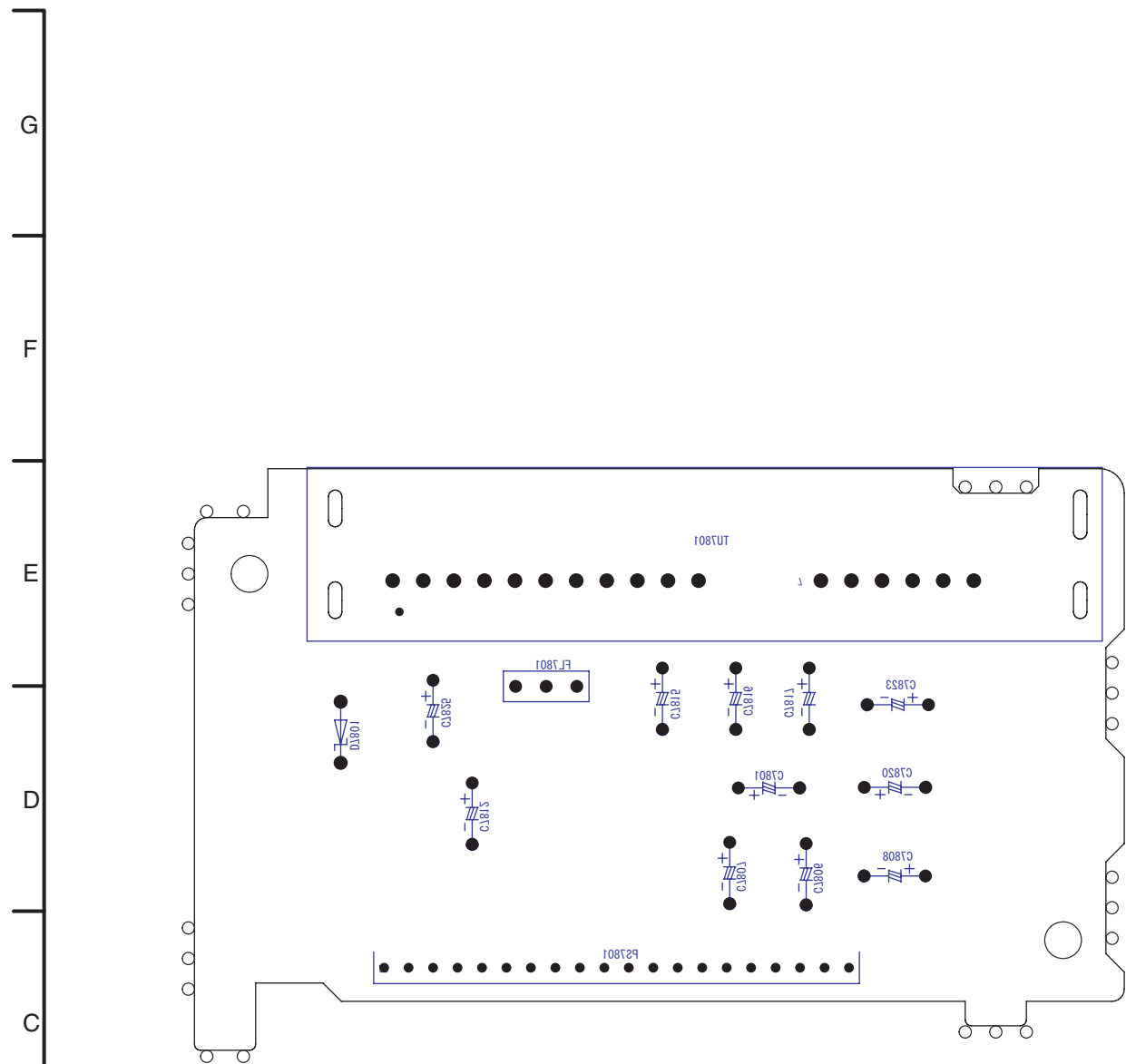

(Component Side)

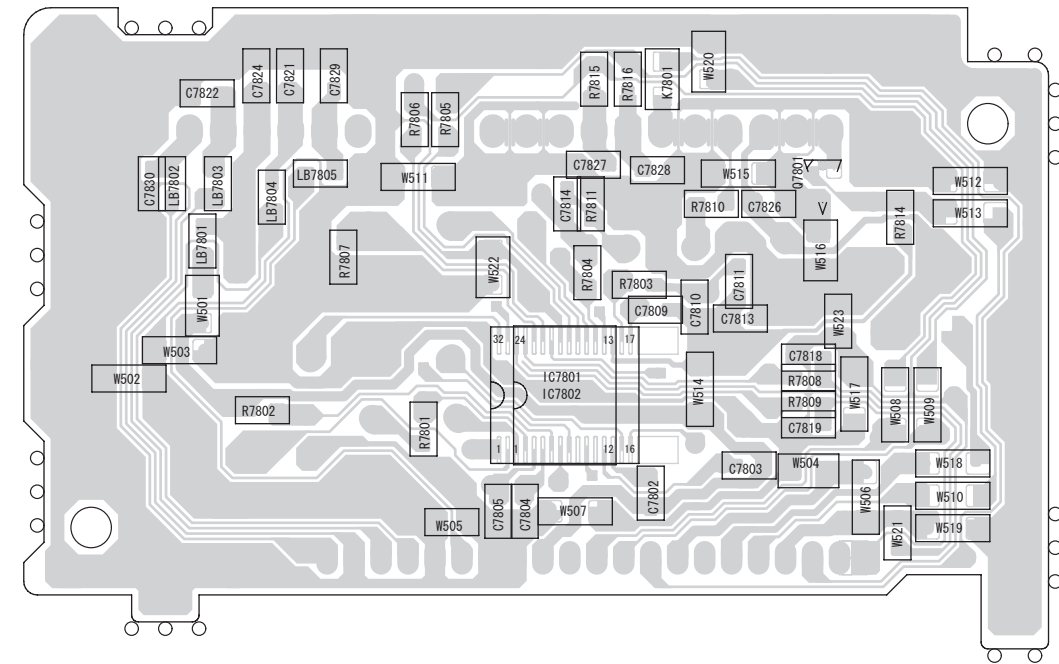

(Foil Side)

S5.4. Front_L P.C.B.

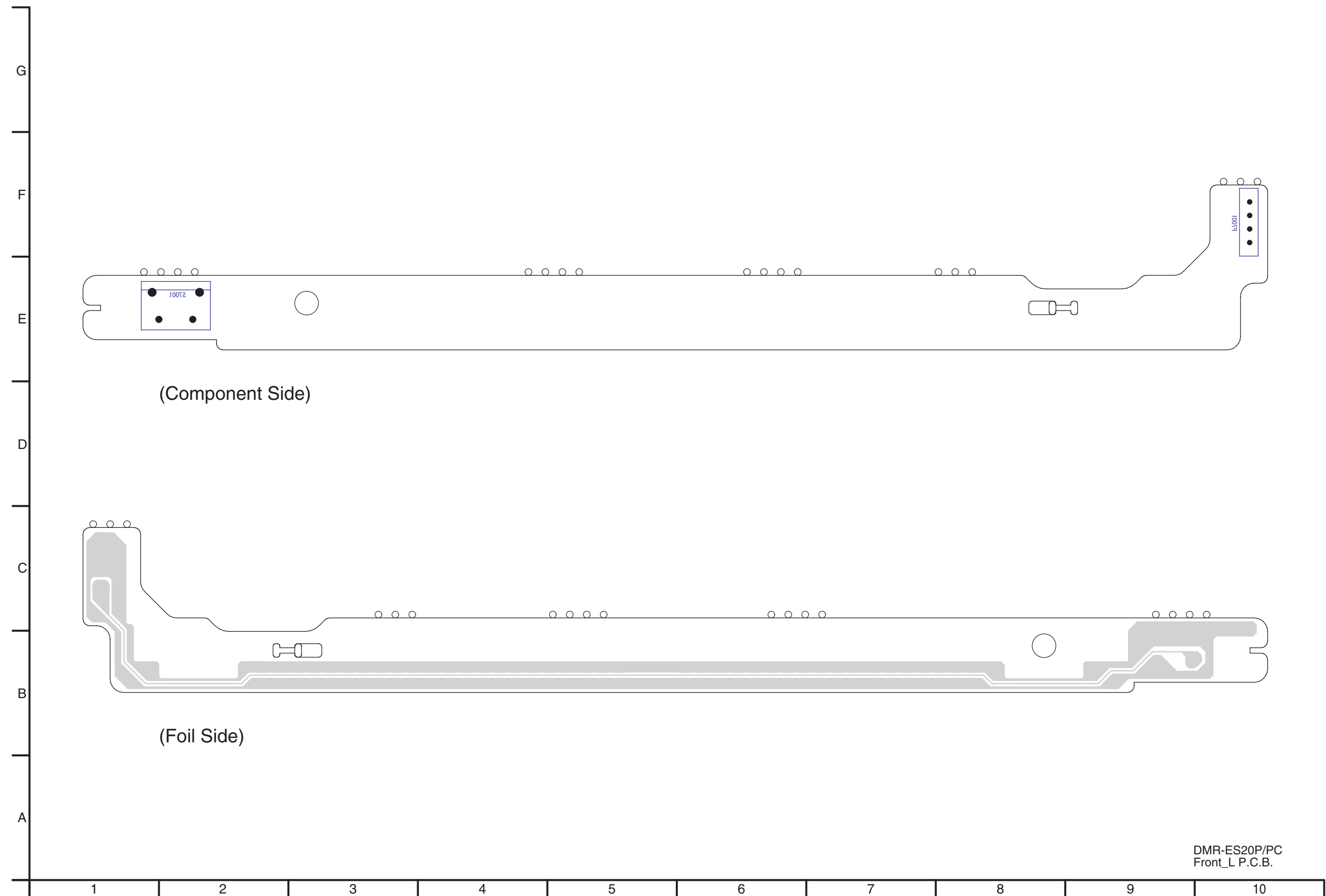

DMR-ES20P/PC
Front_L P.C.B.

S5. Replacement Parts List

- Note: 1.* Be sure to make your orders of replacement parts according to this list.
2. IMPORTANT SAFETY NOTICE
Components identified with the mark \triangle have the special characteristics for safety.
When replacing any of these components, use only the same type.
3. Unless otherwise specified,
All resistors are in OHMS, K=1,000 OHMS. All capacitors are in MICRO-FARADS (uf), P=uuF.
4. The marking (RTL) indicates the retention time is limited for this item. After the discontinuation of this assembly in production, it will no longer be available.

E.S.D. standards for Electrostatically Sensitive Devices, refer to “PREVENTION OF ELECTROSTATIC DISCHARGE (ESD) TO ELECTROSTATICALLY SENSITIVE (ES) DEVICES” section.

Definition of Parts supplier:

1. Parts marked with [PAVC-CSG] in the remarks column are supplied from PAVC COMPANY CS Group (PAVC-CSG).

DMR-ES20P-S
02

Ref.No.	Part No.	Part Name & Description	Pcs	Remarks
■	02	VEP79113B(MAIN P.C.B.)	1	(RTL)
△ C1101	ECQU2A104MLC	0.1U	1	
△ C1121	ECQU2A103MLA	0.01U	1	
△ C1122	ECKWNA102MEV	1000P	1	
△ C1123	ECKWNA102MEV	1000P	1	
△ C1125	ECKWNA102MEV	1000P	1	
C1143	EEUED2V101E	100U	1	
C1150	F2A1V5600013	35V 56U	1	
C1151	F1B3A182A009	250V 1800P	1	
C1152	ECJ1VC1H101J	50V 100P	1	
C1153	ECJ1VB1H222K	50V 2200P	1	
C1154	ECJ1VB1H102K	50V 1000P	1	
C1200	ECQV1H224JL3	50V 0.22U	1	
C1201	ECJ1VB1C473K	16V 0.047U	1	
C1202	ECJ1VB1C104K	16V 0.1U	1	
C1260	F2A1A152A543	10V 1500U	1	
C1261	F2A1A2210063	10V 220U	1	
C1270	F2A1C102A625	16V 1000U	1	
C1271	EEUFM1E221B	25V 220U	1	
C1280	F2A1A681A539	10V 680U	1	
C1281	F2A1E4700048	25V 47U	1	
C1300	ECJ1VB1A105K	10V 1U	1	
C1303	F2A1A2210063	10V 220U	1	
C1305	F2A1C1210012	25V 100U	1	
C1400	F2A1C471A628	16V 470U	1	
C1401	ECJ1VB1C104K	16V 0.1U	1	
C1402	ECJ1VB1H103K	50V 0.01U	1	
C1404	ECJ1VB1E273K	25V 0.027U	1	
C1406	ECJ1VB1A105K	10V 1U	1	
C1407	F2A1A122A542	10V 1200U	1	
C1501	ECJ1VB1A105K	10V 1U	1	
C1502	ECJ1VB1A105K	10V 1U	1	
C1503	ECJ1VB1H103K	50V 0.01U	1	
C1504	ECJ1VB1A105K	10V 1U	1	
C1505	ECJ1VB0J105K	6.3V 1U	1	
C1506	ECJ1VB1A105K	10V 1U	1	
C1507	F2A1A2210063	10V 47U	1	
C1508	ECJ1VB1A105K	10V 1U	1	
C1509	ECJ1VB0J105K	6.3V 1U	1	
C1510	ECJ1VB1A105K	10V 1U	1	
C1511	ECJ1VB0J105K	6.3V 1U	1	
C1513	F1J0J106A014	6.3V 10U	1	
C1514	F1J0J106A014	6.3V 10U	1	
C1516	ECJ1VB1H103K	50V 0.01U	1	
C3005	ECJ1VB1C333K	16V 0.033U	1	
C3006	ECJ1VB1C104K	16V 0.1U	1	
C3007	ECJ1VB1C104K	16V 0.1U	1	
C3008	ECJ1VB1C104K	16V 0.1U	1	
C3010	ECJ1VB1H103K	50V 0.01U	1	
C3011	ECJ1VB1H103K	50V 0.01U	1	
C3012	ECJ1VB1H103K	50V 0.01U	1	
C3013	ECJ1VB1H103K	50V 0.01U	1	
C3014	ECJ1VB1H103K	50V 0.01U	1	
C3015	ECJ1VB1H103K	50V 0.01U	1	
C3016	ECJ1VB1H103K	50V 0.01U	1	
C3017	ECJ1VB1H103K	50V 0.01U	1	
C3018	F2A0J1510006	6.3V 150U	1	
C3019	ECJ1VB1H103K	50V 0.01U	1	
C3020	ECJ1VB1H103K	50V 0.01U	1	
C3022	F2A0J471A247	6.3V 470U	1	
C3023	F2A1E470A205	25V 47U	1	
C3024	F2A0J331A247	6.3V 330U	1	
C3026	F2A0J331A247	6.3V 330U	1	
C3028	F2A1E470A205	25V 47U	1	
C3029	F2A0J471A247	6.3V 470U	1	
C3030	F2A1E470A205	25V 47U	1	
C3031	F2A0J471A247	6.3V 470U	1	
C3032	ECJ1VB1H103K	50V 0.01U	1	
C3033	ECJ1VB1H103K	50V 0.01U	1	
C3034	ECJ1VB1H103K	50V 0.01U	1	
C3035	F2A1H220A236	50V 22	1	
C3036	F2A1H100A236	50V 10U	1	

Ref.No.	Part No.	Part Name & Description	Pcs	Remarks
C3037	ECJ1VB1C104K	16V 0.1U	1	
C3038	F2J1C4700005	16V 47U	1	
C3039	ECJ1VB1C104K	16V 0.1U	1	
C3040	ECJ1VB1H103K	50V 0.01U	1	
C3041	ECJ1VB1C104K	16V 0.1U	1	
C3042	F2J1C4700005	16V 47U	1	
C3043	ECJ1VB1H103K	50V 0.01U	1	
C3044	F2A1E470A205	25V 47U	1	
C3046	ECJ1VB1H103K	50V 0.01U	1	
C3047	ECJ1VB1H103K	50V 0.01U	1	
C3901	ECJ1VB1C104K	16V 0.1U	1	
C3902	ECJ1VB1H103K	50V 0.01U	1	
C3911	ECJ1VB1C104K	16V 0.1U	1	
C3912	ECJ1VB1H103K	50V 0.01U	1	
C3917	ECJ1VB1H103K	50V 0.01U	1	
C4003	ECJ1VF1C104Z	16V 0.1U	1	
C4004	ECJ1VF1C104Z	16V 0.1U	1	
C4005	F2A1H1R0A236	50V 1U	1	
C4006	F2A1H1R0A236	50V 1U	1	
C4007	ECJ1VB1C105K	16V 1U	1	
C4008	ECJ1VB1C105K	16V 1U	1	
C4009	ECJ2VB1E104K	25V 0.1U	1	
C4010	ECJ1VF1C104Z	16V 0.1U	1	
C4011	ECJ1VF1C104Z	16V 0.1U	1	
C4012	F2A1E470A205	25V 47U	1	
C4013	F2A1E470A205	25V 47U	1	
C4014	F2A1H100A236	50V 10U	1	
C4015	F2A1H100A236	50V 10U	1	
C4017	ECA1CAM221XB	16V 220U	1	
C4018	ECJ1VC1H560J	50V 56P	1	
C4019	ECJ1VC1H560J	50V 56P	1	
C4020	ECJ1VF1C104Z	16V 0.1U	1	
C4021	ECA1CAM221XB	16V 220U	1	
C4022	F2A1H1R0A236	50V 1U	1	
C4023	F2A1H1R0A236	50V 1U	1	
C4024	F2A1E470A205	25V 47U	1	
C4025	F2A1E470A205	25V 47U	1	
C4026	ECJ2VC1H102J	50V 1000P	1	
C4027	ECJ2VC1H102J	50V 1000P	1	
C4028	F2A0J471A247	6.3V 470U	1	
C4029	ECJ1VF1C104Z	16V 0.1U	1	
C4030	ECQV1H104JL3	50V 0.1U	1	
C4031	ECJ1VF1C104Z	16V 0.1U	1	
C4032	ECJ1VF1C104Z	16V 0.1U	1	
C4033	ECQV1H104JL3	50V 0.1U	1	
C4035	ECA1CAM471XB	16V 470U	1	
C4903	F2A0J470A599	6.3V 47U	1	
C4904	ECJ1VF1C104Z	16V 0.1U	1	
C7406	ECJ1VB1C104K	16V 0.1U	1	
C7407	ECJ1VB1C104K	16V 0.1U	1	
C7436	ECJ1VB1C104K	16V 0.1U	1	
C7437	F2A0J470A013	6.3V 47U	1	
C7504	ECJ1VC1H101J	50V 100P	1	
C7505	ECJ1VC1H101J	50V 100P	1	
C7506	ECJ1VC1H101J	50V 100P	1	
C7507	ECJ1VB1H103K	50V 0.01U	1	
C7508	ECJ1VB1H103K	50V 0.01U	1	
C7509	ECJ1VB1H103K	50V 0.01U	1	
C7510	ECJ1VB1C104K	16V 0.1U	1	
C7511	ECJ1VC1H220J	50V 22P	1	
C7512	ECJ1VC1H220J	50V 22P	1	
C7513	ECJ1VC1H270J	50V 27P	1	
C7514	ECJ1VC1H180J	50V 18P	1	
C7515	ECJ1VB1C104K	16V 0.1U	1	
C7516	ECJ1VB1C104K	16V 0.1U	1	
C7518	ECJ1VB1H103K	50V 0.01U	1	
C7519	ECJ1VC1H101J	50V 100P	1	
C7520	F2A0J470A245	6.3V 47U	1	
C7521	ECJ1VB1H103K	50V 0.01U	1	
C7524	F2A1H100A248	50V 10U	1	
C7527	F2A1E221A210	25V 220U	1	
C7530	F2A1C221A243	16V 220U	1	
C7531	ECQB1H392KF3	50V 3900P	1	
C7532	F2A1V470A190	35V 47U	1	
C7533	F2A1H100A248	50V 10U	1	

DMR-ES20P-S
02

Ref.No.	Part No.	Part Name & Description	Pcs	Remarks
C7538	F2A0J102A581	6.3V 1000U	1	
C7540	ECJ1VF1A105Z	10V 1U	1	
C7541	ECJ1VB1H103K	50V 0.01U	1	
C7542	ECJ1VF1C104Z	16V 0.1U	1	
C7543	ECJ1VB1C104K	16V 0.1U	1	
D1120	B0EDKT000009	DIODE	1	
D1150	B0HAGM000006	DIODE	1	
D1151	MAZ4270NMF	DIODE	1	
D1152	MAZ4130NMF	DIODE	1	
D1153	MA2C165001VT	DIODE	1	
D1260	B0JBSE000021	DIODE	1	
D1270	B0JAQG000005	DIODE	1	
D1280	B0JAQE000004	DIODE	1	
D1281	B0JCPE000015	DIODE	1	
D1400	B0JCPD000021	DIODE	1	
D1401	B0JCPD000021	DIODE	1	
D1502	B0JCPE000015	DIODE	1	
D1503	B0JCPE000015	DIODE	1	
D1504	B0JCPE000015	DIODE	1	
D1505	MA2C165001VT	DIODE	1	
D1506	MA2C165001VT	DIODE	1	
D4001	MA2C165001VT	DIODE	1	
D7502	MA2C165001VT	DIODE	1	
D7504	MAZ4100NMF	DIODE	1	
D7506	B0AAGM000007	DIODE	1	
D7507	B0AADM000003	DIODE	1	
D7508	B0AADM000003	DIODE	1	
D7510	B0JDCE000002	DIODE	1	
D7511	MAZ4120NHF	DIODE	1	
D7512	B0BA03600021	DIODE	1	
DP7501	A2BD00000127	FL DISPLAY TUBE	1	
△ F1101	K5D162BK0005	FUSE	1	
IC1150	C0DACZH00022	IC	1	
IC1200	C0DAEMB00003	IC	1	
IC1302	C0DBEKG00004	IC	1	
IC1401	C0DBAKH00003	IC	1	
IC1501	C0CBCDC00054	IC	1	
IC1502	C0CBCDC00052	IC	1	
IC1503	C0CBCDG00006	IC	1	
IC1504	C0CBCBD00048	IC	1	
IC1505	C0CBCBD00048	IC	1	
IC3001	C1AB00001979	IC	1	
IC4001	C1AB00001920	IC	1	
IC4002	C0DBAHD00013	IC	1	
IC4003	C0CBCDC00027	IC	1	
IC4901	B3ZAZ0000016	IC	1	
IC7404	C0BBBA000085	IC	1	
IC7501	MN101C87ABC3	IC	1	
IC7502	C0EBE0000504	IC	1	
IC7503	C0EBJ0000110	IC	1	
IC7505	C0ABBA000146	IC	1	
IP1260	K5H2022A0011	IC PROTECTOR	1	
IP1270	K5H302100004	IC PROTECTOR	1	
IP1280	K5H302100004	IC PROTECTOR	1	
IP1400	K5H302100004	IC PROTECTOR	1	
IP7501	K5H7512A0010	IC PROTECTOR	1	
IR7501	B3RAD0000092	REMOTE SENSOR	1	
JK3901	K2HE219B0004	JACK,OUT/IN1	1	
JK3903	K2HA304B0007	JACK,COMPONENT VIDEO OU	1	
JK3904	K1U415B00001	JACK,DV IN/IN2	1	
K1201	ERJ3GEY0R00V	1/10W 0	1	
K1305	ERJ3GEY0R00V	1/10W 0	1	
K1401	ERJ3GEY0R00V	1/10W 0	1	
K1502	ERJ3GEY0R00V	1/10W 0	1	
K7503	ERJ3GEY0R00V	1/10W 0	1	
K7504	ERJ3GEY0R00V	1/10W 0	1	

Ref.No.	Part No.	Part Name & Description	Pcs	Remarks
△ L1120	G0B100E00002	COIL	1	
L1260	G0A100HA00023	COIL	1	
L1270	G0A100HA00023	COIL	1	
L1280	G0A220GA00026	COIL	1	
L1301	G0A220H00017	COIL	1	
L1400	G0A220GA00026	COIL	1	
L1401	G0A100ZA00041	COIL	1	
L3001	G0C220JA00019	COIL	1	
L3002	G0C220JA00019	COIL	1	
L7501	G0C390JA00055	COIL	1	
L7502	G0C220JA00019	COIL	1	
LB1120	J0JKB0000012	COIL	1	
LB1121	J0JKB0000012	COIL	1	
LB1122	J0JKB0000003	COIL	1	
LB1123	J0JKB0000003	COIL	1	
LB1150	J0JHC0000032	COIL	1	
LB1261	J0JKB0000003	COIL	1	
LB1271	J0JKB0000003	COIL	1	
LB1281	J0JKB0000003	COIL	1	
LB1400	J0JHC0000032	COIL	1	
LB1401	J0JHC0000032	COIL	1	
LB3927	J0JCC0000103	COIL	1	
LB3928	J0JCC0000103	COIL	1	
LB3929	J0JCC0000103	COIL	1	
LB4901	J0JHC0000032	COIL	1	
LB4911	J0JCC0000103	COIL	1	
LB4912	J0JCC0000103	COIL	1	
LB7401	J0JKB0000003	COIL	1	
LB7402	J0JKB0000012	COIL	1	
LB7403	J0JKB0000012	COIL	1	
LB7404	J0JKB0000012	COIL	1	
LB7409	J0JHC0000032	COIL	1	
LB7410	J0JHC0000032	COIL	1	
LB7501	ERJ3GEY0R00V	1/10W 0	1	
LB7503	ERJ3GEY0R00V	1/10W 0	1	
LB7504	ERJ3GEY0R00V	1/10W 0	1	
LB7505	ERJ3GEY0R00V	1/10W 0	1	
△ P1101	K2AB2B000007	AC INLET	1	
P1501	K1KA04AA0192	CONNECTOR(4P)	1	
P7401	K1KA88A00002	CONNECTOR(88P)	1	
P7502	K1KB04AA0063	CONNECTOR(4P)	1	
P7503	K1KA03AA0301	CONNECTOR(3P)	1	
PP7404	K1KA13AA0288	CONNECTOR(13P)	1	
△ Q1200	B3PBA0000237	TRANSISTOR	1	
Q3001	B1ADCF000063	TRANSISTOR	1	
Q3002	B1ABCF000020	TRANSISTOR	1	
Q4002	2SD0601A0L	TRANSISTOR	1	
Q4003	2SD0601A0L	TRANSISTOR	1	
Q7502	B1BABK000001	TRANSISTOR	1	
Q7503	2SD0601A0L	TRANSISTOR	1	
Q7504	B1ABMD000004	TRANSISTOR	1	
QR4001	UNR521100L	TRANSISTOR	1	
QR4002	UNR521100L	TRANSISTOR	1	
QR4003	UNR511100L	TRANSISTOR	1	
R1120	ERDS1TJ474B	1/4W 0.47K	1	
R1150	ERJ3GEYJ8R2V	1/10W 8.2	1	
R1151	ERJ3GEYJ103V	1/10W 10K	1	
R1152	ERJ3GEYJ752V	1/10W 7.5K	1	
R1153	ERJ3RBD183V	1/16W 18K	1	
R1154	ERJ3GEY0R00V	1/10W 0	1	
R1155	ERJ3RBD151V	1/16W 150	1	
R1156	ERJ3RBD682V	1/16W 6.8K	1	
R1157	ERJ3GEYJ8R2V	1/10W 8.2	1	
R1200	ERJ3RBD223V	1/16W 22K	1	
R1201	ERJ3GEY0R00V	1/10W 0	1	
R1202	ERJ3GEYJ103V	1/10W 10K	1	
R1203	ERJ3GEYJ184V	1/10W 180K	1	
R1204	ERJ3RBD562V	1/16W 5.6K	1	
R1206	ERJ3RBD242V	1/16W 2.4K	1	

DMR-ES20P-S
02

Ref.No.	Part No.	Part Name & Description	Pcs	Remarks
R1207	ERJ3RBD241V	1/16W 240	1	
R1208	ERJ3RBD222V	1/16W 2.2K	1	
R1209	ERJ3RBD102V	1/16W 1K	1	
R1301	ERJ3RBD393V	1/16W 39K	1	
R1302	ERJ3RBD122V	1/16W 1.2K	1	
R1303	ERJ3RBD103V	1/16W 10K	1	
R1400	ERJ3GEYJ103V	1/10W 10K	1	
R1403	ERJ3RBD562V	1/16W 5.6K	1	
R1409	ERJ3RBD103V	1/16W 10K	1	
R1503	ERJ3GEYJ332V	1/10W 3.3K	1	
R1504	ERJ3GEYJ101V	1/10W 100	1	
R1505	ERJ3GEYJ822V	1/10W 8.2K	1	
R1506	ERJ3GEYJ221V	1/10W 220	1	
R1507	ERJ3GEYJ223V	1/10W 22K	1	
R3002	ERJ3GEYJ471V	1/10W 470	1	
R3003	ERJ3GEYJ471V	1/10W 470	1	
R3004	ERJ3GEYJ220V	1/10W 22	1	
R3005	ERJ3GEYJ220V	1/10W 22	1	
R3006	ERJ3GEYJ471V	1/10W 470	1	
R3007	ERJ3GEYJ471V	1/10W 470	1	
R3025	ERJ3RBD153V	1/16W 15K	1	
R3026	ERJ3GEYJ105V	1/10W 1M	1	
R3030	ERJ3GEYJ750V	1/10W 75	1	
R3032	ERJ3GEYJ103V	1/10W 10K	1	
R3036	ERJ3GEYJ103V	1/10W 10K	1	
R3039	ERJ3GEYJ221V	1/10W 220	1	
R3040	ERJ3GEYJ221V	1/10W 220	1	
R3041	ERJ3RBD104V	1/16W 100K	1	
R3902	ERJ3GEYJ750V	1/10W 75	1	
R3906	ERJ3GEYJ102V	1/10W 1K	1	
R3907	ERJ3GEYJ750V	1/10W 75	1	
R3908	ERJ3GEYJ750V	1/10W 75	1	
R3909	ERJ3GEYJ750V	1/10W 75	1	
R3911	ERJ3GEYJ750V	1/10W 75	1	
R3912	ERJ3GEYJ750V	1/10W 75	1	
R3915	ERJ3GEYJ912V	1/10W 9.1K	1	
R3923	ERJ3GEYJ750V	1/10W 75	1	
R3924	ERJ3GEYJ750V	1/10W 75	1	
R3925	ERJ3GEYJ750V	1/10W 75	1	
R3926	ERJ3GEYJ102V	1/10W 1K	1	
R3927	ERJ3GEYJ750V	1/10W 75	1	
R3928	ERJ3GEYJ750V	1/10W 75	1	
R3929	ERJ3GEYJ750V	1/10W 75	1	
R4003	ERJ3GEYJ104V	1/10W 100K	1	
R4004	ERJ3GEYJ104V	1/10W 100K	1	
R4007	ERJ3GEYJ102V	1/10W 1K	1	
R4008	ERJ3GEYJ102V	1/10W 1K	1	
R4011	ERJ3GEYJ104V	1/10W 100K	1	
R4012	ERJ3GEYJ104V	1/10W 100K	1	
R4017	ERJ3GEYJ101V	1/10W 100	1	
R4018	ERJ3RBD622V	1/16W 6.2K	1	
R4019	ERJ3GEYJ101V	1/10W 100	1	
R4020	ERJ3RBD622V	1/16W 6.2K	1	
R4021	DOHB153ZA002	1/10W 15K	1	
R4022	ERJ3RBD392V	1/16W 3.9K	1	
R4023	ERJ3RBD392V	1/16W 3.9K	1	
R4024	DOHB103ZA002	1/10W 10K	1	
R4025	DOHB153ZA002	1/10W 15K	1	
R4026	DOHB103ZA002	1/10W 10K	1	
R4027	ERJ3GEYJ102V	1/10W 1K	1	
R4028	ERJ3GEYJ104V	1/10W 100K	1	
R4029	ERJ3GEYJ102V	1/10W 1K	1	
R4030	ERJ3GEYJ104V	1/10W 100K	1	
R4031	ERJ3GEYJ473V	1/10W 47K	1	
R4032	ERJ3GEYJ473V	1/10W 47K	1	
R4033	ERJ3GEYJ681V	1/10W 680	1	
R4034	ERJ3GEYJ821V	1/10W 820	1	
R4035	ERJ3GEYJ821V	1/10W 820	1	
R4036	ERJ3GEYJ681V	1/10W 680	1	
R4037	ERJ3GEYJ221V	1/10W 220	1	
R4038	ERJ3GEYJ221V	1/10W 220	1	
R4039	ERJ3GEYJ103V	1/10W 10K	1	
R4040	ERJ3GEY0R00V	1/10W 0	1	
R4901	ERJ3GEY0R00V	1/10W 0	1	
R4903	ERJ3GEY0R00V	1/10W 0	1	

Ref.No.	Part No.	Part Name & Description	Pcs	Remarks
R7401	ERJ3GEY0R00V	1/10W 0	1	
R7402	ERJ3GEYJ472V	1/10W 4.7K	1	
R7403	ERJ3GEYJ472V	1/10W 4.7K	1	
R7442	ERJ3RBD222V	1/16W 2.2K	1	
R7443	ERJ3RBD102V	1/16W 1K	1	
R7444	ERJ3RBD153V	1/16W 15K	1	
R7445	ERJ3RBD222V	1/16W 2.2K	1	
R7446	ERJ3RBD133V	1/16W 13K	1	
R7501	ERJ3GEYJ473V	1/10W 47K	1	
R7502	ERJ3GEYJ473V	1/10W 47K	1	
R7504	ERJ3GEYJ101V	1/10W 100	1	
R7505	ERJ3GEYJ101V	1/10W 100	1	
R7506	ERJ3GEYJ101V	1/10W 100	1	
R7508	ERJ3GEYJ473V	1/10W 47K	1	
R7509	ERJ3GEYJ473V	1/10W 47K	1	
R7510	ERJ3GEYJ101V	1/10W 100	1	
R7511	ERJ3GEYJ822V	1/10W 8.2K	1	
R7512	ERJ3GEYJ822V	1/10W 8.2K	1	
R7513	ERJ3GEYJ822V	1/10W 8.2K	1	
R7514	ERJ3GEYJ101V	1/10W 100	1	
R7515	ERJ3GEYJ101V	1/10W 100	1	
R7516	ERJ3GEYJ101V	1/10W 100	1	
R7517	ERJ3GEY0R00V	1/10W 0	1	
R7519	ERJ3GEYJ103V	1/10W 10K	1	
R7520	ERJ3GEYJ473V	1/10W 47K	1	
R7521	ERJ3GEYJ272V	1/10W 2.7K	1	
R7522	ERJ3GEYJ562V	1/10W 5.6K	1	
R7523	ERJ3GEYJ222V	1/10W 2.2K	1	
R7525	ERJ3GEYJ272V	1/10W 2.7K	1	
R7526	ERJ3GEYJ101V	1/10W 100	1	
R7527	ERJ3GEYJ104V	1/10W 100K	1	
R7528	ERJ3GEYJ101V	1/10W 100	1	
R7529	ERJ3GEYJ101V	1/10W 100	1	
R7530	ERJ3GEYJ823V	1/10W 0	1	
R7532	ERJ3GEYJ473V	1/10W 47K	1	
R7533	ERJ3GEYJ101V	1/10W 100	1	
R7534	ERDS2TJ470T	1/4W 47	1	
R7536	ERJ3GEYJ473V	1/10W 47K	1	
R7544	ERJ3GEYJ473V	1/10W 47K	1	
R7545	ERDS2TJ331T	1/4W 330	1	
R7546	ERDS2TJ1R0T	1/4W 1.0	1	
R7548	ERJ3GEYJ103V	1/10W 10K	1	
R7549	ERJ3GEYJ473V	1/10W 47K	1	
R7550	ERJ3GEYJ562V	1/10W 5.6K	1	
R7551	ERJ3GEYJ470V	1/10W 47	1	
R7552	ERJ3GEYJ473V	1/10W 47K	1	
R7553	ERJ3GEYJ473V	1/10W 47K	1	
R7556	ERJ3GEYJ103V	1/10W 10K	1	
R7557	ERJ3GEYJ821V	1/10W 820	1	
R7558	ERJ3GEYJ183V	1/10W 18K	1	
R7559	ERJ3GEYJ103V	1/10W 10K	1	
R7561	ERJ3GEYJ473V	1/10W 47K	1	
R7566	ERJ3GEYJ473V	1/10W 47K	1	
R7567	ERJ3GEYJ473V	1/10W 47K	1	
S7501	EVQPC105K	SWITCH,OPEN/CLOSE	1	
S7503	EVQPC105K	SWITCH,CH UP	1	
S7504	EVQPC105K	SWITCH,PLAY	1	
S7505	EVQPC105K	SWITCH,STOP	1	
S7506	EVQPC105K	SWITCH,CH DOWN	1	
S7507	EVQPC105K	SWITCH,REC	1	
△ T1150	G4D2A0000249	TRANSFORMER	1	
T7501	G4D1A0000115	TRANSFORMER	1	
△ VA1101	ERZV10D471CS	V.R.	1	
W501	ERJ3GEY0R00V	1/10W 0	1	
W502	ERJ6GEY0R00V	1/8W 0	1	
W503	ERJ6GEY0R00V	1/8W 0	1	
W504	ERJ3GEY0R00V	1/10W 0	1	
W505	ERJ3GEY0R00V	1/10W 0	1	
W506	ERJ3GEY0R00V	1/10W 0	1	
W507	ERJ3GEY0R00V	1/10W 0	1	
W508	ERJ6GEY0R00V	1/8W 0	1	

DMR-ES20P-S
02 / 03 / 04 / 06 / M1

Ref.No.	Part No.	Part Name & Description	Pcs	Remarks
W509	ERJ3GEY0R00V	1/10W 0	1	
W510	ERJ3GEY0R00V	1/10W 0	1	
W511	ERJ6GEY0R00V	1/8W 0	1	
W512	ERJ6GEY0R00V	1/8W 0	1	
W513	ERJ3GEY0R00V	1/10W 0	1	
W515	ERJ3GEY0R00V	1/10W 0	1	
W516	ERJ3GEY0R00V	1/10W 0	1	
W517	ERJ3GEY0R00V	1/10W 0	1	
W518	ERJ6GEY0R00V	1/8W 0	1	
W519	ERJ3GEY0R00V	1/10W 0	1	
W521	ERJ6GEY0R00V	1/8W 0	1	
X7501	H0D800400020	CRYSTAL OSCILLATOR	1	
X7503	H0A327200115	CRYSTAL OSCILLATOR	1	
ZA1101	EYF52BCY	FUSE HOLDER	1	
ZA1102	EYF52BCY	FUSE HOLDER	1	
ZB7501	RMN0826	FL HOLDER	1	
■	03	VEP07A83B/RFKBES20PC(TUN	1	(RTL)
C7801	F2A1H2R2A236	50V 2.2U	1	
C7802	ECJ1VB1C333K	16V 0.033U	1	
C7803	ECJ1VB1C104K	16V 0.1U	1	
C7804	ECJ1VB1E223K	25V 0.022U	1	
C7805	ECJ1VB1C104K	16V 0.1U	1	
C7806	F2A1H3R3A234	50V 3.3U	1	
C7807	F2A1HR33A236	50V 33	1	
C7808	F2A1V100A184	35V 10U	1	
C7809	ECJ1VF1C334Z	16V 0.33U	1	
C7810	ECJ1VB1C104K	16V 0.1U	1	
C7811	ECJ1VB1A224K	10V 0.22U	1	
C7812	F2A1A470A211	10V 47U	1	
C7813	ECJ1VB1H103K	50V 0.01U	1	
C7814	ECJ1VB1H102K	50V 1000P	1	
C7815	F2A1H4R7A248	50V 4.7U	1	
C7816	F2A1H2R2A236	50V 2.2U	1	
C7817	F2A1H2R2A236	50V 2.2U	1	
C7818	ECJ1VB1E223K	25V 0.022U	1	
C7819	ECJ1VB1E223K	25V 0.022U	1	
C7820	F2A1H2R2A234	50V 2.2U	1	
C7823	F2A0J470A245	6.3V 47U	1	
C7824	ECJ1VB1H103K	50V 0.01U	1	
C7825	F2A1H1R00071	50V 1U	1	
C7826	ECJ1VB1H103K	50V 0.01U	1	
D7801	MAZ73000BC	DIODE	1	
FL7801	EFCT4R5MS5W	FILTER	1	
IC7801	AN5832SA-E1V	IC	1	
K7801	ERJ6GEY0R00V	1/8W 0	1	
LB7801	J0JHC0000032	COIL	1	
PS7801	K1KB13B00013	CONNECTOR(FEMALE) 13P	1	
Q7801	2SB1218A0L	TRANSISTOR	1	
R7801	ERJ3GEY0R00V	1/10W 0	1	
R7802	ERJ3GEYJ103V	1/10W 10K	1	
R7803	ERJ3GEYJ332V	1/10W 3.3K	1	
R7804	ERJ3GEY0R00V	1/10W 0	1	
R7805	ERJ3GEYJ331V	1/10W 330	1	
R7806	ERJ3GEYJ331V	1/10W 330	1	
R7807	ERJ3GEYJ184V	1/10W 180K	1	
R7808	ERJ3GEYJ331V	1/10W 330	1	
R7809	ERJ3GEYJ331V	1/10W 330	1	
R7810	ERJ3GEY0R00V	1/10W 0	1	
R7811	ERJ3GEYJ102V	1/10W 1K	1	
R7812	ERDS2TYJ102T	1/4W 1000	1	

Ref.No.	Part No.	Part Name & Description	Pcs	Remarks
R7814	ERJ3GEYJ681V	1/10W 680	1	
R7815	ERJ3GEYJ101V	1/10W 100	1	
R7816	ERJ3GEYJ101V	1/10W 100	1	
TU7801	ENGF6503GRF	TUNER PACK	1	
W501	ERJ6GEY0R00V	1/8W 0	1	
W502	ERJ8GEY0R00V	1/4W 0	1	
W503	ERJ8GEY0R00V	1/4W 0	1	
W504	ERJ6GEY0R00V	1/8W 0	1	
W505	ERJ3GEY0R00V	1/10W 0	1	
W506	ERJ8GEY0R00V	1/4W 0	1	
W507	ERJ8GEY0R00V	1/4W 0	1	
W508	ERJ8GEY0R00V	1/4W 0	1	
W509	ERJ8GEY0R00V	1/4W 0	1	
W510	ERJ8GEY0R00V	1/4W 0	1	
W511	ERJ8GEY0R00V	1/4W 0	1	
W512	ERJ8GEY0R00V	1/4W 0	1	
W513	ERJ8GEY0R00V	1/4W 0	1	
W514	ERJ8GEY0R00V	1/4W 0	1	
W515	ERJ8GEY0R00V	1/4W 0	1	
W516	ERJ6GEY0R00V	1/8W 0	1	
W517	ERJ8GEY0R00V	1/4W 0	1	
W518	ERJ8GEY0R00V	1/4W 0	1	
W519	ERJ8GEY0R00V	1/4W 0	1	
W520	ERJ6GEY0R00V	1/8W 0	1	
W521	ERJ3GEY0R00V	1/10W 0	1	
W522	ERJ6GEY0R00V	1/8W 0	1	
W523	ERJ3GEY0R00V	1/10W 0	1	
■	04	VEP73132A(DV JACK P.C.B.)	1	(RTL)
P37001	K1KA06B00181	CONNECTOR(6P)	1	
P37002	K2HZ104B0012	CONNECTOR(104P)	1	
■	06	VEP70124A(FRONT(L)P.C.B.)	1	(RTL)
P7001	K1KA04A00394	CONNECTOR(4P)	1	
S7001	EVQPC105K	SWITCH,POWER	1	
■	M1	M1_GAISO	1	(RTL)
1	VEP07A83B	TUNER P.C.B.	1	(RTL)
2	VEP79113B	MAIN P.C.B.	1	(RTL)
3	VEP79115A	DIGITAL P.C.B.	1	(RTL)(PS)(PK)
3	RFKBES20PC	DIGITAL P.C.B.	1	(RTL)(PCS)
4	RMC0665	EARTH SPRING	1	
△ 5	RGR0358A-A1A	REAR PANEL	1	(PS)(PK)
△ 5	RGR0358A-B1A	REAR PANEL	1	(PCS)
6	RXX0295	HEAT SINK	1	
7	VEE1A60	WIRE WITH CONNECTOR(4P)	1	
8	RMA1938	DIGITAL ANGLE A	1	
9	VWJ1821	FFC(40P)	1	
10	RMA1939	DIGITAL ANGLE B	1	
11	RMA1961	SUPPORT ANGLE	1	
12	RYP1268F-S2	FRONT PANEL ASS'Y 1	1	(PS)(PCS)
12	RYP1268F-K2	FRONT PANEL ASS'Y 1	1	(PK)
12-1	RGK1886-Q1	FL ORNAMENT	1	
12-2	RHD26045-L	SCREW	1	
12-3	RKF0729F-S	PANEL DOOR	1	(PS)(PCS)
12-3	RKF0729F-K	PANEL DOOR	1	(PK)
12-4	RMR1698-S	SHAFT HOLDER	1	(PS)(PCS)
12-4	RMR1698-K	SHAFT HOLDER	1	(PK)
12-5	RKF0728B-K	TRAY DOOR	1	
12-6	RMX0302	DOOR DAMPER	1	
12-7	RGK1885-S	REC BUTTON RING	1	
12-8	VMB3410	TRAY SPRING	1	
13	RMQ1454	SHEET	1	

DMR-ES20P-S
M1 / M2

Ref.No.	Part No.	Part Name & Description	Pcs	Remarks	Ref.No.	Part No.	Part Name & Description	Pcs	Remarks
14	RMX0335	DRIVE CUSHION	1		PC1	RPG7660	PACKING CASE	1	(PK)
15	RMZ0784	INSULATION SHEET	1		PC1	RPG7661	PACKING CASE	1	(PCS)
16	RMC0654	SPRING	1		PC2	RPN1817-1	CUSHION	1	
17	VEP70124A	FRONT (L) P. C. B.	1	(RTL)	PC3	RPFX0058	MIRAMAT SHEET	1	
△ 18	RKM0536-S	TOP CASE	1	(PS) (PCS)					
△ 18	RKM0536-K	TOP CASE	1	(PK)					
19	VHN0338	NYLON RIVET	1						
20	RFKNVXY1867	RAM DRIVE UNIT	1	(RTL) (PAVC-CSG)					
20-1	RMV0307	BARRIER	1	(PAVC-CSG)					
21	XSN3+4FJ	SCREW	1						
22	VJF0036	NYLON RIVET	1						
23	VJF0036	NYLON RIVET	1						
24	VEP73132A	DV JACK P. C. B.	1	(RTL)					
25	RG00435-H	GASKET	1						
26	L6FAJCCH0007	FAN MOTOR	1						
27	RHD30115-3	SCREW	1						
28	RHD30115-3	SCREW	1						
29	RHD30115-3	SCREW	1						
30	RHD30119-S	SCREW	1						
31	RHD30119-S	SCREW	1						
32	RHD30119-S	SCREW	1						
33	RHD30119-S	SCREW	1						
34	RHD30119-S	SCREW	1						
35	RHD30119-S	SCREW	1						
36	RHD30119-S	SCREW	1						
37	RHD30119-S	SCREW	1						
38	RHD30119-S	SCREW	1						
39	RHD30119-S	SCREW	1						
40	RHD30119-S	SCREW	1						
41	RHD30119-S	SCREW	1						
42	RHD30119-S	SCREW	1						
43	RHD30005-1	SCREW	1						
44	RHD30005-1	SCREW	1						
45	RHD30005-1	SCREW	1						
46	RHD30005-1	SCREW	1						
47	RHD30005-1	SCREW	1						
48	RHD30005-1	SCREW	1						
49	RHD30005-1	SCREW	1						
50	RHD30005-1	SCREW	1						
51	RHD30005-1	SCREW	1						
52	RHD30005-1	SCREW	1						
53	RKA0144-T	LEG RUBBER	1						
54	RKA0144-T	LEG RUBBER	1						
55	RKA0144-T	LEG RUBBER	1						
56	RKA0144-T	LEG RUBBER	1						
57	RKA0144-T	LEG RUBBER	1						
58	RHD30142	SCREW	1						
59	RHD30142	SCREW	1						
60	RHD30142	SCREW	1						
61	RHD30142	SCREW	1						
62	XYN3+F8FJ	SCREW	1						
63	XYN3+F8FJ	SCREW	1						
64	RHD30113	SCREW	1	(PS) (PCS)					
64	RHD30113-K	SCREW	1	(PK)					
65	RHD30113	SCREW	1	(PS) (PCS)					
65	RHD30113-K	SCREW	1	(PK)					
66	RMX0340	GASKET	1						
■ M2	M2_HOUS0		1	(RTL)					
A1	N2QAKB000055	REMOTE CONTROL ASS'Y	1						
A1-1	BNL11M201B	BATTERY COVER	1						
△ A2	K2CB2CB00018	AC CORD	1						
A3	K2KA6BA00003	AV CORD	1						
A4	K2KZ2BA00001	RF COAXIAL CABLE	1						
A5	RPQF0220-1	ACCESSORY CASE	1						
A6	RPFX0067-1	POLYETHYLENE BAG (F. B.)	1						
A7	RQCA1399	SET-UP GUIDE	1						
A7	RQCA1408	SET-UP GUIDE	1	(PCS)					
△ A9	RQT8152-P	OPERATING INSTRUCTIONS	1	(IA)					
△ A9	RQT8163-C	OPERATING INSTRUCTIONS	1	(IB) (PCS)					
A10	RQCC2703	DVD MEDIA SHEET	1	(PS) (PK)					
PC1	RPG7659	PACKING CASE	1	(PS)					

S7. Exploded Views

S7.1. Frame & Casing Section

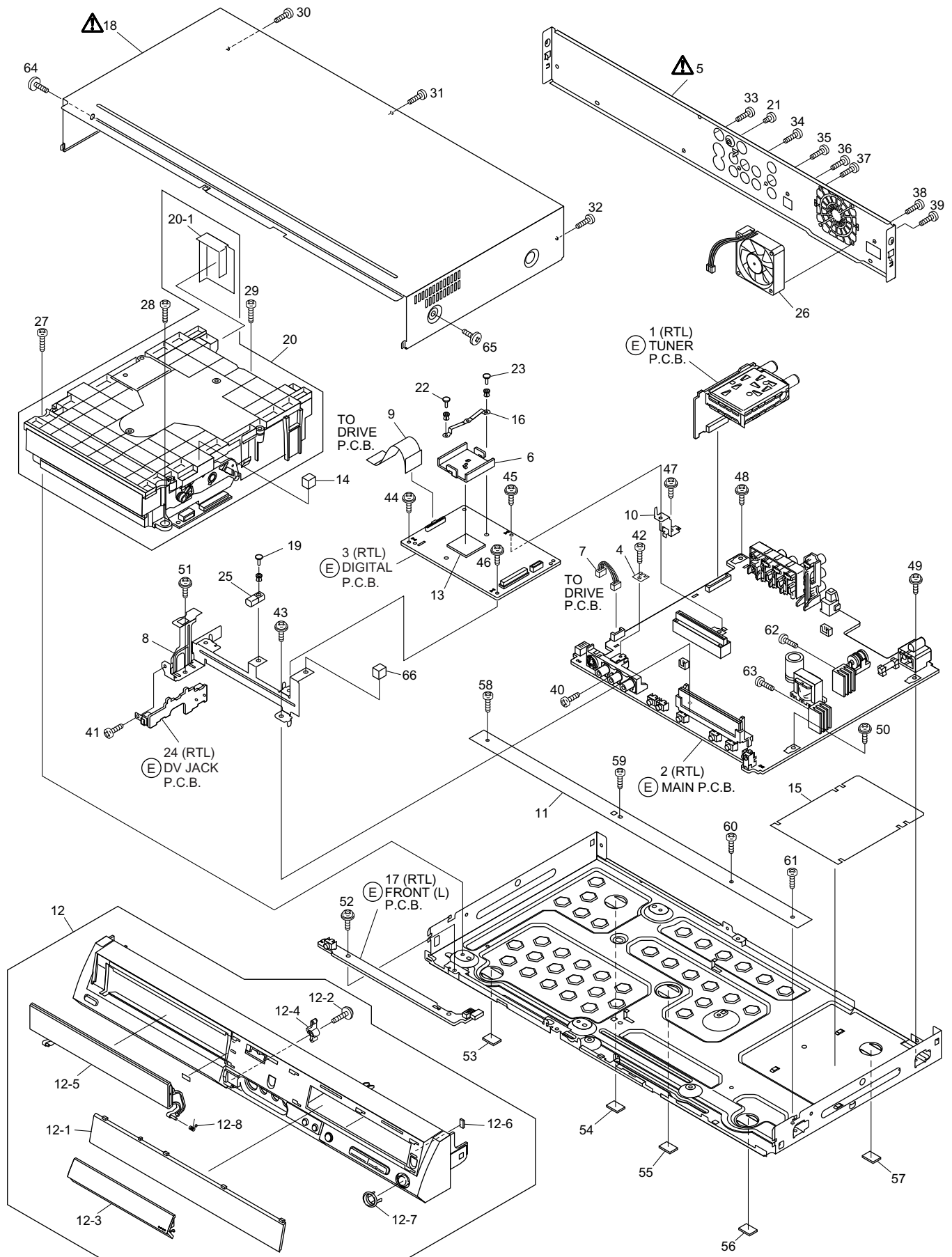

S7.2. Packing Parts & Accessories Section

