

RADIO — ELECTRONICS

formerly

RADIO CRAFT

HUGO GEMSBACK,
Editor

IN THIS ISSUE
Aligning FM Receivers
High-Band Telebooster

AWC CONTRACTING CO.
BUILDERS

W-HANDIE-TALKIE
FOR INDUSTRIAL USE
SEE FM SECTION

LATEST IN RADIO — ELECTRONICS — TELEVISION

NOV
1948

30¢

U. S. and
CANADA



HERE IS HEAVEN SENT HELP

Says LYMAN A. ABBOTT
 THE IOWA FLYING SERVICEMAN

"To any organization such as ours, installing and servicing PA systems, the new Rider PA Manual is heaven sent help. It is a typical Rider Manual. What more need be said."



"... of course we have all 17 RIDER MANUALS."

"... and attribute a good bit of our success in producing a quantity of work in a minimum of time to their always dependable, complete, factory information. We will have Volume XVIII as soon as it is published."



You, TOO—NEED ALL 17 RIDER MANUALS

Volume XVII	\$16.50	Abridged Manuals I to V (one volume)	\$19.80
Volume XVI	8.40	Record Changers and Recorders	9.00
Volume XV	19.80	Master Index, covering Manuals, Vols. I to XV	1.50
Volume XIV to VII (each volume)	16.50		
Volume VI	12.50		

VOL. I RIDER Television MANUAL

1400 Pages, PLUS separate "HOW IT WORKS" and Index, \$18.00. Everything that must be known about the 1946-47 television receivers (complete and kit) of 34 manufacturers. Separate "How It Works" covers theory of television; transmission and reception, frequency standards, antennas, various portions of receivers.

Television "HOW IT WORKS" Available Separately
 If television is not yet in your area, it will be soon. Here is theory you want. 208 pages \$2.70.

VOLUME 1

RIDER PA MANUAL

Just Out

Covers 145 Manufacturers' Amplifiers, from 1938 to Date

Bigger and better than even we had anticipated, the scope and thoroughness of this first industry-wide PA service manual makes it an essential piece of equipment for any shop doing PA work. It covers public address systems, outdoor announcing, musical instruments and phonographs, theatre and church hearing aids, electronic megaphones, intercommunications systems, theatre and home motion pictures, school, hotel and hospital sound systems, mobile and portable sound systems.

- It provides schematics, voltage and resistance tables, tube and chassis layouts, installation notes, operational instructions, impedance matching.
- Separate "HOW IT WORKS" book explains the theory of various designs employed in different types of amplifier systems, the servicing of PA systems, using the sine wave and square wave means of checking, methods of rapidly locating faults. Everything you need.

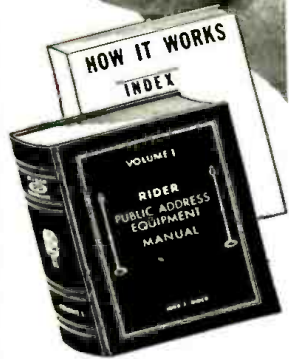

2000 Pages in this new RIDER FIRST plus separate "HOW IT WORKS" and INDEX \$18.00
ORDER YOURS TODAY!

RIDER MANUALS
MEAN SUCCESSFUL SERVICING

JOHN F. RIDER, PUBLISHER, Inc., 404 Fourth Avenue, N. Y. 16
 Export Agent: Rocke International Corp., 13 E. 40th St., N.Y.C. Cable ARLAB

NOTE: The Mallory Radio Service Encyclopedia, 6th edition, makes reference to only one source of radio receiver schematics—Rider Manuals.
 ANOTHER NOTE: The C-D Capacitor Manual for Radio Servicing, 1948 edition No. 4, makes reference to only one source of receiver schematics—Rider Manuals.



Have You Met the Little Fellow
with the
BIG
Advantages?

The All New
Mallory Midgetrol

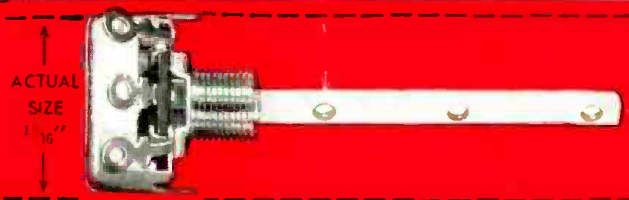

Offers These BIG Advantages...

**BIGGER
MARKET**

The small size of the Mallory Midgetrol lets you service portables, auto radios and small AC-DC receivers which require $1\frac{5}{16}$ " controls.

**SIMPLER
INSTALLATION**

The unique shaft design of the Mallory Midgetrol saves installation time with *all* types of knobs.

**SIMPLER
STOCKING**

Electrical characteristics let you use the Mallory Midgetrol to replace $1\frac{1}{8}$ " as well as $1\frac{5}{16}$ " controls. Stocks are further reduced because no special shafts are needed.

The Mallory Midgetrol is unusually quiet, both mechanically and electrically—and tests prove it *stays* quiet. In addition, the Mallory Midgetrol has nine *all new* features.

- NEW SIZE
- NEW DESIGN
- NEW SHAFT
- NEW EXTENSION
- NEW SWITCH
- NEW ELEMENT
- NEW CONTACT
- NEW TERMINAL
- NEW TWO-POINT SUSPENSION

It's the NEW Standard in Carbon Controls. See your Mallory distributor.

P. R. MALLORY & CO. Inc.
MALLORY

CAPACITORS... CONTROLS... VIBRATORS...
SWITCHES... RESISTORS... RECTIFIERS...
VIBRAPACK* POWER SUPPLIES... FILTERS
*Reg. U. S. Pat. Off.

APPROVED PRECISION PRODUCTS

P. R. MALLORY & CO., Inc., INDIANAPOLIS 6, INDIANA

NEW!

...the Roto Ranger

—automatically rotates one of 18 separate scales into position as you select the range.

SIMPSON MODEL 221 ROTO-RANGER
HIGH-SENSITIVITY A.C.-D.C. VOLT-OHM-MILLIAMMETER

Here is the only multiple scale test instrument of its kind in the world. It definitely reduces the possibility of errors by providing a single scale for each range of this finest of volt-ohm-milliammeters. As the selector switch is moved to the range desired, an ingenious gearing mechanism rotates a drum, bringing into place behind the meter window the proper scale for that range. Here is the equivalent of 25 separate instruments combined in one sturdy and compact unit. (18 scales, 7 additional direct reading ranges through use of high voltage and output jacks.) The patented Roto-Ranger principle eliminates the confusion of numerous readings on one scale, and the multiplying factors common to ordinary multi-range testers, by providing a separate scale for each range. There are no cramped calibrations in these full sized Roto-Ranger scales. Each is designed as it would be for a separate instrument.

SIMPSON ELECTRIC COMPANY
5200-5218 W. Kinzie St., Chicago 44, Ill.

In Canada: Bach-Simpson, Ltd.,
London, Ontario

Simpson
INSTRUMENTS THAT STAY ACCURATE

Ranges

20,000 Ohms per Volt D.C., 1,000 Ohms per Volt A.C.
Volts, A.C.: 2.5, 10, 50, 250, 1000, 5000
Volts, D.C.: 2.5, 10, 50, 300, 1000, 5000
Milliamperes, D.C.: 10, 100, 500
Microamperes, D.C.: 100
Amperes, D.C.: 10
Output: 2.5, 10, 50, 250, 1000
Ohms: 0-2000 (12 ohms center), 0-200,000 (1200 ohms center), 0-20 megohms (120,000 ohms center).
Size: 12 3/4" x 10 1/8" x 5 3/8"
Weight: 8 lbs. 9 oz.
Price, complete with test leads and 28-Page Operator's Manual..... \$69.85

High voltage probe (25,000 volts) for TV, radar, x-ray and other high voltage tests, also available.

Ask your Jobber, or write for complete descriptive literature



A separate scale for every range—automatically!

Large 5 1/2" meter, with 18 separate, full length scales!

MODEL 221

SERIAL NO.

MADE IN U.S.A. BY SIMPSON ELECTRIC CO. CHICAGO, ILL.

RELAYS FOR EVERY PURPOSE Over a Million in Stock!

Whether you require large quantities of relays for production runs or single units for laboratory or amateur work, Wells can make immediate delivery and save you a substantial part of the cost.

Our capable engineering staff is prepared to offer assistance in the selection of correct types to suit your exact requirements.

Each relay is brand new, standard make, inspected, individually boxed and fully guaranteed.

The following list represents only a tiny portion of our relay stock. Write or wire us for information on types not shown.

STANDARD DC TELEPHONE RELAYS					
Stock No.	Operating Voltage	Coil Resistance	Contacts	Manufacturer	Net Each
R-101	24V	1500	DPST (NO)	Auto. Elec.	\$1.35
R-102	24V	400	SPDT	Auto. Elec.	1.10
R-103	24V	DUAL-1000	3PST (NO)	Auto. Elec.	1.35
R-105	24V	600	3PST (NO)	Clare	1.20
R-106	24V	1300	3PST (NC)	Clare	1.25
R-152	12V	50	DPDT (2NC-1ND)	Guardian	1.10
R-153	12V	200	SPDT-SPST (NO)	Stromberg	1.25
R-154	12V	200	SPST (NO)	Clare	1.20
R-155	12V	100	SPST (4NO4NC)	Auto Elec.	1.15
R-158	6V	50	4PST (NO)	Stromberg	1.10
R-159	6V	50	DPST (NO)	Stromberg	1.10
R-160	6V	12	3PDT-3PST (NO)	Auto. Elec.	1.05
R-161	6V	10	3PST (2NC-1ND)	Auto Elec	.90
R-121	150V	5000	2PST (NO) SPDT	Clare	1.65
R-127	150V	6300	SPST (NO)	Clare	1.75
R-66	150V	6500	3PST (NO)	Clare	1.75
R-51	24V	750	SPST (NO)	Clare	1.25
R-57	12V	250	DPST (ND)	Clare	1.20
R-519	250V	14000	SPDT	Auto. Elec.	1.95
R-520	250V	14000	SPDT	R.B.M.	1.50
R-521	32V	1000	DPDT	Auto. Elec.	1.30
R-166	24V	DUAL-200	DPDT-SPST (NO)	Stromberg	1.59
R-168	24V	DUAL-200	4PST (ND)	Auto. Elec.	1.20
H-240	250-350V	40000	DPST (NO)	Auto. Elec.	2.95
H-241	24V	650	SPDT-SPST (NO)	Auto. Elec.	1.25

TYPE 18 DC TELEPHONE RELAYS					
Stock No.	Operating Voltage	Coil Resistance	Contacts	Manufacturer	Net Each
R-109	24V	4000	SPDT	Auto. Elec.	\$1.50
R-110	24-32V	3500	SPDT	Auto. Elec.	1.50
R-112	90-120V	6500	SPST (NC)	Auto. Elec.	1.75
R-114	24V	500	4PST (NO)	Auto. Elec.	1.30
R-603	24V	400	DPST (NO)	Auto. Elec.	1.25
H-238	24V	150	DPDT-SPST (NC)	R.B.M.	1.25
H-239	24V	180	DPST (NO)	Auto Elec	1.25



SEALED DC TELEPHONE RELAYS					
Stock No.	Operating Voltage	Coil Resistance	Contacts	Manufacturer	Net Each
R-125	24V	300	DPDT	Clare	\$2.75
R-126	90-120V	2000	DPDT	Clare	3.00
R-504	24-27V	2800	SPDT	GE-C103C25	3.00

V TYPE DC TELEPHONE RELAYS					
Stock No.	Operating Voltage	Coil Resistance	Contacts	Manufacturer	Net Each
R-164	24-32V	1000	SPST (NO)	W. E.	\$1.20
R-512	24-48V	350	SPST (NO)	W. E.	1.30
R-513	12-24V	300	DPDT-SPST (NC)	W. E.	1.20
R-514	4-6V	60	SPDT	W. E.	1.05
R-526	6V	35	DPDT-SPST (INC-1NO)	W. E.	1.05

AC-STANDARD TELEPHONE RELAYS					
Stock No.	Operating Voltage	Coil Resistance	Contacts	Manufacturer	Net Each
R-212	90-135V	-	NONE	Clare	\$0.95
R-213	5-8V	-	DPST (NO)	Clare	1.50
R-605	24V	-	3PST (NO)	Auto. Elec.	.95
R-606	24V	-	DPST (1NO-1NC)	Auto. Elec.	.95
R-607	24V	-	SPST (NO)	Auto. Elec.	.95



DIRECT CURRENT MIDGET RELAYS					
Stock No.	Operating Voltage	Coil Resistance	Contacts	Manufacturer	Net Each
R-132	24V	300	DPDT	Clare	\$1.20
R-133	24V	300	NONE	Clare	.60
R-134	24V	250	4PDT	Clare	1.15
R-135	24V	300	SPST (NC)	Clare	1.15
R-137	24V	300	SPDT	Clare	1.15
R-138	24V	300	4PST (NO)	Clare	1.15
R-139	24V	200	4PDT	Clare	1.15
R-140	24V	280	SPDT	R.B.M.	1.15
R-141	24V	280	3PST (NO)	R.B.M.	1.15
R-142	24V	400	DPDT	Allied Cont.	1.20
R-143	24V	280	SPST (NO)	R.B.M.	1.15
R-144	24V	250	SPST (NO)	Allied Cont.	1.15
R-145	24V	300	DPST (NO)	Allied Cont.	1.15
R-146	12V	300	DPST (1NO) (1NC)	Clare	1.10
R-147	9-14V	75	SPDT	Guardian	1.05
R-148	12V	100	DPDT-SPST (NC)	Price Bros.	1.00
R-149	6-8V	45	SPST (NC)	Clare	1.00
R-150	6V	30	SPST (NO)	E-Z Elec.	.65
R-522	2-6V	2	SPST (ND)	R.B.M.	.95
R-523	90-125V	6500	DPDT	Clare	1.90
R-222	12V	100	DPST (NO)	P & B	.95
H-242	24-32V	300	DPDT	R.B.M.	1.20
H-243	24-32V	300	4PDT	R.B.M.	1.20



SENSITIVE DC RELAYS					
Stock No.	Operating Voltage	Coil Resistance	Contacts	Manufacturer	Net Each
R-218	4-6V	1800	SPDT	Kurman 220C	\$1.95
R-220	7.5V	5000	SPDT	Allied Cont.	1.20
R-221	18-24V	5000	SPST (NO)	Allied Cont.	1.10
R-174	25V	5000	DPST (NO)	G.M.	1.85
R-175	35V	11000	DPDT-SPST (NO)	G.M.	2.95
R-176	24V	250	DPST (NO)	G.M.	1.50
R-177	24V	300	4PDT	G.M.	1.65
R-600	8-12V	5000	SPDT	S-Dunn-KS	2.10
R-507	24-48V	1000	SPDT-DPST (NC)	Guardian	1.15

TYPE 80 DC RELAYS					
Stock No.	Operating Voltage	Coil Resistance	Contacts	Manufacturer	Net Each
R-169	24V	250	SPST (NO)	Allied Cont.	\$1.95
R-171	24V	230	DPDT	Allied Cont.	2.15
R-172	5-8V	30	DPDT-SPST (NO)	Allied Cont.	1.70
R-173	7-6V	5	SPST (NO)	Allied Cont.	1.25
R-529	24-48V	1000	DPDT	Allied Cont.	2.50

TYPE BJ DC RELAYS					
Stock No.	Operating Voltage	Coil Resistance	Contacts	Manufacturer	Net Each
R-204	12V	65	DPST (NO)	Allied Cont.	\$1.15
R-205	24V	260	DPDT	Allied Cont.	1.25
R-224	12V	75	SPST (NO)	Allied Cont.	1.15
H-237	27V	230	DPDT	Allied Cont.	1.25

HEAVY DUTY KEYING RELAYS					
Stock No.	Operating Voltage	Coil Resistance	Contacts	Manufacturer	Net Each
R-248	28V DC	150	SPST (NO) 10A	Guard. 36471	\$1.05
R-244	75V AC	265	SPST (NO) 20A	Leach 1327	1.75
R-206	24V DC	150	SPDT-3 AMP	P&B-KL	1.20
R-207	24V DC	210	4PDT-3 AMP	P&B-KL	1.10
R-219	50V DC	1500	DPST (NO) 15A	P&B-SP	1.25
R-217	115 AC	600	SPDT-10 AMP	St. Dun. IXAX2.25	1.25
R-525	24V DC	200	DPDT-10 AMP	Guard 2466	1.25
R-508	110 AC	600	SPDT-6 AMP	Guard 37189	1.95
R-506	24 V DC	300	DPST (ND) 6A	-	.95
R-510	24 V DC	200	3PDT-10 AMP	Guard. 516983	1.05
R-604	24 V DC	200	SPST (NO) 30A	St. Dun. B2A	1.25
H-608	115 AC	35	SPST (NO) 20A	St. Dun. LHXX2.25	1.25
R-629	12V DC	35	3PST (NO) 10A	Guard-BK2	1.05
R-223	28V DC	150	SPST (NO) 40A	Price Bros.	1.35
H-230	12-24V DC	80	SPST (NO) 10A	-	1.20
H-231	24V	230	DPST (NO) 5A	R.B.M.	1.15

DC-TYPE 76 ROTARY RELAYS					
Stock No.	Operating Voltage	Coil Resistance	Contacts	Manufacturer	Net Each
R-197	9-16V	70	DPDT	Price Bros.	\$1.65
R-198	9-16V	125	SPST (3NO)	Price Bros.	1.65
R-199	24-32V	250	(3NC) SPDT	Price Bros.	1.65
R-200	24-32V	275	SPDT-DPST (NC)	Price Bros.	1.65
R-201	24-32V	250	3PDT-SPST (NC)	Price Bros.	1.65
R-601	9-14V	60	DPST (NO) SPDT (NC) DPDT 3PST (NO)	Price Bros.	1.65



DIRECT CURRENT KEYING RELAYS					
Stock No.	Operating Voltage	Coil Resistance	Contacts	Manufacturer	Net Each
R-190	12V	65	DPDT 10 AMP	Advance Elec. Type 2000-A	\$1.15
R-191	28V	125	DPDT 10 AMP	Guardian	1.20
R-192	12V	44	3PDT 10 AMP	Allied Cont.	1.35
R-193	5-8V	11	DPDT 10 AMP	Type N85	1.05
R-194	24V	265	SPST (NO) DPST (NO) 10AMP	Leach Type 1027	1.05
R-195	6V	32	DPDT 3 AMP	Type 1054SNW1.25	1.15
R-196	12V	50	DPDT 10 AMP	G.E.Co.	1.15
R-242	24V	170	SPST (NC) SPDT 2 AMP	Guardian	1.15
H-236	5-8V	18.5	SPDT 10 AMP	Leach Type 1253DEW1.25	1.05

CUTLER HAMMER HEAVY DUTY CONTACTORS



Stock No.	Operating Voltage	Coil Resistance	Contacts	Manufacturer	Net Each
R-178	24V DC	100	SPST (NO) 100A.	6141H34A	\$3.85
R-179	6V DC	6.5	SPST (NO) 50A.	6041H83A	3.00
R-180	12V DC	25	SPST (NO) 50A.	604H308	3.25
R-181	24V DC	65	SPST (NO) 100A.	6041H88	3.85
H-232	24V	55	SPST (NO) 50A.	Metal Cased	3.25
H-233	6V	15	SPST (NO) 50A.	Metal Cased	3.15
H-235	24V	70	SPST (NO) 100A.	Type B6	3.85

DIRECT CURRENT AIRCRAFT CONTACTORS

Stock No.	Operating Voltage	Coil Resistance	Contacts	Manufacturer	Net Each
R-182	28V	80	SPST (NO) 25 A	Guardian	\$1.85
R-183	24V	60	SPST (NO) 50 A.	Allen Bradley Type B5A	2.75
R-184	28V	50	SPST (NO) 100A.	General Elec.	2.95
R-185	24V	100	SPST (NO) 50 A.	Leach 5055ELR	2.75
R-186	24V	132	SPST (NO) 50 A.	Leach 722P-3-243.50	2.95
R-187	24V	100	SPST (NO) 50 A.	Allen Bradley	2.95
R-188	24V	200	SPST (NO) 75 A.	Allied Cont.	2.95
H-234	14V	45	SPST (NO) 30 A.	-	1.65

ANTENNA CHANGEOVER RELAYS

Stock No.	Operating Voltage	Coil Resistance	Contacts	Manufacturer	Net Each
R-192	6-12V DC	44	2PDT 10 AMP	Allied-NBS	\$1.35
R-231	12VDC	100	DPDT 6 AMP	G. E.	1.95
R-256	24-32V DC	-	SPDT-DPST (NC)	Guardian	1.45
R-501	110 AC	4	1KW DPDT (1KW)	G. E.	2.45
R-503	12-32V DC	100	SPDT-SPST	G. E. 500 W	1.95

COMBINATION PUSH BUTTON AND REMOTE RELAY

Stock No.	Operating Voltage	Coil Resistance	Contacts	Manufacturer	Net Each
H-244	12-24 V DC	Dual-60	SPDT	CR2791-R106CB	\$1.65

ADJUSTABLE TIME DELAY RELAY

Stock No.	Operating Voltage	Coil Resistance	Contacts	Manufacturer	Net Each
R-246	115 AC	-	SPST (NO) or (NC) 10 AMPS	R. W. Cramer 1-120 Sec	\$6.50

DC MECHANICAL ACTION RELAYS

Stock No.	Operating Voltage	Coil Resistance	Contacts	Manufacturer	Net Each
R-245	12V	25	4 Lever	G.M.	\$0.95
R-527	6-12V	200	2 Lever	-	.95

TYPE C.M.S. RELAY

Stock No.	Operating Voltage	Coil Resistance	Contacts	Manufacturer	Net Each
R-511	24V DC	200	MICRD-Sw SPST (NO)	Clare	\$2.45

DC CURRENT REGULATOR

Stock No.	Operating Voltage	Coil Resistance	Contacts	Manufacturer	Net Each
R-509	6-12V DC	40	SPST (NC)	G. E.	\$0.85

LATCH AND RESET RELAY

Stock No.	Operating Voltage	Coil Resistance	Contacts	Manufacturer	Net Each
R-500	12V DC	10	DPDT-10 AMP	St. Dun. CX-3190B	\$2.85

DC-ROTARY STEP RELAY

Stock No.	Operating Voltage	Coil Resistance	Contacts	Manufacturer	Net Each
R-621	6-12V	30	3 POLE 23 POSITION	W. E.	\$10.95

DC-RACHET RELAY

Stock No.	Operating Voltage	Coil Resistance	Contacts	Manufacturer	Net Each
R-230	5-8V	2	SPDT-DPST (NO)		

INDUSTRIAL ELECTRONICS REFERENCE BOOK, by Electronics Engineers of the Westinghouse Electric Corp. Published by John Wiley & Sons. 9 x 12 inches, 680 pages. Price \$7.50.

This is a large book, physically, and it covers a large subject. The coverage is thorough, beginning with the physical background of electronics—the atomic theory. Much of the material is on subjects of interest to the communication engineer as well as the industrial designer, because the two fields overlap considerably. There are chapters on emission, conduction in gases, vacuum tubes, phototubes, C-R tubes, tuned circuits, and allied topics. Sections which apply especially to industry are those dealing with industrial control, power rectifiers, r.f. heating, industrial X-ray work, and several others.

Each of the 36 chapters has been written by a different author, each evidently, a specialist in his subject. The information is complete and detailed, profusely illustrated with diagrams and tables. The treatment is not wholly mathematical, but the necessary formulas are given. While the text deals with principles and design rather than with descriptions of specific pieces of apparatus, the engineer will find the book a valuable reference source in almost any sort of industrial work.—R. H. D.

THE PHYSICAL PRINCIPLES OF WAVE GUIDE TRANSMISSION AND ANTENNA SYSTEMS, by W. H. Watson. Published by the Oxford University Press. 6½ x 9½ inches, 207 pages. Price \$7.00.

The writer of this volume, a professor of mathematics at the University of Saskatchewan, has covered thoroughly all types of wave guides and the currently known methods of using them.

The book was written to acquaint physicists and engineers with the multiple-propagation characteristics of microwaves. The subject is approached from an entirely theoretical angle, and the treatment is mathematical throughout.

The material will be of most use to

those interested in the principles of microwave transmission, for whom it will provide a complete theoretical background. It is not intended to be an engineering guide.—R.H.D.

RCA Triple Pindex. Base diagrams of 475 tube types. Price 75c.

The book is composed of three separate base-diagram booklets, each with 2½ x 3½-inch pages, joined below each other in a single cover with a spiral wire binding which permits the pages to lie flat. This triple feature permits the repairman to have three separate base diagrams before him at all times without flipping pages from one to the other.

ANTENNAE. An Introduction to Their Theory, by J. Aharoni. Published by Oxford University Press. 6½ x 9½ inches, 265 pages. Price \$8.50.

A completely mathematical treatment of the subject, this book is divided into three parts, Antennae and Boundary-Value Problems, Antennae and Integral Equations and Antennae as Wave Guides. A number of references—both books and papers—are given at the end of the text.

FREQUENCY MODULATION, VOL. I, edited by Alfred N. Goldsmith, Arthur F. Van Dyck, Robert S. Burnap, Edward T. Dickey, and George M. K. Baker. Published by RCA Review. 6 x 9 inches, 515 pages. Price \$2.50.

A collection of 45 papers delivered by RCA engineers at various meetings or published in technical journals, this is the seventh volume of the RCA technical series. Due to the large number of papers, the FM art is covered—though possibly somewhat spottily—almost completely. The papers deal with problems in both FM reception and transmission.

There are two appendices—a bibliography of technical papers by RCA authors from 1936 to 1947 and a guide to a series of articles in *Broadcast News* on FM station placement and field survey techniques.

Earn the big pay of an expert radioman

This self-study **BASIC RADIO COURSE** trains you at home



EXPLAINS the principles of operation of vacuum tubes, their basic circuits and other essentials of radio
PROVIDES the electrical background you must have
FILLS IN the radio and electrical mathematics you need, taking you in easy steps from simple fractions to logarithms

Let this self-study course prepare you right at home for a successful future in the RADIO field. It contains all the information you need . . . radio — electrical — mathematical — to handle all types of radio sets, test equipment and electronic devices. Explains everything from time delay circuits to the most recent advances in the field . . . mechanical and wire recording sound systems—frequency modulation—multiunit and multicathode tubes, etc.

A 3-Way Set!

Even as you learn the fundamentals of radio work you absorb the practical electricity and electrical theory you need. And as you go along the set fills in the mathematics you must know . . . gives you the essentials of algebra, geometry, trigonometry.

This basic course includes
1. ESSENTIALS OF RADIO by Morris Slurzberg and William Osterheld
2. ESSENTIALS OF RADIO by M. Slurzberg and W. Osterheld
3. MATHEMATICS ESSENTIAL TO ELECTRICITY AND RADIO by Nelson Cooke and Joseph Orleans
 Over 1,000 illustrations! 1953 pages! 29 appendixes!

McGRAW-HILL BOOK CO.,
 330 W 42 St., NYC 18

Send me your 3-volume course in BASIC RADIO for 10 days' examination on approval. In 10 days I will send \$4.95 and \$5.00 a month until I have paid \$13.95 or return the books postpaid.

Name

Address

City Zone... State.....

Company

Position RC-11-48

Come to the Great SHOPS OF COYNE

Learn **RADIO TELEVISION F.M.-ELECTRONICS**

PRACTICAL SHOP TRAINING—NOT HOME STUDY

Trained Radio men needed now. Get Radio-Television training and be ready for a real future. Learn on actual equipment at Coyne. 49 years of training experience. Not "Home Study". Free employment service to graduates. Many earn while learning. If you are short of money, ask about Student Finance Plan. G.I. Approved. Coupon brings special plan for men of draft age. **SEND COUPON FOR FREE BOOK**

B. W. COOKE, President
 COYNE ELECTRICAL & RADIO SCHOOL
 500 S. Paulina St., Dept. 88-8H, Chicago 12, Ill.
 Send Big Free Radio-Television Book, also your special plan for men of draft age.

NAME.....

ADDRESS.....

CITY.....STATE.....

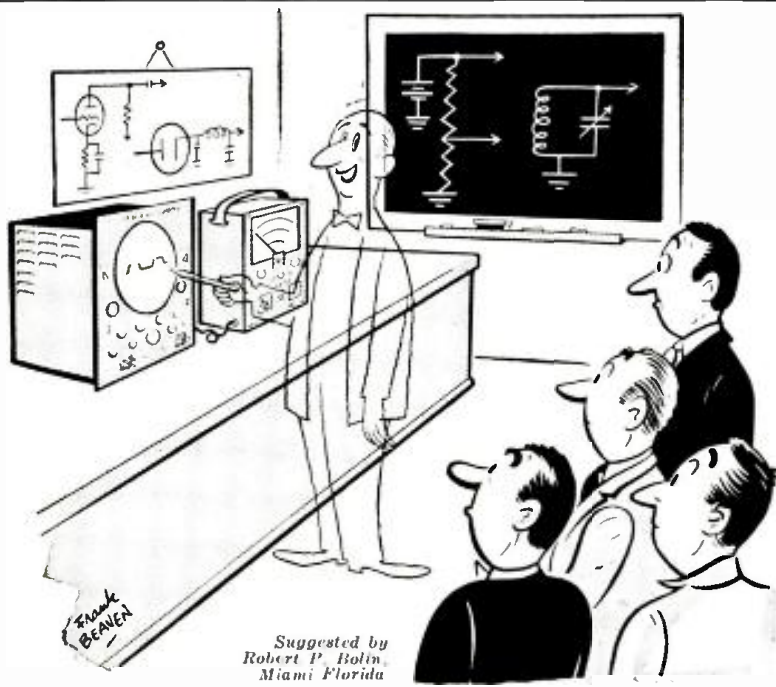

"Well, Students, did I make myself clear?"

Suggested by Robert P. Bolin, Miami Florida

Frank BENNETT



PRECISION RESISTORS

"TAB" Specialists in Precision Resistors. Write Qty. Prices. "NO MFGRS. CHOICE." we ship types in stock.

From .116 to 99,000 ohms 30c. TEN for \$2.50

100000	150000	210000	335000	575000
110000	170000	240000	380000	600000
115000	165000	250000	400000	620000
120000	180000	260000	420000	640000
125000	185000	270000	440000	660000
130000	200000	270000	460000	680000
135000	210000	280000	480000	700000
140000	220000	290000	500000	720000
145000	225000	300000	520000	740000
150000	235000	310000	540000	760000
155000	240000	320000	560000	780000
160000	250000	330000	580000	800000

ABOVE SIZES, EACH 40c. TEN for \$3.50

1 Meg	1.8 Meg	3.3 Meg	4.25 Meg	10 Meg
1.2	2.8%	3.3	4.5	11.5
1.5	2.8%	3.3	4.5	12.8%
1.5	3	1	9.05	20

ABOVE SIZES EACH 75c. TEN for \$6.50

VACUUM Precision Hi Volt Resistors (C) 0.12, 0.25, 0.5, 0.75, 0.83, 0.50 megohms: 1, 1.5, 2, 3, 3.75 megohms, avc 0.75%. Special \$1.00@; Ten for \$7.50

MEGMAX 100 12Meg 10KV 9W. \$1.35@; 10 \$10.00

MEGMAX 100 25KV 20Watt. \$1.98@; 6 \$10.00

MEGMAX 100 13Meg 15KV JAN29. \$1.98@; 6 \$10.00

XTAL DIODES—NEW

1N31 \$1.08 @ 2 for \$2.10 10 for \$9.85

1N21, 21A, 22, 23A each \$1 12 for \$10.00

1N231, 1N24 @ \$2 10 for \$17.50

1N35 Dual Diode \$2.29

PHOTOFLASH and 2 lamps

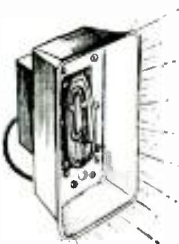

PHOTOFLASH KIT AIR-CORP'S 1503 NEW. Contains Power Supply, ELECTROLYTIC CONDENSERS 50 mfd. TRANSFORMERS & Relay, 2 STROBO-LAMP'S 12 million lumens light output, 17 to 30000 flashes & Reflctrs. for COLOR & BW film. READY for use on 12VDC. In addition, KIT INCLUDES INSTRUCTIONS & PARTS to convert to 115VAC. SPECIAL "TAB" BUY

1503 SET plus six 2V (12V) 8 Batts. \$59.95

PHOTOFLASH 1503 & BATTY PACK for 115VAC/12VDC operation READY TO WORK \$119

PHOTOFLASH LAMP'S & REFL. \$10.95, 2 for \$21.00

Flash Condensers 50mfd/60VAC/2000V Int. \$3.95

50mfd/2000V Int. \$4.50

100mfd/3000V Int. \$7.95

25mfd/2000V Int. \$7.95

16mm/PAN 50 Film GSAP Camera 3/51; 54 for \$8.98

16mm/PAN Film GSAP Camera 3 for \$1; 10 for \$1.98

Blowers—Cool that Tube!



- (A) Impeller 100CFM/28VAC/DC \$ 4.95
- (B) Impeller 100CFM/12VAC/DC 5.95
- (B) TURBINE 250CFM/28VAC/DC & XFOILIER 115VAC/200V Int. 10.95
- (C) TURBINE 40CFM/28VAC/DC, 4500' per min. mean velocity 3.25
- TURBINE 125CFM 115VAC 8.95
- BLOWER TRANSF 28 to 115 VAC 1.69
- TV 500mV Pwr Supply III & Lo Voltages \$29.95
- TV 1000mV Pwr Supply III & Lo Voltages \$36.95

HIPPOWER VARIABLE ANTENNA MATCHING NETWORK



1001A/1KW RF NEW 1.5 to 7 ohms easily converted to HF freets. Network adjustable IN & Outp CSD 15x15x23" BACK MTG. Rhodium Coll & 2500mhz/7000V Var Conds. RFLNTR. Tech manual will match most ANTS. "TAB" SPECIAL (BRAND NEW) \$12.95 NEW. coils require reinserting AS 18, coil repairs required 9.95

Storage & Dry Batteries



- (A) BR18/1H52/5oz. 3v min S'Baty \$1.49; 8/10.00
- (B) BR688 3V/PZRP/dated 6/47. Special 5/1.00
- (C) GOLD 6V/15AH S'Baty USN NEW 3.98
- (D) BR51 2V/27amp WILLARD S'Baty 1.96
- (E) WILLARD 4V/40AH/TBY S'Baty 5.95
- (F) BR2064U/2V/11AH WILLARD S'Baty 1.89

\$3 Min. F.O.B. N.Y.C. Add Post. and 25% deposit. Money back "TAB" Guarantee. Return Mdse Prepaid

"TAB", Dept. RC-11

6 CHURCH ST., NEW YORK 6, N. Y. WOrth 2-7230

Pre-Holiday Specials

CIRCULAR FLUORESCENTS

WESTING-HOUSE 36W CIRCULARC WITH BULBS GENERAL ELECTRIC 32W CIRCULINE \$8.25 \$8.50

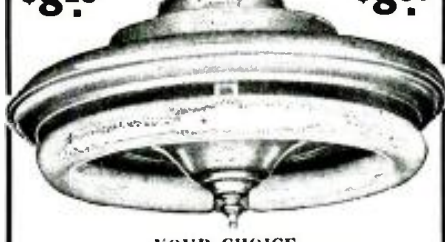

YOUR CHOICE

- WHITE
- CHROME
- 4" CUP FOR KITCHEN
- FLUSH MOUNTING
- LARGE DECORATIVE GLASS \$1.25, 6 LBS.

MICROGROOVE PLAYER

Play Sarvi, Micro-Groove & Standard Records With This Dual Speed Phonograph



SPECIAL \$39.90

Incl. Fed. Tax RCA Licensed

Has Dual Speed motor and dual crystal pickups. Powerful 3 tube J1-B amplifier with volume & bass controls. Heavy 7 1/2 PM SDC 2 Tone Leatherette carrying case. We absolutely guarantee this to meet with your satisfaction or your money back in 10 days. Automatic Switching from L.P. to Regular Model J11-3 11 1/2 V AC. Weight 15 lbs. Model DA-2 Same case as above. Plays New Microgroove Records only. Attaches to your Hi-Fi radio or console. 11 1/2 V AC. Special. \$19.90

WE SELL RETAIL Immediate Delivery. Order Yours Today \$5.00 on all C. O. D. Orders or Payment in Full Catalog N. Please enclose postage.

RISCO ELECTRONICS WHOLESALE DISTRIBUTORS 25 West Broadway, N. Y. T, N. Y.

ANY BOOK IN PRINT



Delivered at your door. We pay postage. Standard authors, new books, popular editions, fiction, reference, medical, mechanical, children's books, etc. Guaranteed savings. Send for Clarkon's 1919 catalog. FREE Write for our great illustrated book catalog. A short course in literature. The buying guide of 300,000 book lovers. The answer to your Christmas gift problem. Free if you write now—today!

CLARKSON PUBLISHING COMPANY Dept. RC8, 1257 So. Wabash Ave., Chicago, Ill.

TELEVISION RECEIVER—\$1.00

Complete instructions for building your own television receiver. 16 pages—11"x17" of pictures, pictorial diagrams, clarified schematics, 17"x22" complete schematic diagram & chassis layout. Also booklet of alignment instructions, voltage & resistance tables and troubleshooting hints.—All for \$1.00.

CERTIFIED TELEVISION LABORATORIES Dept. C, 5507-13th Ave., Brooklyn 19, N. Y.

PEN-OSCIL-LITE

Extremely convenient test oscillator for all radio servicing; alignment; Small as a pen • Self powered • Range from 500 cycles audio to over 600 megacycles d.f.f. • Output from zero to 125 v. • Low in cost • Used by Signal Corps • Write for information.

GENERAL TEST EQUIPMENT 38 Argyle Ave. Buffalo 9, N. Y.



"POCKET TALKIE" As Low as \$9.95 REALLY WORKS—talk and hear 2-10 miles or more — FITS IN YOUR POCKET! Uses flashlight batteries. ABOUT SIZE OF 2 PACKS OF BATTERIES! Wt. 1 LB. SEND \$1.00 (cash, check or M.O.) (\$1.52 C.O.D.) for 22 to rest plus assembly ins., pictures and parts price lists with DETAILED CATALOGUE ON 135 OTHER PRODUCTS SUCH AS: \$1.00 refunded on parts order 2-tube Pocket Radio Clear Box Transmitter, Dash Car Transmitter, Radio Garage Door Openers. MOTOR INDUSTRIES CO., D.L. CW-11, Kearney, Neb.

Index To Advertisers

Air King Products	8
Allied Radio Corporation	45
Almo Electronics, Inc.	91
Almo Radio	87
American Surplus Products Co.	70, 71
Amplifier Corporation of America	68, 90
Audel Publishers	11
Bargain Radio	67
Bell Telephone Laboratories	57
Boland & Boyce Publishers, Inc.	69
Bradshaw Instrument Co.	82
Brook Electronics	65
Brooks Radio Distributing Co.	69
Buffalo Radio Supply	76, 77
Burstein-Applebee Company	82
Capitol Radio Engineering Institute	6, 47
Certified Television Laboratories	96
Cinex Corporation	87
Clarkson Publishing Co.	96
Cleveland Institute of Radio Electronics	15
Clippard Instrument Laboratory, Inc.	86
Communications Equipment Company	63
Coradio	65
Crest Corporation	66
Coyne Electrical School	79, 97
Custom Craft Manufacturing Co.	98
DeForest's Training Institute	13
Electronic Corp. of America	92
Electronic Measurements Corporation	84
Elmhurst Sound & Equipment Co.	90
Espey Manufacturing Co., Inc.	78
Fair Radio Sales	66
Feiler Engineering Company	89
Franklin-Ellis Company	86
General Cement Manufacturing Co.	91
General Electronic Distributing Co.	49, 83, 89
General Salvage Company	91
General Test Equipment	96
Greylock Electronic Supply Co.	65
Halldorson Company	75
Hawkins Radio Co.	84
Heath Company	52, 53, 54, 55
Instructograph Company	79
International Resistance Co.	93
Joyce Radio Distributing	91
Lafayette-Concord	60
Lake Radio Sales Company	79
Leotone Radio Corporation	93
Lifetime Sound Equipment Company	79
McGraw-Hill Book Company	97
McMurdo Silver Company, Inc.	12
P. R. Mallory & Company, Inc.	Back Cover
Metropolitan Electronic & Instrument Co.	16
Mid-America	92
Midway Sales Company	90
Midwest Radio & Television Corp.	67
Mort's Radio Shack	95
Moss Electronic Distributing Co.	84
Motor Industries Company	96
Murray Hill Books, Inc.	72, 80
National Plans Company	91
National Radio Institute	3
National Schools	5
National Surplus Sales	78
Newark Electric Company	95
Ohmite Manufacturing Company	18
Opad Green	75
Opportunity Adlets	68
Precision Apparatus Company	85
Progressive Electronics Company	88
Radio Apparatus Co.	65
Radio Corporation of America	59
The Radio Craftsmen, Inc.	85
Radio Dealers Supply Company	95
Radio Supply & Engineering Co.	58
Radionic Equipment Company	86
Ravac Electronic Corporation	66
John F. Rider	Inside Front Cover
Risco Electronics	96
The Rose Company	82

RADIO SCHOOL DIRECTORY (Pages 94, 95)

American Radio Institute	
Baltimore Technical Institute	
Candler System Company	
Cook's Radio School	
Commercial Radio Institute	
Don Martin School of Radio Arts	
Lincoln Engineering School	
Milwaukee School of Engineering	
RCA Institutes	
Radio Television Institute	
Radio Training Association of America	
Tri-State College	
YMCA Trade & Technical Schools	

Howard W. Sams & Company, Inc.	17
Senco Radio, Inc.	73
N. Silverstine Company	19
Simpson Electric Company	Inside Back Cover
Solar Manufacturing Corporation	4
South River Metal Products	10
Sprague Products Company	20
Sprayberry Academy of Radio	7
Superior Instruments Company	81
Supreme Publications	69
Sylvania Electric Products, Inc.	14
Tab	96
Technical Radio Parts Company	89
Transvision	74, 79
Triplet Electrical Instrument Company	9
Wagner Electric Co.	87
Wells Sales, Inc.	98
Wright, Inc.	88

WANTS SERVICE LICENSES

Dear Editor:

Federal licensing of radio servicing technicians would have the following beneficial results:

Give the serviceman new prestige and promote public confidence in him.

Eliminate the incompetents who give the trade a bad name and destroy confidence in servicemen.

Give the federal government a bona fide roster of qualified servicemen which would be useful in the event of war.

Restrict the entrance of unqualified newcomers. The amateur, tinkerer, and radio school product would be forced to serve a suitable apprenticeship instead of depressing wage levels through cheap competition with the higher priced but more competent individual.

Benefit the public through better, more competent servicing of radio receivers.

Attract better men to the trade through better conditions.

Organization has been tried in the past and it has not worked because of the lack of a common interest or bond. Federal licensing would go a long way toward assuring a common interest in servicing, both in getting and renewing such licenses. The development of a national organization would put power in the hands of the servicemen to fight unethical conduct as well as incompetence in the industry. Such an organization would be stimulated by federal licensing. It could improve both knowledge and working conditions.

WILLARD R. MOODY,
Service Manager, Sanbran Co.,
Washington, D. C.

RCA **RADIO and TELEVISION**
Thorough Training in All Technical Phases
APPROVED FOR VETERANS
DAYS—EVENINGS WEEKLY RATES
RCA GRADUATES ARE IN DEMAND
For Free Catalog Write Dept. RC-48
RCA INSTITUTES, Inc.
A Service of Radio Corporation of America
350 WEST 4TH STREET NEW YORK 14, N. Y.

SHORT CUT **CODE SPEED**
Be an Expert
Learn to be a Telegraph or Radio Operator. Thousands of men needed. Intensely interesting work—good pay. Learn at home or wherever you are, quickly, easily with the famous Canlier Code Speed System. Quality for amateur or commercial license. Book of particulars free.
CANDLER SYSTEM CO.
Dept. 3-M, Box 928 Denver 1, Colo.

DECA **CORRESPONDENCE COURSES IN RADIO and ELECTRICAL ENGINEERING**
ELECTRICAL ENGINEERING Let good grasp of wide electrical field. Prepare yourself at Low Cost, for secure future. Modern course so simplified anyone can understand quickly.
RADIO ENGINEERING Extra fine course in radio, public address, photo-electric work. Trains you to be super-service man, real vacuum-tube technician. Servicemen needed badly. Diploma on completion. Many graduates earning big pay.
WRITE Send postcard for Free Copies of school catalog, full details, all about deferred payment plan, experimental kits, etc. **\$25** Either Course
Lincoln Engineering School, Box 931-C-117, Lincoln 2, Neb.

RADIO
TECHNICIAN and RADIO SERVICE COURSES
FM and TELEVISION
AMERICAN RADIO INSTITUTE
101 West 63rd St., New York 23, New York
Approved Under GI Bill of Rights
Licensed by New York State

MORT'S—For Better Buys

HF10 TRUSOUND AMPLIFIER

The HF 10 amplifier is a general purpose unit of small size (6" x 9" x 7") designed for high quality reproduction of sound, music and speech from records, radio and microphones. It is engineered and built to meet the high quality standards required of an amplifier when used in conjunction with the new high fidelity pickups, FM-AM tuners and wide range speaker systems.

FEATURES

- 10 watts undistorted power output 18 watts peak.
 - Inputs: High Gain for variable reluctance pickups; for high impedance mikes. Low Gain for FM-AM tuners and high output pickups.
 - Selector switch for rapid changeover.
 - Hum level 70 db below 12 watts.
 - Tone compensation. Separate continuously variable base and treble controls.
 - Treble—from plus 10db to minus 15 db at 10,000 cps.
 - Bass—from plus 10 db to minus 15 db at 50 cps. Note—flat characteristics obtained with controls centered.
 - Output impedance 2, 4, 8, 16 and 500 ohms.
 - Straight AC for 110-120V 50-60 cycles fused.
 - Tubes—6SL7, 6SC7, 2 6V6, 5Y3.
 - Chassis and shield silver gray hammerlout finish.
 - Hermetically sealed components used throughout.
- Complete with tubes and cover. **\$29.95**
Stock No. TR10

METAL CAN AEROVOX REPLACEMENT FILTER CONDENSERS

Replaces 8 x 8 at 600 working volts. 10C test volt 800. Each \$1.29—10 for \$11.75

2 TUBE WIRELESS PHONO OSCILLATOR

This fine piece of equipment is being sold at almost the price of the tubes alone. A real bargain while quantity lasts. Each.....\$3.25

Write for our new FREE 1949 catalog.
TERMS: Minimum Order \$3.00. 25% deposit.
Balance C.O.D., F.O.B. Chicago.

MORT'S RADIO SHACK

Dept. RC 1, 630 West Randolph Street
Chicago 6, Illinois

FREE! send for our
RADIO BUYING GUIDE
a complete and diversified line-up of:

- electronic equipment
- sound systems
- recording equipment
- amateur gear
- television components and kits
- replacement parts
- laboratory and service test equipment

Save time and money—buy direct from distributor! Consult the NEWARK radio buying guide, featuring all standard makes... a value-packed listing of 20,000 essentials for expert servicemen, engineers, soundmen, experimenters, teachers, hobbyists, amateurs!

24 HOUR SERVICE ON ALL ORDERS
Free technical advisory service!

JUST MAIL THIS COUPON TO GET YOUR CATALOGUE
Newark Electric Co., Inc., Dept. II
242 West 55th St., New York 19
Please send me the FREE Newark Buying Guide of fine radio equipment.

Name _____
Address _____
City _____ State _____

NEWARK
RADIO & TELEVISION
3 GREAT STORES
115 W. 45th St. 8212 Fulton St., NEW YORK
and 323 West Madison Street in CHICAGO
MAIL ORDER DIVISIONS
242 West 55th Street, NEW YORK 19, N. Y.
323 West Madison Street, CHICAGO 6, ILL.

Radio - Television - Electronic Parts & Equipment Specials

TELEVISION-CATHODE RAY HIGH VOLTAGE

2000 volt D.C. Power Supply
For an unbelievably low price, we can supply a completely filtered television or cathode ray 2000 volt D.C. power supply. Why bother with bulky and dangerous 60 cycle supplies or expensive R.F. power supplies when you can purchase a complete 2000 volt D.C. unit (not a kit), ready to plug into the 110 volt A.C. power line. The ridiculously low price has been made possible by a fortunate purchase of high quality components. These units are brand new, completely tested and guaranteed.

Price \$7.95

4000-6000 VOLT TELEVISION SUPPLY

Similar to the unit above, but has a much higher D.C. output voltage suitable for use with the new 7" and 10" television tubes.
PRICE\$12.50

RADIO NOISE FILTERS

Eliminates extremely noisy radio reception due to power line disturbances caused by lights, refrigerators, washing machines, vacuum cleaners, elevators, oil burners, diathermy machines, etc.
Filters out man-made noises in the broadcast, short-wave, and ultra-high frequency bands.
Designed for all radios, appliances, and electrical equipment consuming up to 1300 watts (12 amperes) at 120 volts AC or DC.

Housed in a metal case 1 1/2" x 3" x 7 1/2" complete with male and female fine connectors.
PRICE ONLY \$1.95

Industrial Type Radio Noise Filter—Will handle up to 50 amperes. Housed in shielded case 3 3/4" x 2 1/2".
PRICE\$3.95

EASILY ASSEMBLED RADIO KITS

5 Tube AC-DC superhet kit furnished in a brown plastic cabinet of artistic design, cabinet size (9"x5"x6")

Variable condenser tuned; with 2 double tuned I. F.'s.
Tubes used: 1-12SA7, 1-12SQ7, 1-12SK7, 1-35Z5 and 1-50L6
PRICE \$11.95 including 5 standard tubes

6 TUBE 3 WAY PORTABLE KIT

- For operation on 110 volt AC or DC and battery
- Superheterodyne circuit
- Full vision dial
- High gain loop
- Cabinet of Blue Aeroplane cloth finish, size 13x9 3/4"x7"
- Tubes used 1A7, 1H5, 3Q5, 117Z6 and 2-1N5

PRICE \$13.75 Not including tubes
Extra for kit tubes \$3.75

6 TUBE, 2 BAND SUPERHET KIT

Bands covered BC 550-1600 KC and 6-18 MC
Power supply 105-125V AC, DC
Full vision dial
Variable condenser tuned, with two double tuned I. F.'s 455KC
Walnut veneer wood cabinet
PRICE \$15.75

A SCIENTIFICALLY DESIGNED PHONO SCRATCH FILTER

Resonated at approximately 4500 cycles effectively reducing objectionable needle scratch without altering the brilliancy of reproduction.
Contains a HI-Q SERIES resonated circuit. Tested by means of an audio oscillator and an oscilloscope to give 22 db. attenuation with very low signal loss. Attenuation may be regulated by means of a SPECIAL MINIATURE gain control.

EASY TO ATTACH
Just two wires to clip on. Compact. **\$1.65**
Price

THREE TUBE PHONO AMPLIFIER

An assembled unit ready for installation using tone and volume control and six feet of rubber cord **\$2.95**
(Not including Tubes)
With Complete Set of Tubes\$3.95

PHONO OSCILLATOR

Wireless phono oscillator transmits recording for crystal pick-ups or voice from carbon mike through radio without wires. Can also be used as an intercom by using P.M. speaker as mike. Price **\$2.95** (excluding tubes)
With Complete Set of Tubes\$3.95

SPECIAL! SPECIAL!

Mammoth assortment of radio and electronic parts, not less than TEN POUNDS of new transformers, chokes, condensers, resistors, switches, coils, wire, hardware, etc. A super-buy for experimenters, service-men, and amateurs for only **\$1.25**

Satisfaction guaranteed on all merchandise.
All prices F.O.B. New York City

WRITE FOR FREE CATALOGUE
RADIO DEALERS SUPPLY CO.
135 Liberty St. New York, N. Y.

RADIO SCHOOL DIRECTORY

Become a Radio and



IN 18 MONTHS!

Here is the opportunity you have been waiting for. Now you can get in on the ground floor of the nation's fastest growing industry—TELEVISION.

LOOK AT THIS RECORD — In 1946 only 6,500 television sets were manufactured — in 1947 this skyrocketed to 175,000 — already in the first four months of 1948 over 160,000 sets have been produced. This means hundreds of new jobs are being created every month.

MSOE NOW ADDS TELEVISION — The Milwaukee School of Engineering now provides complete, practical, technical training in television as well as Radio in its laboratories. This is not just a *serviceman's* course. The special 18 month's residence course includes complete training in radio as well as television — qualifies you for a successful career as a technician in all phases, AM, FM, TV Receivers and Transmitters and Radio Communications.

This Technician Course Prepares You For Any Of These Jobs:

- | | |
|-----------------------------|----------------------------------|
| Radio Servicing — AM and FM | Police, Taxicab and Railroad |
| TV receiver servicing | transmitters operating |
| Broadcast Station Operating | and receiver servicing |
| Electronic Parts Sales | Supervising and testing in radio |
| Radio and TV sales | and TV manufacturing |
| Radio and TV manufacturing | Shop managing |



Electrical Engineering
Bachelor of Science Degree
in 2 additional years
Majoring in **ELECTRONICS**

MILWAUKEE SCHOOL OF ENGINEERING
"A Technical Institute • Founded 1903"

Dept. RC1148 N. Broadway, Milwaukee, Wis.

COURSES

SERVICE

- 6 to 12 Months
- Practical Electricity
- Welding
- Refrigeration
- Heating

TECHNICIAN

- 12 to 24 Months
- Electrotechnics
- Radio and Television
- Electronics
- Refrigeration, Heating and Air Conditioning

PROFESSIONAL

- 36 Months
- Electrical Engineering
- Bachelor of Science Degree
- Major in Machinery or Electronics

Terms start January, April, July, Sept.

MILWAUKEE SCHOOL OF ENGINEERING,
N. Broadway and E. State, Milwaukee, Wis.
Without obligation send me free booklet "Career Building" and more details on course in Radio and Television of.....course.
Name.....Age.....
Address.....
City.....State.....(RC1148)

LEARN RADIO!

IN ONLY 10 MONTHS
PREPARE FOR A GOOD JOB!
COMMERCIAL OPERATOR (CODE)
BROADCAST ENGINEER
RADIO SERVICEMAN

Television Servicing—15 Months

Veterans get \$130.00 Equipment
SEND FOR FREE LITERATURE
BALTIMORE TECHNICAL INSTITUTE
1425 Eutaw Place, Dept. C, Baltimore 17, Md.

RADIO ENGINEERING!

Complete Radio Engineering Course. Bachelor of Science Degree. Courses also in Civil, Electrical, Mechanical, Chemical, Aeronautical Engineering; Business Administration, Accounting, Secretarial Science. Graduates successful. 65th year. Enter Sept., Jan., March, June. Write for catalog.

TRI-STATE COLLEGE 24118 College Ave. ANGOLA INDIANA

WANTED:

Men and Women to Fill
TOP RADIO JOBS
in AM—FM—Television

If you are looking for a career with a future, why not join the hundreds of graduates from the Don Martin School of Radio Arts now successfully employed in the radio industry. The demand is great for qualified radio personnel in AM-FM-Television. Train now to be an announcer, script writer, disk jockey, newscaster, or radio technician. Complete day and night classes... the latest equipment. Free placement service. Approved for veterans. Write for free booklet.

Don Martin School of Radio Arts

1655 North Cherokee St. Hollywood 28, Calif.

Hollywood Experts Help You **Make Good in RADIO-TELEVISION** at Home

Direct from Hollywood, nerve-center of broadcasting, Television, Radio and Sound activities, comes R-T-A's time-proven and tested home training. Here at last—easy to learn, home instruction that quickly qualifies you for steady, good-pay jobs or your own Radio business. 10 big kits of radio parts given at no extra charge. Get full details at once! Send postal for FREE BOOK "How to Make Good in Radio-Television."

RADIO TRAINING ASS'N OF AMERICA, Dept. RCK
3620 Hollywood Blvd. Hollywood 28, Calif.

LEARN then EARN in RADIO

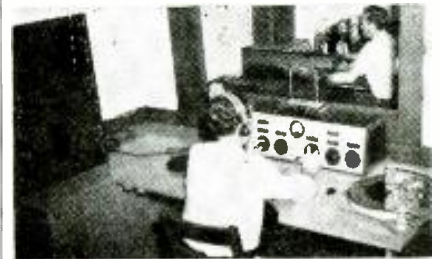

COURSES OFFERED IN
Broadcast Engineering
Commercial Oper. (Code)
Frequency Modulation
Television
Announcing

100% PLACEMENT SERVICE
APPROVED FOR VETERANS
WRITE FOR FREE BULLETIN

Cook's Radio School

DEPT. RC
2933 NORTH STATE ST.,
JACKSON, MISSISSIPPI

TELEVISION 1948!!

Train at an institute that pioneered in TELEVISION TRAINING since 1938. Morning, Afternoon or Evening Sessions in laboratory and theoretical instruction, under guidance of experts, covering all phases of Radio, Frequency Modulation, Television, lead to opportunities in Industry, Broadcasting or own Business. Licensed by N. Y. State. Approved for Veterans. ENROLL NOW FOR NEW CLASSES
Visit, Write or Phone

RADIO-TELEVISION INSTITUTE

480 Lexington Ave., N. Y. 17 (46th St.)
PLaza 3-4585 2 blocks from Grand Central

RADIO COURSES

Preparatory, Service, Broadcast, Television, Marine Operating, Aeronautical, Frequency Modulation, Radar.
Classes now forming for mid-year term Feb. 1st
Entrance exam. Jan. 17
Veterans. Literature,
COMMERCIAL RADIO INSTITUTE
(Founded 1920)
38 West Biddle Street, Baltimore 1, Md.

RADIO COURSES

- RADIO OPERATING
 - RADIO SERVICING
 - CODE
 - ELECTRONICS
 - F.M. TELEVISION
 - REFRIGERATION SERVICING
- Write for Catalog and Picture Brochure
Y.M.C.A. TRADE & TECHNICAL SCHOOLS
15 W. 63rd St. (N'r B'way) New York City

FM INTERFERENCE

Dear Editor:

I have just read Mr. Zarattaro's letter in the August issue and want to suggest to him and others that the solution to the automobile interference problem seems to be either spark-plug suppressors or the new resistor spark plugs (see the September issue, page 86).

Also, I would like to advise fellow readers to beware of induction-type suppressors. They are likely to arc between turns of the coil, which consists of fine wire scramble-wound. The arcing makes matters worse.

R. J. FIEDLER,
Baltimore, Md.

SUPPRESSORS STOP NOISE

Dear Editor:

I read with interest Mr. Zarattaro's letter in the August issue on ignition interference on FM. He is certainly right. Many listeners in suburbs or rural areas are plagued by the noise of cars going by right in the middle of an FM program.

However, I have found that cars with proper suppression will not cause this racket. A simple distributor resistor of 10,000 or 15,000 ohms will do wonders, as will resistor spark plugs.

An active campaign is necessary to get car owners to install these simple but effective suppressors. Would it be possible to get the FCC to do something? If an amateur causes interference, he gets into trouble. Isn't a spark plug really a little transmitter?

CHARLES C. BOEHNKE,
Los Gatos, Calif.

ADVISES GOOD ANTENNA

Dear Editor:

I do not see why Mr. Zarattaro should be so troubled by ignition noises. Perhaps either his receiver or antenna is not adequate.

I am located in an area with high ignition noise. With an ordinary dipole on the roof, enough noise was present to make an annoying clatter and mar the otherwise perfect reception from my Pilotuner. When I installed a double dipole with reflectors, the annoyance decreased until it is barely noticeable on even weak stations. I believe that additional antenna gain will solve the problem entirely. A friend tried the same cure with similar good results.

WILLIAM BANDES, JR.,
Nescopeck, Pa.

NOISE TOO MUCH FOR HIM

Dear Editor:

I agree with Mr. Zarattaro's letter (Communications, August, 1948, page 82) that automobile ignition systems ruin FM. I have two FM sets, an 11-tube RCA 711V3 and a Pilotuner, both using folded dipoles with reflectors located 50 to 100 feet from the street. When the traffic is heavy, I have had to turn off FM stations and listen to programs on AM to avoid ignition noise.

PHILIP J. BRASSINGTON,
Easton, Pa.

LEOTONE **FACTORY SPEAKER REPAIRS** Since 1927

- CHARGER BASE SLIDERS. Smooth ball-bearing heavy-duty aluminum 11" extension. For 400 or 400mm. 11" ext. 11" ext. \$1.98
- 11" extension per pair \$1.89
- Shpg. wt. 2 lbs. per pair.
- NOISE FILTER for MOBILE POWER SUPPLIES. 110 mhos. 6-30V. DC. Thermionically coated metal disk. 2 1/2" x 1 1/2" .59
- R-89 ARN-5A GLIDE PATH RECEIVER. 332-333mm. Complete & in excellent condition. Less tubes & crystals. Shpg. wt. 14 lbs. \$2.95
- WITH FULL SCHEMATIC. NOW ONLY \$2.95
- R-89 schematic only .10c
- ALNICO MAGNETS-EXPERIMENTAL KIT of 10 ass'd powerful Bar, "U", Block, Circular, etc. Kit of 10 \$1.98
- RCA UX-200 TUBES. Ideal triode detector. Brand NEW \$8 for 1.00
- BENDIX AMPLIFIER. Line of Signal 115V. 400 cycle. Contains 3 audio & 1 power tube. 6 oil cond., plus many other components with several times the price. Black crackle finish case. 7 1/2" x 3 1/2" x 4 1/2". Shpg. wt. 9 lbs. 1.95
- SELSYN CONTROL TRANSFORMER (2J1G1), 115V 400 cy. Shpg. wt 2 lbs. 1.49
- CRYSTAL MICROPHONE. Sensitive diaphragm type. Small size 1 1/2" O.D. 1 1/2" deep. Ideal for REGULAR LAPTEL or CONTACT MIKE or as FIELD W. SPEAKER. Rubber shock-mtd. metal frame. Less housing .98
- 12 for \$10.00

!! KIT OF THE YEAR !!
LEOTONE'S "JUMBO RADIO PARTS ASSORTMENT"
You can't afford to miss this TREMENDOUS BARGAIN OFFER of new and dismantled radio and electronic parts. 17 FULL POUNDS of: TRANSFORMERS, COILS, SOCKETS, WIRE, SPEAKER ACCESSORIES, HARDWARE, CONDENSERS, ETC., ETC. ALL THESE AND MUCH MORE (shpg. wt. 21 lbs.) for only \$2.95

- EXPERIMENTAL TUBES—Handy assortment of 20 receiving types. For testing, research, etc. All elements tested. \$1.00
- 6 TUBE CHASSIS. Punched steel for easy rig. of parts. 10" x 4 1/2" x 1 1/2". Shpg. wt. 2 lbs. .23
- 5 for \$1.00
- RECORDING PARTS SPECIALS!—RM-4 HP RECORDING MOTOR Heavy duty 110V 60 cycles. Adaptable to WIRE, TAPE or DISC RECORD & PLAYBACK 3 1/2" sq. x 2 1/4". Less electric. mg. plate & reduction drive wheel. Shpg. wt. 3 lbs. 4.95
- PERMALLOY LAMINATIONS for constructing TAPE RECORDER HEAD. Per "cancel" only laminations .40
- MAGNET WIRE to wind complete TAPE HEAD. No. 27 B-35c, No. 28PE-59c, No. 30 SCC-45c. Kit of all 3 stands 1.25
- HYFLUX RECORDING TAPE Recommended for highest fidelity & permanency. Standard 2.98
- Alnico ERASE MAGNET for TAPE or WIRE U shape .39
- SCR-274-ARC-5 TRANSMITTER P.A. COILS—In following ratings: 6E1, 1-3-2-1, 2-1-4, 4-5-3, 3-4-3, or 7-9-1 .49

SOMETHING FOR EVERYBODY
WRITE TODAY FOR ANY OF THESE FREE SUPPLEMENTS:
"RECORDING PARTS & ACCESSORIES"
"ALNICO MAGNETS"
"HEARING AID & MINIATURE PARTS"
"RADIO & ELECTRONIC COMPONENTS"
"GEARS, SHAFTS & PULLEYS"

- TERRIFIC TUBE VALUES—STOCK UP NOW at up to 80% off list. Perfect condition; unopened cartons. Most types in stock. ALL GUARANTEED FOR 90 DAYS!
- No. 27, 35, 37, 39, 77, 84, 85, 5W4, 5Z3, 39c
 - 6A3, 6BH, 6K7, or 6X5
 - No. 41, 78, 1A7, 1LN7, 5Y5, 5Y4, 8A4, 6BT, 6C5, 6F5, 6F6, 6G5, 6J5, 6K6, 6L6, 6SA7, 6SN7, 6SH7, 6SK7, 6T7, 7A7, 7B8, 7Y4, 49c
 - 12SK7, 12SA7, 9013
- TUBE CARTONS: Plain White
- Miniature (1 1/2" sq. x 2 1/2") Per 100 \$.98
 - GT size (1 1/2" sq. x 3 1/2") Per 100 .125
 - Medium (1 1/2" sq. x 4 1/2") Per 100 1.49
 - Large (2" sq. x 5") Per 100 1.79

- HANDY RADIO PARTS KITS**
- No. 1—R.F. ANTENNA & OSC. COILS \$.98
 - 100 BENT
 - No. 3—MOULDED BAKELITE CONDENSERS 2.95
 - SERS 700 ass'd. 001-01 in 2 mil. 2000-6000WV. Clearly marked
 - No. 5 ELECTROLYTICS 10 ass'd. in 1 mil. multi-layered paper & can types. 1.49
 - No. 9—WAFFER SOCKETS 12 ass'd. 4 .25
 - for T-tuning
 - No. 10—VOLTAGE DIVIDERS 10 ass'd. in 1 mil. multi-layered paper & can types. 1.98
 - No. 11—SHIELD CANS 15 ass'd. for coils, tubes, transformers, etc. .98
 - No. 15—WIRE-WOUND RESISTORS 15 ass'd. ohmage 5 to 20 Watts .58

Min. order \$2.00. 20% Deposit Req. on C.O.D.'s
Please add sufficient postage—Excess Refunded

LEOTONE RADIO CO.
65-67 Dey St., New York 7, N. Y.
WOrth 2-0284

THIS SIMPLE BENCH TEST

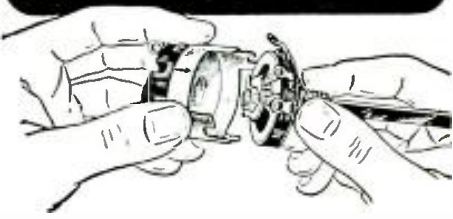

proves you're right

Remove the cover from an IRC control, and from any other reputable control. You'll immediately see the superior IRC construction. Features that insure long dependable performance. Point by point, compare IRC's design to that of any other control and you'll know you're right when you ask for IRC!

Notice—the terminals are riveted assuring positive electrical contact. Gliding "5-finger" contactor provides smooth gradation of volume. Silent Spiral Spring connector eliminates principal source of control noise. Resistance material bonded to bakelite base gives an even, long wearing element.



ALL METAL CABINET

Add time-saving convenience to the other features of IRC controls by buying a practical stock in this handsome all-metal cabinet. With this minimum investment of 18 Type D Controls plus switches and special shafts, the sturdy cabinet is furnished at no extra charge. You pay only the standard net price of the merchandise. Fast moving control stock in this IRC cabinet services 90% of the Howard Sams RED BOOK listings.



401 N. Broad St., Phila. 8, Penna.
In Canada: International Resistance Co., Ltd.
Toronto, Licensee

Yes! We're listed in the RED BOOK
Looking for the correct IRC replacement controls for any receiver manufactured from 1938 to 1948? Just refer to The Radio Industry RED BOOK.

SUPER VALUES from MID-AMERICA!

Stromberg-Carlson DYNATENNA

This famous-make FM antenna has been advertised and sold for many times the low price MID-AMERICA asks! Covers both FM bands. Delivers FM reception at its best. Complete with 60 ft. of 300-ohm twin lead-in. Line is standard approved flat-type, solid dielectric with weather-resisting insulation. Mounts anywhere easily... vertically or horizontally to match polarization of trans-

mitting station. Illustrated instructions and all necessary hardware. A screw-driver is only tool needed for assembly. Dynatenna is seamless, heat-treated, all aluminum... will withstand severest weather.

\$4.95

each
\$4.45 each
in lots of 3



PERMEABILITY TUNER

Build a really HOT 5 or 6-tube AC-DC superhet receiver! Takes place of old-style gang condenser, of and antenna coils; regular 455 KC intermediate frequency. **MA-2167** Complete with permeability tuned oscillator coil. 4" x 2 1/2" x 2 1/2"; 2 1/2" diameter dial drum. Complete with diagrams for building 5 and 6 tube sets. Order **MA-2169** Loop Antenna... 15c
Order **MA-2014** Drilled, punched Chassis... 39c



BANTAM 1-WATER

BGR-746-A tuning unit used as foundation for Bantam 1-Watter described in Jan. 1948 OST. Make a tiny crystal-controlled CW transmitter. Measures only 3 1/2" long, 2 1/2" high, 1 1/2" wide. Requires only 1 1/2 volts "AA", 30 to 90 volts "B". Draws 8 to 15 ma under load. Supplied less crystal, 184 tube and plug-in coil **MA-907**... **24c**

SPECIAL AUDIO TRANSFORMERS

Exceptionally high-quality universal output transformer for up to 12" speakers. Rated at 12 watts. Matches any single, push-pull or parallel tubes to 6-ohm voice coil. 12 color-coded leads. 2" high with 2 1/2" mounting centers for installation on chassis or speaker. Complete with instructions for matching tube impedances. **MA-1205**... **\$1.19**

Hermetically sealed 200 ohm CT to 50,000 ohm grid. U-e-as microphone transformer, line-to-grid, etc. 2 1/2" x 1 1/2" x 1 1/2". **MA-1262**... **69c**

Single 3000-ohm to 4-ohm voice coil output for 50L6, 35L6, etc. 1 1/2" high on 2 1/2" mounting centers. **MA-1255**... **49c**

Heavy Duty Noise Filters

Rated on 10 amps, 115-volt AC. Measures only 1" x 1 1/2" square. Install right in amplifiers, receivers and other equipment where line noises must be kept at a minimum. Nationally-known manufacturer. **MA-2164**... **79c**

Filter for mobile power supplies. Rated 10 amps, 6-30 VDC. Has additional 2 mfd. 100 VDC condenser. 2" high, 2" square. **MA-2165**... **59c**

SPEAKER SPECIALS

All with Heavy ALNICO 5 Slugs

3 1/2" PM **MA-2062**... \$1.39 4x6 Oval PM **MA-2187** \$1.39
5" PM **MA-2071**... \$1.39 6" PM **MA-2189**... \$1.95

ORDER FROM THIS AD!

Quantities are limited, so get your order in now! Minimum order shipped, \$2.50. Send 25% deposit, balance C. O. D. Get on MID-AMERICA's mailing list to receive BIG BARGAIN BULLETINS that list latest, greatest buys in radio parts, electronic equipment. Send orders to Desk 114.

MID-AMERICA CO. Inc.

2412 S. Michigan Avenue
Chicago 16, Ill.

NOW! CASH IN on TELEVISION



FM and TELEVISION SWEEP SIGNAL GENERATOR \$34.95

A must for progressive service shops—a buy at this sensationally low price! Accurate!—Aligns FM and television receivers. Frequency range 2-227 MC. Output modulated or unmodulated. High frequency insulation throughout, built-in power line filter and special Midline capacity tuning condenser. Easy to operate—use it to adjust to new TV channels. AC only. Exceptional opportunity to purchase instrument of this kind direct from manufacturer at a tremendous saving!

WIRE RECORDER and RECORD PLAYER \$109.00



Complete with 2 spools of wire cord for radio recording and d microphones.

For Pleasure or Profit

Simply press a button and begin recording—anything you can hear, it will record and play back! You can make a permanent record, or with the money-saving "eraser" device use the same wire again and again. ALSO: has a TURN-TABLE that plays standard 10 and 12" discs! It's a 3-in-1 machine—and simplicity itself to operate! Microphone has table stand attachment—lets you record programs without use of microphone—gets improved quality. Operates on AC. Beautiful luggage-type carrying case. Size: 9 1/2" x 17 1/4" x 14 1/4".

All Items Backed by ECA with RMA Guarantee

Enclosed find check (or money order) in full
 20% deposit, bal. C.O.D. for the following:
 Send me FREE ECA Bargain Bulletin
 FM Sig. Generator \$34.95.
 Wire Recorder \$109.00.

Name
Address
City Zone... State.....

ELECTRONIC CORP. OF AMERICA
353 W. 48th St. New York 19, N. Y.

WHAT'S IN A NAME

Dear Editor:

I shall continue to buy RADIO-CRAFT no matter what the name or cover. I buy it for what is inside.

The name "Radio-Craft" does not cover the entire contents of the magazine, but no title will, unless you put the whole table of contents on the front cover, like the digest magazines.

Old readers, too, will stick with the magazine regardless of the title. But don't forget to leave some "craft" in the contents for the boys who are just coming into radio. They would never get started with television and u.h.f. in the beginning. Another thing: many people like to read about the new and up-to-the-minute gear, even though they never expect to own it.

Don't change the inside of the magazine. It's good as it is.

J. W. BELL,
Coatesville, Pa.

LIKES NEW FORMAT

Dear Editor:

I wish to commend you for the many improvements in the magazine in the past months. Reading it has always been an interesting, educational experience; however, your new format and the consolidation of each article into one continuous unit have made reading a genuine pleasure. Further, your expanded coverage of the entire radio-electronics field makes RADIO-ELECTRONICS a factual journal of the entire electronics industry.

K. E. FORSBERG,
Sauk Centre, Minn.

CARS ARE TRANSMITTERS

Dear Editor:

Mr. Zarattaro sure spoke a parable in his letter on page 82 of the August issue.

I have a G-E XFM-1 receiver, with antenna 20 feet high located 90 feet from a highway and parallel thereto. A passing truck can be heard from the time it gets within 400 feet until it is the same distance in the opposite direction. At a speed of 30 miles per hour that takes about 20 seconds. This interference is certainly the bane of FM reception.

Cars equipped with radios have spark suppressors that render them perfectly quiet. This suggests the only angle from which this problem can be tackled. The law should require that all cars be equipped with spark suppressors and subject them to inspection the same as brakes and lights.

Even with the laws as they are now, I don't see why the FCC can't arrest and fine truck drivers or owners for transmitting without a license and causing intolerable interference.

FM has come to stay. Ignition noise must go!

FREDERICK E. WARD,
Cataumet, Mass.

Freq.	Station	Location and Schedule
15.450	GRD	LONDON, ENGLAND: 0100 to 0500; 1700 to 2030
15.590	FZ1	BRAZZAVILLE, FRENCH EQUATORIAL AFRICA: 0415 to 0800; 0930 to 1030
17.440	HVJ	VATICAN CITY: 0715 to 0845
17.530	FZ1	BRAZZAVILLE, FRENCH EQUATORIAL AFRICA: 0600 to 0130; 0145 to 0245; 1100 to 1700
17.700	GYP	LONDON, ENGLAND: 0600 to 0900; 1700 to 1800
17.710	GRA	LONDON, ENGLAND: 0915 to 0100; 0600 to 0815; 0915 to 1115
17.730	GVQ	LONDON, ENGLAND: 0850 to 0900; 1700 to 1800; 2315 to 0030
17.750	WRUW	BOSTON, MASSACHUSETTS: 1100 to 1215
17.750	WRUX	BOSTON, MASSACHUSETTS: 1725 to 1900
17.760	KWID	SAN FRANCISCO, CALIFORNIA: 1900 to 2230
17.760		PARIS, FRANCE: 0700 to 0900; 1100 to 1230
17.770	OTC	LEOPOLDVILLE, BELGIAN CONGO: 0600 to 0930; 1130 to 1615
17.770	SEAC	COLOMBO, CEYLON: 2300 to 0730; 1100 to 1200
17.780	WNBI	NEW YORK CITY: 0915 to 1715; 1900 to 2230
17.780	KGEX	SAN FRANCISCO, CALIFORNIA: 0900 to 0915
17.790	GSG	LONDON, ENGLAND: 0515 to 0715; 0830 to 1030; 1100 to 1145
17.800	KRHO	HONOLULU, HAWAII: 0230 to 0345 (off Mondays)
17.800	OIX5	LAHTI, FINLAND: 0130 to 0200; 0500 to 0745; 0800 to 1700
17.800	WLWS2	CINCINNATI, OHIO: 1630 to 1700
17.800	WLWK	CINCINNATI, OHIO: 1900 to 2230
17.810	GSV	LONDON, ENGLAND: 0030 to 0300; 0100 to 1130
17.820	KCNC	MONTREAL, CANADA: 2315 to 0100; 0815 to 1030; 1820 to 2100
17.830	WCBX	NEW YORK CITY: 1100 to 1630; 1645 to 1700; 1800 to 1900 (off Sundays); 2100 to 2100
17.830	VUD10	DELHI, INDIA: 0100 to 0700; 0745 to 0800; 2215 to 0215
17.850	KCBF	DELANO, CALIFORNIA: 2215 to 0230
17.880	KGEX	SAN FRANCISCO, CALIFORNIA: 1900 to 2230
17.880	WGEX	SCHENECTADY, NEW YORK: 1100 to 1715
18.020	GRQ	LONDON, ENGLAND: 0100 to 0500; 1100 to 1500
18.080	GVO	LONDON, ENGLAND: 1630 to 1600
18.130	PMC	BATAVIA, NETHERLAND INDIES: 1100 to 1130
18.160	WNRI	NEW YORK CITY: 0600 to 1815
20.000	WWV	WASHINGTON, D.C.: U. S. Bureau of Standards
21.470	GSH	LONDON, ENGLAND: 0700 to 1215
21.460	WRUX	BOSTON, MASSACHUSETTS: 1100 to 1215
21.460	KNBA	DIXON, CALIFORNIA: 1900 to 2230
21.500	WOOW	NEW YORK CITY: 0915 to 1715
21.530	GSJ	LONDON, ENGLAND: 0100 to 1215
21.550	GST	LONDON, ENGLAND: 0100 to 0100; 1230 to 1300
21.570	WCRC	NEW YORK CITY: 1015 to 1630; 1645 to 1700
21.590	WGEA	SCHENECTADY, NEW YORK: 1130 to 1600
21.610	WNRA	NEW YORK CITY: 0900 to 1630
21.640	GRZ	LONDON, ENGLAND: 0600 to 0900; 1100 to 1230; 1300 to 1600
21.650	WLWS1	CINCINNATI, OHIO: 1730 to 1600; 1800 to 2230
21.690	WLWL1	CINCINNATI, OHIO: 1100 to 1630
21.730	WNRX	NEW YORK CITY: 1100 to 1700
21.750	GVT	LONDON, ENGLAND: 0200 to 0715; 1030 to 1045; 1100 to 1130
25.000	WWV	WASHINGTON, D.C.: U. S. Bureau of Standards; continuously day and night
26.100	GSK	LONDON, ENGLAND: 0615 to 1200
30.000	WWV	WASHINGTON, D.C.: U. S. Bureau of Standards; continuously day and night
35.000	WWV	WASHINGTON, D.C.: U. S. Bureau of Standards; continuously day and night

TELEVISION STATION LIST

Station	City	Channel
KDYL-TV	Salt Lake City, Utah	4
KSD-TV	St. Louis, Mo.	5
KSTP-TV	St. Paul, Minn.	5
KTLA	Los Angeles, Calif.	2
KTSL-W6XAO	Los Angeles, Calif.	2
WBAB	New York, N. Y.	13
WATY	Newark, N. J.	5
WBAL-TV	Baltimore, Md.	11
WBEN-TV	Bu'falo, N. Y.	4
WBKB	Chicago, Ill.	4
WBZ-TV	Boston, Mass.	4
WCAU-TV	Philadelphia, Pa.	10
WCBS-TV	New York, N. Y.	2
WENR-TV	Chicago, Ill.	7
WEWS	Cleveland, Ohio	5
WFIL-TV	Philadelphia, Pa.	6
WGN-TV	Chicago, Ill.	9
WJZ-TV	New York, N. Y.	7
WLWT	Cincinnati, Ohio	4
WMAL-TV	Washington, D.C.	7
WMAR-TV	Baltimore, Md.	11
WNAC-TV	Boston, Mass.	7
WNBT	New York, N. Y.	4
WNBW	Washington, D.C.	4
WNHC-TV	New Haven, Conn.	6
WPIX	New York, N. Y.	11
WPZ	Philadelphia, Pa.	3
WRGB	Schenectady, N. Y.	4
WSB-TV	Atlanta, Ga.	8
WSPD-TV	Toledo, Ohio	13
WTMJ-TV	Milwaukee, Wisc.	3
WTTG	Washington, D.C.	5
WTVR	Richmond, Va.	6
WTYR-TV	Detroit, Mich.	4

It's Mutual Help!

Give Us Your Order and We'll Give Low Prices on Your Radio and Electronic Requirements!

Here are Only a Few Specials!

Our 3-Item Special!

- 1—Standard-Phono Motor—9" Turntable
 - 2—Crystal-Pickup—incl. HDWE.
 - 3—Covered record Player Base—13 x 8 1/4 x 3 1/2 with cut-out for Motor
- SPECIAL. ALL 3 for \$4.50
In Lots of 10 42.50

- Over 100 Assorted Resistors 1.15
- 1/4 to 2 Watts 25.00
- in Lots of 25 25.00
- 50L5 Output Transformers, ea. 7.50
- In Lots of 25 7.50
- 12SR7 Sealed Carton Tubes 30
- 100 or More 27.00
- 470 ohm-10W. Resistors .07
- 40 ohm-10W. Resistor, Lots of 100 5.00
- 8 Ft. GE Approved Rubber Line Cord, each 15
- Lots of 100 12.00
- Distributor Suppressors .07
- Lots of 100 5.00
- Miniature Bayonet Pilot Light Sockets .04
- Lots of 100 3.00

All Merchandise Guaranteed. New and Standard Brands. Refund in 10 Days if Returned Prepaid. Send 20% Deposit With Order. Balance C.O.D. Merchandise F.O.B. N.Y.C. OUR ONLY BRANCH

Almo
ELECTRONICS INC.
135 Liberty St., N. Y. 6, N. Y.

WAR SURPLUS
ACT NOW - SAVE BIG MONEY!

- BEAM ANTENNA ROTATOR MOTOR**
Brand new. Operates directly on 110 V. A.C. 60 cycles (requires only 12 MFD condenser) \$3.95
In fractions, incl. Ea. \$3.95
- NEW RADIO RECEIVER BC-341** U. S. A. Signal Corp. Type with 3 tubes including 1 VT-163; 1 VT-91 A; 1 VT-101 in original bakings. \$3.95
Each
- SELSYN #21JIG1** 57.5 V. 100 cps. Can be used on 110 Volt. incl. Instruction Incl. New. \$2.50
Per PAIR ONLY
- RADIO CONTROL BOX** Type Army type BC-AD 231 3 position. Selective switch. Volume control 75c
New, Ea. Only
- JACK BOX NEW BC-366** U.S.A. Signal Corp with 7 positions selective switch vol. control. 75c
New, Ea. Only
- ADEL CLIPS No. 8** 100 for .95c

DYNAMOTORS

- All Brand New in original Packing
- DYN. G.E. Input 27 V.D.C. output 117 V.A.C. KVA. 1.85. New. Ea. \$4.50
 - DYN. new Type D. G.E. Input 20 Amps output 350 Ma 1000 V.D.C. Wt 28 lbs. Ea. \$4.95
 - DYN. new Model 23550. Input 27 V.D.C. 1.50 Amps Output 285V D.C. .075 Amps Ea. \$1.50
 - DYN. new Type DY-22. MFC Input 28 V. D.C. Output 210 V. D.C. Tube Cont. Ea. \$1.75 ea.
 - RARE D.C. GENERATOR BARGAIN. Brand New #211220 130 V. D.C. 86 Watts. Length of SHAFT 1 1/2" \$5.50 ea.
- Send check or money order. No C.O.D.'s. Prices F.O.B. K.C. on orders less than \$2.00 incl. 35c postage.

GENERAL SALVAGE COMPANY
DEPT. 4, 2920 E. 27th St., Kansas City, Mo.

500 FORMULAS TO SUCCESS

MANY million dollar firms started with a single formula, for which they paid a big price. Here you have 500—no less—tried and tested formulas, recipes and processes for making things... all at the ridiculously low price of 25c. Here is your opportunity to start a business with but a few dollars' capital and with undreamed of profits in prospect. You can also use these formulas in your own home to cut household expenses to the bone. Or you can put them to use in your workshop to cut costs as much as 1000%.

Quit paying out many dollars in profits to manufacturers, wholesalers, and dealers, when you can make the same thing yourself for a few cents. It's so easy when you follow our simple instructions.

66 PAGES, 3200 WORDS IN TEXT. Send for "500 FORMULAS AND RECIPES" today. Enclose 25c. That's all! You won't be asked for another cent now or later. Sold on a money-back guarantee.

NATIONAL PLANS COMPANY
P. O. BOX 26 R, STATION N. New York 23, N. Y.



MUST VACATE
WAREHOUSE — ALL PRICES REDUCED FOR CLEARANCE

HUR DC POWER SUPPLY
24-28 V. at 70 amp. 2000 watts gasoline engine generator with electric starter. Power supply which can be used to operate 24-28 V. equipment, start airplane engines, charge batteries, as a welding machine, lighting system, or for amateur radio station. 21 1/2" x 17 1/2" x 24 5/8".
Weight 115 lbs. **89.50**

REMOTE CONTROLLED COIN INSERT & SPEAKER BOX
Made by Personal Music Corp., Newark, N. J.

Model F
24 Volt operated, fused
Weight 6 1/4 lbs.
Size 4 3/4 x 7 1/2 x 5 1/2" high
Sloping front
PM Speaker 5" size
Has 2 Pilot Lights for illumination
Finished in chrome metal and grill with red plastic
Accepts 1 to 6 nickels
Each 5c coin gives about two phono records of music
Should be mounted on flat base
Has Haydon Mfg. Co. timer
Lock installed in top (with key)
Easily removable coin box, size 6 x 3 1/2 x 1 1/2"
Requires 4 wires from power unit
A beautiful piece of equipment that could be built to house coin operated radio
Worth several times our asking price.
Price brand new **4.95**

ULTRA-VIOLET FLUORESCENT COCKPIT LIGHT ASSEMBLY

Air Corps type C-5, 28 V. DC operated. Black plastic case about 1 1/2" dia. x 3" long. Has adjustable mounting flange, 3 foot two conductor shielded cord and plug includes bulb.
Brand new **1.00 ea.**

CO-AXIAL CABLE VALUES

Co-Axial cable values that we can only offer to customers who buy minimum of 100 foot per type.

- RG-8/U cable 52 ohms impedance (unmarked) **2.95 per 100 ft.**
- RG-8/U cable 52 ohms impedance (marked) **3.95 per 100 ft.**
- RG-29/U Co-axial 53.5 ohms impedance (marked) **3.95 per 100 ft.**

Telephone LINCOLN 8328

TERMS: CASH WITH ORDER

AMERICAN SURPLUS PRODUCTS CO.
537 N. CAPITOL AVE
INDIANAPOLIS IND

Presenting

3 Great New "Elmco" Amplifiers!



MODEL A-100
5 Watt AC Phono Amplifier Complete with Tubes, On-Off Switch, 6" Inecord, built-in Output Transformer, Phono-Jack.

\$18.75
List



MODEL A-101
5 Watt AC Phono Amplifier Complete with Tubes, On-Off Switch, 6" Inecord, built-in output transformers, Mic. and Phono-Jacks. Microphone and Phonograph channels can be intermixed.

\$20.42
List

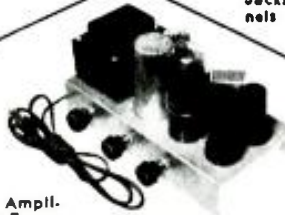

MODEL A-102
8 Watt AC Microphone and Phono Amplifier. Built in 6 Impedance Output Transformer, Mic. and Phono Jack. Hum Level at Normal Output: -58db. Frequency: 40 to 10,000 c.p.s.

\$28.65
List

Prices slightly higher
West of the Rockies.

EACH UNIT PACKED IN INDIVIDUAL CARTONS WITH INSTRUCTION SHEETS AND CIRCUIT DIAGRAM.

The "ELMCO" Amplifiers are designed for highest quality reproduction of sound, music and speech. These amplifiers used in conjunction with suitable accessories will give the user most gratifying results. They have been engineered to meet exacting requirements for High Fidelity pickups, FM, AM, Tuners and Mikes.

Choice Territories still available to Mfg. Representatives. Write for complete details.

Dealer inquiries invited.
Write for free catalog.

Elmhurst Sound Equipment Co.

58-23 - 79th Street
Elmhurst, N. Y.

GET ON THE BANDWAGON!

NATIONALLY ADVERTISED TUBES

60% OR MORE OFF, INDIVIDUALLY BOXED.

12SA7	.61	12BH6	.68
12SK7	.61	12BA6	.68
12SQ7	.54	12AT6	.59
45Z5	.45	63W4	.45
50L6	.61	50B5	.65

NALF. ADV. COND. 00.20 MFD. 150V. .49
 (STR. MFD. G)
 NALF. ADV. COND. 10.10 MFD. 450V. 20 MFD. .79
 25V. E.P.
 DEAL. COND. 50' STABLE WAXY STRETCH .59

REPAIRMAN.
GET ON OUR ACTIVE MAILING LIST NOW!
20% Deposit Required With C.O.D. Orders.
JOYCE RADIO DISTRIBUTING CO.
HOLLYWOOD 28, CALIFORNIA

DON'T BUY

a Magnetic TAPE RECORDER

UNTIL

you find out about the remarkable new instrument that **DOUBLES** your playing time—cuts your tape costs in **HALF!** Write today for technical literature.

AMPLIFIER CORP. OF AMERICA

398-10 Broadway New York 13, N.Y.

TALK ANYWHERE

Instantly To Anyone with Inter-Talkie! Just push buttons and talk to or from 7 different places! Not a phone—loud room volume—no electric "plugs-in" or tubes needed! Sit or hang it! Simple and quick to hook up! For homes, offices, stores, f.a.r.m.s., etc. Guaranteed! Write for free details today!
ONLY \$9.97 EACH
MIDWAY SALES CO., Dept. RC-11, Kearney, Nebr.



Freq.	Station	Location and Schedule	Freq.	Station	Location and Schedule
11.830		CONSTANTINE, ALGERIA: 0130 to 0145; 0630 to 0915; 1315 to 1400, 1430 to 1700	15.170	TGWA	GUATEMALA CITY, GUATEMALA: 0730 to 1700
11.840		PRAGUE, CZECHOSLOVAKIA: 1030 to 1100; 1115 to 1130; 1200 to 1215; 1215 to 1230	15.180	GS0	LONDON, ENGLAND: 2300 to 1600, 1615 to 2015
11.840	VLC7	SHEPPARTON, AUSTRALIA: 2330 to 0015; 1500 to 1615	15.190	CKCK	MONTREAL, CANADA: 0815 to 1100; 1520 to 1905
11.840		PARIS, FRANCE: 0030 to 0130; 0145 to 0300; 0915 to 2215; 0000 to 0015	15.190	TAQ	ANKARA, TURKEY: 0000 to 0200; 0615 to 0730
11.860	KWIX	SAN FRANCISCO, CALIFORNIA: 0100 to 0230	15.200	WRUA	BOSTON, MASSACHUSETTS: 1115 to 1400
11.870	MUNICH	MUNICH, GERMANY: 1100 to 1700	15.210	WBOS	BOSTON, MASSACHUSETTS: 1300 to 1700; 2030 to 2230
11.880		MOSCOW, U.S.S.R.: 1820 to 1930, 2000 to 2015	15.210	KGEI	SAN FRANCISCO, CALIFORNIA: 0030 to 0230
11.880	LRR	ROSARIO, ARGENTINA: 0100 to 2100	15.220	WRUA	BOSTON, MASSACHUSETTS: 1530 to 1815
11.890		MANILA, PHILIPPINES: 0400 to 1005	15.230	VLG6	MELBOURNE, AUSTRALIA: 2330 to 0015; 0100 to 0115; 2200 to 2300; Sat & Sun, 2100 to 2300
11.900	KWID	SAN FRANCISCO, CALIFORNIA: 0030 to 0230	15.230		PRAGUE, CZECHOSLOVAKIA: 1800 to 1900
11.900	XGOY	CHUNGKING, CHINA: 0400 to 0530; 0545 to 0630; 0815 to 1045	15.230	MOSCOW, U.S.S.R.:	0745 to 0815; 1820 to 1930; 2000 to 2130; 2200 to 0200
11.900	CXA10	MONTEVIDEO, URUGUAY: 1930 to 2115	15.250	WLW0	CINCINNATI, OHIO: 1130 to 1630
11.960	HEK4	BERNE, SWITZERLAND: 1615 to 1715, except Saturdays	15.250	KNBX	DIXON, CALIFORNIA: 0630 to 0315; 1300 to 2230
11.970	FZ1	BRAZZAVILLE, FRENCH EQUATORIAL AFRICA: 0000 to 0330; 0415 to 0800; 0930 to 1030; 1100 to 2020	15.250	KRHO	HONOLULU, HAWAII: 0100 to 1005
12.000	CE180	SANTIAGO, CHILE: 0600 to 0800; 1600 to 2000	15.260	GS1	LONDON, ENGLAND: 0100 to 0300; 0615 to 1815
12.090	GRF	LONDON, ENGLAND: 2300 to 1615; 1700 to 2030	15.270	WCBN	NEW YORK CITY: 1200 to 1715
12.210	TFJ	VIENNA, AUSTRIA: 2315 to 1800	15.270	WCRC	NEW YORK CITY: 1900 to 2230
12.260	TFJ	REYKJAVIK, ICELAND: Sundays, 0900 to 0930	15.270	SINGAPORE	MALAYA: 0630 to 1200 to 1200
12.500	HCJB	QUITO, ECUADOR: 1100 to 2230; Mon, 2230 to 2400	15.280	WNRE	NEW YORK CITY: 1015 to 1630
15.000	WWV	WASHINGTON, D. C.: U.S. Bureau of Standards; frequency, time, and musical pitch; broadcasts continue only day and night	15.290	WRUA	BOSTON, MASSACHUSETTS: 1900 to 2230
15.100	HCJB	QUITO, ECUADOR: 0500 to 1200; 1330 to 2230	15.290	WRUL	BOSTON, MASSACHUSETTS: 1200 to 1400; 1430 to 1715; 1730 to 1900; Sundays to 1800
15.110	GWG	LONDON, ENGLAND: 0100 to 1600; 1800 to 1930	15.290	VUD11	DELHI, INDIA: 2215 to 0030; 0125 to 0150; 0200 to 0400; 0500 to 0700
15.120	HVJ	VATICAN CITY: 0830 to 0930; 1100 to 1115	15.300	GWR	LONDON, ENGLAND: 1200 to 1315
15.120	SEAC	COLOMBO, CEYLON: 1930 to 2000; 2030 to 0500; 0700 to 1200	15.300	GSP	SINGAPORE, MALAYA: 0330 to 1200
15.130	WDDC	NEW YORK CITY: 0900 to 1815	15.310	VLC4	LONDON, ENGLAND: 1015 to 1315; 2315 to 0030
15.130	KCBR	DELANO, CALIFORNIA: 1900 to 2300; 0400 to 1005	15.310	HER6	SHEPPARTON, AUSTRALIA: 0215 to 0315; 0345 to 0730; 0800 to 1045
15.130	KNB1	OIXON, CALIFORNIA: 0230 to 0315 (off Mondays)	15.310	WLWR2	BERNE, SWITZERLAND: 1515 to 1630; 1645 to 1715; 1830 to 2000; 2030 to 2230
15.140	GSF	LONDON, ENGLAND: 0600 to 0715; 0915 to 1015; 1030 to 1200; 1300 to 1600; 1615 to 2015; 2300 to 0100	15.330	KCBA	MOSCOW, U.S.S.R.: 2200 to 2500; 0000 to 0500; 0530 to 0800; 0830 to 1100
15.150	WRCA	NEW YORK CITY: 1400 to 1700; 1800 to 1900; 2000 to 2100	15.330	WGEO	DELANO, CALIFORNIA: 0100 to 0930
15.150	KCBA	DELANO, CALIFORNIA: 2215 to 0330	15.330	SCHENECTADY	NEW YORK: 1115 to 1515
15.150	SBT	STOCKHOLM, SWEDEN: 0145 to 0645; 1000 to 1100; 1230 to 1330; 2000 to 2100	15.330	MANILA	PHILIPPINES: 0230 to 0315
			15.330	CINCINNATI, OHIO:	Sundays, 1900 to 2230
			15.340	MOSCOW, U.S.S.R.:	2200 to 0800, 1000 to 1100
			15.350	PARIS, FRANCE:	0700 to 0800; 1700 to 1715; 1915 to 2015; 2030 to 2045
			15.350	CINCINNATI, OHIO:	1200 to 1600; 1630 to 1700

World-Wide Station List

By ELMER R. FULLER

HCJB in Quito, Ecuador, known the world over as the "Voice of the Andes" is heard on 12,500 mc in English from 0630 to 0800; 1700 to 1800; and 2100 to 2400. Programs in other languages, 18 in all, are broadcast at other times; and other frequencies in use are 6,200, 9,900 and 15,100 mc. HCJB was first organized in 1931 and now has six transmitters, both long and short wave. The languages used include Spanish, English, French, German, Portuguese, Russian, Italian, Dutch, Swedish, Yiddish, Greek, Lithuanian, Bohemian, Latvian, Czech, Arabic, Urdu, and Quechua. It is also known as the pioneer missionary radio station, and is supported entirely by contributions from its listeners. The signals are among the strongest received in this country, and are very consistently heard. The station is always silent on Mondays.

The BBC is now being beamed to North America on 11,800 mc from 0600 to 0800; on 21,550 mc from 0800 to 1600; and on 15,110 mc from 1400 to 1915. Also on 11,800 from 1615 to 2215 and on 9,830 mc from 1930 to 2215 hours. All times are Eastern Standard.

Advice has been received from the manager of the "Voice of Guiana." ZFY, stating that the station may be heard on Sundays from 0545 to 1145 and 1445 to 1945 hours; and on Wednesdays from 0545 to 0745; 0945 to 1145; and 1445 to 1945 hours. The frequency is 6,000 megacycles. This is the pioneer broadcasting station in the British West Indies and started operation in 1935. At present they carry commercially sponsored programs and soon will have a station operating in the standard broadcast band. Their signals are heard well in the Guianas, Trinidad, Grenada, and Barbados.

It can be expected that several of the schedules will be changed when the clocks are returned to standard time, but most of them will remain as they have been published. A major change will probably be made in the U. S. schedules and it can generally be figured that all schedules will be moved one hour.

International schedules are never as much affected as those of the stations which broadcast for local consumption, of course. Remember that this list is *always* in Eastern Standard Time, and will remain so until and unless the majority of our shortwave listeners prefer another system. Please consider this until new schedules are printed, which will be in the January issue.

Next month we again print an FM Station List, completely revised to date. Many new stations have appeared since our last list was printed in the September issue, so owners of FM receivers will find the new edition very useful.

RADIO-ELECTRONICS for



NOW!

BUILD 15 RADIOS

COMPLETE KIT ONLY... \$14⁷⁵

ABSOLUTELY NO KNOWLEDGE OF RADIO NECESSARY
YOU NEED NO ADDITIONAL PARTS!

THE PROGRESSIVE RADIO KIT is the ONLY COMPLETE KIT

Operates on 110-120 volts AC DC. Contains everything you need. Instruction Book. Metal Chassis, Tubes, Condensers, Resistors and all other necessary radio parts. The 36-page Instruction Book written by expert radio instructors and engineers teaches you to build radios in a professional manner. The first circuit built is a simple one-tube detector receiver. Each succeeding circuit incorporates new arrangements of detectors, RF and AF amplifiers. This kit is excellent for learning the principles of receiver, transmitter and amplifier design. It is used in many radio schools and colleges. All of the commonly-used detectors are used, including diode, grid leak, plate and infinite-impedance. The transmitters are designed with Hartley and Armstrong oscillators, using screen-grid and control-grid modulation. Both vacuum tube and selenium rectification

are employed in these circuits. The circuits are designed to provide excellent performance. Altogether, fifteen circuits are constructed, including 11 receivers, 1 audio amplifier, and 3 transmitters. The sets start with simple circuits of 1 tube plus rectifier, gradually grow more complex, and finish with several examples of radio sets using three tubes plus rectifier.

PROGRESSIVE RADIO KIT ONLY \$14 75

SPECIAL FREE OFFER

Electrical and Radio Tester sent absolutely FREE with each Progressive Radio Kit. PLUS FREE membership in Progressive Radio Club. Entitles you to free expert advice and consultation service with licensed radio technicians. Write for further information or ORDER your KIT NOW!

WE PAY POSTAGE ON PREPAID ORDERS

C.O.D. ORDERS SHIPPED COLLECT

ATTENTION RADIOMEN!!

Send for Your FREE DEALERS catalog and Price List Today!

• RADIO KITS • AMPLIFIER KITS • FM COIL & CONDENSER KITS • RESISTOR KITS • CONDENSER KITS • RADIO TOOL KITS • FM-AM CHASSIS • SPEAKERS • RADIO PARTS • PORTABLE RADIOS • CAMERA-RADIOS • TUBES • AUTO RADIOS • HOME RADIOS • TELEVISION SETS • TELEVISION CABINETS • TEST EQUIPMENT • FM TUNERS

PROGRESSIVE ELECTRONICS CO.

DEPT. RC-19 497 UNION AVE. BROOKLYN 11, N. Y.

YOU DON'T HAVE TO GRUNT & SWEAR & SWEAT

when installing Wright Verified Speakers with the new Adjustable Mounting Bracket

They fit on like an old shoe

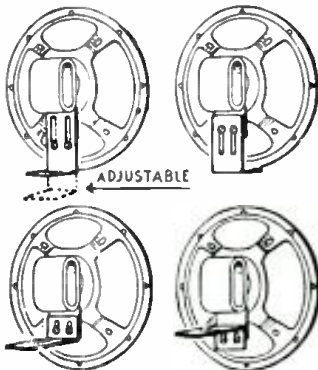

Write for literature and name of nearest distributor

WRIGHT

Inc.

2234 University Ave. St. Paul 4, Minn.

RADIO-ELECTRONICS needs more photos of service shops and service benches. We will pay \$6.00 for each 6x8- or 8x10-inch glossy photo accepted. Do not "dress up" your bench, but take a bona-fide photo preferably with men working.

• TEST-AID • FIRST-AID FOR RADIO-TELE SETS



ONLY \$15⁹⁵

COMPLETE

AT YOUR DEALER OR POSTPAID ANYWHERE IN U.S. WRITE NOW

- QUICKLY LOCATES FAULTY CONDENSERS AND RESISTORS FOR FAST SERVICING
- SUBSTITUTES 11 DIFFERENT VALUES OF CAP. OR RES. WITH SET IN OPERATION 50mmf to 40mfd 450-600 WVDC—27 ohms to 5 meg.
- CHECKS CONDENSER LEAKAGE ON DIRECT CURRENT SUPPLIED FROM OWN PWR SUP.
- OUTPUT INDICATOR FOR ALIGNMENT—CONTINUITY CHECKS
- PROVIDES 100 VOLTS AT 100 MA FOR EXPERIMENTS.

These are only a few of the many uses of the TEST-AID. WRITE FOR CATALOG SHEET TO DEPT. II

Custom Craft

MANUFACTURING CO.

256 E. 98th STREET, BKLYN, N. Y.

Get Started in Radio



10 "HOW-TO-DO-IT" BOOKS

Get a solid foundation in radio by means of these 10c timely text books. Each clearly written, profusely illustrated, contains over 15,000 words. You'll be amazed at the wealth of information packed into these handy books. Excellent for reference—ideal for technical library. Your money back if not satisfied.

5 BOOKS for 50c
10 BOOKS for \$1.00
Sent to You Postpaid

- | | |
|--|-------------------------------------|
| No. 1—How To Make Four Dierie Short Wave Sets | tionary (Leading Terms) |
| No. 2—How To Make The Most Popular All-Wave 1 and 2 Tube Receivers | No. 6—How To Have Fun With Radio |
| No. 3—Alternating Current for Beginners | No. 7—How To Read Radio Diagrams |
| No. 4—All About Aerials | No. 8—Radio for Beginners |
| No. 5—Beginners' Radio Dictionary (Leading Terms) | No. 9—Simple Electrical Experiments |
| | No. 10—Television |

Remit by check or money order—register letter if you send cash or stamps.

RADIO PUBLICATIONS

5A West B'way, New York (7)

CAPACITOR DROPS VOLTAGE

When the filament-dropping resistor in a transformerless receiver burns out or when a new set is being built, a capacitor can be used instead of the resistor to drop line voltage to a suitable value for the filaments. To calculate the value of the capacitor use the formula

$$C = \frac{2650}{\sqrt{E_{line}^2 - E_{fil}^2}}$$

where E_{line} is the power-line voltage, E_{fil} is the total voltage drop across the filaments in series, and I is the rated filament current. This is for a 60-cycle line.

For instance, to find the proper capac-

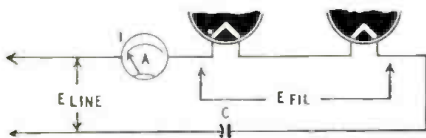

itor for a device using two tubes, each with a 12.6-volt filament drawing 0.15 amp, with a 120-volt line,

$$C = \frac{2,650}{\sqrt{120^2 - 25.2^2}}$$

= 3.4 μ f approx.

Where the line is 50 cycles, substitute 3,180 for the 2,650 above the line in the equation; for 25 cycles, use 6,360. The answer in each case will be in microfarads.

OTTO VON GURICKE,
Wiesen, Switzerland

CORRECTIONS

In the diagram of the Six-Tube Dry-Cell Superhet, page 51 of the August, 1948, issue of this magazine, the tuning condensers of the r.f. and mixer stages are shown connected to the a.v.c. line through 220,000-ohm decoupling resistors. The rotors of the condensers should be grounded to the chassis and the bottom ends of the secondary coils connected to the a.v.c. decoupling resistors. Connections between the resistors and coils should be bypassed to ground with .01- μ f condensers.

Start Full or Spare Time Business at Home

METALIZE BABY SHOES for BIG STEADY PROFITS

No waiting. Cash can start coming in very first day. Money making WARNER SUCCESS PLAN shows every step. Learn quickly, easily without previous training or experience. Plan backed by old established company. Your home is your headquarters. This is too good to pass up since facts cost nothing — now or ever. Don't wait. Send name and address on postcard today to Ray Brandell, Mgr. **WARNER ELECTRIC CO.** 1512 Jarvis Avenue, Dept. 2211, Chicago 26, Illinois

FREE OFFER of COMPLETE Money Making Success Plan We show you how to start—how to get orders rolling in... how to do the work; how to pyramid your profits. **Send No Money** Just your name and address on Postcard.

TELEVISION ASSEMBLY PROJECTION TELEVISION

520 Sq. Inches . . . 20x26" Screen
BY TELEVISION ASSEMBLY COMPANY
Complete with All Parts Hood and Rack

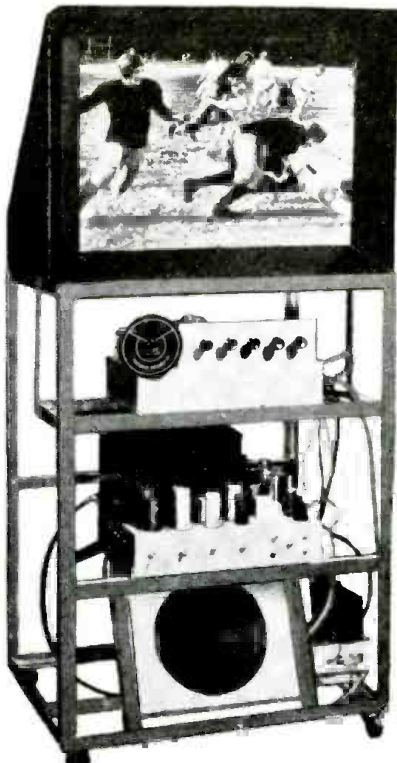

- 37 R.C.A. TUBES
- DUMONT INPUTNER
- 12" P.M. SPEAKER
- Pre-wired & Pre-tuned
- Picture I.F. & Sound I.F.
- Pre-wired 30 KV Tripler Fly Back Power Supply
- Eastman Kodak Projection Screen
- Aluminum Coated Top Mirror
- Bausch & Lomb f:1.9 Projection Lens
- EXPRESSLY DESIGNED Metal Rack, Hood and Picture Frame

For realism, clarity, definition and **BIG SCREEN** Televiewing, the pictures produced by this unit have no equal!

This screen is absolutely flat, precluding curvature distortion anywhere in the picture. Picture tones are true black, grey and white—high in brilliance, yet absolutely glare-free!

MANUAL OF INSTRUCTIONS AND SCHEMATIC DATA

Prepared and Edited by **JOHN F. RIDER PUBLISHER, INC.**

AUTOMATIC GAIN CONTROL

YOUR LOCAL NATIONAL PARTS DISTRIBUTOR



PHONE Lombard 3-9225

509 ARCH ST., PHILA., PENN.

ONLY THE FINEST STANDARD BRAND COMPONENTS USED THROUGHOUT

Send us your name to receive **FREE** Almo Broadcaster magazine.

BRAND NEW SURPLUS! GUARANTEED! 3/4 RPM, HI-TORQUE ELECTRIC MOTOR



\$2.85

Plus 40c Postage and Handling

- Operates on 110V AC, 60-cycles. (Requires only 12 MFD condenser.)
 - Reversible. No Free Swing. Quiet.
 - With Full Instructions.
 - FOR ROTATING HAM. FM. TELEVISION ANTENNAS AND MANY OTHER USES.
- BARGAIN RADIO, Dept. BR-1**
249 N. Juanita Los Angeles 4, California



FAMOUS WAR SURPLUS AIRCRAFT FLASH UNIT

PURCHASED DIRECT FROM U.S. GOVERNMENT. All amateurs and professionals should have it. The Power Supply and 4 high speed Edgerton Flash Tubes. Plastic Sealed, Unbreakable; Light output 110 Watt sec. 2 Condensers, total 50 mfd. made to be used with batteries, but we furnish without extra charge all necessary parts, Reflectors, Connectors, Cords, Spares and Transformer with Diagrams and Instructions to CONVERT to 110 Volt A.C.; you can use battery or power with a flick of the switch.

\$68.00

BRAND NEW—NEVER BEEN USED All complete
A terrific war surplus bargain while they last
CINEX INC. (Dept. CR) 165 W. 46th St., N.Y. 19, N.Y.

TV INTERFERENCE TO TELEVISION TO GO?

TV interference caused by automobile engines will be reduced in the future, according to a statement made last month by P. J. Kent, chief engineer of the electrical division of the Chrysler

Corporation. Some of the new cars coming off the assembly lines have had changes built into their electrical systems which reduce the interfering radiation. Results are good, he said.

LOW IN PRICE
HIGH IN QUALITY
THE PERFECT GIFT



ELECTRIC PORTABLE PHONOGRAPH

A fine playing electric phonograph in a handsome case. Can be easily carried anywhere. This electric portable phonograph will make a wonderful gift for any music lover or record collector.

Note these features that make this phonograph outstanding:

- Handsome leatherette cover.
- Plays 12" records with cover closed.
- Large 5" Alnico 5 Speaker for excellent tone reproduction.
- 2 Watt Amplifier.
- Rim drive constant speed motor.

List price \$29.95

NET PRICE **\$15.95**

LOTS OF THREE..... **14.95**

TUBES! NATIONALLY ADVERTISED BRANDS TUBES!

RCA — Kenrad — Sylvania — Tung-Sol — National Union — Raytheon — Philco — Hytron
All new tubes. 100% guaranteed. Individually boxed.

TYPE	PRICE	TYPE	PRICE	TYPE	PRICE	TYPE	PRICE	TYPE	PRICE
01A	.45	3Q4	.80	6Q7	.72	6V6GT	.72	7E7	.80
0Z4	.80	3Q5GT	.85	6R7G	.65	6V7G	.96	7F7	.80
1A3	.80	3S4	.72	6S7G	1.15	6W7G	.96	7F8	.96
1A4P	1.40	3R4GY	1.15	6S8GT	.80	6X3GT	.54	7G7	.96
1A5GT	.65	3T4	1.40	6SA7GT	.60	6Y6G	.80	7H7	.96
1A6	1.15	3U4G	.54	6SB7Y	.85	6Y7G	1.15	7I7	.96
1A7GT	.72	3V4G	.85	6SC7	.72	6Z5	1.15	7L7	.80
1B4P	1.40	3X4G	.65	6SD7GT	.65	6Z7G	1.40	7N7	.80
1B5-25S	1.15	3Y3GT	.45	6SF5	.65	6ZY5G	.80	7Q7	.65
1C3GT	.80	3Y4G	.54	6SF7	.72	7A4	.65	7V7	.96
1C6	1.15	3Z3	.65	6SG7	.72	7A5	.65	7W7	.96
1C7G	1.15	3Z4	.96	6SH7 GT	.80	7A6	.65	7X7	.96
1D5GP	1.40	4A3	.96	6S17/GT	.60	7A7	.65	7Y4	.65
1D7G	1.15	4A4 LA	1.15	6S27 GT	.80	7B5	.65	7Z4	.65
1D8GT	1.40	4A6	.96	6SL7GT	.85	7B6	.65	12A	.65
1E3GP	1.40	4A7	.72	6S1V7GT	.80	7B7	.65	12A5	1.15
1E7G	1.40	4A8GT	.72	6S07/GT	.54	7B8	.65	12A6	.96
1F4G	.96	4B7	1.15	6S7	.65	7C4	.96	12A7	.96
1F6G	.96	4C7	.96	6S15G	.72	7C5	.80	12A7GT	.96
1F8	1.40	4D7G	1.15	6U6GT	.65	7C6	.65	12A7GT	.96
1F7	1.40	4E5GT	.80	6U7G	.65	7C7	.65	12A7E	.65
1G4GT	.96	4F6GT	.96	6V6	1.15	7E6	.65	12BA6	.65
1G5G	.96	6AG5	.96					12BA6	.65
1G6GT	.96	6AG7	1.15					12BE6	.65
1H4G	1.15	6AK5	.96					12C8	1.15
1H6GT	.80	6B4G	.96					12F5	.65
1H8G	1.15	6B7	1.15					12H6	.65
1J6G	.96	6B8G	1.15					12J5GT	.65
1L4	.72	6C4	.60					12J7GT	.72
1LA4	.96	6C5 GT	.60					12K8	.85
1LB4	.96	6C6	.72					12Q7	.65
1LC2	.96	6C8G	.96					12SA7GT	.65
1L7G	.96	6D6	.60					12SC7	.80
1LD5	.96	6E5	.80					12SE5	.65
1LH4	.96	6F5GT	.60					12SF7	.72
1LN5	.96	6F6	.72					12SG7	.72
1NEGT	.72	6F6GT	.60					12SH7	.80
1N1G	.65	6F7	1.15					12S17	.65
1O5GT	.96	6F8G	1.15					12SK7 GT	.60
1R4	.96	6G6G	.96					12SL7GT	.85
1R7	.72	6H6 GT	.60					12SN7GT	.80
1S4	.85	6J5 GT	.54					12SQ7GT	.54
1S5	.65	6J6	.96					12SR7	.80
1T4	.72	6J7GT	.72					12S7	.80
1T5GT	.96	6J8G	.96					14A7	.80
1V	.80	6K6GT	.54					14B6	.80
1A3	1.15	6K7	.80					14Q7	.80
2A4G	1.15	6K8	.85					14R7	.80
2A5	.80	6L5G	.96					25L6GT	.60
2A6	.96	6L5GA	1.15					25L6GT	.65
2B7	.96	6L7GT	.96					25Z5	.54
2 2 879	1.15	6N5	.80					25Z6GT	.54
3A4	.72	6N7	.85					26	.65
3B7 1291	.96	6P5	.80					26A7	1.15
3D6/1291	.96	6P7G	1.15					27	.54

SPEAKERS

- 4" PM Speaker **\$1.25**
- 5" PM Speaker **1.25**
- 6" PM Speaker **1.98**

SPECIAL! VOLUME CONTROL

1/2 meg with switch. 3 for **99c**

TERMS: 25% with Order—
Balance C.O.D.—F.O.B. Chicago
Prices Subject to Change
Without Notice
Minimum Order \$2.00

FRANKLIN-ELLIS CO. 1313 West Randolph Street
Dept. RC-II Chicago 7, Illinois

SHOOTS TROUBLE FASTER!
MAKES MORE MONEY FOR YOU ON THE JOB OR AT SERVICE BENCH



PRICE \$9.95

at distributor or post-paid direct.

Sorry, no COD's. Ohioans add 3% State Sales Tax.

Signalette
MULTI-FREQUENCY GENERATOR

In radio service work, time means money. Locate trouble faster, handle a much greater volume of work with the SIGNALLETTE. As a trouble shooting tool, SIGNALLETTE has no equal. Merely plug in any 110 V. AC-DC line, start at speaker end of circuit and trace back, stage by stage, listening in set's speaker. Generates RF, IF and AUDIO Frequencies, 2500 cycles to 20 Megacycles. Also used for checks on Sensitivity, Gain, Peaking, Shielding, Tube testing. Wt. 13 oz. Fits pocket or tool kit. See at your dist. or order direct.

Clippard INSTRUMENT LABORATORY, INC.
DEPT. C, 1125 BANK STREET
CINCINNATI 14, OHIO
Qualified jobbers write wire for details.

NEW G.E. WATTHOUR METER
(Continued from page 85)

effect, a push on one side of the disc without a correspondingly great pull on the other. This tends to thrust the entire shaft to one side or the other. Side-thrust will also occur if the two concentric magnets in the bearing system are not perfectly aligned.

Stainless steel guide pins are fastened to the inside of the fixed cavity to keep the moving system in line. These extend down into the rotating cylinder through a graphite washer. Any displacement caused by side-thrust would make the guide pin touch the washer. Placement of the damping magnets has been arranged so that there is minimum side thrust.

Since 1941 the magnetic suspension has been on accelerated-life tests, showing excellent stability during tests equivalent to 65 years of ordinary operation.

CORRECTION

The line cord resistor of the dual test instrument, page 40 of the March, 1948, issue, is shown as 300 ohms. The correct value for the tube shown is 550 ohms. If a dropping resistor is used, it should have a rating of 20 watts or more.

We thank Mr. David Gnessin of Columbus, Ohio, for this correction.

SOUND EQUIPMENT, SOUND VALUES IN RADIONIC'S FREE CATALOG

SENSATIONAL TUBE OFFER!
TUBES Made by famous manufacturer. Brand new tubes! No surplus! Every tube individually tested and carries standard RMA guarantee. Your money back if any tube fails to give complete satisfaction.

- 1R5 6SK7GT 12SQ7GT
- 1S5 6SQ7GT 35L6GT
- 1T4 6V6GT 35W4
- 354 6X5GT 35Z5GT
- 6AT6 12B7G 50B5
- 6BA6 12BA6 50L6GT
- 6BE6 12B26 6SA7GT
- 6K5GT 12SA7GT 36c
- 6K6GT 12SJ7GT
- 6SJ7GT 12SK7GT each

- CONDENSERS**
- Brand New Stock! (No Government Surplus)
- FAMOUS MAKE
- ELECTROLYTIC (Tubulars)
- 25 mfd @ 25v 30c
- 20 20 mfd @ 150v 45c
- 50 30 mfd @ 150v 55c
- 8 mfd @ 450v 35c
- 12 mfd @ 450v 40c
- 16 mfd @ 450v 50c
- 8 8 mfd @ 450v 55c
- PAPER (Tubulars)
- .1 mfd @ 600v 15c
- .05 mfd @ 600v 13c
- .01 mfd @ 600v 12c
- .005 mfd @ 600v 9c

STORE OPEN DAILY 9 to 6—SATURDAY 9 to 5
Minimum order \$3.00. 20% deposit. Bal. C.O.D.

RADIONIC EQUIPMENT COMPANY
170 NASSAU ST., NEW YORK 7, N.Y.
Tribune Theatre Entrance
Tel. WOrth 2-0421 • Cable "CHANSIOR"

MAIL TODAY!

RADIONIC EQUIPMENT CO., Dept. 1011
170 Nassau Street, New York 7, N. Y.

Send at once your free catalog, supplements and bargain lists as published—listing products of leading manufacturers of radio-electronic parts and equipment.

NAME

P.O. BOX or STREET

TOWN STATE.....



Fig. 1—A mock-up of the suspension system.

NEW G-E WATTHOUR METER

THE watthour meters used by electric power companies, to measure consumption have been developed to the point where maintenance needs are very small. However, since the rotating disc rests on bearings, friction eventually makes it necessary to replace the jeweled bearing. A new meter developed by the General Electric Company eliminates bearing friction by using magnetic suspension.

Fig. 1 shows the rotating disc and the magnetic-suspension system. The concentric outer and inner cylinders are magnetized axially, with opposite polarity, so that the resulting magnetic field supports the inner magnet with a slight downward displacement, which can be seen in the photograph. Thus the inner member hangs freely in air—a bearing truly without friction.

Fig. 2 is a detailed view of the upper cylinder and a cavity. The magnets are made of cunco, a highly coercive and easily machined material.

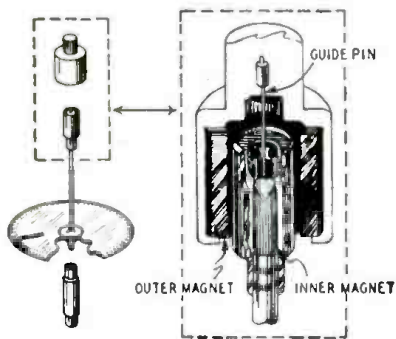
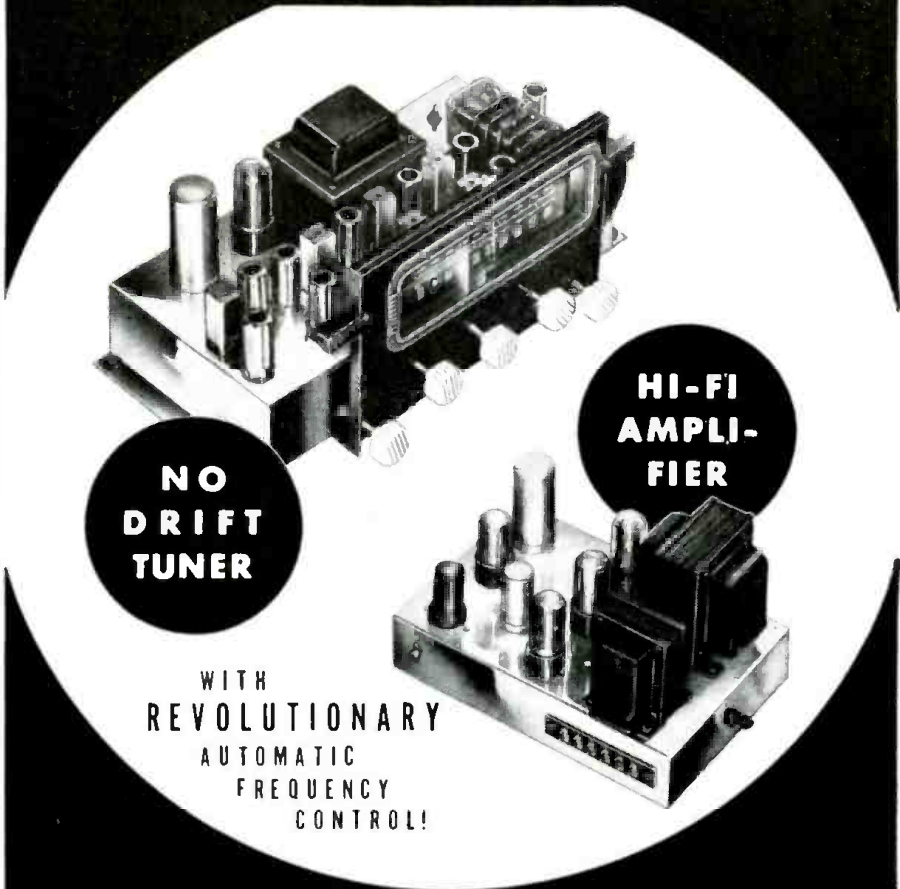

Fig. 2—The shaft is suspended by magnets.

In the usual jewelled bearing, most of the weight of the rotating disc is supported by the lower bearing. The stress is on the order of 100 tons per square inch. With the new magnetic bearings, this pressure is eliminated.

There are, however, side-thrust forces that can cause wear. These are caused by the rotation of the disc and by the damping magnet, which is a part of the electrical metering system. When the disc is made to rotate as power is drawn through the meter, there is, in

FOR FINER FM-AM RECEPTION
 THIS TUNER-AMPLIFIER COMBINATION



FM-AM TUNER RC-8 Features automatic-frequency control, most revolutionary development in FM design—entirely eliminates drift and multiple tuning responses. Nine shielded miniature tubes plus rectifier include double limiter and tuned RF stage in both FM and AM. Low-impedance loop, enabling flexibility in mounting, provides low-noise AM reception. Rear socket provides easy access to 6.3-volt AC and exceptionally well-filtered 100-volt DC for supplying external pre-amplifiers, additional pilot lights, etc. Controls include separate hass, treble and switch positions for phonograph and television

audio inputs. Polished chrome chassis. Audio cable, escutcheon, decals, antennae, and detailed installation instructions furnished.

HI-FIDELITY AMPLIFIER RC-2 High impedance input; 12 watts output at 1% distortion. Taps: 4, 6, 8, 15, 500 ohms. 65 db gain, including inverse feedback. Uniform frequency response from 20 to 20,000 cycles up to 8 watts output. Hum 65 db below rated output. Tubes: 6J5, 6SN7, (2) 6V6, 5Y3. Durable polished chrome chassis.

Write for Descriptive Circular "D" and Prices.

The RADIO CRAFTSMEN, Inc.
 1341 S. MICHIGAN AVENUE, CHICAGO 5, ILL.

HOW TO GET THE MOST
 from only
BASIC TEST EQUIPMENT

Servicing by Signal Substitution
 The Simple, Modern, Dynamic Speed approach to receiver alignment and adjustment problems, FM-AM-TV.

- Nothing complex to learn
- No extra equipment to purchase
- Universal — non-obsolete
- Employs only Basic Test Equipment



S-S-S tells HOW — in simple, direct language.

New 9th edition now off the press. 100 pages of valuable information.

Available from all leading radio parts and equipment distributors or directly from factory at only 40c per copy.

A CHALLENGE — Order a model 247. Disregard the unbelievably low price and compare it on the basis of appearance, quality and performance to any other Tube Tester (ANY MAKE. ANY PRICE). If you are not completely satisfied with the model 247 after a 15 day trial, return it to us for full refund—no explanation necessary. The model 247 is not surplus nor is it a hushed over pre-war model. It is newly designed and incorporates new advances in Tube Tester design. Read the description below and order one today!

THE NEW MODEL 247

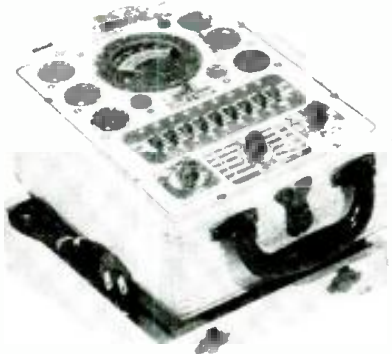

TUBE TESTER

Checks octals, loctals, bantam jr. peanuts, television miniatures, magic eye, hearing aids, thyratrons, the new type H.F. miniatures, etc.

Features:

- * A newly designed element selector switch reduces the possibility of obsolescence to an absolute minimum.
- * When checking Diode, Triode and Pentode sections of multi-purpose tubes, sections can be tested individually. A special isolating circuit allows each section to be tested as if it were in a separate envelope.

- * The Model 247 provides a super sensitive method of checking for shorts and leakages up to 5 Megohms between any and all of the terminals.
- * One of the most important improvements, we believe, is the fact that the 4 position fast-action snap switches are all numbered in exact accordance with the standard R.M.A. numbering system. Thus, if the element terminating in pin No. 7 of a tube is under test, button No. 7 is used for that test.

Model 247 comes complete with new speed-read chart. Comes housed in handsome, hand-rubbed oak cabinet slotted for bench use. A slip-on portable hinged cover is included for outside use. Size: 10 1/4" x 8 3/4" x 5 3/4".

20% Deposit Required on All C.O.D. Orders

ONLY \$29⁹⁰ NET

MOSS ELECTRONIC DISTRIBUTING CO. DEPT. RC-11, 229 FULTON ST. NEW YORK 7, N. Y.

Radio Thirty-Five Years Ago

In Gernsback Publications

HUGO GERNSBACK

Founder

Modern Electrics	1908
Electrical Experimenter	1913
Radio News	1919
Science & Invention	1920
Radio-Craft	1929
Short-Wave Craft	1930
Wireless Association of America	1908

Some of the larger libraries in the country still have copies of ELECTRICAL EXPERIMENTER on file for interested readers.

In ELECTRICAL EXPERIMENTER November, 1914

- A Simply Made Loading Coil by Stuart Sandreuter
- Crystal Detectors and Electrothermal Action by Dr. W. H. Eccles
- Making a Hot-Wire Ammeter
- Electrolytic Interrupters and how to use them by H. Winfield Secor
- U. S. Wireless Truck has 800-Mile Range
- Wireless on Delivery Vans

ELECTRONIC LITERATURE

Any or all of these catalogs, bulletins, and periodicals are available to you if you write to us on your letterhead (do not use postcards) and request them by number. It is necessary to send only the number of the item you want. We will forward the request to the manufacturers, who in turn will send the literature directly to you. This offer void after six months.

11-1—FM AND ANTENNA DATA

A 16-page booklet of information on the Model 300 and Model 400 television-FM antennas, issued by Tricraft Products Company. Illustrated with drawings, directivity patterns and performance charts on these antennas. Of interest to owners of FM and television sets.—*Gratis*

11-2—TRANSFORMER CATALOG

Catalog No. 4811, issued by Merit Coil and Transformer Corp., lists specifications and prices of transformers and chokes for replacement, amateur and electronic application.—*Gratis*

11-3—PLASTICS BULLETIN

Bulletin No. CDP-578 describes and illustrates the design, moldmaking and molding facilities of the Chemical Department of General Electric. It lists applications and general properties of such materials as mycalex, silicone and other plastic materials.—*Gratis to interested parties*

11-4—WALSCO CATALOG

This 15-page catalog lists hardware, tools, chemicals and finishing materials, made by Walter L. Schott Co., for use in assembling and servicing radio and electronic equipment.—*Gratis*

E.M.C.

Gives More Value per Dollar Measurement

E.M.C. MODEL 300

Vacuum Tube Volt-Ohm Capacity Meter

- DC VOLTS—6 ranges to 1000 volts.
- AC VOLTS—5 ranges to 1000 volts.
- RESISTANCE—6 ranges to 1000 megohms.
- CAPACITY—4 ranges (.000025 mfd to 20 mfd)
- HAS ZERO CENTER POSITION

Model 300, as illustrated **\$39.50** with leads

(other models also available)

See the Model 300 at your Jobber

WRITE TODAY to Dept. B-9, for NEW, FREE CATALOG



ELECTRONIC MEASUREMENTS CORPORATION

423 Broome St., New York 13, N. Y.

SMOOTH FM TV VHF SERVICING

This VHF ALIGNMENT WAND gives a constant check on the alignment of FM TV & other 5-500 mc equipment during servicing. Its blending of repair and alignment makes servicing smooth and fast. Solves your TRACKING, SENSITIVITY & S/N problems. Tells which adjustment to make, which way and how much. A modern shop MUST!

HAWKINS RADIO COMPANY
621 East 31st Street Kansas City 3, Mo.

\$3.00 FOR CARTOON IDEAS

RADIO-CRAFT prints several radio cartoons every month. Readers are invited to contribute humorous radio ideas which can be used in cartoon form. It is not necessary that you draw a sketch, unless you wish.

All checks are payable on publication.
RADIO CARTOONS, RADIO-ELECTRONICS
25 West Broadway, New York 7, N. Y.

former mutually repel each other. Hence the appearing divergency in a stream of electrified effluvia.

"But though the particles of electrical matter do repel each other, they are strongly attracted by all other matter. . . .

"Thus common matter is a kind of sponge to the electrical fluid.

"But in common matter there is (generally) as much of the electrical as it will contain within its substance. If more is added, it lies without upon the surface, and forms what we call an electrical atmosphere, and then the body is said to be electrified."

Dr. Millikan says, "The opening sentence contains the simple statement of an epoch-making discovery: 'The electrical matter consists of particles . . .'. After 200 years of research we cannot improve the content of Franklin's conclusion. Its obvious, axiomatic truth may stand forever, but perhaps at the end of another 200 years additional truths may give it a different aspect."

"SAUNDERCISMS"

Epigrams from a lecture on television delivered by Albert C. W. Saunders to the Associated Radio Servicemen of New York (City) at their meeting June 9, 1948.

"A serviceman's work consists of nine mental operations to every manual one." "Don't be too technical with the public—your customer doesn't care whether the dielectric has any specific inductive capacitance or not." "Amplification itself is cheap—it's broad-band amplification that costs money."

"Electricity is the fastest thing in the world—but it's the laziest."

CORRECTIONS

Data on the old Philco bakelite-cased bypass condensers is found on page 14 of Volume II (2) of Rider's *Manual* instead of Volume 11 as reported in the Technote, Philco Condensers, on page 72 of the July issue.

We thank Mr. John Wohlrab of Buffalo, N. Y., for calling our attention to this error.

There is an error in the diagram of the Wobulated Signal Generator on page 34 of the May 1948 issue. The plate of the 6J5 cathode follower is shown connected to ground. This should be connected to the B-plus line running from the No. 4 pin of the power input socket.

We thank Mr. Thomas B. Brook of Twin Bridges, Montana, for this correction.

DE FOREST BANQUET

Dr. Lee de Forest, Father of Radio, was tendered a special banquet at the Chicago Railroad Fair on his 75th birthday. It was spread jointly by the Morse Telegraphers Club of America and American Television Inc. The banquet was only one of a number of celebrations which marked the great inventor's birthday, the high light of them all being Dr. de Forest's coast-to-coast broadcast on the Mutual Broadcasting System network.

**BUILD THE NEW
MODEL TV-67 ALL CHANNEL
TELEVISION BOOSTER**

FOR YOUR OWN USE OR FOR RESALE

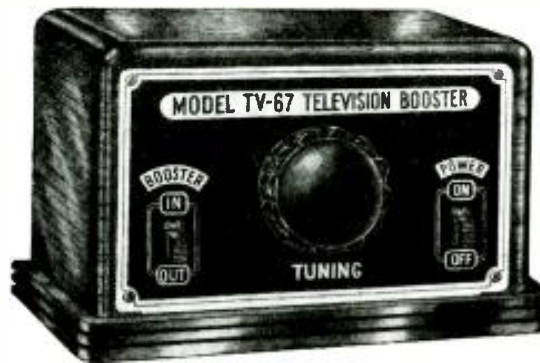

With the aid of our TV-67
INDUCTOR TUNER
Illustrated below.

only **\$3.50**

INDUCTOR TUNER comes complete with circuit and instructions for building the TV-67 TELEVISION BOOSTER. We will also include at no charge basic circuits utilizing the TV-67 INDUCTOR TUNER to build a Television and F.M. Signal Generator, a Television Interference Eliminator and front end for Television Receiver.

No need for switching when using the TV-67

INDUCTOR TUNER

Designed to Cover All Channels 2 to 13 Inclusive.

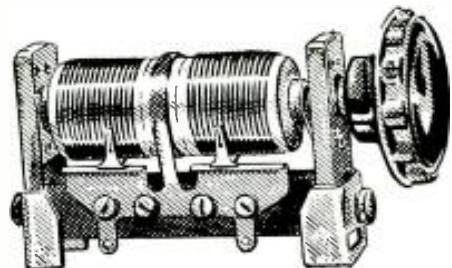

TV-67 Booster Features :

- ★ Permits use of Indoor Installations.
- ★ Reduces or eliminates interference including Amateur, F.M., Short Wave and Inter-Channel.
- ★ Permits TV reception in fringe areas.
- ★ Amplifies weak signals.
- ★ Provides brighter and clearer images.

Specifications:

- ★ The Model TV-67 employs 1-6AK5 as a high gain amplifier; 1-6C4 as an isolation amplifier and 1-6C4 as rectifier. Use of these highly efficient miniature tubes in conjunction with INDUCTOR TUNER results in maximum gain on all channels up to channel 13.
- ★ The Model TV-67 provides a 6 megacycle band-width reducing Video detail loss to absolute minimum.
- ★ The Model TV-67 is designed to operate with any antenna system indoor or outdoor—any impedance.
- ★ New INDUCTOR TUNER covers all television channels, 2 to 13, inclusive without switching.

INDUCTOR TUNER comes complete with circuit and instructions for building the TV-67 Television Booster. We will also include basic circuits utilizing the TV-67 INDUCTOR TUNER to build a Television and F.M. Signal Generator, a Television Interference Eliminator and front end for Television Receiver.

only **\$3.50**

GENERAL ELECTRONIC DISTRIBUTING CO.

98 PARK PLACE

NEW YORK 7, N. Y.

DEPT. RC-11

R-E CELEBRATES BIRTHDAY

SIGNAL GENERATOR

MODEL 300



The Model 300 Signal Generator features finger-tip selection of four accurately aligned frequencies. Special crystal position accommodates any standard crystal to adapt the model 300 to a crystal free standard or TELEVISION MARKER OSCILLATOR. Four Hummed cycle audio modulation, in or out. Supplies 456 Kc, 465 Kc, 600 Kc, and 1500 Kc, to cover 90% of all receivers manufactured. Works equally well with AC-DC sets. Complete with tubes, and output probe. Nothing else to buy. Model 300 \$16.95 Net Model 300-K Complete Kit & Instructions 14.95

"RANGE MASTER"

MODEL 10



The 9-in-1 Service Instrument Covers these 28 ranges—

- (1) CAPACITY .001-1 .01-1 .1-10 Mfd.
 - (2) A.C. CURRENT 0-150, 0-1.5, 0-15 amps.
 - (3) A.C. VOLTAGE 1 to 100 500 1000 volts.
 - (4) D.C. VOLTAGE 10 100 500 1000 volts.
 - (5) D.C. CURRENT 1 to 100 1000 milliamps.
 - (6) RESISTANCE 0 to 10,000 100,000 1 megohm.
 - (7) Shorter High range ohmmeter to 0-250 Megs.
 - (8) Sensitive A.C. microammeter to 1100 microamps.
 - (9) OSCILLOSCOPE CALIBRATOR 1-10-100 metered RMS Volts from A.C. line.
- Model 10-P Portable (Illustrated) \$26.95 Net
 Model 10-F Fused 28.15 Net
 Model 10 Bench 23.50 Net
 Model 10-K Complete Kit & Instructions 17.95 Net
 Test Leads85

"MULTI-TESTER"

MODEL 30



A.C. Volts 0-12.5/25/125/250/1250 V.
 D.C. Volts 0-5/10/50 100/500/1000 V.
 D.C. Current 0-1/100 MA.
 Resistance 0-10,000/100,000-1 Meg. Ohms.
 Decibels—From minus 19 to plus 57 dB.
 Model 30 (Illustrated) \$15.95 Net
 Model 30-K, Comp. Kit 13.95 Net
BARGAIN PACKAGE: One Signal Generator Model 300-K and one Multi-Tester Model 30-K, complete with probe, test leads and battery. A complete service shop in kit form. Nothing else to buy. Only \$26.50 Net. Prices 5% higher west of the Rockies.
 Write for Free Catalog
 See your local distributor. If not available, write to Dept. R. C.



348 LIVINGSTON STREET
 BROOKLYN 17, N. Y.

Headphone BARGAINS

Type H523—8000 ohm impedance, highly sensitive. . . . lightweight only 9 oz. Leather covered spring steel adjustable headband. 12" cord with PL54 plug attached at side out of way. Jack and rubber cord supplied to extend length to 5 1/2 feet. Removable rubber ear cushions. Brand New—\$13.50 Value.
 Stk. No. 17A37
SPECIAL PER PAIR \$2.45



Type H530—8000 ohm impedance. Small yet highly sensitive. Built on hearing aid principle with ear fitting soft rubber cushions attached to receivers. . . . shut out outside noise. Comfortable, light metal band easily shapes to contour of head. Supplied complete as illustrated with 6 foot cord and PL55 plug, shirt clip and matching transformer for 8000 ohm impedance. Very popular for conversion to mikes, telephone sets, miniature crystal sets and all around headphone use. Brand New.. A Terrific Value!
 No. 17A420X. **\$1.29**
 Per Pair.....

5BP4 CATHODE RAY TUBE \$2.95

Has 5" white screen. Quality make individually boxed in cushioned carton. Brand New, Perfect, Guaranteed. No. 36T206. **\$2.95**
SPECIAL EACH.

ORDER NOW from this ad—include postage.

FREE—the big NEW B-A Catalog No. 491. 132 pages of Outstanding Values. Write if you have not received it.



BURSTEIN-APPELBEE
 1012-14 MCGEE STREET, Company
 KANSAS CITY 6, MISSOURI

WE'VE MOVED

More Space—Better Service

3 TUBE PHONO AMPLIFIER

\$1.95

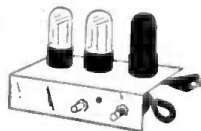

COMPLETELY WIRED, VOLUME AND TONE CONTROLS

- Set of 3 tubes: 50L6, 35Z5, 12A6 \$1.10
- Output trans. 50L635
- 1/2 Meg. vol. control with sw.35
- 1" pm speaker95
- 5" pm speaker 1.15
- 6" pm speaker 1.55
- 6x4" pm speaker 1.39
- 8" pm speaker 2.49
- Webster pickups 1.79
- Astatic Cartridges L-70A, L-26A 1.49
- Alliance motor & Turntable 2.50
- VM \pm 400 INTERMIX CHANGER 21.95
- G.E. Reluctance Cartridge 4.54
- Phono Pre-Amplifier complete with tubes 4.95
- Phono Oscillator complete with tubes 4.52
- Oscillator Coil, 12SA715

All prices F.O.B. N.Y.C.—on C.D.D. 25% Deposit. Write for free catalog.

THE ROSE COMPANY

98 Park Place, Dept. C, New York 7, N. Y.

WANTED RADIO SERVICE MEN

Experienced men with cars for part-time work on AC-DC receivers. Some traveling required. Must be bondable. Pleasant work with good compensation. Need men in or near Davenport, Iowa, Chicago, Indianapolis, Buffalo, Rochester, N. Y., Pittsburgh, Philadelphia, Washington, D. C., Baltimore, Md., and Boston, Mass.

Address box number 02
 c/o Radio-Electronics
 25 W. Broadway New York 7, N. Y.



Hugo Gernsback, founder, editor, and publisher of RADIO-ELECTRONICS, celebrates the start of the magazine's twentieth year of publication by making the first cut in a cake especially baked for the occasion and presented to him by the editorial staff. Titled RADIO-CRAFT for 19 years, the magazine enters upon its twentieth year as RADIO-ELECTRONICS. Old policy of service to all radiomen continues.

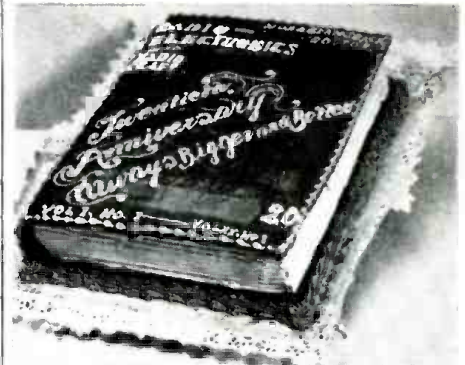

FRANKLIN DISCOVERED ELECTRON

The actual discovery of the electron was made in the United States by Benjamin Franklin 200 years ago, even though it is usually attributed to the English scientist, J. J. Thomson, a little more than 50 years ago.

Attention is called to the fact of Franklin's prior discovery by Dr. Robert A. Millikan, president of the California Institute of Technology, who was the first to isolate a single electron and make extremely accurate measurements of its properties.

In support of his claim that Franklin should be considered the discoverer of the electron, Dr. Millikan, in a communication to *The American Journal of Physics*, cites Franklin's letter to Peter Collinson.

"The electrical matter," Franklin wrote, "consists of particles extremely subtle, since it can permeate common matter, even the densest metals, with such ease and freedom as not to receive any perceptible resistance. . . ."

"Electrical matter differs from common matter in this, that the parts of the latter mutually attract, those of the

2-METER TRANSCEIVER

Please print a circuit for a very compact 144-mc transceiver.—F.M.S., Mars Hill, Me.

A. The simple circuit shown in the diagram can be constructed in a small case. The 3A4 is used for both transmitting and receiving. Note that its filaments

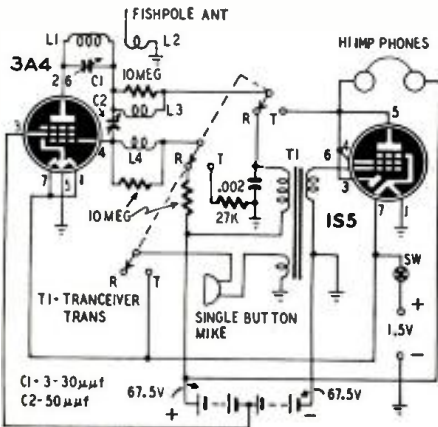

are paralleled for 1.5-volt operation. The 1S5 is modulator and audio tube.

Be sure to keep all wiring as short as possible. Vary the coupling between L1 and L2 for best operation as a super-regenerative receiver. The same coupling is satisfactory for transmission.

The coils are self-supporting and can be wound with No. 16 wire. L1 has five turns, 3/8 inch inside diameter, spaced to occupy 3/8 inch (adjust to cover band). L2 is one turn of the same diameter placed at the end of L1. L3 and L4 are chokes wound with 50 turns of No. 36 wire on 10-megohm resistors.

ELECTRONIC TIMER

Please give me a design for an electronic timer adjustable to a maximum of about 2 minutes.—R. R. K., Vallejo, Calif.

A. The diagram gives the circuit of a timer with a little more than 2 minutes' maximum time. The capacitors connected to the range switch and the 10-megohm potentiometer are the timing

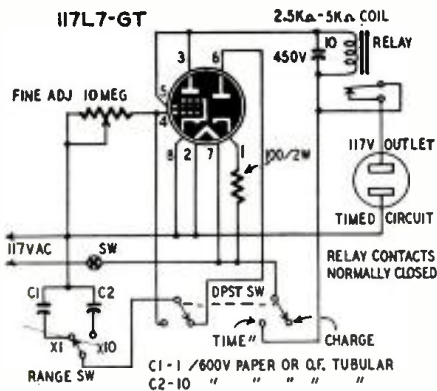

components. The maximum time can be increased somewhat by adding a third position to the range switch, with a 20- to 40-uf paper capacitor.

The control switch normally should be in the CHARGE position. When it is thrown over to TIME, the timing cycle is automatically started and completed.



"Don't Get Your Fingers Burnt"...
Says Speedy

Use the **NEW**

G-C Amo Miniature TUBE PULLER

"Prevents Tube Breakage and Burned Fingers"

It's easy to remove or insert miniature tubes with the new G-C Amo Miniature Tube Puller. Inserts or extracts tubes where fingers will not reach—into hard-to-reach places. Saves time and money.

No. 5093 Miniature puller . . . Net 99c

Write for catalog, Dept. D, or see your distributor.
(DISTRIBUTORS: WRITE FOR DETAILS)

Manufactured by

GENERAL CEMENT MFG. CO.

ROCKFORD, ILLINOIS, U.S.A.

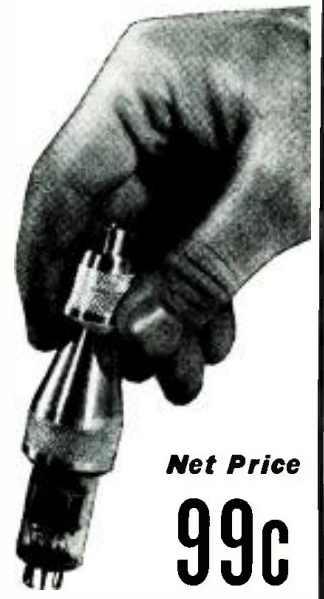

Net Price

99c

each

EVERY SERVICEMAN CAN afford SUPERIOR TEST EQUIPMENT

The New Model 670



SUPER METER

A Combination VOLT-OHM-MILLIAMMETER plus CAPACITY REACTANCE, INDUCTANCE and DECIBEL MEASUREMENTS

D.C. VOLTS: 0 to 7.5 15/75/150/750/1500/7500. A.C. VOLTS: 0 to 15/30/150/300/1500/3000 Volts. OUTPUT VOLTS: 0 to 15/30/150/300/1500/3000. D.C. CURRENT: 0 to 1.5 15/150 Ma.; 0 to 1.5 Amps. RESISTANCE: 0 to 500/100,000 ohms, 0 to 10 Megohms. CAPACITY: .001 to .2 Mfd., .1 to 1 Mfd. (Quality test for electrolytics). REACTANCE: 700 to 27,000 Ohms; 13,000 Ohms to 3 Megohms. INDUCTANCE: 1.75 to 70 Henries; 35 to 8,000 Henries. DECIBELS: -10 to +18, +10, to +38, +30 to +58.

The model 670 comes housed in a rugged, crackle-finished steel cabinet complete with test leads and operating instructions. Size 5 1/2" x 7 1/2" x 3".

\$28.40 NET

We manufacture a complete line of radio test equipment. Write Dept. RC for FREE catalog today!

MFD. BY



SUPERIOR INSTRUMENT CO.

227 Fulton St., New York 7, N. Y.

at your regular jobber

JUST PUBLISHED!

FREQUENCY MODULATION

FUNDAMENTALS • APPARATUS SERVICING



BY NATHAN MARCHAND
Radio and Electrical Consultant, Lecturer on Electrical Engineering, Columbia University, 448 pages, 6x9, over 300 illustrations, \$5.00

A modern guide to one of radio's fastest-growing developments

SIMPLIFIES SERVICE — ENGINEERING PROBLEMS!

It takes more than ordinary radio servicing knowledge to handle the complicated special problems and methods of modern F.M. work. This new book by a well known radio and electrical consultant has been specifically written, first to help you understand F.M. clearly and second, to explain fully just how to get about handling F.M. work. With a minimum of mathematics, but with a copious use of easily understood illustrations, schematic diagrams and practical on-the-job examples, it covers the complete field of frequency modulation, basic theory, circuits, transmitters, receivers and mobile equipment are fully explained—and special emphasis is placed on up-to-the-minute methods of installing, adjusting and repairing F.M. receivers.

Here at your fingertips you have everything necessary for a complete understanding of the subject—from circuit peculiarities, tuning indicators, to antennas, mobile equipment, F.M. test units, receiver alignment, general servicing procedure, and a host of other essential subjects. Particular attention is paid to outlining the important points of difference between FM and ordinary AM work.

HERE'S WHAT IT INCLUDES

1. Fundamentals of Modulation
2. Fidelity of Band Width Requirements
3. Noise and Interference
4. Direct Frequency Modulation
5. Frequency Control Circuits
6. Direct FM Transmitters
7. Phase to Frequency Modulation
8. FM Transmitters Using Phase Modulation
9. FM Detectors
10. Amplitude Limiters
11. RF Amplifiers, Oscillators, and Converters
12. Intermediate Frequency and Audio Circuits
13. FM Receivers
14. FM Transmitting Antennas
15. FM Receiving Antennas
16. Mobile FM Equipment
17. FM Servicing
18. Phasor Calculations, etc.

READ IT AT OUR RISK!

We're so sure you'll want to keep this new FREQUENCY MODULATION book for day to day study and reference, that we'll gladly send it to you for 10 days' examination. Read it carefully. See how quickly it brings you up-to-date on developments in this fast-growing field. Then decide whether or not you want to buy it or return it. We'll take the risk! Send no money. Just mail the coupon now.

10 DAY TRIAL COUPON

Dept. RC-118, Murray Hill Books, Inc.,
232 Madison Ave., New York 16, N. Y.

Send me Marchand's FREQUENCY MODULATION for 10 days' examination on approval. In 10 days I will send \$5, plus a few cents in postage, or return book postpaid. Postage paid on cash orders; same return privilege. (Books sent on approval in U. S. only. Price outside U. S. \$5.50 postpaid.)

Name

Address

City, Zone, State

Occupation

PHOTOELECTRIC CONTROL

My problem requires nine photoelectric circuits wired in parallel and connected to indicator lamps that light when their controlling beams are interrupted. The indicators must remain on for 10 to 15 seconds. The light beams are interrupted for about .0005 second. Will you prepare a diagram of one of the control circuits?—J.W., Alameda, Calif.

supply. An adjustable pulse-lengthening circuit, R1-C1, assures relay operation with very short interruptions of the beams.

When the slider of R1 is at A, full effects of the lengthening circuit are had; at B the effect is cut out. Capacitor C2 controls the length of time the indicator is on. Its value may depend on the tension of the relay spring. Experiment with the value of R2 for best results. A 1:1 line isolation transformer may be used if desired.

A. The circuit shows one of the controlling circuits and a common power

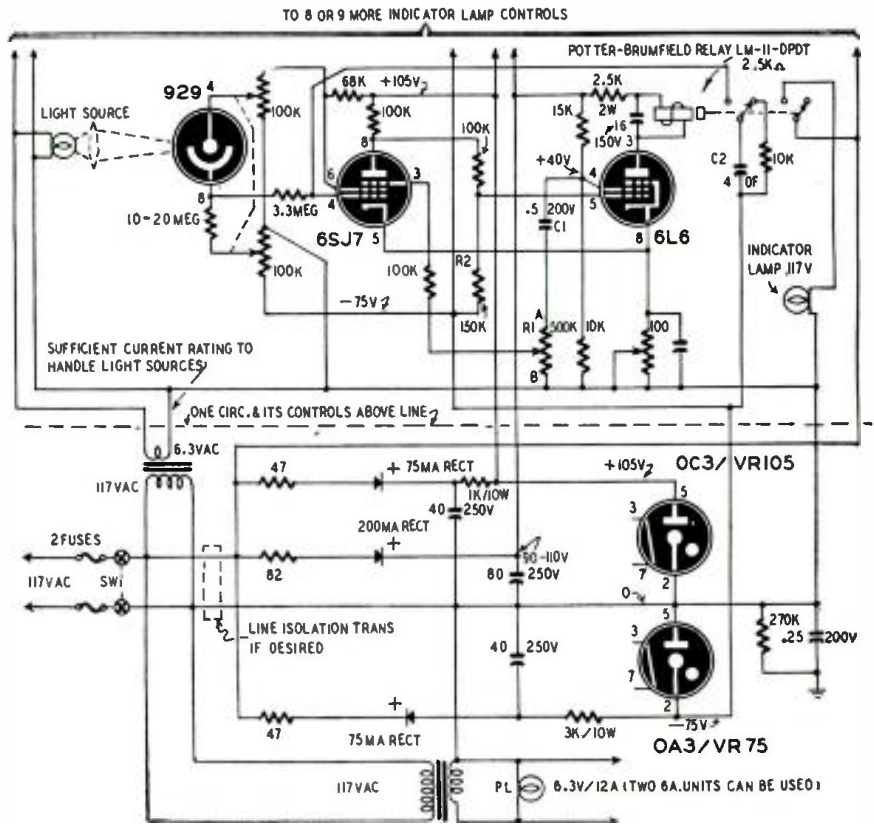

RADIATION MEASUREMENT

I need a loop antenna with a pickup about one-half the signal field strength in microvolts per meter. I want to measure radiation on 600 kc from wired wireless systems to make sure it does not exceed 15 microvolts per meter at a distance equal to $\lambda/2\pi$.

known characteristics.—P. O., Chicago, Ill.

My receiver (its input impedance is 300 ohms) is already calibrated in microvolts, so the antenna should have

A. Close-wind 56 turns of either No. 18 or 20 d.c.c. wire on a 34-inch-square frame. The signal pickup will be approximately 7.9 μ v in a field of 15 microvolts per meter. The antenna should be located very close to the receiver to avoid the effects of long leads.

SIGNAL STRENGTH INDICATOR

I have built the signal tracer described on page 8 of the 1946 RADIO-CRAFT Reference Annual. I would like to install an electron-ray tube as a signal-strength indicator. Can you supply me with a diagram?—H. V. Z., Hanford, Calif.

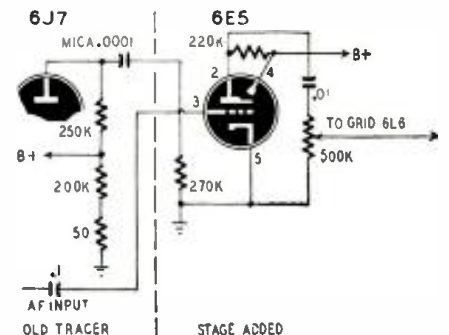

A. The 6E5 shown in the diagram is inserted in the signal-tracer circuit between the audio input and the grid of the output tube. Some gain is added, because the triode in the 6E5 is used as an amplifier.

ANTENNA INSTALLATION

When installing an antenna on the roof of an apartment house, it is often necessary to place insulators on the outer wall of the house to carry the wires down to the window. It is very easy, when leaning over the parapet, to drop the star drill used to make the necessary holes.

To prevent this, tie a length of waxed wire-lacing twine to the star drill. The wax will keep it from slipping. Tie the other end around your belt. Then, if the drill drops, you can just pull it up again with no damage to life, drill, or other property.

LAWSON NORMAN,
Los Angeles, Calif.

CRYSTAL DIODE POLARITY

To find the polarity of a crystal rectifier, measure its resistance with an ordinary ohmmeter. When the test leads are connected for minimum resistance reading, the polarity of the meter's battery voltage indicates the polarity of the crystal.

NORRIS MCKAMEY,
Davenport, Iowa

TV TUBE SUBSTITUTION

Recently I built a television receiver using a 7EP4 picture tube. Not satisfied with the picture because I had to darken the room when viewing, I replaced the 7EP4 with a 7JP4 with very satisfactory results. Since the tube pin arrangements are different for the two kinescopes, the 7JP4 using a 14-pin diheptal socket instead of the 12-pin one needed for the 7EP4, the wiring had to be changed. All voltages were left the same.

The table below shows the wiring changes:

Tube	Pin numbers										
7EP4	1	3	4	6	7	8	9	10	11		
7JP4	1, 2	10	5	7	9	11	8	3	14		

JOHN URBANOWICZ,
Warren, Mich.

DIAL SCALES

To make a precise, commercial-looking black dial scale with transparent white numbers and markings (to be used with back lighting) draw the scale in normal size. Using this as a model, make a copy five to eight times as large with black India ink on smooth white paper (obtaining at an art goods store). Your local photographer can make a high-contrast negative of this large drawing on sheet film, the negative to be the size of the small original.

This negative is the dial scale. The background is black and the lines and numbers are transparent.

G. P. BRUNTON,
Kingston, Ontario

HIGH-VOLTAGE SOURCE

When a cheap source of high voltage at low current is needed for experiments, use a 5- or 10-to-1 audio coupling transformer. Connect the low-turns side to the 117-volt line.

NORRIS MCKAMEY,
Davenport, Iowa

REVOLUTIONARY SOLDERING IRON

TRANSVISION Soldetron

Tr. Mark Reg., Pat. Pend.

For Easier, Better Soldering—on Any Job!

- Weighs only 3 ozs., yet can do the job of a 200 watt iron.
- Heats up in twenty seconds from a cold start; saves time.
- Fingertip control; permits soldering without fatigue.



Ready for attachment and operation on 110 V. A.C., 50-60 cycles, through transformer supplied with iron, or 6.8 volt A.C. or D.C. without transformer (from an automobile battery). Overall size 9 1/4" x 15/16"; ship. wt. approx. 4 lbs.

- Ideal for fine precision work in "hard-to-reach" places.
- Readily interchangeable tip-heads; no cleaning or filing.
- Retains heat with switch off up to 1 minute; efficient.
- * Bakelite handle; cork covering, for comfortable cool grip.

PRICE, including transformer and Tip-Head "A," \$13.95
5% higher west of Mississippi; fair traded.

Ask your distributor, or for further information write to:

TRANSVISION, INC., Dept. RC, NEW ROCHELLE, N. Y.
In Calif.: Transvision of Cal., 8572 Santa Monica Blvd., Hollywood 46

EASY TO LEARN CODE

It is easy to learn or increase speed with an Instructograph Code Teacher. Affords the quickest and most practical method yet developed. For beginners or advanced students. Available tapes from beginner's alphabet to typical messages on all subjects. Speed range 5 to 40 WPM. Always ready—no QRM.



ENDORSED BY THOUSANDS!

The Instructograph Code Teacher literally takes the place of an operator-instructor and enables anyone to learn and master code without further assistance. Thousands of successful operators have "acquired the code" with the Instructograph System. Write today for convenient rental and purchase plans.

INSTRUCTOGRAPH COMPANY

4701 Sheridan Rd., Dept. RC, Chicago 40, Ill.

The HOUSE OF A MILLION RADIO PARTS

- No. 10 Y Tubes 49c
 - No. 1626 Tubes 49c
 - No. 1625 Tubes 49c
 - CRYSTAL PICKUPS
List \$6.50, our price \$1.95
 - McClintock Meters
0-500 MA 3" square \$1.95
- Thousands of other bargains.
Write for our bulletin No. C-912

Lifetime Sound Equipment Co.
911-913 Jefferson Ave., TOLEDO 2, OHIO

RADIOMEN! ELECTRICIANS!

Get this Valuable Book **FREE**

for Merely Examining
Coyné's NEW Pay-Raising

5 VOLUME APPLIED PRACTICAL RADIO SET

Here's a PRACTICAL set of radio books just off the press! Gives you "know how" on everything in Radio today. Basic principles to newest in Television and F.M.—how construct, install, service. Latest trouble-shooting methods. 1000 Illustrations, over 1500 pages. Ideal for reference or home training. To prove how valuable these great books can be to you, Coyné will give you a FREE copy of our new, helpful "150 New Radio Diagrams Explained" for looking over the 5 Vol. Set. OFFER LIMITED—ACT NOW! We will send you 5 vol. set APPLIED PRACTICAL RADIO for 7 days FREE examination, together with Radio Diagrams. Look set over for 7 days. If you like it send \$15 cash, or \$3 after 7 days and \$3 monthly until \$16.75 is paid. If you don't want the set, return it and you owe NOTHING. Either way you keep Diagrams Book Free. SEND NO MONEY! Coupon asks to see books free and get your gift book for doing it! Send coupon NOW!

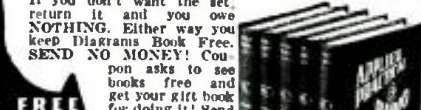

Educational Book Publishing Division
COYNE ELECTRICAL & RADIO SCHOOL, Dept. 88-TI,
500 South Paulina St., Chicago 12, Illinois

OK. Send me, please, Coyné's new 5 volume set, "APPLIED PRACTICAL RADIO" for 7 Days FREE TRIAL per your offer. Also send, absolutely FREE, "150 New Radio Diagrams Explained" as a gift.

NAME.....AGE.....
ADDRESS.....
TOWN.....ZONE.....STATE.....

1. New 7" tube TELEKIT with latest approved circuits. 13 channel factory pre-tuned Tuner. I.F. coils provide maximum gain and picture definition. EASY STEP BY STEP INSTRUCTION BOOK. Specially priced—less tubes \$57.50

- 2. New 10" tube TELEKIT, same as above but using 10" picture tube. Less tubes \$97.50
- 3. Complete TELEKIT TELEVISION RADIO, 23 tubes and five rectifiers. In light bleached or dark Mahogany cabinet. Wonderful performance! Equivalent of the \$50.00 Nationally Advertised Television Set. With 7" TELEV. TUBE. SPECIALLY PRICED \$145.00
- ALLIGATOR PORTABLE CABINET. Each Per 10
For any charger. 17 1/2" x 17 1/2" x 10".
Cut out for 6" speaker 7.95 75.00
- TINY LOOP ANTENNAS for small portable sets. 4" x 6 1/2"29 2.50
- TINY IRON CORE I.F. TRANSFORMERS 456 KC 1/2" x 1/2" x 2".
Pair95 9.00

- SPEAKERS**
- 3" 450 ohm \$1.49 \$14.00
 - 4" PM 1.10 10.00
 - 5" PM with 5016 output transformer. 1.39 13.00
 - 5" 2750 ohm or 450 ohm with 5016 output transformer 1.59 15.00
 - 6" PM VERY SPECIAL 1.39 13.00
 - 8" PM 1000 ohm or 1800 ohm 3.25 30.00
 - 12" PM Utah. 32 oz. Magnet. SPECIAL 5.45 50.00
 - 12" Dynamic 450 ohm field or 1000 ohm 5.65 53.00

- PARTS**
- 500M Chgo. Tel. Vol. Cont. & Sw. 3" shaft39 3.50
 - All other sizes Vol. Cont. & Sw. 3" shaft59 5.50
 - 500M 1 meg and 2 meg tapped Cond. trils69 6.50
 - 40 x 40 Mfd. Natl. Brand Electrolytic Condensers40 3.75
 - 40 x 40 Mfd. Natl. Brand F. P. Condensers39 3.75
 - 40 mil. 2 1/2 volt Power Transformer95 8.00
 - 70 Mil. 2 1/2 Volt Power Transformer 1.75 16.50
 - 70 Mil. 6 Volt Power Transformer 1.95 17.50
 - 60" Auto Aerial 3 Section Side Coil 1.49 14.00
 - 60" Universal Mount 3 Section Auto Aerial 1.75 16.00
 - 5 watt. AC Amplifier with cover using tubes No. 6X5, 6L6, and 6SC7. Less tube 18.95

Write for our new 1948 Illustrated Catalog.

LAKE RADIO SALES CO.
615 W. Randolph Street, Chicago 6, Ill

We're GILDING the LILY!

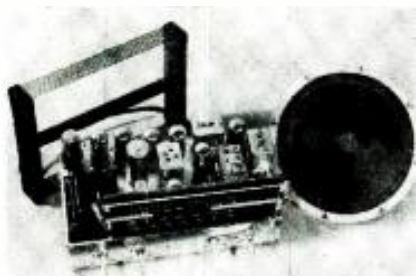

The

NEW, IMPROVED Model 7-B-1, engineered to meet YOUR needs!

Carefully engineered, and manufactured of the finest materials, the ESPEY Model 7-B-1 is specifically designed to meet the most exacting requirements for a replacement chassis, and will lend itself to any type of installation. This model is drift-compensated, AM/FM, with 10 tubes plus rectifier. Supplied complete, ready to operate.

Send to DEPT. C-11 TODAY for
FREE LITERATURE

ESPEY MANUFACTURING COMPANY, Inc.

526 EAST 72ND STREET, NEW YORK 21, N. Y.
"ESTABLISHED - 1928"

HAM RADIO OPERATORS GADGETEERS, etc.



Blower Type FL,
style 1171145B,
Serial No. KO,
115V 400 cycle
6700 RPM. Used
by the army to
cool transmitting
tubes in Radar
sets. Blower ideal for
radio builders, pho-

tography (dark room), etc.
Our price ONLY

\$295

PRICES FOB. KANSAS CITY
Write for new catalog

NATIONAL SURPLUS SALES CO.

723 E. 18th St. Kansas City, Mo.

SOLDERING METAL

It is often difficult to confine solder to a neat, narrow band when making long seams in sheet metal. A method for overcoming the trouble, suggested by A. J. Richards in the British magazine,

2 GREASE CRAYONS BOUND TOGETHER

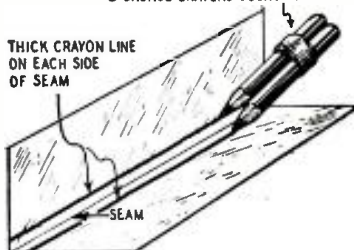

Mechanics, is to use two grease crayons (sometimes sold as "china-marking" pencils).

The crayons are bound together, as the drawing shows, and marks are made on each side of the seam. Because solder will not stick to the grease, there will be no overflow unless an excessive amount of solder is used.

FUSE INDICATOR

Plastic night lights, consisting of a neon lamp embedded in a plastic shell, on sale at hardware and department

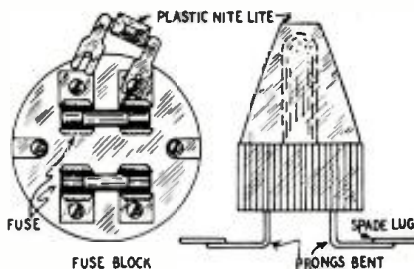

stores, may be used to indicate blown fuses.

Bend the prongs outward, as the sketch shows, and attach spade lugs to the ends. Slip the spade lugs under the fuse block connection screws. When the fuse opens, the current passing through the neon lamp will make it light but will be too small to cause any damage to circuits.

RICHARD L. PARMENTER,
Middleboro, Mass.

NOISE ANTENNA

The 6,600-volt power line passing my house creates a very high noise level in the receiver. I cut down the noise con-

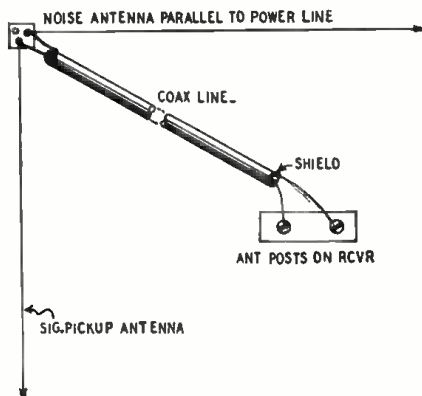

siderably by using the out-of-phase bucking principle.

As the drawing shows, the regular signal-pickup antenna is at right angles to the power line. The noise-pickup antenna, half as long, is parallel to the line. Each antenna is connected to one side of the receiver's antenna coil. The center lead of a co-axial cable is used for the signal antenna, and the shielding for the noise antenna.

The noise picked up by both antennas from the power line is very nearly the same. Since this places both ends of the antenna coil at nearly the same potential (and the same polarity) as far as noise is concerned, the secondary of the coil picks up little noise. Due to the differences in directional orientation and in length, of the two antennas they do not pick up the same radio signals, so signals are not cancelled to a great degree.

250- μ f variable capacitors in series with each incoming lead would help to balance out the noise more effectively, but it was not necessary here.

CHARLES C. COFFIN,
San de Fuca, Wash.

AUDIO TRANSFORMERS

Audio transformers with a 3 to 1 or 3½ to 1 ratio are useful for giving a voltage gain in circuits which originally were R-C-coupled.

The audio sections of some old receivers do not have enough gain to permit a crystal pickup to be used if the usual method of connection is employed. A transformer, hooked up according to the diagram, will increase the effective input to the amplifier.

Where medium- or low- μ triodes in an amplifier do not give enough gain when R-C coupled, two stages can be transformer-coupled. The step-up ratio from primary to secondary will increase

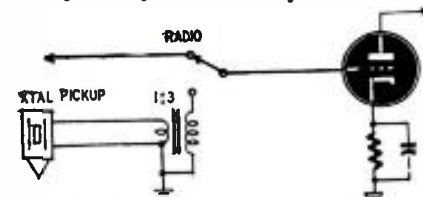

the gain. Other operating conditions, especially the cathode-bias resistor, will have to be changed to accommodate the higher plate current.

G. N. CARTER,
Nanaimo, Canada

(While the transformer will step up volume when used with a crystal pickup, it will almost certainly ruin the frequency response.—Editor)

300-OHM LINE

The 300-ohm ribbon used as transmission line for FM and television antennas is insulated with a plastic material that can be melted easily. To seal and weatherproof a connection to this line, cut a strip of insulation from a similar piece and melt it, allowing the material to drip onto the connection. This plastic catches fire easily, so pick a safe place to do the melting.

ALBERT LOISCH,
Darby, Pa.

RADIOMEN'S HEADQUARTERS ✦ WORLD WIDE MAIL ORDER SERVICE !!

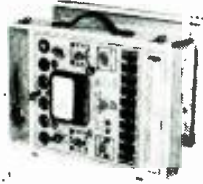

1949 MODEL MUTUAL CONDUCTANCE TUBE TESTER

No possibility of good tubes reading "Bad" or bad tubes reading "Good" as on dynamic conductance testers of other ordinary emission testers. Attractive panel and case equal to any on the market in appearance. Large 1 1/2" meter. Calibrated microhm scale as well as a Bad-Good scale. Front panel fuse. Individual sockets for all tube base types, voltages from 75 volts to 117 volts and complete switching flexibility allow all present and future tubes to be tested regardless of location of elements on the tube base. Indicates gas content and detects shorts or opens on each individual section of all local, octal and miniature tubes including cold cathode, magic eye and voltage regulator tubes as well as all ballast resistors. Name of the nationally known manufacturer withheld because of special price offer.

Model "C"—Slipping front counter case..... \$49.95
 Model "P"—Handsome hand-rubbed portable case..... 54.95
 Built in-roll chart with either of above \$5.00 extra.

CONDENSERS—PAPER TUBULAR 600 WV.—.001, .002, .005—8c; .01, .05—9c; .1—10c; .2—23c; .05—35c; **ELECTRO-LYTIC:** 10mfd 200v—20c; 10mfd 35c—20c; 50mfd 150v—23c; 20/20mfd 150v—35c; 30/20 150v—46c; 50mfd 150v—43c; 8mfd 475v—34c; 16mfd 370v—55c; **OIL CONDENSERS:** 4mfd 600v 49c; 2mfd 600v—29c; 3X, 1mfd 600v—29c.

SPEAKERS—These 1-M speakers are the finest that are available. All have heavy oversize Alnico V magnets.

3 1/2"	\$1.15	6 for \$6.60
4"	\$1.15	6 for \$6.60
5"	\$1.10	16 for \$9.50
6"	\$1.50	6 for \$9.70
7" (Car Radio Size)	\$4.50	6 for \$31.50
8"	10 oz. \$3.95	6 for \$20.50
8"	21 oz. \$4.95	6 for \$26.50
10"	21 oz. \$5.50	6 for \$30.00
12"	21 oz. \$7.95	6 for \$42.00



HEAT GUN

Streamlined pistol grip heat gun in vivid red housing, that delivers a powerful 20 Cubic Ft. per minute blast of hot air at 160 Fahrenheit. Ordinary blowers have small fan motors, but this has a lifetime-lubricated AC-DC motor of the rugged vacuum cleaner type, that produces a hurricane of either hot or cold air. Perfect for blowing out dirt or dust from radio chassis, drying out ignition systems, warming up carburetors, quick-drying paint, thawing out radiators or water pipes, etc. Warning—Keep this away from your wife, or she will be using it to dry her hair because it will do it in half the time of her ordinary hair dryer.

To say nothing of her using it to dry stockings or clothing, or to toast the refrigerator instantly. Only \$12.95. Satisfaction guaranteed or money refunded if returned prepaid within 5 days.

GENERAL ELECTRIC 150 WATT TRANSMITTER
Cost the Government \$1800.00 • Cost to You—BRAND NEW—\$100.00

This is the famous transmitter used in U.S. Army bombers and ground stations, during the war. Its design and construction have been proved in service, under all kinds of conditions, all over the world. The entire frequency range is covered by means of plug-tuning units which are included. Each tuning has its own oscillator and power amplifier coils and condensers, and antenna tuning circuits—all designed to operate at top efficiency within its particular frequency range. Transmitter and accessories are finished in black enamel, and the built-in meter, voltmeter, and RF ammeter are mounted on the front panel. Here are the specifications: **FREQUENCY RANGE:** 200 to 500 Kc and 1500 to 12,000 Kc. (Will operate on 10 and 20 meter band with slight modification for which diagrams are furnished.) **OSCILLATOR:** Self-excited, thermally compensated, and hand calibrated. **POWER AMPLIFIER:** Neutralized class "C" stage, using 211 tube and equipped with antenna coupling circuit which matches practically any length antenna. **MODULATOR:** Class "B"—uses two 211 tubes. **POWER SUPPLY:** Subbed complete with dynamotor which furnishes 1000V at 350 MA. from either 12 or 24 volts. Complete instructions are furnished to operate set from 110V AC. **SIZE:** 21 1/2 x 23 x 9 3/4". Total shipping wgt. 300 lbs., complete with all tubes, dynamotor power supply, seven tuning units, antenna tuning unit and essential plugs. **NOTE:** Price increases to \$100.00 effective Oct. 1, 1948.

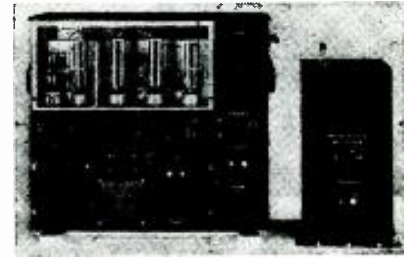

BRAND NEW BC-221 FREQUENCY METERS
 with calibrating Crystal and calibration charts. A precision frequency standard that is useful for innumerable applications for laboratory technician, service man, amateur, and experimenter at the give away price of only \$75.00.

GENERAL ELECTRIC RT-1248 15-TUBE TRANSMITTER-RECEIVER

TERRIFIC POWER—20 watts on any two instantly selected, easily pre-adjusted frequencies from 435 to 500 Mc. Transmitter uses 5 tubes including Western Electric 318 A as final. Receiver uses 10 tubes including 955's, as first detector and oscillator, and 3-7H7's as IF's with 4 slug-tuned 40 Mc. IF transformers, plus a 7H7, 7E7's and 7F7's. In addition unit contains 8 relays designed to operate any sort of external equipment when actuated by a received signal from a similar set elsewhere. Originally designed for 12 volt operation, power supply is not included, as it is a cinch for any experimenter to connect this unit for 110 AC using any supply capable of 400 DC at 135 MA. The ideal unit for use in mobile or stationary service in the Citizen's Radio Telephone Band where no license is necessary. Instructions and diagrams supplied for running the RT-1248 transmitter on either code or voice in AM or FM transmission or reception for use as a mobile public address system, on 80 to 110 Mc. as an FM broadcast receiver, as a Facsimile transmitter or receiver, as an Amateur Television transmitter or receiver for remote control relay hookups, for Geiger-Mueller counter applications. It sells for only \$29.95 or twin for \$53.90, if desired for marine or mobile use the dynamotor which will work on either 12 or 24V DC and supply all power for the set is only \$15.00 additional.

RT1711 Brand New 12 Tube, 110 Volt Receiver-Indicator-Oscilloscope complete with all tubes and power supply. Has telescoping hood over scope tubes, which is equipped with a detachable calibrated screen. Has centering and amplitude controls and two video inputs. A natural for television \$39.95

SELENIUM RECTIFIERS. All types are rated at 130 V.A.C. Do not assort to make quantity.

75 MA	.70	10 for 6.50	50 for \$31.00
100 MA	.75	10 for 7.00	50 for 32.50
150 MA	.80	10 for 7.50	50 for 35.00
200 MA	1.05	10 for 10.00	50 for 47.50
250 MA	1.25	10 for 12.00	50 for 57.50

TERRIFIC VALUE—PORTABLE ELECTRIC DRILL

(Sold at less than established factory price so we cannot mention brand name.)
 Only \$20.95 equipped with 1" Jacobs Geared Chuck and Key. Not an intermittent duty drill, but a full size muzzed tool. Most convenient type switch, natural grip handle, and balance like a six-shooter. Precision cut gears—rubine type cooling blowers—extra long bushings. No stalling under heaviest pressure because of powerful 110 Volt AC-DC motor and multiple ball thrust bearing. Other bearings self-lubricating lifetime-lubricating Chrysler Oilite type. Made for toughest year-in and year-out service in Plant or on construction jobs. Amazing perpetual factory guarantee assures you of a lifetime of trouble-free use. 25% deposit on P.O.D.'s. Full refund if returned prepaid within five days.

\$595 Takes Both BIG BARGAINS

1. **ALUMINUM GEAR BOX** 1 1/2x8 1/2 that contains two powerful electric motors and two matched gear trains, 62 gears in all, varying in size from 1/2 to 1 inches in diameter. This unit is readily converted to rotate a beam antenna or any other similar use..... \$3.00
 2. **SENSATIONAL FASCINATING, AMAZING SELSYNS.** Brand new selsyns made by G. E. Co. Two or more connected together work perfectly on 110 V.A.C. Any rotation of the shaft of one selsyn and all others connected to it will rotate exactly as many degrees in the same direction, following in turn as if the units were connected together by starting instead of wires. This is true whether you twist the shaft of the master unit a fraction of a revolution or many revolutions. Useful for indicating the direction of weather vane, rotating directional antennas, or controlling innumerable operations from a distance. Complete with diagram and instructions. Per matched pair..... \$4.95

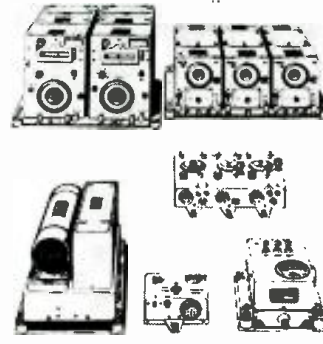

SCR-274N COMMAND SET

The greatest radio equipment value in history. A mountain of valuable equipment that includes 3 receivers that use plug-in coils, and consequently can be changed to any frequencies desired without conversion. Also included are two Tuning Control Boxes; 1 Antenna Coupling Box; four 28V. Dynamotors (easily converted to 110V. operation); two 40-Watt Transmitters including crystals, and Pre-amplifier and Modulator, 29 tubes supplied in all. Only a limited quantity available, so get your order in fast. Removed from unused aircraft and in guaranteed electrical condition. A super value at \$34.95, including crank type tuning knobs for receivers.

PE-109 32-Volt Direct Current Power Plant

This power plant consists of a gasoline engine that is direct coupled to a 3200 watt 32 volt DC generator. This unit is ideal for use in locations that are not serviced by commercial power or to run many of the surplus items that require 24-32V DC for operation. The price of this power plant is only \$79.95. We can also supply a converter that will supply 110V AC from the above unit or from any 32V DC source for \$12.95.

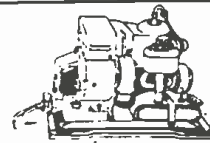

NOTE: Each of the PE-109 power plants that we sell has been actually run and tested for output by us before shipment. Above price is FOB Buffalo.

BUFFALO RADIO SUPPLY, 219-221 Genesee St., Dept. RC-II BUFFALO 3, N. Y.

RADIOMEN'S HEADQUARTERS + WORLD WIDE MAIL ORDER SERVICE ! !

BUFFALO RADIO SUPPLY, ONE OF AMERICA'S LARGEST ELECTRONIC DISTRIBUTORS, IS IN A POSITION TO SUPPLY MOST OF THE REQUIREMENTS OF FOREIGN PURCHASERS, DIRECTLY FROM ITS GIGANTIC STOCKS OR THOSE OF ITS AFFILIATES. EXPORT INQUIRIES ARE SOLICITED BOTH FROM EXPORT HOUSES AND FROM FOREIGN GOVT. PURCHASING COMMISSIONS HERE AND ABROAD. EXPENSE CAN BE REDUCED AND REQUIREMENTS FILLED WITH A MINIMUM OF DELAY BY CONTACTING BUFFALO RADIO SUPPLY INITIALLY.

COMPRESSED AIR INSTANTLY, Anywhere!!



Portable Air Compressor and storage tank. Ruggedly built of best materials using lifetime lubricated ball-bearing on connecting rod and oil impregnated main bearing on shaft. Unusual design forever eliminates valve trouble, the most common fault in air compressors. **PATENTED** unique valve system increases efficiency tremendously over other compressors so that air output is much greater than that from larger compressors powered by heavier motors. Will deliver approximately 3500 cu. inches of air per minute at maintained pressure of 30 lbs., or will inflate a 30 in. tire in less than one minute. Comes complete with 100 lb. gauge, although finger-tip adjustment allows setting of output pressure at any value, which will automatically be maintained. Works from any 1/2 H.P. motor. Useful for spraying paints or lacquers, disinfectants, insecticides, annealing or brazing with natural gas. Inflating tires, etc. Price \$14.50 postage prepaid anywhere in the U. S. Efficient, completely adjustable siphon type spray gun complete with 12 ft. of 100 lb. tested hose available for only \$7.75 with pint container, also prepaid. 25% required on all C.O.D. orders. Send for free catalogs of radio parts and surplus items.

AUTO TRANSFORMERS—Steps up 110v, or steps down 230v to 110v—\$1.95. **TRANS.** 6.3v, 20 Amps.—\$1.98; Universal Output Trans. 8 Watt—89c; 18 Watt—\$1.29; 30 Watt—\$1.69. **AUDIO TRANSFORMERS:** S. Plate to S. Grid. 3:1—79c; S. Plate to P.P. Grids—79c; Heavy Duty Class A1 or B. P.P. Inputs—\$1.49; Midger output for AC-DC sets—69c. **MIKE TRANSFORMER** for T-17 Shure microphone similar to UTC speaker type—\$2.00. Stancor SB or DB mike to line or grid—\$1.95.

POWER TRANSFORMERS—Half-shell type, 110V, 60 cy. Center-tapped HV winding. Specify either 2.5 or 6.3V filament when ordering.
 For 4-5 tube sets—650V, 40MA, 5V & 2.5 or 6.3V..... \$1.49
 For 5-6 tube sets—650V, 45MA, 5V & 2.5 or 6.3V..... 1.75
 For 6-7 tube sets—700V, 50MA, 5V & 2.5 or 6.3V..... 1.90
 For 7-8 tube sets—700V, 70MA, 5V & 6.3 or two 2.5V..... 2.35
 For 7-8 tube sets—700V, 70MA, 5V & 6.3 125 Cycle..... 3.60
 For 8-9 tube sets—700V, 90MA, 5V-3A, 2.5V-3.5A, 2.5-10.5A..... 2.85
 For 9-11 tube sets—700V, 5V & 6.3V-4A..... 2.85
 For 9-15 tube sets—600V, 150MA, 5V & 6.3V. 2.95

Aluminum gear box 18X87 that contains two powerful electric motors and two matched gear trains, 62 gears in all varying in size from 1/2 to 1 inches in diameter. This unit is readily converted to rotate a beam antenna or any other similar use..... \$3.00
TUBES—All types in stock, 60% off on all tubes if ordered in lots of 10 or more.
Super SPECIAL—Highest quality all chrome bullet shaped CRYSTAL MIKE of topknight nationally known brand..... \$5.95
Book on DRY DISC RECTIFIERS by H. B. Conant, nationally recognized authority on the subject Theory and practical applications..... \$.25

STEATITE VARIABLE CONDENSERS
 Ideal for high-frequency applications in receivers and low power transmitter stages.
STANDARD 1/4" DIA. SHAFTS
 10 mmf \$3.25—10 for \$23.00
 15 mmf \$3.25—10 for \$23.00
 25 mmf \$3.25—10 for \$23.00
 35 mmf \$3.25—10 for \$23.00
 50 mmf \$3.25—10 for \$23.00
 75 mmf \$3.25—10 for \$23.00
 100 mmf \$3.25—10 for \$23.00
 150 mmf \$3.25—10 for \$23.00
 100+150 mmf \$1.60—10 for \$12.50
 Butterfly condensers, rotor has two ball bearings and a 3/8" shaft.
 15 mmf, per section \$3.50—10 for \$13.50
 20 mmf, per section \$3.50—10 for \$13.50
 50 mmf, per section \$3.50—10 for \$13.50
 Manufacturers and distributors write for prices on large quantities.

WE HAVE OVER 250,000 VARIABLE CONDENSERS IN STOCK.

AUTO RADIO DEALER ATTENTION
 Nationally advertised brand 1919 car radio that will fit practically any car. These car radios will be sure the hits with your customers. They have plenty of eye appeal plus a host of other features that no other radio regardless of cost can offer. Here are but a few of them:
 Built in battery charger that will charge a car battery. Outlet for an electric shaver or similar electrical appliance.
 The radio is a powerful 6 tube superheterodyne that has a three-gang condenser and a stage of radio frequency amplification for increased sensitivity. The radio, complete with the built-in battery charger and power output, is a single compact unit that is easily installed. **Sample—\$40.50; Dealer Price, \$37.47** each in lots of two or more.

BUFRAD CAR RADIO ANTENNAS

All of our car radio antennas are made of triple plated Admiralty Brass Tubing, complete with low loss shielded antenna leads and high quality fittings.
SIDE COWL—BR-1, 3 sections extend to 66". Your price—single units—\$1.50; in lots of 12—\$1.35 ea.
SKYSCRAPER—BR-2 has 4 heavy duty sections that extend 98". This super-aerial must be seen to be fully appreciated. Your price—single units—\$2.45; in lots of 12—\$2.25 ea.
TILT ANGLE—BR-3, may be adjusted to all body contours. 3 sections extend to 66". Single unit price—\$1.50; 12 lot price—\$1.25 ea.
VERSATILE—BR-4, single hole fender or top cowl mounting may be adjusted to conform with all body contours. 4 sections extend to 56". Single unit price—\$2.90; 12 lot price—\$2.75 ea.
THE MONARCH—BR-5, single hole top cowl mounting. 3 sections extend to 56". Single unit price—\$1.90; 12 lot price—\$1.75 ea.

AFTER SEEING OUR ANTENNAS AND COMPARING, YOU WILL NEVER BUY ANY OTHER MAKE!

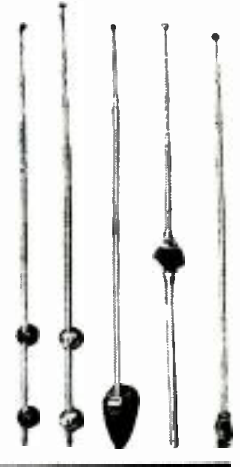

BENDIX SCR 522—Very high Frequency Voice Transmitter-Receiver—100 to 156 MC. This job was good enough for the Joint Command to make it standard equipment in everything that flew, even though each set cost the Gov't \$2500.00. Crystal Controlled and Amplitude Modulated—HIGH TRANSMITTER OUTPUT and 3 Microvolt Receiver Sensitivity gave good communication up to 180 miles at high altitudes. Receiver has ten tubes and transmitter has seven tubes, including two 832's. Furnished complete with 17 tubes, remote control unit, 4 crystals, and the special wide band VHF antenna that was designed for this set. These sets have been removed from unused aircraft and are guaranteed to be in perfect condition. We include free parts and diagrams for the conversion to "continuously variable frequency coverage" in the receiver.
 The SCR 522 complete with 24 volt dynamotor sells for only \$37.95. The SCR 522 is also available with a brand new 12 volt dynamotor for only \$42.95.



VACUUM TUBE VOLT-OHM-CAPACITY METER

There are more features engineered into this all purpose instrument than in any other instrument on the market regardless of price. It was designed not only to meet present conditions but to be readily adaptable to future needs. At the exceptionally low price of this precision instrument no school, plant, lab or service shop need deprive itself of the "new look" in measuring equipment. Here are a few of the many features of this outstanding meter:
 * 5 inch, easy to read, meter.
 * 4 DC voltage ranges from 0 to 1000 V (Input resistance as high as 1 megohm per volt).
 * 7 AC voltage ranges from 0 to 1000 V (No dry disc rectifier to age and destroy the accuracy of this VACUUM TUBE VOLTMETER).
 * 6 Resistance ranges from 210 ohm to 1000 megohms.
 * 4 Capacity ranges from 0.00025 to 20 MF.
 * A zero center range for balancing FM discriminators.
 * Isolating resistor built into probe.
 * Sturdy natural finish hard wood case.
 This outstanding development of one of the leading manufacturers of test equipment costs only \$39.95 complete with all leads, as illustrated.

FILTER CHOKES: 200, 300, 400, 500 ohm light duty—59c; 200 or 300 ohm heavy duty—99c; 250 ma 35 ohm; 250 ma—25c; or 25 for \$4.25; "Melissner" type tapped filter chokes 25c; Choke-condenser combination, ideal to replace any size speaker field when installing FM speaker—79c.
SPLATTER CHOKES—These Tapped "SPLATTER CHOKES" are used between Class C stage and Modulator to eliminate objectionable side band splatter. DC resistance 50 ohms. Our part No. 8000—\$1.50.
SELENIUM RECTIFIERS—Dry disc 180ms 1 1/2", 1", 1/2" Ann. maximum, suitable for converting DC relays to AC for supplying filament source in portable radios, converting DC meters to AC applications, and also may be used in low current charges—90c.
30MC IF TRANSFORMERS, double slug tuned—25c.
30 MC VIDEO AMPLIFIER PLATE COILS—Slug tuned—25c.

RT-1579 consists of a three stage, r-c-c-cle 6847's and 6E6 output stage high gain, high fidelity amplifier with 60 cycle, 110V power supply on the same 13 1/2 x 1 1/2 chassis, which is protected by a substantial steel cover over tubes and parts. Made by Western Electric with typical quality components such as ainsky power transformer and oil condensers. This unit is obviously intended to give years of trouble free service with no more need for repairs than a telephone. Disconnecting one wire each, from the special input and output filters, will result in as high a fidelity amplifier as can be obtained. Your cost with tubes, diagram and parts list included—\$14.95.

RT-1655—11 tube crystal controlled superhet receiver for 21-28V DC operation. Beautiful chassis and cabinet. Uses latest tube types including 7 miniature 6AL5's. Tubes and schematic supplied. Only a few available at.....\$14.95

1000 CYCLE AUDIO FILTERS

Navy PD52010-1 low pass audio filters as mentioned in the "Peaked Audio" article in June CQ, and designated by the above number, are the exact electrical and physical equivalent of commercial audio filter units selling for \$35.00 wholesale. They are infinitely better than the surplus "Radio Range Filters" being sold for reducing QRM, and at 2 KC off resonance for example, a 2 section filter using PD52010-1 is capable of twice the selectivity available thru the use of the Q5'er (the BC453 section of the 274N which has provided the amateur's previous highest standard of interference elimination). **EXTRA SPECIAL**—NAVY PD52010-1 with diagram.... \$5.00

RADIO SET SCOOP. Product of a famous aircraft radio manufacturer who has abandoned the manufacture of table model radios because of the flood of government orders. All in 5 ply genuine mahogany cabinets, both regular and bleached. 6-tube models have tone control. Original list price given first—then your cost. Sensational discounts.

Model 565, Mah. or blonde, \$34.95-\$16.97
 Model 6618, Mah. or blonde, \$44.95-\$20.97
 Model 663, Mah. or blonde, \$46.95-\$21.97

... CROSLY 517

When these sets develop hum not traceable to a bad filter capacitor, check the volume control. It may be burned or warm at one end of the element. In either case, replace it.

HURLEY D. ROBINSON,
Pullman, W. Va.

... RCA 45X1, 45X2

When the rectifier and pilot lamp burned out, the trouble was traced to a short between the voice coil and the field coil of the speaker. The field coil acts as a filter choke. Replacement of the speaker cone and coils was necessary.

DONALD E. STEVENS,
Los Alamos, N. M.

... FILAMENT CIRCUITS

When working on defective filament circuits of portables, insert temporarily a small fuse holder, with a fuse of the proper rating, in series with the filament string. Fuses are cheaper than tubes. When the trouble is cleared up, remove the fuse.

R. W. REID,
Los Angeles, Calif.

... CHEVROLET SETS

If a late-model Chevrolet radio is dead, look for the trouble in the second i.f. transformer. The trimmers short easily.

ED CHRISTNER,
Middletown, Ohio.

... RCA COIN RADIOS

This contains a chassis identical to RCA's 61-5 and 61-10. The volume controls are faulty in some of the sets, the carbon element loosening and falling apart. To check a suspected unit, temporarily connect a 470,000-ohm resistor in place of the control. If the set works, the control was causing the trouble.

LEONARD THOMPSON,
Joplin, Mo.

... PHILCO 38-38

When these sets distort badly and no cause can be found, try replacing the 500,000-ohm volume control.

HURLEY D. ROBINSON,
Pullman, W. Va.

... TELEPHONE TV RECEIVERS

We have found several Teletone sets with a faulty horizontal sweep coupling capacitor (the .005- μ f, 6,000-volt unit which feeds the sync pulse to the deflecting plates of the picture tube). The result is an intermittent raster or picture or complete blanking of both.

To test this capacitor, unsolder the lead from the terminal connected to the deflection plates. Turn the set on and touch the lead to the terminal. The capacitor will charge. Now remove it. If there is an arc, the capacitor is probably bad. Touching it to ground will check the diagnosis. A good capacitor will discharge, while a bad one will do nothing.

Replace the faulty capacitor with a 10,000-volt unit.

H. L. FRAZIER,
Jersey City, N. J.



This **ATTRACTIVE
ALL-STEEL STORAGE
DISPLAY CABINET
FREE**

with purchase of 12 most popular types
HALLDORSON vacuum-sealed
TRANSFORMERS.

Assortment includes input, output
and power transformers as follows (see
Halldorson catalogue):

1-D4-600	1-T-341	1-B5-853
1-D4-604	1-B5-816	1-S-66
1-K4-800	1-A4-777	1-S-67
1-D4-602	1-A4-775	1-S-40

Dealer Net \$24.90

Just the thing for your service bench or can be mounted on the wall . . . an all-steel storage-display cabinet that holds 12 most frequently used Halldorson vacuum-sealed transformers as per list above . . . You pay only for the transformers . . . the cabinet is included in the deal at no extra cost to you . . . saves trips to distributor's counter . . . makes stock keeping easy . . . Good for limited time only. Act now . . .

SEE YOUR RADIO PARTS DISTRIBUTOR OR WRITE
The HALLDORSON COMPANY 4500 Ravenswood Ave. Chicago, Ill.



AT LAST!! A LOW COST POWER UNIT FOR SERVICE WORK

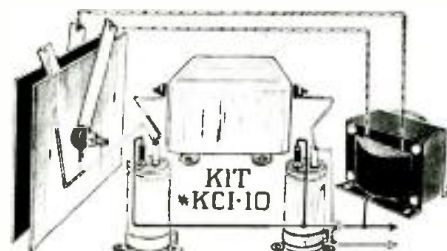

**"A" ELIMINATOR KIT
*KC 1-10**

\$19⁵⁰

Including pictorial and schematic diagrams

For the first time, we are offering a well-engineered six volt direct current power unit for auto-radio and similar service work in kit form!!

This unit was formerly in the high priced range. Now, we have placed all the essential components necessary for construction in kit form, and are offering them to you at this low, low price.

These kits fulfill the long-standing need of every serviceman and technician. They are designed to operate from a 115 V.A.C. 50/60 cycle source, and deliver 6 V.D.C. well-filtered from three to eight amperes, with a peak rating of ten amperes. The A.C. ripple percentage is held to remarkably low values.

This unit charges a standard auto battery in one day!!

- Do away with bulky batteries!
- Do away with corroding fumes!
- Simplify your service operation!

Order these fine kits for your bench today !!

No C.O.D.'s. Full remittance with order. Shipping wt., 12 lbs.

OPAD-GREEN COMPANY

71 Warren St.

Phone: BEekman 3-7385

New York 7, N. Y.

TRANSVISION



NEW Television Kits, and Equipment

Important Advances in TV Reception and Servicing!

Transvision makes television more enjoyable, more profitable!



MODEL 10BL TV/FM KIT



NEW . . . FIELD STRENGTH METER

TRANSVISION manufactures the most extensive line of high quality Television Kits, Cabinets, Components and special equipment. Illustrated and listed here are only a representative few of Transvision's leading values. See your distributor.

MODEL 10BL TV FM KIT, gives 11 1/2 sq. in. picture; complete FM Radio; receives all channels; streamlined cabinet NET \$269.00

Roto-Table for Model 10BL, gives full 180° visibility NET \$ 23.50

MODEL 7CL TV KIT gives 60 sq. in. picture; console cabinet with Roto-Table; streamlined design. Receives all 12 channels; continuous tuning NET \$199.00

MODEL 7BL, same as 7CL except that it is a table model NET \$189.00

All prices include cabinets, tubes, all-channel double folded dip-pole antenna, and 60 ft. of lead-in wire.

NEW . . . TRANSVISION FIELD STRENGTH METER . . .

IMPROVES INSTALLATIONS! SAVES 1/2 THE WORK!

Has numerous features and advantages, including—(1) Measures actual picture signal strength . . . (2) Permits actual picture signal measurements without the use of a complete television set . . . (3) Antenna orientation can be done exactly . . . (4) Measures spots of gain of various antenna and lead-in combinations . . . (5) Useful for checking receiver re-radiation, local oscillation . . . (6) CHANNEL SELECTOR . . . (7) Amplitudes of interfering signals can be checked . . . (8) Weighs only 5 lbs. . . (9) Individually calibrated . . . (10) Housed in attractive metal carrying case . . . (11) Initial cost of this unit is covered after only 3 or 4 installations . . . (12) Operates from 120 volts-60 cycles, Transvision Field Strength Meter, Model FSM-1, complete with tubes NET \$99.50



NEW . . ALL CHANNEL BOOSTER



NEW . . REMOTE CONTROL UNIT KIT

TRANSVISION ALL CHANNEL TELEVISION BOOSTER

To achieve television reception in weak signal areas, or areas which are out of range of certain broadcast stations, Transvision engineers have designed this new booster. It increases signal strength on all 12 television channels. Tunes all 12 television channels, continuously. Can be used with any type of television receiver. Usually high gain in upper television channels. Model B-1 LIST \$39.95

TRANSVISION REMOTE CONTROL UNIT KIT

Will operate any TV receiver from a distance. Turns set on, tunes in stations, controls contrast and brightness. Turns set off. Ideal for installations where the television receiver is inaccessible. Tuner unit is a high gain, all-channel unit with about 50 Micro-volt sensitivity. Easy to assemble in about an hour. Model TRCU, with 25 feet of cable LIST \$49.00 Without cabinet \$47.00

NEW 8-PAGE CATALOG showing complete Transvision line or write to:— now available at your distributor.

TRANSVISION, INC. Dept. R.C. New Rochelle, N.Y.

IN CALIF.: Transvision of California, 8572 Santa Monica Blvd., Hollywood 46 All prices 5% higher west of Mississippi; all prices fair traded. All Prices Subject to Change Without Notice.

Radlomen . . . you can GET INTO THE TELEVISION BUSINESS

In a BIG WAY with the **TRANSVISION DEALER PLAN**

Write for details now!

NEW ZENITH VICE-PRES.

The Zenith Radio Corporation announces that Sam Kaplan, who recently completed his twenty-fifth year with the company, has been appointed a vice-president. In 1934, Mr. Kaplan became assistant treasurer and assistant secretary; in 1935, credit manager; and in 1945 assistant vice-president.



CRESSON MEDAL TO COLPITTS

The recipient of the 100-year-old Cresson Medal of the Franklin Institute is Edwin H. Colpitts, director of the Engineering Foundation of New York, and best known to radiomen as the designer of the circuit which bears his name. It is in recognition of his scientific achievements in the development of long-distance communication by telephone and radio. Dr. Colpitts previously won the Medal for Merit for his services with the National Defense Research Council.



RECEIVES PRESIDENT'S AWARD

John D. Reid, manager of research of the Crosley Division, Avco Manufacturing Corp., has recently been awarded the President's Certificate of Merit for outstanding work on the proximity fuze during the war. The Crosley manager of research was one of fourteen Ohio scientists, doctors and educators to be awarded the honor at a recent Recognition Day Luncheon in Columbus, Ohio.

PARTS FIRM IN NEW HANDS

Control of General Instrument Corp., Elizabeth, N. J., radio parts manufacturer, has been acquired by an industrial group. C. Russell Feldmann, chairman of National Union Radio, has been elected to the same position with General Instrument, and Richard E. Laux, formerly executive vice-president of General Instrument Corp., has been named president and treasurer.

Mr. Feldmann succeeds Samuel Cohen and Mr. Laux succeeds Abraham Blumenkrantz, from whom the controlling interest was purchased. Mr. Cohen and Mr. Blumenkrantz have resigned from the board, as has Louis Scadron. Kenneth C. Meinken, president of National Union, and Harry E. Collin, Toledo investment banker and industrialist, were elected to the new board.

CHECKING A.F. TRANSFORMERS

VERY often, an audio amplifier will not deliver the power for which it is designed because of inefficient transformers, particularly in the output circuit. The efficiency of a transformer in percent is found by dividing the output power by the input power and multiplying by 100.

The output power is computed by connecting a load resistor across the secondary and measuring the voltage developed across it when power is applied to the primary. The power in watts is equal to the square of the voltage divided by the resistance. Measuring power input is not as simple because leakage inductance of the transformer causes the input voltage and current to be out of phase, thus producing false readings. If a capacitor of proper value is shunted across the primary, the leakage inductance will be balanced out and current and voltage will be in phase.

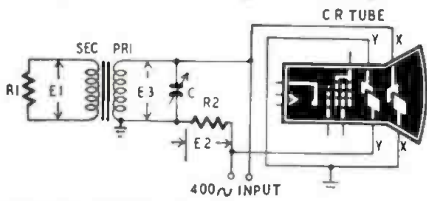

The correct capacitance may be found by using the setup shown in the circuit described originally in *Wireless World* (London). Load the secondary of the transformer with a resistor equal to the output load impedance. Connect the primary to a 400-cycle signal source through a resistor R2 having a resistance somewhat lower than the input load impedance. Connect the X plates of a cathode-ray tube or oscilloscope to the connection of input and primary and the Y plates to the connection of input and R2 as shown. Then vary C until the pattern on the 'scope changes from an oval to a straight line. C will be about .015 µf for the average output transformer.

Measure E1, E2, and E3 with a vacuum-tube or high-resistance voltmeter. The input power is equal to $E3 \times E2/R2$. Dividing this into the output power $E1/R1$, the efficiency of the transformer then becomes:

$$\frac{E1 \times R2}{E2 \times E3 \times R1} \times 100$$

The effective leakage inductance of the transformer is:

$$\frac{E3^2 \times C}{(E3 \times 2\pi fC)^2 + E2^2}$$

where C is in farads, E2 and E3 in volts, R2 in ohms, and f the input frequency in cycles.

If a number of different transformers are to be tested, it is advisable to make a bread board test panel with terminals for connecting the transformer, oscillator, voltmeter and cathode-ray tube. The variable capacitor C may be replaced with a switch and a number of fixed capacitors of different values. R1 and R2 may be calibrated potentiometers.

LOW OVERHEAD.

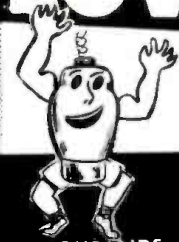

THAT'S WHY YOU SAVE at SENC O!

Type	Each	Each	Each	Each
OZ-4	69c	59c	49	39
1A3	45	39	49	39
1A5GT/G	59	49	49	39
1A7GT	55	48	49	39
1C6	75	68	7F7	54
1E7	99	89	7J7	49
1H4	59	52	7N7	49
1H5GT/G	59	49	7X7	44
1M6	74	69	7Y4	44
1J6	80	72		
1L4	49	45		
1LM4	69	59	12A6	29
1LN5	69	59	12A8GT	35
1N5GT/G	59	49	12AT6	50
1R5	55	49	12AT7	69
1S5	59	55	12BA6	50
1T4	69	55	12BE6	50
1U5	36	30	12F5GT	35
1V	45	39	12M6	39
2A5	54	43	12J5GT	25
2A6	45	35	12J7GT	45
2A7	49	39	12K7GT	45
2X2/879	35	29	12K8Y	35
			12Q7GT	45
			12SA7GT/G	40
			12SF7	35
			12SC7/1634	49
			12SG7	43
			12SJ7GT	55
			12SK7GT/G	45
			12SN7	49
			12SQ7GT/G	45
			12SR7	35
			14A7	65
			14B6	59
			24A	49
			25L6GT/G	49
			25Z5	49
			25Z6GT/G	45
			26	49
			27	49
			28	59
			29	80
			30	75
			31	52
			32	48
			33	59
			34	59
			35/51	42
			35L6GT/G	45
			35W4	43
			35Y4	43
			35Z3	44
			35Z5GT/G	43
			36	35
			37	45
			38	45
			39/44	25
			41	49
			42	47
			47	49
			50L6GT	50
			50Y6GT	50
			56	55
			57	45
			58	45
			59	59
			60	65
			61	39
			62	39
			63	49
			64	47
			65	49
			66	49
			67	49
			68	49
			69	49
			70	49
			71	49
			72	49
			73	49
			74	49
			75	49
			76	49
			77	49
			78	49
			79	49
			80	49
			81	49
			82	49
			83	49
			84/6Z4	49
			85	49
			86	49
			87	49
			88	49
			89	49
			90	49
			91	49
			92	49
			93	49
			94	49
			95	49
			96	49
			97	49
			98	49
			99	49
			100	49

POWER TRANSFORMERS

- All Fully Shielded Flush Mount
- 50 mil — 6.3V @ 2 amps — 5V @ 2 amps 580V \$1.79
- C.T.
- 100 mil — 6.3V @ 3 amps — 5V @ 2 amps 750V.C.T. 2.95
- 150 mil — 6.3V @ 4 amps — 5V @ 3 200 mil — 6.3V @ 3.3 amps — 5V @ 3 amps 815V.C.T. 4.45



VOLUME CONTROL Bargains

- Nationally advertised brand. An exceptional buy! All brand new. Stock up now!
- With Switch
- 10,000 ohms V.C. 3" shaft
- 25,000 ohms V.C. 3" shaft
- 50,000 ohms V.C. 3" shaft
- 100,000 ohms V.C. 3" shaft
- With Switch and Tapped
- 250,000 ohms V.C. 3" shaft
- 500,000 ohms V.C. 3" shaft
- 1 meg ohms V.C. 3" shaft
- 2 meg ohms V.C. 3" shaft
- only 44c ea.

Amazing CARTRIDGE Value

- Fresh stock of brand new cartridges. Order now to be sure you get all you need.
- PNBB Shure Crystal Cartridge \$1.69
- N7 Webster Crystal Cartridge 1.49
- Astatic Nylon Cartridge 2.95

SIGNAL CORPS DUAL HEADSETS

- 6 foot cord and tips. 2000 ohms. Individually boxed. Brand New.
- Now only \$1.49 ea.

SPEAKER Specials

- Top quality, precision built speakers at absolute minimum cost. Take advantage of these values now!
- each
- 5" P.M. — 08 oz Alnico V \$.99
- 3" P.M. — 1.47 oz Alnico V 1.15
- 4" P.M. — 1 oz Alnico V .99
- 4" P.M. — Speaker 1.89
- 4" P.M. — 1 oz Alnico V .99
- 5" P.M. — 1.47 oz Alnico V 1.15
- 5" P.M. — 2.15 oz Alnico V 1.55
- 6" P.M. — 2.15 oz Alnico V 3.69
- 8" P.M. — 6.8 oz Alnico V 4.39
- 10" P.M. — 6.8 oz Alnico V 4.95
- 12" P.M. — 3.2 oz Alnico V 5.95
- 12" P.M. — 6.8 oz Alnico V 5.95
- 12" P.M. — 21 oz Alnico with GV6 P.P. Output 57.95
- 8" Dynamic 680 ohms field with GV6 P.P. Output 3.95
- 12" Dynamic 680 ohms field with GV6 P.P. Output 6.95
- 12" Dynamic 1000 ohms field 5.95

SENC O RADIO INC.

Dept. B, 73 West Broadway
New York 7, N. Y. BEEKMAN 3-6498

MINIMUM ORDER \$1.00
WHEN ORDERING — Send deposit for all C.O.D. shipments — excess will be refunded. Orders without postage will be shipped express collect. All prices P.O.B. New York City.

NEW!
Different!
Down to
earth!

Cash in on



SERVICING PROFITS!

Just Published!

PRACTICAL TELEVISION SERVICING

By J. R. Johnson and J. H. Newitt
375 pages, 6 x 9, over 230 illustrations
Price only \$4

At last, you can get a book that really gives you the low-down on television servicing one that tells step by step what to do and also guides you specifically on precautions to take and the mistakes to be avoided. PRACTICAL TELEVISION SERVICING is all the name implies—a complete, down-to-earth working manual for those who want to understand television servicing fully, get straightened out on the vast amount of MISinformation that is creeping into the television picture, and really be able to do television servicing work.

NOT a Book of Mere Theory

This isn't a book of theory, mathematics and general discussions. The authors, one a radio editor, the other a well-known engineer, actually owned and operated a television service shop to get the specific, how-to-do-it information they now pass along to you in easily understood form. In addition to a clear explanation of how television equipment, construction and operation differ from radio they show exactly how to perform all specific operations in troubleshooting, diagnosing and remedying television receiver troubles. You don't bother with needless theory. You are actually shown how to do the work!

MAKES TELEVISION REPAIR WORK EASY TO UNDERSTAND

Here are the subjects covered:

- | | |
|--|---|
| 1. Television Is Here | 10. Test Equipment and Alignment |
| 2. Fundamentals of the Television System | 11. Wiring and Repair Techniques |
| 3. The Radio-frequency, Intermediate-frequency and Detector Sections | 12. Common Troubles in Television Receivers |
| 4. Video Amplifiers | 13. Troubleshooting |
| 5. Cathode Ray Tubes | 14. Servicing Hints and Case Histories |
| 6. Synchronizing and Sweep Circuits | 15. Color Television |
| 7. Power Supplies | A. Intermediate Frequencies of Standard Receivers |
| 8. Antennas and Wave Propagation | B. Receiver Layout Diagrams |
| 9. Television Receiver Installation | C. Glossary |

FACTUAL SERVICING DATA ON

- How to test for an intermittent peaking coil or transformer
- How to get a signal over a mountain
- What to do when the linearity of the picture is poor
- How to guy a mast properly
- Checking video response with a square wave
- When to use mica capacitors in place of other types
- . . . and scores of other practical problems

10 DAYS TRIAL

SEND NO MONEY JUST MAIL COUPON

Dept. RC-118, Murray Hill Books, Inc.,
232 Madison Ave., New York 16, N. Y.

Send me Johnson & Newitt's PRACTICAL TELEVISION SERVICING for 10 days' examination on approval. In 10 days I will send \$4, plus a few cents postage, or return book postpaid. Postage paid on cash orders; same return privilege. (Books sent on approval in U.S. only. Price outside U.S. \$4.50 post-paid).

Name

Address

City, Zone, State

Occupation

LEAKY CONDENSER TEST

An ohmmeter does not always indicate the true condition of a leaky condenser. To make a better test, disconnect the ungrounded lead of the condenser and touch one lead of a voltmeter to it. Touch the other meter lead to some B-plus point in the receiver at which

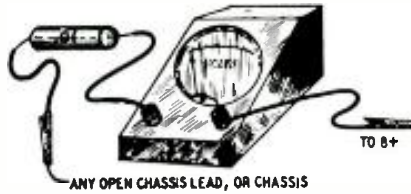

the voltage does not exceed the condenser's rating. (Caution: make sure the B-plus voltage falls within the voltmeter range.)

The reading of the voltmeter will be proportional to the amount of leakage through the condenser.

M. B. SYMCHYCH,
Saskatoon, Sask.

ings of the 0Z4, but we have had no trouble from this source.

A standard synchronous vibrator is connected to the power transformer in the normal manner. The center tap of the secondary is unused. When the vibrator reed contacts points A and C, B becomes positive by the full secondary voltage, and the 0Z4 conducts between P2 and the cathode. When the reed is in the opposite direction, B and D are grounded and A is positive, causing plate D2 to conduct. If there is no output from the cathode, reverse the connections to A and B.

JOE MACE,
Garnett, Kansas

KEYING MONITOR

This keying monitor works on approximately 6 volts of B-supply. The voltage is obtained from a resistor in the cathode circuit of the transmitter's keyed stage. When the stage is keyed, the oscillator produces a tone. The value

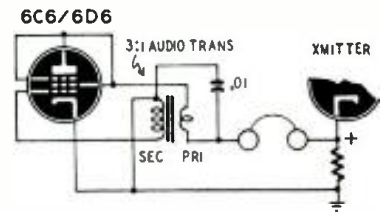

of the resistor should be chosen to give about 6 volts, though a somewhat higher voltage will be as satisfactory. The transformer is any 3:1 audio unit.

R. L. BRIDGES,
Los Angeles, Calif.

CRYSTAL-PLUS RADIO

This crystal receiver uses a 1N34 and includes a two-stage audio amplifier. The tone quality is satisfactory, and selectivity is good for a crystal set.

The receiver works on 117 volts a.c. or d.c. Do not ground it, as the chassis is hot. The antenna trimmer shown was used with a 15-foot length of wire.

ARTHUR S. BEAN,
Baltimore, Md.

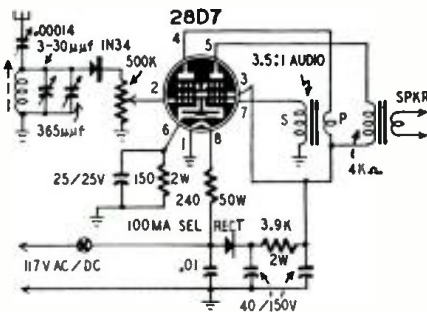

CARBON MIKE TRANSFORMER

When a carbon microphone transformer is needed in a hurry and none can be found, a bell-ringing transformer will often work. Connect the low-voltage secondary to the mike, with the mike battery in series, and the primary between grid and ground.

These transformers will sometimes work, too, as emergency output transformers. Where the secondary is rated at 6-8 volts, a bell transformer will supply filament voltage; but if only a few filaments are to be connected across the transformer, check the voltage under load and insert a small series resistor if it is too high.

NORRIS MCKAMEY,
Davenport, Iowa

(As an emergency microphone transformer, a bell transformer might work well. It would probably not do so in other jobs where more current is carried. Bell transformers are designed for rare intermittent use and are intentionally built to have very high primary impedance and extremely poor regulation. — Editor)

VOLTAGE DOUBLER

This vibrator power supply circuit is one that I have found useful for operating mobile equipment requiring high voltage at moderate current. Standard replacement parts are used.

It is a bridge-type circuit using a combination mechanical and electronic rectifier. It has twice the voltage and half the current of conventional circuits. With the components used, it delivers 650 volts at 50 ma. This exceeds the rat-

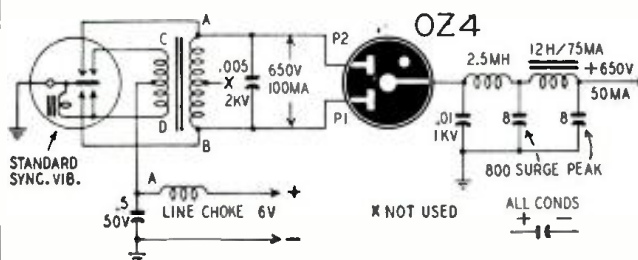

War Surplus Bargains Sold As Used Unless Otherwise Specified!

Micro-switch completely standard, metal grate well cast, rated 15 amperes @ 115 volts normally open type, plunger has override feature. New .35

BC-654-A RECEIVER AND TRANSMITTER

For frequencies, 3800-5800 Kc. Used but in good operating and mechanical condition. Worth many times the price for parts. Complete with all necessary tubes. Shipping weight 40 lbs. Each 29.75

Condenser, electrolytic, 100 Mfd. @ 300 volts, 2 1/2" diameter, 4 1/2" high, metal can. shipping weight 2 lbs. Brand new, 2.00

Condenser Industrial Cond. Corp. 8 Mfd. @ 600 volts DC, 1" x 3 1/2" x 5" high 1.50

Condenser, bath tub type, .1 Mfd. @ 1000 volts DC, new .20

Condenser, Tobe, oil filled, 3 x .1 Mfd. @ 600 volts DC .25

Filter condenser, Aerovox, oil filled, 2 Mfd. @ 600 DC working volts, size about 1 1/2 x 1 1/2 x 5" high, shipping weight about 1 lb., new .35

Condenser, Cornell-Dubilier, oil filled, 4 Mfd. @ 1000 volts DC working voltage, size about 1 x 2 1/2 x 5" high, shipping weight 2 lbs., new 1.75

Vibrator, Radiart VB-3, for 6 volt battery operation, used in vibrator supply PE104—which is used with BC-654A transmitter-receiver, Type J-4, new, 1.95

Vibrator, Radiart VS-3 for 6 volt battery operation, used in vibrator supply PE104—which is used with BC-654A transmitter-receiver, Type J6 (probably exactly same as J-4), new 1.95

Relay, 110 volt 60 cycle AC plunger type for door interlock, new .85

Lord Shock Mount, heavy duty type, base size 3" square x 1 1/2" high—3/8" diameter bolt may be used. New .35

Dual volume control wire wound, each section 25,000 ohms. new .35

Toggle switch, bat handle, DPDT, new, .30

Transformer, 110 volts 60 cycle input; output being two secondaries—each giving 14 volts @ 11 amperes, which can be used alone, in parallel, or in series for various voltage and current combinations. Size about 3 1/2 x 3 1/2 x 4" high. Ideal for operation of propeller pitch motors used for beam antenna rotation. Shipping weight 7 lbs. Manufactured for our company, brand new 5.95

Microswitch, completely weather-proofed, metal-clad or cased, rated 15 amps at 115 volts, normally open type, plunger has override feature. new .35

Battery type BA-38, 103.5 volts, used in Handie-Talkie, Mine detectors or for any purpose where low current drain is required. Size 1 x 1 x 1 1/2" long. Out-dated, but tests O.K. 3.00

Tube socket, RCA, for 866 or similar type tube bases, new, .35

Tube socket, wafer octal type, excellent mica insulation, new, .10

Tube socket for 813 type tube, Johnson type 237, new .60

Tube socket, for Acorn type tubes, made by Millen Co., new, .20

Tube socket, porcelain octal type, less mounting ring, new .10

First IF transformer for BC-348 type receiver, 915 Kc., new 1.00

Kit of potentiometers, twenty-five assorted sized carbon and wire wound. New 2.25

Resistor, voltmeter multiplier type, rated at 2 megohms, 2 kilovolts insulation, 1 Ma. maximum current, about 1" diameter x 5 1/2" long, mounts in clips. New .75

Resistor, 100 watt type, 5 sections having 7500, 3000, 23, 23 and 75 ohms (total of 11,269 ohms) resistance. 1 1/4" diameter by 8 1/2" long. New .35

Cord CD-132, has PL-55 type plug and 9" cord, with spade type lug tips .35

Sylvania type IN26 crystal. New, .35

Resistor 20 watt, one-half ohm. New .10

Fuse holder for type 3AG fuses. New .10

Amphenol co-axial chassis connector, new, type 83-IR .40

Amphenol co-axial angle plug adapter, used, type 83-IAP, .40

Connector, bakelite insulation, male and female section, 6 pin polarized .50

Canvas bag, moisture & fungus proofed, with carrying strap, leather re-enforced corners, weight 3 lbs., size 9" x 14" x 12" high. Ideal for tool case, for sportsmen, etc. New 1.00

Argon bulbs—2 watt, ideal for transmitter tuning, night light, etc. 35c ea. Carton of ten 3.00

Filter condenser, 8 Mfd. @ 700 volts DC working voltage. Oil filled, well insulated terminals. Size about 2" x 4 1/4" x 5" high, with mounting flanges, gray metal case, shipping weight about 4 lbs. New 1.25

Filter condenser, Cornell Dubilier, 1 Mfd. @ 4000 volts DC working voltage, oil filled. Size about 2 1/4" x 4" x 7" high over all. Shipping weight about 4 lbs. Heavy stand-off insulator type terminals. New 3.75

Telephone LINCOLN 8328

PRICES F.O.B. INDIANAPOLIS

TERMS: CASH WITH ORDER

AMERICAN SURPLUS PRODUCTS CO.

537 N. CAPITOL AVE.
INDIANAPOLIS, IND.

Filter condenser, oil filled, 4 Mfd. @ 300 volts, DC working voltage, size about 2" x 2" x 3 1/2" high, shipping weight about 2 lbs. New .35

Condenser Industrial Cond. Corp. 5.2 mfd. @ 50 volts DC, 1" x 2 1/2" x 3 1/4" .35

Filter condenser, Industrial Condenser Corp., oil filled, 1 Mfd. @ 3000 volts DC working voltage, size about 2 1/4" x 3 1/2" x 5" high, well insulated terminals. Shipping weight about 3 lbs. New, 2.00

METERS—Brand New

All checked for accuracy!

0-500 Ma. DC 3 1/2" round, NX35 Westinghouse 3.00

0-5 Amps RF 3 1/2" round, NT35 Westinghouse, Internal TC 4.50

0-3 Amps RF 2 1/2" round, NT33 Westinghouse, less TC 3.50

0-15 MA DC round 3 1/2" bakelite case G. E. type DO-41 Int. Res. 7 1/2 ohms 3.00

0-10 & 0-250 Ma. DC combination, round, DW41 G.E. 2.50

0-3 Ma. DC 3 1/2" square, 327A Triplet 4.50

0-500 Volts AC 3 1/2" square 337A Triplet 6.00

0-2 Volts AC rectifier type 10,000 ohms/volt 327A Triplet, 3 1/2" square 15.00

0-50 Ma. AC 337A Triplet 3 1/2" square 7.50

RELAYS—All brand New

RBM DPDT 110 V. 60 cycle, make before break .75

Leach type 1127-FR 110 V. 60 cycle, DPST 1.50

Automatic Electric Co. DPDT 24 V. DC 6 Amp. silver tungsten contacts .40

Automatic Electric Co. delay relay, 20 ohm, silver tungsten contacts .40

Starter relay, 28 volt operated, heavy duty construction .50

Switch, pushbutton type DPST, on/off type, to fit standard switchbox, 10 amps at 250 volts .25

Switch, toggle type, bat handle, DPDT heavy duty contacts .35

Plastic coated Assault wire, twisted 2-conductor No. 20-7 strand tinned, 100 Ft. or more .01c per ft.

Television wire, 2-conductor—300 ohm, 250 Ft. spool 5.00

4-Conductor wire, 16 gauge impregnated rubber coated sheathed stranded copper wire 100 Ft. 6.00

BC-645 ULTRA HI-FREQUENCY TRANSMITTER-RECEIVER

You read about it recently in QST! Originally operated in the frequency band from 450 to 500 Mc. Can be converted to 420 Mc. amateur band. Consists of complete transmitter and modulator system, and receiver. Complete, brand new, with 15 tubes 11.95

LS-3 SPEAKER

6" PM type, housed in heavy metal case. Contains output transformer to match 4000 ohm impedance. Used but guaranteed okay. Size about 8" x 8" x 4". Shipping weight approx. 10 lbs. Has jack for plugging in cord to receiver. Ideal for B-C-348 receiver 8.50

War Surplus Bargains Sold As Used Unless Otherwise Specified!

MUST VACATE WAREHOUSE — PRICES REDUCED FOR CLEARANCE

SCR-625 MINE DETECTOR (brand new)

The most sensitive mine detector on the surplus market. For miners, treasure hunters, plumbers, electricians, lumber mills, etc. 59.50

AN/PRS-1 MINE DETECTOR (brand new)

A very dependable detector only 22.50

TURBO AMPLIFIERS

Used for parts or small phono-amplifier, shipped complete with the following tubes: 2—7C5's, 1—7Y4, 1—7F7. Our greatest bargain. See July 1947 "Radio-Craft" for conversion data 1.75 ea.

WILLARD LEAD ACID CELLS

(Brand new) 6 V. (dry-charged) 3.00
6 V. in metal carrying case (dry charged) 4.00
(Add electrolyte specific gravity 1.265—any drugstore)

BC-348 Communications Receiver and or SCR-274N Command Set
Power supply for 110 V. operation, with complete instructions 7.95

BC-375 GE MOPA XMTR.

Transmitter only 19.50
Tuning units TU-5B, TU-6B, TU-7B, TU-8B, TU-9B, TU-10B, TU-26B—choice. 2.50
Dynamotor PE-73C 4.95
Antenna tuning unit (BC-306A) 4.95

BC-357 MARKER BEACON RECEIVER

Operates about 75 Mc. Ideal for controlling remote circuit and model aircraft, boats, etc. Signal easily altered to 2-meter band. Tubes used and included—12C8 and 12SQ7. Sensitive relay, circuit diagram inside case. Size $5\frac{3}{8} \times 3\frac{3}{8} \times 5\frac{1}{4}$ ". For 24 V. DC operation 3.95

T-39 APQ-9 RADAR TRANSMITTER

Contains many excellent parts for the VHF experimenter such as a cavity oscillator using 2—RCA 8012 tubes rated at full output to 500 Mc. Tubes are forced aircooled by 24 V. DC motor which is easily converted to 110 V. AC operation. Other valuable parts such as a pair of 807's, 2—6AC7's, 1—931, and 1—6AG7 tubes, ceramic switch, potentiometers, gears, revolution counter, etc., 12.50

APN-1 RADIO ALTIMETER

A complete 460 Mc. radio receiver and transmitter which can be converted for ham or commercial use. Tubes used and included: 4—12SH7, 3—12SJ7, 2—6H6, 1—VR150, 2—955, 2—9004. Other components such as relays, 24 V. dynamotor, transformers, pots, condensers, etc. make this a buy on which you cannot go wrong. Complete in aluminum case $18 \times 7 \times 7\frac{1}{4}$ " 10.95

DETROLA AIRCRAFT RECEIVER

If you want a good 28 V DC operated 200-400 Kc. aircraft-receiver—just don't pass up this bargain. A few left at 5.75 ea.

JACK BOX BC-1366

Contains 2 pole 5 position switch, rheostat, 2 phone jacks, etc. In aluminum case $3\frac{1}{4} \times 4\frac{3}{8} \times 2\frac{1}{4}$ ". Complete with headphone set adapter to match high to low impedance 1.50

R-89/ARN-5A GLIDE PATH RECEIVER

Formerly used for blind landing but adaptable to many other uses such as receiver for new police or citizens band. Band of operation 326-335 Mc. on any of its 3 pre-determined crystal controlled frequencies. Contains 11 tubes, 6 relays and other valuable parts. For 24 V. DC operation. Size $13\frac{3}{4} \times 5\frac{1}{4} \times 6\frac{3}{8}$ ". Price complete, 12.45

AIRCRAFT RADIO RANGE FILTER FL-8A

For helpful reduction of QRM or crowded CW bands. When attached to output of any communications receiver: (1) will pass signal of 1020 CPS, eliminating others, (2) will pass voice frequencies and eliminate 1020 CPS code signal. Compact, lightweight, with switch. Size $2\frac{3}{4} \times 2\frac{3}{8} \times 3\frac{3}{4}$ ". 2.25

BC-733D LOCALIZER RECEIVER

A part of aircraft blind landing equipment. Operates on any of its 6 pre-determined crystal controlled frequencies in the range of 108-120 Mc. Contains 10 tubes—3 of which are W.E. 717-A's—and crystals. Ideal receiver for conversion to 144 Mc. ham band or mobile telephone bands. For 24 V. DC operation. Size $14\frac{1}{2} \times 7 \times 4\frac{5}{8}$ ". Price, with dynamotor 6.95
Price, without dynamotor 5.95

MODULATOR with carbon mike input (with dynamotor) for SCR-274N Command Set 4.75

Telephone LINCOLN 8328

PRICES F.O.B. INDIANAPOLIS

TERMS: CASH WITH ORDER

AMERICAN SURPLUS PRODUCTS CO.

537 N. CAPITOL AVE.
INDIANAPOLIS, IND.

ARB (CRV-46151) AIRCRAFT RADIO RECEIVER

6 tube, 4 band, super-heterodyne rec. with built-in dynamotor. Designed for reception of MCW (tone or voice) or CW within the frequency range 195 Kc. to 9.05 Mc. Complete with brand new pilot's control box and brand new receiver tuning unit 27.50

BC-221 FREQUENCY METER

Covers 125-20,000 Kc. Battery or 110 V. AC or vibrapack operated. A beautiful instrument. The finest we have ever had 69.50

BC-221 FREQUENCY METER, with modulation 89.50

T-17-B CARBON MICROPHONE

Handmike, Brand new 1.75
Telegraph Keys, new .75
Headphone extension cords .75

INTERVALOMETER

Electric timing device. Was used for releasing bombs at intervals. Ideal for dark-room timer, model train control. Contains relays, switches, pilot light, resistors, knobs, etc. 3.25

C-1 AUTO PILOT GYRO

Operates from 24 V. DC or 110 V. AC. Adaptable to many interesting hobbies, 7.95

TELRAD 18-A FREQUENCY STANDARD

Checks signals in the range of 100 Kc. to 45 Mc. with a high degree of accuracy. Self-contained power supply for 110, 130, 150, 220 and 250 V. 25-60 cycle AC. Complete with tubes, dual crystals and instruction book. One of the best buys on the surplus market today. While the few that we have left last 39.50
SCR-510 RADIO SET, new 69.75
SCR-522 (100-156 Mc. receiver & transmitter), complete with tubes 39.75

BC-406-A RECEIVER—Brand New

Manufactured by Western Electric. 165 to 205 Mc. operation. IF frequency 19.5 Mc. IF band width .7 Mc. Easily converted for operation on other ultra-high frequencies. Operates from 110 V., 60 cycle, AC. Worth many times this amount for tubes and parts. Tubes—one 5T4, two 6SJ7, four 6SK7, one 6N7, five 954's, one 955, one 6F7, one 6N7. Also contains small 110 V. operated motor. 34.50

Condenser, mica, .25 Mfd. @ 250 volts, new .15

Jack Box BC-631-B, size about 2" x 2" x 4", aluminum case, contains 10,000 ohm volume control, knob, Jones Barrier strip, brand new .40

Switch, push-button type DPST, on/off type, to fit standard switch box, 10 amperes @ 250 volts, new .25

KINESCOPE PROTECTION CIRCUIT

Patent No. 2,444,902
Charles Edward Torsch
Lancaster Township, Lancaster County, Pa.
(assigned to Radio Corp. of America)

Many television receivers derive their high voltage from the scanning circuits. If these circuits fail, no high voltage is applied to the kinescope. In other cases, the high voltage comes from a separate source such as an r.f. oscillator. If the scanning circuits become defective an intense spot is formed on the screen because the

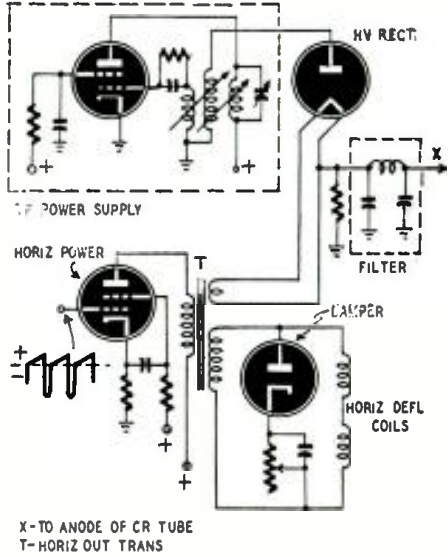

beam is not deflected. This may damage the kinescope.

The circuit shown here eliminates the danger by automatically removing the high voltage if the scanning circuit fails. The rectifier filament is heated through the horizontal output transformer. Unless the sweep circuit is normal, full power will not be applied to the filament and high voltage will be reduced.

There is also protection in case of trouble in the damping circuit. The induced voltage (across the secondaries of the output transformer) is due mainly to the abrupt damping of the primary current. For example, if the deflection coils should open, full voltage will not be applied to the rectifier filament again serving to reduce the high voltage.

It is sufficient to protect against failure in the horizontal scanning circuit. If only the vertical scanning fails the spot will be swept across the screen to form a line. This is not likely to cause damage.

BOTH BOOKS FREE

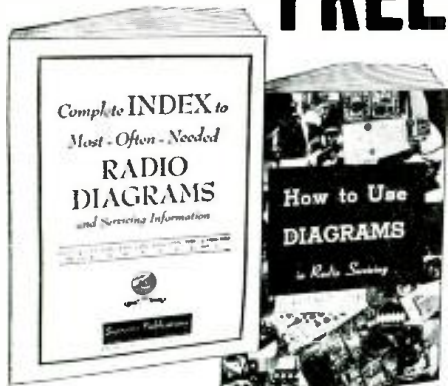

FREE to every reader of Radio-Electronics. No strings, nothing to buy. "How to Use Diagrams" gives hints, suggestions, short cuts on the use of diagrams in radio servicing. The 20-page INDEX will tell you just what models are included in "SERVICING" "Most Often Needed Radio Diagrams" manuals. If you need a circuit at any time, the INDEX will tell you where to get it. Get both books in 2-in-1 volume FREE. Just send 2c stamp for postage.

SUPREME PUBLICATIONS 3727 W. 13th St. Chicago 23, ILL.

COMPLETE RADIO HANDBOOK
The RADIO DATA BOOK

Section 1. The 150 Basic Circuits in Radio
Section 2. Complete Test Equipment Data.
Section 3. Testing, Measuring and Alignment
Section 4. All about Antennas
Section 5. Sound Systems
Section 6. Recording
Section 7. Complete Tube Manual
Section 8. Charts, Graphs and Curves
Section 9. Codes, Symbols and Standards
Section 10. 50 Tested Circuits Designed for Optimum Performance
Section 11. Dictionary of Radio and Electronic Terms
Over 1000 illustrations!

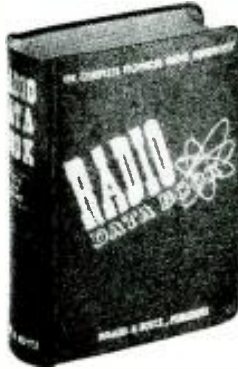

12 complete books in only one. Less than 42c a book!
the only radio handbook of its kind . . . 1148 pages . . . 12 sections, each covering a radio subject more completely than any other book!
ANYONE and every one in radio and electronics can use this book!

ON SALE NOW ONLY \$5.00

COMPLETE TELEVISION MANUAL

The VIDEO HAND BOOK

Sec. 1. Television. Past, Present, Future.
Sec. 2. Fundamentals of Television.
Sec. 3. The Television Station.
Sec. 4. The Television Receiver.
Sec. 5. The Television Antenna System.
Sec. 6. Creating a Television Show.
Sec. 7. Descriptions of Modern Television Receivers.
Sec. 8. Installing Television Receivers.
Sec. 9. Servicing Television Receivers.
Sec. 10. Television Test Equipment.
Sec. 11. Building a Television Receiver.
Sec. 12. Data Section.
Sec. 13. Television Terms.
Sec. 14. Bibliography.



The vast amount of information contained in this book can only be briefly outlined here. The VIDEO HANDBOOK contains 768 pages—over 800 illustrations—thousands of vital facts.

ADVANCE SALE—ONLY \$5.00!
MAKE SURE YOU GET YOUR COPY—ORDER NOW!

SEND THIS COUPON TO YOUR JOBBER OR DIRECT TO:
BOLAND & BOYCE, INC., PUBLISHERS
MONTCLAIR, N. J. RC-11

PLEASE SEND ME
 THE RADIO DATA BOOK \$5.00 (\$5.50 foreign)
 THE VIDEO HAND BOOK \$5.00 (\$5.50 foreign)
 I ENCLOSE \$5 FOR EACH BOOK
 I ENCLOSE \$1.00 AND WILL PAY POSTMAN BALANCE ON DELIVERY (IN U. S. ONLY)

NAME
 ADDRESS
 CITY ZONE.....
 STATE

BOLAND & BOYCE INC., PUBLISHERS

RED HOT BUYS!

CO-AX CABLE RG59U, 100 ft.	\$ 5.25
" " " " 500 ft.	24.75
TWIN LEAD-IN, 300 Ohms, 100 ft.	1.95
" " " " 500 ft.	7.95
" " " " 1000 ft.	13.75

PM SPEAKERS (Alnico No. 5 Mag.)

4"	\$1.19	8"	\$3.95
5"	1.39	10"	4.95
6"	1.75	12"	5.95

OUTPUT TRANSFORMERS

MATCHING, 50L6, 25L6, 43, etc.	\$.39
PUSH PULL (2-25L6)	.59
MATCHING, 6V6, 6K6, 6F6, etc.	.65
MATCHING, 6L6, heavy duty	.79
UNIVERSAL, any tube setup	.95
AC-DC CHOKE, 50 ma, 10 henrys	.39

STANDARD VOLUME CONTROLS

10K, 25K, 50K, 1/2 meg, 1 meg, 2 meg.	
Less switch	19c
With switch	39c

Mention shaft desired, we ship nearest size.

I.F. AND OSCILLATOR COILS

I.F. TRANSFORMER, input 456kc	\$.39
I.F. TRANSFORMER, output 456kc	.39
OSCILLATOR COIL, 456kc	.19
OSCILLATOR COIL, short wave	.19
FM—I.F. TRANSFORMER, 10.7mc	.83
FM-LIMITER TRANS., 10.7mc	.83
FM-DISCRIM. TRANS., 10.7mc	.83
FM—OSCILLATOR COIL	.19
FM ANTENNA COIL	.19

WIRE SPECIALS

6 FOOT LINE CORD, incl. plug	\$.12
ANTENNA HANK, 15-ft. spool	.15
RESISTANCE CORD, 150 ohms	.39
RESISTANCE CORD, 180 ohms	.39
STEP-DOWN CORD, 220 to 110V	.79
ZIP CORD, 20 gauge, 500 feet	6.75

AUTO RADIO ACCESSORIES

VIBRATOR, 4 prong, non synch	\$1.19
WHIP ANTENNA, side mount	1.95
GEN. CONDENSER, 5-200V	.22

PHONOGRAPH ITEMS

PHONO AMPLIFIER, incl. 3 tubes	\$3.95
PHONO MOTOR, incl. turntable	2.95
CRYSTAL PICKUP, incl. hardware	1.95
CRYSTAL CARTRIDGE, fits most pickups	1.45
PERMANENT SAPPHIRE NEEDLE	.49
NEEDLE CUP, automatic spring door	.07
TOGGLE SWITCH, SPST	.15
TOGGLE SWITCH, DPST	.25
TOGGLE SWITCH, DPDT	.37

MISCELLANEOUS ITEMS

ONE POUND ROSIN SOLDER	\$.59
100 WATT ESICO ELEC. SOLD. IRON	2.36
BROOKS INVERTER, 110 V. DC to AC	8.95
FM CONDENSER & COIL KIT, w inst.	4.95
CHASSIS PAN, incl. 8 mounted sockets	.39
LOOP ANTENNA, oval AC-DC type	.39
SELENIUM RECTIFIER, 100 ma	.59
VARIABLE CONDENSER, 2 gang, 420/162	.68
VARIABLE CONDENSER, triple 420 mmfd	1.45
VARIABLE CONDENSER, FM, 88 to 108mc	.95
RADIO TUBE, 1LN5 Sylvania, list \$2.65	.39
100 TUBE CARTONS, GT type	.95
100 TUBE CARTONS, peanut type	.75
100 ASST. CONDENSERS, .001 to .02	3.95
100 ASST. SOCKETS, lect., oct., min.	4.95
100 ASST. RESISTORS, 1/2 watt	1.50
100 ASST. KNOBS, screw & push on	4.95
100 ASST. PILOT LIGHTS, 41 & 47	4.95

BROOKS RADIO DIST. CORP.
80 VESEY ST., DEPT. A NEW YORK 7, N.Y.

OPPORTUNITY AD-LETS

Advertisements in this section cost 25¢ a word for each insertion. Name, address and initials must be included in the above rate. Cash should accompany all classified advertisements unless placed by an established advertising agency. No advertisement for less than ten words accepted. Ten percent discount six issues, twenty percent for twelve issues. Objectionable or misleading advertisements not accepted. Advertisements for December, 1948, issue, must reach us not later than October 11, 1948.

Radio-Electronics, 25 W. Broadway, New York 7, N. Y.

12B8 and 25B8 TUBES; ADAPTORS USING 2 MINIATURE tubes (6AT6 & 6BA6 for 12B8, and 12AT6 & 12BA6 for 25B8). Take less space than original tube, and adaptor fits in same socket. Nothing else to buy—just plug in and it works. Sold on money-back guarantee. 12B8 or 25B8 unit, complete; \$2.00 each; 10 units for \$22.00. Write for new free bulletin catalog, Commercial Radio, 55 Beattle St., Boston, Mass.

RADIOMEN, SERVICEMEN, BEGINNERS — MAKE more money, easily, quickly, \$250 weekly possible. We show you how. Information free. Merit Products, 216-321, 132nd Avenue, Springfield Gardens 13, New York.

SELECTED GROUP OF MEN, GRADUATES OF WELL-known trade school, desir. employment in Radio Field. Will travel anywhere. Qualified in radio servicing, installation, test instruments, circuit operation, etc. Contact Placement Dept., Eastern Technical School, 888 Purchase Street, New Bedford, Mass.

LANCASTER, ALLWINE & ROMMEL, 436 BOWEN Building, Washington 5, D.C. Registered Patent Attorneys. Practice before United States Patent Office. Validity and infringement investigations and opinions. Booklet and form "Evidence of Invention" forwarded upon request.

BRITAIN'S FOREMOST RADIO MONTHLY, PRACTICAL WIRELESS, sent all over the world to "ham" interested European radio developments. Leading technicians describe new British ideas and much valuable advice published for both amateur and expert. Indispensable to the "keen" civilian operator who wants to "keep ahead" and for all DX "hams" who listen out across Atlantic. For annual subscription mailed direct from London, send only \$2.00 to George Newman Ltd. (F.W. 13), 312 Madison Avenue, New York 17.

SUITCASE SIZE RADIO SHOP—FIELD IT AND realize huge profits. Free literature. Write: Grand Federal, 3176 Woodland, Kansas City 3, Kansas.

20 YEARS EXPERIENCE RADIO REPAIRING AT your fingertips. I've perfected simple system you can follow step by step. No formulas or calculations. Cuts repair time to minimum. Total price \$2.00 postpaid or C.O.D. Money-back guarantee. Ross Radio 14615-T Grandriver, Detroit 27, Michigan.

YOU CAN ACCURATELY ALIGN SUPERHETERODYNE receivers without signal generator. Complete instructions \$1. Money-back guarantee. Chas. Gates, Pecos 2, Texas.

MAGAZINES (BACK DATED)—FOREIGN, DOMESTIC, arts. Books, booklets, subscriptions, pin-ups, etc. Catalog 10¢ (refundable). Currone's, 863 First Ave., New York 17, N. Y.

TELEVISION, BUILD YOUR OWN, OUR DETAILED plans \$1.00. Telephone, 834 1/2 E. 74th St., Los Angeles 1, Calif.

AMATEUR RADIO LICENSES, COMPLETE THEORY preparation for passing amateur radio examinations. Home study and resident courses. American Radio Institute, 101 West 64th St., New York City. See our ad on Page 95.

ELECTRIC EYE AND AMPLIFIER KIT, INCLUDES photo-cell, sensitivity control, relay, amplifier, punched chassis, condensers, resistors, diagrams, etc. Industrial type circuit applicable to counting, sorting, burglar alarms, advertising displays, window demonstrations. Xmas tree or model railroad control. Visible and infra-red sensitive. SPECIAL \$7.50 Postpaid. Electric Controls Co., 3062 Fulton St., Brooklyn, N. Y.

WHICH

MAGNETIC TAPE RECORDER

DOUBLES
YOUR PLAYING TIME ..
CUTS YOUR TAPE COSTS
IN HALF?

Write today for technical literature.

AMPLIFIER CORP. OF AMERICA

398-10 Broadway New York 13, N.Y.

Defense appropriations approved by the last session of Congress will require a total of \$1,000,000 of electronic equipment over the next two years or \$500,000,000 in each year. This will mean that the radio industry will be forced to convert 25% of its facilities to the production of electronic equipment for defense by the end of this year.

RELAY TUBE

Patent No. 2,443,511

Michael Parcaro, Arlington, N. J.
(Assigned to Penn Electric Switch Co.,
Goshen, Ind.)

The life of a tube can be prolonged by operating its heater only when needed. However, if the plate voltage is applied before the heater reaches operating temperature, the plate current will cause high evaporation of the emitting material on the surface of the cathode. This shortens its life considerably.

The primary purpose of this tube is to prevent

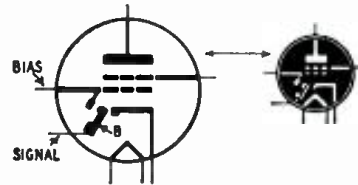

plate current from flowing until the filament is fully heated. To do this the inventor has included a thermal delay relay in the grid circuit of an otherwise normal tube.

In the diagram, the usual control grid is permanently connected to the bias supply. When the filament and plate voltages are first applied the bias on the control grid prevents any plate current flow.

After the filament has heated, the bimetallic strip B distorts and makes contact with the control grid. The normal signal or grid-control voltage is connected to the strip. When contact is made the excitation as well as the bias voltage appears on the control grid and operation is normal. In effect, the internal relay takes the place of the external relay in series with the B-supply often used with medium- and high-power tubes in transmitting equipment for this same purpose.

While many uses could be made of this invention, the inventor refers particularly to use in unattended relay-control circuits. In several applications the filament could automatically be switched on and off intermittently but with usual tubes this is not done because of the severe deterioration caused by plate-current flow before the filament is fully heated. This tube would allow intermittent operation with a consequent saving in filament wear.

A.C. REGULATOR

Patent No. 2,444,715

Alec H. B. Walker, London, England
(assigned to Union Switch & Signal Co.,
Swissvale, Pa.)

Several improvements are included in this stabilizing transformer.

The line is connected across the left-hand winding. Output is taken from a pair of windings around the other two legs of the core. These are series-opposing. The right-hand leg operates at a flux density above saturation. The center leg includes an air-gap, therefore its flux density is much lower.

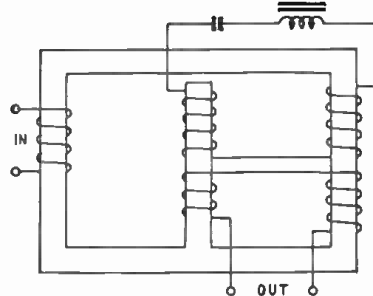

The output voltage is due mainly to the winding around the right-hand leg. This is opposed and stabilized by the voltage induced in the center leg winding which is more sensitive to load changes. A third winding is connected to a series condenser and iron-core inductance which resonate at the third harmonic of the line frequency. The harmonic is greatly reduced, leaving a pure output wave.

The transformer may be designed for 1:1 ratio or for voltage transformation.

MEASURING ELECTRON VELOCITY

Patent No. 2,442,961

Edward G. Ramberg, Feasterville, Pa.
(Assigned to Radio Corp. of America)

Electron velocity can be measured by its effects on a photographic film or screen. This invention interprets velocity in terms of a colored film. Two films are separated by a metallic deposit which slows down electron particles. Each film has maximum sensitivity to electrons of the same velocity. Therefore the second film gets maximum exposure from electrons which had a higher initial velocity. To determine which film has received exposure, each is mixed with a differently colored dye.

The plate shown here is made of a glass support, a red photographic screen, a metallic deposit (such as magnesium) and a green screen. Each screen has maximum sensitivity to electrons of 50 kv velocity, and the metal is sufficient to slow the velocity by 20 kv. Each screen is arranged in checker-board patterns with the dye patches of one corresponding to the spaces between dye patches of the other.

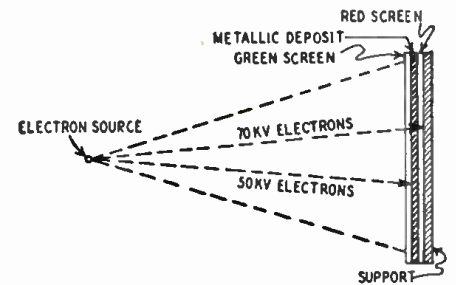

In the presence of 50 kv electrons the green screen becomes dark after developing. If the entire plate is then held to a light these areas will look red. When the plate is exposed to 70 kv electrons, the red screen becomes dark. Therefore the plate looks green when held to a light. Different color shadings correspond to slightly different electron velocities.

INDUCTION COMPASS

Patent No. 2,444,290

Carl-Erik Granqvist, Lidingo, Sweden
(assigned to
Svenska Aktiebolaget Gasaccumulator,
Lidingo, Sweden)

This compass indicates direction electronically. A filter is connected between the instrument and the line to remove second-harmonic distortion which may produce error. Then the a.c. is connected to one coil of a wattmeter W and also through a phase-shifter to a coil L1. The field due to this coil is shown as Hm.

Two more coils L2, L3 are shown to left of L1. Between them is a rotating core C which is stabilized by a gyro. The rotating core C and the two fixed cores (within L2, L3) are horizontal.

Two fields are cut by the rotating core. One is the field Hm and the other is the earth's magnetic field Hh, shown as making an angle d with the first. As C rotates it causes a voltage to be induced in L2 and L3. This is rectified and amplified by a screen-grid tube. The plate circuit is tuned to the line frequency. The a.c. component is passed on to one wattmeter coil.

The wattmeter indication is proportional to the cosine of the angle d. The reading is zero when the three cores point north and south. In this case Hm and Hh are in the same direction.

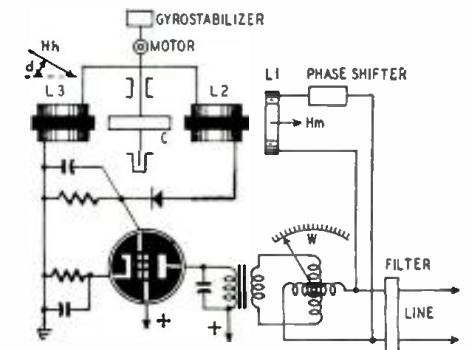

**LOW
FACTORY
PRICES!**

... on the Sensationally NEW 1949
MIDWEST RADIOS

**NEW
SERIES 16
SUPER DE LUXE
AM-FM
CHASSIS**

30 DAYS TRIAL

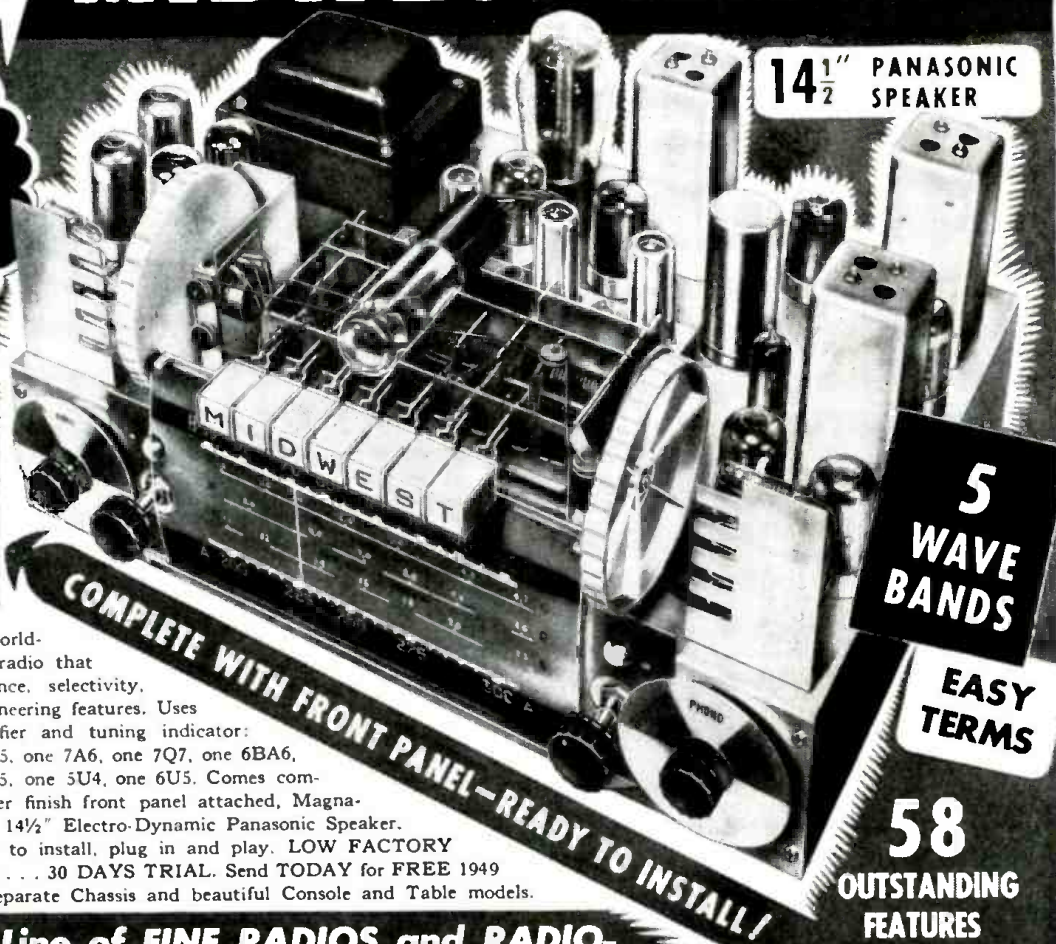

**14 1/2" PANASONIC
SPEAKER**

**5
WAVE
BANDS**

**EASY
TERMS**

58

**OUTSTANDING
FEATURES**

*Including the
Exclusive Midwest*

**FLASH-O-MATIC
Volume and Band Indication**

**TELEVISION
Audio Switch-Over**

**FIDEL-A-STAT
Color-Ray Tone Selection**

**TRI-MAGNADYNE
Coil System**

*...Plus NO-DRIFT FM
and many other features*

Here is the last word in radio engineering . . . a powerful, world-ranging, magnificently-toned radio that is unsurpassed for performance, selectivity, sensitivity, and advanced engineering features. Uses these latest-type tubes, rectifier and tuning indicator: three 7A7, three 7A4, two 7C5, one 7A6, one 7Q7, one 6BA6, one 6BE6, one 6C4, one 6AL5, one 5U4, one 6U5. Comes complete with satin stripe copper finish front panel attached, Magna-Tenna Loop Aerial and giant 14 1/2" Electro-Dynamic Panasonic Speaker. Requires only a few minutes to install, plug in and play. **LOW FACTORY PRICES . . . EASY TERMS . . . 30 DAYS TRIAL.** Send TODAY for FREE 1949 Midwest Radio Catalog of separate Chassis and beautiful Console and Table models.

COMPLETE WITH FRONT PANEL—READY TO INSTALL!

A Complete Line of FINE RADIOS and RADIO-PHONOGRAPHS . . . Available in SEPARATE CHASSIS Like the POWERFUL SERIES 16 AM-FM Model above or in COMPLETE CONSOLES like this...



Beautiful
SYMPHONY GRAND
**AM-FM Radio-Phonograph with
TELEVISION Audio Switch-Over
and NEW Intermix AUTOMATIC
RECORD CHANGER**

A Magnificent musical instrument and a masterpiece of cabinet design—the finest Midwest Radio in 29 years of manufacture. Offers world-ranging radio reception and newest automatic Intermix Record Changing Phonograph. Uses Series 16 Super DeLuxe AM-FM Chassis. Giant 14 1/2" Panasonic Speaker; Tri-Magnadyne Coil System; Built-In Loop Antenna. Other luxurious console and table model cabinets available with Series 16, 12, and 8 chassis—on Easy Terms and 30 Days Free Trial.

Rush for Free Catalog!

**FILL IN COUPON AND MAIL TODAY OR JUST
SEND NAME AND ADDRESS ON 1c POSTCARD**

MIDWEST RADIO & TELEVISION CORP.

Dept. 383 909 Broadway, Cincinnati 2, Ohio

Please send me your new FREE 1949 Catalog.

NAME _____
ADDRESS _____
CITY _____ ZONE _____ STATE _____

BUY DIRECT FROM FACTORY and SAVE!

MIDWEST RADIO & TELEVISION CORP.

Dept. 383 909 Broadway, CINCINNATI 2, OHIO

**COMMAND RECEIVER—
AC POWER SUPPLY
AND SPEAKER**



BC 454 COMMAND RECEIVER
3 to 6 Megacycles. Covers 75 and 80 meter amateur band. Price with schematics, new..... **\$6.95**
TUNING CRANK for Comm. Receivers 65c ea.

AC POWER SUPPLY AND SPEAKER

Completely wired power supply and speaker, with volume control C W and on and off switch, housed in metal cabinet, size 4 1/2" x 5 1/2" x 4 1/2". For above receiver or any other type command receiver, ready to plug into receiver or rack, and 110 Volt 60 Cycle line. Price completely wired **\$14.95**
Price kit of parts only **9.95**



B 19 MARK II TRANSMITTING AND RECEIVING SETS

COMPLETE with all spare parts including 15 spare tubes. Set ready to operate from 12 to 24 Volts DC. Frequency range 2 to 8 Mc (10 and 80 meters). Separate 235 Mc Trans. & Rec and two tube amplifier. Price: New **\$59.50**

MARKER BEACON RECEIVERS

BC-1023 Receives 75 Mc. Modulated signal, can be varied from 62 to 80 Mc. Operates self-contained sensitive relay that can be used to operate equipment from remote point. Needs only 12 to 14 Volts DC for filament and plate voltage. Complete with 4 tubes, schematic. Shock mounted. Size 5 3/4" x 5 3/4" x 3 7/16". New, in original boxes. Price **\$3.50**

INTERPHONE AMPLIFIER BC-347

Army Aircraft Type: uses 6FB Tube. Contains two (2) Magnet High Fidelity UTC oscillator transformers (7/8" x 1 1/4"). Input 200 ohm to single or push pull grid. Output 200 ohm from single or push pull grid, plus resistors, condensers, etc. Completely enclosed. Size 2 1/2" x 4" x 6" Less Tube—only each **79c**
Or 3 for **\$2.00**

ADDRESS DEPT. RC • Prices F.O.B., Lima, Ohio • 25% DEPOSIT On C.O.D. Orders

**SELSYN TRANSMITTER
AND INDICATOR**

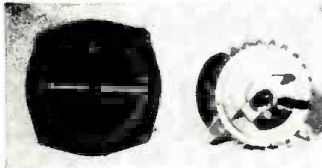

Ideal as Radio Beam position indicator, for Ham, Television or commercial use. Complete with 1-82 five inch indicator. Autosyn Trans. 12 Volt 60 Cycle transformer, and wiring instructions. Price: NEW **\$7.95**
1-82 Indicator only **\$4.95**

ANTENNA MAST MOUNT

Multiple Mast Mount—Can be mounted on Chimneys, on gable, slanted, or flat roofs or on sides or corners of brick or frame walls. Ideal for holding all popular types of Television and FM Antennas in sizes up to 1 1/2" diameter. Made of aluminum, with steel hardware, plated. Complete with banding for chimney mounting. Price **\$4.50**
Less banding **\$3.00**

**DYNAMOTORS—INVERTERS—
MOTORS**

MG-149F INVERTER, Input 24 Volt DC; Output 26 Volts 400 cycle 250 MA or 115 Volt 400 Cycle 400VA. Reconditioned and tested **\$9.95**
MOBILE DYNAMOTOR 9 Volt input, output 40; Volt 3; MA, 9 Volt input, output 250 Volt 95 MA. DMB35X. New **\$3.95**
PM DYNAMOTOR—12 or 24 Volt input, output 55 Volt 50 MA; 6 Volt input, output 240 Volt 50 MA. New **\$1.95**
MOTOR—4 or 12 Volt AC-10; Heavy Duty reversible motor with 5/16" x 7/16" shaft. New **\$2.95**
MOTOR—6 Volt AC-DC Motor ideal for auto fans, models, etc. Shaft 3/8" x 5/8". Used, tested **\$1.50**

FAIR RADIO SALES 132 SOUTH MAIN ST LIMA, OHIO

RADIO TUBES

For immediate shipment

R.M.A. Guaranteed

Individually Sealed Cartons

GT Types	Miniature Types	Price
6K6GT	.40 1S5	.50
6K5GT	.46 1T4	.55
6V6GT	.46 1R5	.55
6SA7GT	.46 3S4	.55
6SJ7GT	.46 6BA6	.50
6SK7GT	.46 6BE6	.50
6SQ7GT	.46 6AT6	.42
6X5GT	.40 12BA6	.50
12SA7GT	.46 12BE6	.50
12SQ7GT	.46 12AT6	.42
12SK7GT	.46 35W4	.42
12SJ7GT	.46 50B5	.55
35L6GT	.40	
35Z5GT	.32	
50L6GT	.46	

25% DEPOSIT REQUIRED ON C.O.D.—2% C.O.D. 10% DISCOUNT ON LOTS OF 50 OR MORE

RAVAC ELECTRONICS CORP.

432 Fourth Avenue
New York 16, N. Y.

**DRASTICALLY SLASHED PRICES
in this FINAL RADIO-EQUIPMENT CLOSE-OUT**

Buy at Distributor's COST!
Only a few of each
First Orders Given Preference

Quan.	Description	Price Each
6	L10 Masco Musical Contact Mike	\$ 4.20
4	VC20 Masco Musical Contact Mike	5.50
4	MA32 Masco Amplifier, with Tubes	41.50
3	MA25 Masco Amplifier, with Tubes	34.90
2	MAS35 Masco Portable System	72.30
1	MA23 Masco Portable System	66.30
2	MAS17 Masco Portable System	52.30
7	MPA3 Masco Electric Photograph	21.75
1	MPT4 Masco Electric Photograph	23.45
12	101 Masco 12" Speaker Cabinet	1.95
6	102 Masco 10" Speaker Cabinet	3.10
21	103 Masco 8" Speaker Cabinet	2.40
21	104 Masco 6" Speaker Cabinet	1.95
7	Mel 8 Masco Microphone Floor Stand	4.00
5	106(W) Webster Rauland Master Unit	12.05
1	1214(W) Webster Rauland Master Unit	39.90
29	4008(W) Webster Rauland Remote Unit	9.00
3	3212 Triplett Tune Tester	45.15
3	2450 Triplett Volt Ohm Meter	71.15
6	2413 Triplett Tube Tester	19.50
4	2405 Triplett Volt Ohm Meter	45.00
3	650A Jackson Condenser Tester	39.00
3	640 Jackson Test Oscillator	39.00
5	642 Jackson Volt Ohm Meter	45.50
3	643 Jackson Volt Ohm Meter	35.00
3	645 Jackson Vacuum Tune Voltmeter	55.00
2	637 Jackson Tube Tester	60.00
9	Kit #4 Clarostat Volume & Tone Control Kit	12.00
	Clarostat Volume Control	1.50
	Clarostat Resistors 25 ohm to 2000 ohm	.10
	Clarostat 10 watt Resistors, 1 ohm to 50,000	.16
	Aerovox—Close Out	
	Electrolytic Capacitors	} 10% below Distributor Cost
	Mica Capacitors	
	Paper Capacitors	
	Resistors	
	(Write us for Specific cost)	
13	S43 Snyder Antenna Hemisphere	1.90
6	Cr Snyder Antenna Bit Box	1.85
100	FC4 Snyder Antenna Cosmonolian	2.50
73	108 Snyder Antenna Window	1.50

Nationally-Advertised Tubes		Nationally-Advertised Tubes	
Quan.	Price Each	Quan.	Price Each
450	1Q5GT \$.80	75	10Y \$1.35
100	1S560	100	12BD660
1200	3A580	175	12BE660
250	3A465	100	12Q7GT55
200	6SA7GT50	200	30 1450
100	6SQ7GT70	100	30 1455
100	6B4G 1.00	100	5655
250	7SJ7GT60	150	70L7GT 1.25
250	6SK7GT50	1500	7245
250	6SQ7GT50	300	7255
100	6G6G80	3000	8033
250	6Y6GT60	100	80 1.50
700	6J5GT60	100	80 1.00

25% Deposit with Order—Balance C.O.D.
CREST CORP., Dept. C-3
3949 Forest Park Blvd., St. Louis 8, Mo.

UN ASSEMBLY USES RADIO

RADIO coverage of the United Nations General Assembly in Paris called for "the most complete and efficient installations ever made in France's history," according to officials of the French Broadcasting System.

The installations, thrown open to the world's radio correspondents and commentators during the Assembly sessions, were made by the French Broadcasting System in cooperation with the United Nations. They included the first use in any international session of the French-made Magnetophone, a tape-recording device which reproduces sound with such astonishing fidelity that even trained musicians are said to be unable to distinguish its recordings from live performances.

In addition to the numerous broadcasting booths installed in the plenary session and committee rooms, six studios for special interviews and commentaries were built into the Palais de Chaillot, the General Assembly's temporary home. A battery of 13 recording machines manned by France's outstanding recording experts was available to the world's radio reporters. Live broadcasts were relayed through a special control room by wire and cable to London, Brussels, Holland, and Geneva, and by short-wave radio to the United States. Complete broadcasts of the sessions were also short-waved throughout the world over the French Broadcasting System's facilities.

Much of the equipment provided by the French Broadcasting System was manufactured especially for the occasion, and a hundred of France's top technicians were assigned to the operation of running and servicing it for the assembly.

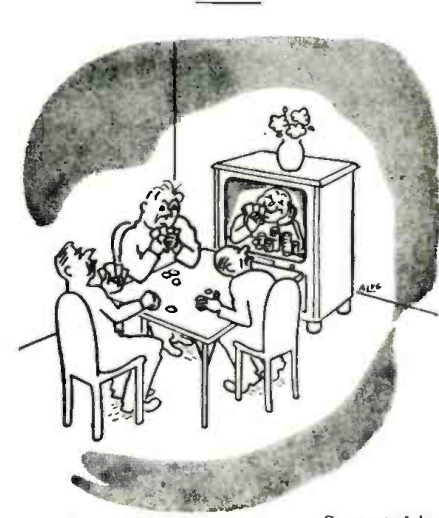

Suggested by: Grego Banskuck

CORRECTION

Mr. Gene Conklin informs us that the yearly license fee for radio servicemen in Costa Rica is \$10.00 rather than \$100.00 as stated in his article, "Radio in Latin America," on page 69 of the August issue.

owner of any car who has fitted an interference suppressor to its ignition system can obtain one of these free of charge from the Radio Society of Great Britain. He then fixes it to his windshield, telling the world that he is doing his bit in the warfare against television interference. I haven't the least doubt that the idea will be a success. To "suppress" an auto costs so little and means so much to televisioners that in television service areas the owner of the vehicle whose windshield doesn't carry the sticker will soon come to be looked upon



Fig. 2—Stickers identify "suppressed" cars.

as a public enemy. It's a really good idea; I take pleasure in passing it on.

Olympic retrospect

Quite apart from our admiration of the wonderful performance of competitors from the United States in the Olympics, the coming of so many Americans to watch the athletic and other events has given us a great deal of pleasure.

One point of special interest was the impression made on American visitors by our television. Naturally, I was anxious to learn how the received images compared with those on American viewing screens. As the BBC televised most of the big items of the Games, there was plenty of opportunity for comparison. It was good to experience the U. S. A. enthusiasm and to find how surprised the Americans were that our 405-line system could accomplish so much.

Actually, it's all wrong to imagine that definition is fixed by the number of lines. You can't, of course, drop below a certain minimum number (probably about 300) without having a poor image. But once you send a reasonable number of lines, the most important factor is the range of modulation frequencies *genuinely transmitted* and properly handled by the receiver. Unless this is sufficient your screen picture is "muzzy" and seems not to be sharply focused. This happens because the video impulses are not square enough, with the result that the different shadings merge gradually into one another instead of being sharply defined. Our frequency range is 2.7 mc—a total band width of 5.4 mc. This, with the very efficient cameras which have been developed, seemed to me to give images about as clear as one could wish. I was glad to hear from American visitors that they were agreeably surprised by the definition and the depth of focus.

Introducing...

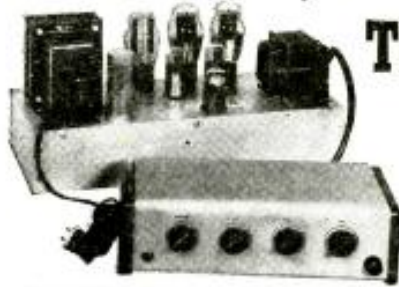

**The NEW Brook
10 WATT
All-Triode
Amplifier**

Model 12A3—Two-unit remote-control amplifier. Deco-rotor-styled control cabinet for living-room use. Also available as Model 12A2 for table or rack operation.

HERE it is at last—an amplifier of incomparable performance—built up to the highest standards of Brook engineering—in the moderate price field.

Within the range of its power rating the new Model 12A3 is equal in all respects to the world-renowned Brook 30-watt amplifiers.

The use of low- μ triodes in all stages, together with Brook-designed transformers available in no other amplifier, permits the cleanest amplification ever achieved... with

intermodulation and harmonic distortion reduced to the vanishing point at any power up to maximum. Frequency response is flat within 0.2 DB from 20 to 20,000 cycles.

Now for the first time, the distortion-free all-triode performance which the Brook Amplifier alone provides is available at a new low cost. Orders will be filled as rapidly as production permits.

Write TODAY for copy of detailed Distortion Analysis and Technical Bulletin SL-8!

Dealer Inquiries Invited — Standard Discounts Apply

The BROOK High Quality Amplifier

— Designed by LINCOLN WALSH



BROOK ELECTRONICS, Inc.,

34 DeHart Place, Elizabeth 2, N. J.

★ POLICALARM

F. M. RADIO RECEIVER \$39.95

Excise tax included. F.O.B. Indianapolis \$10 cash, rest C.O.D. Slightly higher west of Rockies.



TUNES 152-162 MEGACYCLES

6-tube superheterodyne, ready to operate. Veneer cabinet 9 1/2 x 6 1/4 x 5 1/4 deep, wt. 6 lbs. Schematic inside back cover, warranty outside. 2 stages high gain 10.7 megacycle I. F.'s. Guaranteed reception from local F.M. transmitters with attached antenna—police, cabs, others. Ready to plug in and use. 115 volts, A.C.-D.C. Power consumed 2B watts. SOME CHOICE DEALERSHIPS OPEN... WRITE

RADIO APPARATUS CO.
729 N. BANCROFT ST. INDIANAPOLIS 1, IND.

STEADY PROFITS



Your Own Business with

CORADIO

The Coin Operated Radio Place these specially built radios that play 1 or 2 hours for 25c in the thousands of available hotel rooms, tourist courts, etc. They yield immediate profits and steady income. Install Coradio, the finest made. Limited capital required. Send for further information. Write today. **CORADIO Coin Operated Radio** Dept. B.

212 Broadway, Phone: BEekman 3-0038-9 NEW YORK 7, N. Y.

GREYLOCK
A Dependable Name in
RADIO TUBES

GT, Glass & Miniature Types
All Tubes in Individual Cartons

6A8GT	12A7G	1R5
6A7G	12BA6	1T4
6BA6	12BE6	1U4
6BE6	12K7GT	1S5
6K7GT	12Q7GT	3S4
6Q7GT	12SA7	3Q4
6SA7GT	12SK7	3V4
6SK7GT	12SQ7	12AU6
6SQ7GT	25L6GT	12BF6
6V6GT	25Z6GT	35B5
6X4	35W4	35L6GT
12A8GT	50B5	35Z5GT
	50L6	

39c
each

SPECIAL OFFER! All 39c Tubes may be purchased in lots of 100 assorted, at \$35.00 per 100.

6A7	6AU6	6GG6
6AC5	6BH6	6SN7GT
6AK5	6BJ6	12AU7
6AQ5	6C6	25Z5
6AQ6	6D6	75
6AJ5	6SL7GT	117Z3

49c
each

1H5GT	19T8	117L7
1N5GT	70L7	6L6GA
32L7	84	53

59c
each

SPECIAL!! 6BG6G \$.89
Standard Replacement VOLUME CONTROLS
All sizes, 1 1/2" shaft, less switch, each..... \$.24
With SPST switch, each..... \$.34
With DPST Switch, each..... \$.39

PM SPEAKERS Less Trans.

4" with Alnico V Magnet.....	\$1.14
5" with Alnico V Magnet.....	1.14
6" with Alnico V Magnet.....	1.49
3" PM with plastic cone, and 8-oz. Alnico V Magnet.....	1.35
6" 1/2" PM with Alnico V Magnet.....	1.19
WEBSTER M1 Pickup, plastic arm.....	1.49

SELENIUM RECTIFIERS

100 Ma.59
75 Ma.49

TERMS: Net C.O.D., F.O.B. N.Y.C. 35c Handling Charge on all orders under \$5.00.

Write for Bargain Catalog C-11

GREYLOCK ELECTRONIC SUPPLY CO.
30 Church Street New York 7, N. Y.

European Report

By Major Ralph W. Hallows

RADIO-ELECTRONICS LONDON CORRESPONDENT



SOUTHEND is to Londoners what I imagine Coney Island is to New Yorkers. Lying near the mouth of the Thames estuary, its main industry is to provide seaside fun and games for visitors. Londoners flock there in thousands. Though it insists on calling itself Southend-on-sea, the town is, as a matter of fact, some few miles up the river. But the estuary is about seven miles wide here, and the town dweller gets the impression of a vast expanse of water, which is certainly salt.

Since the estuary has shallows extending a long way out from the shore even at high tide, Southend had to build one of the world's longest piers to enable the steamboats, which bring so many of its visitors, to use it as a port of call. That pier is actually over 1½ miles in length and juts out right into the main channel, through which there is a ceaseless passing of ships to and from the Port of London.

Could there be a better place than the end of this enormous pier at which to set up a school for training future radar operators of the mercantile marine? Radar apparatus situated there has its screens as well supplied with "breaks" caused by passing ships as though it were carried on a vessel afloat in mid-channel.

That is just what has been done in the last few weeks. Some of the most up-to-date ship radar equipment has been set up. The scanner provides a lookout extending many miles upstream and downstream; the display is exactly the same as in shipborne radar. Classes of student operators are undergoing intensive training.

But don't forget that Southend is above all things a holiday town, all out to entertain its visitors. The opportunity of showing them "the wonders of radar" was too good to be missed. And it hasn't been missed. A repeater PPI tube has been installed in a room open to all. Do the holidaymakers like it? They do indeed! The radar cabin is now one of Southend's most popular sideshows.

New dry cell

For the best part of 50 years the dry cell just stagnated. Until recently we operated our flashlights or portable radios from cells little more efficient

than those which were available to our grandfathers. The zinc-sal ammoniac-manganese dioxide-carbon cell had been good enough for them, and for a long time it seemed that it would be all that we would ever get. Though it has a good many things to recommend it, that combination of electrodes, electrolyte, and depolarizer is a very long way from ideal. The worst of its shortcomings is that it has a continually falling e.m.f. while under load. True, it recuperates to a large extent when given a rest, but it never quite regains all that it has lost. During a rest the e.m.f. rises, but it never reaches the point at which it was when the previous discharge began.

All this is due to the effects of polarization—and incomplete depolarization. Polarization means that positive hydrogen ions arriving at the carbon electrode to give it its positive charge stay there after they have been neutralized by grabbing electrons reaching the carbon from the outside circuit. In theory the manganese-dioxide depolarizer should hand out enough oxygen atoms to enable the hydrogen molecules to combine with them and form water. In practice it doesn't. Both short-term and long-term polarization occur. During discharge the chemical combination is not sufficiently rapid to cause all the hydrogen mole-

cules to form water. Short-term polarization thus occurs because of the formation of a film of hydrogen gas round the carbon rod. The internal resistance goes up, and down goes the e.m.f. When the cell is rested, the MnO₂ depolarizer does further cleaning-up work; but it never entirely catches up with its job. After every discharge and the following rest the film is a little denser, the internal resistance a little greater, and the e.m.f. a little lower.

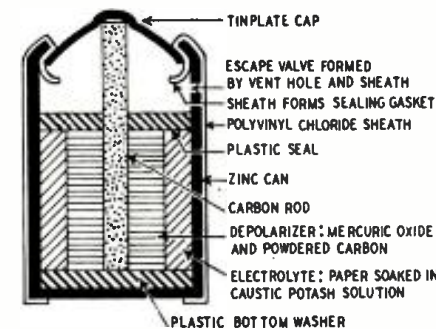

Fig. 1—Vidor Kalium cell has extended life.

Two noteworthy attacks on basic problems of the dry cell have been made recently. One resulted in the Ruben-Mallory cell; a second has just led in Britain to the Vidor Kalium cell. The Vidor cell, whose internal makeup is shown in Fig. 1, has many interesting points. The

zinc can of the original Leclanché dry cell is still there to form the negative contact. There is, again, a central carbon rod. But the electrolyte is caustic potash (KOH) and the depolarizer mercuric oxide (HgO). The top of the carbon rod is pressed hard against the tinplate cap of the cell. A boss in the cap forms the positive contact. As the Kalium cells are made in sizes identical with those of the familiar Leclanché cells, they can replace them anywhere—they have the same diameter, the same length, and the same contacts. But there's a vast difference in their performance. I've just tested out some of the new Vidor cells of the 61 x 32.5 mm size. I was asked by the makers to treat 'em rough, so I did. Each cell was discharged *continuously and with no rests* through a resistance of 5 ohms. As the initial e.m.f. under load is about 1.25 v, this means a nominal current of 0.25 amp. Try that test on the best Leclanché cell of the same size and see what happens. The needle of the voltmeter moves visibly downward, and before so very long reaches the cutoff of 1.0 v. The new cells are perfectly happy with this load. They settle down almost at once to an e.m.f. of 1.15 v and maintain it. My tests showed that the e.m.f. was constant within ± 0.025 v for the first 25 hours of such *continuous* heavy discharge. Then it fell gradually for a further 10½ hours until it had reached 1.0 v. After that it was a landslide; within an additional 1½ hours it had fallen almost to zero. The e.m.f. may seem rather low, but I must say I prefer a moderate e.m.f. which stays put to a nominally higher one which doesn't.

The Kalium cell is available right down to the 35.5 x 20-mm and 51 x 14-mm sizes. The rather complicated series of chemical reactions during discharge is still a matter of some doubt; but don't be surprised at that, for electrochemists still wage fiercer battles of words over those of the lead-acid secondary cell. Those of the Kalium cell are probably:

1. $Zn + HOH = Zn(OH)_2 + 2H$
(formation of zinc hydroxide and hydrogen)
2. $2H + HgO = Hg + HOH$
(removal of hydrogen)
3. $Zn(OH)_2 + 4KOH = K_2ZnO_2 + 2H_2O + 2KOH$
(Removal of zinc hydroxide)

The only snags are that this cell is more expensive to produce than the Leclanché and relatively is not as efficient under light loads as under heavy ones. It needs, in fact, vigorous chemical reactions inside it to be at its best.

The war on interference

I'm sure you'll approve of the automobile sticker shown in Fig. 2. The

DYNAMOTORS



Type	Input Volts	Input Amps	Output Volts	Output Amps	Radio Set	Price*
BD 77KM	11	10	1000	350	BC 191	\$20.00N
PE 73	28	19	1000	350	BC 375	21.50N
DM 21C	11	3.3	275	100	BC 312	3.15N
DM 21CX	28	1.6	275	100	BC 312	3.15N
DM 25	12	2.3	250	95	BC 307	2.91N
DM 28R	28	2.3	275	100	BC 318	3.75
DM 33	28	7	510	250	BC 156	5.50N
DM 42	14	16	515	110	SCR 506	6.50N
PE 55	12	25	500	400	SCR 215	5.25N
PE 86	28	1.25	275	100	BC 307	3.95
PE 101 C	13/26	12/6	400	135	SCR 515	5.25N
BD AR 93	28	3.25	375	150		4.95N
23350	27	1.75	285	107	APN-1	3.50N
35X045B	28	1.2	250	100		3.50N
ZA 0515	12/24	1/2	500	350		3.95N
B-19 pack	12	3.1	275	110	Mark II	9.95N

*N—New, L.N. Lake, New.

HAND GENERATORS

GN-35: Output: 750 v., 60 ma., 8 v., 2.4 amp. less hand crank. \$7.50
 SELSYNS: 115 v., 60 cy., size 7. \$7.75 per pair

COAX CABLE

RG 18/U, 52 ohm imp., unarmored. \$51/ft.
 RG 23/U, 100 ohm coax, 127 ohm imp., armored. \$50/ft.
 RG 28/U, 50 ohm imp., pulse cable, Corona min. starting voltage 17 KV.
 RG 35/U, 70 ohm imp., armored. \$50/ft.

COAX CONNECTORS.

831R	\$.35	UG 21 U	\$.85
831SP	\$.35	UG 86 U	\$.95
831AF	\$.35	UG 254 U	\$.75
831HP	\$.15	UG 255/U	\$.85
Homedef male to type "N" male adapter. \$1.25			

QBG-1, ECHO RANGING DRIVER-RECEIVER
 Complete underwater sound signal transmission and reception unit with range of 200 to 600 yds. and frequency of 16 to 27 kc. New, complete with battery \$85.00
 box in chest, less projector

BAND PASS FILTER

#70473. Sharp band pass peaked at 700 cps. High-to-high impedance. Can be plugged into phone output of receiver for good results. Cuts out QRM. New, with circuit diagram. \$2.25

INSTRUCTION MANUALS
 RC 312, RC 342 \$1.25
 SCR 281 \$1.25
 ZA Equip. .75
 Mark II .75
 SCR 508 1.00
 SX-32 .75

VIBRATORS

TR 1210, 12 vdc, 5 pin \$1.20
 OAK V-0675, 24-32 vdc, 7 pin 1.10
 Mal. Type G531C, 12 vdc, 5 pin 1.25
 Mal. Type G629-C, 12 vdc, 4 pin 1.15

VFO KIT—80 METERS

ARC-5, Xmitr M.O. parts and circuit for that new VFO-exciter. Kit consists of the following: 1-#1029 M.O. coil; 1-#5632 tuning condenser; 1-#1990 padding cap. 1-#ARC-5 Xmitr. schematic. Complete kit \$2.75

HEADSETS

Dynamic mike and headset combination. A high quality, efficient unit, used in B-19 tank Xmitrs. Mike and phones complete. Few. \$2.75
 R-15 headsets: 8000 ohms impedance, rubber cushions. Comes with 8' cord and plug PL-55. New. \$2.95
 Head and Chest Set HS-19. Carbon mike magnetic phones. New, complete with plug PL-58. \$4.50

MICROPHONE ELEMENTS

Carbon transmitter element for TS11-J, TS11-L, TS13-E, TS15-A. Element for microphone T-24, 30 ohm resistance. .95 ea.

CROSS POINTER INDICATOR

Dual 0-200 microamp. movement in 3" case. Each movement brought out to 6-term. receptacle at rear. Originally used in ILS equip. \$5.00



30' U.S. ARMY SIGNAL CORPS RADIO MASTS

Complete set for the erection of a full flat top antenna. Of rugged plywood construction telescoping into 3/4 in. ft. sections for easy storage and transportability. A perfect setup for "getting out." Supplied complete: 2 complete masts, hardware, shipping crate. Wt. app. 200 lbs. Sig. Corps #2A289-223A. New. per set \$39.50

MAGNETRONS

TUBE	FRQ. RANGE	PK. PWR. OUT.	PRICE
2431	2820-2860 mc.	265 K.W.	\$15.00
2421A	9245-9105 mc.	50 K.W.	25.00
2422	2267-2333 mc.	265 K.W.	15.00
2426	2092-2019 mc.	275 K.W.	15.00
2427	2065-2092 mc.	275 K.W.	15.00
2432	2780-2820 mc.	285 K.W.	15.00
2438	Pkg. 3240-2263 mc.	5 K.W.	25.00
2439	Pkg. 3267-3333 mc.	8.7 K.W.	25.00
2475	Pkg. 9345-9105 mc.	50 K.W.	25.00
3431	21,000 mc.	35 K.W.	55.00
5430			39.50
711AY			50.00
720BY	2800 mc.	1000 K.W.	50.00
720Y			50.00
725-A			25.00
730-A			25.00

KLZYSTRONS: 723A/B \$12.50; 707B \$20.00; 720-A \$15.00

MAGNETS

For 201 727-A, 2422, 2426, 2427, 2431, 2432, and 3431
 1850 Gauss, 3/4" bet. pole faces, 3/4" pole diam. Each \$8.00
 1500 Gauss, 1 1/4" bet. pole faces, 1 1/4" pole diam. 8.00

TUNABLE PKG'D 'CW' MAGNETRONS

QK50 2875-2900 Mcs. QK61 2975-3200 Mcg
 QK60 2840-2875 Mcs. QK62 3170-2375 Mcs.
 NEW—\$45 each New—\$55 each

A COMPLETE LINE—MICROWAVE EQUIPMENT IN STOCK: 10CM, 3CM, 1.2 CM. SEND FOR MICROWAVE FLYER.

BIRTCHEER TUBE CLAMPS



926-A 926-B5
 926-A2 926-B33
 926-B 926-C
 926-B1
 All sizes \$1.4 Each

SPECIALS

SELENIUM RECTIFIERS, Input: 115 vdc, 60 cy. Out: 120 vdc, 1.66 amps. Full Wave, F. T. & R. #1011 \$9.95
 POWER SWITCH, 4 pos., 60 amps., 600 vac. Arrow H&H \$4.25
 ROTARY SPARK GAP, 24 vdc motor, 1 spark gap electrodes, p/o Xmitr BC 1081-TG \$5.50
 CODE TAPE, paper 1 1/16 wide, 8" diam. rolls \$5.50
 CABLE ASSEMBLY, 45 pr. 102' L. Telephone type WE #100059 \$20.00 per length
 SONAR SOUND DETECTOR: Underwater detector with 7 microphone units encased in rubber sheath. Model JR \$12.50
 MN72H Azimuth control box for aircraft radio compass \$1.25
 ARC-3 Airborne radio series replacement relays. Types 55526, 55521, 55542, 55528, 55531, 55585. \$.60 ea.
 TUBE HOLDER, GE type EL-1 \$1.00
 AMERTYPE RECORDING FILM, 50 ft. lengths individually boxed \$1.00 per length
 MODULATION TRANS. ARC #9866, push pull 80% to plates and screens of 2 807's in parallel \$1.65

GREAT TUBE VALUES

01-A	\$.45	5430	39.50	531	45.00	1061	5.00
1024	4.85	0A67	1.00	532	3.95	8012	3.95
1H5	.85	0AK5	.95	539	4.00	8002	.65
1N5	.60	6C4	.58	562	90.00	9004	.47
1T4	.60	6C	2.00	615	.89	9006	.47
2C21	.69	6J6	1.00	701-A	7.00	CE 7?	1.95
2C22	1.85	6K7	.85	704-A	.75	EF 50?	.79
2421-A	25.00	6L6GA	1.00	705-A	2.85	F-1148	.75
2422	15.00	6C87	.70	7107-H	20.00	F-128	20.00
2426	15.00	6X87	1.00	714AY	15.00	FC 258A	1.00
2427	15.00	6X8	.75	715-B	12.00	FC 271	40.00
2431	25.00	7C4	1.00	720HY	50.00	GL 562	75.00
2432	15.00	7E5	1.00	720CV	50.00	GL 623	75.00
2438	25.00	7E8	.72	721-A	3.80	GL 697	75.00
2439	25.00	10Y	.60	723-A	12.00	ML 100	60.00
2455	25.00	12A6	.35	724-B	1.75	ML 100	60.00
3131	35.00	12BY7	14.95	724-D	1.25	VR 135	1.25
3132	35.00	12KX5	.65	725-A	25.00	QC 80	45.00
3133	35.00	12N7	.49	726-A	15.00	QC 81	55.00
314	.65	12N87	.49	726-B	2.25	QC 82	55.00
31P1	2.25	12SK7	1.40	801-A	4.10	8CA 932	55
3C24	6.00	15L	1.40	801-A	4.10	8CA 932	55
3C30	.79	20D7	.75	804	9.95	VR 91	1.00
3D0	.79	30 (Spec.)	.70	815	2.50	VR 130	1.25
3D1-A	13.50	35L8	.89	836	1.25	VR 135	1.25
3D21-A	1.50	35Z5	.66	837	1.95	VR 137	1.25
3D31	2.25	45 (Spec.)	.59	843	.59	VII 150-30	.95
3E1	2.95	39 44	.49	840	15.00	VU 120	1.00
3F17	1.20	35 51	.72	861	40.00	VU 134	1.00
3F19	3.50	41 4	.75	874	4.95	WL 532	4.75
3Q5	.79	227A	3.85	876	4.95	WT 250	3.00
5BP1	1.20	225	8.80	1005	.35	Twist cavity	
5BP4	4.95	250R	20.00	1613	.95	Twist cavity	
5CP1	3.75	355-A	19.50	1619	.21	with 5.00	
5F17	3.50	417A	22.50	1624	.85	Photocell	
5F19	6.00	530	90.00	1624	.35		

VOLTAGE REGULATORS



Mfg. Raytheon: Navy CRP-30107; Pri: 92-138 v., 15 amps, 57 to 63 cy. 1 phase. Sec: 115 v., 7.15 amp. #2 KVA, 96-PP. Contains the following components: Regulator Transformer; Raytheon UX-9515; Pri: 92-138 v., 60 cy. 1 PH. Sec: 200/580 v., 3.5/5.26 amps, 4000 v rms test.
 Filter Reactor: 156 hy, 5 amps, 1000 v test. Raytheon UX-9517.
 Transformer; Pri: 185 v., 5 amps; Sec: 115 v., 7.2 amps. Entire unit is enclosed in grey metal cabinet with mounting facilities. Size: 12"x20"x20". Net wt. approx. 250 lbs. New, as shown \$99.50

K5 9668 Plate Transformer; Pri: 117 v., 60 cy tapped to give 2750/2470/2240 on secondary at 750 ma. on CT; 7000 volts insulation \$34.50
VOLTAGE REG. "Trauslat" Amertran Type "RIF" 2 Kva Load. Input: 90/130 v 50/60 cy. Output: 115v. \$40.00
ITE Circuit Breaker, 115 amps, 6000 v. \$15.00
FILE TRANS. UX-6899 Pri: 115 v., 60 cy. Sec: Two 3 v., 5.5 amp Wdg. 29KV Test. \$24.50
PLATE TRANSFORMER; Pri: 115 230 V. Sec: 9000 v. Sec: 21,000 v. 100 ma. \$120.00

OIL CONDENSERS

.1 mfd. 10 KVDC GEPVR 214F101 \$15.00
 15 mfd. 1000 vdc \$3.25
 1.5 mfd. 6000 vdc Airpax \$12.50
 .25 mfd. 20,000 vdc \$17.50
 10 mfd. 1000 VDC \$1.79
 3x10 mfd. delta connected synchro-capacitor, 90 v., 60 cycles, GE \$4.95
 1 mfd. 6000 vdc, GEPVR 25F50002 \$3.85

POWER CHOKES

Swing. Choke: 4.5 to 8 hy.; 2 to 1 amp. \$10.95
 .03 hy., 2 amp. \$4.45 35 hy., .35 amp. \$7.50
 8.5 hy., 125 ma. \$5.50 Dual 2.5 hy., 130 ma. \$11.25
 25 hy., 65 ma. \$5.10 Dual 1.5 hy., 150 ma. \$6.75
 6 hy., 150 ma. \$1.50 Dual 3 hy., 150 ma. \$16.00
 Dual 7 hy., 75 ma. \$1.10 Dual 5 hy., 380 ma. \$3.95
 3 hy., 40 ma. \$12 Dual 2 hy., 100 ma. \$5.75
 1.16 hy., .15 amp. \$4.50 2 hy., 200 ma. \$5.75
 .01 hy., 2.5 amp. \$3.50 Dual 120 hy., 17 ma. \$2.45

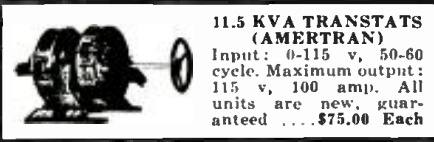

400 CYCLE TRANSFORMERS

4109; Pri: 115 v., 400 cy. Sec: 6.3 v., 2.7 amp. \$2.95
 6.3 v., 60 amp; 6.3 v., 21 amp. \$2.95
 32332; Pri: 115 v., 400-2400 cy. Sec: 400 vdc \$2.95
 352; Pri: 115 v., 400-2400 cy. Sec: 15 amp. \$2.25
 352-1759; Pri: 115 v., 400-2400 cy. Sec: 6.5 v., 12 amp. \$3.50
 12 amp. ct. 250 v., 100 ma. 5 v., 2 amp. \$3.50
 #9049; Pri: 115 840 v., 400-2400 cy. Sec: 650 vdc \$2.15
 352-7090; Pri: 115/80 v., 400-2400 cy. Sec: 2.5 v., 1.75 amp. 3KV Ins. 5v., 3 amp; 6.5 v., 6.5 amp. \$3.95
 6.5 v., 1.2 amp. \$3.95
 KS 9607; Pri: 115 v., 400-2400 cy. Sec: 794 VCT. \$5.95
 177 ma., 1710 vdc, 177 ma. \$5.95
 D-1625; Pri: 115 v., 400-2400 cy. Sec: 6.3 v., 1.0 amp. 7.7 v., 0.265 amp. \$2.79
 GE #747157; Pri: 100/110/120/130 v., 100-2400 cy. Sec: 2.5 v., 20 amp. HV Ins. \$4.85
 D-1625; Pri: 115 v., 400 cy. Sec: 6.3 v., 12 amp. \$5.85
 6.3 v., 2 amp; 6.3 v., 1 amp. P O AN APD-5 \$5.85
 KS 9685; Pri: 115 v., 400-2400 cy. Sec: 6.3 vdc \$4.35
 7.5 amp; 6.3 v., 3.8 amp; 6.3 v., 2.5 amp. \$4.35
 PLATE XFMR; Pri: 115 v., 400 cy. Sec: 9800 v. \$12.50
 #12033, Plate Xmitr; Pri: 115 v., 800 cy. Sec: 4550 v. \$7.50
 vdc, 250 ma.
 KS 9445, Pwr Xmitr; Pri: 115 v., 400-2400 cy. Sec: 592 vdc, 120 ma. 6.3v., 8 amp; 5 v., 2 amp. \$3.50
 PLATE XFMR; Pri: 115 v., 400-2400 cy. Sec: 4500 v., 6 ma. \$6.50
 #7143; Pri: 115 v., 400 cy. Sec: 6.3 v., 7 amp. \$2.50
 FILE XFMR; Pri: 115 v., 400 cy. Sec: 6.3 v., 9 amp. \$3.25
 6.3 vdc, .65 amp; 2.5 v., 3.5 amp; 2.5 v., 3.5 amp. \$15.00
 10 amp. size; 7"x10"x6" \$15.00
 PLATE XFMR; Pri: 115 v., 400 cy. Sec: 11500 v., 1150 v., 10 ma. G.E. (86531) \$1.75

INVERTERS

PE 200-A, Input: 28 VDC @ 38 amp. Output: 80 volts @ 500 volt-amps, 800 cycles, Leiland. New, complete with on-circuit relay. Filter, instruction book. \$12.50
 PE 21R; Input: 25-28 VDC @ 92 amps. Output: 115 volts @ 1500 volt-amps, 380-500 cycles. Poor physical but good running condition. \$25.00

BEAM MECHANISM

The most powerful, compact assembly offered on surplus for beam ratchet. 00:1 gear ratio turned by 24 wire motor that will run on 12 vac. Bicycle type sprocket for easy coupling to any shaft. 9/16"x6 1/2"x4 1/4" with mounting facility. New, guaranteed, complete with 110 vac. 12 v. step down transformer \$16.50



131-C.
 Liberty St.
 New York 7, N.Y.

All merchandise guaranteed. Mail orders promptly filled. All prices, F.O.B. New York City. Send Money Order or Check. Shipping charges sent C.O.D.

COMMUNICATIONS EQUIPMENT CO.

PHONE
 DIGBY
 9-4124

Instrument Voltage Supply

A cheap and simple power supply that provides up to 50 ma at exactly 90 volts for instrument use

By R. L. PARMENTER

VERY frequently resistors that are in the order of megohms have to be checked. Usually an external battery is used with a limiting resistor to extend the resistance range of the average ohmmeter. A B-battery will last a long time and its cost is not too great, but there are advan-

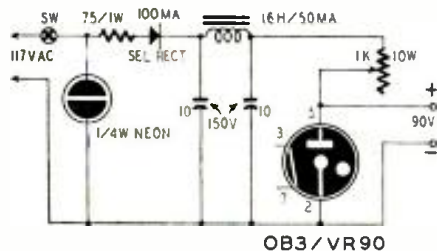

Fig. 1—A regulator tube fixes the voltage.

tages in having a small power supply available for the purpose.

This small regulated supply provides 90 volts at 50 ma. There is no warm-up period; the potential is there as soon as the line switch is snapped. Such a power supply can also be used as a B-supply for servicing battery receivers up to its limit of 50 ma. This limit might be extended somewhat by using a heavier-duty choke. The cost of the unit is nominal, about twice the price of B-batteries, but it will last indefinitely. With the OB3/VR90, a regulated potential of 90 volts is obtained. Since this is a multiple of the batteries commonly used in ohmmeters, the resistance readings of the instrument can generally be multiplied by the proper factor without need of recalibration. In other words, if a 4.5-volt battery is normally used in the ohmmeter circuit the multiplier would be 20, since 90 divided by 4.5 equals 20.

The circuit diagram is shown in Fig. 1. The 1,000-ohm, 10-watt adjustable resistor is for setting the current flow through the regulator tube to the proper value. This may be done very easily by inserting a 0-50-ma meter between the resistor and the tube. Adjust the slider until the current flowing through the tube is about 20 ma. This will provide good regulation even when the line voltage varies over a considerable range. The 1/4-watt neon bulb is used as a pilot lamp. Observe the polarity of the rectifier unit when wiring.

The cabinet was constructed of masonite and wood.

The unit described was built to be used with the volt-ohm-milliammeter shown in the photo, which calls for a 90-volt external battery for the ohms x 1,000 range and provides readings up to 10 megohms. With any similar meter, where jacks are provided for connecting an external battery, the 90-volt supply can be connected to these jacks and no further equipment is needed.

When the meter has no provision for connection of an external battery, a current-limiting resistor and a zero adjuster must be added. A separate box can be used for these, or they can be built right into the power-supply case.

To find the values for these resistors, the builder must know the basic full-

Suitable values would then be around 80,000 ohms for R1 and 20,000 ohms for R2 (to give it a little extra adjustment range).

To measure a resistor, connect the circuit of Fig. 2 to the multimeter through the milliamperage jacks on the panel. Short the test terminals A and B, and adjust R2 for full-scale reading. Now insert the unknown resistor between the test terminals and read the value from the ohms scale, multiplying by the proper factor.

The circuit of Fig. 2 can be used with any milliammeter, even one not calibrated in ohms. Having found the total series resistance necessary for full-scale meter reading (R1 plus R2), use the following formula to find the value of an unknown resistor:

$$R_x = \frac{90}{I_m} - (R_1 + R_2),$$

where R_x is the unknown resistor and I_m is the milliammeter reading (in amperes) with the unknown in the circuit.

For instance, if the meter is a 0-1-ma unit, R1 plus R2 will equal 90,000. If the meter reading is 0.5 ma (.0005 amp), the formula will read:

$$R_x = \frac{90}{.0005} - 90,000 = 90,000 \text{ ohms.}$$

An easier approach is to calibrate the meter with a number of known resistors, and paste a chart or table on some convenient part of the instrument.

When taking readings, beware of shock. Even 90 volts can be uncomfortable.

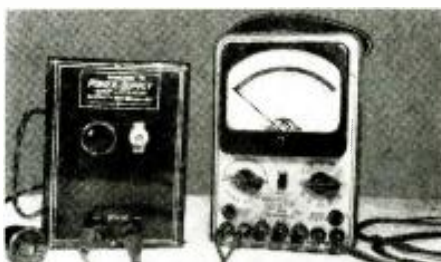

The voltage supply and a 90-volt ohmmeter.

scale range of the meter movement. This can usually be judged from the voltage ratings: a 1,000-ohm-per-volt multimeter has a 1-ma movement; a 10,000-ohm-per-volt unit has a 100- μ a movement; and so on.

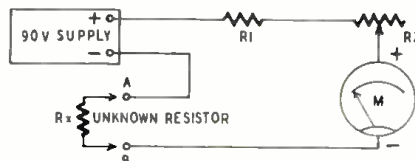

Fig. 2—Circuit of high-resistance ohmmeter.

The circuit is shown in Fig. 2. R1 plus R2 equals the total series resistance which, when the test prods are shorted, will give a full-scale meter reading. If the meter has a 1-ma movement,

$$R = \frac{E}{I} = \frac{90}{.001} = 90,000 \text{ ohms}$$



The panel shelf makes construction easier.



3 Great
Mail Centers
To Speed Orders

LAFAYETTE-CONCORD

ELECTRO NEWS

29 Years of Service—500,000 Satisfied Customers

NEW L. C. CATALOG ELECTRIFIES RADIO MEN

THE BARGAIN COUNTER

Here's your chance to pick up some of the latest developments at big money savings. Every one a bona-fide "buy":



UNBELIEVABLE VALUE IN A 10" SPEAKER

Grab up a couple at this amazingly low price. They're top quality 10" PM speakers. 4.8 oz. Alnico V magnet. Voice coil impedance 3.2 ohms. Up to a booming 8 watt capacity. Ideal extra speaker for radios, public address, etc.

\$345

No. 99N7019R Lots of 3 . . . \$3.25 ea.—Lots of 6 . . . \$3.10 ea.

MICROGROOVE PICK-UP FOR NEW LP RECORDS

SPECIAL!



SPECIAL!

For the new long-playing records, crystal phono pickup for reproduction of lateral cut long playing microgroove records at 33 1/2 rpm. Excellent frequency response for voice and music. Output voltage approx. 1 volt. Extremely low tracking force. No. 99N3577R. Wt. 12 oz.

\$495

THIS IS IT! NEW VM DUO SPEED CHANGER!



FOR NEW 33 1/2 AND STANDARD 78 RPM RECORDS

Four hours' continuous entertainment with a stack of 33 1/2 rpm. records; one hour continuous play at 78 rpm. (Takes both 12" and 10" records. Intermixed.) Universal dual speed motor. Quick, quiet-changing cycle, takes less than 4 seconds. Automatic shut-off, single tone arm returns to rest and mechanism shuts off after last record. Precision testing insures perfect performance—no adjustments. Dual needle reversible cartridge; single speed control. Mounting space: 13 1/2" wide; 12 1/4" long; 7 1/2" high.

\$3322

No. 34N22563R—same as above, mounted in handsome walnut and maple base, \$34.99

MADE TO SELL FOR \$14950 NOW AN AMAZING \$5995

TROPICALIZED



7 BAND RECEIVER

COVERS: 540-1725 kc and 1.8-5.8; 5.8-15.5; 17.1-22.2; 14.5-17.1; 11.17-12.2; 9.28-9.8 mc. 8" PM dynamic speaker delivers an undistorted 4.5 watt output. 3 gang condenser. RF stage. Supersensitive. 110-220 V. AC. Guaranteed foreign reception. Beautifully finished cabinet. All heavy duty components. Quantity limited so rush your order. 13 1/2"x26 1/2"x11 1/4". 35 lbs. No. 1N811R

\$5995

idea of the year



PORTABLE BICYCLE RADIO

Battery operated. Can be easily mounted or carried as a personal. Supplied complete with all bicycle mounting hardware and telescopic antenna which plugs into radio. Slide rule dial. Vernier tuning. Full size Alnico #5 speaker. Operates on inexpensive flashlight cells and standard 67 1/2 volt "B" battery. Attached handle. Lightweight. Case beautifully finished. Anti-theft feature. 7 1/4"x4 1/4"x3 1/4". Weight: 3 lbs., 3 oz. No. 1N420R

\$1995



CO-AX HI-FI SPEAKER

Ideal for quality FM-AM receivers. 15" dual speaker system with built-in frequency network. Tweeter and woofer reproduce entire audible range with magnificent realism. With built-in load resistor. 8 ohm input impedance. No. 99N7014R—24 lbs.

\$3495

SPECIAL BULLETIN

Don't miss getting copies of our two new Free bulletins. One on TV, the other a Christmas Gift Catalog. Both will save you money! The Xmas book's a real eye-opener . . . full of unusual ideas and grand values. Send the coupon.

Economy-minded hams, set builders, service men overwhelmed by giant new book! "Never saw anything like it!" . . . "As good as money in the bank!"—typical comments.

Law Upholds Landlord on TV Antennae

Under the law, landlords appear to be within their rights in refusing permission for erection of antennae by apartment tenants. They may ban aerials entirely, or give permission to some residents and bar others, without being held answerable to those who are denied this favor. Courts have held that the rental of an apartment does not give the lessee any proprietary right to attach any equipment to a roof or the other exterior parts of a building.

The property owner also is held to be within his rights in removing an aerial which has been set up without his permission, provided he takes the precaution of returning the equipment intact to the tenant in his building.

Listen—how would you feel if you opened your mail box this A.M. and found an envelope stuffed with crisp new fives and tens? That's how veteran bargain hunters react when they open their copies of the giant new Lafayette-Concord 1949 Catalog, now in the mails!

IT'S THE NEXT BEST THING TO A BANKBOOK

180 pages solidly crammed with sensational "buys" made possible by the purchasing power of the largest radio supply organization in the world—plus everything in famous brands! There's hardly a page without some real "find" in TV, Hi-Fi, Ham, AM & FM Radios, P.A., Test Equipment, Parts, Tools, etc.

IDEAL, USEFUL GIFT



NEW 33 1/2 RPM PLAYER

Get several for the top names on your Xmas list. Sure to make a hit; everyone wants it; practically no one has it yet. 33 1/2 rpm. motor (110 volts, 60 cycle) for sensational long-playing records. Webster microgroove pick-up, with life-long needle. Portable cabinet covered with simulated leather, handsomely lined. Plays 12" record with cover closed. R.C.A. phono jack with 5' cord, to plug into radio. No. 34N22677R

\$1695



EVERY DAY YOU LET GO BY WITHOUT THIS CATALOG IS COSTING YOU HARD CASH!

海外顧客
OVERSEAS CUSTOMERS
CLIENTES DE ULTRAMAR
Send your communications
Attention Export Division

RUSH THIS COUPON AT ONCE FOR YOUR FREE CATALOG

SHOP IN PERSON AT ANY ONE OF OUR OUTLETS:
NEW YORK
 100 Sixth Avenue
 542 E. Fordham Rd., Bronx
CHICAGO
 901 W. Jackson Blvd.
 229 W. Madison St.
ATLANTA
 265 Peachtree St.
BOSTON
 110 Federal St.
NEWARK
 24 Central Ave.

Lafayette-Concord Dept. JK-8
 901 W. Jackson Blvd., Chicago 7
 100 Sixth Avenue, New York 13
 265 Peachtree St., Atlanta 3

Please rush Free catalog No. 89
 Send Free Xmas Gift Catalog
 I enclose \$_____ Please fill attached order: Shipping charges extra.

NAME _____
 ADDRESS _____
 CITY _____ ZONE _____ STATE _____

LAFAYETTE-CONCORD

the world's largest radio supply organization

TUBE PIN STRAIGHTENER

Hytron Radio & Electronics Corp.
Salem, Mass.

This miniature-tube pin straightener takes care of nine-pin tubes and is a companion device to this company's seven-pin straightener. Miniature-tube pins are actually thin wire extensions of the tube elements and are easily misaligned, sometimes making the tube useless. The straightener can be screwed to the bench. Each tube is inserted in it before being plugged into its socket.



BICYCLE RADIO

Trin Radio Co.
Brooklyn, N. Y.

Attachment devices are offered for cyclists who like to listen to a radio en route. The devices are clamped to the handle bars and will hold battery receivers of any height and measuring up to 7/8 inches in length and 6 inches in width. The brackets absorb shocks, preventing damage to the set.

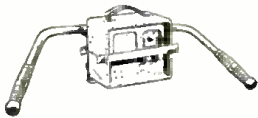

OSCILLOSYNCHROSCOPE

Browning Laboratories, Inc.
Winchester, Mass.

Model OL-158 Oscillosynchroscope is a new laboratory instrument for observation of transient and recurrent phenomena involving wide ranges of frequencies. A 5-inch cathode-ray tube with 4,000 volts accelerating potential provides excellent intensity and definition of images.



Other features include a vertical amplifier band width of 6 mc, recurrent sweeps of from 5 to 500,000 per second, and driven sweep rates of 0.25 microsecond per inch to 200 microseconds per inch. An internal trigger generator is also provided, as well as a variable delay circuit which may be used to provide delayed triggers or a delayed sweep either internally or externally triggered. A calibration device provides measurement of deflection sensitivity through the amplifier.

The vertical amplifier, which is linear without positive slope from 10 cycles to 6 mc, has a transient response such that a 100-ke square wave which rises or falls at the rate of 500 volts per microsecond is faithfully reproduced.

ISOLATION TRANSFORMER

Radio Corporation of America
Camden, N. J.

The Isotap variable-voltage isolation transformer is designed for the service-

man, but it can also be used in homes where line voltage is too low or too high for proper radio or television chassis operation.

A tap switch may be set for the available line voltage. Three a.c. output receptacles are provided: LOW, ME-



DIUM, and HIGH. These provide 105, 117, and 130 volts, respectively. The serviceman can use the low voltage to test oscillator stability and the high voltage to "pop" components which are ready to fail. In all cases, the unit adds to working safety when repairing a.c.-d.c. equipment.

DISC RECORDER

Risco Electronics
New York, N. Y.

Records may be made at either 78 or 33 1/3 r.p.m. with this portable unit. A swinging-arm-type cutting mechanism is used. The recorder includes a recording and playback amplifier, a crystal microphone, and a 6-inch speaker.



TV-FM ALIGNER

Philco Corporation
Philadelphia, Pa.

Model 7008 precision visual-alignment generator for television and FM contains in one instrument all the generators and indicators necessary to adjust FM and TV receivers. The basic unit is a 4-120-mc FM generator with sweep adjustable up to 15 mc. An AM generator tunable from 3.2 to 250 mc can be used by itself or as a marker for the FM and TV alignments. A crystal calibrator provides check points every 5 mc to maintain the reset accuracy of the generators. The AM oscillator can be modulated by the internal 400-cycle a.f. generator to produce a modulated test signal.

Above the generators on the same panel is a 3-inch cathode-ray tube with its controls. This oscilloscope unit is operated from the same power supply as the generators. Sensitivity of the 'scope circuit is better than 25 mv per inch (vertical). Phasing and blanking controls are included on the same metal panel.



Output is controlled by a shielded attenuator. To compensate for the loss in gain usually present at the higher frequencies, output of all generators increases about five times at the high frequencies over that at the low end of

the range, giving fairly constant output at all frequencies.

SQUARE HOLE CHASSIS PUNCH

Pioneer Broach Co.
Los Angeles, Calif.

This chassis punch operates on the same principle as the familiar tube-socket punches made by Greenlee and others. A hole is drilled in the metal to accommodate the cap screw. The die and the punch are placed on opposite sides of the metal and screwing down the bolt makes the punch go through the metal, cutting out a clean square hole to accommodate transformers or other rectangular components.

Any shape of hole having square corners may be cut out with the new punch. It is offered at present in two sizes, 3/8 and 1/4 inch.



TWO-SPEED PHONO TABLE

Alliance Mfg. Co.
Alliance, Ohio

The new two-speed turntable is designed for playing Columbia Microgroove records as well as ordinary phonograph discs. A dual version of this manufacturer's Model 80 table, the unit uses two motors, one for each speed, a single lever controlling both speeds. It has a center off position, in which both motor shafts are disengaged from the idlers to prevent flats from developing on the idlers and causing wows.

MULTITESTER

Triplett Electrical Instrument Co.
Bluffton, Ohio

Model 630 volt-ohm-milliammeter has six d.c. voltage ranges at 20,000 ohms per volt and six a.c. ranges at 5,000 ohms per volt. Top voltage on each is 6,000. Five d.c. ranges are included, the lowest 60 μ a full scale and the highest 12 amperes. Resistance up to 100 megohms and -30 to +30 decibels may be measured.



AUDIO OSCILLATOR

General Electric Co.
Syracuse, N. Y.

The YGA-4 audio test generator is intended primarily for the serviceman. The entire range from 25 to 16,000 cycles is covered in one band. Output has low distortion and is constant at any setting of the volume control within ± 1 db over the band.

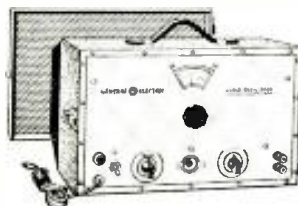

TV ALIGNMENT MARKER

Vision Research Laboratories
Richmond Hill, N. Y.

Model TM-100 is an absorption trap which can be used with any visual-align-



ment generator as a marker. Instead of the usual pip on the 'scope screen, a small dip appears on the curve. The unit uses no power and is hand-calibrated. Frequency range is from 9.5 to 28 mc.

DUAL CLIP

Mueller Electric Co.
Cleveland, Ohio

The new No. 22 Twin-Clip has two jaws, one at each end, as well as a screw terminal in the center. It can be used to connect two pieces of wire temporarily or to connect a lead to two or more other leads for test and experimental purposes. The spring is in the center and both jaws may be opened at once by squeezing the spring. Squeezing the clip at either end causes only one set of jaws to open, without disturbing the other. The Twin-Clip is made of cadmium-plated steel.

SPEECH CLIPPER

Electro-Voice, Inc.
Buchanan, Mich.

Model 1000 speech clipper is a diode unit designed to increase the effective output of a transmitter without exceeding 100% modulation. As much as 20 db

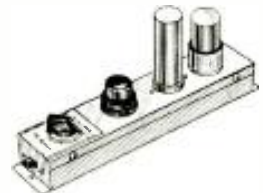

of clipping can be accomplished. A low-pass filter attenuates the harmonics created by the clipping action. A 6SC7 and a 6H6 are used. B-plus (150 volts at 5 ma) and 6.3 volts at 0.6 amp for the filaments must be furnished from an external supply.

BATTERY TESTER

Chicago Industrial Instrument Co.
Chicago, Ill.

Batteries of any voltage from 1.5 to 150 may be tested with Model 471 battery Merchandiser. The battery is tested under the recommended load. A 5 1/2-inch meter is divided into three regions: NEW, USEFUL, and REPLACE.



REACHING TOOL

Emco Enterprises
Chicago, Ill.

Flex-o-pic is a flexible tool for picking up small parts in hard-to-reach locations. It uses flexible cable of the type employed in speedometers and which can be furnished in any length. A claw at one end, operated by a button at the other end, picks up small objects.

The unit may be taken apart for cleaning. It is chromium-plated and acid-proof.

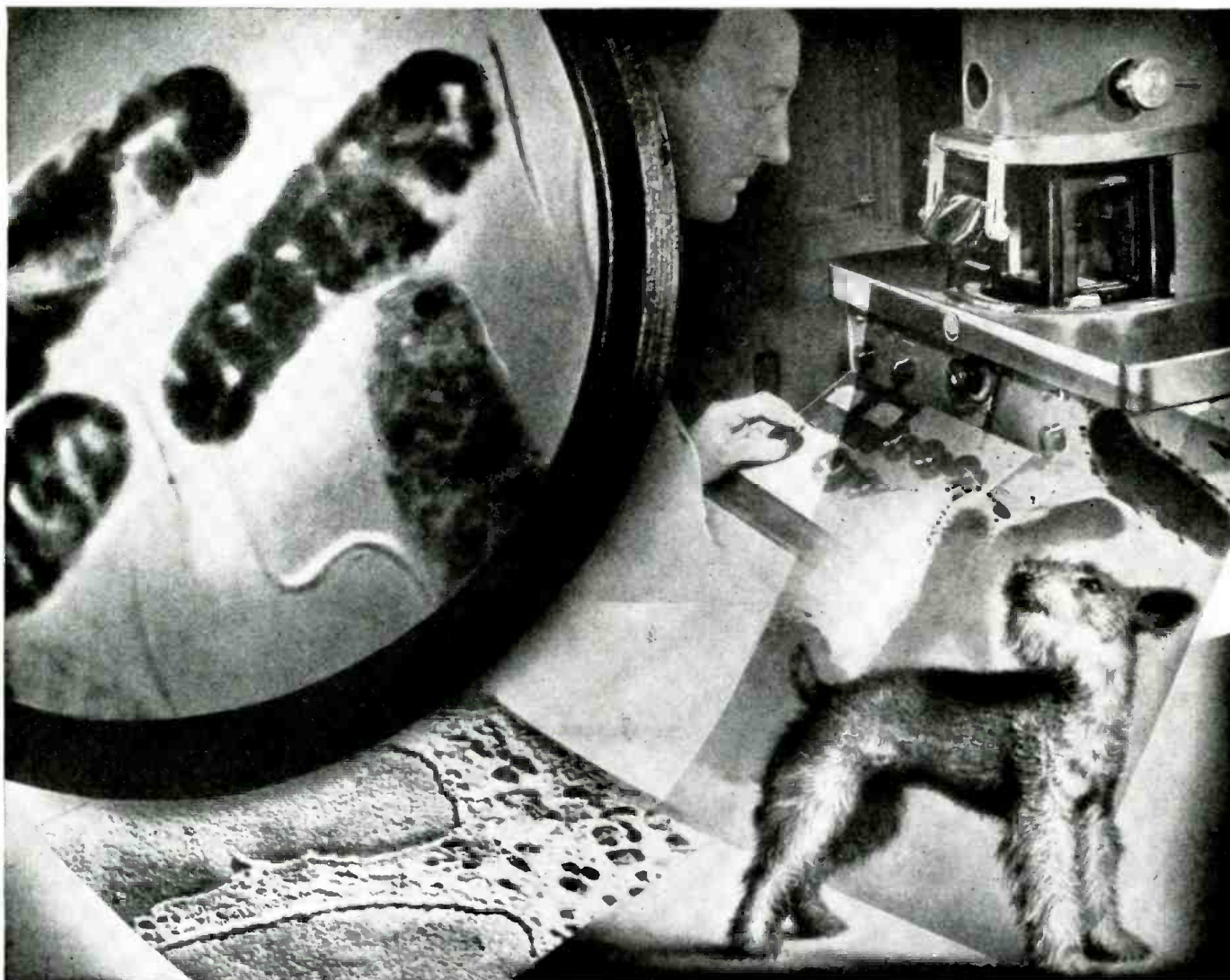

Electron microscope, perfected at RCA Laboratories, reveals hitherto hidden facts about the structure of bacteria.

Bacteria bigger than a Terrier

Once scientists, exploring the invisible, worked relatively "blind." Few microscopes magnified more than 1500 diameters. Many bacteria, and almost all viruses, remained invisible.

Then RCA scientists opened new windows into a hidden world—with the first commercially practical electron microscope. In the laboratory this instrument has reached magnifications of 200,000 diameters and over. 100,000 is commonplace . . .

To understand such figures, pic-

ture this: A man magnified 200,000 times could lie with his head in Washington, D. C., and his feet in New York. . . . A hair similarly magnified would appear as large as the Washington monument.

Scientists not only see bacteria, but also viruses—and have even photographed a molecule! Specialists in other fields—such as industry, mining, agriculture, forestry—have learned unsuspected truths about natural resources.

Development of the electron

microscope as a practical tool of science, medicine, and industry is another example of RCA research at work. This leadership is part of all instruments bearing the names RCA, and RCA Victor.

. . .

When in Radio City, New York, you are cordially invited to see the radio, television and electronic wonders at RCA Exhibition Hall, 36 West 49th Street. Free admission. Radio Corporation of America, RCA Building, Radio City, New York 20.



RADIO CORPORATION of AMERICA

Here's a
SENSATIONAL BUY!

**COMBINATION
INTERCOM & RADIO**

Customers Say—

"Intercom alone is worth your low price. You get free a 6 tube radio in this deal plus real utility!"

A REAL MONEY
MAKER FOR YOU



Intercom Sub-Station Master Intercom Station, Including 6-Tube Radio

Combines a top-quality 6 tube superhet receiver, plus office or home intercom system in handsome walnut-veneer cabinets. Hi-Amplification 3 tube intercom permits instant communication between radio-master and up to 4 remote sub-stations. Any remote station can call the master while radio is playing; call can be returned to any remote station. Operates on 110 volts AC or DC.

It's handsome—It's easy to install—It's easy to use!

Price includes Radio Master, 1 Remote, 50' wire

Original retail price was \$84.50 with 4 remotes. Buy from RSE and SAVE OVER 50%.

Brand new—only 400 available.

\$29⁹⁵

Extra Remotes—\$3.95

MIDGET I.F. TRANSFORMERS

Back again—by popular demand!



RSE scores again with a new and better I. F. I. 400-500 KC range—1 1/4" square x 3" high—ceramic based mica trimmers—high gain iron cores—pep up old receivers, ideal for new construction—and now available in either input or output types—for peak performance! Individually boxed in the colorful RSE carton. List price \$2.10. LR1—input; LR2—output;

Specify Type.

Each	Matched Pair	Dozen	Egg Crate of 100
36c	69c	\$3.95	\$29.00



VOLUME CONTROLS

• Our own private brand—made by a nationally known manufacturer. • The same kind that net for \$1.09. • Noise-free carbon construction, standard shaft and bushing. • Individually boxed in our colorful carton carrying the RSE equality seal of approval. • Complete with switch, full range of sizes.

10 M ohms	100 M ohms	each	59c
15 M ohms	250 M ohms		
25 M ohms	500 M ohms	per 10	\$5.50
50 M ohms	1 Meg ohms		
2 Meg ohms		asstd.	
500 M Knurled Shaft			
500 M ohms less switch, 39c each, 100 for \$35.00			

TUBES

"The All-American Five"

Here they are—the fastest movers ever made—at RSE's long discount. Brand new, tested top-grades with regular RMA guarantee. Individually boxed in eye-appealing cartons. Know your supplier—his reputation. Shoot us an order today—watch your profits zoom tomorrow!

125A7GT...65 125K7GT...65 125Q7GT...59
35Z5GT...49 50L6GT...65

"All-American Kit", one each of above... \$2.98



ORDER INSTRUCTIONS

Minimum order—\$2.00. 25% deposit with order required for all C.O.D. shipments. Be sure to include sufficient postage—excess will be refunded. Orders received without postage will be shipped express collect. All prices F.O.B. Detroit.

Demand This Seal of Quality

RADIO SUPPLY & ENGINEERING CO., Inc.
85 SELDEN AVE. DETROIT 1, MICH.

SIGNAL TRACERS ARE POPULAR

(Continued from page 56)

not obtainable, the time spent in winding them with a high-value carbon resistor as a form, well repays the trouble. (Winding 4,700- and 15,000-ohm resistors with resistance wire is not too easy, and the likelihood of any constructor's getting the same residual inductance and capacitance values as those in the author's instrument seem fairly remote depending pretty much on accident. Possibly ordinary carbon resistors could be used with small r.f. chokes in series.—Editor)

An excellent indicator

The 6E5 has proved itself an excellent detector. It is especially useful in one instance where other indication devices would be more or less useless—on a weak unmodulated carrier provided by the local oscillator of a superheterodyne receiver. It is obviously impossible to detect by ear whether a local oscillator is oscillating; but, by placing the r.f. prod of the tracer on the plate of the oscillator, a clear indication can be obtained from the 6E5 by the partial closing of the eye. Naturally, the response of the eye is not as great as it would be normally, but it is sufficient for the purpose.

It is essential that stray pickup should be guarded against, and therefore metal 6J7 and rectifier tubes should be used. If possible, an open-ended shield can should be placed round the 6E5.

The instrument is built on a chassis inside a 6 x 7 x 10-inch metal cabinet.

Fig. 2 shows the probes. Notice that the shielding is made continuous from the probe tip to the tracer jack by bonding the probe case to the cable shielding.

This tracer has been found extremely useful on outside service jobs, on account of its lightness and portability. Its weight is little more than that of the average battery-operated multi-range meter.

A bigger instrument

For bench work, a much more elaborate instrument is used. The circuit is shown in Fig. 3.

As a bench analyzer may frequently be used to trace very weak signals, considerable r.f. gain is advisable. Two r.f. stages are incorporated, both of them being resistance-capacitance-coupled and having the r.f. gain control in the common cathode leads. These are followed by a cathode-follower detector, chosen for its signal-handling properties, high fidelity, and minimum damping effect upon the previous stage. The signal is then passed on to a 6C5 audio amplifier (into which the a.f. prod is fed), and finally into a 6V6 output stage.

Notice that two terminals have been connected to the voice-coil leads for insertion of an external a.c. voltmeter which can be used as a visual indicator.

Bonding between chassis and panels and all other shielding must be thorough

if the instrument is to be a first-class job.

Operating the tracer

The tracer is easy to operate. When using the r.f. probe, the a.f. gain control should be kept at maximum, and any adjustment of gain should be made on the r.f. gain control in order to keep tube noise to a minimum. When using the a.f. probe, the r.f. stages are not in use and the gain control may be turned down. While not essential, this will make for a clearer signal.

Let us suppose that the receiver under test has poor quality. The first thing is to tune in a local station or inject a signal from a generator into the antenna terminal of the receiver. The second is to silence the receiver's speaker as we shall be using that in the tracer. Probably the best way to silence the speaker is to disconnect the speaker transformer secondary and replace the voice coil with a load resistor. In that way no damage can be caused to the output tube or transformer.

Now by placing the r.f. probe on the various grids and anodes the signal can be made to appear in the tracer's speaker. If no fault is apparent up to the second detector, change over to the a.f. probe. Once the faulty section has been found, the bad component can often be determined by injecting a signal at various points of the input to the tube and using the probe.

Occasionally a receiver will be found in which the signal, if there at all, is so weak as to be inaudible on its own speaker. In such cases, if the signal is not audible when the r.f. probe is placed on the first detector plate, it can be assumed that the local oscillator is not functioning, and checking can be done on that basis. On the other hand, although the signal is strong at the receiver input, it may arrive at the speaker distorted and weak. Tracing through with the instrument, a stage will be reached at which there is a marked diminution in the gain. Some measure of the actual loss can be secured by rotating the r.f. gain control and noting how much rotation is needed to bring the signal back to its former strength.

With experience the operator will rapidly become familiar with these and many other faults indicated by the tracer and will find that it is one of the handiest bits of gear any service technician can possess.

There are four rules to remember when using a signal tracer: (1) Always see that the power pack of the receiver on test is O.K. before switching on. (2) Always start tracing from the antenna end of the receiver and proceed toward the output stage. (3) When using the probe, keep the a.f. gain control at maximum, and regulate volume with the r.f. gain control. (4) When using the a.f. prod, turn the r.f. gain control to minimum.

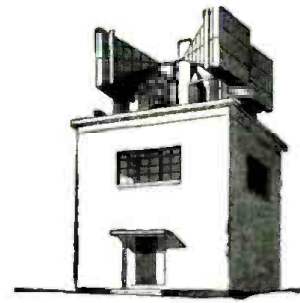

Pipe Circuits

UNLIKE radio broadcast waves, microwaves are too short to be handled effectively in wire circuits. So, for carrying microwaves to and from antennas, Bell Laboratories scientists have developed circuits in "pipes," or waveguides.

Although the waves travel in the space within the waveguides, still they are influenced by those characteristics which are common to wire circuits, such as capacitance and inductance. A screw through the guide wall acts like a capacitor; a rod across the inside, like an inductance coil. Thus transformers, wave filters, resonant circuits — all have their counterpart in waveguide fittings. Such fittings, together with the connection sections of waveguide, constitute a waveguide circuit.

From Bell Laboratories research came the waveguide circuits which carry radio waves between apparatus and antennas of the New York-Boston radio relay system. As in long distance wire communication, the aim is to transmit wide frequency bands with high efficiency — band widths which some day can be expanded to carry thousands of telephone conversations and many television pictures.

Practical aspects of waveguides were demonstrated by Bell Telephone Laboratories back in 1932. Steady exploration in new fields, years ahead of commercial use, continues to keep your telephone system the most advanced in the world.

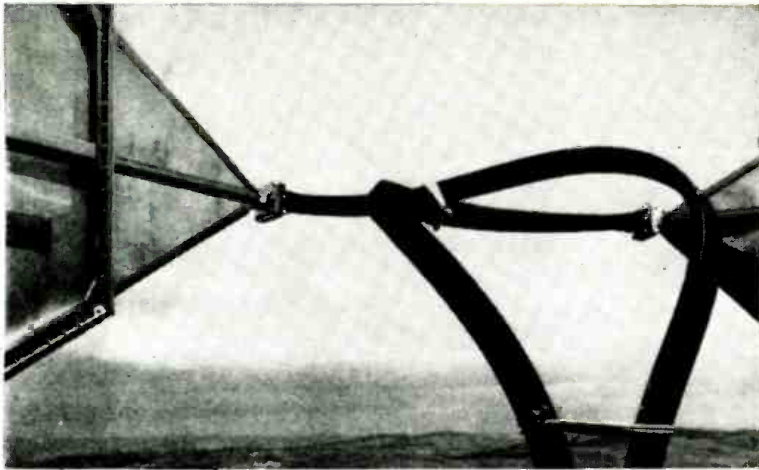

3 The waveguide connects with antennas, which are oriented in azimuth with antennas at next station. At right is complete repeater station.

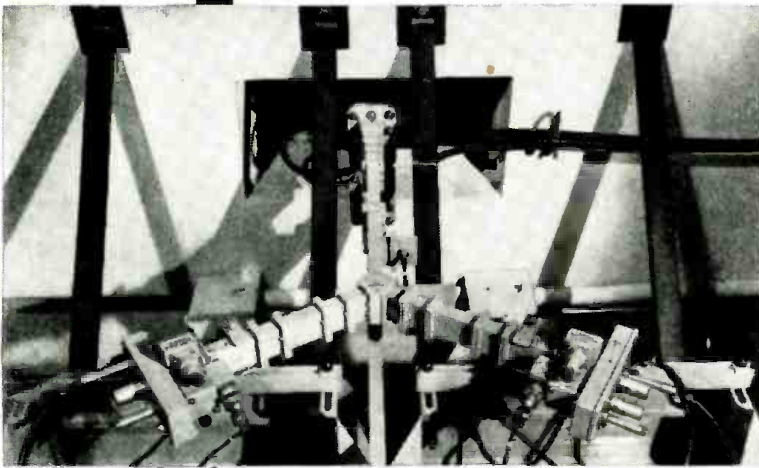

2 The waveguide continues upward through the roof of the station toward the antennas.

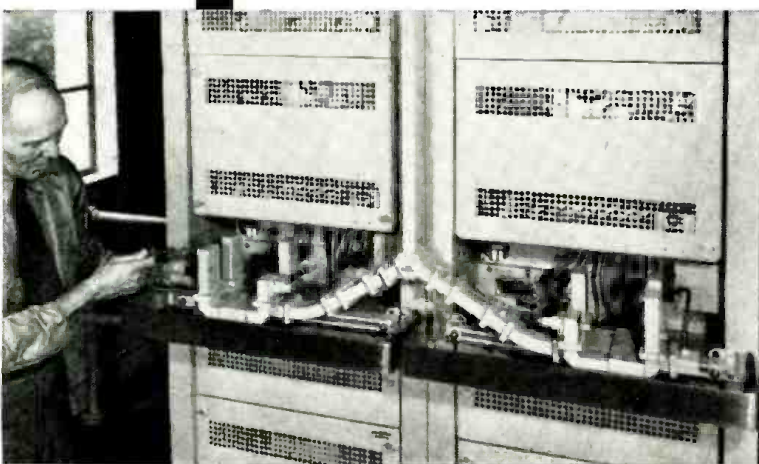

1 Base of a waveguide circuit in a repeater station of the New York-Boston radio relay system.

BELL TELEPHONE LABORATORIES

EXPLORING AND INVENTING, DEVISING AND PERFECTING FOR CONTINUED IMPROVEMENTS AND ECONOMIES IN TELEPHONE SERVICE.



Buy HEATH SURPLUS Now!

ALL QUANTITIES LIMITED SUBJECT TO PRIOR SALES

APN/1 RADIO ALTIMETERS



\$34.50

NO. 200. The last chance to get a complete new 14 tube radio altimeter. Contains 420 Mc. transmitter and receiver, power supply, range switches, two antennas, meter indicator, all plugs and instruction manual. This unit makes excellent amateur station as it is right in the band. Shipped in original export crate. Weight 87 lbs.

G.E. BC 375 TUNING UNIT

NO. 203. Model TU108 covers 10 Mc. to 12.5 Mc. New complete with aluminum cabinet. The best buy of surplus. Over \$30.00 worth of new variable condensers, coil, dials, switches, etc. Add postage for 20 lbs.



\$2.49

G.E. 50 AMP CIRCUIT BREAKER
NO. 204. New General Electric 50 Amp 220 Volt AC circuit breakers. 100 Amp when used on 110V. Add postage for 4 lbs.



\$2.95
EACH
3 FOR
\$7.50

BC 347 AIRCRAFT INTERPHONE AMPLIFIER

NO. 205. Interphone amplifier contains 6F8 tube, Oncer transformers, diagrams, etc. in aluminum cabinet. Add postage for 4 lbs.



\$2.95

274N COMMAND SET ACCESSORIES



NO. 238. 5" PM Speaker with output transformer matching telephone output. \$2.80
NO. 239. Dual receiver rack FT277A with connecting plugs. \$1.00
NO. 240. Single transmitter rack FT234A. \$1.00
NO. 241. Spline shaft for tuning command receivers. Allows use of regular tuning knob on BC 453-45 receivers. \$.39

BC 451 CONTROL BOX
NO. 236. Control box for 274N transmitters. Contains proper cw-voice switch, 4 channel switch, power switch, mike jack and telegraph key. Add postage for 2 lbs. \$1.95

METER SPECIAL

NO. 237. Brand new DeJur Model 312 0-800 M.A. D.C. Square 3" 0-10 M.A. basic meter with built in shunt. Probably the best buy ever offered in a surplus meter. Shipping Weight 1 lb. \$2.95



A-62 ARMY PHANTOM ANTENNA



NO. 206. Contains tuning condenser, coil, resistors, tuning dial, tuning indicator, binding posts, steel case, useful for building amateur transmitter. Add postage for 8 lbs. \$1.95

BENDIX MR9C COMPASS CONTROL UNIT

NO. 207. Tuning and control unit for Bendix MN 26 radio compasses contains tuning dial, band switch, crystal switch, AVC switch, volume control, fuses, phone jacks, etc. Shipping Weight 5 lbs. \$9.50



BC731 CONTROL BOX



with Weston Model 476 AC Voltmeter
NO. 208. Excellent buy in motor control box. Size 8" x 10" x 5 1/2". Contains Weston 0-150V. AC 3 1/2" voltmeter, motor starting switch, 28 fuses all 30 Amp 110V. and 8 fuse holders. Fuses and holders alone worth the price. Shipping Weight 18 lbs. \$7.95

BC 645 GENERAL ELECTRIC TRANSCEIVER



NO. 201. Complete 15 tube transmitter-receiver. Ideal for new citizens band 460 Mc. for communication between office and car, home, boat, etc. Conversion article in August ELECTRONICS Magazine. Brand new in original G.E. cartons with tubes. Add postage for 25 lbs.

\$19.50 ... 2 for \$35.00

ACCESSORIES FOR BC 645
PE101C Dynamotor for car use \$ 3.95
110V 60 Cycle Power Supply for home or office use... \$14.50

T32 TABLE MICROPHONE

NO. 210. One of the Army's best. Built by Kellogg, ideal for factory call system, public address, amateur use. Brand new in original cartons. Add postage for 5 lbs.



\$2.95

MINIATURE ELECTRIC MOTOR



NO. 211. Tiny Delco motor only 1" x 1 1/4" x 2". 10,000 RPM. Operates from 6 to 24 V. Excellent for models. Add postage for 1 lb.

\$2.95

P. E. 103

DYNAMOTOR

NO. 212. Dynamotor only from PE 103 power supply. Input 6 or 12 Volts, output 500 Volts at 160 MA. Brand new original cartons. Shipping Weight 29 lbs.



\$5.95



G. E. 1000 VOLT 350 MA DYNAMOTOR

NO. 213. An ideal dynamotor for mobile operation in taxicabs, police cars, sound systems and amateur stations. Supplies above voltage from 12 Volts or 500V. at 350 MA from 6 Volts. Complete with starting relay, and fuses. New. Our Dynamotor A. Shipping Weight 72 lbs.

\$5.95

DM-36 DYNAMOTOR

NO. 215. Western Electric 24 Volt input, 220V. at 60 MA out. With filter assembly. Shipping Weight 6 lbs.

\$2.95

G. E. BC 306 ANTENNA TUNING UNIT



NO. 231. Matches any aerial to 150 Watt transmitter, used on BC 375. Brand new. Add postage for 20 lbs. \$2.95

W.E. BC456 MODULATOR

NO. 217. Modulator from 274N command transmitters contains 3 husky relays, 3 tubes, VR150, 12J5 and 1625. Brand new. Add postage for 11 lbs. \$3.95



\$3.95



BE 77 TELETYPE TEST SET

NO. 218. Contains zero center volt-milliammeter, switches, relays, voltage divider resistors, neon indicator, etc. Excellent foundation for radio tester. Shipping Weight 10 lbs.

\$7.95

BENDIX MN 20E DIRECTION FINDER LOOP

NO. 219. Ring type loop excellent for use on boat or aircraft. Extremely rugged construction. Low impedance manual type. Add postage for 8 lbs. \$9.95 EACH



LP 18C DIRECTION FINDER LOOP

NO. 220. Motor driven streamline pod type loop used on automatic direction finders. Has Selsyn transmitter and motor, fits most military direction finders. Add postage for 20 lbs. \$14.50 EACH

KIT SPECIALS

POTENTIOMETERS
NO. 232. Kit of 10 excellent shaft type potentiometers good variety \$1.95

SOCKETS
NO. 233. Kit of 20 high quality sockets several different types \$1.00

RCA NAVY COMMUNICATION RECEIVER

NO. 202. The last of these beautiful RCA sets. Covers 195 Kc. to 9.1 Mc. continuously. Supplied complete with tubes, control box, tuning unit, 24 Volt dynamotor, band change motor, plugs and circuit diagram. Superheterodyne circuit covers aircraft, broadcast, short wave, marine, foreign broadcasts. Has sharp air broad I.F.'s B.F.O., etc. Shpg. Wt. 30 lbs.



\$29.50



PE 125 TRANSMITTER POWER SUPPLY

NO. 223. Operates from 12 to 24 Volts and supplies 500 Volts at 160 MA. Extremely rugged construction used in Army tanks. Complete with fuses - relays - filters, etc. Ideal for boats. Shipping Weight 73 lbs.

\$12.95

FM PUSH BUTTON TUNER

NO. 224. Brand new ten push button tuning assembly from Army FM receiver. Contains 4 gang 100 MMF silver plated tuning condenser. Add postage for 10 lbs. \$2.50 EACH



RG 8/U FLEXIBLE COAXIAL CABLE

NO. 225. Standard television lead in 52 ohm. Any length up to 1,000 ft. Add postage.

4¢ PER FOOT

POWER TRANSFORMER Specials



NO. 226. Primary 117V. 60 cycle. Secondaries supply 746 V. CT at 220 MA, 6.3V. at 4.5 A., and 5V. at 4A. Will handle 13 tube radio receivers. Supply is limited, order early. Shipping Weight 11 lbs. each. \$3.95 ... 3 for \$9.95

OUTPUT TRANSFORMER

NO. 227. Push pull 6V6's to 6-8 ohm voice coil excellent characteristics. 3 for \$1.95



TRANSFORMER TRANSFORMER



NO. 228. The transformer for Transmitter Power Supply, 600 Volt at 200 MA and 4 Amp. filaments of 3 to 24 Volts. Also 5 Volts at 4 amperes for rectifier. Shipping Weight 12 lbs. \$9.50

MILITARY POWER TRANSFORMERS

NO. 229. Convert your military receivers without rewiring the filament. "A" type supplies 500 VCT at 50 MA, 5V. at 2A. and 24V. at 1/2 A. "B" type supplies 500 VCT at 50 MA, 5V. at 2A. and 12V. at 1 Amp. State whether A or B type desired. Shipping Weight 4 lbs. \$2.95



HOME WORKSHOP GRINDER KIT

NO. 230. Easily assembled 110V AC or DC ball bearing fully enclosed motor from Army surplus dynamotor. Purchaser to make simple changes and shaft extensions, detailed instructions and all parts supplied. Motor approximately 5,000 R.P.M. Ideal for tool-post grinder, flexible shaft tool, model drill press, saw. Shipping Weight 6 lbs. \$3.95



HEARING AID HEADPHONES

NO. 216. The Army's best - eliminate flat ears and outside noise. Complete with transformer for conversion from low to high impedance. With cord and plug complete. Add postage for 1 lb. \$1.00

TELEVISION CONDENSERS

NO. 221. Tobe triple .2 MFD 4000 V.D.C. Filter used on Army radar. Ideal filter for H.V. television set. Add postage for 3 lbs. \$3.95
NO. 222. G.E. Pyranol capacitor .25 MFD 6000 V.D.C. Porcelain insulated, an outstanding buy for high voltage filters. Add postage for 3 lbs. \$3.95

HOW TO ORDER • • • GIVE PART NUMBER AND DESCRIPTION • • • ADD POSTAGE FOR WEIGHT SHOWN. NO ORDERS UNDER \$2.00 • • • WE WILL SHIP C.O.D.

The HEATH COMPANY
DEPT. C . . . BENTON HARBOR, MICHIGAN

ELECTRONIC BARGAINS for EXPERIMENTERS and HOBBYISTS

ALL QUANTITIES LIMITED SUBJECT TO PRIOR SALES

STANCOR FILAMENT TRANSFORMER
 NO. 242. Heavy duty Stancor No. ST355 supplies 5V at 6 Amps, 5V at 3 Amps and 5V at 3 Amps from 220V 60 Cy. primary or 1/2 above from 110V. Cased type. Ship. **\$1.50**
 Wgt. 7 lbs. Each

G.E. THYRATRON TRANSFORMER
 NO. 243. New G.E. Transformer supplies 2.5V at .100 KVA, has 3KV insulation 100V 60 cy. primary. Shipping Wgt. 13 lbs. Each **\$9.50**

RCA SATURABLE REACTOR TRANSFORMER
 NO. 246. New RCA No. CRV30531 AC current 750 MA DC current 2 Amperes. Rated 1.75 henries. Shipping wgt. 4 lbs. Each **\$1.00**

12.6V POWER TRANSFORMER
 NO. 247. New cased 110 V 60 cy. Power Transformer. Supplies 440V Ct. at 60 MA, 6.3V at 2A, and 12.6V at 1 Amp. Excellent for military sets. Shipping Wgt. 6 lbs. Each **\$1.95**

RCA INPUT TRANSFORMER
 NO. 248. Heavy duty RCA No CRV-30529. Input has primaries 600 to 200 and 25 ohms secondary 250,000 ohms C.T. Shipping Wgt. 2 lbs. Each **\$1.00**

REPLACEMENT POWER TRANSFORMER
 NO. 251. Excellent value transformers made by one of largest transformer companies. 110V 60 cy. Primary supplies 746 V Ct. at 150 MA, 5V at 4A and 6.3V at 4.5 Amps. Shipping Wgt. 7 lbs. Each **\$2.95**

FEDERAL POWER TRANSFORMER
 NO. 252. New cased 110V 60 cy. Power Transformer. Supplies 480V CT at 50 MA and 6.3 V at 2.1 Amps. A beautiful transformer. Ship. **\$1.50**
 Wgt. 4 lbs. Each

HEAVY DUTY 6-12-24 VOLT VIBRATOR
 NO. 253. A husky vibrator used on army transmitter. Rated 30 amperes at 6 Volts 220 cycle with contacts for 12 and 24 Volts. Synchronous type, has many industrial applications. Ship. Wgt. 3 lbs. Each **\$1.50**

4 CHANNEL PUSH BUTTON TUNER
 NO. 254. Permeability tuner from BC 728 containing RF, first detector, and oscillator coils. Covers 2 to 5 MC. Complete circuit diagram furnished. Shipping Wgt. 2 lbs. Each **\$2.50**

CONDENSER SPECIAL
 NO. 255. An ideal oil filled power supply filter used in army 16 tube unit, has 2.5, 2.5 and 5 MFD all at 600V D.C. rating. Shipping **\$1.50**
 Wgt. 3 lbs. Each

AEROVOX TELEVISION CONDENSER
 NO. 256. Aerovox Myval .05 MFD at 7500V. rating. Excellent television coupling condenser with mounting bracket. Shipping Wgt. 3 lbs. Each **\$3.50**

BC 746 TUNING UNIT
 NO. 257. Plug in transmitter tuning unit from army Walkie Talkie. Contains antenna and tank coils, tuning condenser, transmitting and receiving crystals. Ideal transmitter foundation. Shipping Wgt. 1 lb. Each **\$1.00**
 (Same as above except transmitter crystal in 80 meter amateur band \$2.50 each)

T30 THROAT MICROPHONE
 NO. 258. Makes excellent contact microphone for musical instrument or vibration pick-up. Shipping Wgt. 1 lb. \$1.00 each
 Extension cord with switch for above \$1.50 each

BRAND NEW ARMY AIR FORCE ASTROGRAPH

NO. 259. The case of this unit makes the finest tool and service kit ever designed. Ply-wood construction, 14 x 11 x 10" high, with 8 covered compartments in the bottom for repair parts, leather handle, steel reinforced covers, hinged lid. Also excellent as case for radio phonograph, movie projector, camera, shell case, fishing kit, picnic kit, etc. The astrograph itself, (which cost the government \$125.00) makes an excellent contact printer, and can be used for a foundation for enlarger, strip map holder, etc. The case alone worth twice the give-away price of **\$3.95**

AN27/ARNS ANTENNA
 NO. 260. Standard blind landing antenna system. Brand new in original crate. Ship. Wgt. 14 lbs. **\$9.50**

AS114/APT ANTENNA SYSTEM
 NO. 261. New blade type antenna complete with case assembly, in original carton. Shipping Wgt. 9 lbs. **\$7.50**

AS115/APT ANTENNA SYSTEM
 NO. 262. New blade type antenna complete with case assembly, in original carton. Ship. Wgt. 11 lbs. **\$7.50**

AT38A/APT RADAR ANTENNA
 NO. 263. New radar dome type antenna with mounting base and connections, in original carton. Ship. Wgt. 11 lbs. **\$14.50**

AN104A BLADE ANTENNA
 NO. 264. Standard blade antenna used on many military fighting planes with coaxial connection at base. Shipping Wgt. 3 lbs. **\$1.50**

BENDIX MT51C TRANSMITTER CONTROL BOX
 NO. 235. Contains channel switch, emission switch, send receive switch, power switch and indicators for Bendix aircraft transmitters. Ship. Wgt. 3 lbs. **\$5.50**

BC 670B REMOTE CONTROL BOX
 NO. 265. Motor starting control box has starting and stopping switch, indicator, cable and plug. Wooden case. Ship. Wgt. 6 lbs. Each **\$1.95**

BK 22 RELAY ASSEMBLY
 NO. 266. Used on SCR 269 Radio Compasses. Contains stepping and control relays - junction box of aluminum. Brand new. Ship. Wgt. 7 lbs. Each **\$3.95**

HEINEMANN CIRCUIT BREAKER
 NO. 267. Heavy duty type 7 Amp. 24 Volt D.C. Many uses around shop. Shipping Wgt. 2 lbs. Each **\$1.00**

CUTLER HAMMER MOTOR FIELD CONTROL
 NO. 285. Rated 10 ohms. 3.2 Amps. Maximum. 6 1/2" diameter with knob and mounting feet, can be used to regulate generator output voltage. Shipping Wgt. 5 lbs. Each **\$2.50**

PENN THERMO RELAY
 NO. 268. Thermo Relay with a range of 45° to 100° complete with 5 Ft. flexible cable to immersion bulb. Shipping Wgt. 6 lbs. **\$3.50**

B & W 11 to 14 MC TANK COIL
 NO. 281. Plug in type used on BC 610 Transmitter. New, original cartons. Shipping Wgt. 2 lbs. Each **\$1.50**

DM 64A 12 VOLT DYNAMOTOR
 NO. 269. Input 12V at 5 Amps. Output 275 Volt 150 MA. New. Shipping Wgt. 7 lbs. Each **\$5.50**

DM 32A COMMAND SET DYNAMOTOR
 NO. 270. Part of 274N Command Receivers. Input 28 Volts, output 250V at 60 MA. Shipping Wgt. 4 lbs. Each **\$5.50**

DM 21 12 VOLT DYNAMOTOR
 NO. 271. Used in Army BC 312 Communication Receiver. Input 12 Volts at 3.3 Amps. Output 235 Volts at 90 MA. New, original cartons. Shipping Wgt. 8 lbs. Each **\$5.50**

PE94C SCR 522 POWER SUPPLY
 NO. 272. Complete dynamotor power supply for the SCR 522, operates from 28 Volts. Complete with controls, filters, etc. Original carton. Shipping Wgt. 34 lbs. Each **\$8.75**

PE101C BC645 POWER SUPPLY
 NO. 273. Complete power supply for BC 645. Operates from 12 or 24 Volts. Supplies both AC and DC required. Shipping Wgt. 13 lbs. Each **\$3.95**

DM 35 12 VOLT DYNAMOTOR
 NO. 274. New input 12 Volt at 18.7 Amperes. Supplies 675V at 275 MA or 1/2 above voltage from 6 volts. Excellent for auto use. Shipping Wgt. 11 lbs. Each **\$7.50**

PE 86 DYNAMOTOR
 NO. 214. A popular 28 Volt receiver dynamotor used on present military equipment. Supplies 250V at 60 MA. Shipping Wgt. 4 lbs. Each **\$5.50**

GN 58 HAND GENERATOR
 NO. 275. Makes excellent home lighting plant, operated by wind propeller, waterfall, gas engine, or hand crank. Reduction gear allows full output at slow speed; supplies 6 volts at 2.45 amp., 425 volts at .115 amp. New. Add \$7.95 postage for 28 lbs. Each **\$7.95**
 Handles for GN 58 \$1.50 each
 Connecting cord for GN 58 with plugs CD1086 \$1.50 each

COLLINS AUTOTUNE CONTROL HEAD
 NO. 278. Brand new controls used on the ART 13, 100 Watt, Transmitter. Types 7, 8, 10, and 11 available. Get a spare while available as new cost is over \$22.00 each. Shipping Wgt. 3 lbs. Price any type (mention when ordering). Each **\$4.50**

MC 432 VHF ANTENNA LOADING UNIT
 NO. 279. Contains 2 pole, 5 position rotary switch with silver ceramic variable condensers, and coils for matching VHF Transmitter to AN109 antenna with 50 ohm line. Many useful parts. Shipping Wgt. 2 lbs. Each **\$1.50**

148 OUTDOOR TELEGRAPH KEY
 NO. 280. Rugged enclosed type for outdoor use, built for army to withstand hard usage. Complete with card and PL55 plug. Shipping Wgt. 2 lbs. Each **\$2.00**

ONE KILOWATT ADJUSTABLE ANTENNA LOADING COIL
 NO. 282. Huge porcelain coil 4" diameter 8 1/4" long, has 5 sliders for adjustments. Shipping Wgt. 5 lbs. **\$3.50**

300 MA SELENIUM RECTIFIERS
 NO. 209. Rated 300 MA at 36 Volts, complete with mounting brackets. Shipping Wgt. 1 lb. **3 FOR \$1.00**

DUAL SELENIUM RECTIFIER
 NO. 283. Two units mounted on single bracket, each section rated 15V. at 1/2 Amp. Shipping Wgt. 1 lb. **2 FOR \$1.00**

HOW TO ORDER • • • GIVE PART NUMBER AND DESCRIPTION • • • ADD POSTAGE FOR WEIGHT SHOWN. NO ORDERS UNDER \$2.00 • • • WE WILL SHIP C.O.D.

The HEATH COMPANY
 DEPT. C . . . BENTON HARBOR, MICHIGAN

TEST EQUIPMENT

New! HEATHKIT FM and TELEVISION SWEEP GENERATOR KIT

THE BASIC FM AND TELEVISION SERVICE INSTRUMENT

- Features -**
- ★ Covers 2 Mc. to 226 Mc.
 - ★ 110 V 60 cy transformer.
 - ★ Supplies either RF or FM.
 - ★ Variable sweep width 0 to App. 10 Mc.
 - ★ 5 Tube Circuit
 - ★ Large calibrated dial.
 - ★ Variable phasing control.
 - ★ Sweep output for scope.
 - ★ No band switching necessary.
 - ★ Uses new miniature HF tubes.



At the lowest cost possible, anyone can now service FM and television receivers. The Heathkit sweep generator kit operates with oscilloscope and covers all necessary frequencies. A few pleasant hours assembling this kit puts any organization in position to share the profits of the FM and TV boom. Every part supplied - grey crackle cabinet, two color calibrated panel, all metal parts punched, formed and plated. 5 tubes, complete detailed instructions for assembly and use. Shipping weight 6 lbs.

\$24.50

Enjoy the profits now of this new field

HEATHKIT HIGH FIDELITY AMPLIFIER KIT

Build this high fidelity amplifier and save two-thirds of the cost. Push pull output using 1619 tubes (military type 6L6's), two amplifier stages using a dual triode (6SN7), and a phase inverter give this amplifier a linear reproduction equal to amplifiers selling for ten times this price. Every part supplied; punched and formed chassis, transformers (including quality output to 3-8 ohm voice coil), tubes, controls, and complete instructions. Add postage for 20 lbs.

12" PM speakers for above \$6.95



\$14.95

HEATHKIT 3-TUBE ALL-WAVE RADIO

110-volt AC operation

An ideal way to learn radio. This kit is complete ready to assemble, with tubes and all other parts. Operates from AC. Simple, clear detailed instructions make this a good radio training course. Covers regular broadcasts and short wave bands. Plug-in coils. Regenerative circuit. Operates loud speaker.

Add postage for 3 lbs.

HS 30 Headphones per set \$1.00
2 1/2" permanent magnet loudspeaker \$1.95

\$8.75



INTERPHONE

2-WAY CALL SYSTEM KIT

Ideal call and communication system for homes, offices, factories, stores, etc. Makes excellent electronic baby watcher, easy to assemble with every part supplied including simple instructions. Distance up to 1/5 mile. Operates from 110 V. A.C. 3 tubes, one master and one remote speaker. Shipping Weight 5 pounds.



\$14.50

\$39.50

Nothing ELSE TO BUY

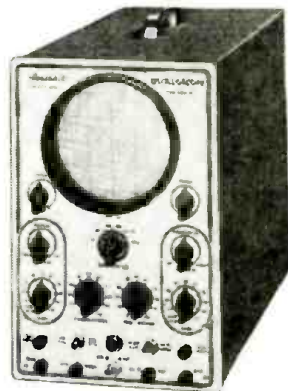
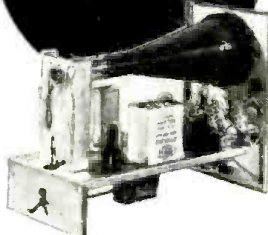

NEW 1948 HEATHKIT 5" OSCILLOSCOPE KIT

A necessity for the newer servicing technique in FM and television at a price you can afford. The Heathkit is complete, beautiful two color panel, all metal parts punched, formed and plated and every part supplied. A pleasant evening's work and you have the most interesting piece of laboratory equipment available.

Check the features - large 5" 5BP1 tube, compensated vertical and horizontal amplifiers using 6SJ7's, 15 cycle to 30 M cycle sweep generator using 834 gas triode, 110V 60 cycle power transformer gives 1100 volts negative and 350 volts positive.

Convenient size 8 1/2" x 13" high, 17" deep, weight only 26 pounds.

All controls on front panel with test voltage and ext. syn post. Complete with all tubes and detailed instructions. Shipping weight 35 pounds. Order today while surplus tubes make the price possible.

110 V. A.C. MILITARY RECEIVER POWER SUPPLY KIT

Ideal way to convert military sets. Supplies 24 Volts for filament - no wiring changes inside radio. Also supplies 250 V. D.C. plate voltage at 50-60 MA. Connections direct to dynamotor input. Complete with all parts and detailed instructions. Ship. Wt., 6 lbs.

\$ 5.95

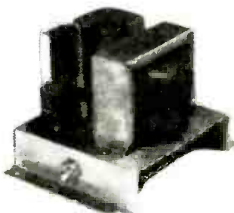

110 V. A.C. TRANSMITTER POWER SUPPLY KIT

For BC-645, 223, 522, 274N's, etc. Ideal for powering military transmitters. Supplies 500 to 600 Volts at 150 to 200 MA plate, 6.3 C.T. at 4 Amps, 6.3 at 4 Amps and 12V at 4 Amps. Can be combined to supply 3-6-9-12 or 24 Volts at 4 Amperes. Kit supplied complete with husky 110V 60 cycle power transformer, 5U4 rectifier, oil filled condensers, cased choke, punched chassis, and all other parts, including detailed instructions. Complete - nothing else to buy.

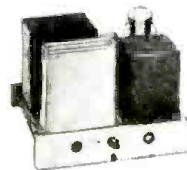

\$14.50



The HEATH COMPANY

DEPT. C . . . BENTON HARBOR, MICHIGAN

*It's Only
Natural*

**FOR RADIO MEN TO
ASSEMBLE THEIR OWN**

Heathkit ELECTRONIC SWITCH KIT
DOUBLES THE UTILITY OF ANY SCOPE



\$34⁵⁰

Gives two separately controllable traces with individual inputs on any scope.

See both the input and output traces, locate distortion, phase shift, etc., immediately.

Individual gain controls and positioning control. Coarse and fine sweeping rate controls. Complete Heathkit matches others, with 5 tubes. All metal parts are punched, formed and cadmium plated. Complete with tubes, all parts, detailed blueprints and instructions. Shipping Wt. 13 lbs.

Nothing ELSE TO BUY

- ★ Save ⅓ the cost.
- ★ Gain valuable knowledge.
- ★ Achieve better workmanship.
- ★ Learn many new applications.
- ★ Ideal training for use.

Heathkits are regular factory quality test equipment unassembled but with all forming, punching, calibrating and printing already completed.

**HEATHKIT
CONDENSER CHECKER KIT**

A condenser checker anyone can afford to own. Measures capacity and leakage from .00001 to 1000 MFD on calibrated scales with test voltage up to 500 volts. No need for tables or multipliers. Reads resistance 500 ohms to 2 megohms. 110V 60 cycle transformer operated complete with rectifier and magic eye indicator tubes. Easy quick assembly with clear detailed blueprints and instructions. Small convenient size 9" x 6" x 4¾". Weight 4 pounds. This is one of the handiest instruments in any service shop.



\$19⁵⁰
*Nothing
ELSE TO BUY*

**THE NEW HEATHKIT VACUUM TUBE
VOLTMETER KIT**

The most essential tool a radio man can have, now within the reach of his pocketbook. The Heathkit VTVM is equal in quality to instruments selling for \$75.00 or more. Features 500 microamp meter, transformer power supply, 1% glass enclosed divider resistors, ceramic selector switches, 11 megohms input resistance, linear AC and DC scale, electronic AC reading RMS. Circuit uses 6SN7 in balanced bridge circuit, a 6H6 as AC rectifier and 6 x 5 as transformer power supply rectifier. Included is means of calibrating without standards. Average assembly time less than four pleasant hours and you have the most useful test instrument you will ever own. Ranges 0-3, 30, 100, 300, 1000 volts AC and DC. Ohmmeter has ranges of scale times 1, 100, 1000, 10M and 1 megohm, giving range .1 ohm to 1000 megohms. Complete with detailed instructions. Add postage for 8 lbs.

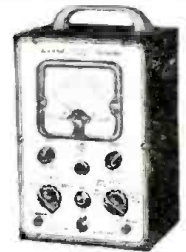

\$24⁵⁰
*Nothing
ELSE TO BUY*

**HEATHKIT
SIGNAL GENERATOR KIT**

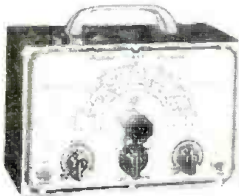

\$19⁵⁰
**NOTHING ELSE
TO BUY**

Every shop needs a good signal generator. The Heathkit fulfills every servicing need, fundamentals from 150 Kc. to 30 megacycles with strong harmonics over 100 megacycles covering the new television and FM bands. 110V 60 cycle transformer operated power supply.

400 cycle audio available for 30% modulation or audio testing. Uses 6SN7 as RF oscillator and audio amplifier. Complete kit has every part necessary and detailed blueprints and instructions enable the builder to assemble it in a few hours. Large easy to read calibration. Convenient size 9" x 6" x 4¾". Weight 4½ pounds.

**HEATHKIT
SIGNAL TRACER KIT**

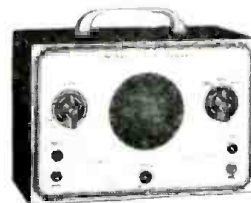

\$19⁵⁰
Nothing ELSE TO BUY

Reduces service time and greatly increases profits of any service shop. Uses crystal diode to follow signal from antenna to speaker. Locates faults immediately. Internal amplifier available for speaker testing and internal speaker available for amplifier testing. Connection for VTVM on panel allows visual tracing and gain measurements. Also tests phonograph pickups, microphones, PA systems, etc. Frequency range to 200 Mc. Complete ready to assemble. 110V 60 cycle transformer operated. Supplied with 3 tubes, diode probe, 2 color panel, all other parts. Easy to assemble, detailed blueprints and instructions.

Small portable 9" x 6" x 4¾". Wt. 6 pounds. Ideal for taking on service calls. Complete your service shop with this instrument.

**HEATHKIT SINE AND SQUARE WAVE
AUDIO GENERATOR KIT**

The ideal companion instrument to the Heathkit Oscilloscope. An Audio Generator with less than 1% distortion, high calibration accuracy, covering 20 to 20,000 cycles. Circuit is highly stable resistance capacity tuned circuit. Five tubes are used, a 6SJ7 and 6K6 in the oscillator circuit, a 6SL7 square wave clipper, a 6SN7 as a cathode follower output and 5Y3 as transformer power supply rectifier.

The square wave is of excellent shape between 100 and 5,000 cycles giving adequate range for all studio, FM and television amplifier testing.

Either sine or square wave available instantly at a toggle switch. Approximately 25V of sine AC available at 50,000 ohm output impedance. Output ± 1 db. from 20 to 20,000 cycles. Nothing else to buy. All metal parts are punched, formed and cadmium plated. Complete with tubes, all parts, detailed blueprints and instructions.

\$34⁵⁰
Shipping Wt., 13 lbs.



The HEATH COMPANY

DEPT. C . . . BENTON HARBOR, MICHIGAN

ing, even though not a single resistor is changed!

The amplifier, used on the lower ranges, also has negative feedback, achieved by leaving part of the cathode resistor unbypassed so that good frequency response is obtained throughout the audio range.

A certain amount of high-frequency compensation is gotten by connecting a 20- μ f condenser between the amplifier cathode and ground.

Constructional details

The layouts of the front panel and chassis are shown in the photographs. For the panel, a black crackle finish is used, lettered with white drawing ink. Where the panel is to be lettered, the paint is first smoothed with fine sandpaper, then moistened with saliva and allowed to dry.

Layout of the chassis is not particularly critical, no more so than that of a microphone preamplifier. Main points are shielding the 6J7-G, if one is used, and short leads from the hot input terminal and from the control grid of the first tube. The range switch should be covered with a grounded metal shield can.

Warning: do not attempt to omit the power transformer and use an a.c.-d.c.

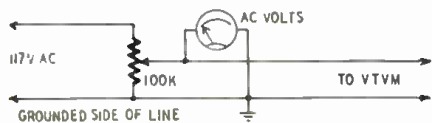

Fig. 2—Setup for calibrating the voltmeter.

circuit with a line-cord resistor. You can't hope for reliable readings if one side of the power line is connected to the chassis.

Calibration

Set R1 so that the meter reads a very small value, but not zero (say about .01 ma). Mark this point zero on the meter scale.

A calibration setup will be needed. This can consist of a 100,000-ohm potentiometer connected across the 117-volt power line, with a reliable a.c. voltmeter between the arm and ground. Test with an incandescent lamp to make sure which is the grounded side of the line. The arrangement appears in Fig. 2. Be careful not to touch anything but the grounded leads.

Before going further, adjust the values of R2 and R3 for the indicated B-voltage. Then set the arm of the calibration potentiometer for 20 volts. Set the v.t.v.m. range switch to the 20-volt position, and adjust R4 for full-scale meter deflection. Adjustments on this and other fixed resistors can be made either by substituting other resistors or, if the resistor is an uninsulated carbon type, filing it down to obtain higher resistance. The scale can be calibrated now by varying the input voltage and marking in the various values on the meter.

Next set the test voltage at 10 and make sure the v.t.v.m. reads properly.

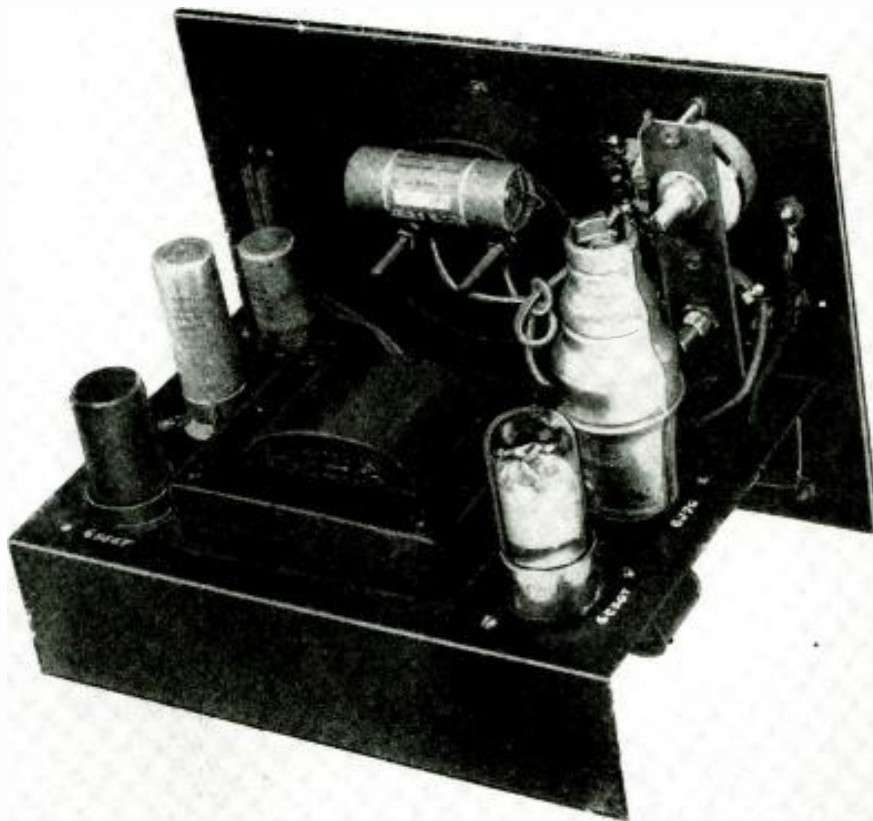

The chassis layout. Notice the shield covering the 6J7-G. R1 and R7 are on strip at right.

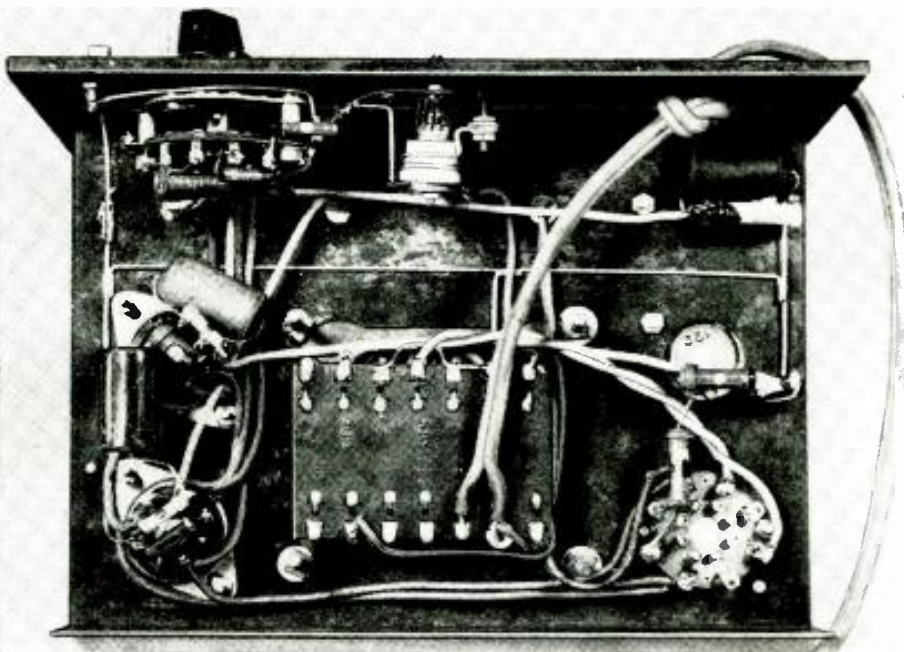

Wiring under the chassis should be rigid and short to minimize hum pickup and instability.

Set the range switch at 200 and adjust R5 and R6 so that the meter again reads 10.

The remaining scale can be calibrated by setting the range switch, feeding in the proper voltage, and adjusting the 6-megohm resistor on the 0.8-volt range and the 38-megohm resistor on the 4-volt range for full-scale meter reading. The 0.2-volt range should be calibrated first by setting R7. R7 should be left alone while calibrating the other two

low-voltage ranges.

This type of meter gives readings depending upon the peak value, although the scale is calibrated to read r.m.s. or effective values. The presence of even harmonics can be detected by reversing the input leads to the v.t.v.m. If there is a difference in the readings, second harmonic is probably present. Inadequate shielding of the supply may also cause hum to be picked up with one polarity but not with the other.

Sensitive Vacuum-Tube Voltmeter

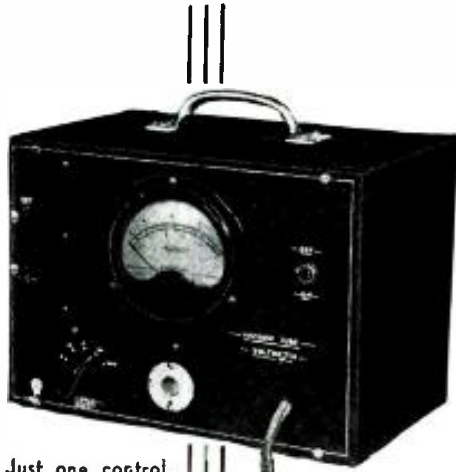

Just one control, the range switch, appears on panel.

A practical instrument which uses an extra amplifier tube for the lower-voltage ranges

By JOHN W. STRAEDE*

ANY voltage measurement that can be made by a v.t.v.m. can be made by some other means, but a tube makes a very portable, convenient, stable, cheap and versatile device.

Vacuum-tube voltmeters are used to measure voltages: (a) from a high-impedance source, (b) that are very small, (c) of very high frequency, and (d) whose wave form is unknown or unusual. Voltages in class (a) can be measured by certain types of electrostatic voltmeters which contain no resistance across the input, but it's easier and cheaper to use a buffer amplifier with a special tube requiring no grid leak and to follow it with an ordinary meter.

Very minute voltages can be measured with an Einthoven string galvanometer or by a potentiometer, but again it's easier to amplify the small voltage and bring it into a higher range.

High-frequency voltages can be measured with rectifier-type or thermocouple meters if special compensation networks are used, but the effective ohms per volt are rather low.

No matter what the wave form, it is possible to devise a v.t.v.m. that will measure peak, average, or r.m.s. value, whichever is desired.

Any detector circuit can be used as a v.t.v.m. There are three types of detectors: the grid-leak (very sensitive for low input voltages); the anode-bend with feedback (very linear but comparatively insensitive); and combinations of these with an amplifier preceding or following.

The preceding amplifier usually makes the instrument suitable for a.c.

only and must be well designed to take care of frequency response, tube aging, and variations in B-voltage. A following amplifier must be direct-coupled and must have a current bucking device to correct for drift.

Chief advantages of the meter described in this article are: (1) independence of supply voltage (20% change gives no detectable difference in reading at the center of each scale and only slight changes at the ends); (2) good linearity of scale and the same linearity on each range, so that only one scale is required; (3) separate sensitivity adjustment on each range, so that the meter can be adjusted at intervals to be "dead accurate"; (4) an input resistance higher than 1 megohm per volt, except on the higher-voltage ranges where it is desirable to avoid special high-value resistors; (5) good frequency response over the audio range; and (6) no false reading if the input is shorted—d.c. continuity or otherwise of the source of the voltage being measured does not affect the reading.

The useful frequency range is ap-

proximately from 25 to 20,000 cycles. At the low-frequency end the response is down about 2 db at 10 cycles. It drops off below this at about 6 db per octave on the higher-voltage ranges. On the lower-voltage ranges the response drops off below 25 cycles.

The response in the r.f. range depends on care in layout. Poor layout requires excessive shielding, resulting in poor response. With good layout, the meter still works (though well down) in the r.f. range.

This particular meter was designed for checking phonograph pickups and for general audio-frequency amplifier testing. Lowest range is 0.2 volt, full scale, and highest is 200. The basic circuit, that of the triode in Fig. 1, is a plate detector with complete negative feedback, obtained by having all the load in the cathode circuit. Plenty of feedback means stability and constancy of calibration, with consequent freedom from troubles due to B-supply variation. So self-adjusting is this circuit that replacement of the triode by a pentode has only a negligible effect on the read-

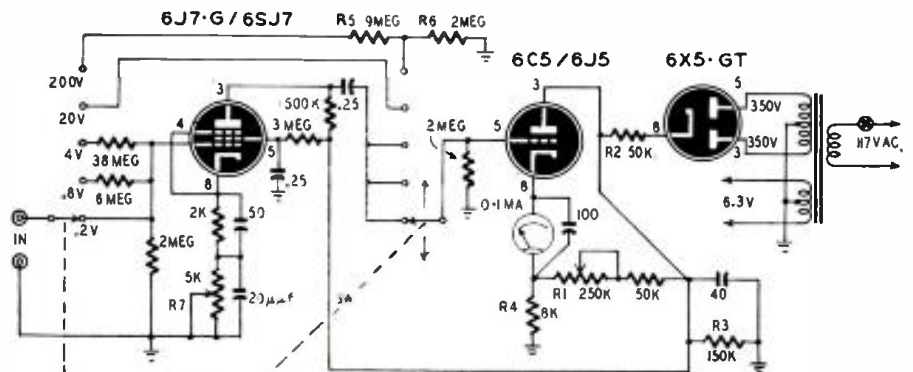

Fig. 1—Pin numbers of detector tube refer to 6J7-G only. R1 is the zero-adjustment control.

*Lecturer in electronics and electro-acoustics, Melbourne Technical College, Australia.

MONEY BACK GUARANTEE — We believe units offered for sale by mail order should be sold only on a "Money-Back-If-Not-Satisfied" basis. We carefully check the design, calibration and value of all items advertised by us and unhesitatingly offer all merchandise subject to a return for credit or refund. You, the customer, are the sole judge as to value of the item or items you have purchased.

BUILD YOUR OWN SIGNAL TRACER and **SAVE!!**



THE MODEL CA-12 KIT COMES COMPLETELY ASSEMBLED. Can be wired in 30 minutes. Components and circuit guaranteed to meet the following:

The Only Signal Tracer in the Low Price Range Including BOTH METER AND SPEAKER!!

We are pleased to announce we have obtained an exclusive franchise to distribute the well known Model CA-12 Signal Tracer in kit form. The Model CA-12 sells regularly for \$29.95, here is your opportunity to save \$8.00 with the added advantage of complete familiarity of design and operation made possible when you build your own instrument.

FEATURES: ★ Comparative intensity of the signal is read directly on the meter—quality of the signal is heard in the speaker. ★ Simple to operate—only one connecting cable—no tuning controls. ★ Highly sensitive—uses an improved vacuum-tube voltmeter circuit. ★ Tube and resistor capacity network are built into the detector probe. ★ Built-in high gain amplifier—Alnico V speaker. ★ Completely portable—weighs 8 pounds—measures 5 1/4" x 6 1/2" x 9".

MODEL CA-12 Kit includes ALL PARTS assembled and ready for wiring, circuit diagram and detailed operating data for the completed instrument \$21.95

\$21⁹⁵

MODEL CA-12 COMPLETELY WIRED READY TO OPERATE \$29.95

THE NEW MODEL 670

SUPER METER



SUPER METER. A Combination VOLT - OHM - MILLIAMMETER plus CAPACITY REACTANCE, INDUCTANCE and DECIBEL MEASUREMENTS.

D.C. VOLTS: 0 to 7.5/15/75/150/750/1500/7500. **A.C. VOLTS:** 0 to 15/30/150/300/1500/3000. **OUTPUT VOLTS:** 0 to 15/30/150/300/1500/3000. **D.C. CURRENT:** 0 to 1.5/15/150 ma. 0 to 1.5/15/150 ma. **RESISTANCE:** 0 to 500/100,000 ohms. 0 to 10 Megohms. **CAPACITY:** .001 to .2 Mfd. .1 to 4 Mfd. (Quality test for electrolytics.) **REACTANCE:** 700 to 27,000 Ohms; 13,000 Ohms to 3 Megohms.

INDUCTANCE: 1.75 to 70 Henrys; 35 to 8,000 Henrys.

DECIBELS: -10 to +18. +10 to +38. +30 to +58.

The model 670 comes housed in a rugged, crackle-finished steel cabinet complete with test leads and operating instructions. Size 5 1/2" x 7 1/2" x 3".

\$28⁴⁰ NET

The Model S-35 — a POWERFUL

REFLEX PROJECTOR

COMPLETE WITH WESTERN ELECTRIC BUILT-IN DRIVER UNIT

CONSERVATIVELY RATED AT 35 WATTS—WILL EASILY HANDLE UP TO 55 WATTS WITHOUT BLASTING

Heavy gauge aluminum in the main trumpet section completely eliminates blasting and blaring. New plastic diaphragm overcomes the resonant peaks of the old type; also it is absolutely impervious to atmospheric changes whereas the old type was subject to atmospheric corrosion. Complete unit unconditionally guaranteed for one year.



Specifications
POWER (CONSERVATIVE) — 35 WATTS; AIR COLUMN—3/2 FT.; DISPERSION—80°; POWER (PEAK) —55 WATTS; BELL DIAMETER—15"; IMPEDANCE—8 ohms; FREQUENCY RANGE—130 to 5000 C.P.S. PROJECTION — 1/2 mile; FINISH — Attractive two tone crystalline.
The Model S-35 Comes Complete with Built-in Driver Unit, ONLY

\$28⁵⁰ NET

The New Model 770 — An Accurate Pocket-Size

VOLT-OHM MILLIAMMETER



(Sensitivity: 1000 ohms per volt)

Features: Compact—measures 3 1/4" x 5 7/8" x 2 1/4". Uses latest design 2 1/2" accurate 1 Mil. D'Arsonval type meter. Same zero adjustment holds for both resistance ranges. It is not necessary to readjust when switching from one resistance range to another. This is an important time-saving feature never before included in a V.O.M. in this price range. Housed in round-cornered, molded case. Beautiful black etched panel. Depressed letters filled with permanent white, insures long-life even with constant use.

Specifications: 6 A.C. VOLTAGE RANGES: 0-15/30/150/300/1500/3000 volts.

6 D.C. VOLTAGE RANGES: 0-7 1/2/15/75/150/750/1500 volts.

4 D.C. CURRENT RANGES: 0-1 1/2/15/150 Ma. 0-1 1/2 Amp.

2 RESISTANCE RANGES: 0-500 ohms. 0-1 Megohm.

The Model 770 comes complete with self-contained batteries, test leads and all operating instructions.

\$13⁹⁰ NET

The Model 88 — A COMBINATION

SIGNAL GENERATOR AND SIGNAL TRACER



Signal Generator Specifications:

*Frequency Range: 150 Kilocycles to 50 Megacycles. *The R.F. Signal Frequency is kept completely constant at all output levels. *Modulation is accomplished by Grid-blocking action which is equally effective for alignment of amplitude and frequency modulation as well as for television receivers. *R.F. obtainable separately or modulated by the Audio Frequency.

Signal Tracer Specifications:

*Uses the new Sylvanite 1N34 Germanium crystal Diode which combined with a resistance-capacity network provides a frequency range of 300 cycles to 50 Megacycles.

The Model 88 comes complete with all test leads and operating instructions. ONLY

\$28⁸⁵ NET

20% DEPOSIT REQUIRED ON ALL C.O.D. ORDERS

GENERAL ELECTRONIC DISTRIBUTING CO. DEPT. RC-11 98 PARK PLACE, NEW YORK 7, N. Y.

High Band Telebooster

A companion to last month's preamplifier

By I. QUEEN

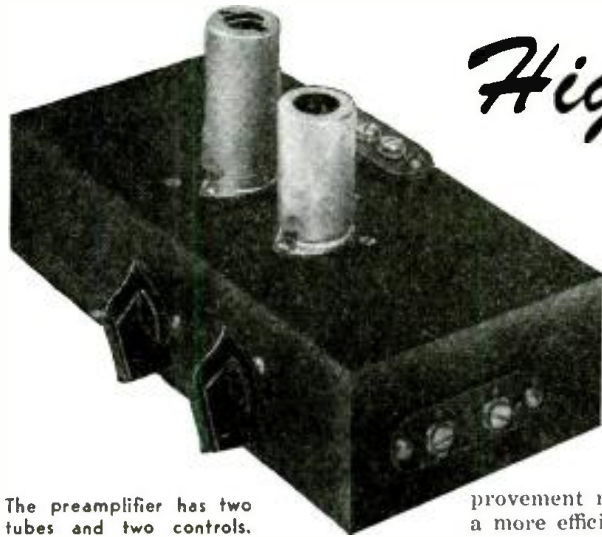

The preamplifier has two tubes and two controls.

LIKE the booster described in the October issue, the one diagrammed is based on the cascode circuit, using two tubes in a novel circuit arrangement (See Fig. 1). It operates on the h.f. television band.

Both the input circuit and the output circuit are tuned. L1 and L2, made of heavy wire, are self-supporting. Each is formed of 1½ turns ¼ inch in diameter. A little experimenting with turns spacing will be needed to tune over the band. With four-plate midget tuning condensers, channel 13 comes in near minimum capacitance. Channel 7 requires about two-thirds maximum capacitance. The tuning controls track closely.

Input and output coupling coils, L3 and L4, are also self-supporting and are made of push-back wire. Each has 1½ turns. Maximum gain is provided by coupling as tightly as possible to the tank coils.

Choke L5 is made of four turns ¾ inch in diameter. L6 is 6 turns of wire and ½ inch in diameter. Use No. 18 to 22 enameled wire.

The booster has been tried on channels 7, 11, and 13. Using the conventional signal-strength scale, it raises the signal about 2 S-points. Gain is slightly less near the upper end of the band than it is on channel 7. Unless the noise level is already too high, this booster will bring in a clearly visible (though weak) picture where the receiver alone tunes in one which is practically invisible.

When added to an average TV set which has an r.f. stage, the booster provides as much gain as can be used in most cases. This is because the noise level is also brought up. Further im-

provement requires a better location or a more efficient antenna.

Only one booster may be sufficient in a particular location, but it is possible that both high and low bands will require amplification. This booster and the one described in October can be combined into a single unit on the same chassis and with the same power supply. Since the low-band unit included a power supply, all that is necessary is to connect the high-band unit to the same supply. As a matter of fact, this amplifier was built on half of the same sawed-in-two chassis.

Even the simplest switching arrangement *within* either preamplifier will introduce long leads and add too much capacitance. When combining the two preamps on one chassis, switch the 300-ohm lines from the antenna and to the receiver. Construct each amplifier as a complete unit (except for power supply) and use a rotary selector switch to transfer input and output transmission lines from one to the other. A center

position for cutting out the preamps entirely would be a good idea. To prevent long leads under the chassis (these will reduce amplification and cause instabil-

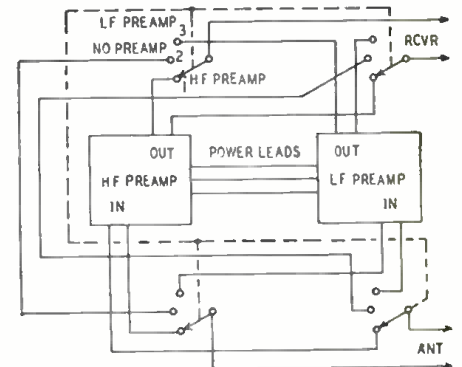

Fig. 2—Proposed low-high switching circuit.

ity), use a long switch shaft and position the switch gangs close to the terminal points. The switching diagram of Fig. 2 gives a suggested arrangement. Use low-loss-type switch wafers.

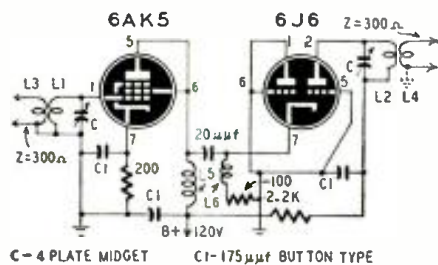
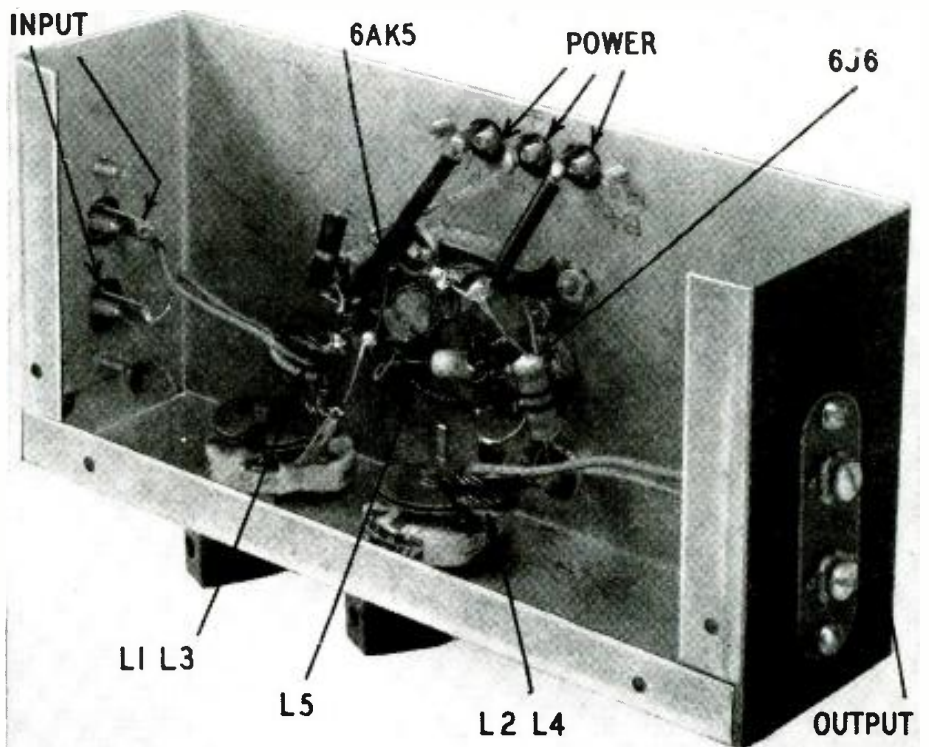

Fig. 1—Unit is a cascode with double tuning.



Underchassis view. Parts layout and manner of winding coils can be seen from the photograph.

Capitol Radio Engineering Institute — Pioneer in Radio Engineering Instruction Since 1927



WANTED!

**Chief Engineers,
Studio Engineers,
Transmitter
Engineers**
for more than

**1100 FM* & 2350 AM
BROADCAST STATIONS**
the FCC indicates will be in
operation in the U.S. next year

* As of Sept. 1948:
618 FM stations
on the air.
818 FM stations
with construction
permits and
conditional grants.



**MAIL COUPON TODAY
FOR THIS 24-PAGE
FREE BOOKLET!**

**Yes, Plenty of Good-Paying Jobs...
BUT Only for those Qualified**

FM is actually coming into its own in 1948-49 . . . more than 1100 FM stations with permits and grants now on the air, or soon to be. Over 1700 standard broadcast stations now in operation—1200 more with construction permits and applications. Television receivers are on mass production lines. Hundreds of new TV stations will be going on the air—over a hundred construction permits now issued—over 400 TV applications now at the FCC.

Radio-electronics is not only expanding in job opportunities but it is also growing in technical complexity. Rapid developments in every branch of the field are leaving many radio technicians and engineers far behind the parade of progress. These are the men who fail to realize that their technical knowledge must grow with the expansion of the industry.

What does this mean to *you*? It means you must study not only to *hold* the job you now occupy . . . but study to *qualify* for the better job you want. CREI modern technical training can (within a comparatively short time) qualify you for the better jobs and help enable you to step ahead of those who have failed to improve their ability through technical training.

Beginning *right now* CREI can provide the on-the-job training that equips you with the technical ability to go after—and GET—the important, high salaried jobs. Get all the facts today about the unprecedented opportunities that await you. Learn how CREI spare time training can help you as it has helped thousands of other professional radiomen advance to better jobs during the past twenty years.

VETERANS! CREI TRAINING AVAILABLE UNDER THE "G. I." BILL

**Capitol Radio
Engineering Institute**
An Accredited Technical Institute

Dept. RC-11, 16th and Park Road, N. W., Washington 10, D. C.

Branch Offices: New York (T): 170 Broadway

San Francisco (2): 760 Market St.

Capitol Radio Engineering Institute
16th and Park Road, N. W., Dept. RC-11
Washington 10, D. C.

Gentlemen: Please send me your free booklet, "CREI training for your better job in RADIO-ELECTRONICS," together with full details of your Home Study training. I am attaching a brief resume of my experience, education and present position.

Check One Course:
 Practical Television
 Practical Radio-Electronics

Name _____
 Street _____
 City _____
 Zone _____ State _____

I am entitled to training under the G. I. Bill.

very much like shunt-peaked circuits but they have sharper cutoff. The voltage developed across RL is applied across the grid leak of the following stage, Rg, and C2. Since Rg is large, the series

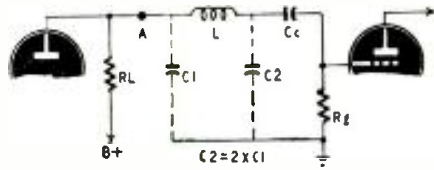

Fig. 5—Basic diagram, series peaking circuit.

resonant circuit, L and C2, works as a reactive voltage divider. The voltage across C2—and Rg—rises as the resonant frequency is approached. (The value of L is chosen so the resonant frequency is outside the high-frequency cutoff point of the amplifier.) This compensates for losses caused by C1 shunting RL. C1 and C2 are portions of the shunt capacitance between the stages. The

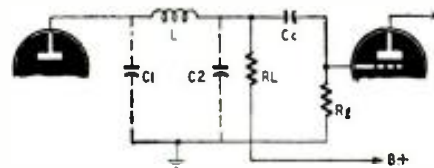

Fig. 6—The value of C1 is twice that of C2.

shunt capacitance, Cs, (C_{output} + C_{input} + C_{stray}) is divided into C1 and C2 by L. The major disadvantage of series peaking is that there should be a 2 to 1 ratio between the capacitance of C1 and C2. This is not always easy to realize in practice. The circuits work best when RL is on the low-capacitance side of the network. In Fig. 5, RL is connected directly to the plate of the tube so C2 must be made equal to 2C1.

It is difficult to balance the shunt capacitance properly and the positions of the components in the circuit must be found by experiment. A good 'scope and a square-wave generator are required for this. Connect the 'scope to the output of the generator, feed in a 400-cycle square wave and observe the wave shape on the 'scope. Adjust the generator and 'scope controls until a good square wave is obtained. Now connect the generator to the input of the amplifier and the 'scope to its output. If the leading edges are badly rounded, try altering the positions of RL, L and Cc. Position the components for the best possible wave shape—giving particular attention to the edges.

Even in the most carefully planned circuits, Cc, the coupling capacitor, will add considerably to the stray capacitance. If it is paper, the major capacitance will be between the outer foil and

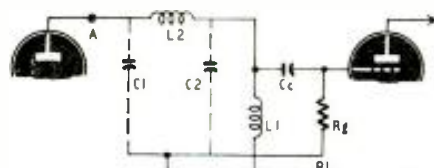

Fig. 7—Combination series and shunt peaking.

ground. If the output capacitance is larger than the input capacitance, R1 will normally be connected to the grid (low-capacitance) end of L, as in Fig. 6. If Cc has a large capacitance to ground, this will add to the input capacitance and C2 may be larger than C1.

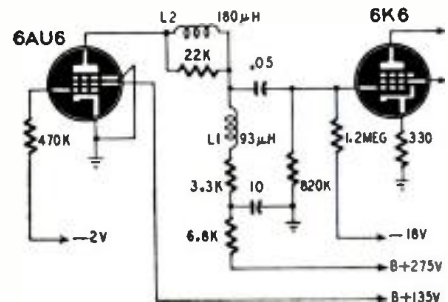

Fig. 8—Commercial series-shunt high peaker.

Check this by moving Cc to the plate end of L (A in Fig. 5). It is even worth while to try turning Cc end-for-end.

In Figs. 5 and 6:

$$RL = \frac{1.5}{\sqrt{6.28 \times f \times C}}$$

$$\text{and } L = 0.67 \times C \times RL^2$$

where L is in henries, C in farads and f in cycles. Best results can be obtained by winding L on a form with a variable powdered-iron core. The core can be adjusted for the best high-frequency response. Series-peaked circuits cut off sharply, so the further f is from the cutoff frequency, the flatter the frequency response curve. In some instances, it may be necessary to shunt L with a resistor about 5 to 10 times RL to flatten the response.

Series-shunt peaking is, as the name implies, a combination of both compen-

Fig. 8 shows the series-shunt peaking network used in the RCA 641TV. The 22,000-ohm resistor across L2 flattens the response peak that may be due to improper ratio of C1 to C2 or to distributed capacitance of L2. Ignoring the wiring capacitance, C1 is the output capacitance of the 6AU6 and C2 is the input capacitance of the 6K6-G.

Fig. 9 is a partial schematic of the iconoscope preamplifier used in the Navy ATK airborne television transmitter. The output of the iconoscope consists of signals ranging from about 20 cycles to 4 mc or higher at a very low level. This signal appears across the 470,000-ohm input resistor of the 1649. The input capacitance of the 1649 shunts the resistor and reduces the signal level at high frequencies. L1 and L2 constitute a series-shunt peaking circuit with all reactances negligible up to 1 mc. The load impedance of V1 is the 2,700-ohm resistor. Above 1 mc, the rising reactances of L1 and L2 in combination with the shunt capacitance boost the gain gradually to 4 mc. This compensates for some of the losses at the input of V1. The 22,000-resistor across



Fig. 10 (left)—The ideal V1-to-V2 response. Fig. 11 (right)—Response of the high peaker.

L2 controls its Q and assists in obtaining the desired response. Fig. 10 shows optimum response between the grid of V1 and the plate of V2.

The "high-peaker" between V2 and V3 completes the restoration of highs lost at the input of V1. The degree of peaking and the point at which it occurs may be varied by adjusting C2. Fig. 11 is the response curve between

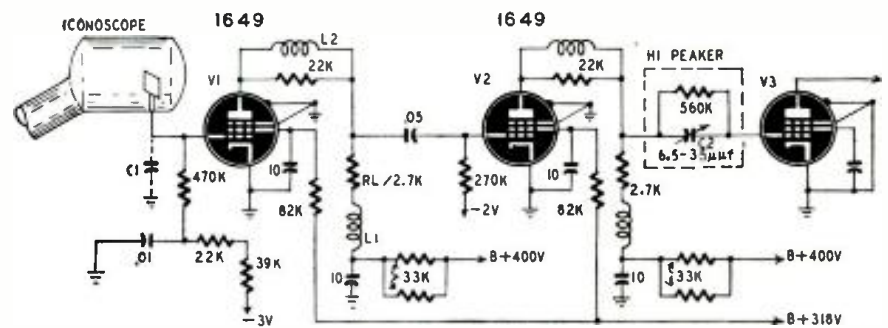

NOTE:—1649 IS A SPECIAL NON-MICROPHONIC 6AC7

Fig. 9—Navy ATK airborne transmitter uses an R-C high peaker and L-C stage compensators.

sation methods. The basic circuit is shown in Fig. 7. Here, L1 corresponds to L in Figs. 1 and 2 and L2 corresponds to L in Figs. 5 and 6. In this circuit, the 2 to 1 ratio of C1 and C2 should be maintained. In this case, L1 and RL may have large capacitance to ground and it may be necessary to connect the shunt peaking network at A on the plate side of L2. In Fig. 7:

$$RL = 1.8/6.28 \times fC,$$

$$L1 = 0.12 \times RL^2 \times Cs$$

$$\text{and } L2 = 0.52 \times RL^2 \times Cs.$$

the grid of V2 and the plate of V3.

The compensating system employed depends largely on the desired gain and permissible phase shift at the highest frequency, f. In an uncompensated amplifier, gain at f is 70.7% of the gain at mid-band. With shunt peaking, the response at f is equal to the response at mid-band. With series and series-shunt compensating methods, the relative gains are 150% and 180% when compared to the gain at mid-band.

If phase shift is important series peaking is the most desirable system to use.

ALLIED'S NEW **FREE** 1949 RADIO CATALOG

180 VALUE-PACKED PAGES

Send for it now!



The Preferred Radio Buying Guide

It's ready for you—the new 1949 ALLIED Radio Catalog! Get the Radio Buying Guide that's the first choice of thousands of expert service technicians, engineers, soundmen, Amateurs, builders and experimenters. The new ALLIED Catalog—Radio's largest and most complete—brings you 180 pages packed with the widest selections of the newest and finest equipment, at today's lowest, money-saving prices! Here's everything in radio for everyone in radio: new Television and home receivers; radio-phonos with new Dual-Speed Changers; packaged Sound Systems, high-fidelity sound components and P. A. equipment; latest Amateur receivers and station gear; test instruments; builders' kits; thousands of parts, tubes, tools, books—the world's largest and finest stocks of nationally known equipment. Take advantage of ALLIED's speedy, expert shipment and the personal attention of seasoned old-time radio men. Get the details, too, of radio's most liberal Time Payment Plan. Write today for your FREE copy of ALLIED's newest and greatest Catalog—the preferred Radio Buying Guide!

LARGEST STOCKS • QUICK, EXPERT SERVICE

**Send for your FREE copy of
Radio's Most Complete Catalog.
Use the coupon below — NOW!**

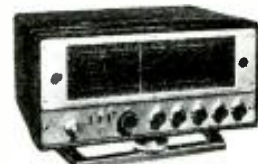
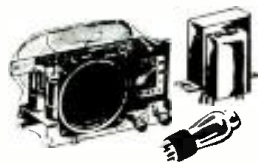

WORLD'S LARGEST STOCKS

Everything in radio for everyone in radio! ALLIED's huge stocks are the world's largest, including complete lines of all leading makes of parts and equipment. Get everything you need from one dependable centralized source—ALLIED RADIO!

TELEVISION & HOME RADIOS

See ALLIED'S outstanding selection of new Television sets, new table model radios, FM-AM combinations with new Dual-Speed Automatic Changers. Save on these radio models—the choice of experts!

AMATEUR STATION GEAR

You'll find everything you need for your shack in the new ALLIED Catalog. See all the latest releases in receivers, transmitters, parts, station equipment—the biggest and most complete listings in Ham radiol

NEW SOUND EQUIPMENT

Packaged, ready-to-use Sound Systems; amplifiers guaranteed for one full year; high-fidelity sound components; everything in speakers, mikes, P. A. accessories, intercom and recording equipment—headquarters for Soundmen!

*Radio's Leading
Buying Guide . . .*



**THE WORLD'S
LARGEST
RADIO
SUPPLY
HOUSE . . .**



ALLIED RADIO CORP.
833 W. Jackson Blvd., Dept. 2-L 8
Chicago 7, Illinois

Send FREE New 1949 ALLIED Catalog.

Name.....

Address.....

City.....Zone.....State.....

Compensating TV Amplifiers

Special circuits bring up h.f. response

By ROBERT F. SCOTT

VIDEO amplifiers are resistance-coupled amplifiers with special compensating circuits added to increase the over-all band-width. These amplifiers are commonly used in television, radar, special oscilloscope circuits, and in numerous other applications. It was shown in "Wide-Band Amplifiers" (RADIO-CRAFT, March, 1948) that high-frequency response is limited by the wiring and interelectrode capacitances shunting the output impedance of the tube. In "High-Fidelity Amplifiers" (RADIO-CRAFT, May, 1948) we found that high-frequency response can be increased—at the expense of gain—by decreasing the size of the plate load or coupling resistor. The gain at high frequencies is equal to

$$\frac{G_{if}}{\sqrt{1 + (R_{eq}/X_{cs})^2}}$$

where $G_{if} = g_m R_{eq}$, X_{cs} is total shunt capacitive reactance and

$$R_{eq} = \frac{R_L \times R_p \times R_g}{R_L \times R_g + R_L \times R_p + R_p \times R_g}$$

If R_p (the internal plate resistance of the tube) and R_g are many times larger than R_L —as they should be for good h.f. response— R_L will be approximately equal to R_{eq} . High-frequency response varies inversely as the shunt capacitance and R_L and directly as g_m .

Table I

Tube	g_m (micromhos)	Figure of Merit
6AK5	5100	750
6AG5	5000	602
6AC7/1852	9000	562
6AG7	11,000	536
EF-50	6300	484
6AB7/1853	5000	385
807	6000	333
25L6	9500	322
6SH7	4900	316
6Y6	7100	308
6AK6	2300	308
6L6	6000	272
6AQ5	4100	216
813	3750	123

The advantage of one tube over another can be determined by dividing the transconductance, g_m , by the sum of the input and output capacitances of the tube. The resultant is called the *figure of merit*. Table I shows the figure of merit and g_m of a number of tubes suitable for video amplifiers.

One of the simplest methods of compensating for the effects of shunt reactance is to insert an inductance L in series with the load resistor R_L as in

Fig. 1. The inductance and shunt capacitance, C_s , form a parallel tuned circuit, Fig. 2, resonant at some frequency outside the high-frequency limit of the am-

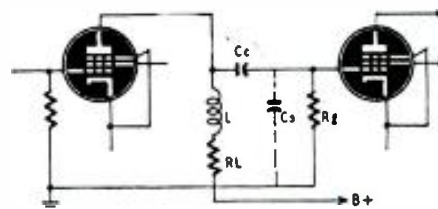

Fig. 1— L and C_s are parallel tuned circuit.

plifier. The resonant frequency should be approximately 1.41 times the h.f. cutoff frequency for best compromise between linear amplitude, linear phase response, and voltage.

In an amplifier using shunt peaking, R_L is made equal to the reactance of the shunt capacitance, C_s , at cutoff frequency or

$$R_L = \frac{1}{\sqrt{6.28 \times f \times C_s}}$$

where f is the cutoff frequency in cycles and C_s is the total shunt capacitance in farads. Input and output capacitances can be taken from a tube manual and wiring capacitance can be measured or estimated depending on the accuracy desired. The stray wiring capacitance averages between 10 and 15 μf in a well-

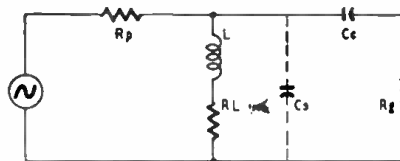

Fig. 2—Equivalent circuit of that in Fig. 1.

designed video amplifier that has been carefully laid out.

To measure the total shunt capacitance and v.t.v.m. to amplifier as shown in Fig. 3. Set the oscillator to about 1,200 cycles and adjust the output to about 10 volts or some convenient value. Measure the output of the amplifier. Increase the frequency—keeping the output of the oscillator constant—until the output of the amplifier drops to 70.7% of its value at 1,200 cycles. When the output of the amplifier has dropped to this level, the shunt reactance equals the resistance formed when the internal plate resistance, the coupling resistance and the grid resistance are considered in parallel. In order to calculate the total

shunt capacitance present use the formula

$$C_s = \frac{1}{6.28 \times f \times R_{eq}}$$

where

$$R_{eq} = \frac{R_L \times R_p \times R_g}{R_L \times R_g + R_L \times R_p + R_p \times R_g}$$

The wiring capacitance can be found by subtracting the sum of the input and output capacitances of the tubes and the input capacitance of the v.t.v.m. from the measured shunt capacitance.

These measurements are made on an uncompensated amplifier. If peaking inductors are added later, their capac-

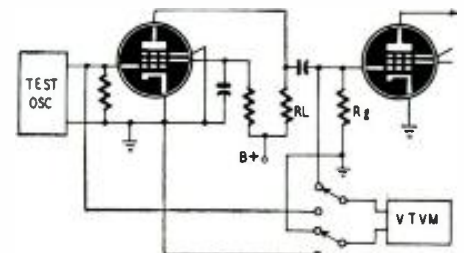

Fig. 3—V.t.v.m. measures shunt capacitance.

itance to ground will add to the stray capacitance and make previous calculations useless. If exact measurements are desired, connect a single pie of a small r.f. choke in the exact place where the peaking coil is to be mounted. Be sure to short-circuit the pie before beginning the measurements.

The value of the necessary peaking inductance can be found from

$$L = \frac{C \times R_L^2}{2}$$

Fig. 4 shows the shunt peaking constants used in a video amplifier with high-frequency response flat to 2.5 mc. The inductances are wound on forms with adjustable powdered-iron cores.

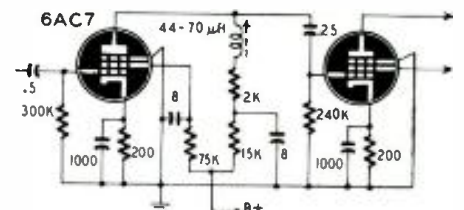

Fig. 4—Peaker gives flat response to 2.5 mc.

Figs. 5 and 6 show circuits for series peaking to compensate for high-frequency losses. These circuits function

a 10-inch set when the station changes from one sync generator to another, or from a local to a relay program.

(2) The line voltage at the receiver may change. This changes the deflection voltages and high voltages, both of which affect the picture size. (For this reason also, a TV set that is adjusted in the service shop for correct size may be found to have a smaller or larger picture on the owner's power supply.)

(3) There may be some drift in the picture size or centering during the first hour of operation.

For these and other reasons, experience has taught that it is a practical necessity to make the picture extend slightly beyond the mask.

The test pattern should be designed with this in mind. For example, if the pattern has small circles or other information too close to the corners, it may cause unnecessary headaches for the technician, because when the picture is made larger than the mask, the designs in the corner may be partly hidden. Some TV owners want to know why.

The two arcs of circles in the NBC pattern (Fig. 1) are an aid in adjusting horizontal centering. The main black circle is used in adjusting vertical centering.

The television signal controls the intensity of the electron beam in the kinescope. This beam produces a fluorescent spot of light on the inner face of the kinescope. It is this spot that "paints" the picture.

For good definition or resolution, or ability to make very small details evident and distinct in the picture, the spot must be small and round. It should be small enough so that the horizontal line structure can be seen distinctly, and it should be round in order to get the best definition from top to bottom and from left to right.

If the spot is slightly elliptical or oval shaped, instead of round, it may be rotated by adjusting the focus control, as described below.

The vertical and horizontal wedges are used in adjusting focus; they provide a check on the shape of the spot.

Closely examine the separate lines toward the narrow end of the vertical wedge, and adjust the focus control so these lines are in best focus, or sharpest.

Then look at the lines toward the narrow end of the horizontal wedge, and see if a slight readjustment of focus improves the focus on these lines.

If best focus on both the vertical and horizontal wedges is obtained at the same setting of the focus control, it may be assumed that the spot is round.

If the setting for best focus is slightly different for the two wedges, it indicates that the spot is oval. In this case it is generally preferable to adjust the control for best focus on the vertical wedge.

In most test patterns, the narrow ends of the wedges are intentionally placed near the center of the test pattern. By focusing here, it ensures that the picture will be in best focus at the center, which is desirable.

Some test patterns, such as Fig. 2,

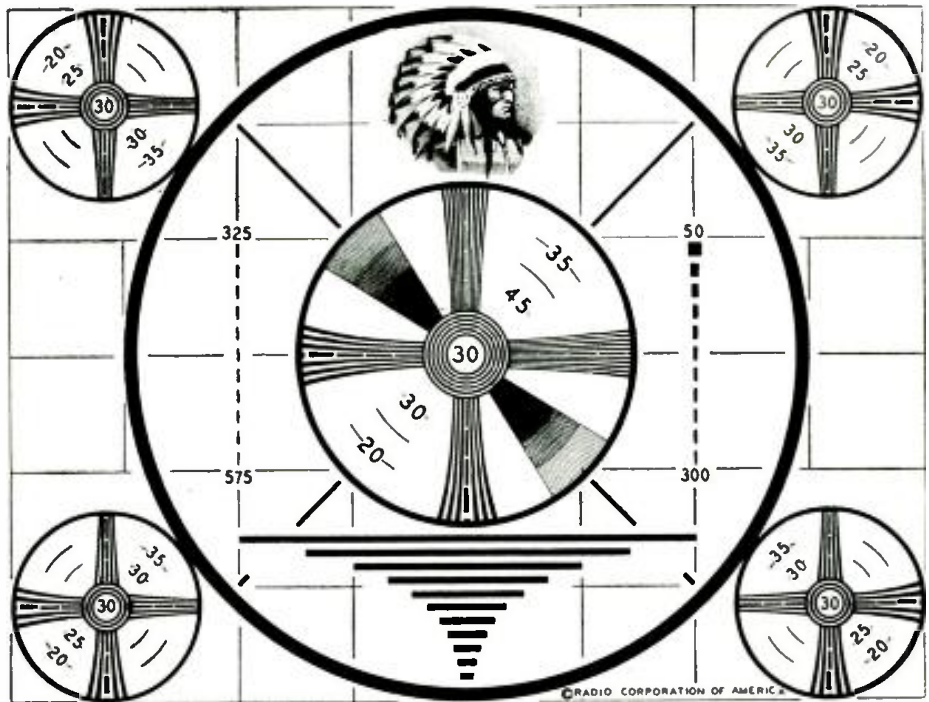

Fig. 2—With this monoscope pattern the edges of screen can be checked as well as center.

provide additional wedges in the corners to show whether the focus is good on the sides and top and bottom, compared with the center.

If focus is not reasonably uniform over the entire picture, it may indicate need for repositioning of the ion-trap magnet, or the focusing coil and focusing control.

If the test pattern does not have wedges in the corners, the horizontal scanning lines can be observed to check focus over the entire screen.

When focus must be adjusted on a program, without the help of a test pattern, it is generally satisfactory to adjust for the finest scanning lines near the center of the picture.

In projection receivers, there is the usual electrical focus control for the kinescope, and the mechanical focusing adjustments for the optical system. To prevent confusion, and to get the best possible pictures, it is important to adjust the electrical focus first while looking at the kinescope, or at the reflection of the kinescope in the spherical mirror. The optical system should not be touched until the test pattern as seen on the kinescope is sharp and clear.

If the test pattern has crossed lines in the corners and in the center of each side, and in the center of the top and bottom, they are very helpful in adjusting the reflective optical systems that are used in some projection receivers.

Contrast and brightness

Almost all test patterns include some form of shading blocks to assist in adjusting contrast and brightness.

The shading blocks have at least five shades: black, dark grey, medium grey, light grey, and white. The contrast and brightness should be adjusted so that each shade is distinguishable. With contrast too high, the darker greys become

black; and with contrast too low, the lighter greys become washed out.

If brightness and contrast are set too high, the definition will suffer, owing to "blooming" of the kinescope spot. When the spot is too bright, it grows larger, and best definition depends on a small spot.

Instead of shading blocks, some test patterns have a section of light grey



Fig. 3—Grid pattern is good linearity check.

background with white lettering, and a section of darker grey background with black lettering. This serves the same purpose as the shading blocks, and is more fool-proof, because few persons are aware of the significance of the shading blocks.

Many test patterns are designed with a grey background to secure an average modulation of 50%. This reduces the need for readjusting brightness and contrast when the station switches from the test pattern to an average program.

The horizontal wedges show lack of interlacing by a moire pattern, or wavy effect, toward the narrow end of the horizontal wedges. A moire pattern is somewhat similar to the effect that is seen when looking through two pieces of window screening, or at a piece of satin.

The appearance of poor interlacing can usually be duplicated by turning the vertical-hold control slowly until the picture is just beginning to move down. At this point the moire effect will be seen on the horizontal wedges. Also the horizontal scanning lines, instead of interlacing, will lay over each other.

Using TV Test Patterns

By JOHN R. MEAGHER

Reprinted from RCA Radio Service News, RCA Tube Department, Harrison, N. J.

WHEN something goes wrong in a television receiver, it generally shows up as a definite symptom in the picture. In no other type of electronic equipment are the troubles and symptoms so clearly displayed before our eyes.

If we learn to recognize these visible symptoms, we can quickly localize the trouble to a particular portion of the set. Even the complete absence of picture and raster tells us to suspect certain definite parts.

There is no standard test pattern in general use. The nearest thing to a standard is the RCA "Indian head" monoscope, which is used by a number of TV stations. RMA has proposed a standard "resolution chart," but for various reasons it has not been adopted by TV stations for air use.

Many TV stations have designed their own test patterns, which, although differing in appearance, are all intended to facilitate adjustments and checks in both the transmitting equipment and in the receivers.

Two typical test patterns, the NBC and the RCA Indian head, are shown in Figs. 1 and 2. The various elements are named in Fig. 1, and these names will be referred to in the following discussion.

The controls for width, horizontal drive, and horizontal linearity, and the

controls for height and vertical linearity should be adjusted so that:

- (1) The circles in the test pattern are as round as possible, and
- (2) The test pattern is slightly larger than the mask appearing in front of the kinescope.

If linearity is not correct, the circles will be flattened or egg-shaped.

In judging *vertical* linearity, it helps if you lay your head on your shoulder and look sideways at the picture. This makes vertical nonlinearity more apparent.

Many TV owners are extremely fussy about having the circles exactly round. Some of them check the circles by holding a small plate in front of the screen, and others measure the wedges to see if they are equal lengths. In some TV areas, this makes life extremely difficult for the television technicians, because it is an unfortunate fact that some stations do not transmit good linearity. Also, the linearity may be different from one camera to another. In one particular city, if the receiver is adjusted so the test-pattern circle is round on the first station, the second station will be egg-shaped vertically, and the third station will be egg-shaped horizontally.

In the latter case, it is sometimes necessary for the technician to adjust the receiver for the best compromise

linearity on all stations in the area. But it is preferable to select the station that is most likely to have correct linearity, and adjust the receiver on this station, because in time the other stations will correct their nonlinearity.

Frequently, it is necessary to install and adjust TV receivers at night or when there are regular programs, but no test patterns on the air. In such cases, it is possible to use a "bar generator" which produces a number of vertical and horizontal bars on the picture. These bars are "synchronized" by the sync pulses so that the bars remain stationary on the picture. The set is then adjusted for equal spacing between the bars.

A very useful hint for checking and adjusting vertical linearity when there are only programs and no test patterns on the air, is to turn the vertical hold control so the picture keeps rolling slowly from top to bottom. If the vertical linearity is good, the black vertical-blanking bar will remain the same thickness in all positions from the top to the bottom. There is no similar easy way to check horizontal linearity.

In a few test patterns, all circles are intentionally omitted: regularly spaced horizontal and vertical lines are used to check and adjust linearity, as shown in Fig. 3. This design of test pattern is the answer to the technician's prayers, because it avoids the trouble of the fussy customer who insists that the circles be exactly round, yet it provides a satisfactory means for adjusting linearity within reasonable limits.

Of course nothing that has been stated here should be used as an alibi to excuse poor linearity that is caused by incorrect adjustment of the receiver or by failure or change in value of components in the deflection circuits of the receiver. The question of whether the station or the receiver is at fault can be determined by experience with a number of different receivers, or by the use of a bar generator.

Most TV set owners complain if the picture does not completely fill the mask, but do not complain if a small portion of the picture is hidden behind the mask.

It would seem reasonable to make the picture exactly the same size as the mask, but this is impractical, because:

- (1) There is considerable variation in the horizontal and vertical blanking time on different stations, and on different sync generators in the same stations. Actually there may be as much as $\frac{1}{4}$ -inch difference in height or width on

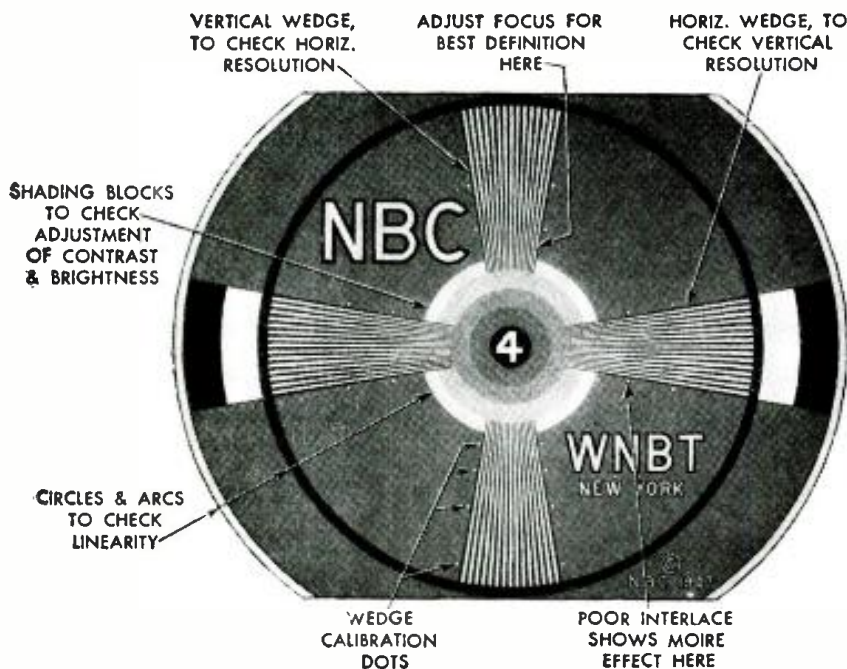

Fig. 1—This typical test pattern helps owner and serviceman adjust set for best picture.

Another type of pressure recorder makes use of a very ingenious adaptation of the Wheatstone bridge. Fig. 4 is a photograph of this device, which is known as an unbonded resistance-wire strain gauge. Its circuit diagram, which is that of a Wheatstone bridge, is represented in Fig. 5.

Whenever a wire is subjected to stress it becomes longer and thinner and, within limits, returns to its original length upon removal of the stretching force. Also, as the wire elongates and narrows, its electrical resistance increases. Therefore, the change in resistance and the reading of the galvanometer can be used as a measure of the force producing stress.

The construction of the gauge is shown in the photo. It consists of two major parts: a frame, and an armature which moves with respect to the frame. The armature is supported by two very flexible suspensions. The metallic filaments which undergo resistance changes with stress are strung on the eight posts.

Four of these are mounted on the armature and the other four on the frame. One end of each element is fixed to an armature post and the other end to a frame post.

The rod extending from the right side of the assembly is fastened to the armature. In the assembled instrument, the free end of the rod is attached to a metal diaphragm. The device operates just as does the photoelectric recorder, the changes in fluid pressure causing the diaphragm to bulge and relax. The movements of the diaphragm are transmitted to the armature via the rod. Hence, whenever the rod (and consequently the armature) is pushed to the left, the central pair of resistance-wire elements increases in length and the two outside elements contract. When the rod is pulled to the right by the diaphragm, the movement of the armature to the right will relax the central elements and stretch the outer pair. It is these four metallic filaments which are connected together to form the Wheatstone bridge.

The instrument is so constructed that the bridge is balanced and no current flows through the galvanometer when no pressure is applied to the diaphragm.

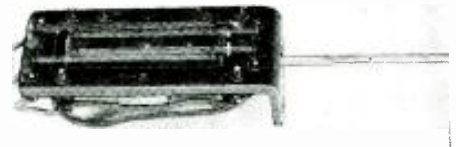

Courtesy Statham Laboratories

Fig. 4—Unbonded resistance-wire strain gauge.

Whenever the diaphragm is subjected to pressure, the stretching of one pair of elements and the contraction of the other pair unbalances the bridge. Current flows through the galvanometer and the galvanometer deflection is proportional to the pressure of the fluid on the diaphragm.

Fig. 6 is a photograph of a permanent-magnet, six-trace galvanometer assembly. Small reflecting mirrors, which replace the pointer needles, pivot with the galvanometer suspension. They can be seen through the focusing lenses in the inset. This instrument throws a moving reflected image of the light source upon a traveling light-sensitive surface to produce a permanent tape recording.

The author wishes to acknowledge the cooperation of the various manufacturers who supplied photographs for this article, particularly Statham Laboratories for providing technical data on their strain gauges.

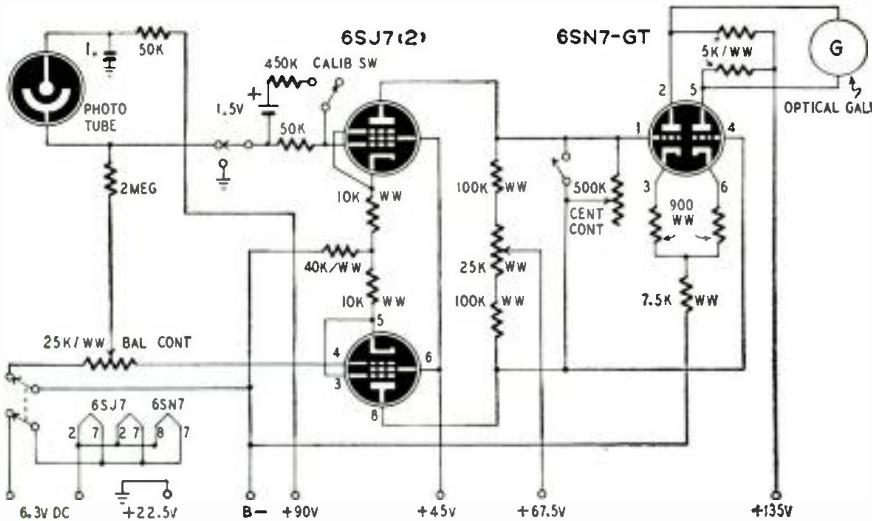

Fig. 3—This is a typical direct-coupled amplifier for amplifying output of the phototube.

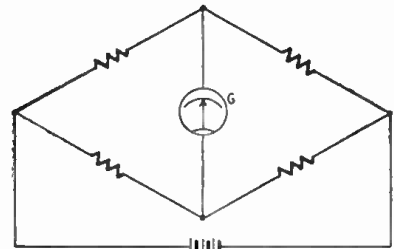
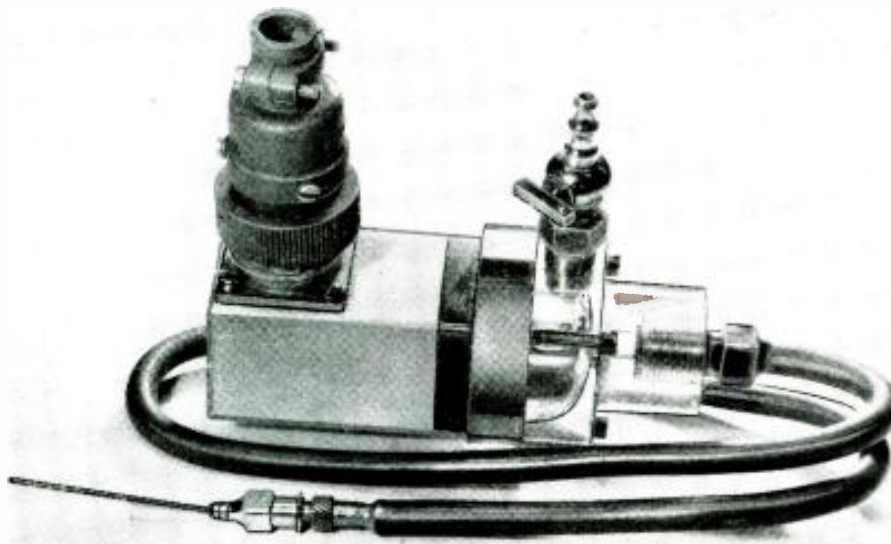

Fig. 5—Strain gauge is a Wheatstone bridge.



Photograph of the blood-pressure measuring device diagrammed in Fig. 2. Plug is for wires.

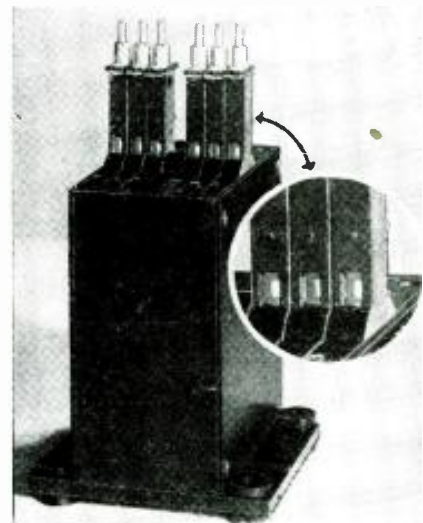

Photo courtesy Heiland Research Corp.

Fig. 6—This is 6-trace optical galvanometer.

Electronics in Medicine

Part III -- Phototubes and photoelectric cells find extensive use in medical diagnosis and examination

By EUGENE THOMPSON

THE photoelectric technique most widely used by the medical profession is *photoelectric colorimetry* or, as it is sometimes called, *photometry*. The reason for its great popularity is the astonishing rapidity and precision of this method of performing laboratory analyses, as compared to the older, time-consuming, and often inaccurate chemical procedures used for the same analyses.

In photoelectric colorimetry the physician treats the blood, urine, or other material containing the substance to be analyzed, so as to produce a colored product. The color intensity is then proportional to the concentration of the substance in the blood, urine, or other sample.

The depth of color of the solution is measured with the photoelectric colorimeter as indicated in Fig. 1-a. The light source and the battery are held to standard values, and the rheostat is previously calibrated. When the filtered light rays pass through the test tube containing the colored solution, the amount of light striking the photo tube varies with the depth of the color. The amount of light, in turn, determines the resistance of the phototube and the read-

and inflates. This procedure is somewhat inaccurate, does not permit continuous blood-pressure recording, and is not very suitable for determining the venous blood pressure. It is being replaced in many institutions by the direct method in cases which are serious enough to require more than the routine physical examination.

In the direct method of blood pressure measurement the physician inserts a hypodermic needle into an artery or vein (depending on whether the arterial or venous pressure is being measured). Fig. 2 is a cut-away view of one type of instrument used. A photograph of it appears on page 41.

The device is filled with sterile isotonic salt solution, and the needle introduced into the blood vessel. As the blood pressure varies, the pressure changes are transmitted through the needle and salt solution to the recording chamber. As the transmitted fluid pressure rises and falls within this compartment, the flexible rubber diaphragm bulges and relaxes in step with the fluctuations. The movements of the diaphragm alter the position of the light gate cemented to its surface. This motion of the gate produces variations in the amount of

very low frequency. If a d.c. signal is applied to the input of such an amplifier and maintained, the galvanometer or recording arm connected to the amplifier output will be deflected and maintained in the deflected position. If an a.c. signal is superimposed on this d.c., the recording device, besides holding an initial deflection proportional to the d.c., will fluctuate about the d.c. point in step with the superimposed a.c.

The d.c. component is the phototube output for some mean value of blood

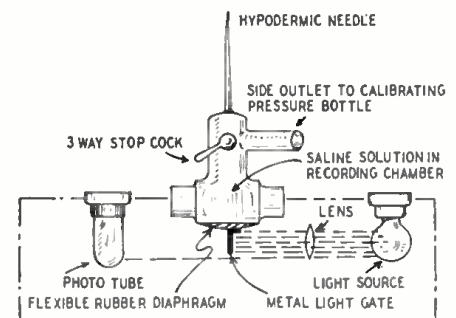

Fig. 2—Taking blood pressure with phototube.

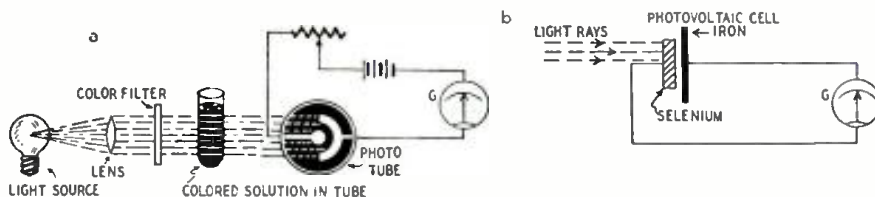

Fig. 1—Photoelectric colorimeter analyzes a substance by measuring the depth of its color.

ing of the galvanometer G. Comparison of the reading with a previously made curve showing current *versus* concentration gives the physician the desired information.

Another type of photometer employs a photovoltaic cell. The circuit is shown in Fig. 1-b. The physical arrangement is the same as that of Fig. 1-a.

One of the most important items of information needed by the physician is the arterial blood pressure. This may be determined by the indirect method using the familiar cloth cuff which the physician wraps around the patient's arm

light reaching the phototube, the output of which varies accordingly.

The resulting signals are then fed into a direct-coupled amplifier—such as the one shown in Fig. 3—the output of which actuates an optical galvanometer or electro-magnetic recording stylus. Both of these recording devices were described in a previous article on electrocardiography (RADIO-CRAFT, March, 1948).

Resistance-capacitance-coupled, transformer-coupled, or impedance-coupled amplifiers cannot be used. Direct-coupled amplifiers respond at zero or

pressure. The a.c. component is the variation, above and below this mean value, produced by the tube in response to the fluctuations of blood pressure above and below its mean pressure. Only direct-coupled (d.c.) amplifiers are usable because other types will not pass the d.c. component (the mean blood pressure), but only the a.c. signal (the periodic variations). Hence, they are of no value for quantitative analysis.

Modification of this pressure recorder makes it useful for other measurements. For example, if a length of small rubber tubing with a balloon at its free end is substituted for the hypodermic needle, the device can be used for studying the activity of the lungs, the stomach, or any part of the gastro-intestinal tract. For the latter application, the instrument is filled with some material opaque to X-rays, such as barium, and the balloon and tube passed through the mouth and down the throat. The barium permits the physician to see the position of the tube while it is in the patient's body on a fluoroscope.

ELECTRON TUBE CONFERENCE

NOT so long ago electron tubes were associated exclusively with communications. Now more and more are required for special instruments such as computing machines, one, the ENIAC, using 18,000 tubes. Many electronic instruments require great uniformity and precision in tubes.

The increasing use of tubes in research and industry inspired an Electron Tube Conference which was held recently in Philadelphia. Tube makers met tube users, and there was an opportunity to exchange recommendations.

The most frequent defects in tubes are short circuits, broken beads, uncertain life, and low emission.

Among suggested improvements were a 10,000-hour life span, lower hum and microphonics, freedom from unexpected failure, and 10% tolerance in characteristics.

The following basic tube types were discussed at the conference: double-diode (6H6), pentode amplifier (6SJ7), gating tube (6SA7), double-triode (6SN7), and beam power (6L6). Electrometer and voltage regulators were also analyzed.

One of the most common circuits used in electronic instruments is the trigger circuit which usually employs a 6SN7 or similar type. For example, about half of the tubes in the ENIAC are 6SN7's. Experience shows that this tube has a life expectancy of about 150 years of intermittent life, provided it passes the first 100 hours without developing a defect. For trigger use, it was recommended that the tube be kept within closer tolerance than at present. The most important characteristic is the bias required for plate current cutoff.

In pentode amplifiers, the important factor is uniformity. Of course sufficient degeneration cancels out the need for tube uniformity, but more gain is then required. If the 6SJ7 could be made more nearly uniform, it would be possible to get higher gain in each stage. In some cases stages could be eliminated.

Tubes of the 6SA7 type find different uses in communications than in industry. For radio the present tube is satisfactory. However, industry requires a gating tube. The two controlling grids must have independent control over the output and each should operate from cutoff to the positive grid region. It was recommended that an entirely new tube be developed for this purpose.

A more rugged, longer-life tube was recommended for the 6L6 beam tube. Improvements were asked for in leakage, hum, microphonics, and noise. The tube would have to be redesigned mechanically to stand shock and vibration.

The plan also includes more conservative voltage, current, and temperature ratings, without much change in the present gain and output. This could be done by redesigning the tube structure.

It is felt that the conference will result in improved tube design.

A second conference on electron tubes is planned for next year.—I. Queen

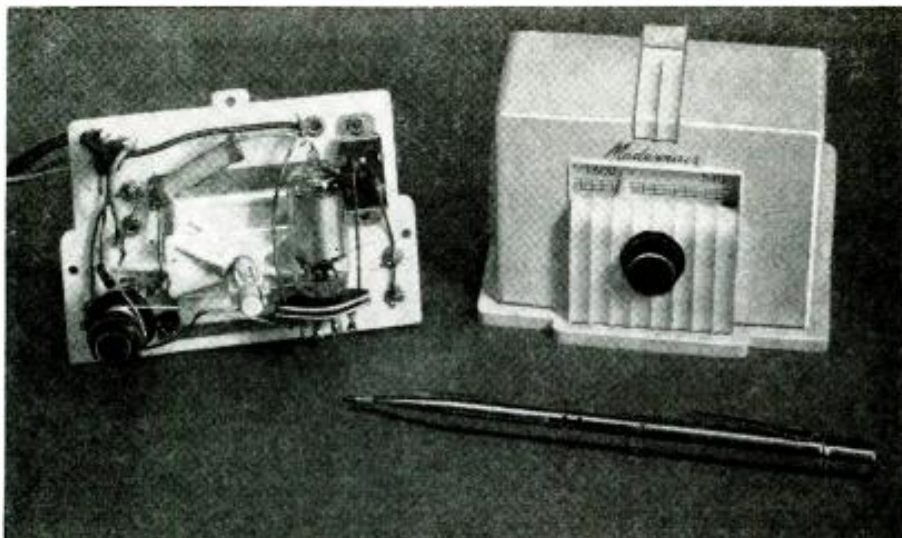

Fig. 5—The Modernair uses a book condenser for tuning. Case and chassis are white plastic.

because the electromagnetic vibratory system is so small.

The editors were surprised at the high sensitivity of such a low-priced (under \$5.00) toy telephone. Conversations were held without difficulty and with good intelligibility.

The Little Orphan Annie Portable Radio-Phone, a small radio receiver made by the same manufacturer, appears in Fig. 3 alongside a regular telephone instrument. Inside the red plastic base of the Radio-Phone are the components, consisting of a tube, coil, condenser, and batteries. See Fig. 4. An on-off switch is on the front of the case and antenna and ground clip-leads come from the rear. The headphone is contained in the handset, in the same place where a telephone receiver would normally be. There is, of course, no transmitter in the handset.

The set is tuned by rotation of the telephone dial. The tuning element is a coil with a movable core. This permeability tuner is linked to the dial by a dial-cord arrangement. The dial is not calibrated though the numbers from 1-0 can be used as a guide.

While an outside antenna aids reception, especially in weak-signal areas, clipping the antenna lead to almost any metal object will suffice if there is a strong local signal. The inside of the cover of the box in which the radio comes is metallized and a terminal is provided for attaching the ground wire. This counterpoise ground also helps reception. In downtown New York City the box cover was attached to the antenna lead and the radio was carried around, giving good reception almost all the time. The sound was not always loud but it was sufficient.

The Modernair, pictured in Fig. 5, uses almost exactly the same circuit as the previous set. It is made by the Vaugh Manufacturing Co. The tube, however, is a 1L4 and tuning is done with a "book" condenser. This condenser, which looks like a large-size compression trimmer is compressed and expanded by the plastic tuning shaft, which screws in and out of a threaded hole. The slide-

rule tuning indicator is moved by a gear on the tuning shaft. The on-off switch is on the rear of the case. The plastic "chassis," shown on the left in Fig. 5, holds all components except the tuning indicator. It fastens to the back of the case with three machine screws. Batteries are exposed at the rear for easy replacement. Two pen-light cells and miniature 22½-volt batteries are used. A standard single earphone is permanently attached. A tryout showed about the same results as the previous receiver.

General Electric's toy record player, shown in Fig. 6, is all-electronic. A standard electric motor is used. The amplifier, powered from 117-volt a.c. or d.c. lines, puts a maximum of three-quarters of a watt output into a built-in 4-inch PM speaker. Two tubes are used, a rectifier and an amplifier. The pickup is a high-output crystal with replaceable needles. Since it is made especially for children, care was taken to make it safe. All electronic parts are inside the case away from prying hands, and the metal pickup arm is sufficiently isolated from the power line to avoid any shock.

The player will handle ordinary 10- and 12-inch records, as well as those made for children in the 6- and 8-inch size.

Though the amplifier will operate on d.c. the motor will not.



Fig. 6—Complete G-E phonograph for children.

ELECTRONICS in the Toy World

By

RICHARD HENRY

THAT this is the age of electronics is made clear by the multitude of electronic devices which appear every day in business and at home. The younger generation also has a place in the world of electronics, for even very young children will enjoy many of the new electronic toys put on the market recently. Among the devices especially designed for children are a sound-powered 2-way telephone, a small all-electronic record player and miniature radio receivers operating on tiny batteries and selling for less than \$5. These devices widen the gulf between a child's life today and the rag-doll-and-coaster-wagon era of a few years ago.

One of the most interesting of these gadgets is known as the Buck Rogers Supersonic Two-Way Transceiver, man-

ufactured by Da-Myco Products Company of New York. Although there is nothing supersonic about this toy, it does give very usable 2-way communication without any batteries. The two

esting that it well deserves the attention of telephone receiver manufacturers who wish to try for the greatest possible sensitivity. They work on the electromagnetic principle first discovered by Alexander Graham Bell. The earphones are, therefore, reversible—each can be used also as a transmitter as, in fact, it is.

In the usual earphone a rather thick soft iron diaphragm is used. Its diameter is usually about 2 inches. If very strong magnets are used the entire diaphragm is pulled down; this greatly impedes vibration making a fairly strong current necessary for operation of the telephone.

The makers of the new toy have gotten around this difficulty and actually made an earphone which is self-amplify-

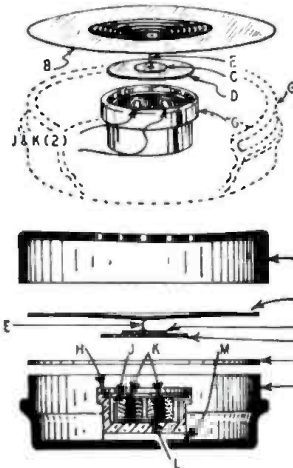

Fig. 2—Parts of the earphones. A—Cap made of plastic; B—Diaphragm; C—Reinforcing disc on armature; D—Armature; E—Wire connecting armature to diaphragm; F—Cushion ring; G—Plastic case; H—Brass shell; J—Coil winding; K—Alnico magnet. Units receive and transmit.

identical instruments used are shown in the photograph and cutaway drawings of Figs. 1 and 2.

Each instrument is a specially designed earphone. These highly ingenious self-amplifying earphones are, of course, a toy, but the principle used is so inter-

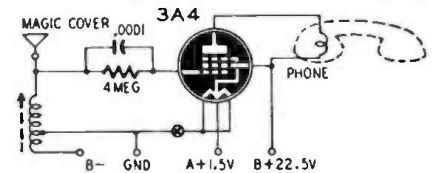

Fig. 4—Diagram of Orphan Annie Radio-Phone.

ing. Instead of the 2-inch diaphragm, they have used a very small iron diaphragm measuring $\frac{3}{8}$ inch in diameter. This is fastened rigidly to a thin brass amplifying cone which is able to swing freely under the influence of the small diaphragm. A powerful electro-magnet can now be used without hampering vibration. An Alnico magnet is used in the toy. Great sensitivity is available

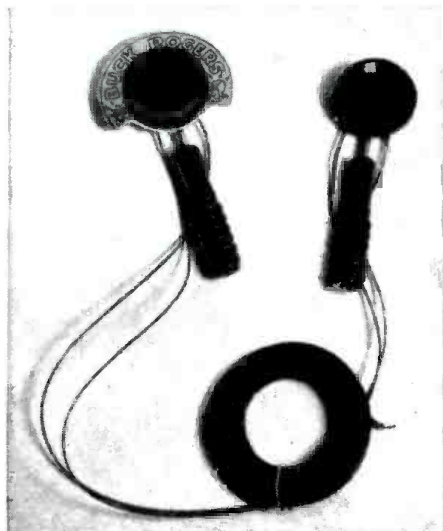

Fig. 1—The Buck Rogers phone instrument.



Fig. 3—Toy radio at left is tuned by turning the "telephone" dial. Standard phone at right.

first. The discriminator is a Foster-Seeley circuit using crystal diodes. The 2E36 a.f. amplifier is transformer-coupled to a receiver in one end of the handset. A switch on the handset operates the filament changeover relay to switch power to the transmitter.

The transmitter

There are 8 tubes in the transmitter; two are miniature and the others are subminiature types. The 5672 crystal oscillator, No. 14, is wired with the crystal between the grid and screen grid. The signal from the oscillator goes to the 2E36 phase modulator. This tube is so connected across the output of the

oscillator that the phase of the signal varies with the audio signal at the grid of the modulator. Transformer coupling is used between the microphone and the control-grid of the modulator.

The phase modulator is followed by a 2E36 buffer operating straight-through. Two triplers and a doubler raise the phase modulated signal to the operating frequency. The second tripler uses a pair of 2E36's in parallel.

Construction

Construction and maintenance of a 19-tube unit as compact as this Handie-Talkie transmitter-receiver would present many problems were it not for the

cellular type of construction. The tubes and all components associated with each stage are on plug-in sub-assemblies.

This type of construction simplifies servicing and reduces to a minimum the time a unit must remain out of service for repairs. As soon as a defective stage is isolated, it can be replaced by a good one and the unit put back in service.

The defective unit can be repaired at a more convenient time and placed in stock for replacement purposes when needed.

Metering points are provided for trouble-shooting and adjusting the transmitter power amplifier or the receiver mixer and limiter circuits.

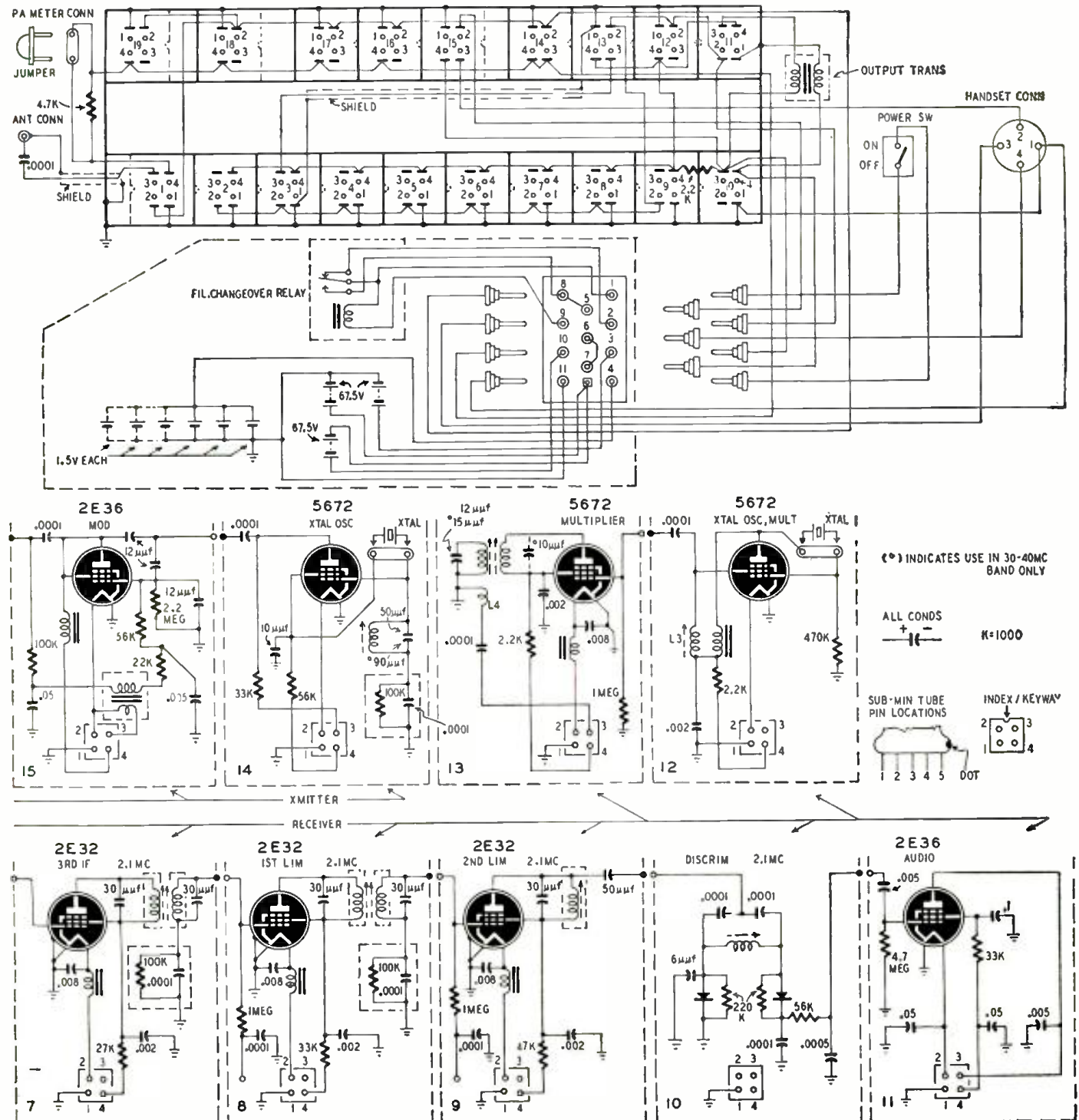



The top cover and nine of the plug-in units have been removed to show chassis construction.

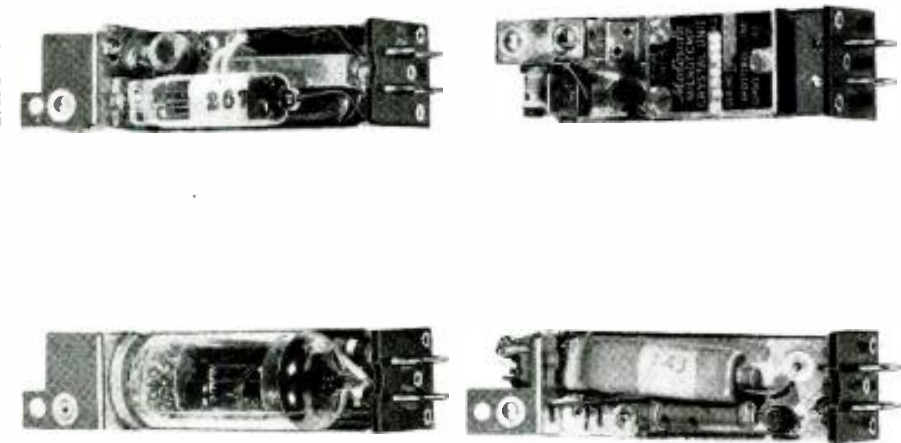

Each of the plug-in units has a plug at the bottom. There are wiping contacts at the top.

Crystals for the high-frequency model range from 6.15 to 7.98 mc and those in the low-frequency set are between 4.65 and 6.31 mc. L3, in the screen-grid circuit, is adjusted to resonate at three times the crystal frequency. The third harmonic of the crystal is amplified and coupled to the grid of the 5672 frequency doubler, No. 13. The output of the doubler—six times the oscillator frequency—is the heterodyning frequency. It is coupled to the input of the mixer, No. 4, through L4 and L5. The heterodyning frequency is 2.1 mc lower than the operating frequency.

The mixer works into a 3-stage 2.1-mc intermediate-frequency amplifier. Miniature i.f. transformers are used. The primary and secondary coils of each are tuned by varying the position of powdered-iron cores within the coils. The secondary of the i.f. output transformer feeds into the grid of the first stage of the cascade limiters. Both limiters have the same time-constant but the second limiter is operated at a lower plate voltage than the first. This second stage removes any amplitude variations that may pass through the

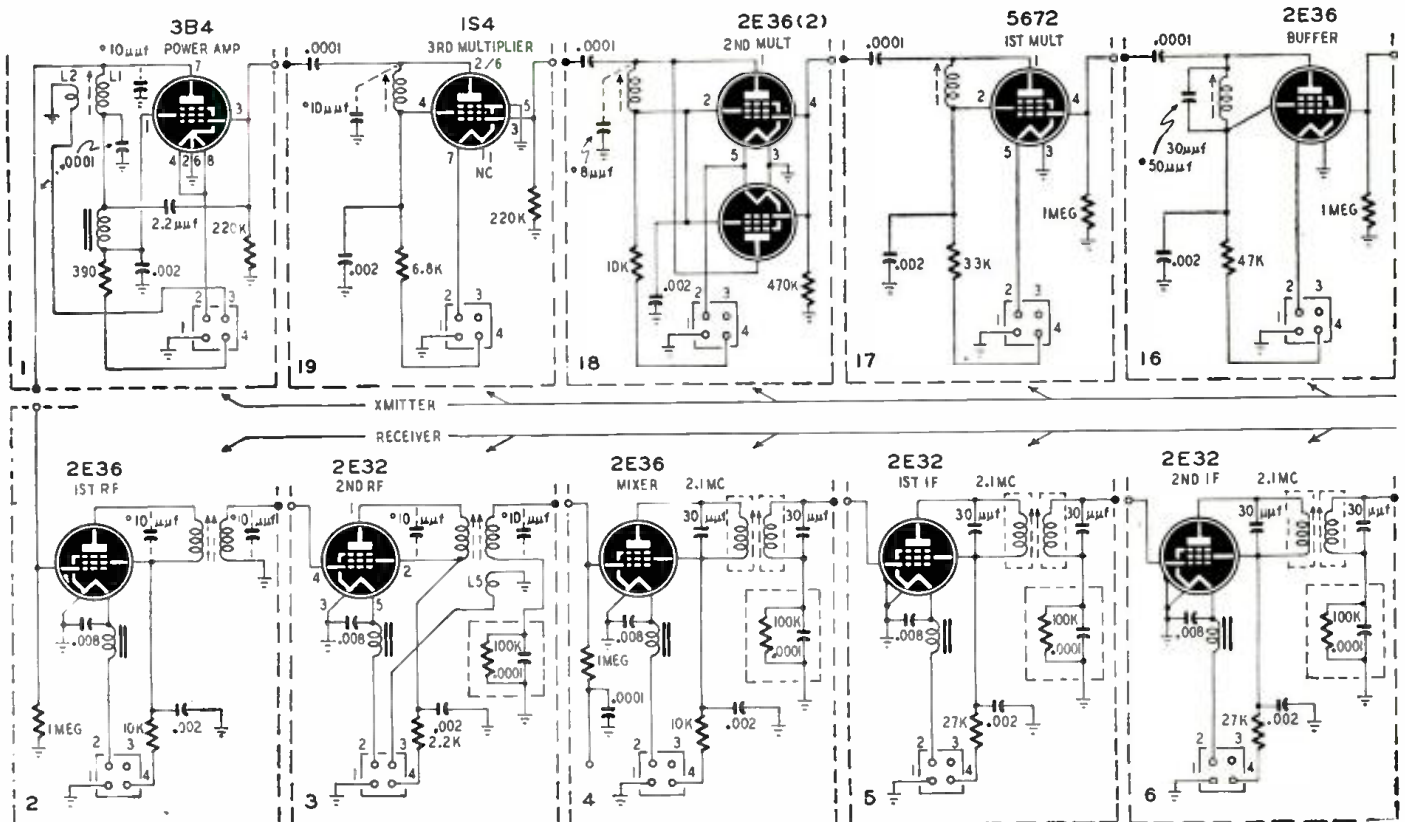
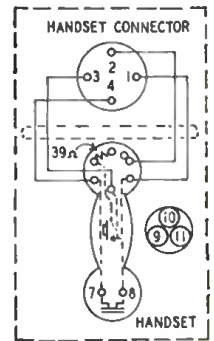
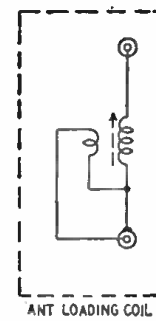

Cover Feature

FM Handie-Talkie Radio for Industry

Radio can be used as a vital link between working teams. The new Motorola FM Handie-Talkie unit is suitable for many industrial applications

THE new Motorola FM *Handie-Talkie** transmitter-receiver unit is designed for use by police, fire-fighters, public-utility and construction workers, rescue and emergency teams and in other applications where a light-weight, low-power transmitter-receiver is required. Its 9.8 pounds include an 8-tube transmitter and 11-tube receiver. Its case is 10 inches high, 12 $\frac{1}{2}$ inches long and 3 $\frac{1}{2}$ inches wide. It is designed to be carried in the hand or strapped to the body. A handset clips into a cradle on top of the case when not in use.

A 43-inch base-loaded whip-antenna is standard equipment, but any 50-ohm antenna can be used to increase the range when the unit is used in fixed or semi-fixed locations. It is normally supplied with a battery power pack. Vibrator packs and a.c. supplies are also available.

A power switch is located on one end of the case. The receiver remains on when the switch is closed. The transmitter is turned on and the receiver off in the standard manner by a push-to-talk switch on the handset. The transmitter and receiver are crystal controlled.

The Handie-Talkie radio is available in two models. The FHTR-1AL and FHTR-1AH operate on any predetermined frequency in the 25 to 40-mc and 39 to 50-mc bands respectively. The units are tuned to the desired frequency at the factory.

A unique cellular construction is used in the chassis. There are 19 cells, each housing a complete plug-in stage. These cells are shown in the photographs and are numbered and separated by broken lines on the diagram on pages 36 and 37.

*Trade mark of Motorola, Inc.

NOVEMBER, 1948



This is the portable radioset. The antenna, handset and bottom cover have been removed.

The receiver

There are 11 subminiature tubes in the receiver. They are: 2E36, first r.f. amplifier; 2E32, second r.f. amplifier; 5672, oscillator-multiplier; 5672, multiplier; 2E36, mixer; 2E32's as first, second and third i.f. amplifiers and cascade limiters; and a 2E36 audio amplifier. Crystal diodes are used in the discriminator circuit.

The grid of the first r.f. amplifier, cell No. 2, is capacitance-coupled to the plate end of L1, the power-amplifier

tank coil of the transmitter. This is the common antenna secondary coil for both transmitter and receiver. L2 couples the resonant coil to the antenna when transmitting and receiving. All coils between the antenna and the grid of the mixer are tuned to the operating frequency.

Low-frequency crystals are used in the crystal oscillator-multiplier, No. 12. The crystal is between plate and grid. A third harmonic is developed in the screen circuit. (Cont. on next page)

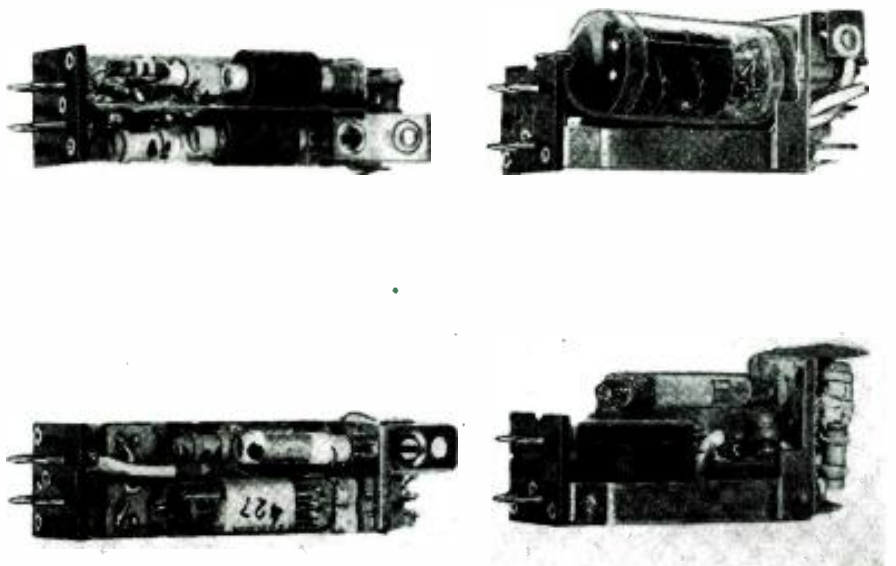

Four of the nineteen plug-in stages are shown. Cellular construction simplifies servicing.

the ratio detector, connect the network from plate to ground of the next to the last i.f. tube. In Philco sets, connect it from plate to ground of the last i.f. stage. (It is important to keep the signal generator output as low as possible for all i.f. and r.f. adjustments.)

First place the load network across the proper stage as outlined above and adjust the secondary trimmer of that stage for maximum output. Then remove the loading network and connect it from the grid end of the same trans-

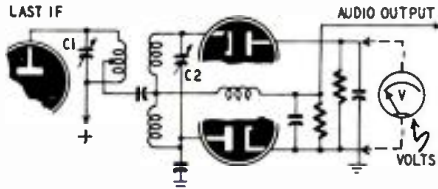

Fig. 3—Meter connection for ratio detector.

former to ground. Align the primary trimmer for maximum output. Follow this routine through to the first i.f. stage, adjustments being made with the signal generator connected to the converter control grid. After the adjustments have been completed remove the loading network.

Front-end alignment

Connect a 70-ohm resistor across the signal generator output terminals and connect the output leads to the antenna terminals of the receiver. With the generator and receiver set at 105 mc, adjust the oscillator trimmer for maximum output. Set the receiver to 88 mc and check oscillator tracking by tuning the generator slightly to either side of this frequency. Spread or compress the turns of the oscillator coil very slightly, if necessary, to bring the signal generator in at the 88-mc setting. Then repeat the adjustments at both ends of band until no further improvement is noted.

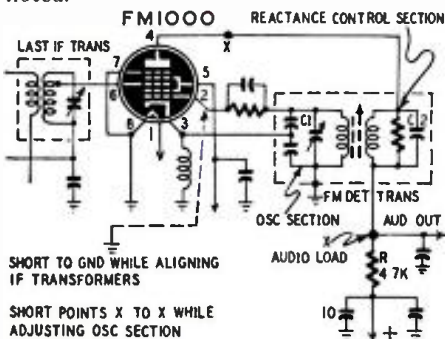

Fig. 4—Philco detector contains oscillator.

Set the generator and receiver at 105 mc and adjust the converted trimmer for maximum output. Rock the tuning condenser of the signal generator when making this adjustment.

If the receiver has no r.f. stage, make the adjustment as follows: connect two 30-inch lengths of wire to the signal generator and two identical lengths to the receiver antenna terminals. Bend each to form a simple dipole and place the generator several feet away from the receiver. Set the generator and receiver to 105 mc and adjust the r.f.

trimmer for maximum output. Set the generator and receiver to 92 mc and check tracking of the converter grid with a tuning wand. A decrease in signal when either the iron or brass end is inserted in the coil indicates proper tracking. If the output increases with brass inserted, spread the coil slightly; if the output increases with the iron end inserted, compress the coil. Repeat all oscillator, converter, and r.f. adjustments until maximum results are obtained.

Limiter and detector

In receivers using two limiter stages, the second limiter must be adjusted before proceeding to the detector.

With the d.c. indicating meter still connected as before, connect the signal generator to the grid of the i.f. stage preceding the first limiter and connect the loading network from plate to ground of the same stage. Then carefully retune the generator to the center intermediate frequency, as indicated by maximum reading on the meter.

Remove the loading network and connect the indicating meter to the grid of the last limiter. With the generator connected to the first limiter grid, connect the loading network from the first limiter plate to ground. Adjust the input trimmer of the second limiter for maximum reading. Then, with the loading network connected from the second limiter grid to ground, adjust the first limiter plate trimmer for maximum output. Remove the meter and loading network.

For detector adjustments, an FM signal generator and oscilloscope should be used to observe detector linearity. If these instruments are not available, proceed with the AM generator. For all detector adjustments, use an insulated, nonmetallic alignment tool. Alignment procedure depends on the type of detector circuit incorporated in the receiver.

With the Armstrong discriminator, connect an audio output meter across the speaker voice coil. With the signal generator connected to the grid of the i.f. stage preceding the limiter (but with loading network and d.c. indicating meter removed), tighten the discriminator balancing trimmer to detune the circuit. With the output of the signal generator as low as possible, adjust the plate trimmer (C1 in Fig. 2)

for maximum audio output. Adjust the balancing trimmer (C2) for minimum audio output. The output should increase sharply on either side of the minimum setting.

Ratio detector

Connect the d.c. indicating meter as shown in Fig. 3. (Use the 10- or 50-volt range of the meter.) Connect the generator to the grid of the next to last i.f. tube; connect the loading network from plate to ground of this stage. Reset the generator to the center intermediate frequency, as indicated by a maximum reading on the d.c. meter. Remove the loading network.

First adjust the diode trimmer (C2 in Fig. 3) for maximum output, then adjust the plate trimmer C1 for maximum reading. Remove the d.c. meter and retrim C2 for minimum audio output. Output should increase sharply on either side of the minimum setting.

The Philco detector (Fig. 4) is adjusted by tuning the oscillator section to zero beat with the signal generator, which is tuned to the center intermediate frequency and connected to the i.f. stage immediately preceding the detector.

With the audio output meter across the speaker voice coil, connect the generator to the input of the last i.f. stage and the loading network across the primary of the last i.f. transformer.

With the oscillator grid (pin 2 of the FM1000 tube) grounded, modulate the signal generator and retune to the center intermediate frequency, as indicated by maximum audio output. (For this adjustment keep the generator output as low as possible.) Then remove the short and take out the loading network and output meter.

Short pin 4 of the tube to the audio load resistance R (Fig. 4). Then turn off the generator modulation and adjust the oscillator trimmer C1 to zero beat.

Remove the short and adjust the reactance-control trimmer C2 for zero beat. This adjustment is rather sharp; use a very low input signal from the generator.

This step-by-step alignment procedure is the one recommended by Philco for alignment of FM receivers without an FM signal generator or oscilloscope. The Philco Model 7070 r.f. signal generator was used for making the adjustments.

FM STATIC SHIELD

My FM receiver was picking up automobile spark interference. Working on the theory that noise travels in straight lines, I made a shield and placed it on the antenna mast so that it intercepts ignition radiation from cars on the road below, but allows the FM signals to pass over the top of the shield and strike the antenna. The scheme is shown in the drawing.

The shield is made from metal lath such as that used as a plaster base in most houses. It can be obtained at any lumber yard. The sheet is bent into a

U-shaped trough and held that way with heavy wires. It is mounted on the mast (which passes through a hole in it) just below the dipole.

The shield eliminated about 90% of the noise.

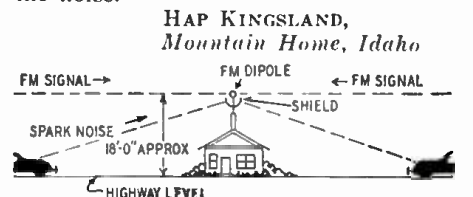

Aligning FM Receivers

You can align any FM receiver without an FM generator or 'scope. This article gives the alignment procedure in step-by-step fashion

By JOHN B. LEDBETTER

IT IS a relatively simple matter to align an FM receiver when the service manual is available and the proper instruments are on hand. But when a new or unfamiliar receiver comes into the shop without alignment instructions or when the FM signal generator and oscilloscope usually specified in the service manual are not available, proper alignment becomes a more difficult undertaking.

Most FM receivers can be aligned with an AM signal generator, provided the generator's frequency range extends to 105 or 110 mc, and provided the serviceman knows the proper function of each stage of the receiver. The only additional equipment needed is an output meter, a 20,000-ohm-per-volt d.c. meter, an insulated alignment tool, and a tuning wand.

Circuit characteristics

In an FM receiver, the r.f., converter, and oscillator circuits may be aligned by peaking for maximum output. They are heavily damped to allow broad response, and present no unusual problems in alignment.

The main difference between i.f. transformers in AM and FM receivers is the band width. The maximum width required in the best AM receivers is 10 kc, whereas an FM i.f. transformer must have a flat-top characteristic over

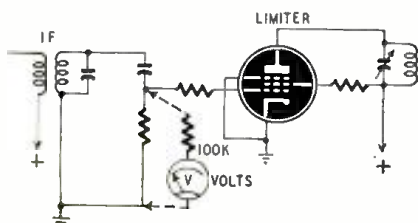

Fig. 1—Meter placement for aligning i.f.'s. a band width of 200 kc. Two basic methods are used to obtain wide-band response: overcoupled transformers and single-peak transformers.

For overcoupling the i.f. coils have

been placed physically close together, past the point of critical coupling, so that a flat-topped response curve is obtained. Transformers of this type cannot be aligned by peaking for maximum output. An attempt to align overcoupled transformers by peaking would throw some or all the i.f. tuned circuits off the center frequency.

Single-peak i.f. transformers are designed to have relatively high gain at the center frequency, at the same time having a Q sufficiently low to give broad response over the required band. They may be peaked for maximum output.

Three basic types of detectors are in use. They are the Armstrong discriminator, the ratio detector and the Philco.

The Armstrong system employs a duo-diode frequency discriminator, preceded by one or two limiter stages. An amplitude-modulated signal cannot be used for alignment because the limiters

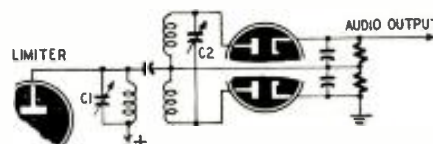

Fig. 2—This is the Armstrong discriminator.

remove most of the AM component from the i.f. signal. However, since the i.f. signal causes d.c. grid-current flow in the limiter which is dependent on the signal amplitude, i.f. alignment adjustments can be made with an ordinary 20,000-ohm-per-volt d.c. meter as the tuning indicator. (See Fig. 1.) To prevent detuning the limiter a 100,000-ohm resistor should be inserted in the test prod when it is attached to the Armstrong circuit. The meter may be used for all r.f. and i.f. adjustments; it should be connected across the first limiter output if two limiters are used, then connected to the second limiter for alignment of the first limiter stage.

In the ratio detector, which also uses two diodes, a high-capacitance condenser is charged at a varying rate by the i.f. signal.

The Philco detector has a special tube (FM1000), part of which acts as a Colpitts oscillator operating on the center intermediate frequency. The i.f. output is fed into an injector grid of this tube, and the reactive coupling between the pentode section and the oscillator causes the latter to lock in and follow the frequency variations of the i.f. signal. In a receiver employing the Philco detector, the oscillator control grid must be shorted to ground before the r.f. and i.f. stages can be aligned. The pentode section then acts as a regular AM detector; and r.f., i.f., and oscillator adjustments can be peaked with a modulated AM signal generator for maximum output.

I.f. alignment

First determine the type of detector employed. Then connect the signal generator accordingly. In the Armstrong detector the generator is connected to the last i.f. stage preceding the limiter, or to the first limiter if two are used. In the ratio detector, the generator should be connected to the control grid of the next to the last i.f. stage. (Alignment is always begun with the last i.f. stage and worked back to the converter.) In the Philco circuit, the signal generator is connected to the control grid of the last i.f. tube.

With overcoupled i.f. stages a loading network, consisting of a 0.1- μ f condenser in series with a 4,700-ohm resistor, must be placed across the coil opposite the one being tuned, to allow each coil to be aligned for maximum output without affecting the center frequency of the other. If you are not sure whether the receiver has overcoupled or single-peak i.f. stages, connect the loading network anyway and proceed as if the stages were overcoupled. Use of the network will not affect the tuning adjustments in single-peaked stages.

In the Armstrong circuit, the load network is connected from limiter plate to ground (first limiter plate to ground if two limiter stages are employed). In

RY1 opens contacts 6 and 7 to turn off the recorder.

When a signal is received, C8 charges through contacts 3 and 4. When RY1 opens, the condenser discharges into the grid circuit of the 6SJ7. This positive pulse makes RY1 act quickly and positively without chattering. The 0.5- μ f condenser across RY1 bypasses surges resulting from static and random noise in the receiver.

Terminal No. 2 ends in a phone plug, which is inserted in the receiver metering jack, and the metering switch is turned to No. 1 position (or if separate jacks are used, to the appropriate jack). The grid of the 6SJ7 will then be in

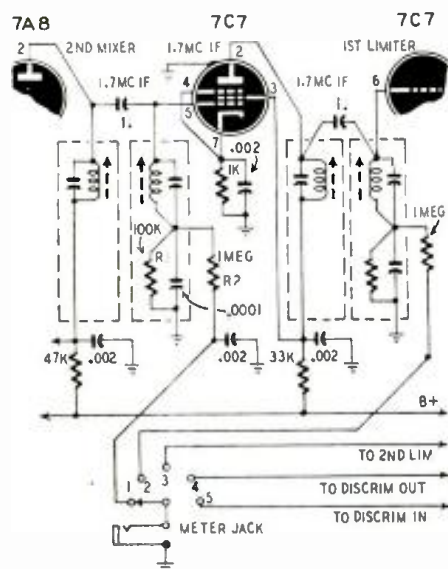

Fig. 3—Low-frequency i.f. of the FM receiver. either the grid circuit of the low-frequency i.f. tube or the first limiter.

A grid resistor is unnecessary in the 6SJ7 circuit. The grid return is through R1 and R2 (Fig. 3).

Terminal No. 3 is connected to the hot or ungrounded side of the plate transformer primary in the transmitter. When the transmitter is turned on its plate transformer is furnished line voltage by the keying relay in the transmitter. This feeds line voltage to the a.c. relay RY2 in the keyer from terminal No. 3 and the recorder is started to record the transmitted message. Note this is done through points 1 and 2 of RY1. Thus, primary voltage cannot be placed back on the primary of the transmitter plate transformer when RY1, due to received signal, actuates RY2, as the points 1 and 2 will have opened the line to terminal No. 3 and the plate transformer in the transmitter. R5, R6 and R7 are taps on a voltage divider. A 100-watt size is used for ease in adjustment of the taps. The total value of the divider is 15,000 ohms, and the bleeder current, used to help stabilize circuit voltages, must be taken into consideration in setting tap points, the values of which are shown in the schematic.

The recorder itself must be modified to permit all internal circuits to remain hot except the motor. An added d.p.d.t. toggle switch in the recorder permits throwing the hot side of the motor ei-

ther to the regular line terminal for normal operation or to J2 by means of a connector cord for automatic operation. S2 permits the sensitivity of the keyer to be set to operating point by means of R3 and the indicator lamp before the recorder is turned on. The outer conductor of the connector cable between J2 and the recorder is used to complete the ground return between the two units. This is necessary to reduce hum in the recorder.

An ordinary wall receptacle is used for connecting the power cord of the recorder. It may be necessary to polarize this receptacle because of the transmitter keying circuits introduced into the keyer through terminal No. 3. For this reason the power cord of the keyer is attached in the transmitter across the line fuse block to insure against possible mixup. All cables and terminals are color-coded. S1 is the power on-off switch.

In the event the radio equipment is not remote-controlled, the two-way recording can be obtained with the recorder microphone instead of connections from terminal Nos. 4 and 5. Simply place the recorder mike in common

proximity to the receiver speaker and the operator's microphone. The recorder will continue to operate automatically and will record both sides of the traffic.

It is possible this type keyer will have two advantages over the better-known voice-operated circuits, especially as used in radio networks. The instant a carrier appears in the receiver the keyer will start the recorder or other device before audio is present, thus allowing the recorder to reach operating speed and eliminating wow. Also, in FM receivers the saturated limiters produce terrific audio, due to amplified thermal noise, when the squelch is opened by weak and undesired signals as is often the case. This noise audio would trip a voice-operated keyer and the result would be considerable loss as far as recording is concerned.

In actual operation the keyer described can easily be tripped by signals received from 50-watt stations operating from the 200-foot towers in the 30-40-mc band in excess of 125 miles and by mobile units 40 miles distant. Its application in the 72- and 156-mc bands will prove just as effective according to the area covered.

NEWLY-DEVELOPED RECEIVING TUBES

Three new miniature tubes were announced recently by RCA and a new type of tube construction is being used by Raytheon.

The new tubes are 6BA7, 12BA7 and 6AR5. The 12BA7 has the same appearance as the 6BA7 shown on the left. The 6AR5 is shown at the right. Both the 6BA7 and 12BA7 are pentagrid converters with the same characteristics as the standard-size 6SB7. Differing only in filament characteristics, these two miniatures are especially recommended by RCA for service in the 88-108-mc FM band.

The 6AR5 is a beam power tube. It is intended for use in the output stage of automobile and compact a.c.-operated receivers. It delivers a moderate power output with relatively small input voltage. Within its maximum ratings, it is the performance equivalent of the 6K6-GT.

The heater of this tube operates at 6.3 volts, 0.4 amperes. Maximum voltage is 250 volts for plate and the screen-grid. When operated as a class-A amplifier, plate and screen are operated at 250 volts. With 16.5 volts of bias, maximum plate and screen currents are 45 ma and 10 ma respectively. The gm is 2,400 micromhos, plate resistance 65,000 ohms and the load resistance is 7,000 ohms. Maximum power output is 3.2 watts with 7% total harmonic distortion. With 18 volts of bias; plate current is 33 ma, screen current is 10 ma, gm 2,300 micromhos, plate resistance 68,000 ohms, and load resistance 7,600 ohms. Maximum power output is 3.4 watts with 11% distortion. Resistance in the grid circuit should not exceed 100,000 ohms for fixed bias or 500,000 ohms for cathode bias.

The maximum plate dissipation is 8.5 watts and screen dissipation is 2.5 watts. Do not permit the voltage between the heater and cathode to exceed 90 volts in either direction. The Raytheon Bantal-type tube has increased ruggedness due to an 8-pillar support construction. Each tube has an internal shield, short leads with wide spacing and other structural advantages. The Bantals are at present manufactured to replace the 6SA7-GT, 6SJ7-GT, 6SK7-GT and 6SQ7-GT.



A Carrier-Controlled Recorder

By RHETT McMILLIAN*

Messages are logged automatically

"If I just had a recording of that!"
That, of course, being some piece of monitored air traffic which, having come fleetingly to one's attention, is as quickly irrevocably gone. Such expressions are familiar to all in communication circles. Too many times has an occasion abruptly shown the need of an exact replica of a certain transmission in such fields as police, fire, taxi, marine, railroad, and other branches of the so-called emergency services.

Wire recorders are satisfactory for copying such transmissions; however, the longest average recording time of most of these instruments, without rethreading, is one hour. It being impossible to predict when a call will be received over the radio system, the recorder is normally run continuously to assure a record of all transmissions. This results in miles of dead wire and numerous later hours wasted in playback monitoring. Also, because of the necessity of changing wire spools every hour, the recording equipment must be placed in the dispatch room so the operator may have access for servicing. Satisfactory operation may be impaired because of operator failure in attending the equipment, especially in the event of irregular traffic in which the personnel is involved.

The keying device shown in Figs. 1 and 2 was developed to turn on the recorder whenever a signal is being received or transmitted. When the keyer is used with a recorder, several hours—and often days—can be reduced to one hour of continuous recording. The net recording time will naturally be influenced by the amount of the traffic load on the net.

The device described was designed to work in conjunction with a Motorola FM 30-40-mc receiver and associated transmitter, one of the many popular brands of emergency radio equipment. There should be no serious difficulty in adapting the keyer to operate from practically any receiver, including AM a.v.c. circuits. However, to design such an instrument to operate from all the many types and makes of receivers would be highly impractical from a field service standpoint, especially inasmuch as one radio system will not ordinarily employ more than one type of manufactured equipment.

The greater majority of emergency services now use or intend to use, frequency-modulated equipment. Therefore, the discussion of the simple cir-

cuit will be limited to its intended use with an FM receiver. No alterations or changes are necessary in the receiver. Phone jacks or one jack with a selective switch are usually provided for measuring voltage or current while tuning the FM receiver circuits. One of these metering voltages triggers the keyer. The keyer is set off by the negative voltage developed across the metering resistor in the grid return of the low-frequency i.f. stage in the double-superheterodyne receiver.

The schematic of the keyer is shown in Fig. 1. It is essentially a d.c. amplifier with the 6SJ7 drawing enough current to reduce the plate current of the

6J5 below the point required to activate the relay RY1. Upon receipt of a signal, the low-frequency i.f. tube (first limiter in some receivers). Fig. 3, will be driven to a point where a negative voltage is developed across its grid load R1. This negative voltage drives the 6SJ7 to cutoff, making its plate—and the grid of the 6J5—more positive so the 6J5 will pass current and actuate RY1. This closes contacts 6 and 7 to excite the coil of RY2. When RY2 closes, a.c. is applied to the motor of the recorder through J2. When the transmitting station goes off the air, the 6SJ7 conducts more heavily, making its plate less positive. The grid of the 6J5 is cut off and

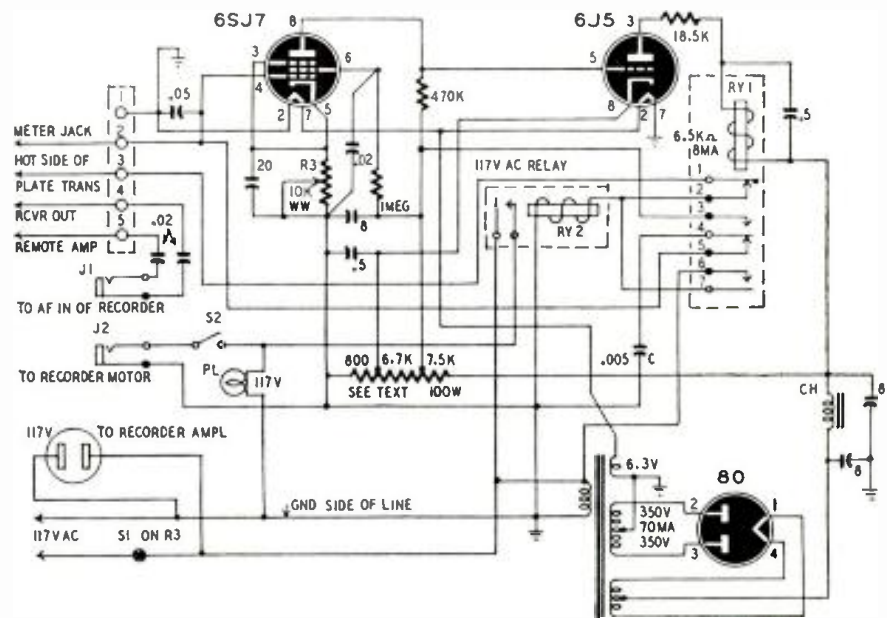

Fig. 1—Receiver develops voltage to cut off 6SJ7 and trigger relay in plate circuit of 6J5.



Fig. 2—This 3-tube relay unit operates recorder when a signal is transmitted or received.

*Chief, Communications, Florida Highway Patrol, Tallahassee, Florida

The listeners must be trained—they have to know what to listen for and how to describe what they hear in terms of treble, bass, muddiness, brilliance, fuzziness, tinniness, boominess, presence, and sometimes in unprintable terms. It is best to have one or two other radios to compare with the one being tested. The listeners should be blindfolded so that they are not influenced by knowl-

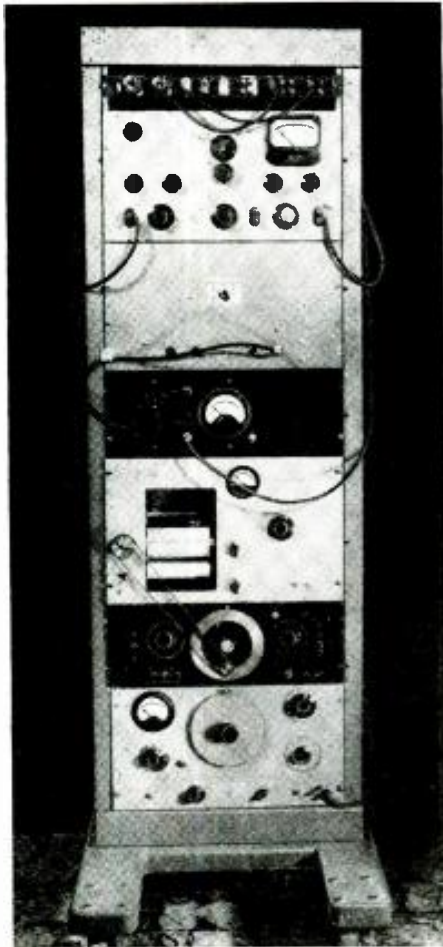

Automatic ink recorder is mounted in a rack.

edge of what radio they are listening to.

Since the listeners are human beings and not indicating instruments, their ratings have most value when they are unanimous. If all the listeners agree that a radio sounds bad, the inescapable conclusion is that the tone really is poor.

Listening to radios must be done at both ends of the radio dial, since the tone at the two ends may be different in AM sets. It should be done on a number of different stations, because all stations are not operated the same way with regard to frequency response, hum, and distortion. It should include different kinds of selections, such as male and female speech, vocal and musical programs. Live programs are best.

In listening to midget radios the most important single requirement is that the radio reproduce sibilants. If you can't hear the s's, don't bother buying the radio.

Another way to set up listening tests is to broadcast your own test programs. For this purpose high-fidelity records

are played through the signal generator. The standard of comparison (the "other radio") may be an audio amplifier. The British HMV and Decca records have outstanding fidelity.

The record-playing equipment used in this laboratory is a Rek-O-Kut transcription turntable with a Gray phono arm and a G-E cartridge and Gray pre-amplifier. These can be switched from the signal generator to a Fisher amplifier and a Stephens co-axial speaker in a bass-reflex cabinet for comparison listening.

Testing FM and television sets

Tests of FM radios are quite similar to those for AM sets. The frequency-response test differs mainly in the fact that an FM signal generator is used—the Boonton 202-B. Since this does not have a built-in pre-emphasis circuit, an external one is attached between the audio oscillator and the FM generator. Also, instead of a transmitting loop, a dummy antenna is used between the signal generator and the receiver.

In measuring the sensitivity of an FM set, there is a choice of several kinds of sensitivities as defined in the IRE standard. From a home listener's viewpoint the quieting signal sensitivity appears to be the most appropriate, since it measures the sensitivity when the audio signal is 30 db stronger than the background noise.

One very bad fault of early postwar FM radios was frequency drift with time and frequency shift with changes of line voltage. These have been largely overcome even in the cheaper sets, but the listener should still be on the lookout. As far as drift is concerned, the listener is probably interested in knowing whether he has to retune during the first half hour of listening (by that time chances are that he will have tuned to another program anyway) and whether he has to retune the next day after turning off the set in the evening. These facts can be determined the hard way—as outlined in the standard, by plotting an oscillator frequency-drift curve—or by simply listening. The results of the latter method are even more significant because drift by itself is not objectionable—it is the audio distortion (if any) resulting from drift.

Service shop tests

The average serviceman can perform similar tests with a minimum of equipment, though with less precision.

For frequency-response charting, one can use a service oscillator if it has connections for external modulation. Unfortunately too few servicemen and experimenters own an audio oscillator. If none is available, the cheapest thing to do is to buy a frequency record (see page 46, October issue) and play it through a wide-range pickup into the external modulation connections of the service oscillator. The relative loudness of the different tones as they come from the loudspeaker may be checked with an amplifier system of known flat characteristics and an output meter. It is

important, of course, to leave the volume control strictly alone during this test.

An easier but less informative way to judge the frequency-response would be to connect an a.c. voltmeter across the loudspeaker terminals. The voltmeter readings (converted to decibels) may then be plotted on graph paper. This test does not take the speaker into account, of course.

In the listening test, pay attention to sibilants—they should be audible, but not exaggerated. As an over-all test for trebles, triangles will be completely inaudible on some radios. A record with a good bass to listen to is the Victor recording of the *Lt. Kije Suite*, side 4. The tympani are completely inaudible on radios with poor bass response and too loud on boomy ones.

The sensitivity of an AM radio is usually given in service notes as the voltage on the antenna terminals. This is all right for checking whether the set is in proper operating condition. As a matter of fact, it has been recognized for some time now among radio servicemen that the easiest way to locate hard troubles is, not to measure d.-c. voltages and resistances all over the place, but to make over-all gain measurements with a service oscillator and an r.f. vacuum-tube voltmeter. Of course, for this purpose one must have nominal gain figures for each stage. Such figures nowadays are obtainable from the better service notes.

For evaluating two radios to find out which is more sensitive, the loop antennas must be included in the test. This may be done by placing them one by one in exactly the same position on the table or on the floor, so that their loops are in exactly the same position. The set that can bring in the weakest station the clearest is the more sensitive one. In making this test, be careful that there is no metal table, metal floor or wall in the vicinity since results will then—to a great extent—depend upon which radio has its loop of the latter method mounted so as to be farther from the metal.

One test that cannot be made by actual comparison of two sets is the interference-rejection test, that is, unless the i.f.'s are at exactly the same frequency. The interfering station may be at just the right frequency for one set and not for the other, while it is the second set that is really bad. If the two i.f.'s have been aligned to exactly the same frequency, then at least the image interference and i.f. interference frequencies will be the same, and a comparison test would be valid. Again, if the test is made during the day, there may be no interference on any set. Listen for interference after sundown.

A very enlightening analysis of interference is published by RCA Victor Division, Camden, N. J. (*Interference Analysis and Its Radio Reception Effects* by W. J. Zaun). It gives the i.f. frequencies to which radios in given cities should be aligned to avoid interference. Servicemen might avoid a lot of birdie troubles if they followed such a chart and used one of the crystal service oscillators for exact aligning to the proper frequency.

the output started dropping at about 2,000 cycles; and by the time the audio oscillator had reached about 5,000 cycles, there was no output at all. Taking the 10-db-down point as a reasonable

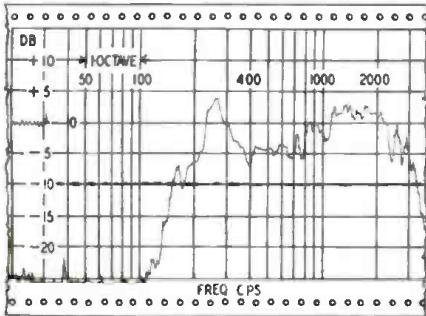

Fig. 2—Sample receiver response curve chart.

measure of limiting response, the radio might be said to be good from 150 cycles to 3,300. This was a good table-model radio. Good console FM radios will go both lower and higher.

Interference rejection

Another thing that affects the way a radio sounds is its liability to interference from stations other than the one to which it is tuned. A two-signal-generator, interference-rejection test imitates actual listening conditions. The radio is tuned to one signal generator, and the other is cranked through its range to find interfering frequencies.

The "desired-signal" generator is tuned to a clear channel mid-band, and the radio under test is tuned to it. The signal is adjusted to be strong enough to be usable on the particular radio (16 db signal-to-noise ratio). The volume control of the radio is adjusted for average loudness (80 db on the 40-db scale of the sound-level meter). The modulation on the desired signal is then turned off, and the undesired signal is turned on and cranked through a wide frequency range to catch interference. If interference is heard at any spot, the generator is stopped and its output reduced until the interference practically vanishes. The ratio of the outputs of the two signal generators is then a measure of the goodness of the radio as regards interference rejection. In other words, the bigger an undesired signal must be (compared to a desired signal) to produce interference, the better the radio. Signal ratio is expressed in decibels.

In testing a group of 14 expensive 1948 radios, it was found that on the average it took an interfering image signal 30 db stronger than the desired signal to cause interference. However, on the best of sets there was interference only if the signal was 60 db stronger, while on the worst a signal 9 db stronger caused interference.

In the same group of radios the best radio could tolerate an interfering signal on the intermediate frequency as much as 18 db stronger than the de-

sired signal, while the worst one could not stand i.f. interference 13 db lower than the desired signal.

It was also found that on some radios the selectivity was so good that an adjacent signal (10-kc separation) could be as much as 4 db stronger than the desired signal, while on others the adjacent signal had to be 12 db weaker not to cause interference.

The interference rejection tests are performed in slightly modified forms for three types of interference: image interference (birdies), adjacent-channel interference, and i.f. interference. For the i.f. test the desired signal and the test radio are both tuned to the low-frequency end of the broadcast band.

Sensitivity

The sensitivity of a radio is best tested under operating conditions—not at the antenna terminals but through the built-in loop antenna. The setup is very similar to the frequency-response test shown in Fig. 1. The main difference is that no recorder is used. The transmitting and receiving loops are placed very carefully so that they are exactly 50 cm apart and so that each is at least 5 feet away from the metal walls of the test booth. The standard-signal generator is 30% modulated with the random-noise generator. The volume control of the receiver and the output control of the standard-signal generator are then adjusted until the audio signal is 16 db stronger than the noise. Naturally, if

the signal generator output is increased from this point, the signal-to-noise ratio improves; and if it is decreased, the signal-to-noise ratio becomes worse. The field strength (in microvolts per meter) about the receiver loop at which the signal-to-noise ratio is 16 db is taken as a measure of the usable sensitivity of the radio. This is usually less than the absolute sensitivity, but the usable sensitivity has more significance for the listener to local broadcasts. The absolute sensitivity figure might be of interest to long-distance listeners, but even so, the noise in some expensive radios makes them completely useless with the sensitivity and volume controls turned fully on.

Listening tests

The tests so far described are the most important of the laboratory tests performed on home radios. These tests take place in an electrostatically shielded room, which also must be sound-isolated so that outside noises don't get in and sound-treated so that the sound doesn't bounce around inside the room too much.

A radio must also be subjected to listening tests. A frequency response curve and distortion measurements (at the present state of the art) do not tell you whether a set *sounds* good or bad to the ear. For listening tests a room is needed that does have some reverberation—like a typical living room. (Continued on following page)

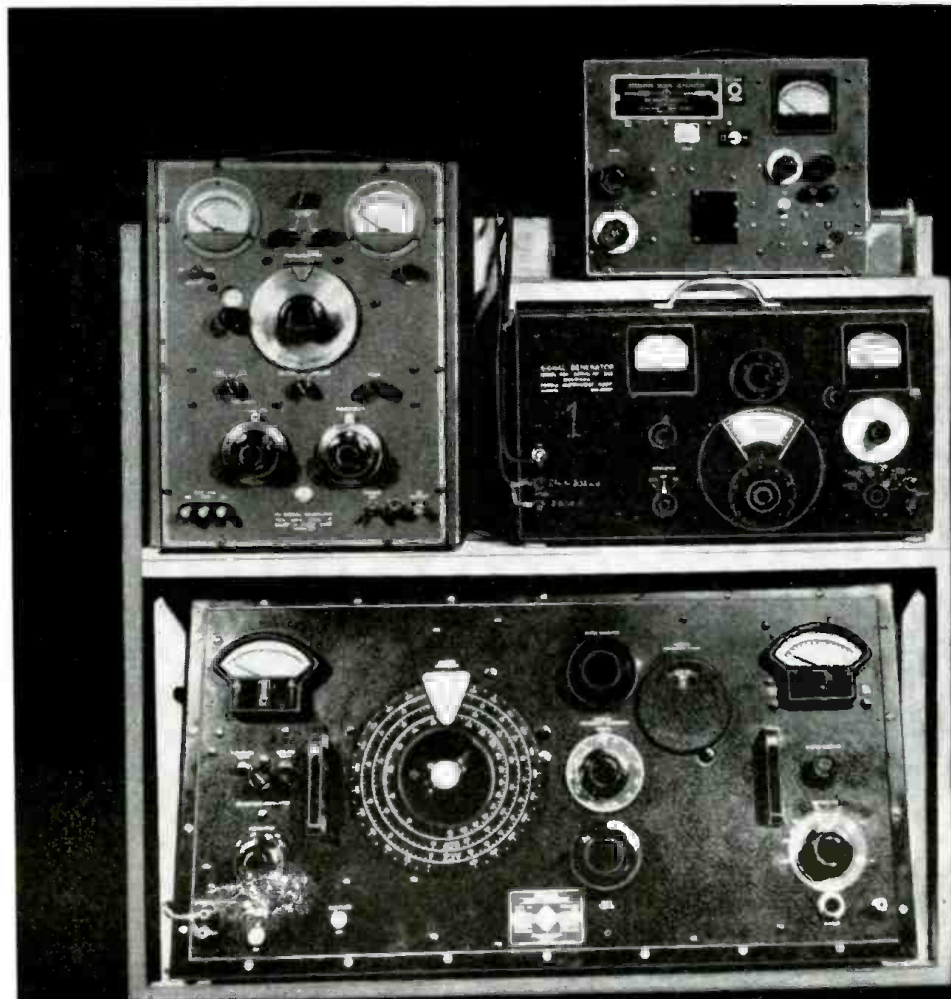

Photos courtesy of Consumers Union

These are four of the high-precision generators used in the laboratory for comparing performances of receivers tested.



Careful laboratory measurements determine the qualities of a receiver

By K. V. AMATNEEK*

Laboratory technician tests a receiver. Sound-absorbing material covers walls and a metal shield encloses room.

Radio Performance Tests

THE worth of a radio receiver is determined by its performance, operating convenience, durability, ease of maintenance, hazards to the user and to other property, and appearance. Probably the most important point is performance. Many radio repairmen and experimenters have sufficient equipment to make some of the tests which show exactly how a radio performs. To furnish some guidance on the testing methods, we shall describe how one laboratory compares different receiver makes and models.

The most important aspects of performance are tone, interference rejection, and sensitivity. The exact meaning of these and standardized ways of testing for them, are described in standards published by the Institute of Radio Engineers. The first of these, issued in 1938 and still useful, is entitled *Standards on Radio Receivers: Methods of Testing Radio Receivers, 1938*. Another important one is *Standards on Electroacoustics, 1938: Definitions of Terms, Letter and Graphical Symbols, Methods of Testing Loudspeakers*. And there is the latest one, *Standards on Radio Receivers: Methods of Testing Frequency-Modulation Broadcast Receivers, 1947*. These standards are highly recommended to anyone interested in radio receivers. They have been published as separate pamphlets at 50 cents each by the Institute of Radio Engineers, Inc., 1 East 79th Street, New York City 21.

Probably the most interesting test of a radio is measuring its frequency response. The usual way is to disconnect the speaker voice coil from the output transformer and connect a dummy load—a resistor of the same value as the loudspeaker impedance—across the output terminals. Of course, this leaves out

altogether the characteristics of the loudspeaker and the cabinet. (A radio might be pumping both low bass and high treble frequencies through its output transformer, but the speaker may be unable to reproduce them.)

A good acoustic frequency-response test on the other hand is very complicated—mainly because of such things as standing waves—and the equipment is very expensive. A suitable compromise may be reached by leaving the loudspeaker in place and using a listening microphone about 12 inches from the loudspeaker in a reasonably well padded room. At such a small distance from the speaker, the standing waves are relatively small at the microphone, but the resulting frequency-response curve is not entirely accurate.

The fidelity test is best described by a block diagram. Fig. 1 shows the setup with names and model numbers of the equipment used in the author's laboratory.

What the setup amounts to is a broadcast transmitter (the signal generator), a receiver, and a listening microphone. The transmitter is modulated by an audio oscillator which is cranked by a motor through the whole audio-frequency range—from 20 to 20,000 cycles. The same motor pulls the frequency-response chart under a pen; the pen rides up and down on a moving strip of graph paper as the loudness of the loudspeaker increases and decreases. The result is a curve like that shown in Fig. 2.

To perform the test the audio oscillator (or else a special random-noise generator) is adjusted to give 30% modulation of the standard-signal generator; the latter is tuned to a free channel somewhere in mid-band and its output adjusted to give an average input into the receiver under test. The re-

ceiver is then tuned to that frequency and its volume control adjusted to average loudness. (The 40-db scale of a sound-level meter is used for this purpose.) The microphone is placed in front of the speaker and the amplifier gain is adjusted to deflect the recorder pen 15 db below the top of the graph paper. The audio oscillator is then cranked to the 20-cycle position, and the paper drum is aligned so that the pen falls on the 20-cycle division on the graph.

The motor switch is then turned on. As the audio oscillator dial passes 50, 100, 200 cycles and so on, the pen at the same time passes the corresponding markings on the graph paper. In the curve of Fig. 2 the radio evidently had little or no output below 100 cycles. The output then rose rapidly to a peak at 260 cycles. At the high frequencies

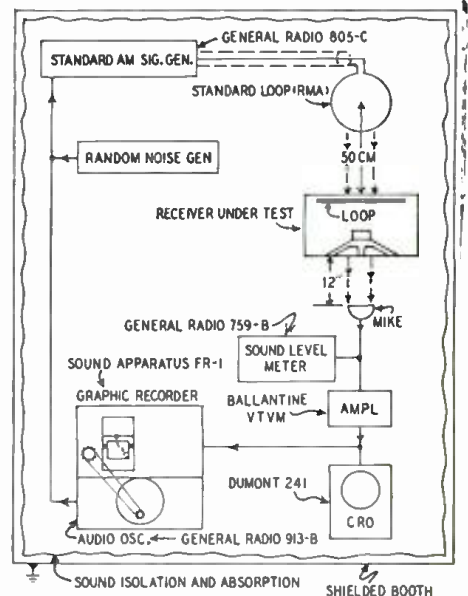

Fig. 1—Set up of the measuring equipment.

*Head of the Electrical Division of Consumers Union of U. S., Inc., New York, N. Y.

example, metals in contact, plus modulation of a carrier wave by the rectified signals. Station X's signal reaches some BX cable, in a building, which is touching another piece of metal, the bimetal contact acting as a detector and producing an audio current. This affects another carrier, which is modulated by the audio current. Of course, it has its own modulation as well. The result in the listener's receiver is two sets of voices or music.

The same phenomenon occurs in the set when, in some circuit before the second detector, there is rectification of one signal and modulation by it of a second carrier. External cross-modulation may be recognized by the fact that other sets in the same location will have the same trouble.

Several excellent articles going into the causes of interference due to harmonics and heterodynes have appeared in past issues of RADIO-CRAFT, notably "Interference Analysis" in November, 1941. Cross-modulation was dealt with in detail by the article "Station Riding" which appeared in RADIO-CRAFT in January, 1945.

Oscillation is likely to be found in commercial sets when the location of wires has been changed by some serviceman and also in homemade sets. The cause is generally more difficult to locate and cure than either hum or interference. Perhaps the chief reason for oscillation in a well-designed set is attempted alignment "by ear." Homer L. Buck and others after him caused considerable controversy in older issues of RADIO-CRAFT by advocating "by ear"

alignment, but no one was able to show a satisfactory method.

Home-built receivers

Anyone who has used a single-tube regenerative set will recognize the signs and sounds of oscillation. High sensi-

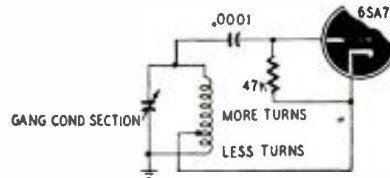

Fig. 3—Grid-cathode winding is the largest.

tivity, instability, and a rushing sound plus a squealing or squawking which increases with an advance in the volume control setting, mark oscillation in the wrong place in an a.c.-d.c. set. How to cure it? Sometimes rebuilding the home-built set seems the only method. Screwing down one i.f. trimmer condenser and unscrewing the other trimmer of the same i.f. (stagger-tuning) or shunting the primary or secondary of the i.f. coil with, say, a 50,000-ohm or higher resistance may cut the oscillation but naturally will lessen signal strength and selectivity.

Filter condensers again may be causing the trouble and should be replaced for a trial or shunted with paper or mica capacitors. Proximity of grid and plate leads (particularly in the i.f. section), lack of shielding, or improperly grounded shields may result in oscillation. Replacement of a low-gain trans-

former with a high-gain one, as, for example, replacement of the i.f. transformer in a cheap 5-tuber with a high-gain i.f. transformer taken from a portable, may result in oscillation. Of course, too high an a.c. line voltage may cause trouble, and an external antenna connected to the loop on the set produces oscillation.

A common cause is a defective or omitted bypass condenser, particularly the screen bypass. Try substituting condensers of known good quality for those in the set. A cathode bypass condenser may need to have a larger capacitance or a condenser should be used to shunt a cathode resistor where none appears in the set. Even so small an omission as failing to shield the small openings in the top of an i.f. can may result in oscillation, due to feedback to the loop. Be sure that every i.f. can is thoroughly grounded to the chassis. Most servicemen familiar with small sets have found some that persisted in oscillating when everything was "just right" according to the instruments. Note in Fig. 3 that the tapped oscillator coil has its *outside* ends across the variable condenser terminals, and that a larger portion of the winding is between grid and cathode of 12SA7 than between the tap and ground. A resistance check will reveal the larger winding.

Sometimes omission of a line bypass will not only bring in clicks and hum but will also cause oscillation. When the tuning condenser is not connected to chassis directly but through a fixed condenser, sometimes a larger condenser will stop oscillation.

OFFER TO ORGANIZATIONS

RADIO-ELECTRONICS has discovered that many active radio repairmen's associations are unknown outside a small area.

It would be advantageous to these associations to be in touch with the larger radio technicians' organizations and federations, and with magazines which encourage radio servicemen's organizations. It would be equally advantageous to the larger organizations and State federations to be able to keep in touch with all the local associations.

To establish continuing contact with all radio technicians' associations, RADIO-ELECTRONICS is offering a subscription to each active association of servicemen in the U.S. and Canada.

To qualify, send us the names and addresses of your officers and a report of the latest meeting.

RADIO-ELECTRONICS will also be glad to print any interesting events in the lives of the associations, such as cases of customers' complaints settled or other instances in which the association was useful to the local radio technicians or to the public.

Write immediately and get your association's name on our roster and RADIO-ELECTRONICS in your library. Lists of active local associations will be printed in the magazine from time to time.

WICHITA SERVICEMAN IN BUSINESS 15 YEARS



The photograph above shows the service bench of the Chase Radio Service, Wichita, Kansas. C. F. Chase, the shop's owner, shown soldering a lead back in place, states that he has been servicing for over 15 years. Because of his progressive business methods, the small shop (it is less than 100 square feet in area) provides a comfortable living for a five-member family. First-quality parts are used, tube testing is free, and all the work done is guaranteed.

brackets for the mounting screws as seen in the front view. This has to be done carefully so that the amplifier will go into the rack at the proper place. The best way to do it is to actually fit the panel to the rack, with any other rack-mounted equipment in place, and measure for the holes. The ends can be cut off a standard rack panel for the purpose, but most of these are $\frac{1}{4}$ inch thick, a fairly heavy gauge to cut with a hand hacksaw. If a machine shop is available, they can do the job. The heavier metal will be worthwhile because of its extra strength.

Take one plate out of the center of the stator and remove about $\frac{1}{4}$ inch or more from the center of each side of the stator frame. This produces a split-stator condenser with about 55 μf per section. This is just right to tune the 6-turn amplifier coil to 28 mc. This coil will be used as the push-pull tank coil L3 of the amplifier, so place a tap at the center for B-plus. Push the link L4 into the center of the form and remount the switch, coil, and condenser. Connect one end of the link and the switch arm to terminal on the right side of the case.

The original oscillator coil and condenser will be used for the grid circuit of the amplifier. Remove two turns from the winding and tap it at the center. Wind a two-turn pickup link L1 around the center of the coil, using flexible wire. After remounting the coil, connect the 50- μf condenser across it, and connect the link to terminal strips mounted on the left side of the case. The link is used for connecting to a driver or exciter stage.

Cut the shield plate into strips and drill mounting holes for sockets and other components as shown in Figs. 2 and 3. Bolt the strips in the case and complete the wiring. Connect filament plate, and ground leads to the heavy jacks in the rear or to a cable connector like the one behind the grid coil in Fig. 2. The .0004- μf , 5,000-volt grid and filament bypass condensers are obtained from the tuning unit. (If you plan to modulate the amplifier, better use .01- μf filament bypass condensers. —*Editor.*) The r.f. choke was also taken from the original unit. The neutralizing condenser we used is a dual unit with rotors connected with an insulated shaft. Standard neutralizing condensers can be used if desired. Their value and plate spacing depends on the tubes and the plate voltage used. Capacitors variable between 0.25- μf and 4 μf are suitable for the 24G's. The voltage breakdown rating should be about twice the sum of plate and grid bias voltages to avoid the possibility of arc-over.

A 100-ma d.c. meter measures cathode and grid currents. When the meter switch is in the grid-current position, it is shunted across a 25-ohm resistor. The shunt in the cathode circuit, R1, is made by shunting enough No. 26 wire across the meter to make it read 300 ma full scale. Isolantite crystal-holder sockets were used for connecting the input and output links. Any type of low-

loss connectors could be used.

Any good exciter delivering 10 watts or more will drive this amplifier to full output, even with 2,000 volts on the plates. The output coupling system will work into almost any coupling network or antenna with nonresonant feeders. Coupling should be adjusted until the cathode current is at its proper value at resonance. This will be found in the tube manual.

The circuit is standard in every respect, so no trouble will be encountered. No doubt different arrangements will suggest themselves, such as the type of plug used to carry the filament and

plate voltages, mounting of the various parts to fit each constructor's ideas, and so on, but the tuning unit does provide the basis for making a good final amplifier and most of the work, especially the tough metal punching, is already done.

Of course, some of the GI's who lived with the BC-375 may think they would prefer never to see the gadgets again in *any* form; but with ham electrons coursing through the coils and condensers, the picture takes on a different hue. For three bucks one has most of the makings for a pretty good final amplifier, even if it is a bit GI-looking.

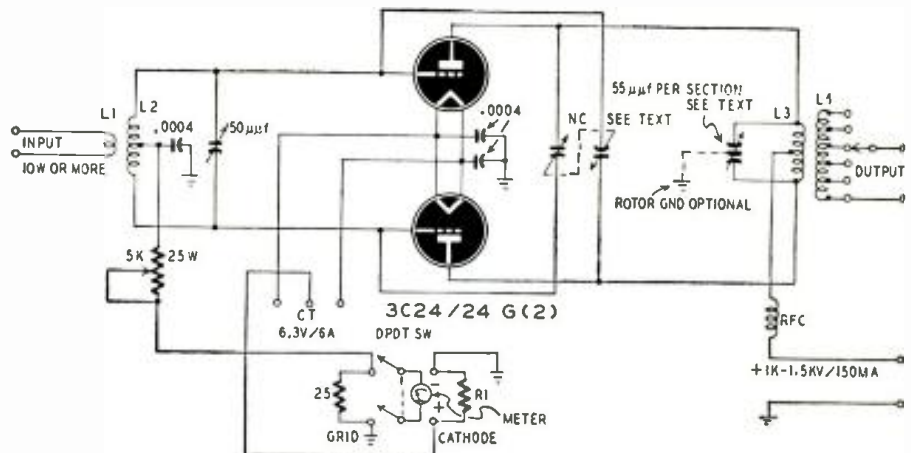

Fig. 1—This simple push-pull amplifier can be built on the TU-10-B chassis in a few hours.

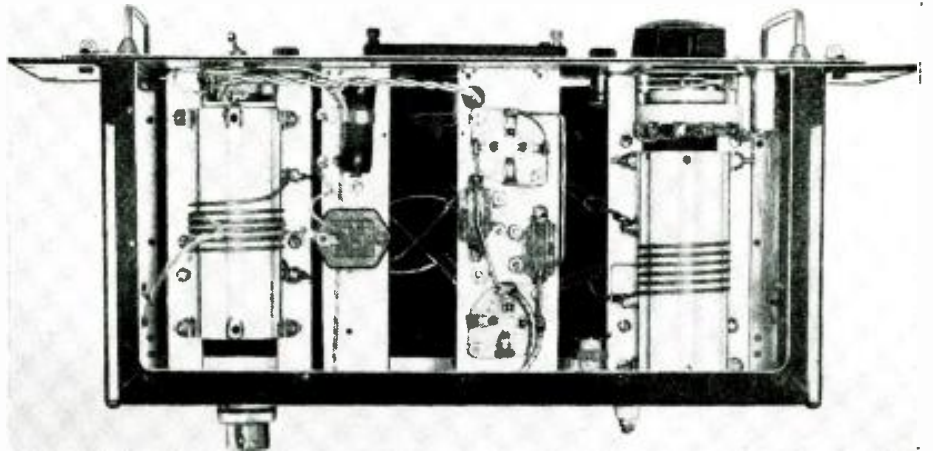

Fig. 2—This photograph shows the underside of the amplifier. The grid coil is at the left.

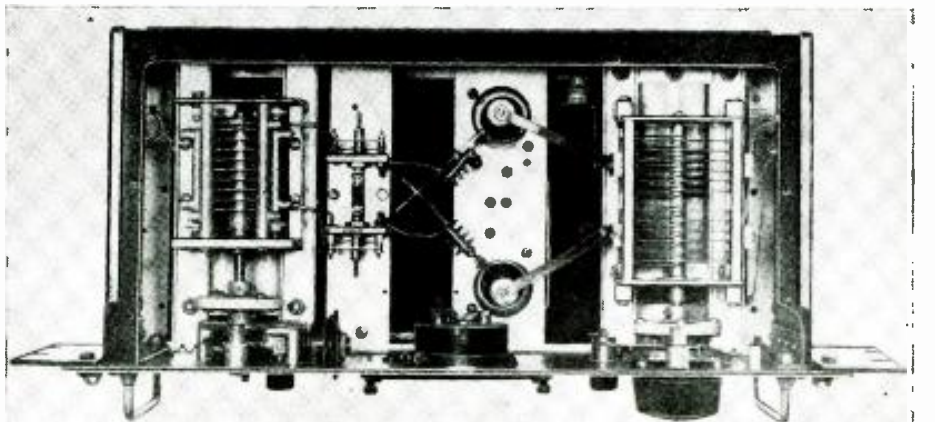

Fig. 3—Looking down on the amplifier from the top. The original tuning condensers are used.

Ten-Meter Final From TU-10-B



Metal extensions allow placing panel in standard rack.

An excellent final amplifier can be built very cheaply from standard components of the surplus BC-191 and BC-375

By **L. W. MAY, W5AJG**

THE drawer-type tuning units from the BC-191 and BC-375 have been plentiful on the surplus market for some time. These units, TU-5, TU-6, etc., contain a large number of parts useful in amateur transmitters. They contain all the tuning circuits for an m.o.p.a.-type transmitter using 211's as a v.f.o. and single-ended final amplifier. Available for less than \$3, these units have been purchased in large numbers by hams who have either converted them to variable-frequency oscillators and transmitters or dismantled them for the parts they contain. Here at W5AJG, we converted a TU-10-B to a 200-watt final amplifier that works so well that we plan to build similar units for the other amateur bands. For 90% of the components needed for a 200-watt amplifier, \$3 is not a particularly high price to pay.

There are 12 different types of tuning units in the series designed for the BC-191 and BC-375. Since all of these look alike, be sure to get one nearest the frequency you wish to use. The frequency ranges most commonly available and most useful for amateur conversions are listed in the table which fol-

lows. Though the figures do not show it, there is some overlap in the ranges.

	kc
TU-5	1,500 to 3,000
TU-6	3,000 to 4,500
TU-7	4,500 to 6,200
TU-8	6,200 to 7,700
TU-9	7,700 to 10,000
TU-10	10,000 to 12,000

The number of the tuning unit is usually followed by a letter that indicates the series of the transmitter for which it was designed. There is little, if any, difference between tuning units with the same number although they may be TU-5-A and TU-5-B. Either the A or the B will be satisfactory for conversion to use as an amateur power amplifier.

The TU-10-B was selected as the foundation for the 10-meter amplifier. The oscillator tuning circuit consists of eight turns of No. 10 wire tuned with a 50- μ fd variable condenser; the power amplifier circuit has six turns tuned with a 116- μ fd condenser. Both circuits are tuned from the front panel with slow-speed dial mechanisms. The power amplifier coil has a tapped link connected to a six-position tap switch on the

panel. The link is inside the form at the cold end of the power amplifier coil.

We selected 3C24/24G's because they are efficient at most amateur frequencies and will work well with the 1,250-volt power supply we had available for them. A number of other tubes—not necessarily triodes—will work equally well. The components in the tuning units are suitable for use in most medium-power transmitters. The variable condensers have a breakdown voltage of 1,500 volts or higher. Unless you have some way of finding out exactly what the breakdown voltage is in the case of any particular condenser, it is probably a good idea to keep the B-supply voltage at or below 1,500.

The amplifier uses a standard push-pull circuit (Fig. 1). It is simple and takes only a few hours to build. After removing the top, bottom, sides, and center shield, take out all components except the dial drives. Do not disconnect the switch from the link coil. If you plan to mount the amplifier in a standard 19-inch relay rack, cut strips from 1/16-inch sheet metal and bolt them to the ends of the panel to make it 19 inches across the front. Notch the

Besides the sale of hearing aids to individuals, the Audiphone Company installs group hearing-aid systems in churches. A group hearing aid consists of a microphone at the pulpit and an amplifier which is usually concealed within the pulpit housing. A master cable from the output of the amplifier is run beneath the church flooring for the entire length of the room. From this cable branches are tapped off, each leading to a pew section and coming to a receiver jack. The hard-of-hearing members of the congregation are furnished with individual earphones which they plug into the jacks under the pews. Volume can be regulated to suit the individual by a special volume control in the cord running to the plug. Over-all volume can be adjusted at the amplifier.

This company has also had a number of calls from clinics, schools, and otologists for audiometers, devices which are essentially audio oscillators calibrated to read hearing loss. These come in units to read individual hearing losses as well as in models designed to read the hearing of groups.

For its intercom business, the Audiphone Company depends on newspaper advertisements, telephone directory listings and some direct-mail literature to potential customers. Word-of-mouth advertisement by satisfied customers has also been a contributing factor in sales. They have felt no need to list intercoms on their store show window, feeling that they are not an over-the-counter sales item.

Besides advertising locally, they have the benefits of national advertising, for most intercom and hearing aid manufacturers pass on leads which result from inquiries. When such leads come in, the customer receives a personal visit from one of the owners of Audiphone. A demonstration is a great aid in closing sales.

The repair department is manned by two competent technicians who handle all the repair work necessary on intercoms, audiometers, and hearing aids. Because of the small size of hearing aids and intercoms, the repair space is not as large as would be needed for radio service work. Desks are used because of their convenience; the drawers are ideal for storage of small replacement parts.

The test equipment used here is similar to that found in any radio shop—multimeters, vacuum-tube voltmeters, scopes, gain-checking devices, and similar items.

The two organizations mentioned are representative examples of how much business there is in sound. The newcomer would do well to secure literature from various manufacturers and familiarize himself with representative standards and variations. A franchise for the sale and service of public address systems or intercommunicating systems can then be obtained from the manufacturer or distributor whose products are considered the best in their price range. (Some manufacturers sell directly to appointed representatives while others work through distributors.)

In most cases manufacturers furnish

free engineering service to their representatives where a particular installation exceeds normal requirements in size and complexity. The manufacturer will cooperate with the dealer in the design of special control panels, and will furnish necessary wiring instructions and schematics.

To facilitate installation and service work, manufacturers also publish service bulletins which contain troubleshooting procedures, normal wiring methods, and schematics. Since each manufacturer sells cable, junction boxes, and other accessories necessary for the best hookup of his particular line, the radio repairman finds the transition to intercommunication system and PA work a comparatively simple matter.

Other sound work

Another branch of sound which shows promise is the rental of tape or wire recorders to schools and clinics, where they have proved valuable in speech study.

The popularity of electronic organs and organ attachments for pianos has opened another field for the radio repairman. The Radio Service Shop has already contracted with several manufacturers for local service and repair.

Many other possibilities exist, from wired music for hotels, restaurants, and



Radio Service Shop does large sound business.

factories, to the use of intercoms in the home for baby-watching or basement workshop communication.

Sound offers a wide variety of potential money makers for the radio repairman. When you've successfully developed a particular line, you'll agree with many others who have built successful sidelines that "sound is a *sound* business."



Intercoms, hearing aids, and amplifiers are tested and repaired on Audiphone's bench.



Main store entrance of the Audiphone Company. Hearing aids and intercoms are sold.

SOUND HELPS YOU MAKE MORE MONEY

By **MATTHEW MANDL**

SOUND—either as a sideline or an independent business—offers unusual opportunities for the radio repairman. It provides a means for augmenting his yearly profits, and at the same time opens another avenue along which his business can expand. Since the average serviceman is already quite familiar with audio amplification, he will encounter no difficulty in working with public address systems, intercoms, or any other sound equipment.

The most popular sideline with the radioman today is the renting and selling of PA systems. This does not mean, however, that it is the only one with money-making possibilities. Many shops have done exceptionally well in the sales and service of intercommunication systems, the gross income from which often exceeds that secured from PA system rentals. Others have done nicely renting large phono amplifiers to lodges, churches and schools for their special events. Still others have concentrated on servicing office sound equipment, such as dictating machines. There are also good markets for tape and wire recorder rentals, as well as the furnishing of recorded music for factory workers.

A good example is The Radio Service Shop operated by David Van Nest and Gibson Brindley in Trenton, N. J. Shortly after opening the shop they found the

repair business profitable and decided to expand. Their shop was too small to allow them to go into radio sales, so, after some debate, they decided to take on PA systems as a sideline. The equipment required no floor space in the shop and could be stored away when not in use.

They acquired a 10-watt amplifier, two microphones, and three speakers. To start off, they ran an occasional newspaper advertisement and lettered "PA Systems" on their delivery truck. A box in the classified section of the telephone directory also helped. From the first, they found their investment paying dividends.

About a year after their entry into the PA business, their entire sound system was burned beyond repair at an amusement park fire.

They bought new and better equipment, until today they have half a dozen indoor-type PA systems, ranging from 10 to over 50 watts in output power, and three portable amplifiers, two of which were built in their own shop.

A number of lodges, churches, and civic groups have become regular customers of The Radio Service Shop. The owners make a specialty of repairing permanently installed PA systems, and their public address business has reached such proportions that the in-

Any serviceman has enough knowledge to enter the PA business. Rental and service help bring in extra cash.

come from it often exceeds that from their radio repair service.

Both Van Nest and Brindley are agreed in attributing their success to the fact that they concentrate on giving good service. They take turns personally supervising the installation of their public address systems, making sure that the microphones are placed properly and that the gain of each is sufficient for the use to which it will be put.

Intercoms and hearing aids

Another store which does exceptionally well in the field of sound is the Audiphone Company, also of Trenton, which deals exclusively with sales and service of intercommunication systems and hearing aids.

This business is a good example of what can be done with sound. In a little over six years the volume of business in sales and repair has reached enviable proportions. They have consistently exceeded their yearly quotas for Western Electric hearing aid sales, and have installed intercoms in country clubs, state offices, business places, stores, and institutions within a 50-mile radius of their location.

The
**RADIO SERVICE
SHOP**

**RADIO and ELECTRONIC
TECHNICIANS**

24 YEARS EXPERIENCE

**TELEVISION
SOUND EQUIPMENT**

**DAVID VAN NEST
GIBSON BRINDLEY**

TRENTON 2-4742

1101½ Hamilton Av.

AUDIPHONE CO INC

**INTERCOMMUNICATING
SYSTEMS**

For Offices, Hospitals, Warehouses, Etc

**SOUND EQUIPMENT
AUDIO ENGINEERING SERVICE**

TRENTON, N. J.

244 E State Trenton 3-9303

These ads appear in the classified phone book.

RADIO-ELECTRONICS for

HOW TO BREAK INTO SERVICING

A new era in servicing lies ahead . . .

By HUGO GERNSBACK

WHEN the radio boom first started in the early 20's, servicing of radio receivers was an entirely new development. The then radio experimenters, radio amateurs, and other radio enthusiasts soon heard the servicing call. As the new radios went out of order the laymen owners could not put them into condition again and it was not long before radio technicians who understood something about the intricacies of radio sets were called in. That was the birth of radio servicing.

At present we are again in the midst of another—but much greater—radio boom. This time it is television. Authorities are convinced that during the next few years there will be a tremendous upswing in the servicing industry, far greater than was ever the case with AM receivers.

Millions of new television receivers will be in use in the near future. Indeed, it is quite conceivable that at the end of the next ten years the television receiver will have replaced to a great extent the present-day radio receiver.

The editors are now constantly in receipt of letters from men anxious to climb on the television bandwagon in one way or another and those who wish to get in on the ground floor in television servicing are no exception to that rule. Here is an excerpt from a letter received recently:

Editor, RADIO-ELECTRONICS:

"Just a few lines to you from a friend and a subscriber of yours since my early school days. I am 38 today.

"I am not a radio engineer by any means but I am also no tyro—how could I be with all the information you and your staff have crammed into my head through the years?

"Have always used Radio as a hobby while working at something else.

"If I don't get into radio and television servicing now I never will. I am not trying to say that I know all that there is to know about Radio. But I can get along; my education is fairly good.

"What are your suggestions?

"When you get a free moment, please drop me a line. I grew up with the name Gernsback as familiar to me as Babe Ruth to baseball fans.

John J. Bergen, Paterson, N. J."

The present time, indeed, is a most auspicious moment to start out in a radio-television servicing career. Furthermore in order to become established in the industry there are no great handicaps, no secrets. Nor does it take a great deal of money. If you have a good radio background—you need not be an engineer—if you are industrious, if you are willing to study and work hard, you should be able to make a good living in television servicing.

The first and most important requirement is good radio technical knowledge. This can be gained from schools or by studying radio publications and textbooks. The second is actual and concentrated experience in repairing radio and television sets. If you have a good theoretical radio knowledge, if you understand circuits, if you know a fair amount of mathematics, you should have no trouble in getting along.

To be sure, you will require the service manuals and servicing data of the various receivers. This information fortunately is tendered to you nowadays on a silver platter. The radio set and television manufacturers all issue valu-

able servicing information. Then there are several excellent servicing organizations that make a specialty of publishing and supplying such data to servicemen at a reasonable cost.

Experience with actual radio and television receivers is, however, a paramount requirement. It takes some time before the average new serviceman becomes proficient in locating the various troubles—it cannot be learned overnight. Furthermore to do efficient servicing and make a living from it, it is of the utmost importance that you have the proper tools. The days of the screw-driver-and-pliers-serviceman are gone forever. Modern receivers, particularly television receivers, are most complex. To work efficiently and hunt down receiver failure in a minimum of time, good servicing instruments are an absolute necessity. The new serviceman requires as a minimum the following:

A 20,000-ohm-per-volt multimeter with HV range or multiplier to 8 or 10 kv.

Standard signal generator with a.f. output terminals.

Tube tester, mutual conductance type.

VTVM (high-frequency type).

Scope, with triggered sweep, blanking and calibrated scale.

FM and TV sweep generator (best available).

The above represent only a modest beginning. Later on the experienced serviceman will wish to add other items to help him work more efficiently and guarantee him a better living.

If you have a reasonably good radio background it should not take more than three to four months to become a self-supporting radio and television serviceman. But remember this important point: even if you are the greatest radio wizard in the country *you will still not be a success unless you have the ability to sell yourself to the public.* The independent serviceman nowadays in many localities is often under a cloud. This is due to no fault of his, but because a small minority of unscrupulous servicemen—the outer fringe—are exploiting and have exploited the public. It is this very small minority that has given the industry a black eye in the past. It takes no more than five per cent of such men to give the whole group a bad reputation.

The new serviceman should always remember the cardinal rule that honesty is the best policy in the long run. When an unscrupulous serviceman charges \$5.00 or more for cleaning the contacts of a tube, or tightening a loose wire connection, such tactics invariably come home to roost and plague him and his industry. Sooner or later the public catches on to these underhanded methods and becomes not only suspicious, but antagonistic towards the whole servicing trade. The serviceman who is successful in the end is the one who makes no charge whatsoever for little jobs such as the ones mentioned above. (It is presumed that the receiver was taken to his shop; if he was called in by the set owner, then a small servicing charge is in order.) Such treatment will be remembered and when a serious repair comes along next time, the set owner will have confidence in the serviceman—an asset that will pay big dividends in his future.

In short, if you wish to make a success in servicing, it can best be summarized in the following five points: 1. Good radio knowledge. 2. Intelligent work. 3. Honesty and fair play. 4. Good personal appearance. 5. Keeping everlastingly at it.

Why play "PENNY-ANTE"... when your business is at stake?

A good reputation, like good-will, is built by many deeds, but may be destroyed by a single dissatisfied customer. Your reputation is too valuable to risk for the few pennies "saved"

by buying inferior or unknown "bargains." That's why we keep repeating "Your Reputation and your customers deserve the best!" And the best means Sprague.

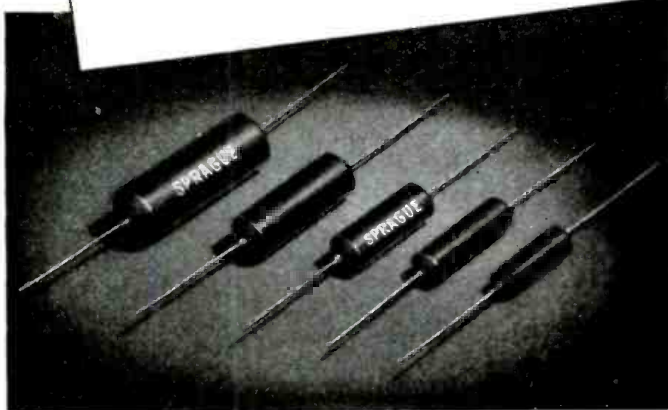
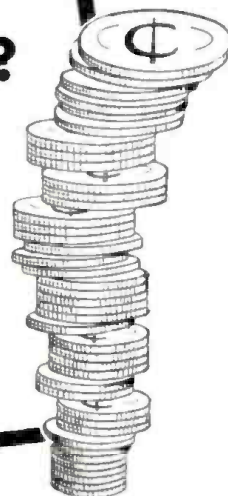

SPRAGUE TM TUBULARS—The first truly practical MOLDED Paper Tubular Capacitors!

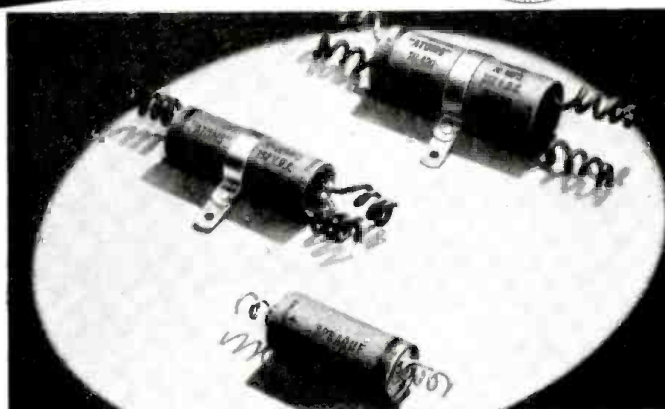

SPRAGUE ATOMS—Universal Midget Dry Electrolytic

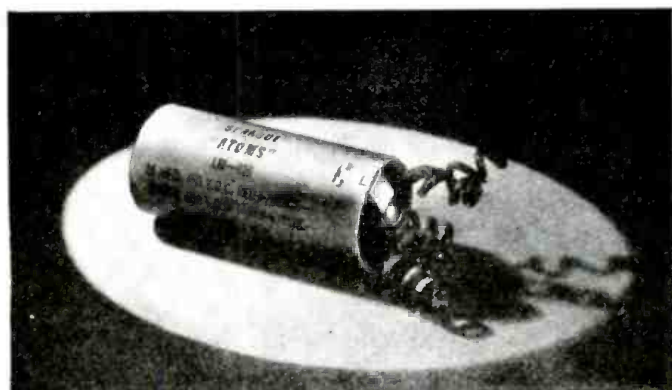

SPRAGUE LM—Universal Mounting Replacements!



SPRAGUE EL—Self-Mounting Midget Can Type!



THESE SPRAGUE PRODUCTS ARE UNCONDITIONALLY GUARANTEED!

When used at their capacitance and voltage ratings, these Sprague Products are unconditionally guaranteed to render satisfactory performance.

CAPACITORS

*KOOLOHM
RESISTORS

SPRAGUE

*T.M. Reg.
U.S. Pat. Off.

SPRAGUE PRODUCTS COMPANY, North Adams, Mass.
(JOBING AND DISTRIBUTING ORGANIZATION FOR THE PRODUCTS OF THE SPRAGUE ELECTRIC COMPANY)

RADIO-ELECTRONICS for

We're holding the Line,

OUR PRICES ARE STAYING DOWN DESPITE INCREASED COST OF WAREHOUSING & REPLACEMENT

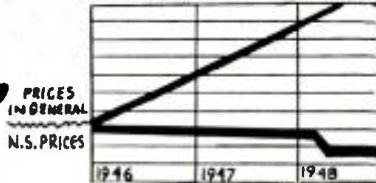

Xmas Special BRAND NEW

OB-8 1/4" Light Duty Drill

The OB-8 light duty drill is designed for intermittent service. It is a good, high quality product, properly balanced, with an air-cooled handle having a comfortable grip. Light in weight, it is especially adaptable for radio repair work, wood and metal assembly, airplane construction, boat building and kindred applications.

OB-4 1/4" Standard Duty Drill

For general maintenance, construction and building work the OB-4 standard duty drill will give dependable service. It is popular with electricians, carpenters, machinists and repairmen. It has an abundance of power developed by a smooth running universal motor. It is well balanced, has a comfortable grip and air-cooled handle.

Electric Drills AS LOW AS: **\$19.95** or **\$23.50**

F.O.B. Detroit Express Charges Collect.



Investigate this offer
525 FT. BRAND NEW WIRE \$2.95

3 conductor braided insulated copper and steel telephone wire. It is of copper for conductivity and steel for strength. Worth at least 3c per foot, yet due to an exceptional buy we can now offer it at less than 1c per foot.

(Shipped express charges collect)



G.R. Tubes

- 3 CP 1 (Ind. Screen) .95
- 3 DP 1-A (Ind. Screen) .95
- 3 FP 7-A 1.35
- 3 HP 7 1.45

(add 25c each to cover postage and handling)

- 5 FP 7 1.75
- 5 CP 1 1.95
- 5 BP 1 2.45
- 5 HP 1 2.45

(add 35c each to cover postage and handling)

- 7 BP 7 2.65
- 7 CP 1 3.25

(add 40c each to cover postage and handling)

- 9 GP 7 3.50

(Shipped express, charges collect)

PHANTOM ANTENNA

for CITIZEN BAND Still 85¢

A transmitting antenna, for use on approximately 450 MC. Complete with standard coax connector. A weather-proof unit. (Add 25c to cover handling and postage)



BRAND NEW "211'S"

49¢

A war proven veteran. The 211 Transmitting Triode, Signal Corps No. VT-4-C. Used in the famous BC375 and BC191. 2 Tubes good for Class A audio 39.4 w output, Class B audio 260 w output, Class C 300 w input and 200 w output and Class C (cw) 375 w input and 260 w output. These are really rugged tubes. Their graphite plates will take plenty of beating. Add 20c to cover postage and handling.



3/4 R.P.M. Motor Only \$2.95

Ideal for a beam rotor, plenty of power. Originally designed for 24 volt DC operation, but easily converted, 110 volts AC. Complete instructions included. Excellent for other uses too. Brand new, surplus, guaranteed. (Add 40c each to cover postage and handling)

WILLARD 2 VOLT BATTERIES \$1.25



Brand new, compact, spillproof built-in hydrometer, group several together to get higher voltages. Fully guaranteed. Shipped dry, add 35c to cover postage and handling.

ALL NEW

IMPORTANT!

All merchandise subject to prior sale, minimum order \$2.00, No C.O.D. orders accepted. Michigan residents must add 3% State sales tax.



1300 FT. Heavy Duty Cable \$18.00 Antenna Relay



New 4 conductor 16 gauge rubber covered cable. Color coded. Used by United States Government as Field Telephone Cable. 1300 feet on steel reel. F.O.B. Our warehouse Shipped motor freight or express shipping charges collect.

Antenna Relay Unit BC-442A or RE-2/ARC-5. Originally used on Command Set SCR-274. Contains an antenna change-over relay, a 1 1/2 millivolt meter, with an external 1/4 amp. thermo-couple. The meter scale reads R.F. current on linear scale calibrated 0 to 10. A truly sensational buy at only \$1.95 (add 25c to cover postage and handling)



BC 450 CONTROL BOX

Triple remote control box for Command Receivers "SCR 274 N Series". Equipped with 3 tuning dials, 3 volume controls, and 6 selector switches. Used, but in excellent condition, a steal at only \$1.50 ea. (Add 25c to cover postage and handling)



BC-616 RELAY BOX

Originally used with the command set between Modulator BC456A and Control Box BC451A. Contains 3, 24 volt relays and other parts an excellent buy at only \$1.89 postpaid.

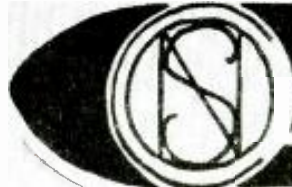

N. SILVERSTINE CO.

6532 EAST McNICHOLS ROAD DETROIT 12, MICHIGAN

Seven Acres of Surplus

NEW!



OHMITE
Little Devil
RESISTOR ASSORTMENT

IN RUGGED *All-Plastic* CABINET

REGULAR
PRICE FOR RESISTORS
\$10.00
NO CHARGE FOR
CABINET

Servicemen's Assortment Contains 125 Selected 1/2-Watt Little Devil Composition Resistors in 40 Separate Compartments

Here's a handsome, sturdy, all-plastic resistor cabinet you'll be proud to have in your shop—and one that will save you hours of valuable time. The new cabinet is molded of solid plastic and has five drawers with eight compartments in each drawer. It is extremely compact—only 9" long, 4-3/4" high, and 5-1/4" deep. Factory-packed in the cabinet is a serviceman's assortment of 125 carefully selected Ohmite "Little Devil" 1/2-watt, individually marked, insulated composition resistors, in the 40 values (10 ohms to 10 megohms) most fre-

quently used by servicemen. The assortment is offered at the price of the resistors alone—the cabinet is furnished without extra cost!

You'll need one or several of these handy cabinets in your shop to protect your resistors and to help you find resistance values quickly. What's more, they provide visual stock control so you can avoid duplicate inventories or unnecessary trips to your distributor. Order your assortment and cabinet from your jobber, today!



CAN BE STACKED ON EACH OTHER

A dovetail joint is provided on top and bottom of each cabinet so they can be stacked one on top of another.

Stocked by Leading Distributors

OHMITE MANUFACTURING CO., 4895 FLOURNOY ST., CHICAGO 44

QUANTITIES AND RESISTANCE VALUES IN THE SERVICEMAN'S ASSORTMENT

Quantity	OHMS	Quantity	OHMS	Quantity	OHMS	Quantity	OHMS
1	10	3	1000	1	33000	10	0.47 meg.
1	15	1	1500	5	39000	1	0.68 meg.
1	27	1	2200	10	47000	10	1.0 meg.
1	47	3	2700	1	68000	1	1.5 meg.
1	100	5	4700	1	82000	1	2.2 meg.
1	150	1	6800	10	0.1 meg.	1	2.7 meg.
1	270	10	10000	5	0.15 meg.	1	3.9 meg.
1	330	3	15000	1	0.22 meg.	1	4.7 meg.
1	470	5	22000	10	0.27 meg.	1	6.8 meg.
1	680	10	27000	1	0.33 meg.	1	10 meg.

Be Right with **OHMITE**

RHEOSTATS · RESISTORS · TAP SWITCHES

Switch to PHOTOFACT— the Best Service Data Buy You'll Ever Make!

Thousands of Radio Service Technicians are *right!* They've found the way to quicker, easier, more profitable servicing. Join these thousands of successful money-making Servicemen who have switched to PHOTOFACT Service Data. Learn for yourself how this accurate, easy-to-use, practical data saves you time, makes your work easier, helps you earn more. PHOTOFACT gives you 100% useful service data—every photograph, every diagram, every bit of information helps you do a *complete job*. You owe it to yourself to switch to PHOTOFACT. There'll be a big difference in the time you save and the bigger profits you'll earn every single working day.



Subscribe Regularly to PHOTOFACT Folder Sets

Here's the most accurate and complete Radio Data ever compiled—issued regularly two sets per month. Keeps you right up-to-the-minute on all current receiver production. Your best buy in Service data—practical, useful information that makes money for you every day by saving you time on service jobs. Shows you everything you need to know about the sets you service—in clear, accurate, uniform style. Packed with extra help—full PHOTOFACT data on Automatic Record Changers—communications receivers—amplifiers—*plus* new PHOTOFACT Television Folders—exclusive, uniform coverage of popular Television Models, data proved best by actual service clinic experience. Subscribe at your Jobber today, for regular monthly issues. **\$150 PER SET ONLY**.....

PHOTOFACT VOLUMES The Preferred Service Data

Bring your file of post-war receiver Service Data right up to July, 1948! Here's the most accurate and complete radio data ever compiled—preferred and used daily by thousands of Radio Service Technicians. Includes: Exclusive Standard Notation Schematics; photo views keyed to parts lists and alignment data; complete parts listings and proper replacements; alignment, stage gain, circuit voltage and resistance analysis; coil resistances; record changer service data, etc. Order Volume 4 today—keep your Photofact library up-to-date—it's the *only* Radio Service Data that meets your *actual* needs!

- Vol. 4.** Covers models from Jan. 1, 1948 to July 1, 1948
- Vol. 3.** Covers models from July 1, 1947 to Jan. 1, 1948
- Vol. 2.** Covers models from Jan. 1, 1947 to July 1, 1947
- Vol. 1.** Covers all post-war models up to Jan. 1, 1947



Your Price
Each Volume,
In DeLuxe Binder **\$18.39**



1947 Record Changer Manual

Nothing like it! Complete, accurate data on over 40 post-war models. Exclusive exploded views, photos from all angles. Gives full change cycle data, information on adjustments, service hints and kinks, complete parts lists. PLUS—for the first time—complete data on leading Wire, Ribbon, Tape and Paper Disc Recorders! 400 pages; hard cover; opens flat. Order now! **\$4.95 ONLY**.....



Radio Industry RED BOOK

The RFD BOOK tells you *in one volume* all you need to know about replacement parts for approximately 17,000 sets made from 1938 to 1948. Includes complete, accurate listings of all 9 major replacement components—not just one. Lists correct replacement parts made by 17 leading manufacturers—not just one. Covers original parts numbers, proper replacement numbers and valuable installation notes on: Capacitors, Transformers, Controls, IFs, Speakers, Vibrators, Phono-Cartridges. Plus—Tube and Dial Light data, and Battery replacement data. 440 pages, 8½ x 11; **\$3.95** sewed binding. **ONLY**.....



Receiver Tube Placement Guide

Shows you exactly where to replace each tube in 5500 radio models, covering 1938 to 1947 receivers. Each tube layout is illustrated by a clear, accurate diagram. Saves time—eliminates risky hit-and-miss methods. 192 pages, completely indexed. **\$1.25 ONLY**.....



Dial Cord Stringing Guide

The book that shows you the *one right* way to string a dial cord. Here, in one handy pocket-sized book, are all available dial cord diagrams covering over 2300 receivers, 1938 through 1946. Makes dial cord restringing jobs quick and simple. **\$1.00 ONLY**.....

FREE Photofact Cumulative Index

Send for the FREE Cumulative Index to PHOTOFACT Folders covering *all* postwar receivers up to the present. You'll want this valuable reference guide to the Radio Service Data preferred and used by thousands. Helps you find the Folders you want quickly. Get this Index at your Jobber or write for it today.



BOOST YOUR EARNING POWER!

Mail This Order Form
to **HOWARD W. SAMS & CO., INC.**
2924 E. Washington St., Indianapolis 7, Indiana

My (check) (money order) for \$.....enclosed.

Send the RED BOOK. \$3.95 per copy.

Send PHOTOFACT Volumes in DeLuxe Binder:

Vol 4. Vol. 3. Vol. 2. Vol. 1 (\$18.39 each).

Automatic Record Changer Manual, \$4.95.

Tube Placement Guide, \$1.25.

Dial Cord Stringing Guide, \$1.00.

Send FREE Photofact Cumulative Index.

Name.....

Address.....

City.....State.....

HOWARD W. SAMS & CO., INC.
INDIANAPOLIS 7, INDIANA

ONLY \$89.50 IS THE COST!

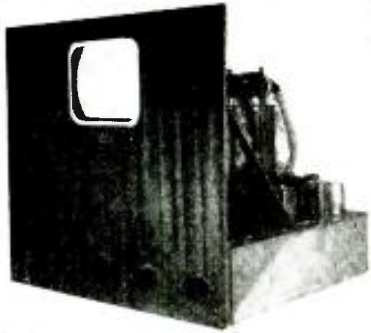

for the SENSATIONAL-NEW-IMPROVED
10 INCH
TELEVISION KIT

Complete with new built-in pretuned and aligned 13 Channel tuner, all parts and easy step-by-step instructions and schematics.

\$89.50 less tubes

Kit, complete with all tubes\$149.50
Specially designed cabinet for kit 25.00

An amazing value! Even a beginner can assemble one of these fine, new improved television kits. Has the new 13 channel tuner, pretuned and factory aligned for the entire television spectrum. High quality parts and excellent circuit assure perfect performance. Circuit designed by master class T.V. engineers. Complete RT stage, oscillator and mixer. Uses new I.F. coil providing maximum gain and picture definition. Sound reproduction is high quality FM for years of listening pleasure.

Same quality and features for 7" KIT complete, less tubes\$59.50
Complete, with tubes 99.50
Specially designed cabinet for 7" kit 22.50
This kit can be used with Sylvania 10 HP4 10" picture tube without modifications.
7" and 10" KITS AVAILABLE FOR IMMEDIATE DELIVERY FROM STOCK!

The New Model B-45 Battery Operated

SIGNAL GENERATOR

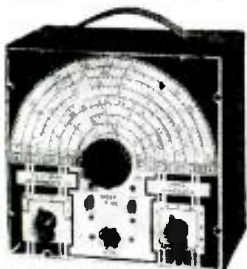

for servicing AM, FM and Television Receivers. R.P. frequencies from 1 to 10 Kilocycles to 50 Megacycles (1.5 Mc. to 12.5 Mc. on Fundamentals and from 11 Mc. to 40 Mc. on Harmonics). Complete with shielded test leads, self-contained battery and instructions. NET\$27.75

The New Model TC-50

TUBE AND SET TESTER



A complete laboratory, all purpose test-instrument, this versatile combination tube and set tester will accurately test all up-to-date designed tubes. The multi-meter section affords many necessary measurements for every day's service work.

The New Model TC-50 Tube and Set Tester simulates seven instruments: D.C.V., A.C.V., D.C.M.A., Ohm's, Output Meter, Double Meter and Tube Tester. Full scale accuracy to 1% for 1000 readings (4000 and R.M.S. scale for test tube tubes). Disturbance reduced by shielded mechanism. Simple and quick reading charts for tube testing. Multi-meter section affords most popular everyday's measurements. Model TC-50 Tube and Set Tester operates on 90-150 Volts 40 cycles A.C. Housed in a sturdy beautiful metal, hand rubbed cabinet. Complete with test leads, tube charts and all detailed, operating instructions. Size 8" x 10 1/2" x 5".....NET \$39.50

IMMEDIATE DELIVERY FROM STOCK

All orders filled same day received

Metropolitan ELECTRONIC & INSTRUMENT CO.
Dept. RC11 42 WARREN ST. N. Y. 7, N. Y.

RCA USES RAYTHEON PATENTS

Raytheon Manufacturing Company has recently granted a license to Radio Corporation of America under the radar patents owned by Raytheon. These radar patents were issued to Submarine Signal Company, now Raytheon's marine affiliate, and cover development work begun in the early thirties.

The company states that practically every radar device built during the recent world war employed the basic principles used in these patents.

EGYPT'S NEW RADIO CENTER

A new broadcasting center to cover the whole Nile delta, reaching to Alexandria and Port Said, is under development near Cairo. A 50-kilowatt medium-wave transmitter has been purchased by the Egyptian Government from the International Division of RCA. It will be erected at Abu Zaabal, 11 miles from the capital, where the studios are built.

RMA NAMES LIAISON GROUPS

To continue industrial cooperation between radio manufacturers and broadcasters, two liaison committees recently have been appointed by RMA President Max F. Balcom. These committees will work with similar representatives of the National Association of Broadcasters and the FM Association.

Early meetings are planned to promote broadcasting services and receiving set sales for AM and FM radio and television. The RMA Committee for liaison with NAB is headed by Paul V. Galvin, president of Motorola. The RMA committee for liaison with FM is headed by H. C. Bonfig, vice-president of Zenith Radio Corporation.

SET PRODUCTION FLUCTUATES

A recent RMA report on the number of radio sets produced during the first seven months of 1948 shows that the output of television receivers continues to be high. The drop in production of FM and AM sets is attributed to seasonal conditions. The table shows the figures given by the RMA.

	TV	FM-AM	AM	All sets
January	30,001	136,015	1,173,240	1,339,256
February	35,889	140,629	1,203,087	1,379,605
March	52,137	161,185	1,420,113	1,633,435
April	46,339	90,635	1,045,499	1,182,473
May	50,177	76,435	970,168	1,096,780
June	64,353	90,414	959,103	1,113,780
July	56,089	74,988	552,361	683,438
TOTALS	334,985	770,301	7,323,571	8,428,857

COMPANIES REPORT EARNINGS

The general tone of financial statements issued recently by radio manufacturers shows that business as a whole is excellent. Some examples are:

RCA: Total gross income of the parent company and its domestic subsidiaries—\$176,079,713 in the first half of 1948, compared with \$154,333,872 for the same period in 1947, representing an increase of \$21,754,841. Net income for the first half of this year was \$10,850,288, as compared with last

year's \$8,825,912; this is an increase of \$2,024,376.

G-E: Net income of \$54,602,339 in the first 6 months of 1948, as compared with \$42,802,075 in the same period of 1947—a gain of 28%.

PHILCO: Total sales for the first half of this year were 16% higher than for the comparable period in 1947.

EMERSON: The parent company and subsidiaries report a consolidated net profit of \$1,326,290.64 for the 39-week period ending July 31, 1948, as compared with \$1,585,197.48 for a like period in 1947.

ZENITH: Net consolidated operating profits for itself and subsidiaries for the three months ending July 31, 1948, amounted to \$104,969. No comparison was made with the previous fiscal period. Shipments for the three-month period amounted to \$14,137,861. Demand for the company's models, especially portable radios, continued strong.

RAYTHEON: An increase in the backlog of government orders led to the reversal, after the close of the fiscal year, of the previous declining trend in sales. Backlog of government business on May 31, 1948, was approximately \$34 million against \$36.9 million on August 1, 1947.

FCC LIMITS STATION CONTROL

The Commission recently adopted rules making it impossible for any person or corporation to have more than seven standard broadcasting outlets or to own an interest in more than 14.

Previously it had set a limit of six on the number of FM stations under common control and had forbidden joint ownership of over five television outlets.

The rules now in force also prohibit dual ownership of facilities in the same category in the same community, thus limiting one person or group to one standard, one FM, and one television outlet in a single area.

TV SHIPMENTS INCREASE

Second-quarter shipments of television sets by RMA manufacturers totaled 153,455 as compared with 106,136 during the first quarter, a gain of 50%. Televisers went to 31 of the 48 States and to the District of Columbia.

This brings the half-year total to 259,591, as compared with 162,181 for the entire year 1947. No reports were made for 1946 shipments, but 6,476 TV sets were produced by RMA members.

Shipments lag behind actual production, which amounted to 278,896 for the first six months of 1948. The total TV set production since the war is reported as 463,943.

AWARD TO HOWARD SAMS FIRM

Howard W. Sams & Co. was recently the recipient of a citation made by *Financial World* for the firm's clear analysis of its financial position for the benefit of stockholders during 1947.

Which Do You Want?



Better Pay



A Nice Home

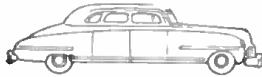

A New Car



Greater Security



Happy Vacations and Travel

Get your FCC ticket
Jobs worth
\$3000 to \$7500
are opening up
right now for
FCC Licensed Radiomen

Get Your FCC

COMMERCIAL RADIO OPERATOR LICENSE

in a Few Short Weeks

It's EASY if you use CIRE Simplified Training and Coaching AT HOME in SPARE TIME

Get your license easily and quickly and be ready for the \$3000 to \$7500 jobs that are open to ticket holders. CIRE training is the only planned course of coaching and training that leads directly to an FCC license.

Your FCC ticket is recognized in all radio fields as proof of your technical ability.

Employers often give preference to license holders, even though a license is not required for the job. Hold an FCC "ticket" and the job is yours!

Cire Graduates Find FCC License Pays Off

"Thanks to this course, I now have a very good job in a local power plant's test department. I couldn't have obtained this job without the math and basic electrical theories in the first part of Section I of this course." Stud. No. 2893N12

"I have been working for Police Radio Station WPFS in Asheville for five months since getting my second-class ticket." Stud. No. 2858N12

"You may be interested to know that I am employed at the local broadcast station, where I am a transmitter operator. I took and passed the FCC examinations last February." Stud. No. 2754N12

CLEVELAND INSTITUTE of RADIO ELECTRONICS, RC-11
4900 Euclid Avenue Cleveland 3, Ohio

Approved for Training under "G. I. Bill of Rights"

NOVEMBER, 1948



I can train you to pass your FCC License Exams in a few short weeks if you've had any practical radio experience — amateur, Army, Navy, radio servicing or other. My time-proven plan can help put you, too, on the road to success—

Let me send you FREE the entire story Just fill out the coupon and mail it. I will send you, free of charge, a copy of "How to Pass FCC License Exams," plus a sample FCC-type Exam and Catalog A, describing opportunities for you
EDW. H. GUILFORD, Vice-President

Get All 3 FREE Send Coupon Now!

CLEVELAND INSTITUTE OF RADIO ELECTRONICS RC-11
4900 Euclid Ave., Cleveland 3, Ohio

I want to know how I can get my FCC ticket in a few short weeks by studying at home in spare time. Send me your FREE booklet "How to Pass FCC License Examinations" (does not cover exams for Amateur License) as well as a sample FCC-type exam and Catalog A, describing opportunities in Radio-Electronics.

NAME

ADDRESS

CITYZONE.....STATE.....

Veterans check for enrollment information under G.I. Bill.

NO OBLIGATION—NO SALESMEN.



MADE TO SELL YOU AND YOUR SERVICE

3 NEW SYLVANIA AIDS!



Big, handsome, eye-catching! That's the new Sylvania 38 $\frac{3}{4}$ " high and 8 $\frac{1}{4}$ " wide metal thermometer! Put this green, black and white business aid outside your shop—call attention to the service you offer and the merchandise displayed in your windows!

You can obtain this sales-catcher from your Sylvania Distributor! See him today!

only \$2⁹⁵

Here's the new Sylvania Service Kit now available to service dealers—a prestige-building and practical addition to your service business!

Made of laminated plywood covered with brown plastic fabric with the appearance of fine leather, this kit has a tube capacity of over 75 tubes. The interior measures only 18"x 11 $\frac{1}{4}$ " x 5 $\frac{1}{2}$ ". The tool section in the lid is designed to hold the most commonly used tools for on-call service. Ask your Sylvania Distributor for this wonderful new, low-priced Service Kit. Get that added professional touch that means so much.



(Tools shown
not included)

only \$9⁹⁵



only
\$4⁵⁰

And here's the new Sylvania illuminated shadow box sign that's ready for hanging in your window, on your wall, or on any strategic flat surface in your window. Two eyes in the top of the sign are for hooks or chains.

The big, bright red letters "Radio Service" tell your message in no uncertain terms to every passerby. The sign's face is glass; the background translucent yellow. The red letters are outlined in black, while the bottom half of the sign is black with yellow lettering. The brown metal case is chrome trimmed. Size: 18 $\frac{1}{4}$ " long, 8 $\frac{1}{4}$ " high, 3 $\frac{3}{4}$ " deep. Seven-foot cord provided.

At Sylvania Distributors everywhere! Sylvania Electric Products
Inc., Advertising Department, Emporium, Pa.

SYLVANIA ELECTRIC

RADIO TUBES; CATHODE RAY TUBES; ELECTRONIC DEVICES; FLUORESCENT LAMPS, FIXTURES, WIRING DEVICES; PHOTOLAMPS; ELECTRIC LIGHT BULBS

RADIO-ELECTRONICS for

10 Reasons Why...

D.T.I. IS ONE OF YOUR BEST BUYS

D.T.I. can prepare you for a profitable future in TELEVISION Radio - Electronics

- 1 You profit from our 17 years of "Know-how" in preparing men for real opportunities in the Radio-Electronics field.
- 2 A faculty of more than 60 skilled residential and 15 extension instructors to guide students in their training.
- 3 You may learn at home or in our new, modern laboratories in Chicago.
- 4 Home Movies, an exclusive D.T.I. feature, help you learn faster . . . easier at home.
- 5 You receive many shipments of commercial-type equipment which give you practical "on-the-job" experience in your own home. You keep all of this equipment — working about 180 experiments, including a permanent 6-tube Radio Receiver the entire family will enjoy.
- 6 You build and keep modern-type test equipment which you can regularly use for analyzing, checking and testing purposes.
- 7 You also get lessons with many illustrations and schematic drawings that make electronic circuits easier to understand.
- 8 The only training of its kind to be awarded the Certificate of Merit by the New York Museum of Science and Industry.
- 9 EFFECTIVE EMPLOYMENT SERVICE is available when you complete your training to help you get started.
- 10 Consultation Service. After you have completed your training, you are privileged to write for additional information to help you with "on-the-job" problems.

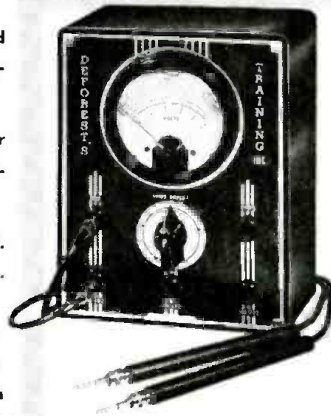

See how DeForest's Training, Inc. can start preparing you now for the opportunities ahead in TELEVISION . . . RADIO . . . ELECTRONICS. We provide practical training in your own home to help you gain the confidence and "know-how" to fit you for a responsible, well-paying job or your own business. D.T.I. trains you rapidly, thoroughly, by using modern instruction methods and equipment. Write today for free facts on how you, too, may get started toward a profitable, exciting career.

You BUILD and KEEP this jewel bearing MULTI-METER (above) and 6-tube "Super-Het" Receiver (below) . . . giving you practical experience at home in ASSEMBLY . . . WIRING . . . SOLDERING . . . TESTING . . . TROUBLE SHOOTING!



NO EXPERIENCE NECESSARY

D.T.I. sends every major aid to speed your home training. In addition to the many shipments of Radio-Electronics parts and assemblies, you receive well illustrated, loose-leaf lessons, prepared in clear, simple language to help you learn faster, easier.

YOU ALSO USE HOME MOVIES

Only D.T.I. provides you with this all important home training aid that makes Radio-Electronics principles remarkably clear and easier to understand. We lend you a 16 mm. projector and many reels of information-packed film.

EMPLOYMENT SERVICE

When you complete your training, our Employment Service will help you get started. Mail coupon today for full details.

MAIL THIS OPPORTUNITY COUPON NOW!

DeForest's Training, Inc.
2533 N. Ashland Ave. Dept. RC-E11
Chicago 14, Illinois

Send me complete details, showing how I may make my start in Radio-Electronics-Television. No obligation.

Name Age

Address Apt.

City Zone State

If under 16, check here for special information If a discharged veteran of World War II, check here.

DeFOREST'S TRAINING, INC.
CHICAGO, ILLINOIS
Associated with the DeVry Corporation,
Builders of Electronic and Movie Equipment

McMurdo
SILVER

Announces the **NEW** **900A VOMAX**



Net Price
\$68.50

CONTINUOUS RESEARCH, study of thousands of cases of actual field experience now enable us to offer you the new 900A "VOMAX". Revolutionary as was the original, the new 900A forges far ahead in simplicity, dependability all-around *usability*.

Just 3+ months ago McMURDO Silver Co. announced "VOMAX"—the first truly stable, ultra-high input resistance v.t.v.m. Lifting the v.t.v.m. out of the limited laboratory-application class, Silver engineering and use-experience made "VOMAX" the first *universal* v.t.v.m. Its acceptance was instant and overwhelming — for "VOMAX" will measure, at input resistance so astronomically high as not to "load down" any circuit to which it may be connected — d.c. volts, a.c., a.f., i.f. and r.f. volts, d.c. milliamperes and amperes, resistance and db. — all over tremendous range and with laboratory accuracy. Used in scores and hundreds by such competent organizations as the National Bureau of Standards, the Navy, Army, F.C.C., C.A.A., Veterans Administration, G. E., Western Electric Co. Recommended by Bendix, "VOMAX" is consistently copied, never equalled — stands today as "standard of comparison" for the entire industry.

In announcing the new "VOMAX" we think you'll agree that we can feel just a bit proud of having again done the impossible to give you the world's finest *universal* Laboratory Caliber Electronic Test meter at only Net \$68.50.

FEATURES

- Non-breakable glass 7" meter completely protected behind panel.
- Single hand-convenient probe gets into tight places, banishes usual snarl of easily lost and broken test leads.
- Newer — and fewer — miniature u.h.f. tubes.
- 51 ranges at highest available a.c. and d.c. input resistance.
- Absolutely stable—one adjustment sets meter zero for all ranges.
- No grid current error. Exclusive to "VOMAX", this vital feature is carried to new heights in new 900A.
- 24 d.c. ranges at 51 and 126 megohms, constant input resistance. 0 thru 3, 7.5, 12, 30, 75, 120, 300, 750, 1200 and 3000 volts. Polarity reversing switch.
- 6 a.c./r.f. ranges, 20 μ thru 300 mc., 20 megohms input resistance shunted by 7 mmfd. 0 thru 3, 12, 30, 120, 300 and 1200 volts.
- 3 db. ranges.—10/+10, +10/+20 and +20/+50 db.
- 6 resistance ranges. 0 thru 2000, 20,000 and 200,000 ohms. 0 thru 2, 20 and 2000 megohms.
- 6 direct current ranges. 0 thru 1.2, 30, 120, 300, 1200 ma. and 12 amperes.
- True vacuum tube meter in all but current functions. No low-resistance, frequency-erroneous copper oxide rectifiers.

Every good jobber features the new "VOMAX", new *super-sensitive* 905A "SPARX" Signal Tracer, 910 Universal Test Speaker & 18 Watt Universal Output Transformer, 906 FM/AM Signal Generator, new 909 and 911 TV and FM Sweep Signal Generators, 904 Resistance/Capacitance Tester. All, Laboratory Caliber Electronic Test Instruments at a price you can afford.

OVER 37 YEARS OF RADIO ENGINEERING ACHIEVEMENT

McMurdo Silver Co., Inc.

EXECUTIVE OFFICES: 1240 MAIN ST., HARTFORD 3, CONN.
FACTORY OFFICE: 1249 MAIN ST., HARTFORD 3, CONN.

UNAUTHORIZED BROADCASTING from a transmitter operated in Jennings, La., was stopped last month by federal agents. The station was operated by a young veteran who had studied radio at a Texas school. He had been broadcasting music and entertainment on a frequency of 1540 kc for several months.

The intervention of federal agents and seizure of the equipment provides another warning to all radio men that unauthorized transmissions will not be tolerated by the government. *Even phono oscillators may come under the ban if they have sufficient output.* The safest plan is to deliberately limit output of such devices to the minimum necessary to transmit across the room in which oscillator and receiver are located.

U. S.-CANADIAN AGREEMENT was reached last month with regard to FM stations close to the border. The agreement calls for consultation between the FCC and the Canadian Department of Transport to eliminate any possibility of interference between stations of both countries. No loss of channels to this country is expected.

KENNETH B. WARNER, known to radiomen as secretary of the American Radio Relay League and editor of its official organ, *QST*, died unexpectedly September 2.



Mr. Warner was one of the founders of the League and was its first paid secretary, holding the post from 1919 till his death. He was active in organizing the International Amateur Radio Union and at practically all national and international conferences where the welfare of the amateur was affected.

He maintained his personal interest in radio, operating his own station W1EH up to the time of his death. He was also an enthusiastic amateur photographer, and many of his pictures have been exhibited. He was a member of the Institute of Radio Engineers and the Hartford County Camera Club.

SUPERSONIC PAINT TESTING was reported last month to the American Chemical Society. Less than a second is required to tell whether a paint or varnish will wear well.

The coating of paint is smeared on a piece of metal. The metal is then shaken violently by a transducer connected to a supersonic oscillator. The amount of vibration necessary to make the paint or varnish peel indicates how long it will be likely to last under normal conditions of use.

TOWERS are being erected across Northern Indiana to chart a layout for television relays, it was announced last

month by T. C. Wilhoite, TV engineer for the American Telephone and Telegraph Co. The towers are temporary; when the permanent ones are built next year, they will link Chicago with East Coast TV facilities.

A co-axial cable laid across the same route last year was intended for television but this cable is already being overworked to handle long-distance telephone calls. When the relays are finished, the cable will be used for television only in emergencies.

NATIONAL ELECTRONICS CONFERENCE will be held at the Edgewater Beach Hotel in Chicago on November 4, 5, and 6.

A comprehensive technical program has been arranged covering all the major fields. New equipment will be displayed throughout the sessions.

LOW-POWER FM transmitters may be used by schools and other non-commercial, educational broadcasters, according to a ruling made by the FCC last month. Power used may be 10 watts or less and all stations will operate on 88.1 mc. The ruling is expected to make it possible for many schools with limited finances to enter the broadcasting field.

BRITISH TV standards were frozen indefinitely last month by a government decision to retain the present 405-line, 25-frame pictures. The British decision parallels the American one made some time ago against converting to color. The reason in each case was that technical advances were not sufficient to justify a change in system which would make all present sets obsolete. British televisioners now own approximately 60,000 receivers.

MAGNETIC TAPE STANDARDS for the broadcast industry were decided upon last month by the NAB, lifting the last barrier to widespread production and use of tape recording equipment. Most important was standardization of tape speed at 15 inches per second for high-fidelity work, with 7.5 inches as a secondary speed and 30 inches as a supplemental speed. The 7.5-inch speed corresponds to the proposed RMA standard for home recording.

Other standards adopted include a tape width of 0.25 inch, specified breakage, temperature, and humidity characteristics, noise level 40 db below peak signal, and 33-minute playing time on each spool.

NATIONAL RADIO WEEK will be observed this year from November 14 to 20, with all phases of the broadcasting and radio manufacturing industries participating. The announcement was made by RMA and NAB, the joint sponsors.

This will be the fourth year in which all radio interests will cooperate in observing the anniversary of broadcasting. This year's anniversary is the twenty-eighth.

USEFUL XMAS GIFTS



PLEASE TEAR OUT THIS ADV. AS REMINDER

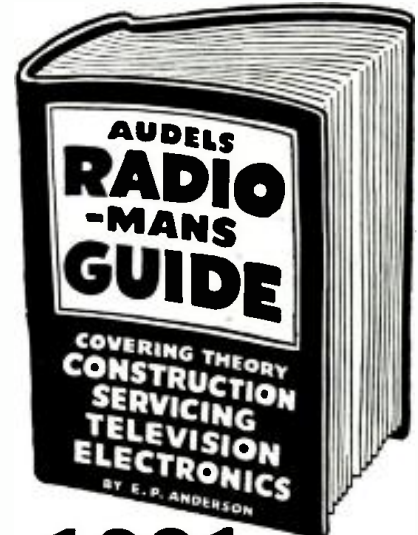

1001 RADIO FACTS AND FIGURES

AUDELS RADIOMANS GUIDE—914 Pages, 633 Illustrations, Photos, Wiring Diagrams, 38 Big Chapters, covering Radio Theory, Construction, Servicing, including Important Data on Developments in Television, Electronics and Frequency Modulation, Review, Questions and Answers, Calculations & Testing. Highly Endorsed—Indispensable for Ready Reference and Home Study.

\$4 COMPLETE • PAY ONLY \$1 A MONTH Step up your own skill with the facts and figures of your trade. Audels Mechanics Guides contain Practical Inside Trade Information in a handy form. Fully illustrated and Easy to Understand. Highly Endorsed. Check the book you want for 7 days' Free Examination.

Send No Money. Nothing to pay postman.

CUT HERE MAIL ORDER

AUDEL, Publishers, 49 W. 23 St., NEW YORK 10, N. Y.

Please send me postpaid for FREE EXAMINATION books marked (x) below, if I decide to keep them I agree to mail \$1 in 7 Days on each book ordered and further mail \$1 monthly on each book until I have paid Drica—otherwise, I will return them.

- RADIOMANS GUIDE**, 914 Pages . . . \$4
- ELECTRICIANS EXAMINATIONS**, 250 Pages . . . 1
- WIRING DIAGRAMS**, 210 Pages . . . 1
- ELECTRIC MOTOR GUIDE**, 1000 Pages . . . 4
- ELECTRICAL DICTIONARY**, 9000 Terms . . . 2
- ELECTRICAL POWER CALCULATIONS**, 425 Pgs. . . 2
- HANDY BOOK OF ELECTRICITY**, 1440 Pages . . . 4
- ELECTRONIC DEVICES**, 216 Pages . . . 2
- ELECTRIC LIBRARY**, 12 vol., 7000 Pgs., \$1.50 vol. . . 2
- OIL BURNER GUIDE**, 384 Pages . . . 1
- REFRIGERATION & Air Conditioning**, 1280 Pgs. . . 4
- POWER PLANT ENGINEERS Guide**, 1500 Pages . . . 4
- PUMPS, Hydraulics & Air Compressors**, 1658 Pgs. . . 4
- WELDERS GUIDE**, 400 Pages . . . 1
- BLUE PRINT READING**, 416 Pages . . . 2
- SHEET METAL WORKERS Handy Book**, 388 Pgs. . . 1
- SHEET METAL PATTERN LAYOUTS**, 1100 Pgs. . . 4
- AIRCRAFT WORKER**, 240 Pages . . . 1
- MATHEMATICS & CALCULATIONS**, 700 Pgs. . . 2
- MACHINISTS Handy Book**, 1600 Pages . . . 4
- MECHANICAL Dictionary**, 968 Pages . . . 4
- AUTOMOBILE GUIDE**, 1700 Pages . . . 4
- DIESEL ENGINE MANUAL**, 400 Pages . . . 4
- MARINE ENGINEERS Handy Book**, 1280 Pgs. . . 4
- MECHANICAL DRAWING GUIDE**, 160 Pages . . . 1
- MECHANICAL DRAWING & DESIGN**, 480 Pgs. . . 2
- MILLWRIGHTS & Mechanics Guide**, 1200 Pgs. . . 4
- CARPENTERS & Builders Guides (4 vols.)** . . . 6
- PLUMBERS & Steamfitters Guides (4 vols.)** . . . 6
- MASONS & Builders Guides (4 vols.)** . . . 6
- MASTER PAINTER & DECORATOR**, 320 Pgs. . . 2
- GARDENERS & GROWERS GUIDES (4 vols.)** . . . 6
- ENGINEERS and Mechanics Guides** . . . 1
- Nos. 1, 2, 3, 4, 5, 6, 7 and 8 complete . . . 12
- Answers to Practical ENGINEERING** . . . 1
- ENGINEERS & FIREMANS EXAMINATIONS** . . . 1

Name _____

Address _____

Occupation _____

Employed by _____ R.C.F. _____

THE MOST DESIRABLE ANTENNA MOUNT EVER MADE!



Pat. Pending

Chimney Mount Antenna Base

● for TELEVISION
● FM ● AMATEURS

List Price: \$7.50

Cost to Retailer: \$4.50

Installed in 10 minutes • Permits Use
of Several Mounts on One Chimney

Chimney Mount is by far the fastest selling product of its type in the radio and television fields. It can be installed in ten minutes without the use of special tools or drilling of holes. Several mounts can be strapped to one chimney—to pole, 2 x 4, side of house or to any rectangular roof extension. Fastens aerial to highest point with galvanized steel bands having a combined tensile strength of more than 3,000 lbs. Made of corrosion-resistant aircraft-type aluminum alloy. Weight: 3 lbs.

Available Through All Leading
Jobbers and Dealers or Write to:

South River Metal Products Co.
South River, New Jersey

ALL-METAL TV TUBES are now being manufactured by the Tel-O-Tube Corporation of America, according to an announcement made last month by Samuel Kagan, the firm's president. The new tube has a 16-inch viewing surface. They are being produced at the rate of 100 a day, the first metal viewing tube to be made in quantity.

Most of the tube is made of spun chrome-steel alloy. Ordinary plate glass

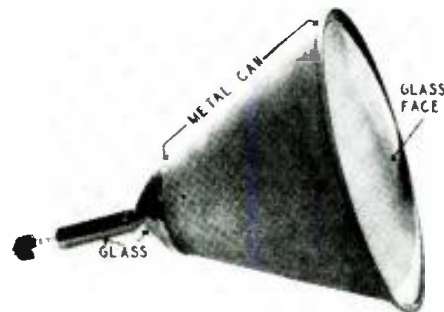

is used for the face. Advantages include: lighter weight (the new tube weighs only about one-sixth as much as a 15-inch all-glass tube); larger viewing area (144 square inches, compared with 115 for a standard 15-inch glass tube); and better shielding from ambient light.

MICROWAVE RELAYS are now being used for some of the ordinary long-distance telephone conversations between New York and Boston, the Long Lines Department of the American Telephone and Telegraph Company announced last month. The new system was completed about a year ago and was used for experiments in the transmission of telephone and television traffic. Seven stations operating in the vicinity of 4,000 mc are used over the New York-Boston route.

NEW OPERATOR LICENSE classifications will not be created, the FCC announced last month. Some time ago the Commission had proposed abandoning the present radiophone licenses which cover broadcast station operators and adopting three new grades, broadcast engineer-operator, broadcast technician-operator, and limited broadcast operator.

The proposal had been strongly opposed by union spokesmen, who characterized it as degrading. It was suggested that the problem of higher qualifications for broadcast operators be solved by advancing the requirements for obtaining the first class 'phone license to cover the latest developments in the field.

The FCC announced that it had started revision of the examinations and that work has been completed on the examinations for first and second permits.

COSMIC NOISE which left outer space about 3,000 years ago is interfering with our radio communication today. According to an account published recently in the *Australian Journal of*

Scientific Research, J. G. Bolton and G. J. Stanley have discovered that this radiation comes from a mysterious space in the constellation *Cygnus*.

The radiation produces the second loudest cosmic noise of any place in the Milky Way. A place in the constellation Sagittarius produces the loudest noise.

The Cygnus radiation is unusual because it sends two kinds of signals. One is of constant intensity at about 100 mc; the other varies in intensity and uses frequencies below 100 mc.

CHILDREN may not attend television shows in New Jersey bars, according to a decision last month by State Alcoholic Beverage Commissioner Erwin B. Hock.

Patrick Radigan, owner of a Hoboken tavern, had made a practice of closing his bar to adults between 6 and 7 p.m. and inviting neighborhood children in to watch the television juvenile programs. In ordering Mr. Radigan to stop the practice, Hock wrote, "However worthy your intentions, I disagree. Henry Wadsworth Longfellow would turn over in his grave if he could see the locale of your 'Children's Hour!'"

SIGNAL CORPS RESERVE UNIT will be organized in New York under the sponsorship of NBC. Chief Signal Officer Maj. Gen. Spencer B. Akin announced last month. The unit will be a mobile radio broadcasting company.

SYNTHETIC MICA with the desirable characteristics of natural mica has been produced for the first time, it was revealed last month. The material is being produced by a pilot plant under a research program sponsored by the Office of Naval Research, the Army Signal Corps, and the Navy Bureau of Ships.

Known as fluorine-phlogopite mica, the synthetic can be separated into thin sheets and has good electrical and mechanical properties and chemical stability. The discovery is important because of the scarcity of natural mica in this country. Indispensable in almost all electronic apparatus, only 15% of the amount of mica needed during the war was produced domestically.

SUSPENSION OF LICENSES of three amateur stations was proposed last month by the FCC. Reuben E. Gross, W2OXR, a lawyer of Staten Island, N. Y., was charged with transmitting deceptive signals. According to the commission, Mr. Gross transmitted and received messages to and from Palestine in code on behalf of a third person and used false call letters in addressing the Palestine station in order to conceal its identity.

Joseph A. Jurkowski and Marvin C. Grossman of Caldwell, N. J., were charged with using profanity during a radio conversation. The commission said the two made "obscene and disrespectful allusions to this commission and the law generally."

ONE OF THESE 5 WILL BEST FILL YOUR V.O.M. REQUIREMENTS



MODEL 630. Outstanding Features: (1) The new Triplett Molded Selector Switch with contacts fully enclosed . . . (2) Has Unit Construction with Resistor Shunts, Rectifier Batteries in molded base . . . (3) Provides direct connections without cabling . . . no chance for shorts . . . (4) Big easily read 5 1/2" Red • Dot Lifetime Guaranteed Meter.

TECH DATA

D.C. VOLTS: 0-3-12-60-300-1200-6000, at 20,000 Ohms/Volt
 A.C. VOLTS: 0-3-12-60-300-1200-6000, at 5,000 Ohms/Volt
 D.C. MICROAMPERES: 0-60, at 250 Millivolts
 D.C. MILLIAMPERES: 0-1.2-12-120, at 250 Millivolts
 D.C. AMPERES: 0-12, at 250 Millivolts
 OHMS: 0-1000-10,000, 4.4 Ohms at center scale on 1000 scale; 44 Ohms center scale on 10,000 range.
 MEGOHMS: 0-1-100 (4400-440,000 at center scale)
 DECIBELS: -30 to -4, -16, -30, -44, -56, -70.
 OUTPUT: Condenser in series with A.C. Volt ranges.

MODEL 630. . . . U.S.A. Dealer net price . . . \$37.50
 Leather Carrying Case, \$5.75. . . Adapter Probe for TV and High Voltage Extra.

MODEL 666-HH. This is a pocket-size tester that is a marvel of compactness and provides a complete miniature laboratory for D.C. and A.C. voltages, Direct Current and Resistance analyses. Equally at home in the laboratory, on the work bench or in the field . . . its versatility has labeled it the tester with a thousand uses . . . housed in molded case . . .

TECH DATA

D.C. VOLTS: 0-10-50-250-1000-5000, at 1,000 Ohms/Volt
 A.C. VOLTS: 0-10-50-250-1000-5000, at 1,000 Ohms/Volt
 D.C. MILLIAMPERES: 0-10-100-500, at 250 Millivolts
 OHMS: 0-2,000-400,000, (12-2400 at center scale)

MODEL 666-HH. . . . U.S.A. Dealer Net Price . . . \$22.00
 Leather Carrying Case, \$4.75.

MODEL 625-NA. This is the widest range laboratory-type instrument with long 5.6" mirrored scale to reduce parallax. Special film resistors provide greater stability on all ranges. Completely insulated molded case. Built by Triplett over a long period of time, it has thoroughly proved itself in laboratories all over the world.

TECH DATA

SIX D.C. VOLTS: 0-1-25-5-25-125-500-2500, at 20,000 Ohms/Volt
 SIX D.C. VOLTS: 0-2.5-10-50-250-1000-5000, at 10,000 Ohms/Volt
 SIX A.C. VOLTS: 0-2.5-10-50-250-1000-5000, at 10,000 Ohms/Volt
 D.C. MICROAMPERES: 0-50, at 250 Millivolts
 D.C. MILLIAMPERES: 0-1-10-100-1000, at 250 Millivolts
 D.C. AMPERES: 0-10, at 250 Millivolts

OHMS: 0-2000-200,000, (12-1200 at center scale)
 MEGOHMS: 0-40, (240,000 at center scale)
 SIX DECIBELS RANGES: -30 +3.0, +15, +29, +43, +55, +69.
 (Reference level "0" DB at 1.73 V. on 500-Ohm line.)
 Six Output on A.C. Volts ranges.

MODEL 625-NA. . . . U.S.A. Dealer Net Price . . . \$45.00
 Carrying Case, \$5.50. Accessories available on special order for extending ranges.

MODEL 2405-A. This instrument combines ultra sensitivity with a large 5 3/4" scale meter and is housed in a rugged metal case. . . It is furnished with hinged cover so that it can be used for service bench work or for portable field service. Gives A.C. Amperes readings to 10 Amps.

TECH DATA

D.C. VOLTS: 0-10-50-250-500-1000, at 20,000 Ohms/Volt
 D.C. AMPERES: 0-10, at 250 Millivolts
 D.C. MILLIAMPERES: 0-1-10-50-250, at 250 Millivolts
 D.C. MICROAMPERES: 0-50, at 250 Millivolts
 A.C. VOLTS: 0-10-50-250-500-1000 at 1000 Ohms/Volt
 A.C. AMPERES: 0-0.5-1.5-10, at 1 Volt-Ampere
 OHM-MEGOHMS: 0-4000-40,000 ohms-0.4-40 megohms (self-contained batteries)
 OUTPUT: Condenser in series with A.C. Volts ranges
 DECIBELS: -10 to +15, +29, +43, +49, +55. (Reference level "0" DB at 1.73 V. on 500-ohm line.)
 CONDENSER TEST: Capacity check of paper condensers is possible by following data in instruction book.

MODEL 2405-A. . . . U.S.A. Dealer Net Price . . . \$59.75

MODEL 2451. Electronic Volt-Ohm-Mil-Ammeter . . . is easy to use in complicated testing . . . A must in F.M. and TV work in any sensitive circuit where low current drain is a factor . . .

TECH DATA

D.C.-A.C.-A.F. VOLTS: 0-2.5-10-50-250-500-1000
 R.F. VOLTS: 0-2.5-10-50
 D.C. MILLIAMPERES: 0-2.5-10-50-250-500-1000
 OHMS: 0-1K-10K-100K
 MEGOHMS: 0-1-10-100
 INPUT IMPEDANCE: 11 Megohms on D.C. Volts.
 4.8 Megohms on A.C.-R.F. Volts

MODEL 2451. . . . U.S.A. Dealer Net Price . . . \$76.50
 External high-voltage probe available on special order. See the Triplett V.O.M. line at your local Radio Parts Distributor or write

TRIPLETT ELECTRICAL INSTRUMENT COMPANY • BLUFFTON, OHIO, U.S.A.

In Canada: Triplett Instruments of Canada, Georgetown, Ontario

Precision first... to Last



Now AIR KING "Know How" makes possible this outstanding Portable WIRE RECORDER

Complete with
AMPLIFIER

\$99⁹⁵

INCLUDES FEDERAL TAX
Slightly higher in Zone 2



The AIR KING Wire Recorder line is complete



Model A-750-1



Model 4700

AIR KING

Portable Wire Recorder
Model A-725

Only Experience can build fine WIRE RECORDERS

—and *only* AIR KING experience could build this moderately priced, matchless Wire Recorder with Amplifier. As pioneers, AIR KING has achieved and maintained the leadership in the magnetic recorder industry. Glamorous consoles... compact portables... radio-phono-wire recorder combinations: every one is AIR KING *experience-built*. It's the *know-how* that counts!

AIR KING has it!

AIR KING PRODUCTS CO., INC., 170 53rd STREET, BROOKLYN 32, NEW YORK
Export Address: Air King International, 75 West Street, New York 6, New York

✓ THESE SELLING ADVANTAGES

- ★ Complete with amplifier
- ★ Records direct from radio, phonograph or telephone
- ★ Automatic shut-off at end of play or rewind of wire
- ★ Crystal mike for hand table or stand and plug-in mike cord
- ★ Rewind speed: 6 times forward speed
- ★ Plug for cable to record from radio to phonograph
- ★ Erases automatically when recording over used wire
- ★ Safety lock prevents accidental erasure
- ★ Covered in leatherette
- ★ One piece chassis
- ★ Luggage-type carrying case
- ★ 5" Alnico V P.M. Speaker
- ★ TUBES: 2 — 50L6, 1 — 1280, 1 — 6AQ6 plus selenium rectifier
- ★ WEIGHS: 21½ lbs.
- ★ MEASURES: 13¾" long by 12" wide by 9" high

AIR KING RADIO

Division of HYTRON RADIO & ELECTRONICS CORP.

The Royalty of Radio Since 1920





I'll Send You 8 Big Kits of Training Equipment
including
TWO-BAND 6 TUBE SUPER RECEIVER
AND 16 RANGE METER SET-UP
for Testing

Learn Fast . . . Earn Fast
HOME TRAINING
Planned For Your Needs
You Build All These
TESTERS . . . and MORE!

I give you a fine, moving-coil type Meter Instrument on Jewel Bearings—with parts for a complete Analyzer Circuit Continuity Tester. You learn how to check and correct Receiver defects with professional speed and accuracy.

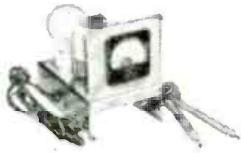

Practice Does It!

Soldering, wiring, connecting Radio Parts . . . building circuits with your own hands—you can't beat this method of learning. When you construct this Rectifier and Filter Resistor and Condenser Tester, etc., you get a really practical slant on Radio that leads to a money-making future.

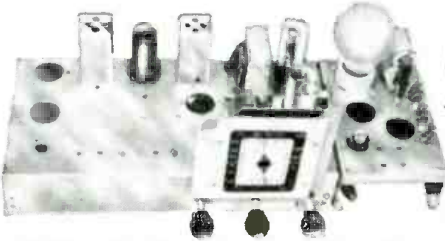
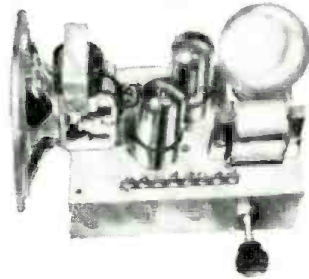

Building this Signal Generator and multi-purpose Tester will give you the kind of valuable experience and practice that is so important as a foundation for making good money in Radio. It makes a breeze out of fixing Radios, and you don't have to spend money on ready-made Equipment.

NOW! TWO LOCATIONS
TO SERVE YOU BETTER
 Mail Coupon to Location Nearest Your Home
SPRAYBERRY ACADEMY of RADIO, Dept. 20-L
 Sprayberry Building or 20 N. Wacker Drive
 Pueblo, Colorado or Chicago 6, Illinois



PRACTICE WITH YOUR OWN HANDS!
 Mind training through hand practice, that's the only way to LEARN and REMEMBER Radio. It's the most successful of Home Training methods.



OVER 175 PRACTICAL EXPERIMENTS
 You'll find out how to build countless Radio Circuits. You'll learn a new, fast way to test Radio Sets without mfg. Equipment.

LOW COST HOME RADIO TRAINING!
Easy Monthly Payments!

My perfected Radio Training prepares you to start your own Radio Service Shop—or to land a big pay Radio job. With my help you get Radio jobs while learning—*or extra cash and rich experience.* I train you RIGHT—by putting you to work with your hands in your own home during spare hours. You get 8 big kits of real professional Radio Parts and Equipment—and use them to build, test and trouble-shoot a powerful 6 tube superhet receiver, a 16 range test meter set-up and over 175 fascinating, instructive Radio experiments. My training is down-to-earth, really

PRACTICAL—it's the Training you need to make money in Radio. Theory is cut to the bone—you don't need any previous schooling or experience. Sprayberry Training starts you out at the very beginning of Radio—the lessons are illustrated, simply written and easy to understand. Get the facts about Sprayberry Training now. Find out what it can do for you—prepare for amazing opportunities in Radio Servicing, Television, FM, Radar and Industrial Electronics. Fill out and mail coupon for my two big Books—FREE. No obligation—and no salesman will call. Mail coupon Now!

MAIL COUPON FOR THESE 2 BOOKS!



VETERANS: Approved for G.I. Training under Public Laws 16 and 346

SPRAYBERRY ACADEMY of RADIO, Dept. 20-L
 SPRAYBERRY BUILDING, PUEBLO, COLORADO, or
 20 NORTH WACKER DRIVE, CHICAGO 6, ILLINOIS

Please push my FREE copies of "How to MAKE MONEY in RADIO, ELECTRONICS and TELEVISION" and "How to READ RADIO DIAGRAMS and SYMBOLS."

Name _____ Age _____
 Address _____
 City _____ State _____

(Mail in envelope or paste on penny postcard)

How do you stack up in the modern radio servicing field?



- AM BROADCAST RECEIVERS
- FM BROADCAST RECEIVERS
- TELEVISION RECEIVERS
- AUTOMATIC PHONOGRAPHS
- HOME RECORDING DEVICES
- PUBLIC ADDRESS SYSTEMS
- INTERCOMMUNICATING SYSTEMS
- HEARING AIDS
- TELEPHOTO EQUIPMENT
- HOME FACSIMILE RECEIVERS
- RADIO WEATHER DEVICES
- HOME SOUND MOVIES
- RADIO TELETYPEWRITERS
- ALARM SYSTEMS
- CARDIOGRAPHS
- CHEMICAL CONTROLS
- CIRCUIT BREAKERS

- SAFETY DEVICES
- SELECTING MACHINES
- SIGNALLING
- SIGN CONTROLS
- DENSITOMETERS
- DETECTORS
- DETONATORS
- DOOR OPENERS
- DRYERS
- ENGINE TESTERS
- ELEVATOR LEVELERS

- ELECTRIC FENCES
- FURNACE CONTROL
- FURNACES, INDUCTION
- GAS DETECTION
- GRADERS
- HEATERS
- MEASURING DEVICES
- METAL ANALYSIS
- MICROSCOPES
- MOTOR CONTROLS
- PACKAGING

- MOBILE COMMUNICATIONS EQUIPMENT FOR:
 - POLICE, FIRE, FOREST SERVICE, AIRCRAFT, MARINE, EXPLORATIONS, RAILROADS, TAXICABS, STREETCARS, BUSES, TRUCKS, AMBULANCES, EMERGENCY VEHICLES, ETC.
 - SYNCHRONIZERS
 - THERAPY EQUIPMENT
 - THICKNESS GAUGES
 - TIMERS
 - TRAFFIC CONTROLS
 - VIBRATION
 - WEIGHING
 - WELDING
 - WRAPPING
 - X-RAY

**CREI Technical Training Can Prepare You
Now to Meet These New Demands That Mean
More Money and Security for You!**

Have you taken a really good look recently at the expanding service field? Do you have a feeling of helplessness when you think of some of the intricate, new-model equipment that you may be called upon to service? Or of the many jobs you may be missing in these related fields because you feel you don't know anything about them?

You may as well face the facts. You must keep your technical ability in pace with industrial developments—or be left behind because you lack understanding of radio-electronics as applied today to business and industry.

There is no need to tell these things you already know. But it is important for you to realize that, no matter whether you are a "beginner" or an "old timer" CREI home study training can help you. You will find that CREI courses in Radio-Electronics and Television are pitched to your own level. They take you *all the way* from introductory basic principles to advanced training, on to specialized subjects. CREI training can help you *right now*, in your daily work in the installation and servicing of radio-electronic equipment.

CREI's reputation has been proved over a period of 20 years. Join the many servicemen who are studying—at home—the new developments and techniques with CREI—protecting their future jobs, their businesses by acquiring the new "know-how" NOW!

TELEVISION AND FM SERVICING

This is it! The New 100%
Practical "On-the-Job" Course

SEND IN THE COUPON NOW!

↓ Find Out for Yourself How
This New CREI Course Can Help You ↓

Radio Service Division of

CAPITOL RADIO ENGINEERING INSTITUTE

An Accredited Technical Institute

Dept. 5118, 16th & Park Rd., N. W., Washington 10, D. C.

Branch Offices: New York (7) 170 Broadway • San Francisco (2) 760 Market St.

MAIL
TODAY

CAPITOL RADIO ENGINEERING INSTITUTE
16th & Park Road, N. W., Dept. 5118, Washington 10, D. C.

Gentlemen:

Please send me complete details of your new home study course in Television and FM Servicing. I am attaching a brief resume of my experience, education and present position.

NAME _____

STREET _____

CITY _____ ZONE _____ STATE _____

I AM ENTITLED TO TRAINING UNDER G. I. BILL.

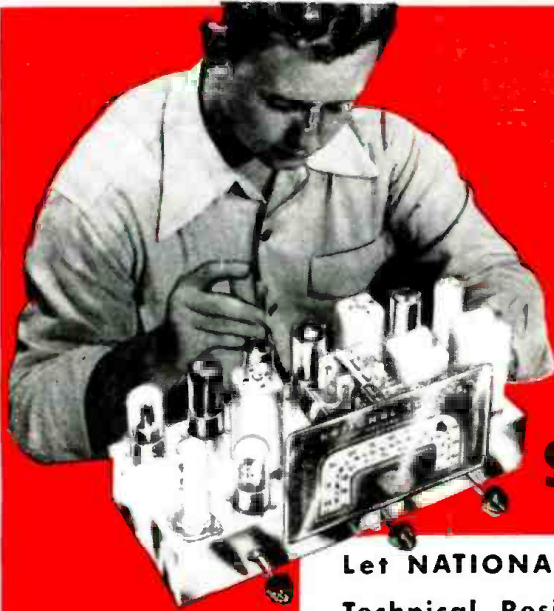

Learn RADIO

TELEVISION, ELECTRONICS

by SHOP METHOD HOME TRAINING

Let NATIONAL SCHOOLS, of Los Angeles, a practical Technical Resident Trade School for almost 50 years, train you for today's unlimited opportunities in Radio

You receive all parts, including tubes, for building this fine, modern Superheterodyne Receiver. This and other valuable standard equipment becomes your property.

these two FREE books will tell you how



Good Jobs Await the Trained Radio Technician

You are needed in the great, modern Radio, Television and Electronics industry! Trained Radio technicians are in constant and growing demand at excellent pay—in Broadcasting, Communications, Television, Radar, Research Laboratories, Home Radio Service, etc. National Schools Master Shop Method Home Study course, with newly added lessons and equipment, can train you in your spare time, *right in your own home*, for these exciting opportunities. Our method has been proved by the remarkable success of National Schools-trained men all over the world.

You Learn by Building Equipment with Standard Radio Parts We Send You

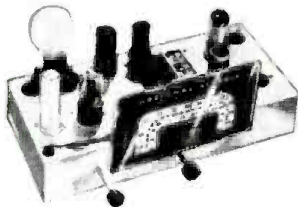

Your National Schools Course includes not only basic theory, but *practical training as well—you learn by doing*. We send you complete standard equipment of professional quality for building various experimental and test units. You advance step by step until you are able to build the modern superheterodyne receiver shown above, which is yours to keep and enjoy. You perform more than 100 experiments—build many types of circuits, signal generator, low power radio transmitter, audio oscillator, and other units. The Free Books shown above tell you more about it—send for them today!

Now! NEW PROFESSIONAL MULTITESTER INCLUDED!

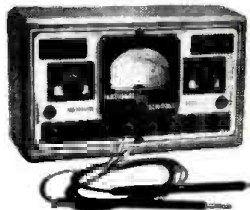

This versatile testing instrument is portable and complete with test leads and batteries. Simple to operate, accurate and dependable. You will be able to quickly locate trouble and adjust the most delicate circuits. You can use the Multitester at home or on service calls. It is designed to measure AC and DC volts, current, resistance and decibels. You will be proud to own and use this valuable professional instrument.

Lessons and Instruction Material Are Up-to-date, Practical, Interesting.

National Schools Master Shop Method Home Training gives you basic and advanced instruction in all phases of Radio, Television and Electronics. Each lesson is made easy to understand by numerous illustrations and diagrams. All instruction material has been developed and tested in our own shops and laboratories, under the supervision of our own engineers and instructors. A free sample lesson is yours upon request—use the coupon below.

You Get This and Other Valuable Information in the Free Sample Lesson:

1. Basic Receiver Circuits and How They are Used.
2. Construction of the Antenna Circuit.
3. How Energy is Picked Up by the Aerial.
4. How Signal Currents are Converted into Sound.
5. How the Tuning Condenser Operates.
6. How the R-F Transformer Handles the Signal, and other data, with diagrams and illustrations.

Both Home Study and Resident Training Offered

APPROVED FOR VETERANS
Check Coupon Below

NATIONAL SCHOOLS LOS ANGELES 37, CALIFORNIA EST. 1905 MAIL OPPORTUNITY COUPON FOR QUICK ACTION

National Schools, Dept. RC-11, 4000 S. Figueroa, Los Angeles 37, Calif. Paste on a Postcard

Mail me FREE the books mentioned in your ad, including a sample lesson of your courses. I understand no salesman will call on me.

NAME AGE

ADDRESS

CITY ZONE STATE

Check here if Veteran of World War II

GET THE DETAILS—SEND THE COUPON →

RADIO-ELECTRONICS

formerly RADIO-CRAFT

Incorporating

SHORT WAVE CRAFT*

TELEVISION NEWS*

RADIO & TELEVISION

*Trademark registered U. S. Patent Office

Hugo Gernsback, Editor-in-Chief
 Fred Shunaman, Managing Editor
 M. Harvey Gernsback, Consulting Editor
 Robert F. Scott, W2PWG, Technical Editor
 R. H. Dorf, W2QMI, Associate Editor
 I. Queen, W2OUX, Editorial Associate
 Angie Rascale, Production Manager
 Elmer Fuller, Shortwave Editor
 Wm. Lyon McLaughlin,
 Tech. Illustration Director
 G. Aliquo, Circulation Manager
 John J. Lamson, Advertising Director
 Alfred Stern, Promotion Manager

Contents — November 1948

Editorial (Page 21)	
How to Break into Servicing.....	by Hugo Gernsback 21
Audio (Pages 22-23)	
Sound Helps You Make More Money.....	by Matthew Mandl 22
Amateur (Pages 24-25)	
Ten-Meter Final From TU-10-B.....	by L. W. May, W5AJG 24
Servicing (Pages 26-30)	
Servicing a Noisy Set.....	by H. A. Nickerson 26
Radio Performance Tests.....	by K. V. Amatneek 28
Broadcasting and Communications (Pages 31-32)	
A Carrier-Controlled Recorder.....	by Rhett McMillian 31
FM (Pages 33-37)	
Aligning FM Receivers.....	by John B. Ledbetter 33
FM Handie-Talkie Radio for Industry (Cover Feature).....	35
Electronics (Pages 38-41)	
Electronics in the Toy World.....	by Richard Henry 38
Electronics in Medicine.....	by Eugene Thompson 40
Television (Pages 42-48)	
Using TV Test Patterns.....	by John R. Meagher 42
Compensating TV Amplifiers.....	by Robert F. Scott 44
High Band Telecoaster.....	by I. Queen 48
Test Instruments (Pages 50-58)	
Sensitive Vacuum-Tube Voltmeter.....	by John W. Straede 50
Signal Tracers are Popular.....	by T. W. Dresser 56
Construction (Page 62)	
Instrument Voltage Supply.....	by R. L. Parmenter 62
Foreign News (Page 64)	
European Report.....	by Major Ralph W. Hallows 64
Theory and Design (Page 87)	
Capacitor Drops Voltage.....	by Otto von Guericke 87
Departments	
The Radio Month.....	10
Radio Business.....	16
New Devices.....	60
New Patents.....	68
Radio-Electronic Circuits.....	72
People.....	74
Technotes.....	75
Try This One.....	78
Question Box.....	80
Miscellany.....	82
World-Wide Station List	
by Elmer R. Fuller	88
Communications.....	92
Book Reviews.....	97

RADIO-ELECTRONICS, November, 1948, Volume XX, No. 2. Published monthly. Publication Office: Erie Ave., P. O. Box 32, Philadelphia 32, Pa. Entered as second class matter at Post Office, Springfield, Mass., under Act of March 3, 1879. Application pending transfer to the Philadelphia, Pa. Post Office. **SUBSCRIPTION RATES:** In U. S. and Canada, in U. S. possessions, Mexico, South and Central American countries, \$3.50; \$6.00 for two years; \$8.00 for three years, single copies 30c. All other foreign countries \$4.50 a year, \$8.00 for two years, \$11.00 for three years. Allow one month for change of address. When ordering a change please furnish an address stencil impression from a recent wrapper.

RADGRAFT PUBLICATIONS, INC. Hugo Gernsback, Pres.; M. Harvey Gernsback, Vice-Pres.; G. Aliquo, Sec'y. Contents Copyright, 1948, by Radcraft Publications, Inc. Text and illustrations must not be reproduced without permission of copyright owners.

EDITORIAL and ADVERTISING OFFICES, 25 West Broadway, New York 7, N. Y. Tel. REctor 2-9690. **BRANCH ADVERTISING OFFICES:** Chicago: 308 W. Washington Street, Telephone RAncolph 6-7363. Detroit: Frank Holstein, Room 302, Lexington Bldg., 297 1/2 West Grand Blvd., Telephone TRinity 5-7226. Los Angeles: Ralph W. Barker, 600 South Hill St., Tel. TRuck 1-793. San Francisco: Ralph W. Barker, 382 Market St., Tel. CArfield 1-2481.

FOREIGN AGENTS: Great Britain: Atlas Publishing and Distributing Co., Ltd., 18 Bible Lane, Fleet St., London E.C.4. Australia: Merrill's Agency, 179 Elizabeth Street, Melbourne, France: L'Internatio, 37 Avenue de l'Opera, Paris 2e. Holland: Trilicium, Heemsteedsche Dreef 121 Heemstede. Greece: International Book & News Agency, 17 Amerikis Street, Athens. So. Africa: Central News Agency, Ltd., Cor. Risik & Commissioner Str., Johannesburg; 112 Long Street, Capetown; 369 Smith Street, Durban. Natal: Publishers Book Agency, 70 Harrison Street, Johannesburg. Middle East: Steimatzky Middle East Agency, Jaffa Road, Jerusalem. India: Susil Gupta (Distributors) Co., Amrita Bazar Patrika Ltd., 11 Ananda Chatterjee Lane, Calcutta.

Editorial and Executive Offices:
 25 West Broadway, New York 7, N. Y.



MEMBER AUDIT BUREAU OF CIRCULATION
 ABC PAID CIRCULATION 6 MONTHS TO JUNE 30,
 1948—112,592. (Publishers' Statement) PRINTED
 FOR NOVEMBER ISSUE—157,000



with radio men!

This year again more radio men will buy more Sealdtite* Capacitors than any other molded paper tubulars.

This year-after-year preference for Sealdtite Capacitors over all other molded paper tubulars is positive proof of Sealdtite superiority. And there are reasons! Solar's exclusive all-purpose molded Hi-Temp construction resists atmospheric moisture, and heat up to 100°C—no cardboard tubes to grow soggy—no dripping wax. These all add up to definite assurance of long trouble-free life. Write right now for catalog.

SOLAR CAPACITOR SALES CORP.
 NORTH BERGEN, NEW JERSEY

SEALDTITE MEANS LONGER LIFE

★ Trade Mark



RADIO-ELECTRONICS for

You Practice COMMUNICATIONS

I Send You Parts To Build This Equipment

As part of my new Communications Course I send you parts to build your own Transmitter. Conduct actual procedure demanded of Broadcast Station Operators, practice many interesting experiments and tests, learn how to put a transmitter on the air.



NEW

You Practice Radio SERVICING

On This Modern Radio You Build With Parts I Send

As part of my Servicing Course, I send you the speaker, tubes, chassis, transformer, loop antenna, EVERYTHING you need to build this modern Radio Receiver that brings in local and distant stations. You use it to conduct many tests and experiments.

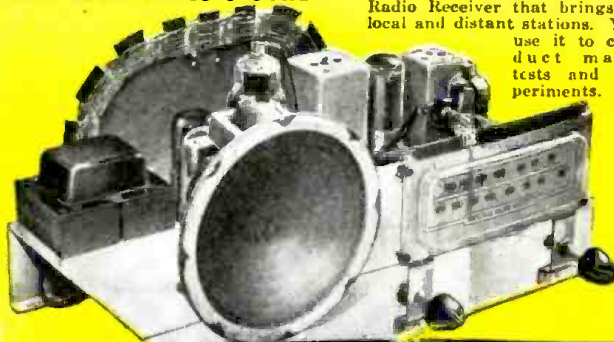

BE A RADIO TECHNICIAN

Learn Servicing or Communications

Learn by Practicing in Spare Time with MANY KITS OF PARTS I Send

YOU BUILD this Tester as part of my Servicing Course. It soon helps you EARN EXTRA MONEY fixing neighbors' radios in spare time.

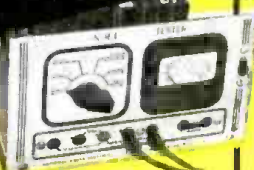

YOU BUILD this Power Pack as part of my new Communications Course. Use it to conduct fascinating experiments with frequency amplifiers and multipliers, buffer stages, etc.



YOU BUILD this Superheterodyne Receiver Circuit and conduct Frequency Modulation experiments and many other tests as part of my Servicing Course.



YOU BUILD this Signal Generator as part of my Servicing Course for more valuable experience. It provides amplitude-modulated signals for many interesting tests and experiments.



VETERANS

YOU CAN GET THIS TRAINING UNDER G. I. BILL MAIL COUPON

YOU BUILD this Wavemeter as part of my new Communications Course. Use it with Oscillator you also build that furnishes basic power to transmitter and determines transmitter frequency.



J. E. SMITH, President National Radio Institute

Want a good-pay job in the fast-growing Radio and Television industries or to be boss of your own money-making Radio and Television shop? I've trained hundreds of men with no previous experience to be Radio technicians. I can do the same for you! Or now, for the first time, enroll in my new practical course in Radio—Television Communications—learn to be a Broadcasting and Communications technician. You learn Radio and Television principles from clear, illustrated lessons. You get practical Radio experience with MANY KITS OF PARTS I SEND in my train-at-home method. All equipment yours to keep.

MAKE EXTRA MONEY IN SPARE TIME

As part of my Radio Servicing Course, I send EXTRA MONEY booklets, starting the day you enroll. Use your know-how to make EXTRA MONEY fixing radios in spare time while training. The next step is your own Radio shop or a good-pay Radio servicing job. Or, if you prefer, get into Government, Police, Aviation or Marine Radio, Broadcasting, Radio Manufacturing or Public Address Work.

BRIGHT FUTURE IN TELEVISION

Think of the present and future opportunities in the fast-growing Television field. New stations are going on the air every month. Television manufacturers are producing over 100,000 sets a month. It's a fast-growing field and the man who knows Television will be in demand.

GET ACTUAL LESSON AND BOOK FREE

Send now for my special DOUBLE FREE OFFER. Get actual lesson on Radio Repairing short-cuts absolutely free. Also get 64-page book, "HOW TO BE A SUCCESS IN RADIO—TELEVISION—ELECTRONICS." See how quickly, easily you can start. J. E. SMITH, President, Dept. 8MX, National Radio Institute, Pioneer Home Study Radio School, Washington 9, D. C.

I TRAINED THESE MEN AT HOME



Good Job In Radio Station
"Am Chief Engineer of Station WORD, in charge of four men. Owe all I know about Radio to NRI."—CLYDE J. BURDETTE, Spartanburg, South Carolina.



Makes Extra Cash In Spare Time
"Earned enough spare time cash to pay for my course by time I graduated. NRI training is tops!"—ALEXANDER KISH, Carteret, New Jersey.



Operates Own Radio Business
"Now have two Radio shops servicing about 200 sets a month. Have largest service establishment in Southeast Missouri."—ARLEY STUDYVIN, DeSoto, Mo.

Good for Both—FREE

MR. J. E. SMITH, President, Dept. 8MX National Radio Institute, Washington 9, D. C.

Mail me FREE Sample Lesson and 64-page book about how to win success in Radio and Television—Electronics. (No salesman will call. Please write plainly.)

Name..... Age.....

Address.....

City..... Zone..... State.....

Check If Veteran APPROVED FOR TRAINING UNDER G. I. BILL

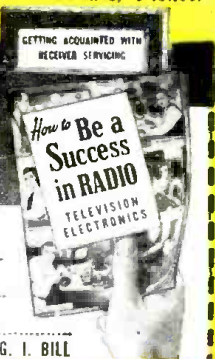

MY COURSE INCLUDES **TELEVISION**