



Wearable Light Organ

Written By: Steve Hobley

TOOLS:

- [Soldering Iron, 15-Watt \(1\)](#)
from RadioShack.
- [Wire cutter/stripper \(1\)](#)

PARTS:

- [Op-Amp chip, Quad, LM324 \(1\)](#)
from RadioShack.
- [Capacitor, 1.0 \$\mu\$ F non-polarized electrolytic \(capacitor code 105\) \(1\)](#)
from RadioShack.
- [Capacitor, 0.1 \$\mu\$ F ceramic \(100 nF, capacitor code 104\) \(1\)](#)
from RadioShack.
- [Microphone condenser element \(1\)](#)
from RadioShack.
- [Transistor, NPN, 2N4401 \(1\)](#)
from RadioShack.
- [Resistor assortment, 500 piece \(1\)](#)
from RadioShack.
- [PC board, grid style, with 371 holes \(1\)](#)
from RadioShack.
- [Hookup wire, 22 gauge, multiple colors \(1\)](#)
from RadioShack.
- [Battery snap, 9V \(1\)](#)

from RadioShack.

- [Battery, 9V \(1\)](#)

from RadioShack.

- [Solder, lead-free \(1\)](#)

from RadioShack.

- [LED 5mm \(1\)](#)

from RadioShack.

SUMMARY

This simple, wearable circuit uses an [operational amplifier](#) (or "op-amp") chip to convert sound into light. An LM324 op-amp and a transistor boost input from a mini condenser microphone to light a series of LEDs. Watch it blink to the beat of your favorite music.

Check out more [Weekend Projects](#).

Step 1 — Gather the parts



- All the resistors you need are in the "grab bag" resistor assortment pack from RadioShack.
- The electret microphone element is polarized, so be careful not to reverse the connections. The ground leg is the one with the 3 silver traces running to the case (second photo).
- To identify resistor values from their color codes, you can use [this online calculator](#).
- The LM324 chip has four op-amps, but this circuit only requires two of them.



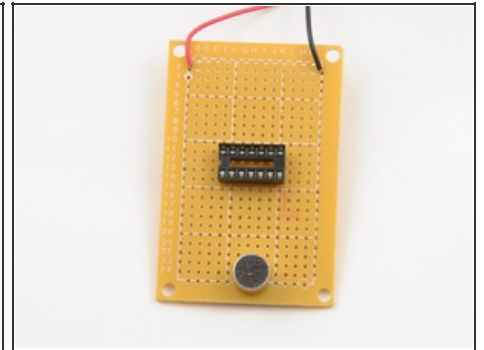
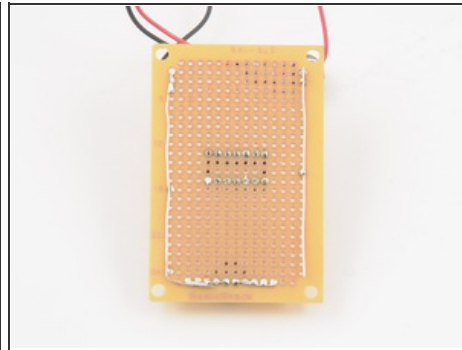
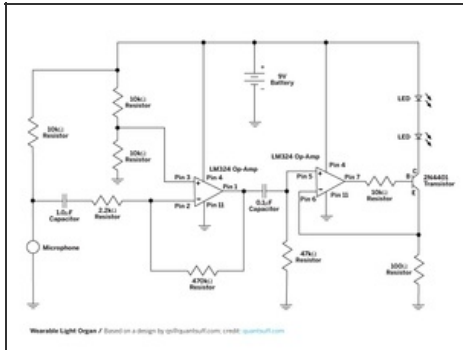

Step 2 — Solder the mic, socket, and power

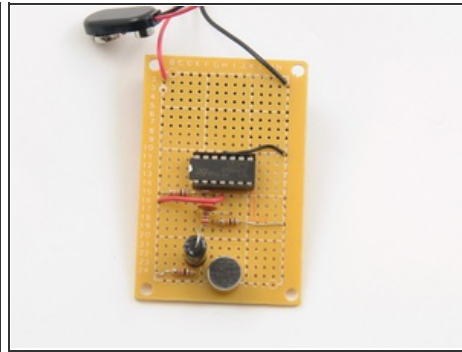
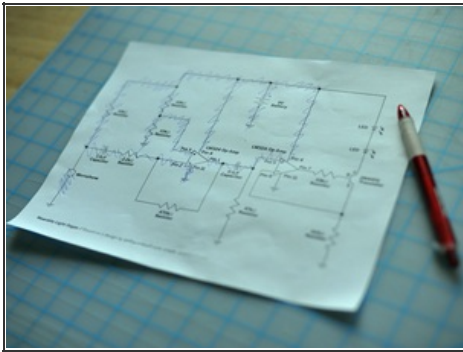

- Follow the schematic to connect all components, starting with the microphone, chip socket, and battery holder.
- It is useful to strip some wire and create a power "bus" consisting of V+ and Ground (-) lines running down the underside of the board on opposite sides. Solder these to the red (+) and black (-) wires of the battery holder, respectively.
- On the schematic, the LM324 chip is drawn functionally, using two separate amplifier symbols (the triangles). Both of these represent the same component, and you need only one connection each between Pin 4 and V+, and Pin 11 and Ground.

Step 3 — Add the input stage resistors and capacitors



- When you are following a schematic, it's useful to print it out and mark off each connection as you make it. Quite often your circuit board layout will not resemble the diagram, and so, doing this lets you know how much you have completed. 
- In the second photo here, you can see most of the input stage components added. These are: Microphone, 3x 10k Ω resistors (Brown, Black, Orange, Gold), 2.2k Ω resistor (Red, Red, Red, Gold), 470k Ω resistor (Yellow, Violet, Yellow, Gold), 1 μ F capacitor and 01. μ F capacitor.
- Plug the LM324 chip into the socket. Note the chip's orientation. With the notch pointing up, Pin 1 is top left corner, and the pins are numbered counter-clockwise.
- Power it up by inserting the batteries. If nothing starts smoking, that's a good sign!
- To check the output from the first amplifier, I hooked up an oscilloscope to the right hand leg of the 0.1 μ F capacitor. This showed a sound wave when I spoke - so far, so good! 

Step 4 — Add the the second stage resistors

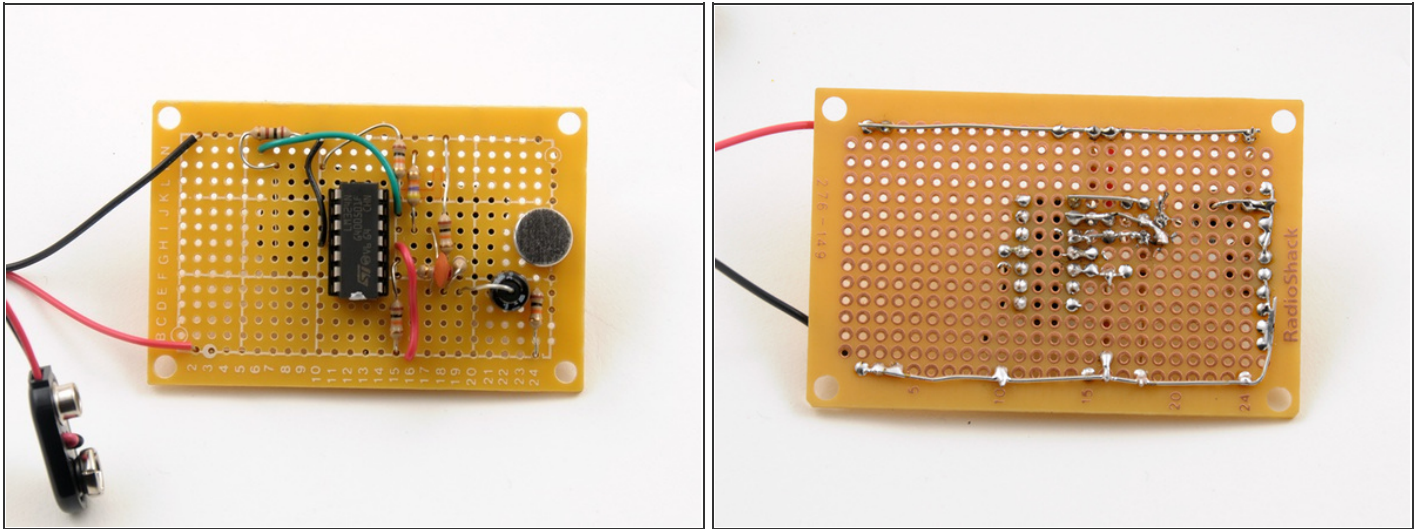

- We're getting really close now. Add the remaining resistors: 47kΩ ohm (Yellow, violet, orange, gold), 10kΩ ohm (Brown, black, orange, gold), 100Ω (Brown, black, brown, gold).
- Solder a connecting wire from chip Pin 7 to where you'll put the transistor, which we'll add in the next step.
- All that remains is to add the transistor and the LEDs.

Step 5 — Final assembly - and testing!

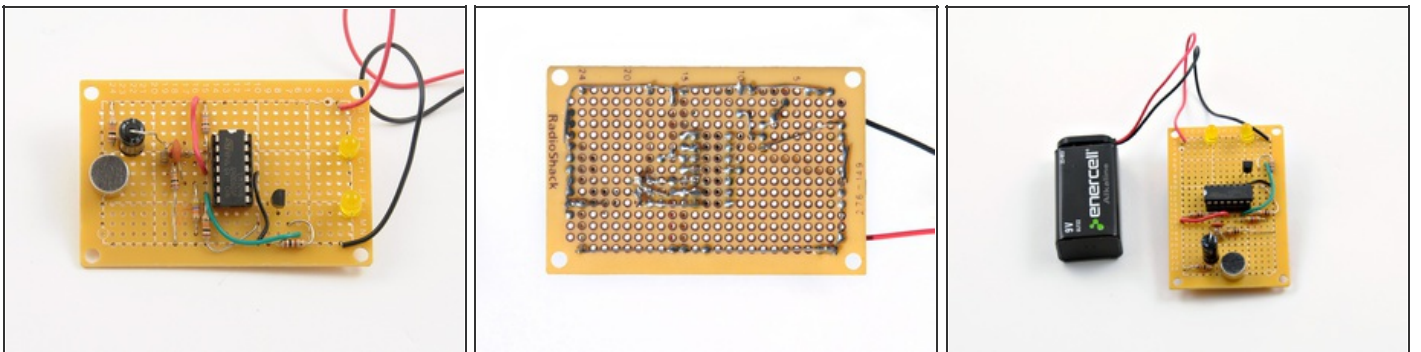

- Finish up by connecting the transistor (note the orientation) and the LEDs, connected in series.
- Now we should be able to turn the Wearable Light Organ on and see something happening.
- You can see a little YouTube movie of the device in action [here](#).

This project demonstrates how to amplify a signal from a microphone and use that signal to

switch a transistor on and off. The transistor in turn is used to drive some LEDs. Circuits like this are very popular among hobbyists, and are often referred to as ["light organs."](#)

This document was last generated on 2012-10-30 06:09:37 PM.