

R2A

S/L

SECTION

S.N. 20 - UP.

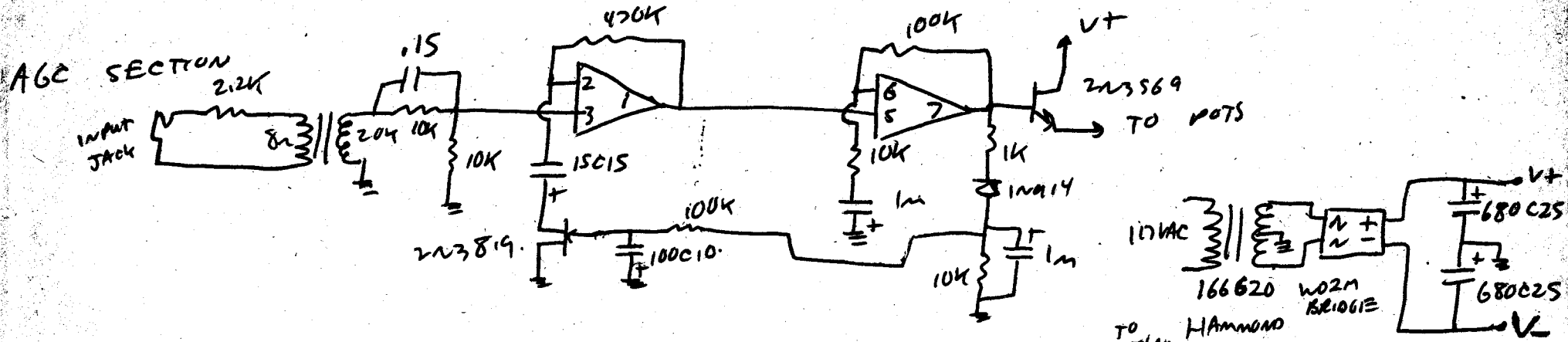

**FILTER SECTION**

FROM AGC SECTION

4 x 10K POTS.

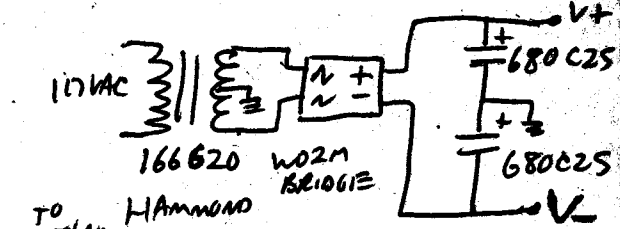
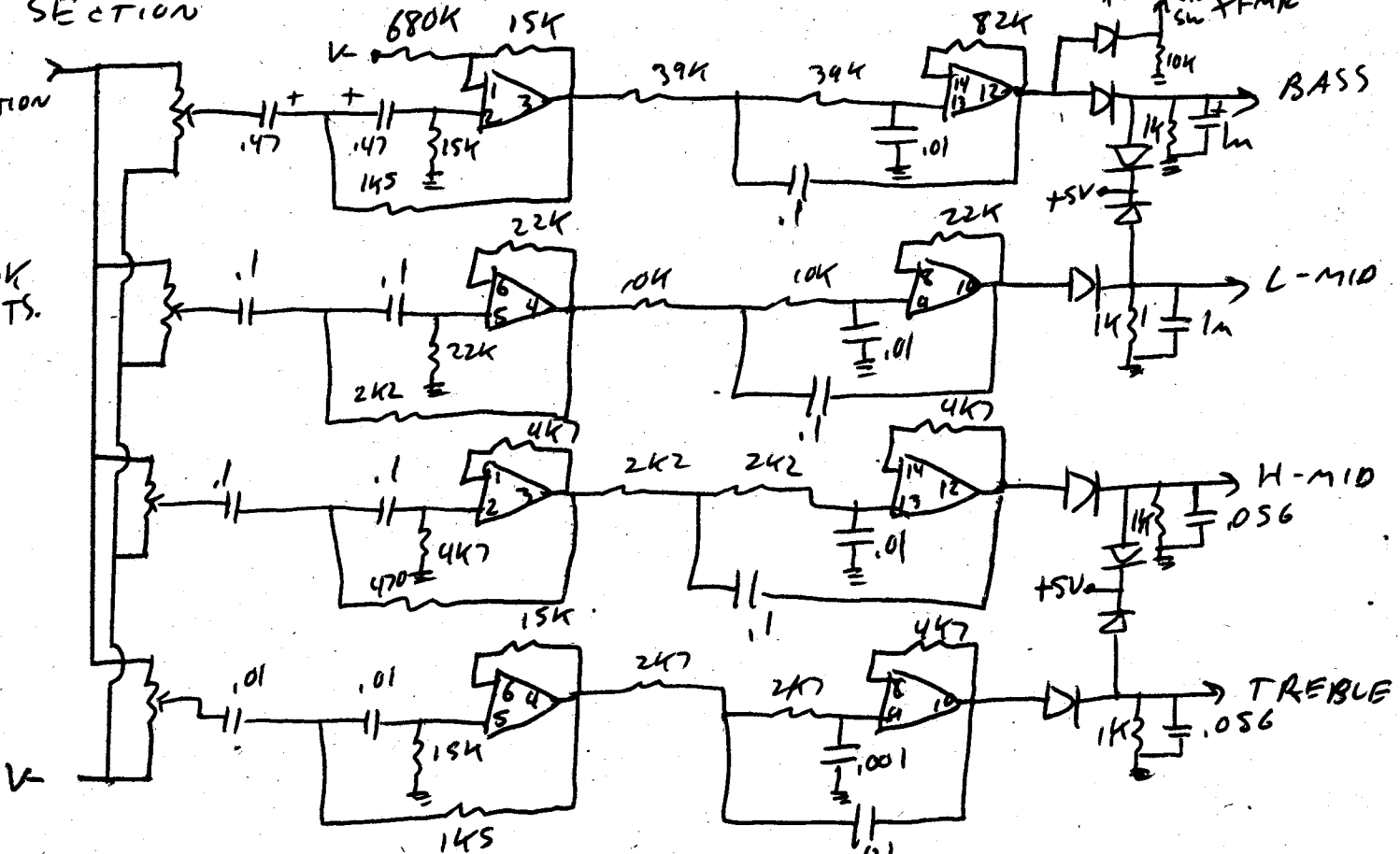

Done 4/1/79.  
D. F. ...

IC = 2 x 4136

R2 A DIGITAL

SECTION  
3 X 7438

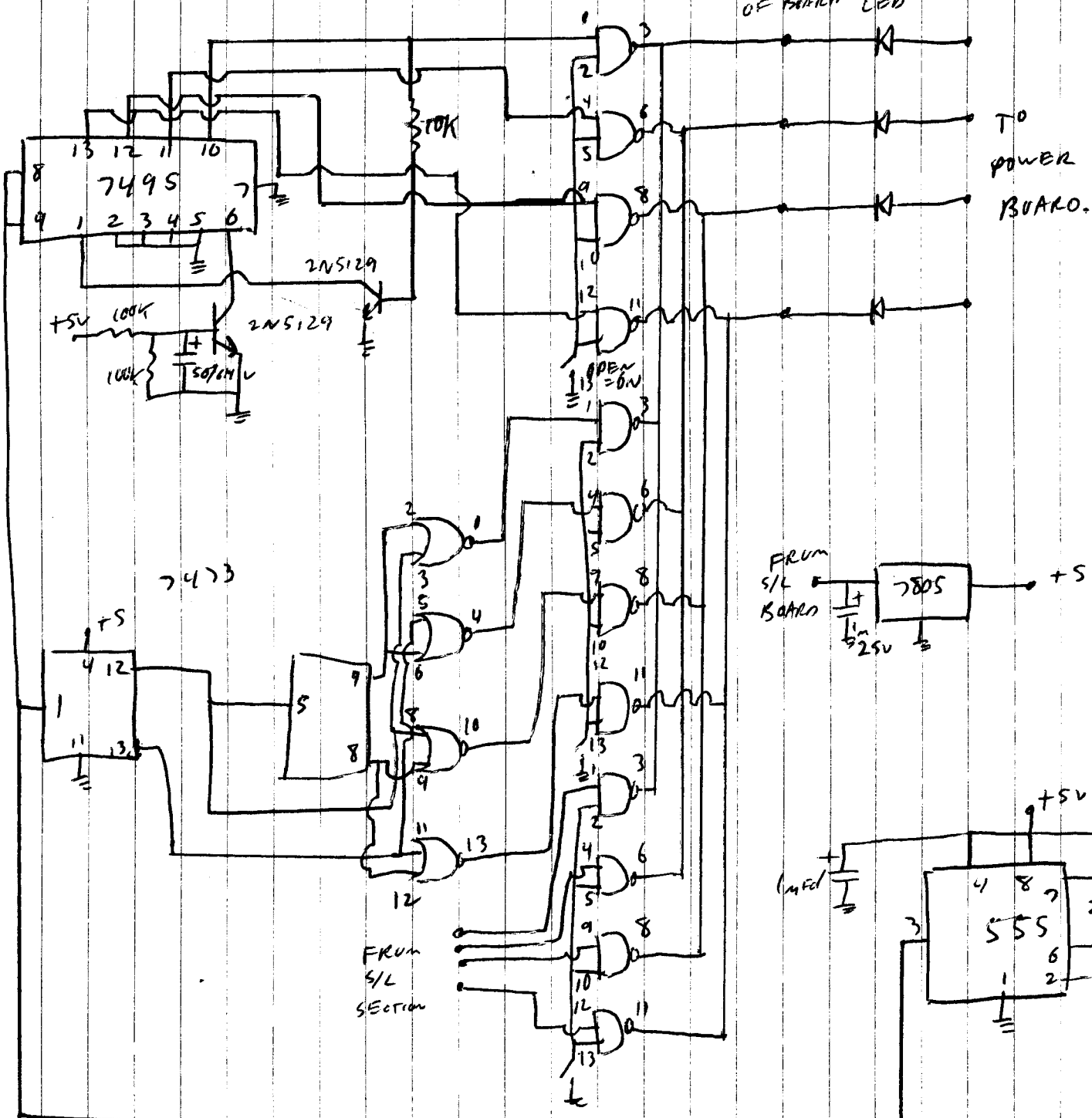

June 19/78  
D. Fran

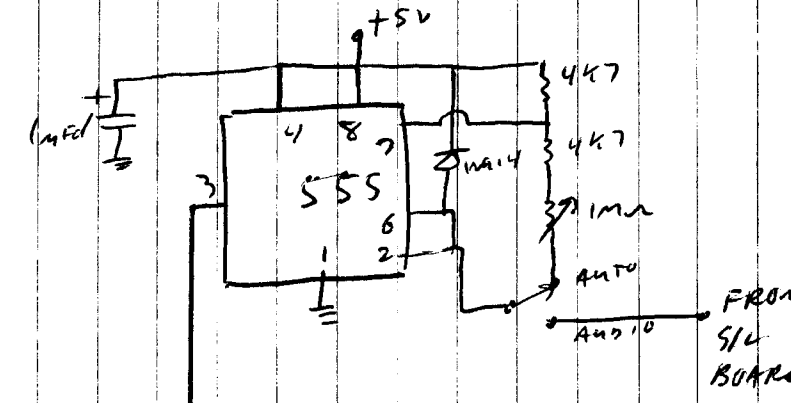
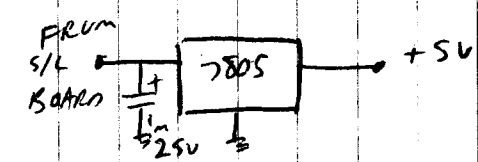

POWER BOARD OLD EARLY PRODUCTION

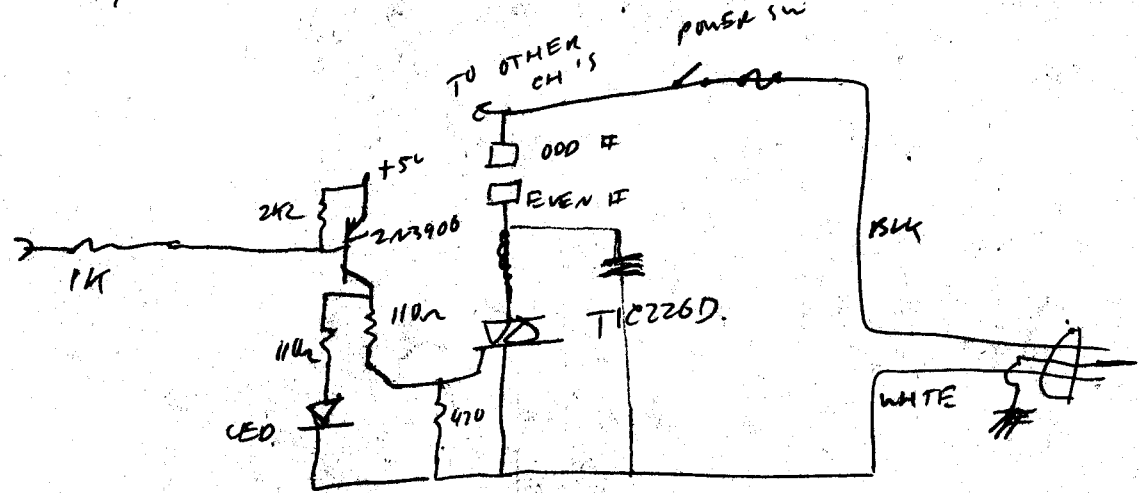

NEW LATER PRODUCTION > MAY 18/75

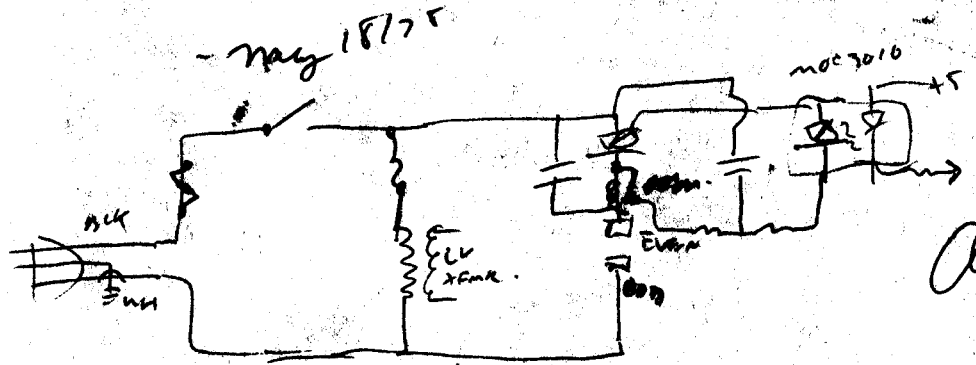

April 20/78  
D. Fross

D. Fross

# LATEX PRODUCTION POWER BOARD

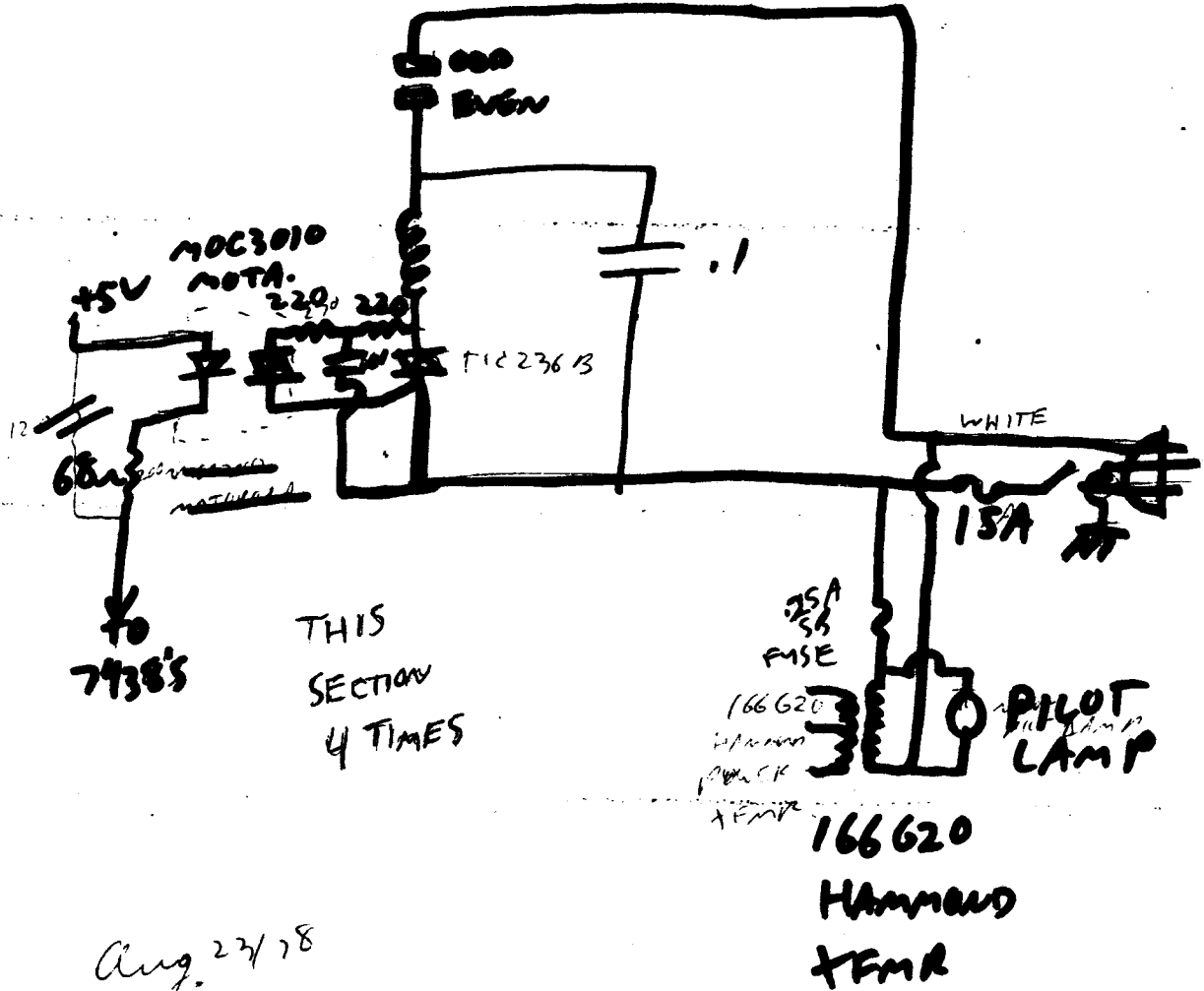

Aug. 23/78  
D. J. [unclear]

# TIL III TRIAC BOARD.

Jan 10/80  
D. Frase

2m-400V  
ON WITS WITH  
LOW SENSITIVITY  
TRIACS.

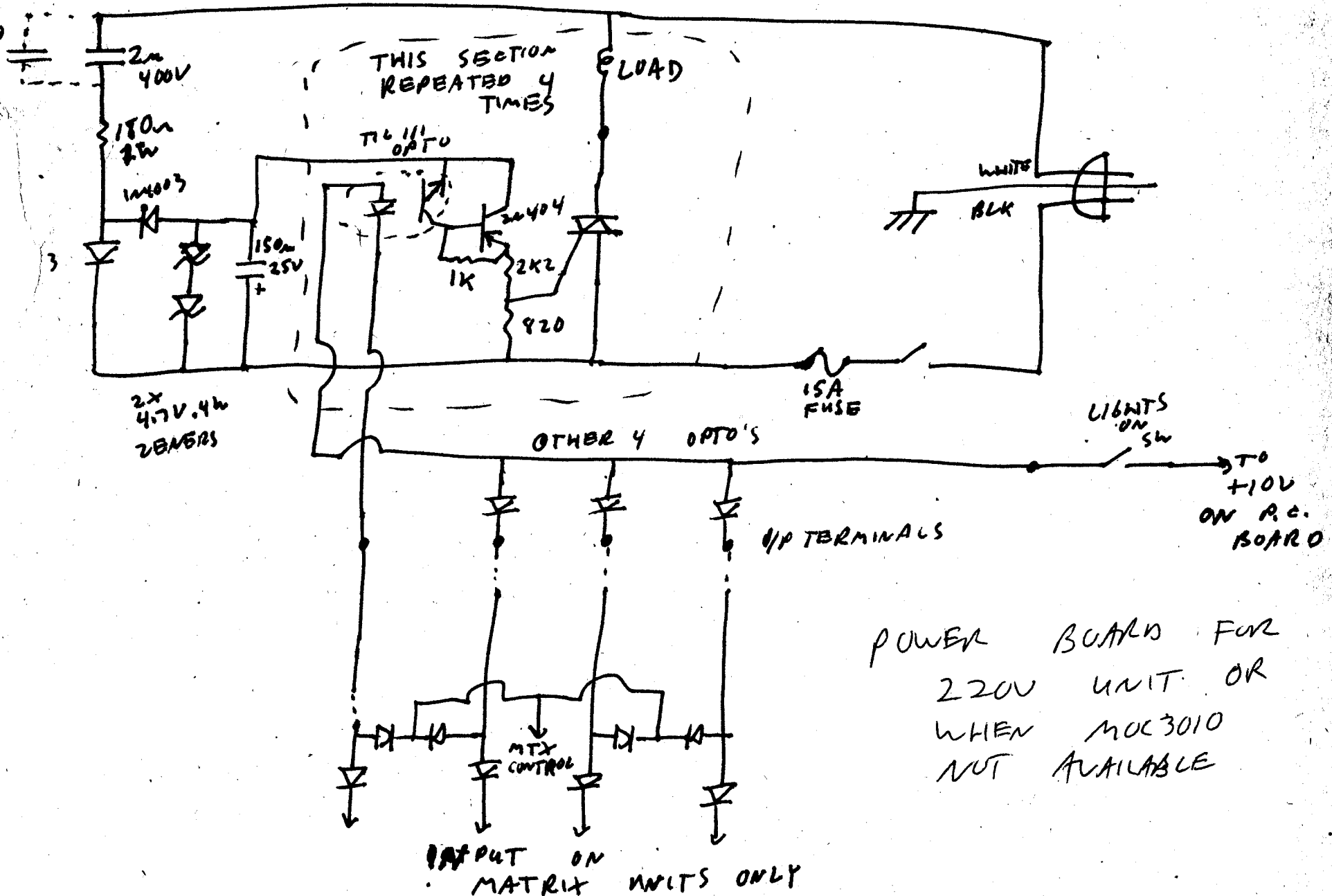

POWER BOARD FOR  
220V UNIT OR  
WHEN MOC3010  
NOT AVAILABLE

R2 F

PULSE GEN Ckt FOR FLUORESCENT LAMPS

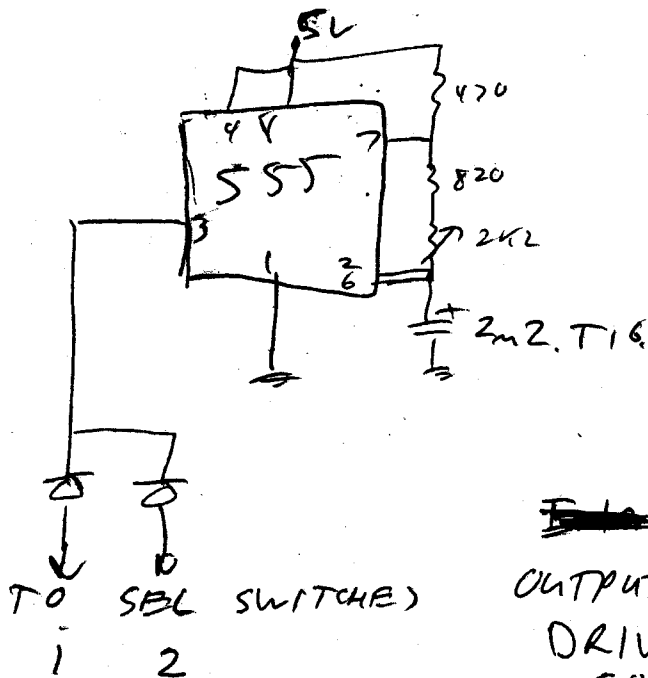

APPROX FREQUENCY  
= 178 Hz

~~FILE~~  
OUTPUT PULSER TO  
DRIVE IGNITION  
COILS TO DRIVE  
FLUORESCENT LAMPS

OUTPUT ckt

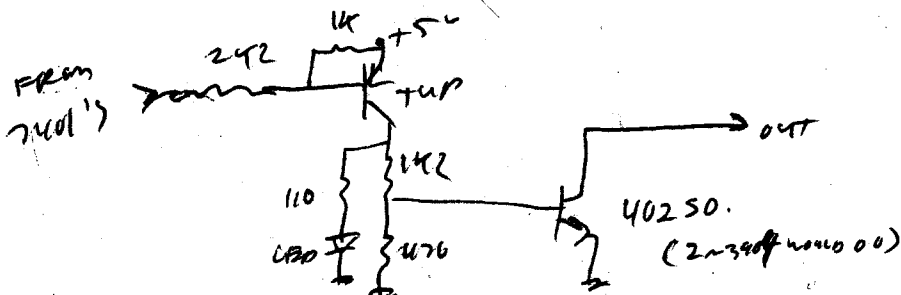

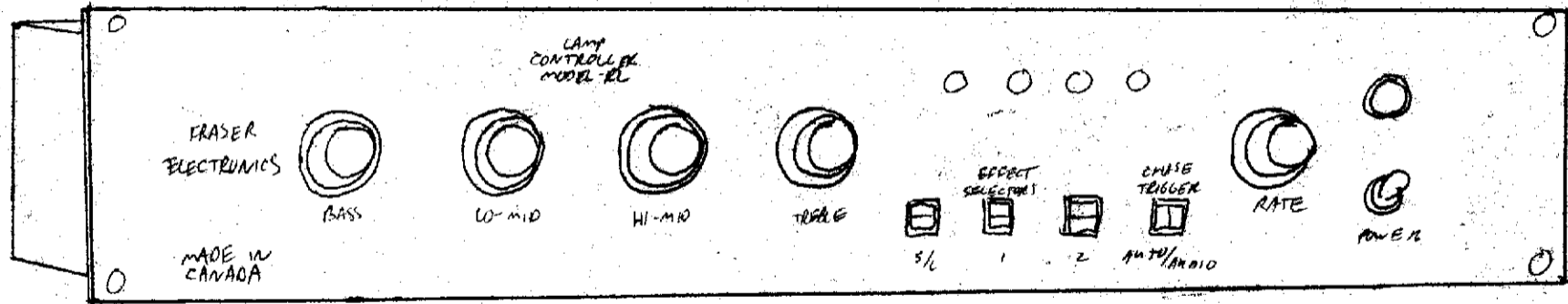

FRASER  
ELECTRONICS



BASS



LO-MID



HI-MID



TREBLE

LAMP  
CONTROLLER  
MODEL-R2



S/L

EFFECT  
SELECTORS



1



2

CHASE  
TRIGGER



AUTO/AUDIO



RATE



POWER

MADE IN  
CANADA





FRASER  
ELECTRONICS

BASS

LO-MID

HI-MID

TREBLE

S/L

1

2

AUTO/AUDIO

RATE

POWER

MADE IN  
CANADA

LAMP  
CONTROLLER  
MODEL-R2

Klondike Days Entertainment  
July 14-26

**'SUMPLACELSE CABARET'**

Canada's All New

**MALTON & HAMILTON SHOW**

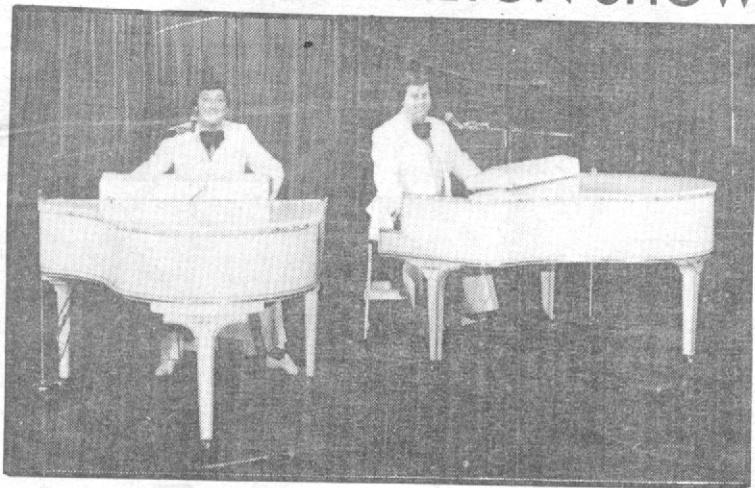

*Come Early and Avoid Disappointment*

*Early R2 buyer*