

Build this X-Y plotter for your PC and plot curves, draw circuit-board patterns, create artistic designs, and even do lettering!

JIM BROWN

HAVE YOU EVER WANTED AN X-Y plotter for your personal computer but been discouraged by the high price of a factory-made unit? Here is your chance to build your own plotter, learn the fundamentals of computer-based plotters, and save money.

This plotter can draw lines, curves, complex patterns, and alphanumeric characters with a pen on paper. It can also plot mathematical functions and even draw printed-circuit board foil patterns. If a cutter is installed in the tool holder in place of the pen, the plotter can cut adhesive-backed sheet vinyl to form uniform letters, numbers, or patterns.

The simplified diagram of the plotter mechanism shown in Fig. 1 shows how it translates the rotary motions of two stepper motor shafts into linear motions under computer control.

The plotter assembly consists of X and Y stepper motors and sliding X and Y motion translation arms mounted on the rigid wooden board that is the plotting surface.

The X motor moves the tool left and right on the board along the X axis, and the Y motor moves the tool up or down on the board along the Y-axis. A sliding component that consists of two bearings and a tool holder resolves the simultaneous motions of the X and Y axes and moves the pen or cutting tool in two degrees of freedom to trace the resulting pattern.

A third or Z-axis stepper motor shown in the more detailed drawing, Fig. 2, lifts the tool holder from the plotting surface under computer control. A crank arm on the motor

shaft hauls up on a cord attached to a "drawbridge" mechanism that lifts a hinged arm supporting the X and Y mechanical elements. Z-axis motion occurs when the motor shaft is stepped through a partial revolution.

This simple motion-translation mechanism is suitable only for light-duty plotting or cutting. It avoids expensive gears, drive chains or lead screws. As can be seen in Fig. 2, the mechanism includes tee-shaped X-axis and Y-axis arms or frames. Each frame consists of a base rod with a translation arm rigidly fastened perpendicular to it. Each base rod is supported at both ends by a combined standoff and sleeve bearing.

The sleeve bearings permit the base members to move only in one degree of freedom—parallel to the X or Y axes. As a re-

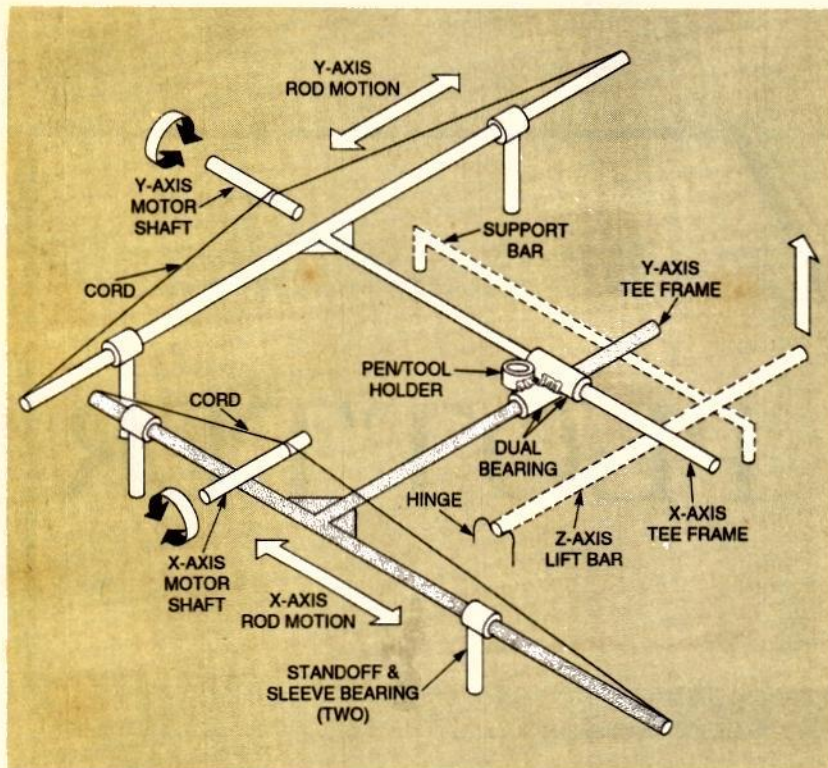

FIG. 1—CONCEPT OF X-Y PLOTTER. A pen in the holder coupled to two overlapping X and Y tee frames is driven in two degrees of freedom. The holder resolves the simultaneous winching actions of the X and Y stepper motors.

sult, the perpendicular X-axis and Y-axis motion translation arms follow the motions of the base members.

The base rods for both the X and Y axes are moved in their respective directions by cord wrapped around the stepper motor shafts and terminated at the ends of the base members. In effect, the shafts "winch" each tee frame back and forth over precise linear distances under computer control.

The overlapping translation arms on each tee frame are constrained by a part consisting of two sleeve bearings with an attached tool holder. The two sleeve bearings are joined, one over the other, with their axes 90° apart and the tool holder is fastened at right angles to both bearings.

Precise construction details have been deliberately omitted from these drawings to give the reader the opportunity to experiment and build an assembly that is within his or her capabilities. It is important that all of the mechanical parts be as light and strong as possible,

and that all bearings permit the supported parts to move freely.

Stepper motors

A stepper motor is classified as a DC motor, but it is actually an AC motor driven by a train of pulses. The rotors of these motors move or are indexed through a carefully controlled fraction of a revolution each time they receive an input step pulse. This permits shaft movement to be controlled precisely, which in turn permits precise and repeatable pen or cutting tool movement.

Electronically counted input pulses provide this controlled motion without the need for an error correcting closed-loop feedback circuit. The shafts of the light-duty stepper motors selected for this project will turn through a complete revolution with the application of either 50 or 100 pulses. Each pulse to the 50-pulse motor moves the shaft in 7.5° increments. However, each pulse to a 100-pulse motor moves the shaft in 3.6° increments, providing much greater precision.

Buying the motors

Suitable stepper motors for this project are available from many *Electronics Now* advertisers. The three stepping motors for the author's prototype plotter were salvaged from obsolete floppy-disk drives. The 100 step per revolution (3.6°) motors draw 0.16 amperes when driven from the 12-volt supply available within a personal computer. They have an impedance of 75 ohms and five external wires.

The drives were obtained from All Electronics, P.O. Box 567, Van Nuys, CA91408-0567, Phone 800-826-5432. It was necessary to disassemble the salvaged disk drives to obtain the motors.

However, the same source offers 12-volt, 50-step per revolution (7.5°) stepper motors which do not have to be removed from a salvaged drive, but at a slightly higher price. They are six-wire, 35-ohm motors. If these six-wire models are purchased, tie the two common wires (typically black and white) together to form a common power connection.

The first stepper motors in 360-Kbyte floppy-disk drives had five wires; one is the ground or common wire and four are pulse wires. The functions of the pulse wires can be verified with a 9-volt battery with leads attached. Connect the negative lead to the black wire, and in a 1, 2, 3, 4 sequence, touch each of the other four wire ends with the wire from the battery's positive terminal.

Whenever you connect the positive lead to one of the four wires, the shaft of the stepper motor will move incrementally. These stepping motors step 3.6° with each input pulse. However, some motors must be energized in a 1, 3, 2, 4 order. To reverse the shaft direction, the motor is stepped in reverse order: 4, 3, 2, 1 or 4, 2, 3, 1, depending on how the motor is wound.

Building the plotter

The recommended size for the square plotting board based on the torque limitations of the stepper motors is about one foot

on a side. The prototype board was made from 1/2-inch thick

PARTS LIST

Semiconductors

IC1—8255A-5 programmable peripheral interface, Intel or equiv.

IC2—74LS138 1 of 8 line decoder/demultiplexer, Motorola or equiv.

IC3, IC4—ULN2803 high-voltage, high-current Darlington array, Allegro Microsystems or equivalent

Other Components

MOT1, 2, and 3—stepper motor, 100 pulse per revolution, 3.6" (See text)

Miscellaneous: IBM PC/XT 8-bit plug-in prototype board (see text), No. 22 AWG insulated wire in a variety of colors, plywood (1 ft x 1ft, 1/2-inch thick), appropriate materials for constructing stand-offs, bearings and moving tee arms and other mechanical parts, 15-pin connector, heavy-duty nylon cord, plug and socket, epoxy, solder.

plywood, but any rigid, smooth base would be suitable.

Cut the X-Y plotting board to that size, and sand its edges and corners to prevent splintering. Draw the "footprints" of the three stepper motors in the positions and with the orientations shown in Fig. 2. This will permit you to estimate the size of the available plotting area. (An area of 8 1/2 x 8 1/2 inches should be satisfactory.)

Fasten both the X and Y-axis stepper motors at the edges of plotting board at their mid points as shown in Fig. 2. One simple way to mount the motors securely on the plotting board is as follows:

Form two inverted "U"-shaped sheet-metal straps with bent tabs at each end. Drill holes in the tabs to accept wood screws, and fasten the motors to the boards with their shafts parallel to the board, as shown in Fig. 2.

Form an "L"-shaped crank

arm from a piece of thin-walled copper or brass tubing about 3 inches long. Drill a hole in one end for fastening the Z-axis "drawbridge" cord. Fasten the arm to the shaft of the Z-axis motor by soldering or epoxy. Drill holes in the plotting board to align with holes in the mounting bracket of the Z-axis motor so that it can be mounted in a vertical position. With suitable screws, fasten the motor, as shown in Fig. 2, with the crank arm of the motor directed as shown.

With the X, Y and Z motors mounted, determine the dimensions of the X and Y tee frames or arms. The base rods should be approximately twice the length of the available plotting surface. The tee frames in the author's prototype were made from hardwood dowels that were hot-glued perpendicular to each other. However, thin-walled brass tubing that can be soft-soldered will work just as

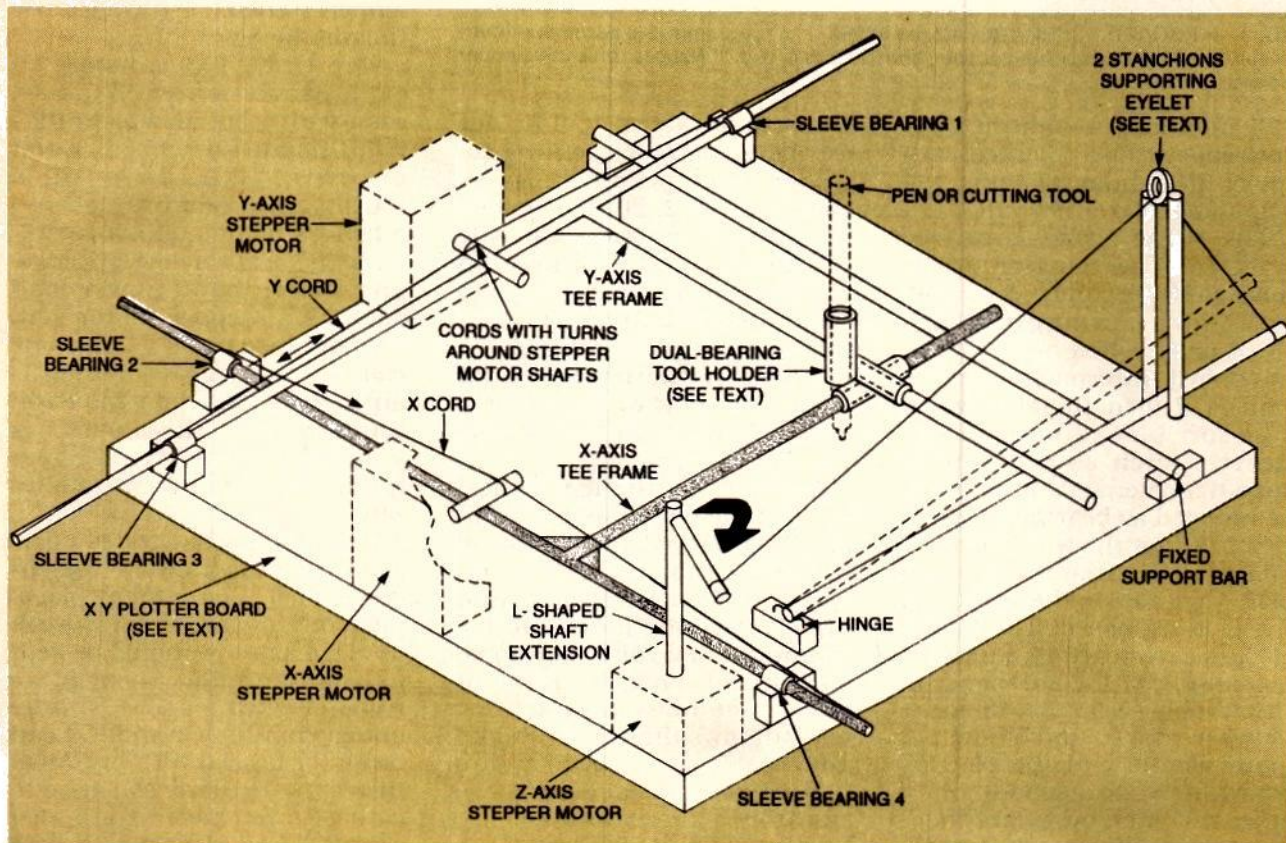

FIG. 2—CONSTRUCTION DETAILS OF X-Y PLOTTER. The tee frames can be made from different kinds of light, strong materials, but they must be slide easily in their sleeve-bearing supports without binding. The vertically mounted Z-axis motor lifts the X and Y arms and tool holder when a crank arm pulls on the cord attached to the side rail.

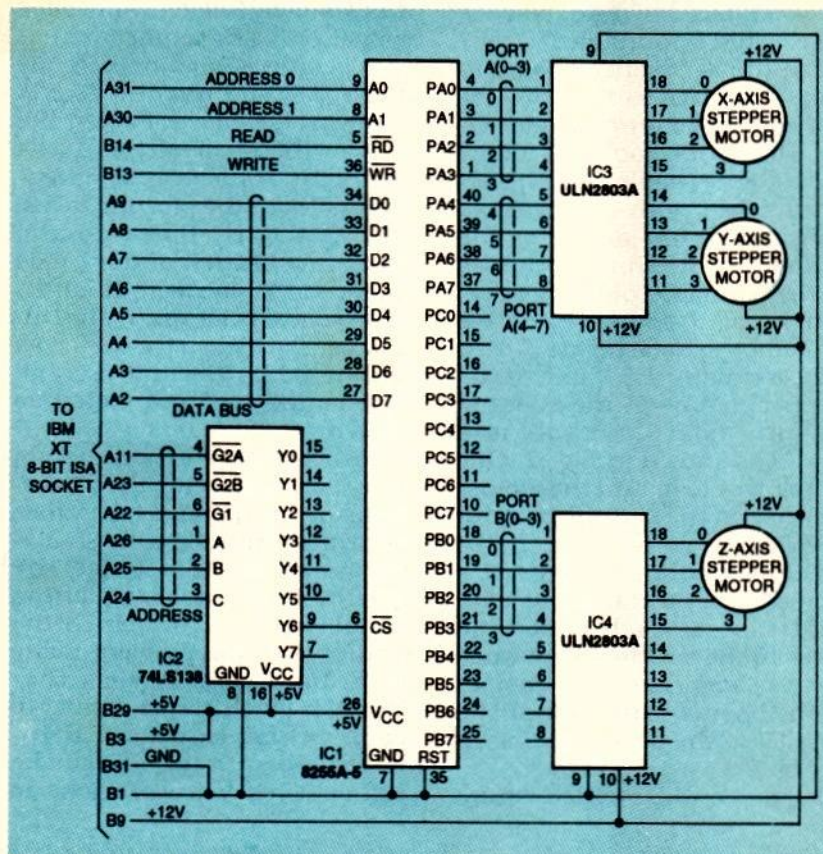

FIG. 3—I/O BOARD SCHEMATIC: IC1, an 8255A, is a programmable peripheral interface, IC2, a 74LS138 is a line decoder, and IC3 and 4, two ULN2803s drive the stepper motors.

well. Another possibility is glass fiber-epoxy rods cemented with epoxy. Triangular webbing will help to reinforce the joint.

The sleeve bearings can be made from sections of plastic tubing. These can be cemented to wooden stand-off blocks glued or attached by screws to the board. Alternatively, holes can be drilled in taller wood standoff blocks and plastic sleeves, such as sections of large-diameter soda straws can be inserted as bearings.

Notice that the tee frames are mounted so that they lie in planes parallel to the surface of the plotting board. The height of the sleeve bearings above the plotting board will depend on the available clearance distance between the X and Y stepper motor shafts and the plotting board. A vertical separation of at least 1/4-inch between frames is recommended to prevent mechanical interference throughout the frame's complete range of motion.

The part with the two bear-

ings and attached tool holder can be made by cementing together three plastic tubes as shown in Fig. 2. The tool holder, which could be made of plastic or aluminum, should have an inside diameter large enough to accommodate a thin, light, felt-tipped pen. A set screw in the sidewall of the holder could clamp the pen or tool, but a folded leaf spring or wedge would also work.

Assemble all the mechanical parts of the plotter as shown in Fig. 2, and attach and secure all the cords that move their respective mechanical elements. Then manually move the tee frames to their full extent to be sure there is no mechanical interference between parts or bearing misalignment. Make any repairs necessary to assure that all mechanical parts move smoothly without binding.

Motor drive board.

The four integrated circuits in the motor drive circuit are readily available from many

electronics stores and the mail-order electronics distributors advertised in this magazine. All are alternate-sourced by at least two semiconductor manufacturers. A suitable 8-bit IBM PC-XT plug-in prototyping board for use as the circuit board is also available as a stock item from many of the same sources.

The four integrated circuits on the circuit board are a 8255A-5 programmable peripheral interface or equivalent (8255A, 8255-5, or 82C55-5) (IC1), a 74LS138 1-of-8 decoder/demultiplexer for address decoding or CMOS equivalent (IC2), and two ULN2803 high-voltage, high-current Darlington arrays (IC3 and IC4).

The 8255A has 24 output pins but only twelve are used in this project—four for each stepper motor. All eight channels of one ULN2803 (IC1) are used to drive the coils of the X-axis and Y-axis stepper motors. Each coil of the stepper sinks 500 milliamperes when it is turned on by the digital logic.

The ULN2803 consists of eight parallel driver channels, each with load current ratings to 500 milliamperes. Each channel consists of a Darlington buffer/inverter and a flyback diode suitable for interfacing between low-level logic and a peripheral power load such as a stepper motor coil. The software turns on only one coil at a time. The ULN2803 is an inverter, so when the 8255 line goes low, the stepper is switched on; when the line goes high, the coil current falls to zero.

Figure 4 is a suggested parts placement diagram for the circuit board. Component placement on this card is not critical, but lead lengths should be kept to a minimum. Sockets are recommended for all ICs. Integrated circuits IC1 and IC2 can be either bipolar TTL or CMOS that is particularly sensitive to damage from electrostatic discharge (ESD). However, observe proper handling precautions when handling either kind.

Notice that the components are located on the side of the

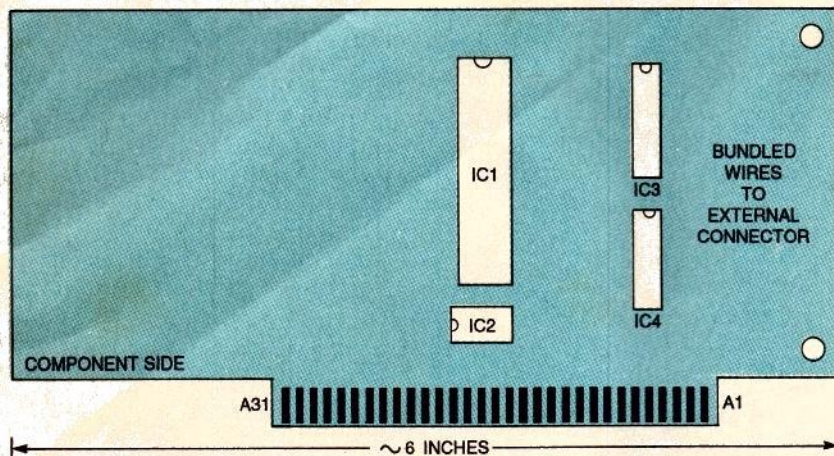

FIG. 4—CIRCUIT BOARD IS AN IBM-XT compatible 8-bit prototype plug-in card. Component placement is not critical, but wiring should be kept as short as possible. The component side is shown.

board with the A1 to A31 terminal "fingers." The board is inserted in the computer card-edge connector with the drilled holes on the right side of the board, as shown in Fig. 4, closest to the back of the computer. The B1 to B31 terminations are on the solder side of the board.

The wires from output pins 11 to 18 on IC3 and 15 to 18 on IC4 connect the drivers to the three stepper motors as shown in the schematic, Fig. 3. An additional wire connects the 12-volt source from B9 to the common +12-volt wires on the stepper motors. All wires should be cut at least 12 inches long so they can be soldered to the IC pins and +12-volt terminal and clamped securely to the circuit board.

Drill a 1/4-inch hole in the "L" bracket that is bolted to the end of the circuit board for covering the slot in the computer card cage. Insert a protective rubber grommet in the hole, bundle the 12 drive wires and +12-volt wire, and insert them through the grommet. It is recommended that all 13 wires be terminated with a circular connector socket having at least 15 contacts.

The five wires (four coil wires and +12-volt wire) from each motor can be cut to a length of about four feet. They should be bundled or inserted in a vinyl protective sleeve and terminated in a mating connector plug. The three +12-volt wires can be jumpered together with-

in the plug so that they mate with the +12-volt wire in the socket. This arrangement permits the X-Y plotter to be disconnected and stored conveniently when not in use.

Drive software

The software written for this plotter will give the builder ample opportunities for programming. The objective of the program is to apply pulses to the stepper motor coils so that the drive shafts respond as directed. Sample software source code is available as file PLOTTER.C on the *Electronics Now* bulletin board 516-293-2283, V.32, V.42bis).

Programming

The card can be set up for eight different beginning port addresses depending on the chip select (CS) pin from IC2 74LS138 selected:

| PIN | ADDRESS (HEX) | ADDRESS (DECIMAL) |
|-----|---------------|-------------------|
| 15 | 200 | 512 |
| 14 | 220 | 544 |
| 13 | 240 | 576 |
| 12 | 260 | 608 |
| 11 | 280 | 640 |
| 10 | 2A0 | 672 |
| 9 | 2C0 | 704 |
| 7 | 2E0 | 736 |

If you connect the CS line to pin 9, then the beginning port address will be 704 (hex 2C0). The 8255A-5 IC has four ports. Port A is at address 0, port B is at address + 1, port C is at ad-

dress + 2 and the configuration port is at address + 3. The common configuration for the port is all outputs (control word 128 (hex 80)). The 8255A-5 can be configured for inputs as well as outputs. (For example, control word 133 (hex 85) converts ports A and B to outputs and port C as inputs if sensors were used).

To make the motors step sequentially, pulse each binary line: 1, 2, 4, 8. For the high-order nibble pulse: 16, 32, 64, 128. Be sure the delay is long enough for the pulse to drive the motor through the next step. If all the circuitry is correct and the motor shaft does not rotate, the delay is probably too short.

Programming example

The first step is to send the configuration data to the integrated circuit. That can be done with the BASIC statement:

```
10 OUT 707,128
```

Next, the stepper motor is sequenced and a delay is added between each step:

```
20 FOR I=0 TO 100
30 OUT 704,1
40 FOR DELAY=0 TO 100:
  NEXT DELAY
50 OUT 704,2
60 FOR DELAY=0 TO 100:NEXT
  DELAY
70 OUT 704,4
80 FOR DELAY=0 TO 100:NEXT
  DELAY
90 OUT 704,8
100 FOR DELAY=0 TO 100:
  NEXT DELAY
110 NEXT I
```

Then turn off the motor:

```
120 OUT 704,0
```

By sequencing the motors, X lines or Y lines, or a combination of them, diagonal lines can be drawn. With additional programming, arcs and circles can be developed.

Banner program

The file posted on the *Electronics Now* BBS contains a banner program that accepts a text message for printing and plots each letter of the message. The sample program given here

ELECTRONICS NOW

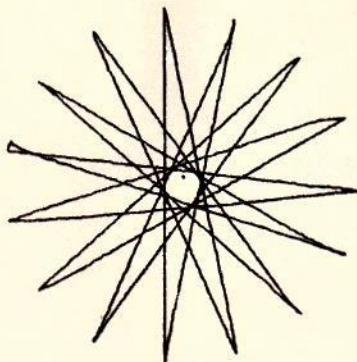
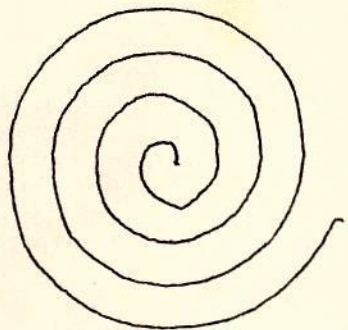

SINE WAVE

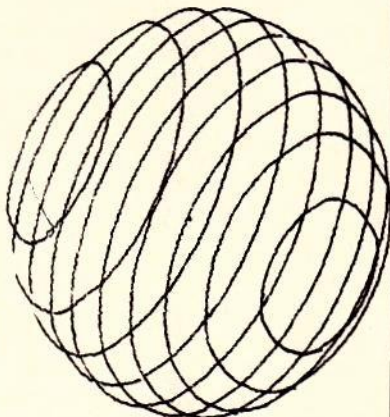
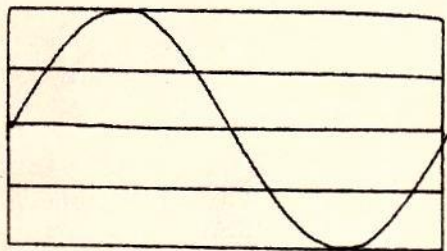

HERE ARE SEVERAL EXAMPLES OF output from the author's prototype plotter, shown below.

will help you to learn plotter programming. It defines each of the 26 capital letters. All letters are defined by 10 pulses. Each pulse step can be either be a line, a quarter arc, a pen lift and a move command. Each step is given X and Y directions to move the pen.

For example, the letter B is defined by:

1,0,60, Draw a line 60 steps up.
1,15,0, Draw a line to the right 15 steps.

2,15,-15, Draw an arc down and to the right, 15 by 15 steps.

2,-15,-15, Draw an arc down and to the left, 15 by 15 steps.

1,-15,0, Draw a line to the left 15 steps.

1,15,0, Draw a line to the right 15 steps.

2,15,-15, Draw an arc down and to the right, 15 by 15 steps.

2,-15,15, Draw an arc down to the left 15 by 15 steps.

1,-15,0, Draw a line to the left 15 steps.

3,35,0, Move to the right 35 steps for the next letter.

The main loop looks up each character in the message and moves the pen the number of steps defined for each character until all of the characters are drawn.

The line and arc subroutines listed will move the pen in the direction desired. To enlarge the characters, increase the scale factor. This will multiply the number of steps required to draw each line.

The delay subroutine allows the stepper motor to dwell long enough for the voltage to reach the value that will step the motor. *Note:* This program was developed on an IBM personal computer with an Intel 80286 microprocessor. Adjustments in delay-time might have to be made for reliable motor stepping if the programming is done on a different computer.

Other computers might speed up the plotter by decreasing the delay time until movement becomes unreliable. If this occurs, additional time can be added to increase motor reliability. With the subroutines included here and innovative programming, almost any kind of line artwork can be drawn.

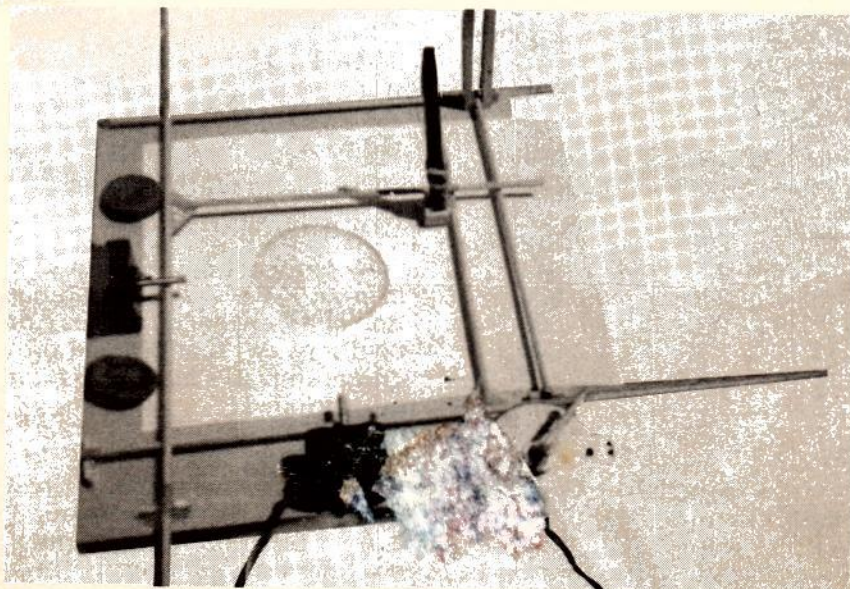

AUTHOR'S PROTOTYPE PLOTTER, although simple in construction, was able to produce impressive results.