

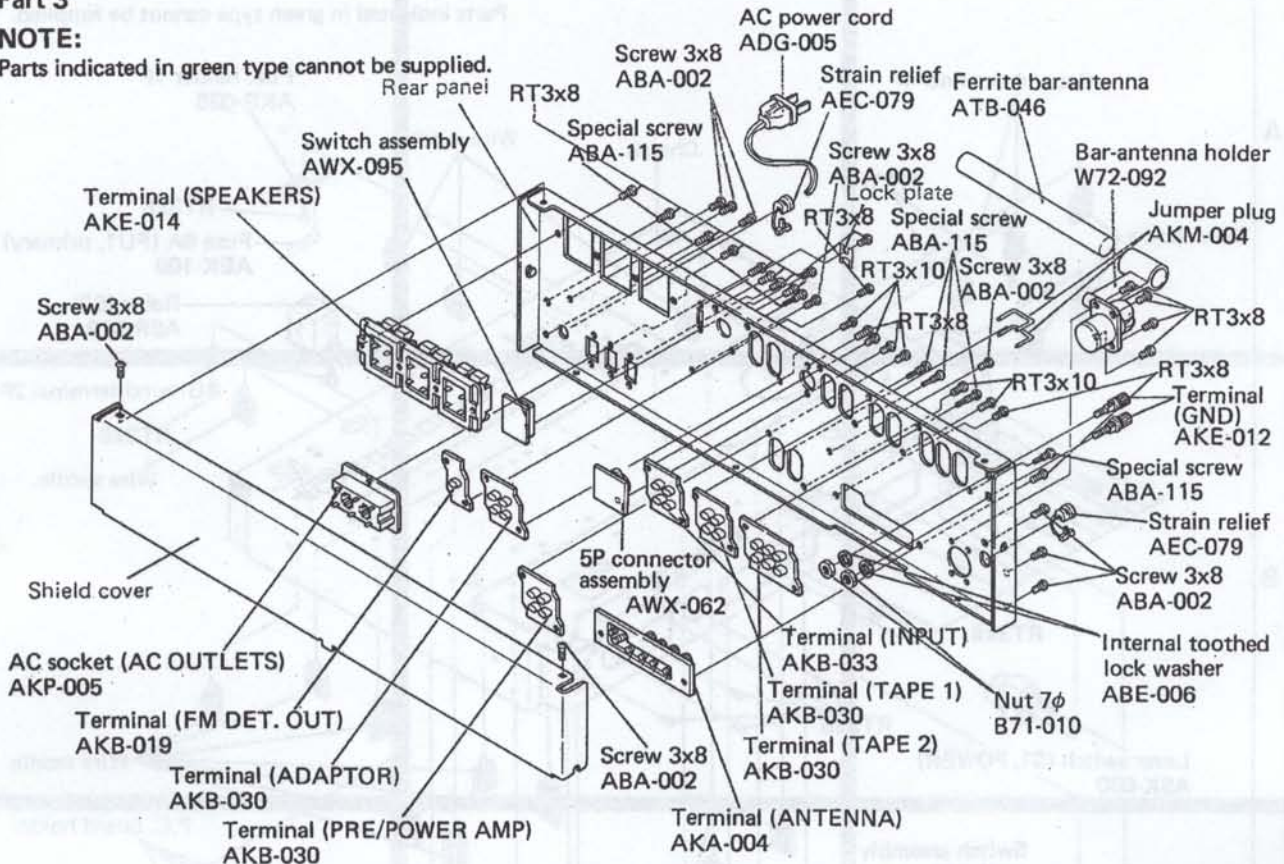

**Part 3**

**NOTE:**

Parts indicated in green type cannot be supplied.  
Rear panel



**Flat Amplifier Assembly (AWG-038)**

**Tone Amplifier Assembly (AWG-039)**

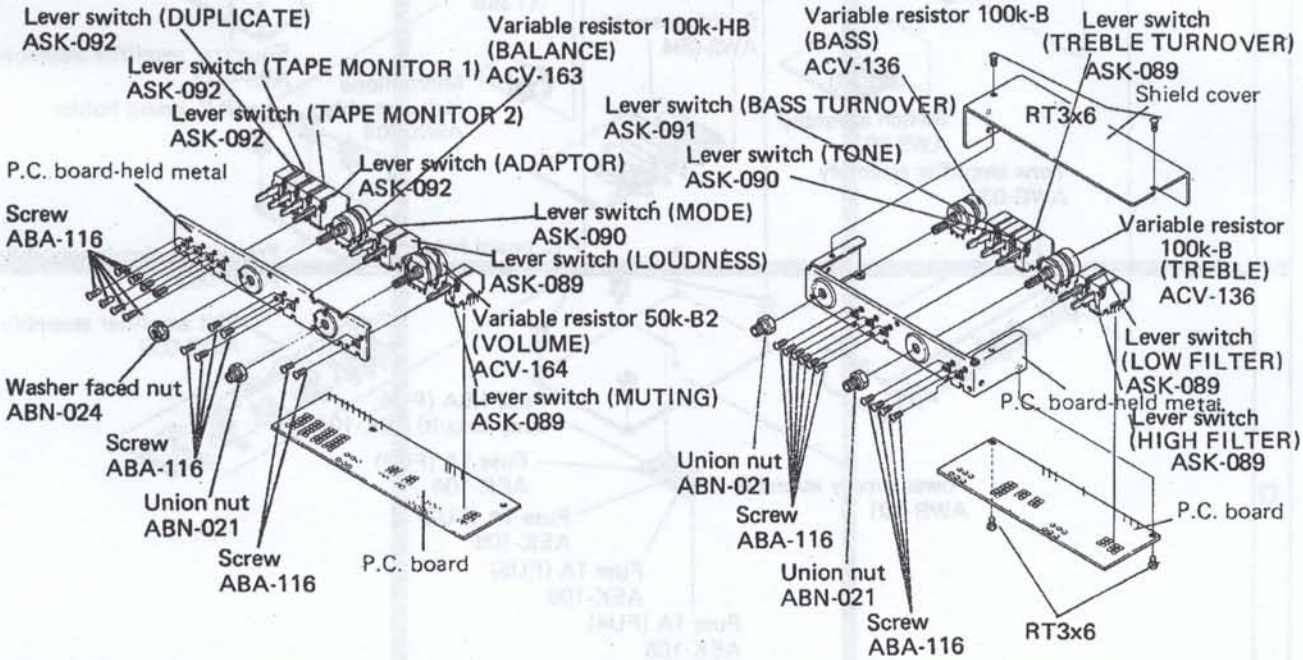



Switch Assembly (AWS-093)

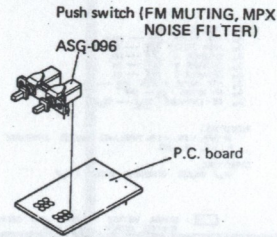

**NOTE:**  
Parts indicated in green type cannot be supplied.

Switch Assembly (AWX-095)

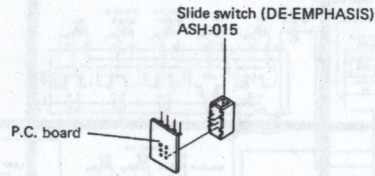

Switch Assembly (AWS-094)

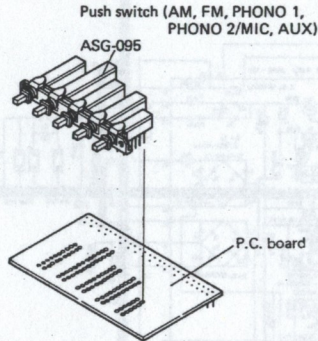

Microphone Jack Assembly (AWX-094)

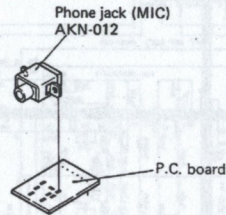

Switch Assembly (AWS-095)

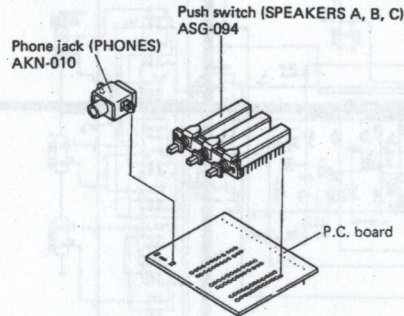

5P Connector Assembly (AWX-062)

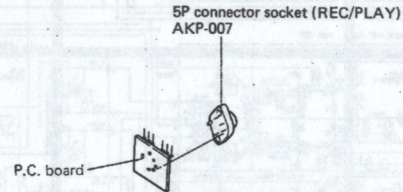

## 12. SCHEMATIC DIAGRAMS, P.C. BOARD PATTERNS AND PARTS LISTS

### 12.1 MISCELLANEOUS-PARTS

#### SEMICONDUCTORS

| Symbol | Description | Part No. |
|--------|-------------|----------|
| Q1     | Transistor  | 2SB557-R |
| Q2     | Transistor  | 2SB557-R |
| Q3     | Transistor  | 2SD427-R |
| Q4     | Transistor  | 2SD427-R |
| Q5     | Transistor  | 2SB557-R |
| Q6     | Transistor  | 2SB557-R |
| Q7     | Transistor  | 2SD427-R |
| Q8     | Transistor  | 2SD427-R |

#### LAMPS

| Symbol  | Description                     | Part No. |
|---|---------------------------------|----------|
| PL1   | Lamp assembly*                  | AEL-056  |
| PL2   | Lamp assembly*                  | AEL-056  |
| PL3   | Lamp assembly*                  | AEL-056  |
| PL4   | Lamp assembly*                  | AEL-056  |
| * Lamp assemblies (PL1-PL4) are made up of the following parts. |                                 |          |
|   | (1) Lamp (8V, 0.3A, wedge-type) | AEL-029  |
|   | (2) Lamp socket (wedge-type)    | AKK-004  |
| PL5   | Lamp with leads (8V, 50mA)      | AEL-069  |
| PL6   | Lamp with leads (8V, 50mA)      | AEL-076  |
| PL7   | Lamp with leads (8V, 50mA)      | AEL-075  |
| PL8   | Lamp with leads (8V, 50mA)      | AEL-074  |
| PL9   | Lamp with leads (8V, 50mA)      | AEL-072  |
| PL10  | Lamp with leads (8V, 50mA)      | AEL-073  |
| PL11  | Lamp with leads (8V, 50mA)      | AEL-074  |
| PL12  | Lamp with leads (8V, 50mA)      | AEL-072  |
| PL13  | Lamp with leads (8V, 50mA)      | AEL-073  |

#### FUSES

| Symbol | Description              | Part No. |
|--------|--------------------------|----------|
| FU1    | Fuse 6A (primary)        | AEK-109  |
| FU2    | Fuse 1A                  | AEK-106  |
| FU3    | Fuse 1A                  | AEK-106  |
| FU4    | Fuse 1A                  | AEK-106  |
| FU5    | Fuse 1A                  | AEK-106  |
| FU6    | Fuse 1.5A (lamp circuit) | AEK-104  |

#### SWITCHES

| Symbol | Description          | Part No. |
|--------|----------------------|----------|
| S1     | Lever switch (POWER) | ASK-080  |
| S2     | Relay                | ASR-019  |

**NOTE:**

- Capacitors: in  $\mu\text{F}$  unless otherwise noted p:pF
- Resistors: in  $\Omega$ ,  $\frac{1}{4}\text{W}$  unless otherwise noted k:k $\Omega$ , M:M $\Omega$

#### TRANSFORMERS AND COILS

| Symbol | Description         | Part No. |
|--------|---------------------|----------|
| T1     | Power transformer   | ATT-265  |
| T2     | Ferrite balun       | T22-025  |
| T3     | Ferrite bar-antenna | ATB-046  |

#### RESISTORS

| Symbol | Description                            | Part No.                 |
|--------|--|--------------------------|
| R1     | Metal oxide 2.7k 2W                    | RS2P 272J                |
| R2     | Metal oxide 2.7k 2W                    | RS2P 272J                |
| R3     | Carbon film 2.2M $\frac{1}{4}\text{W}$ | RD $\frac{1}{4}$ PS 225J |

#### CAPACITORS

| Symbol | Description                 | Part No.      |
|--------|-----------------------------|---------------|
| C1     | Electrolytic 22,000 63V     | ACH-059       |
| C2     | Electrolytic 22,000 63V     | ACH-059       |
| C3     | Ceramic 0.01 150V (DC1.4kV) | ACG-003       |
| C4     | Ceramic 0.01 150V (DC1.4kV) | ACG-003       |
| C5     | Ceramic 0.01 50V            | CKDYF 103Z 50 |
| C6     | Ceramic 0.01 50V            | CKDYF 103Z 50 |
| C7     | Ceramic 0.01 50V            | CKDYF 103Z 50 |
| C8     | Ceramic 0.01 50V            | CKDYF 103Z 50 |
| C9     | Ceramic 0.01 50V            | CKDYF 103Z 50 |
| C10    | Ceramic 0.01 50V            | CKDYF 103Z 50 |
| C11    | Ceramic 0.01 50V            | CKDYF 103Z 50 |
| C12    | Ceramic 0.01 50V            | CKDYF 103Z 50 |



Circuit Diagrams of ICs

HA1137 (FM IF IC)

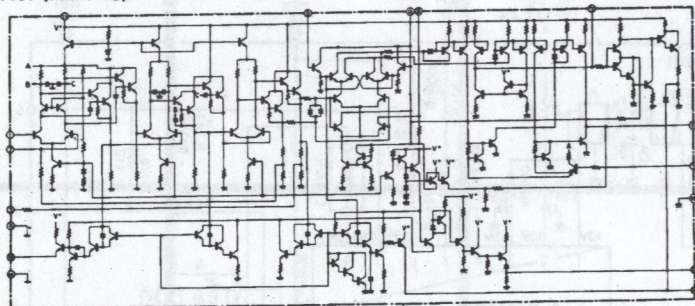

HA1138 (AM IC)

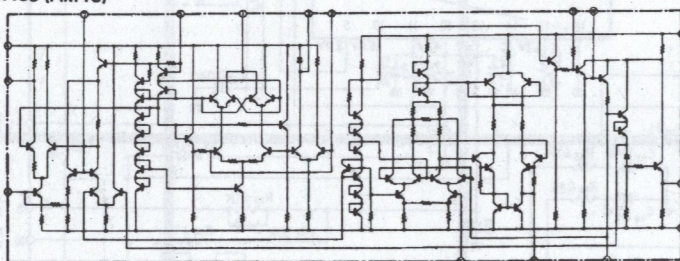

HA1196

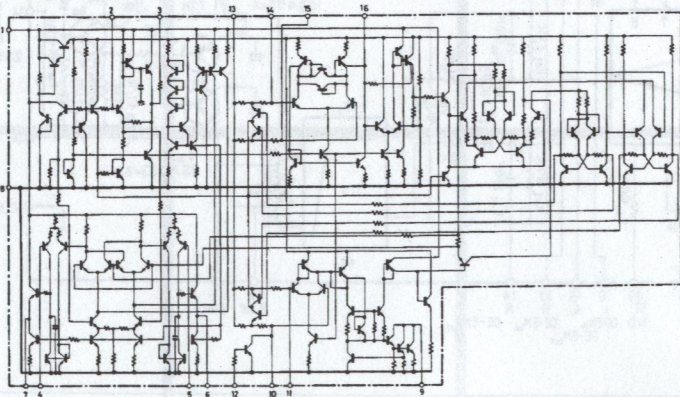

HA1201

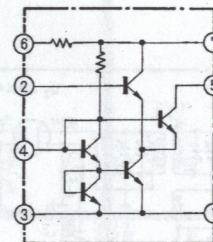

External Appearance of Transistors and ICs

2SA725  
(2SA763P)  
2SA726S  
(2SA763P)  
2SC869  
(2SC857)  
(2SC1515)  
2SC1312  
2SC1313  
(2SC1345)



2SC461  
2SC717



2SA720  
2SA733  
2SC945  
2SC945A  
2SC1318



2SB507P  
2SB536  
2SD313  
2SD313P  
2SD381

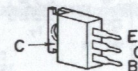

2SC1384  
2SC1885



2SK30AW



3SK45



2SA818  
(2SB527)  
2SC1628  
(2SC1451)

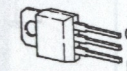

2SB557  
2SD427



HA1201



Index

HA1137  
HA1138  
HA1196



Index



12.3 TUNER ASSEMBLY (AWE-066)

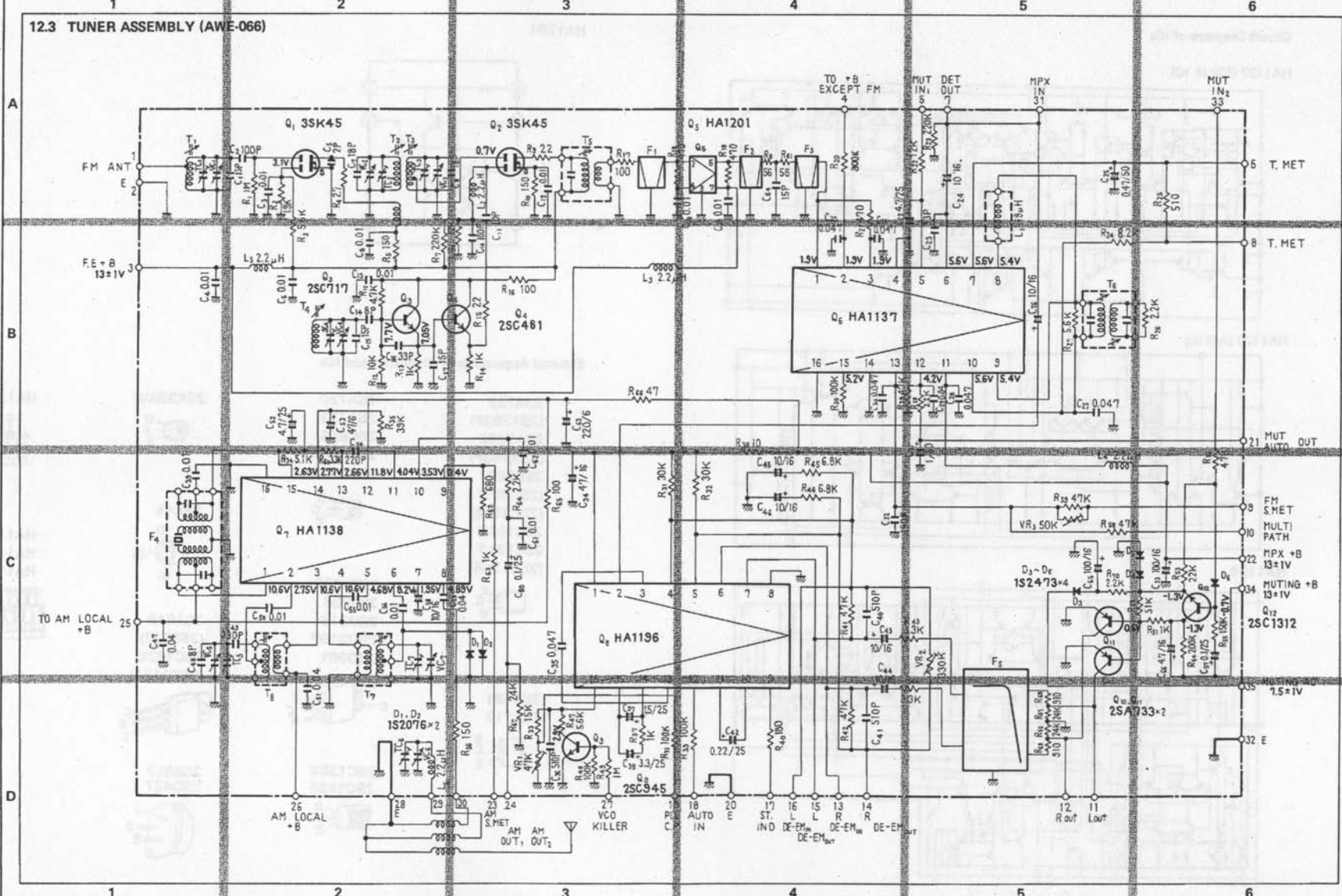



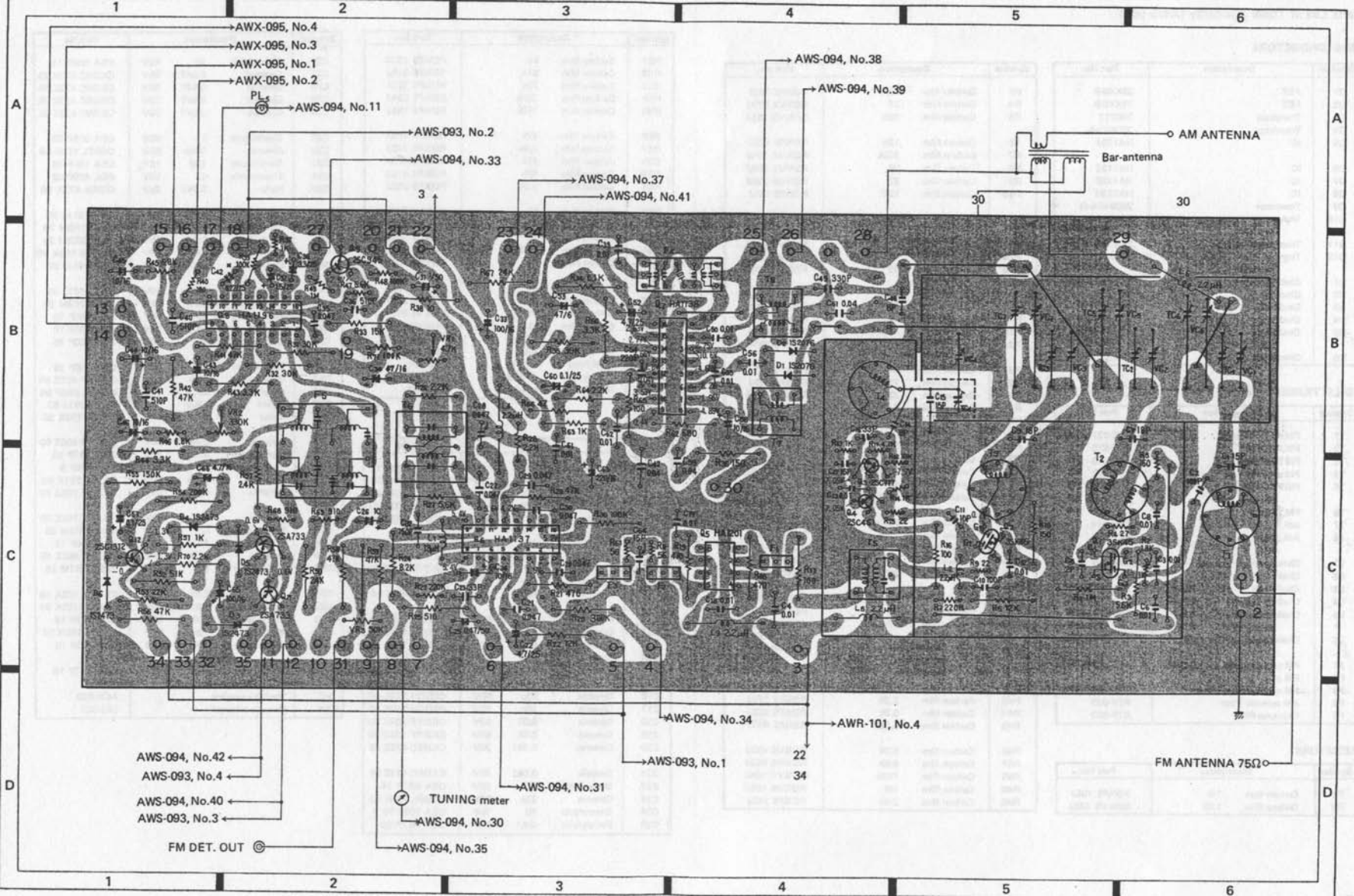



Parts List of Tuner Assembly (AWE-066)

SEMICONDUCTORS

| Symbol | Description | Part No.  |
|--------|-------------|-----------|
| Q1     | FET         | 3SK45-B   |
| Q2     | FET         | 3SK45-B   |
| Q3     | Transistor  | 2SC717    |
| Q4     | Transistor  | 2SC461-B  |
| Q5     | IC          | HA1201    |
| Q6     | IC          | HA1137    |
| Q7     | IC          | HA1138    |
| Q8     | IC          | HA1196    |
| Q9     | Transistor  | 2SC945A-Q |
| Q10    | Transistor  | 2SA733-Q  |
| Q11    | Transistor  | 2SA733-Q  |
| Q12    | Transistor  | 2SC1312-G |
| D1     | Diode       | 1S2076    |
| D2     | Diode       | 1S2076    |
| D3     | Diode       | 1S2473    |
| D4     | Diode       | 1S2473    |
| D5     | Diode       | 1S2473    |
| D6     | Diode       | 1S2473    |

COILS, TRANSFORMERS

| Symbol | Description        | Part No. |
|--------|--------------------|----------|
| T1     | FM antenna coil    | ATC-021  |
| T2     | FM RF coil         | ATC-015  |
| T3     | FM RF coil         | ATC-016  |
| T4     | FM oscillator coil | ATC-022  |
| T5     | FM IFT             | ATE-008  |
| T6     | FM IFT             | T73-035  |
| T7     | AM RF coil         | ATB-014  |
| T8     | AM oscillator coil | ATB-013  |
| L1     | Choke coil 18µH    | ATH-007  |
| L2     | Choke coil 2.2µH   | T24-028  |
| L3     | Choke coil 2.2µH   | T24-028  |
| L4     | Choke coil 2.2µH   | T24-028  |
| L5     | Choke coil 2.2µH   | T24-028  |
| L6     | Choke coil 2.2µH   | T24-028  |
| F1     | FM ceramic filter  | ATF-013  |
| F2     | FM ceramic filter  | ATF-013  |
| F3     | FM ceramic filter  | ATF-013  |
| F4     | AM ceramic filter  | ATF-027  |
| F5     | Low pass filter    | ATF-033  |

RESISTORS

| Symbol | Description      | Part No.   |
|--------|------------------|------------|
| R1     | Carbon film 1M   | RD4PS 105J |
| R2     | Carbon film 1.8k | RD4VS 182J |

| Symbol | Description      | Part No.   |
|--------|------------------|------------|
| R3     | Carbon film 5.6k | RD4PS 562J |
| R4     | Carbon film 27   | RD4VS 270J |
| R5     | Carbon film 150  | RD4VS 151J |
| R6     | Carbon film 12k  | RD4PS 123J |
| R7     | Carbon film 220k | RD4VS 224J |
| R8     | Carbon film 56   | RD4VS 560J |
| R9     | Carbon film 22   | RD4VS 220J |
| R10    | Carbon film 150  | RD4PS 151J |
| R11    | Carbon film 4.7k | RD4VS 472J |
| R12    | Carbon film 10k  | RD4VS 103J |
| R13    | Carbon film 1k   | RD4VS 102J |
| R14    | Carbon film 1k   | RD4VS 102J |
| R15    | Carbon film 22   | RD4VS 220J |
| R16    | Carbon film 100  | RD4PS 101J |
| R17    | Carbon film 100  | RD4PS 101J |
| R18    | Carbon film 470  | RD4PS 471J |
| R19    | Carbon film 470  | RD4PS 471J |
| R20    | Carbon film 300k | RD4PS 304J |
| R21    | Carbon film 470  | RD4PS 471J |
| R22    | Carbon film 12k  | RD4PS 123J |
| R23    | Carbon film 220k | RD4VS 224J |
| R24    | Carbon film 8.2k | RD4PS 822J |
| R25    | Carbon film 510  | RD4PS 511J |
| R26    | Carbon film 2.2k | RD4VS 222J |
| R27    | Carbon film 5.6k | RD4PS 562J |
| R28    | Carbon film 2.2k | RD4VS 222J |
| R29    | Carbon film 47k  | RD4PS 473J |
| R30    | Carbon film 100k | RD4PS 104J |
| R31    | Carbon film 30k  | RD4PS 303J |
| R32    | Carbon film 30k  | RD4PS 303J |
| R33    | Carbon film 15k  | RD4PS 153J |
| R34    | Carbon film 5.1k | RD4PS 512J |
| R35    | Carbon film 39k  | RD4PS 393J |
| R36    | Carbon film 150  | RD4PS 151J |
| R37    | Carbon film 1k   | RD4VS 102J |
| R38    | Carbon film 10   | RD4PS 100J |
| R39    | Carbon film 100k | RD4VS 104J |
| R40    | Carbon film 180  | RD4PS 181J |
| R41    | Carbon film 47k  | RD4PS 473J |
| R42    | Carbon film 47k  | RD4PS 473J |
| R43    | Carbon film 3.3k | RD4PS 332J |
| R44    | Carbon film 3.3k | RD4PS 332J |
| R45    | Carbon film 6.8k | RD4PS 682J |
| R46    | Carbon film 6.8k | RD4VS 682J |
| R47    | Carbon film 5.6k | RD4VS 562J |
| R48    | Carbon film 100k | RD4PS 104J |
| R49    | Carbon film 1M   | RD4VS 105J |
| R50    | Carbon film 2.4k | RD4PS 242J |

| Symbol | Description       | Part No.   |
|--------|-------------------|------------|
| R51    | Carbon film 1k    | RD4PS 102J |
| R52    | Carbon film 51k   | RD4PS 513J |
| R53    | Carbon film 22k   | RD4PS 223J |
| R54    | Carbon film 200k  | RD4PS 204J |
| R55    | Carbon film 150k  | RD4PS 154J |
| R56    | Carbon film 47k   | RD4PS 473J |
| R57    | Carbon film 2.4k  | RD4PS 242J |
| R58    | Carbon film 47k   | RD4PS 473J |
| R59    | Carbon film 47k   | RD4PS 473J |
| R60    | Carbon film 3.3k  | RD4PS 332J |
| R61    | Carbon film 56    | RD4VS 560J |
| R62    | Carbon film 680   | RD4PS 681J |
| R63    | Carbon film 1k    | RD4PS 102J |
| R64    | Carbon film 2.2k  | RD4PS 222J |
| R65    | Carbon film 100   | RD4PS 101J |
| R66    | Carbon film 47    | RD4PS 470J |
| R67    | Carbon film 24k   | RD4PS 243J |
| R68    | Carbon film 910   | RD4VS 911J |
| R69    | Carbon film 910   | RD4VS 911J |
| R70    | Carbon film 2.2k  | RD4PS 222J |
| R71    | Carbon film 100k  | RD4VS 104J |
| VR1    | Semi-fixed 4.7k-B | C92-051    |
| VR2    | Semi-fixed 330k-B | ACP-042    |
| VR3    | Semi-fixed 50k-B  | ACP-043    |

CAPACITORS

| Symbol | Description           | Part No.      |
|--------|-----------------------|---------------|
| C1     | Ceramic 15p 50V       | CCDSH 150K 50 |
| C2     | Ceramic 100p 50V      | CCDSL 101K 50 |
| C3     | Ceramic 0.01 50V      | CKDYF 103Z 50 |
| C4     | Ceramic 0.01 50V      | CKDYF 103Z 50 |
| C5     | Ceramic 2p 50V        | CCDSL 020C 50 |
| C6     | Ceramic 0.01 50V      | CKDYF 103Z 50 |
| C7     | Ceramic 18p 50V       | CCDSH 180K 50 |
| C8     | Ceramic 0.01 50V      | CKDYF 103Z 50 |
| C9     | Ceramic 18p 50V       | CCDSH 180K 50 |
| C10    | Ceramic 100p 50V      | CCDSL 101K 50 |
| C11    | Ceramic 10p 50V       | CCDSL 100F 50 |
| C12    | Ceramic 0.01 50V      | CKDYF 103Z 50 |
| C13    | Ceramic 0.01 50V      | CKDYB 103K 50 |
| C14    | Ceramic 8p 50V        | CCDLH 080F 50 |
| C15    | Ceramic 15p 50V       | CCDLH 150K 50 |
| C16    | Ceramic 33p 50V       | CCDCH 330K 50 |
| C17    | Ceramic 15p 50V       | CCDCH 150K 50 |
| C18    | Ceramic 0.01 50V      | CKDYF 103Z 50 |
| C19    | Ceramic 0.01 50V      | CKDYF 103Z 50 |
| C20    | Ceramic 0.047 25V     | CKDBC 473Z 25 |
| C21    | Ceramic 0.047 25V     | CKDBC 473Z 25 |
| C22    | Electrolytic 4.7 25V  | CEA 4R7P 25   |
| C23    | Ceramic 33p 50V       | CCDSL 330K 50 |
| C24    | Electrolytic 10 16V   | CEA 100P 16   |
| C25    | Electrolytic 0.47 50V | CEA 4R7P 50   |

| Symbol | Description           | Part No.      |
|--------|-----------------------|---------------|
| C26    | Electrolytic 10 16V   | CEA 100P 16   |
| C27    | Ceramic 0.047 25V     | CKDBC 473Z 25 |
| C28    | Ceramic 0.047 25V     | CKDBC 473Z 25 |
| C29    | Ceramic 0.047 25V     | CKDBC 473Z 25 |
| C30    | Ceramic 0.047 25V     | CKDBC 473Z 25 |
| C31    | Electrolytic 1 50V    | CEA 010P 50   |
| C32    | Ceramic 150p 50V      | CCDSL 151K 50 |
| C33    | Electrolytic 100 16V  | CEA 101P 16   |
| C34    | Electrolytic 47 16V   | CEA 470P 16   |
| C35    | Mylar 0.047 50V       | CQMA 473K 50  |
| C36    | Styrol 510p 50V       | CQSA 511J 50  |
| C37    | Electrolytic 1.5 25V  | CSZA 1R5M 25  |
| C38    | Electrolytic 3.3 25V  | CSZA 3R3M 25  |
| C39    | Ceramic 0.01 50V      | CKDYB 103K 50 |
| C40    | Styrol 510p 50V       | CQSA 511J 50  |
| C41    | Styrol 510p 50V       | CQSA 511J 50  |
| C42    | Electrolytic 0.22 25V | CSSA 2R2M 25  |
| C43    | Electrolytic 10 16V   | CEA 100P 16   |
| C44    | Electrolytic 10 16V   | CEA 100P 16   |
| C45    | Electrolytic 10 16V   | CEA 100P 16   |
| C46    | Electrolytic 10 16V   | CEA 100P 16   |
| C47    | Ceramic 0.04 50V      | CKDYF 403Z 50 |
| C48    | Ceramic 8p 50V        | CCDXL 080F 50 |
| C49    | Styrol 330p 50V       | CQSA 331J 50  |
| C50    | Mylar 0.01 50V        | CQMA 103K 50  |
| C51    | Ceramic 0.04 50V      | CKDYF 403Z 50 |
| C52    | Electrolytic 4.7 25V  | CEA 4R7P 25   |
| C53    | Electrolytic 47 6V    | CEA 470P 6    |
| C54    | Ceramic 220p 50V      | CCJSL 221K 50 |
| C55    | Ceramic 0.01 50V      | CKDYF 103Z 50 |
| C56    | Ceramic 0.01 50V      | CKDYF 103Z 50 |
| C57    | Electrolytic 0.1 25V  | CSSA 0R1M 25  |
| C58    | Electrolytic 10 16V   | CEA 100P 16   |
| C59    | Ceramic 0.04 50V      | CKDYF 403Z 50 |
| C60    | Electrolytic 0.1 25V  | CSSA 0R1M 25  |
| C61    | Ceramic 0.01 50V      | CKDYB 103K 50 |
| C62    | Ceramic 0.01 50V      | CKDYB 103K 50 |
| C63    | Electrolytic 220 16V  | CEA 221P 16   |
| C64    | Ceramic 15p 50V       | CCDSL 150K 50 |
| C65    | Electrolytic 100 16V  | CEA 101P 16   |
| C66    | Electrolytic 4.7 16V  | CEA 4R7P 16   |
| VC     | Tuning capacitor      | ACK-016       |
| TC4    | Ceramic trimmer       | C43-007       |



12.4 MICROPHONE JACK ASSEMBLY (AWX-094)

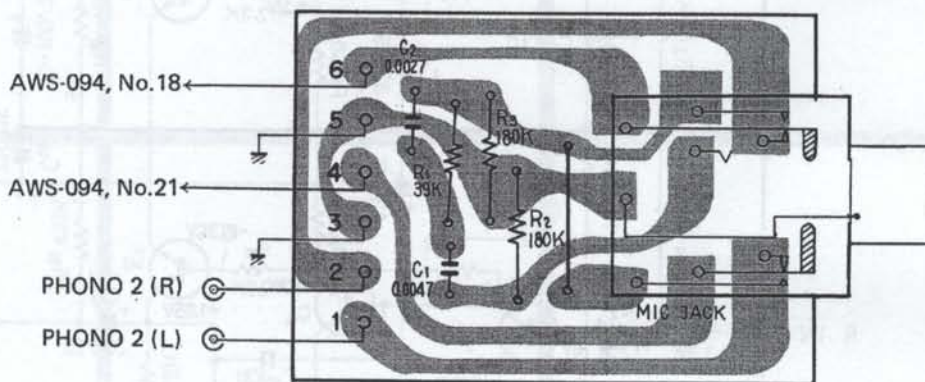
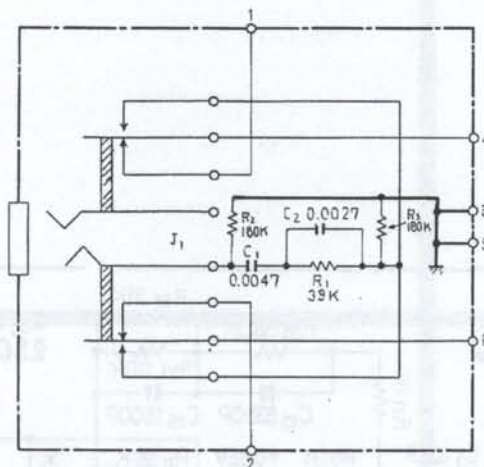

Parts List of Microphone Jack Assembly (AWX-094)

| Symbol | Description                | Part No.     |
|--------|----------------------------|--------------|
| R1     | Carbon film resistor 39k   | RD¼PS 393J   |
| R2     | Carbon film resistor 180k  | RD¼PS 184J   |
| R3     | Carbon film resistor 180k  | RD¼PS 184J   |
| C1     | Mylar capacitor 0.0047 50V | CQMA 472K 50 |
| C2     | Mylar capacitor 0.0027 50V | CQMA 272K 50 |
| J1     | Jack (MIC)                 | AKN-012      |



12.5 EQUALIZER AMPLIFIER ASSEMBLY (AWF-011)

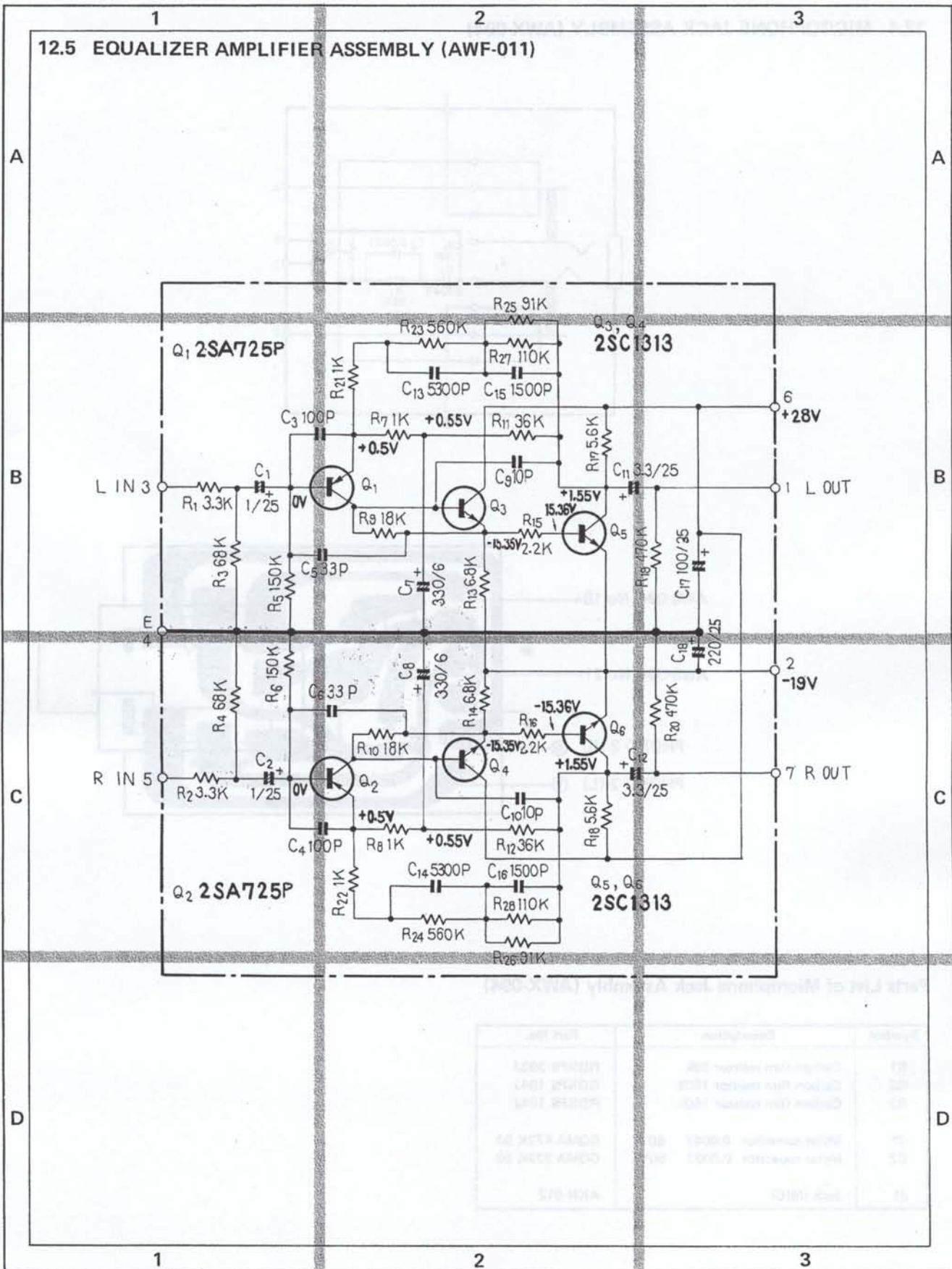

THE LIST OF COMPONENTS TAKEN FROM THE LIST OF MATERIALS (L.M.)

| Part No. | Description | Quantity |
|----------|-------------|----------|
| 12.5-1   | 2SA725P     | 2        |
| 12.5-2   | 2SC1313     | 2        |
| 12.5-3   | RESISTOR    | 28       |
| 12.5-4   | CAPACITOR   | 18       |



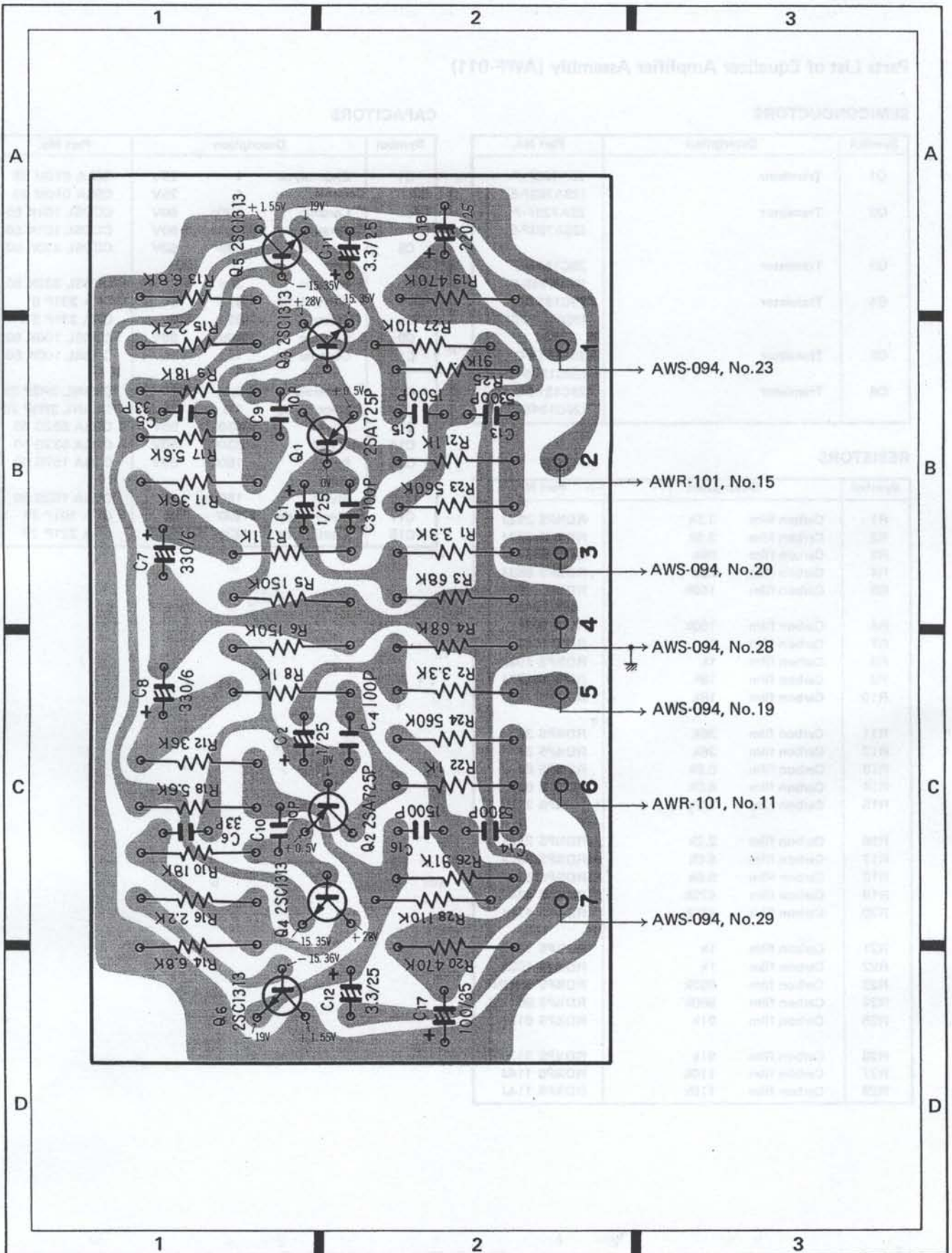



## Parts List of Equalizer Amplifier Assembly (AWF-011)

### SEMICONDUCTORS

| Symbol | Description | Part No.                 |
|--------|-------------|--------------------------|
| Q1     | Transistor  | 2SA725P-F<br>(2SA763P-5) |
| Q2     | Transistor  | 2SA725P-F<br>(2SA763P-5) |
| Q3     | Transistor  | 2SC1313-G<br>(2SC1345-E) |
| Q4     | Transistor  | 2SC1313-G<br>(2SC1345-E) |
| Q5     | Transistor  | 2SC1313-G<br>(2SC1345-E) |
| Q6     | Transistor  | 2SC1313-G<br>(2SC1345-E) |

### CAPACITORS

| Symbol | Description          | Part No.      |
|--------|----------------------|---------------|
| C1     | Electrolytic 1 25V   | CSSA 010M 25  |
| C2     | Electrolytic 1 25V   | CSSA 010M 25  |
| C3     | Ceramic 100p 50V     | CCDSL 101K 50 |
| C4     | Ceramic 100p 50V     | CCDSL 101K 50 |
| C5     | Ceramic 33p 50V      | CCDSL 330K 50 |
| C6     | Ceramic 33p 50V      | CCDSL 330K 50 |
| C7     | Electrolytic 330 6V  | CEA 331P 6    |
| C8     | Electrolytic 330 6V  | CEA 331P 6    |
| C9     | Ceramic 10p 50V      | CCDSL 100K 50 |
| C10    | Ceramic 10p 50V      | CCDSL 100K 50 |
| C11    | Electrolytic 3.3 25V | CEANL 3R3P 25 |
| C12    | Electrolytic 3.3 25V | CEANL 3R3P 25 |
| C13    | Styrol 5300p 50V     | CQSA 532G 50  |
| C14    | Styrol 5300p 50V     | CQSA 532G 50  |
| C15    | Styrol 1500p 50V     | CQSA 152G 50  |
| C16    | Styrol 1500p 50V     | CQSA 152G 50  |
| C17    | Electrolytic 100 35V | CEA 101P 35   |
| C18    | Electrolytic 220 25V | CEA 221P 25   |

### RESISTORS

| Symbol | Description      | Part No.     |
|--------|------------------|--------------|
| R1     | Carbon film 3.3k | RD%PS 332J   |
| R2     | Carbon film 3.3k | RD%PS 332J   |
| R3     | Carbon film 68k  | RD%PS 683J   |
| R4     | Carbon film 68k  | RD%PS 683J   |
| R5     | Carbon film 150k | RD%PS 154J   |
| R6     | Carbon film 150k | RD%PS 154J   |
| R7     | Carbon film 1k   | RD%PS 102J   |
| R8     | Carbon film 1k   | RD%PS 102J   |
| R9     | Carbon film 18k  | RD%PS 183J   |
| R10    | Carbon film 18k  | RD%PS 183J   |
| R11    | Carbon film 36k  | RD%PS 363J   |
| R12    | Carbon film 36k  | RD%PS 363J   |
| R13    | Carbon film 6.8k | RD%PS 682J   |
| R14    | Carbon film 6.8k | RD%PS 682J   |
| R15    | Carbon film 2.2k | RD%PS 222J   |
| R16    | Carbon film 2.2k | RD%PS 222J   |
| R17    | Carbon film 5.6k | RD%PS 562J   |
| R18    | Carbon film 5.6k | RD%PS 562J   |
| R19    | Carbon film 470k | RD%PS 474J   |
| R20    | Carbon film 470k | RD%PS 474J   |
| R21    | Carbon film 1k   | RD%PS 102J   |
| R22    | Carbon film 1k   | RD%PS 102J   |
| R23    | Carbon film 560k | RD%PS 564JNL |
| R24    | Carbon film 560k | RD%PS 564JNL |
| R25    | Carbon film 91k  | RD%PS 913J   |
| R26    | Carbon film 91k  | RD%PS 913J   |
| R27    | Carbon film 110k | RD%PS 114J   |
| R28    | Carbon film 110k | RD%PS 114J   |



12.6 5P CONNECTOR ASSEMBLY (AWX-062)

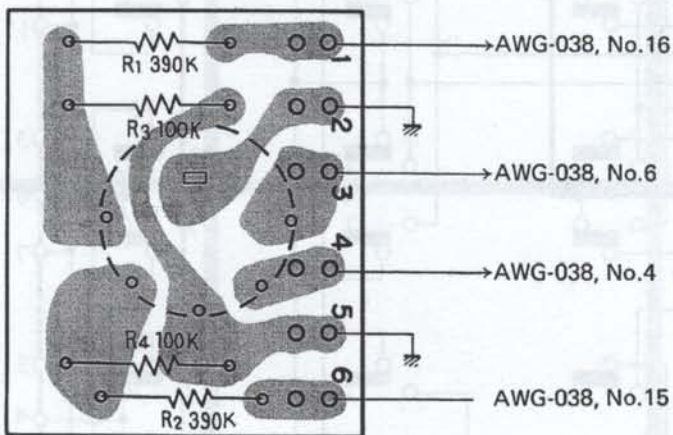
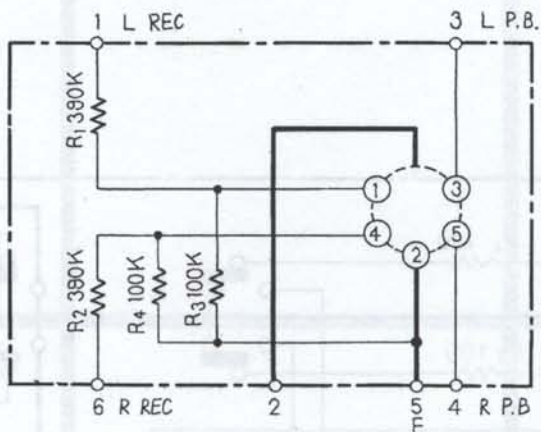

Parts List of 5P Connector Assembly (AWX-062)

| Symbol | Description                    | Part No.   |
|--------|--------------------------------|------------|
| R1     | Carbon film resistor 390k      | RD½PS 394J |
| R2     | Carbon film resistor 390k      | RD½PS 394J |
| R3     | Carbon film resistor 100k      | RD½PS 104J |
| R4     | Carbon film resistor 100k      | RD½PS 104J |
|        | Connector socket 5P (REC/PLAY) | AKP-007    |



### 12.7 SWITCH ASSEMBLY (AWS-094)

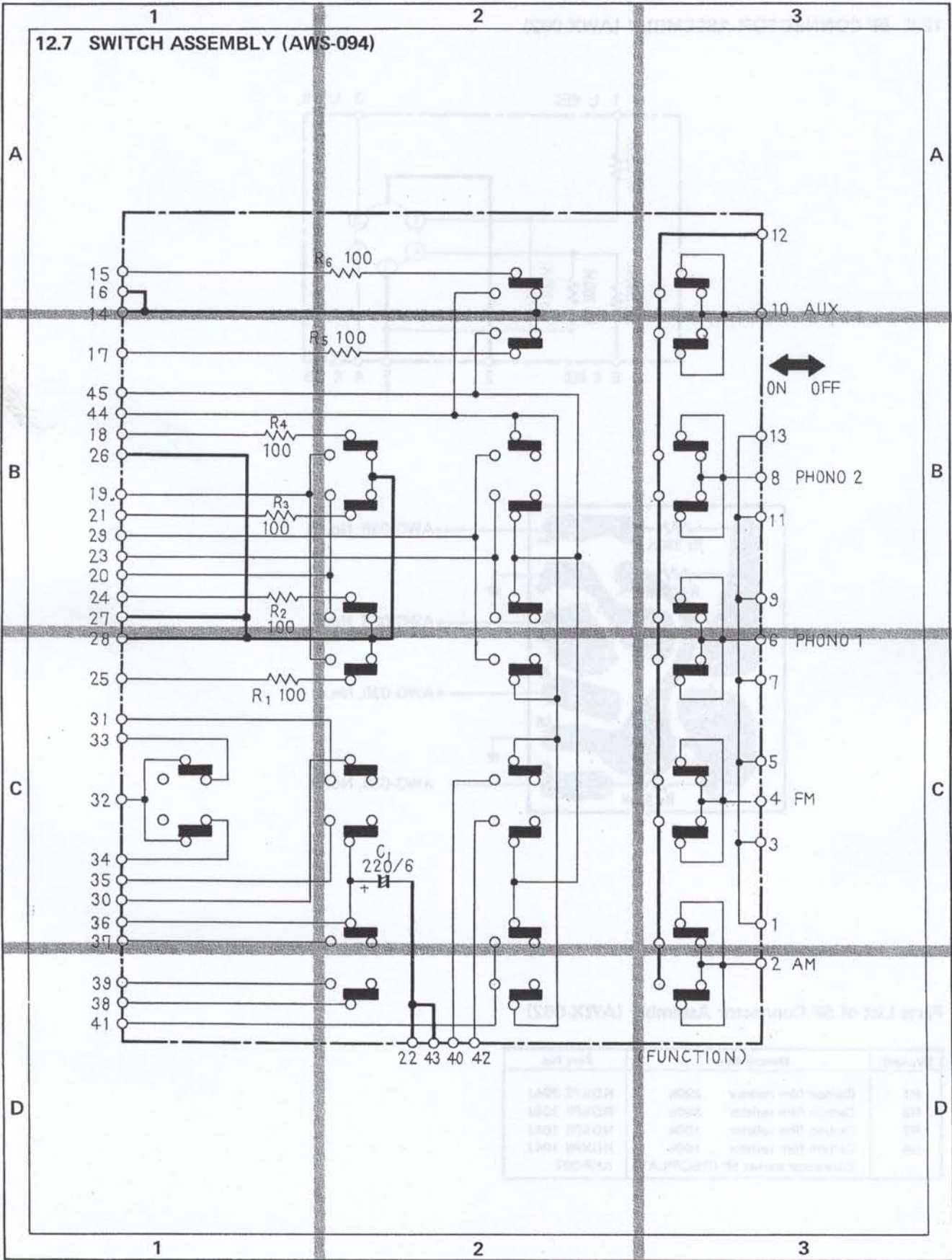



Parts List of Switch Assembly (AWS-094)

| Symbol | Description                   | Part No.   |
|--------|-------------------------------|------------|
| S1     | Push switch (FUNCTION)        | ASG-095    |
| R1     | Carbon film resistor 100      | RD¼PS 101J |
| R2     | Carbon film resistor 100      | RD¼PS 101J |
| R3     | Carbon film resistor 100      | RD¼PS 101J |
| R4     | Carbon film resistor 100      | RD¼PS 101J |
| R5     | Carbon film resistor 100      | RD¼PS 101J |
| R6     | Carbon film resistor 100      | RD¼PS 101J |
| C1     | Electrolytic capacitor 220 6V | CEA 221P 6 |

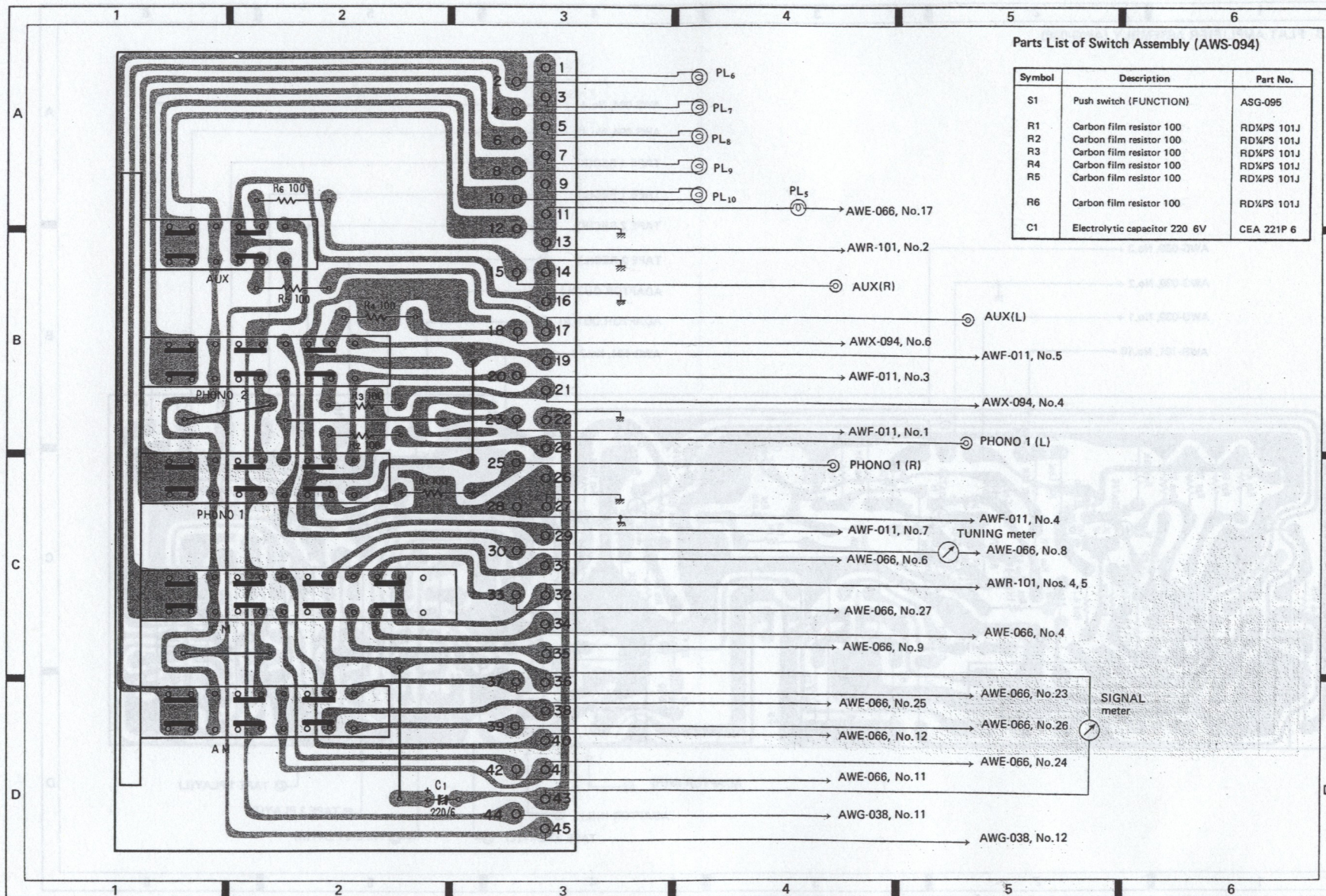



12.8 FLAT AMPLIFIER ASSEMBLY (AWG-038)

- AWG-039, No.3 ←
- AWG-039, No.2 ←
- AWG-039, No.1 ←
- AWR-101, No.10 ←

- AWS-094, No.44 ←
- AWS-094, No.45 ←
- TAPE 1 REC(R) ⊙
- TAPE 1 REC(L) ⊙
- TAPE 2 REC(R) ⊙
- TAPE 2 REC(L) ⊙
- ADAPTOR OUT(L) ⊙
- ADAPTOR OUT(R) ⊙
- AWR-101, No.7 ←

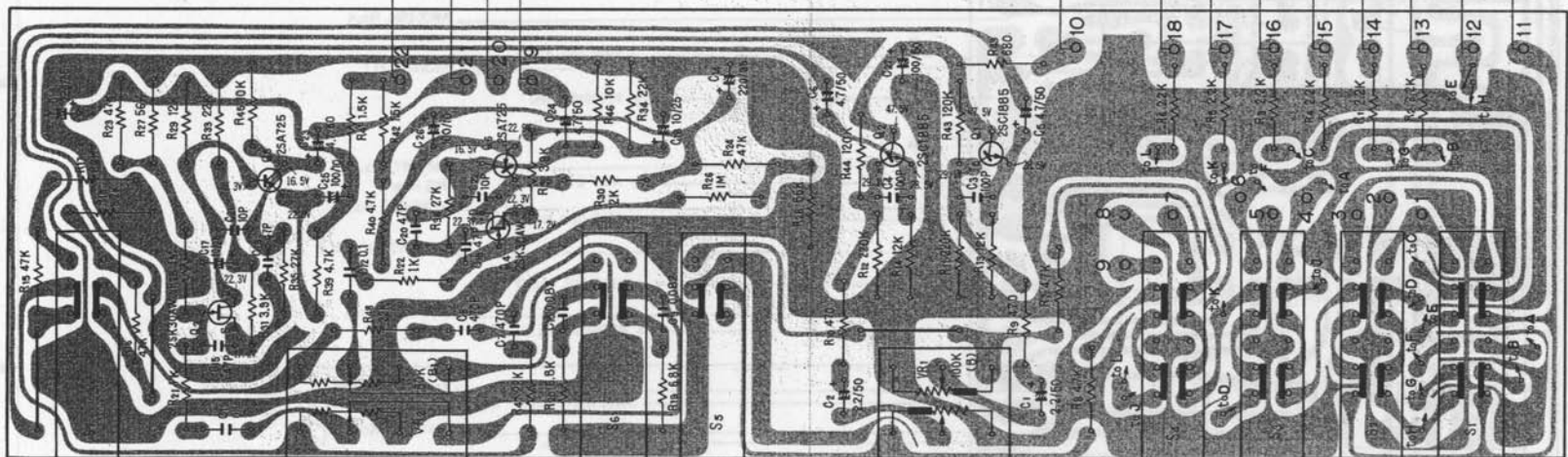

- ADAPTOR IN(R) ⊙
- ADAPTOR IN(L) ⊙
- TAPE 2 PLAY(L) ⊙
- TAPE 1 PLAY(L) ⊙
- TAPE 1 PLAY(R) ⊙
- TAPE 2 PLAY(R) ⊙



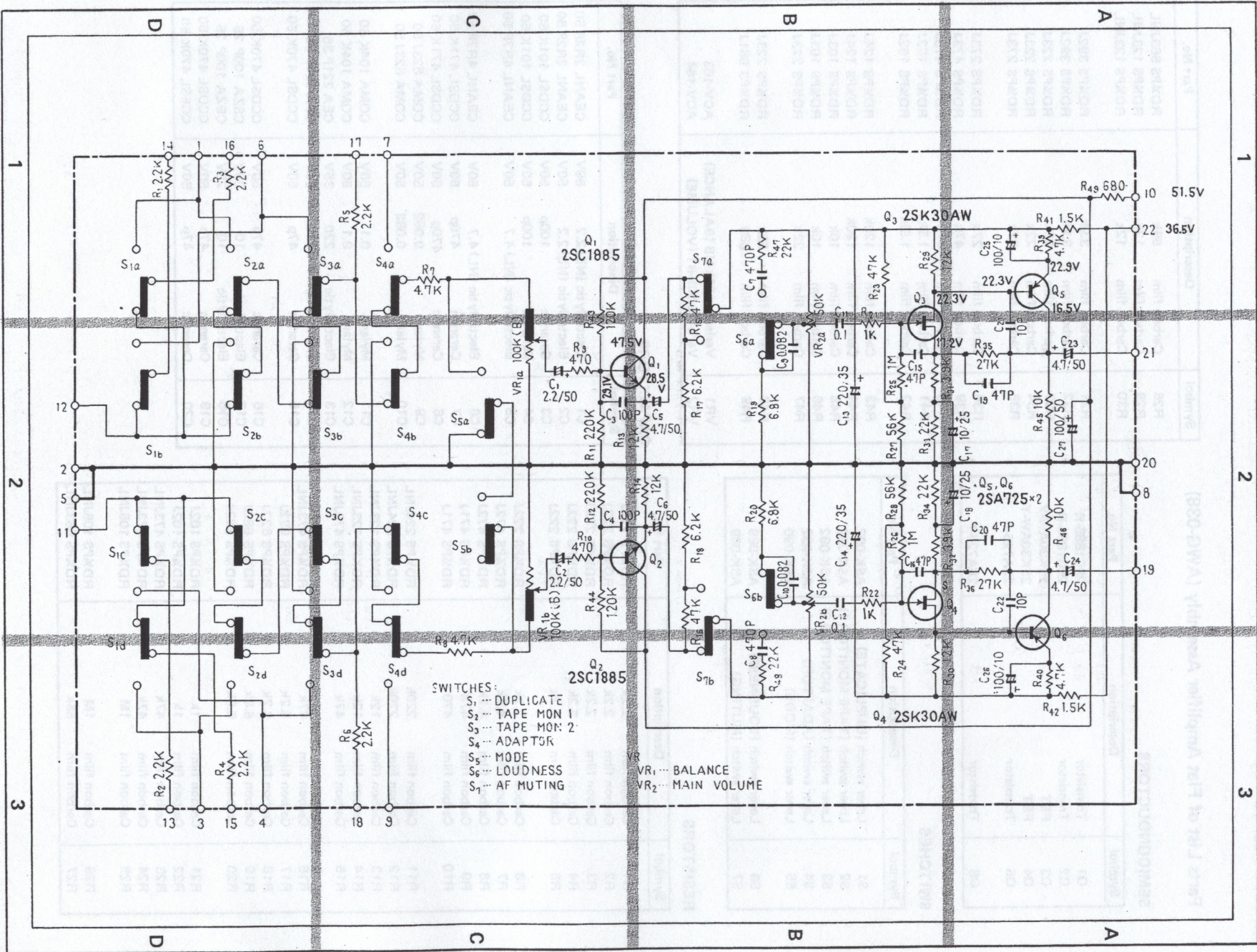

SWITCHES:  
 S<sub>1</sub>... DUPLICATE  
 S<sub>2</sub>... TAPE MON 1  
 S<sub>3</sub>... TAPE MON 2  
 S<sub>4</sub>... ADAPTOR  
 S<sub>5</sub>... MODE  
 S<sub>6</sub>... LOUDNESS  
 S<sub>7</sub>... AF MUTING

VR  
 VR<sub>1</sub>... BALANCE  
 VR<sub>2</sub>... MAIN VOLUME



## Parts List of Flat Amplifier Assembly (AWG-038)

### SEMICONDUCTORS

| Symbol | Description | Part No.  |
|--------|-------------|-----------|
| Q1     | Transistor  | 2SC1885-R |
| Q2     | Transistor  | 2SC1885-R |
| Q3     | FET         | 2SK30AW-Y |
| Q4     | FET         | 2SK30AW-Y |
| Q5     | Transistor  | 2SA725-F  |
| Q6     | Transistor  | 2SA725-F  |

### SWITCHES

| Symbol | Description                   | Part No. |
|--------|-------------------------------|----------|
| S1     | Lever switch (DUPLICATE)      | ASK-092  |
| S2     | Lever switch (TAPE MONITOR 1) | ASK-092  |
| S3     | Lever switch (TAPE MONITOR 2) | ASK-092  |
| S4     | Lever switch (ADAPTOR)        | ASK-092  |
| S5     | Lever switch (MODE)           | ASK-090  |
| S6     | Lever switch (LOUDNESS)       | ASK-089  |
| S7     | Lever switch (MUTING)         | ASK-089  |

### RESISTORS

| Symbol | Description      | Part No.     |
|--------|------------------|--------------|
| R1     | Carbon film 2.2k | RD%PS 222J   |
| R2     | Carbon film 2.2k | RD%PS 222J   |
| R3     | Carbon film 2.2k | RD%PS 222J   |
| R4     | Carbon film 2.2k | RD%PS 222J   |
| R5     | Carbon film 2.2k | RD%PS 222J   |
| R6     | Carbon film 2.2k | RD%PS 222J   |
| R7     | Carbon film 4.7k | RD%PS 472J   |
| R8     | Carbon film 4.7k | RD%PS 472J   |
| R9     | Carbon film 470  | RD%PS 471J   |
| R10    | Carbon film 470  | RD%PS 471J   |
| R11    | Carbon film 220k | RD%PS 224JNL |
| R12    | Carbon film 220k | RD%PS 224JNL |
| R13    | Carbon film 12k  | RD%PS 123JNL |
| R14    | Carbon film 12k  | RD%PS 123JNL |
| R15    | Carbon film 47k  | RD%PS 473JNL |
| R16    | Carbon film 47k  | RD%PS 473JNL |
| R17    | Carbon film 6.2k | RD%PS 622J   |
| R18    | Carbon film 6.2k | RD%PS 622J   |
| R19    | Carbon film 6.8k | RD%PS 682J   |
| R20    | Carbon film 6.8k | RD%PS 682J   |
| R21    | Carbon film 1k   | RD%PS 102J   |
| R22    | Carbon film 1k   | RD%PS 102J   |
| R23    | Carbon film 47k  | RD%PS 473JNL |
| R24    | Carbon film 47k  | RD%PS 473JNL |
| R25    | Carbon film 1M   | RD%PS 105JNL |
| R26    | Carbon film 1M   | RD%PS 105JNL |
| R27    | Carbon film 56k  | RD%PS 563JNL |

| Symbol | Description                | Part No.     |
|--------|----------------------------|--------------|
| R28    | Carbon film 56k            | RD%PS 563JNL |
| R29    | Carbon film 12k            | RD%PS 123JNL |
| R30    | Carbon film 12k            | RD%PS 123JNL |
| R31    | Carbon film 3.9k           | RD%PS 392J   |
| R32    | Carbon film 3.9k           | RD%PS 392J   |
| R33    | Carbon film 22k            | RD%PS 223J   |
| R34    | Carbon film 22k            | RD%PS 223J   |
| R35    | Carbon film 27k            | RD%PS 273J   |
| R36    | Carbon film 27k            | RD%PS 273J   |
| R39    | Carbon film 47k            | RD%PS 473J   |
| R40    | Carbon film 47k            | RD%PS 473J   |
| R41    | Carbon film 1.5k           | RD%PS 152J   |
| R42    | Carbon film 1.5k           | RD%PS 152J   |
| R43    | Carbon film 120k           | RD%PS 124J   |
| R44    | Carbon film 120k           | RD%PS 124J   |
| R45    | Carbon film 10k            | RD%PS 103J   |
| R46    | Carbon film 10k            | RD%PS 103J   |
| R47    | Carbon film 22k            | RD%PS 223J   |
| R48    | Carbon film 22k            | RD%PS 223J   |
| R49    | Carbon film 680            | RD%PS 681J   |
| VR1    | Variable 100k-HB (BALANCE) | ACV-163      |
| VR2    | Variable 50k-B1 (VOLUME)   | ACV-164      |

### CAPACITORS

| Symbol | Description               | Part No.      |
|--------|---------------------------|---------------|
| C1     | Electrolytic (NL) 2.2 50V | CEANL 2R2P 50 |
| C2     | Electrolytic (NL) 2.2 50V | CEANL 2R2P 50 |
| C3     | Ceramic 100p 50V          | CCDSL 101K 50 |
| C4     | Ceramic 100p 50V          | CCDSL 101K 50 |
| C5     | Electrolytic (NL) 4.7 50V | CEANL 4R7P 50 |
| C6     | Electrolytic (NL) 4.7 50V | CEANL 4R7P 50 |
| C7     | Ceramic 470p 50V          | CCDSL 471K 50 |
| C8     | Ceramic 470p 50V          | CCDSL 471K 50 |
| C9     | Mylar 0.082 50V           | CQMA 823J 50  |
| C10    | Mylar 0.082 50V           | CQMA 823J 50  |
| C11    | Mylar 0.1 50V             | CQMA 104K 50  |
| C12    | Mylar 0.1 50V             | CQMA 104K 50  |
| C13    | Electrolytic 220 35V      | CEA 221P 35   |
| C14    | Electrolytic 220 35V      | CEA 221P 35   |
| C15    | Ceramic 47p 50V           | CCDSL 470K 50 |
| C16    | Ceramic 47p 50V           | CCDSL 470K 50 |
| C17    | Electrolytic 10 25V       | CSZA 100P 25  |
| C18    | Electrolytic 10 25V       | CEZA 100P 25  |
| C19    | Ceramic 47p 50V           | CCDSL 470K 50 |
| C20    | Ceramic 47p 50V           | CCESL 470K 50 |



| Symbol | Description               | Part No.      |
|--------|---------------------------|---------------|
| C21    | Ceramic 10p 50V           | CCDSL 100K 50 |
| C22    | Ceramic 10p 50V           | CCDSL 100K 50 |
| C23    | Electrolytic (NL) 4.7 50V | CEANL 4R7P 50 |
| C24    | Electrolytic (NL) 4.7 50V | CEANL 4R7P 50 |
| C25    | Electrolytic (NL) 100 10V | CEANL 101P 10 |
| C26    | Electrolytic (NL) 100 10V | CEANL 101P 10 |
| C27    | Electrolytic 100 50V      | CEA 101P 50   |

OTHERS

| Symbol | Description      | Part No. |
|--------|------------------|----------|
|        | Union nut        | ABN-021  |
|        | Washer faced nut | ABN-024  |
|        | Screw            | ABA-116  |

12.9 SWITCH ASSEMBLY (AWS-093)

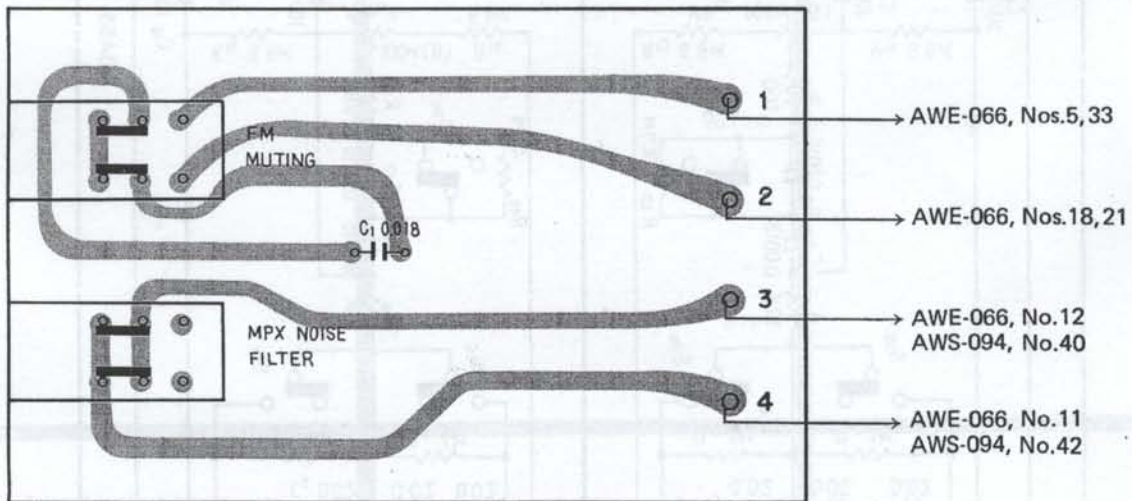
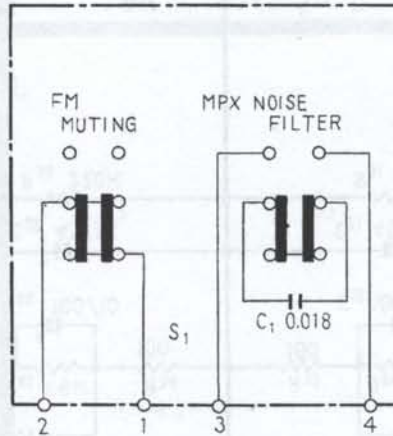

Parts List of Switch Assembly (AWS-093)

| Symbol | Description                               | Part No.     |
|--------|---|--------------|
| S1     | Push switch (FM MUTING, MPX NOISE FILTER) | ASG-096      |
| C1     | Mylar capacitor 0.018 50V                 | CQMA 183J 50 |



12.10 TONE AMPLIFIER ASSEMBLY (AWG-039)

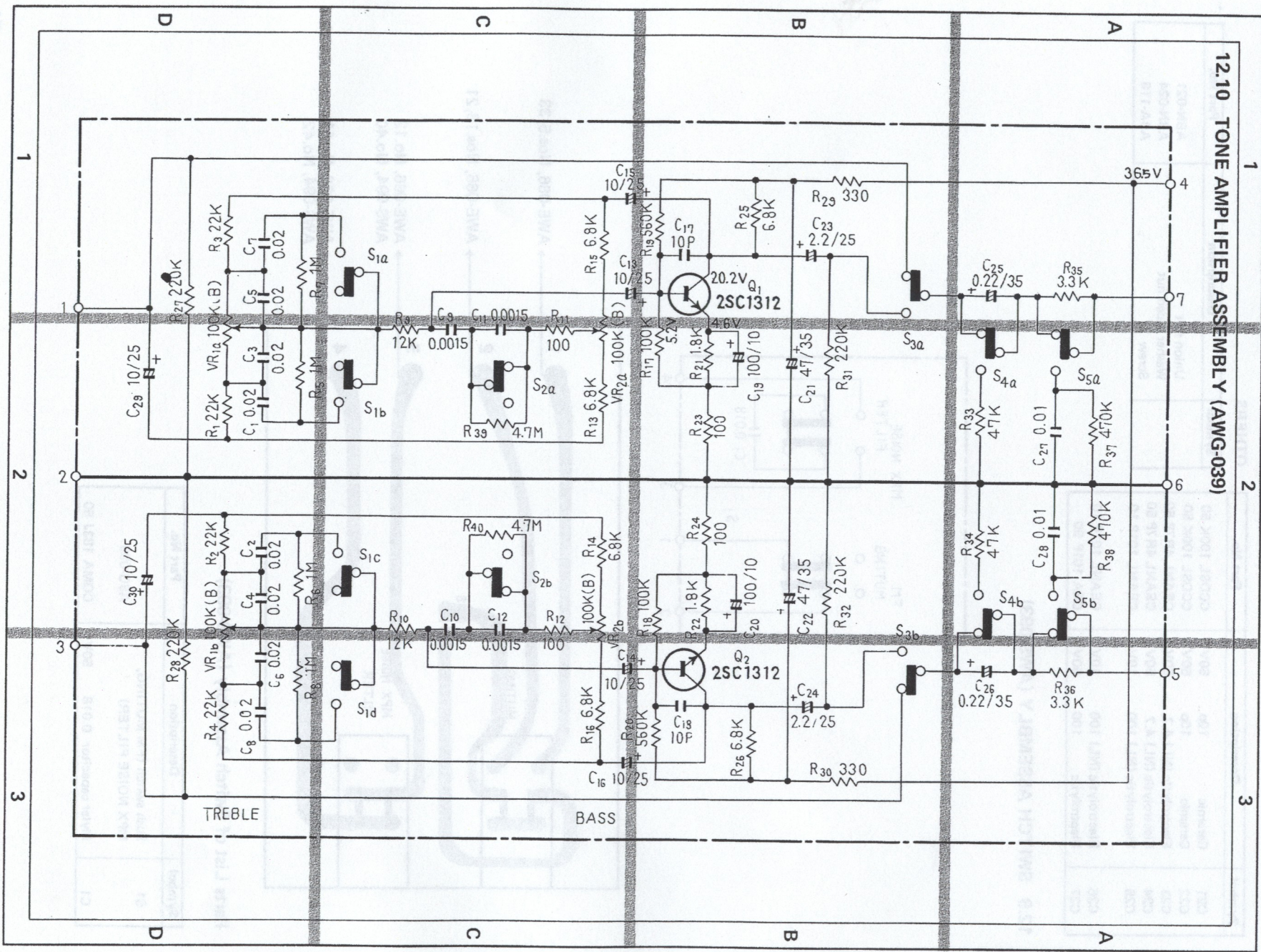



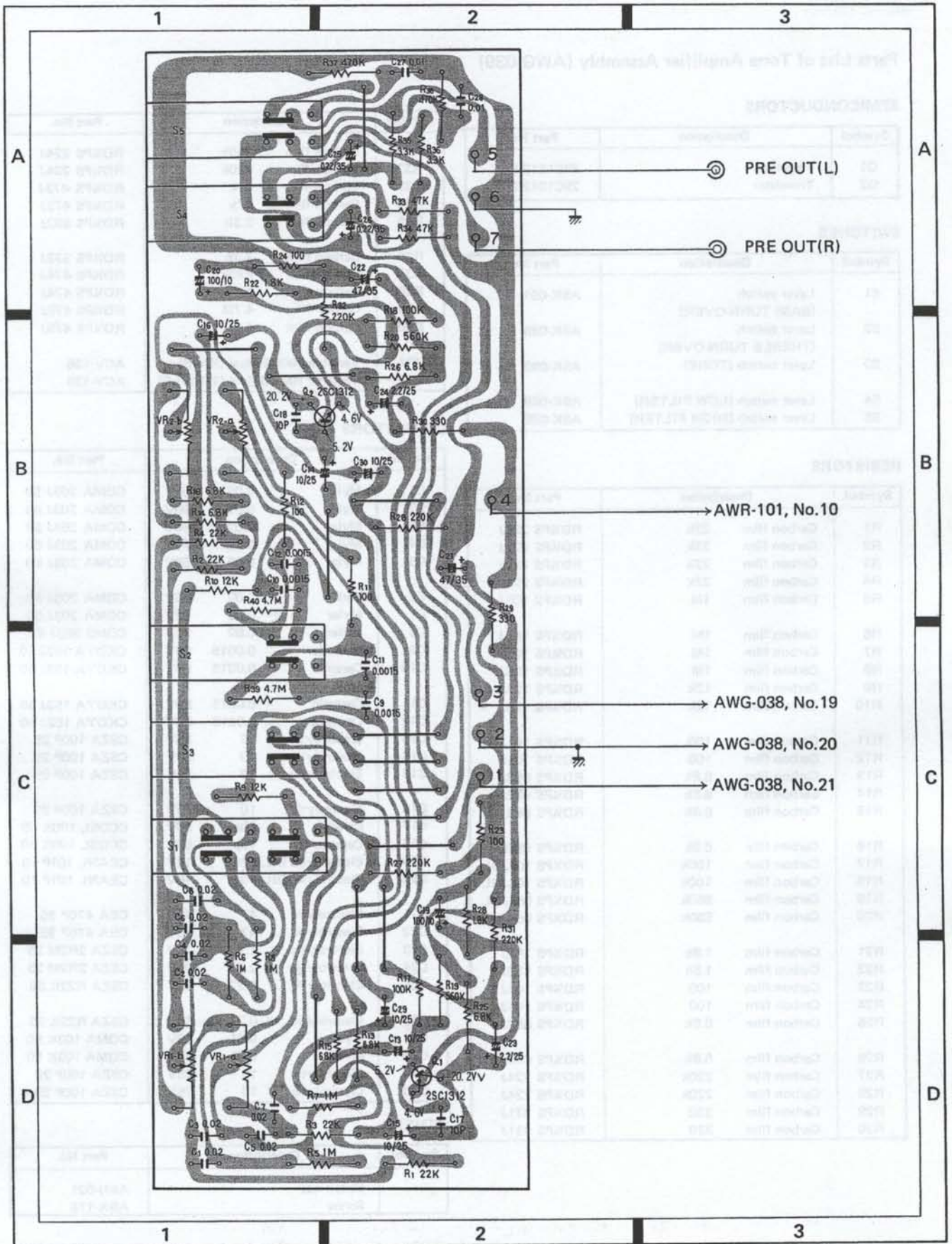



## Parts List of Tone Amplifier Assembly (AWG-039)

### SEMICONDUCTORS

| Symbol | Description | Part No.  |
|--------|-------------|-----------|
| Q1     | Transistor  | 2SC1312-F |
| Q2     | Transistor  | 2SC1312-F |

### SWITCHES

| Symbol | Description                        | Part No. |
|--------|------------------------------------|----------|
| S1     | Lever switch<br>(BASS TURN-OVER)   | ASK-091  |
| S2     | Lever switch<br>(TREBLE TURN-OVER) | ASK-089  |
| S3     | Lever switch (TONE)                | ASK-090  |
| S4     | Lever switch (LOW FILTER)          | ASK-089  |
| S5     | Lever switch (HIGH FILTER)         | ASK-089  |

### RESISTORS

| Symbol | Description      | Part No.     |
|--------|------------------|--------------|
| R1     | Carbon film 22k  | RD%PS 223J   |
| R2     | Carbon film 22k  | RD%PS 223J   |
| R3     | Carbon film 22k  | RD%PS 223J   |
| R4     | Carbon film 22k  | RD%PS 223J   |
| R5     | Carbon film 1M   | RD%PS 105J   |
| R6     | Carbon film 1M   | RD%PS 105J   |
| R7     | Carbon film 1M   | RD%PS 105J   |
| R8     | Carbon film 1M   | RD%PS 105J   |
| R9     | Carbon film 12k  | RD%PS 123J   |
| R10    | Carbon film 12k  | RD%PS 123J   |
| R11    | Carbon film 100  | RD%PS 101J   |
| R12    | Carbon film 100  | RD%PS 101J   |
| R13    | Carbon film 6.8k | RD%PS 682J   |
| R14    | Carbon film 6.8k | RD%PS 682J   |
| R15    | Carbon film 6.8k | RD%PS 682J   |
| R16    | Carbon film 6.8k | RD%PS 682J   |
| R17    | Carbon film 100k | RD%PS 104JNL |
| R18    | Carbon film 100k | RD%PS 104JNL |
| R19    | Carbon film 560k | RD%PS 564JNL |
| R20    | Carbon film 560k | RD%PS 564JNL |
| R21    | Carbon film 1.8k | RD%PS 182J   |
| R22    | Carbon film 1.8k | RD%PS 182J   |
| R23    | Carbon film 100  | RD%PS 101J   |
| R24    | Carbon film 100  | RD%PS 101J   |
| R25    | Carbon film 6.8k | RD%PS 682J   |
| R26    | Carbon film 6.8k | RD%PS 682J   |
| R27    | Carbon film 220k | RD%PS 224J   |
| R28    | Carbon film 220k | RD%PS 224J   |
| R29    | Carbon film 330  | RD%PS 331J   |
| R30    | Carbon film 330  | RD%PS 331J   |

| Symbol | Description                   | Part No.   |
|--------|-------------------------------|------------|
| R31    | Carbon film 220k              | RD%PS 224J |
| R32    | Carbon film 220k              | RD%PS 224J |
| R33    | Carbon film 47k               | RD%PS 473J |
| R34    | Carbon film 47k               | RD%PS 473J |
| R35    | Carbon film 3.3k              | RD%PS 332J |
| R36    | Carbon film 3.3k              | RD%PS 332J |
| R37    | Carbon film 470k              | RD%PS 474J |
| R38    | Carbon film 470k              | RD%PS 474J |
| R39    | Carbon film 4.7M              | RD%PS 475J |
| R40    | Carbon film 4.7M              | RD%PS 475J |
| VR1    | Variable 100k-B dual (BASS)   | ACV-136    |
| VR2    | Variable 100k-B dual (TREBLE) | ACV-136    |

### CAPACITORS

| Symbol | Description               | Part No.      |
|--------|---------------------------|---------------|
| C1     | Mylar 0.02 50V            | CQMA 203J 50  |
| C2     | Mylar 0.02 50V            | CQMA 203J 50  |
| C3     | Mylar 0.02 50V            | CQMA 203J 50  |
| C4     | Mylar 0.02 50V            | CQMA 203J 50  |
| C5     | Mylar 0.02 50V            | CQMA 203J 50  |
| C6     | Mylar 0.02 50V            | CQMA 203J 50  |
| C7     | Mylar 0.02 50V            | CQMA 203J 50  |
| C8     | Mylar 0.02 50V            | CQMS 203J 50  |
| C9     | Ceramic 0.0015 50V        | CKDYA 152J 50 |
| C10    | Ceramic 0.0015 50V        | CKDYA 152J 50 |
| C11    | Ceramic 0.0015 50V        | CKDYA 152J 50 |
| C12    | Ceramic 0.0015 50V        | CKDYA 152J 50 |
| C13    | Electrolytic 10 25V       | CSZA 100P 25  |
| C14    | Electrolytic 10 25V       | CSZA 100P 25  |
| C15    | Electrolytic 10 25V       | CSZA 100P 25  |
| C16    | Electrolytic 10 25V       | CSZA 100P 25  |
| C17    | Ceramic 10p 50V           | CCDSL 100K 50 |
| C18    | Ceramic 10p 50V           | CCDSL 100K 50 |
| C19    | Electrolytic (NL) 100 16V | CEANL 101P 10 |
| C20    | Electrolytic (NL) 100 16V | CEANL 101P 10 |
| C21    | Electrolytic 47 35V       | CEA 470P 35   |
| C22    | Electrolytic 47 35V       | CEA 470P 35   |
| C23    | Electrolytic 2.2 25V      | CSZA 2R2M 25  |
| C24    | Electrolytic 2.2 25V      | CSZA 2R2M 25  |
| C25    | Electrolytic 0.22 35V     | CSZA R22K 35  |
| C26    | Electrolytic 0.22 35V     | CSZA R22K 35  |
| C27    | Mylar 0.01 50V            | CQMA 103K 50  |
| C28    | Mylar 0.01 50V            | CQMA 103K 50  |
| C29    | Electrolytic 10 25V       | CSZA 100P 25  |
| C30    | Electrolytic 10 25V       | CSZA 100P 25  |

### OTHERS

| Symbol | Description | Part No. |
|--------|-------------|----------|
|        | Union nut   | ABN-021  |
|        | Screw       | ABA-116  |



12.11 SWITCH ASSEMBLY (AWX-095)

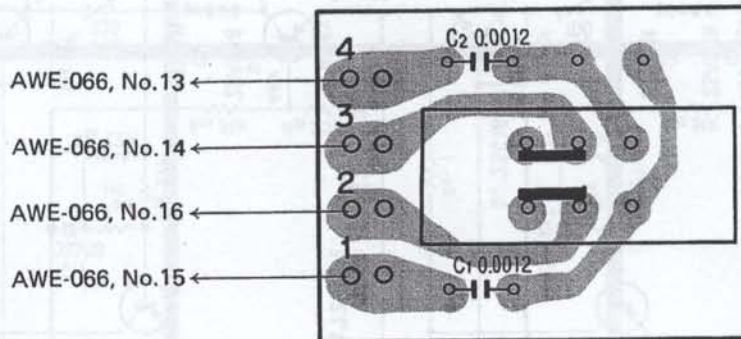
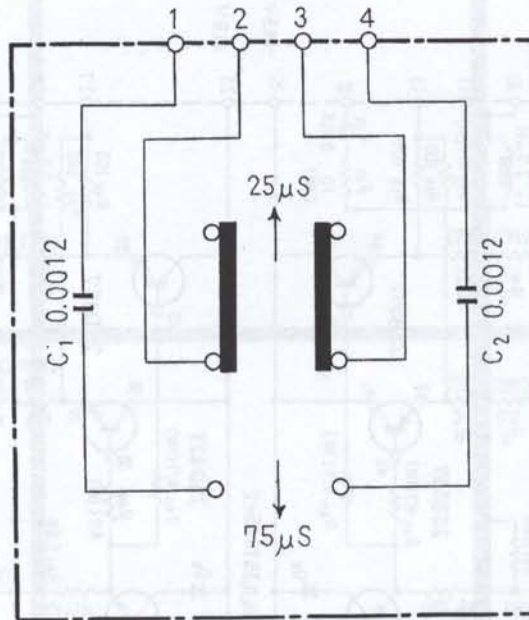

Parts List of Switch Assembly (AWX-095)

| Symbol | Description                | Part No.     |
|--------|----------------------------|--------------|
|        | Slide switch (DE-EMPHASIS) | ASH-015      |
| C1     | Mylar capacitor 0.0012 50V | CQMA 122J 50 |
| C2     | Mylar capacitor 0.0012 50V | CQMA 122J 50 |