

# AM/FM STEREO RECEIVER

# SX-636

KCU

<ART-155-0>



 **PIONEER®**

# SERVICE MANUAL

AM/FM STEREO RECEIVER

# SX-636

KCU, FV, GN

**NOTE:**

THE MODEL SX-636 COMES IN THREE VERSIONS DISTINGUISHED AS FOLLOWS:

Round label on rear panel	Voltage	Type
KCU	120V only	UL (U.S.A.) and CSA (Canada) approved.
GN	220V only	SEMCO (Sweden) DEMCO (Denmark) and NEMCO (Norway) approved.
FV	110V, 120V, 130V, 220V and 240V (switchable)	General export model.

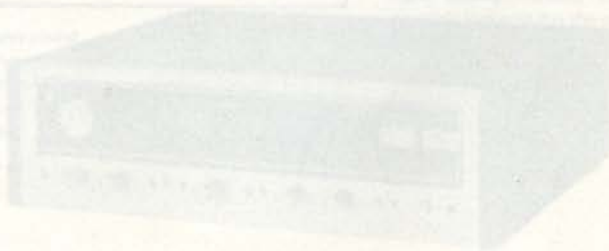

 **PIONEER**<sup>®</sup>

# CONTENTS

1.	SPECIFICATIONS .....	3
2.	FRONT PANEL FACILITIES .....	5
3.	CONNECTION DIAGRAM .....	7
4.	BLOCK DIAGRAM AND LEVEL DIAGRAM .....	9
5.	DISASSEMBLY .....	11
6.	PARTS AND P.C. BOARD LOCATION .....	12
7.	DIAL CORD STRINGING .....	14
8.	ADJUSTMENTS .....	15
9.	PACKING METHOD AND PARTS NUMBERS .....	23
10.	EXPLODED VIEW AND PARTS LIST .....	24
11.	SCHEMATIC DIAGRAMS, P.C. BOARD PATTERNS AND PARTS LIST	
11.1	Circuit Connection Diagram and Miscellaneous Parts .....	29
11.2	Tuner Assembly (AWE-046) .....	34
11.3	Equalizer Amplifier Assembly (AWF-014) .....	40
11.4	AF Amplifier Assembly (AWK-035) .....	43
11.5	Power Amplifier Assembly (AWH-034) .....	48
11.6	Power Supply Circuit Assembly (AWR-060) .....	53
11.7	Power Supply Circuit Assembly (AWR-061) for 220V only model ...	56



# 1. SPECIFICATIONS

## SEMICONDUCTORS

FET	1
ICs	3
Transistors	33
Diodes	17

## AMPLIFIER SECTION

### Continuous Power Output

20Hz~20kHz (Both channels driven)	25W + 25W (8Ω:Rated power), 27W + 27W (4Ω)
1kHz (Both channels driven)	27W + 27W (8Ω), 30W + 30W (4Ω)

### Harmonic Distortion

(20Hz~20kHz Continuous Power Output)	Less than 0.5%
(1W + 1W, Power Output)	Less than 0.07%

### Intermodulation Distortion

(Continuous Power Output)	Less than 0.5%
(1W + 1W, Power Output)	Less than 0.07%

### Power Bandwidth

(IHF, Both channels driven)	5Hz~60kHz (T.H.D. 0.5%)
-----------------------------	-------------------------

Output Speaker	A, B, A + B, (4Ω ~ 16Ω)
Headphone	4Ω ~ 16Ω

Damping Factor (1kHz, 8Ω)	More than 35
---------------------------	--------------

### Residual Hum & Noise

(8Ω, Pre & Power amplifier)	Less than 0.5mV
-----------------------------	-----------------

### Input Sensitivity/Impedance

PHONO	2.5mV/50kΩ
PHONO Overload Level (rms/p-p)	110mV/310mV
MIC	7mV/85kΩ
AUX	150mV/60kΩ
TAPE PB 1, 2	150mV/60kΩ
TAPE PB 2 (DIN connector)	150mV/60kΩ

### Output Level/Impedance

TAPE REC 1, 2	150mV
TAPE REC 2 (DIN connector)	30mV/80kΩ

### Frequency Response

PHONO (RIAA equalization)	30Hz ~ 15kHz ±0.5dB
AUX, TAPE PB	20Hz ~ 30kHz ±0.5 dB

### Filter

HIGH	-9dB (10kHz) 6dB/oct
------	----------------------

### Tone Control

BASS	±10dB (100Hz)
TREBLE	±10dB (10kHz)

### Loudness Contour (Volume control)

set at -40dB position	+9dB (100Hz), +5dB (10kHz)
-----------------------	----------------------------

### Hum & Noise (IHF, short-circuited, A Network)

PHONO	More than 70dB
MIC	More than 65dB
AUX, TAPE PB	More than 90dB



## 2. FRONT PANEL FACILITIES

### SIGNAL METER

Tune in both AM and FM stations for maximum deflection of the meter indicator to the right.

### FM TUNING METER

When tuning in an FM station, first employ the SIGNAL meter, then perform fine tuning adjustment in order to center the needle of this meter.

### PHONES JACK

For plugging in stereo headphones. A wide variety of high quality headphones are available from Pioneer.

### POWER BUTTON

AC power is turned on by pushing this switch to ON.

### SPEAKER BUTTONS

Buttons for selecting A or B speaker system connected to A or B output terminals.

- A: Speaker system A operates
- B: Speaker system B operates

#### NOTES:

1. When employing headphones, speakers can be turned off by setting the SPEAKERS buttons to the OFF (undepressed) position.
2. Two pairs (A, B) of speaker systems can be used at the same time with A and B switches pushed.

### BASS & TREBLE CONTROLS

Adjust bass and treble. Flat response is obtained at center of rotation. Turning the controls clockwise or counterclockwise from center will boost or diminish the tone as desired.

### HIGH FILTER BUTTON

Push this button to ON (undepressed position) when high pitched noise, such as record scratch noise, is objectionable. At other times, set this button to OFF.

### BALANCE CONTROL

Adjusts balance between left and right speakers. When turned clockwise, left channel volume decreases while right channel volume increases. Turning the control counterclockwise has the opposite effect.

### MODE BUTTON

Selects stereo or mono sound.

- STEREO: Leave it undepressed.
- MONO: Depress it for monophonic sound into which the left and right channel signals blend.

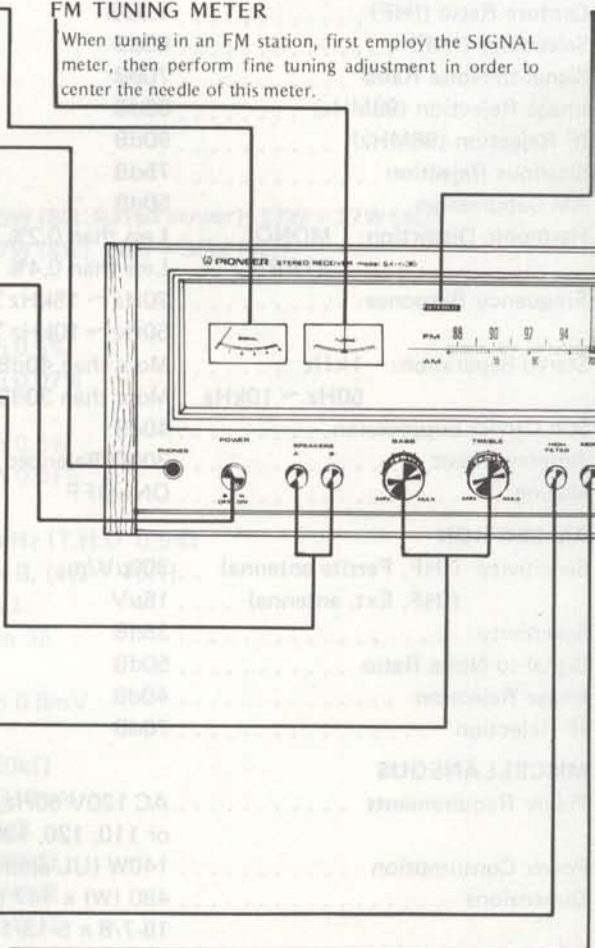

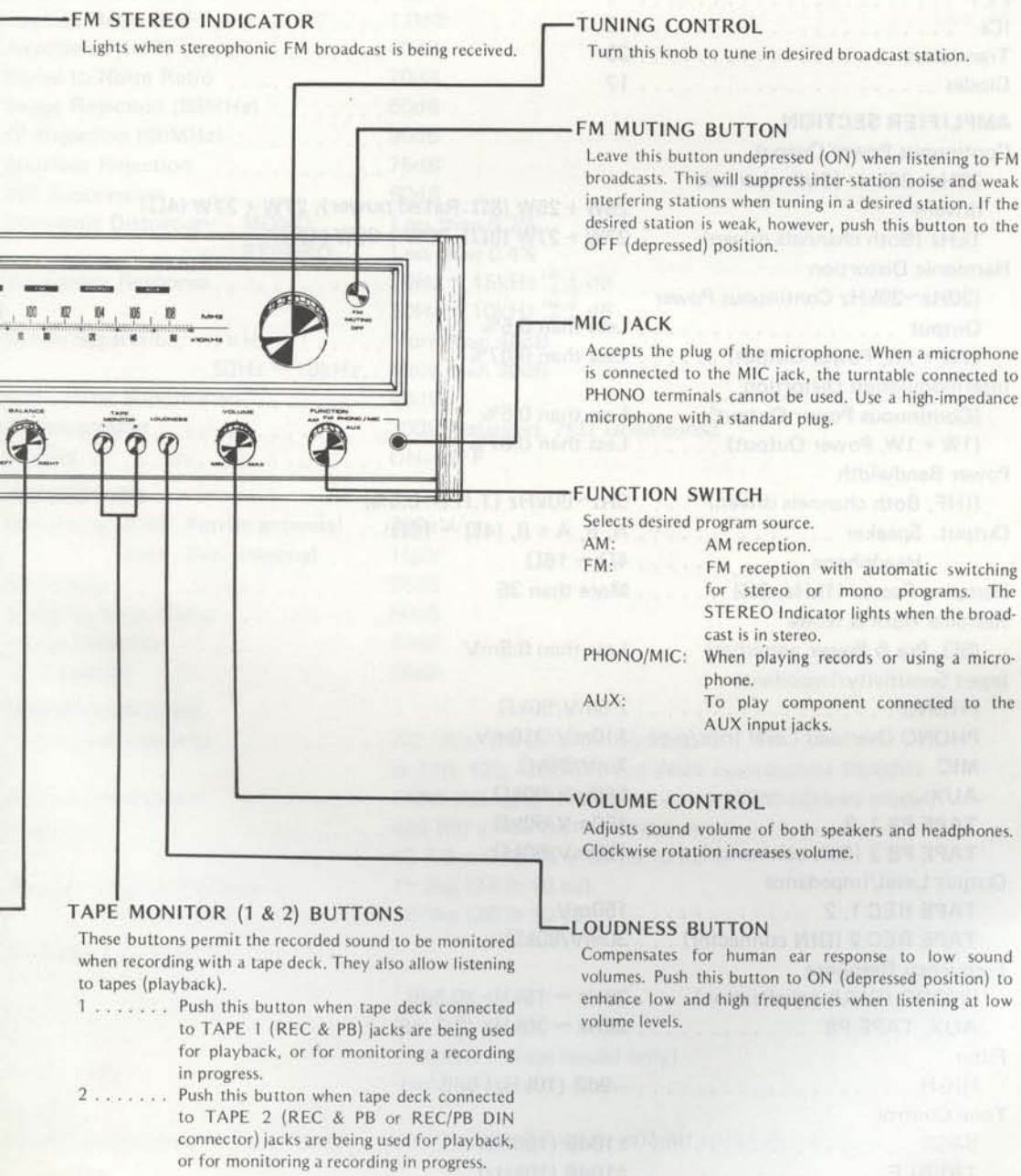

**FM STEREO INDICATOR**

Lights when stereophonic FM broadcast is being received.

**TUNING CONTROL**

Turn this knob to tune in desired broadcast station.

**FM MUTING BUTTON**

Leave this button undepressed (ON) when listening to FM broadcasts. This will suppress inter-station noise and weak interfering stations when tuning in a desired station. If the desired station is weak, however, push this button to the OFF (depressed) position.

**MIC JACK**

Accepts the plug of the microphone. When a microphone is connected to the MIC jack, the turntable connected to PHONO terminals cannot be used. Use a high-impedance microphone with a standard plug.

**FUNCTION SWITCH**

- Selects desired program source.
- AM: AM reception.
- FM: FM reception with automatic switching for stereo or mono programs. The STEREO Indicator lights when the broadcast is in stereo.
- PHONO/MIC: When playing records or using a microphone.
- AUX: To play component connected to the AUX input jacks.

**VOLUME CONTROL**

Adjusts sound volume of both speakers and headphones. Clockwise rotation increases volume.

**TAPE MONITOR (1 & 2) BUTTONS**

These buttons permit the recorded sound to be monitored when recording with a tape deck. They also allow listening to tapes (playback).

- 1 . . . . . Push this button when tape deck connected to TAPE 1 (REC & PB) jacks are being used for playback, or for monitoring a recording in progress.
- 2 . . . . . Push this button when tape deck connected to TAPE 2 (REC & PB or REC/PB DIN connector) jacks are being used for playback, or for monitoring a recording in progress.

**LOUDNESS BUTTON**

Compensates for human ear response to low sound volumes. Push this button to ON (depressed position) to enhance low and high frequencies when listening at low volume levels.

### 3. CONNECTION DIAGRAM

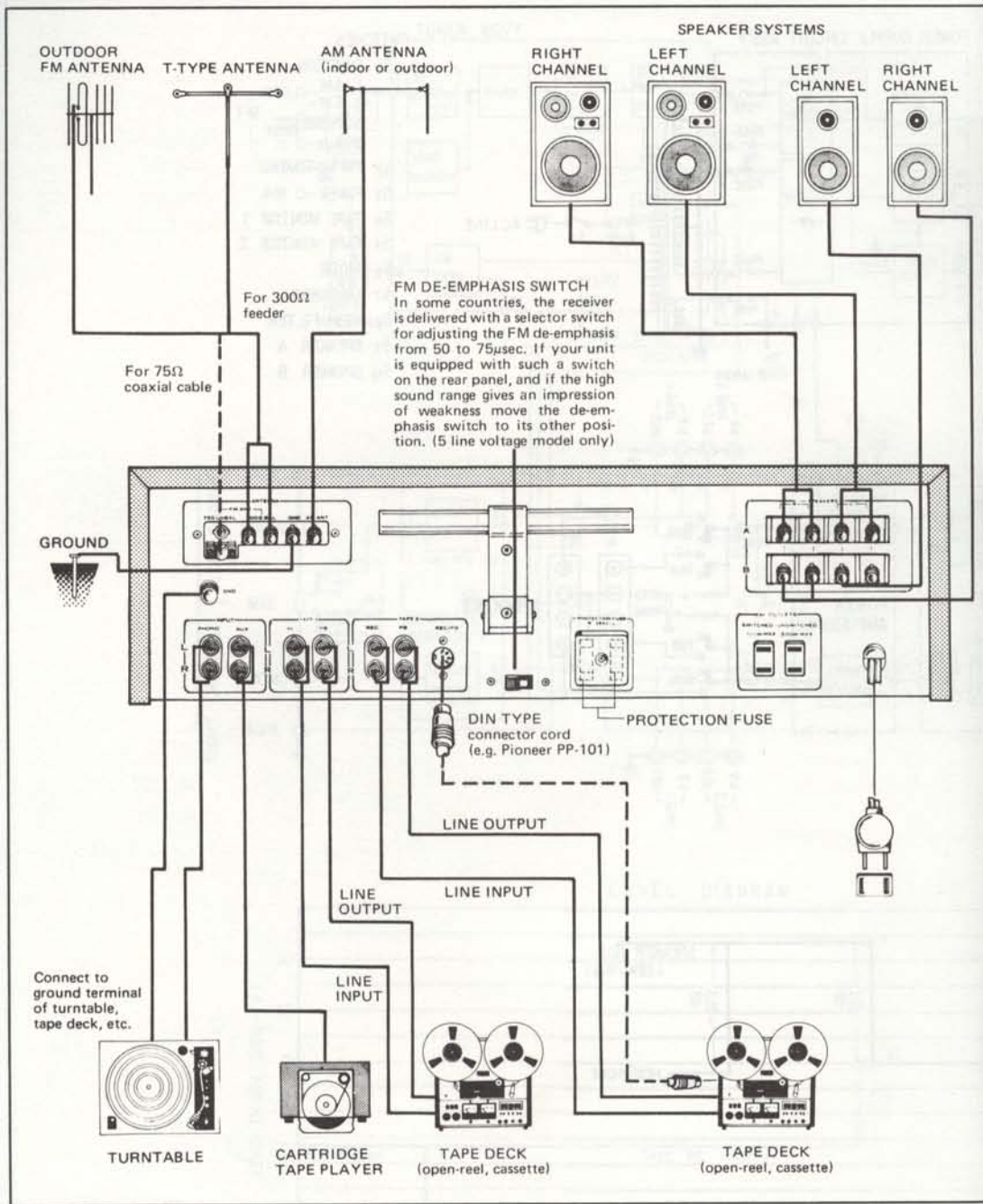



**Line Voltage And Fuse And Rear Panel**

Each design of LINE VOLTAGE and FUSE of this model differs according to each destination to be delivered.

How to operate the SX-636 is quite the same for each version. However, each rear panel differs according to LINE VOLTAGE and FUSE design for each version.

Fig. A shows the LINE VOLTAGE of a 120V only model.

Fig. B shows the LINE VOLTAGE of a 220V only model.

Fig. C shows a 5 line voltage (110V, 120V, 130V, 220V and 240V) model whose LINE VOLTAGE and FUSE can be changed and set as follows:

**Changing Line Voltage Setting And Fuse (Fig. D)**

To remove the fuse, turn the fuse cap located on the line voltage selector in the direction indicated by the arrow. Then remove the fuse plug from the unit. Put the fuse plug back so that the proper line voltage marking can be seen through the cut in the edge of the plug. Whenever the position of the selector is changed, check the rating of the fuse. A 1.5A fuse is to be used for either 220V or 240V operation and a 3A fuse rating for 110V, 120V or 130V operation. If the rating of the fuse is correct, replace cap.

**Fuse Replacement**

When the fuse blows, remove the fuse cap and replace the fuse with a new one.

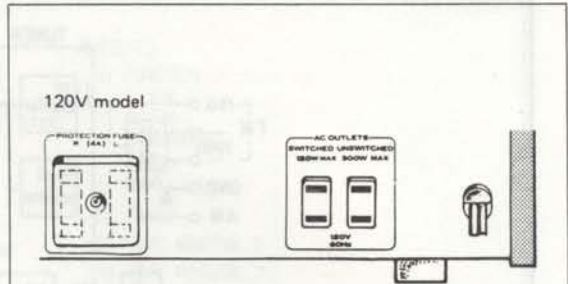

Fig. A

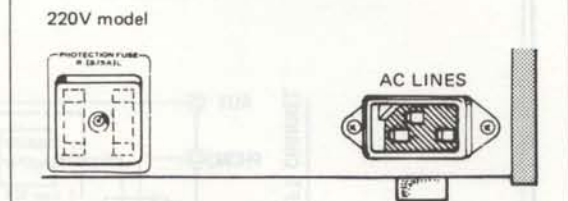

Fig. B

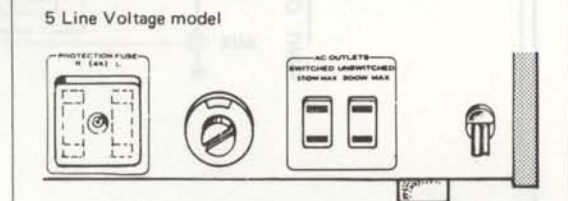

Fig. C

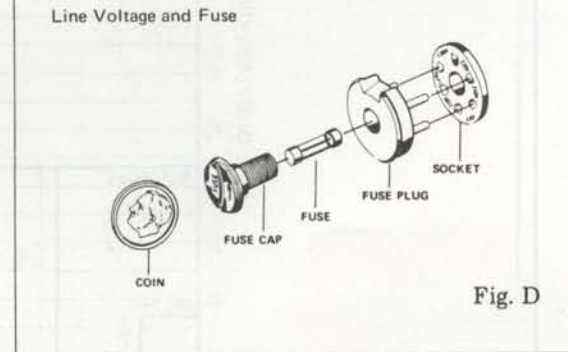
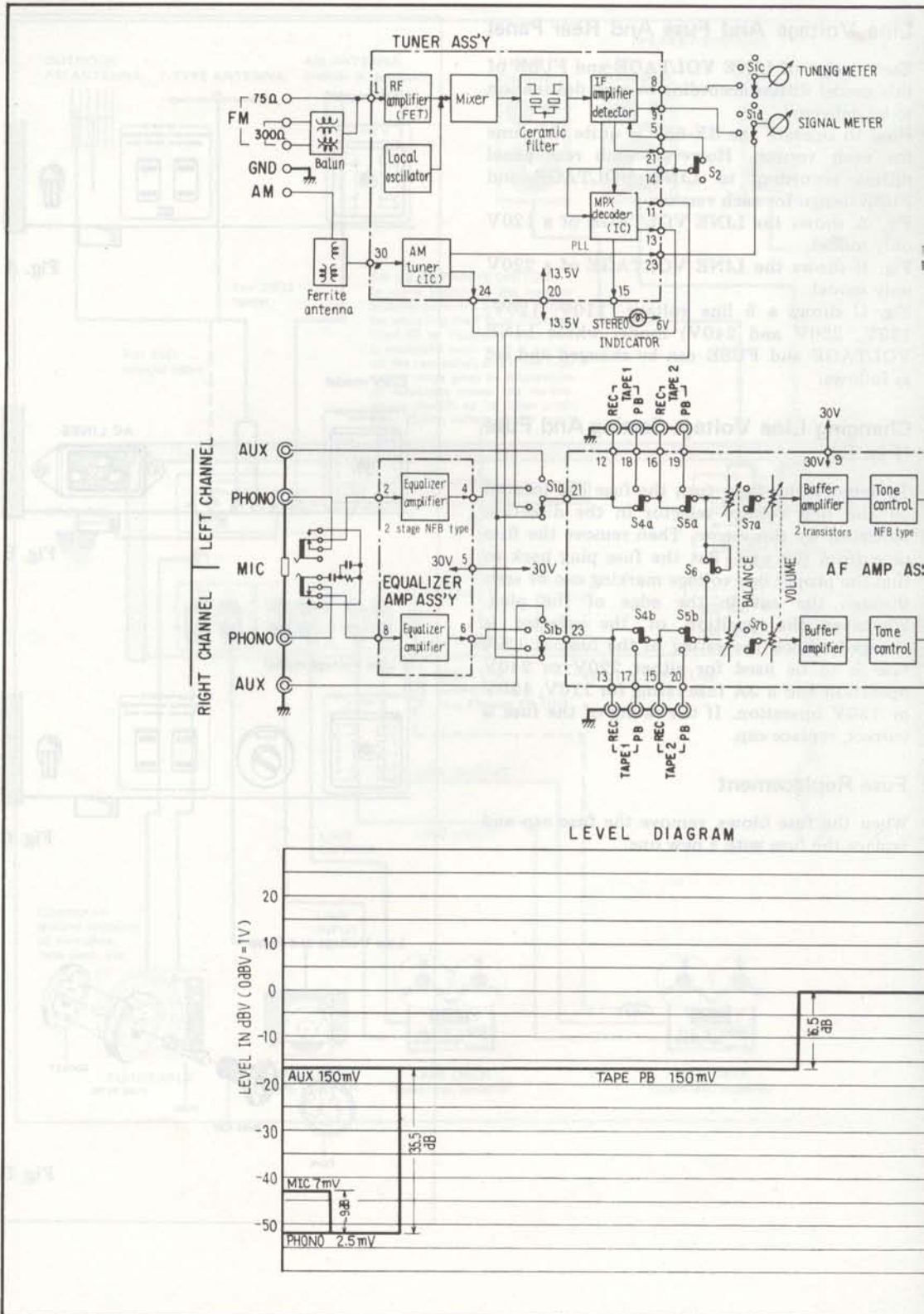
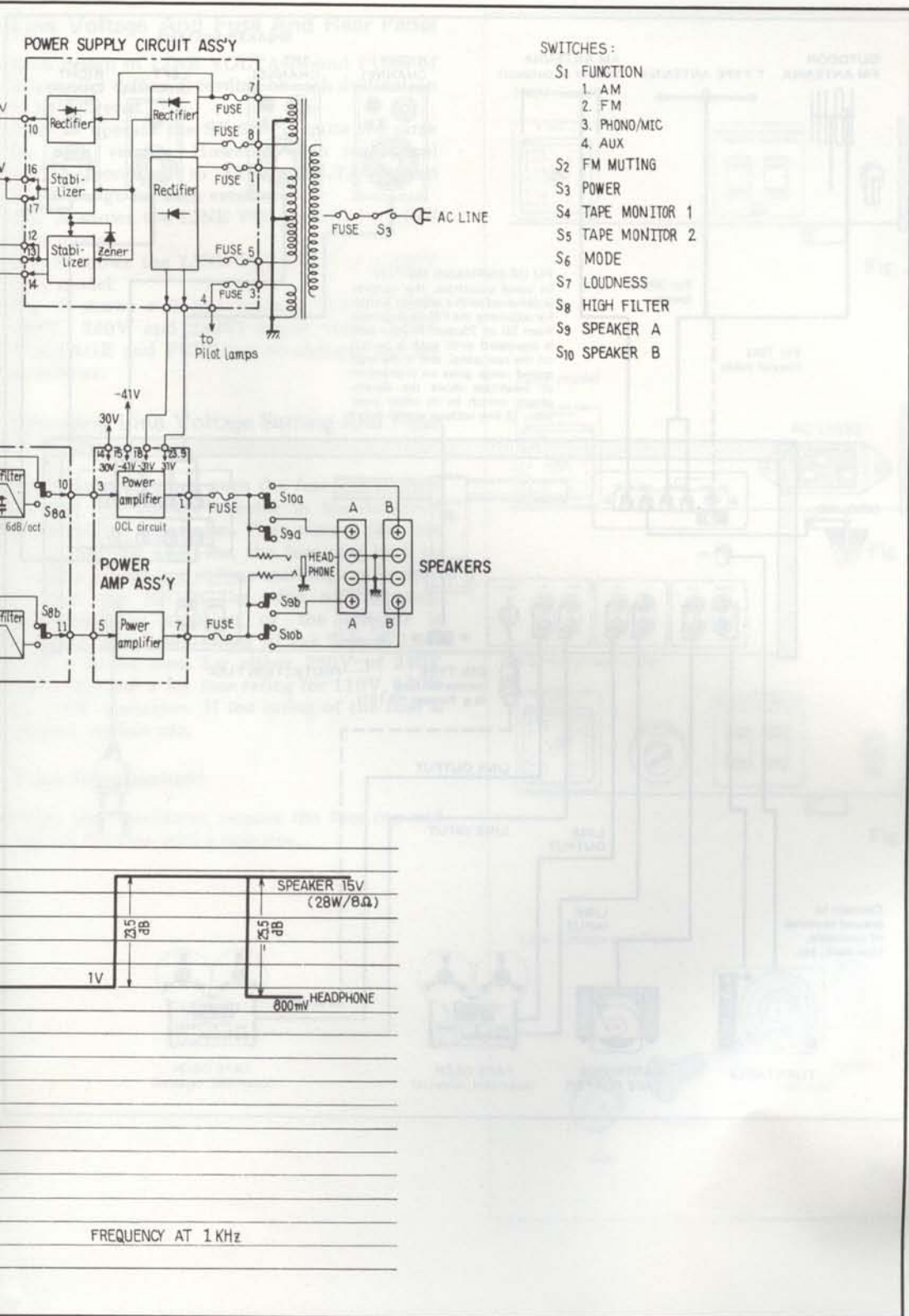

Fig. D

# 4. BLOCK DIAGRAM AND LEVEL DIAGRAM





## 5. DISASSEMBLY

1. To remove the wooden cabinet, remove 2 screws each fastening either side and lift the cabinet while sliding it backwards.
2. Pull off all the knobs.
3. To remove the front panel, remove 2 screws fastening its top and nuts holding each of BASS, BALANCE and FUNCTION control shafts.
4. To remove the bottom plate, remove a total of 15 screws.

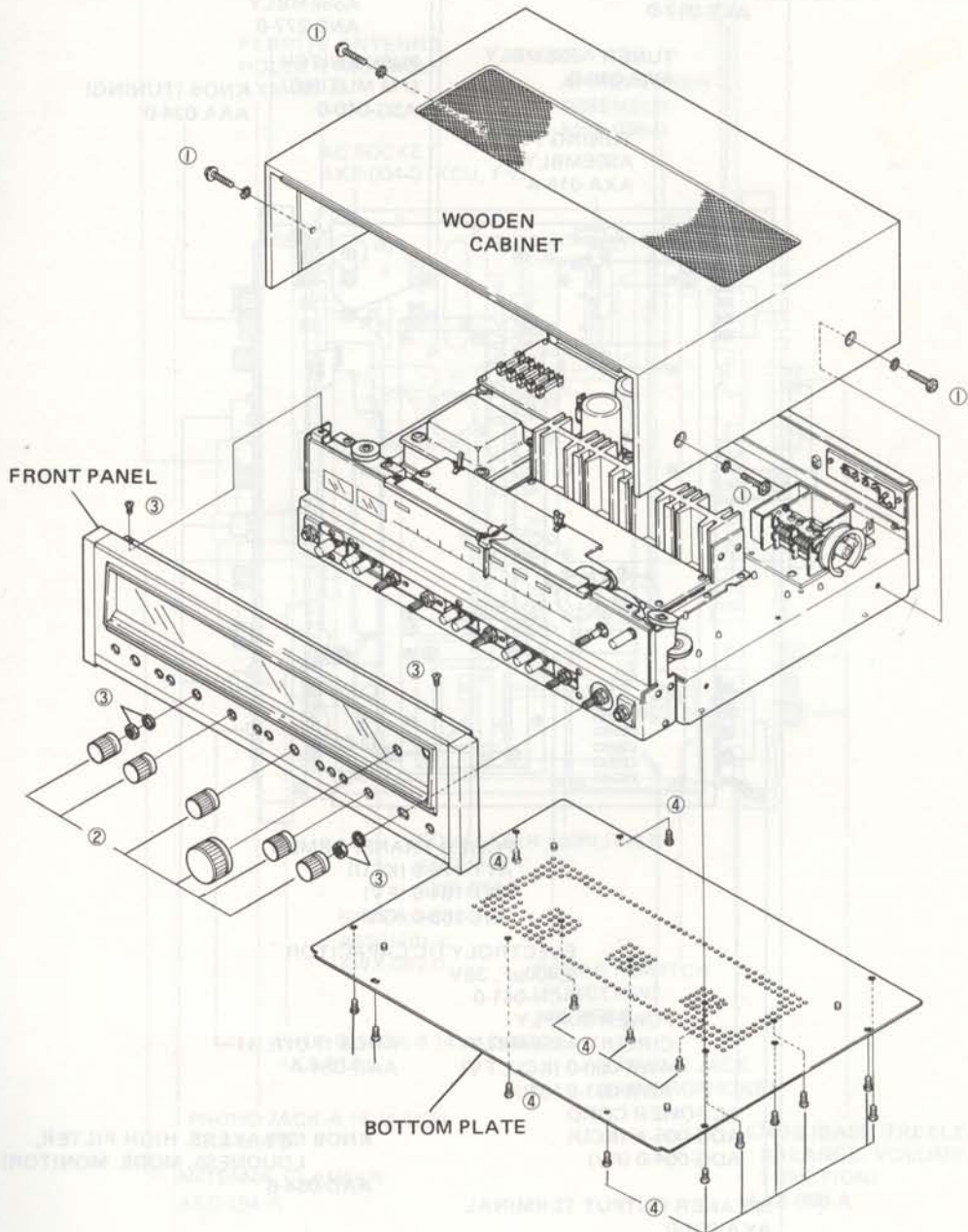

# 6. PARTS AND P.C. BOARD LOCATION

Top View

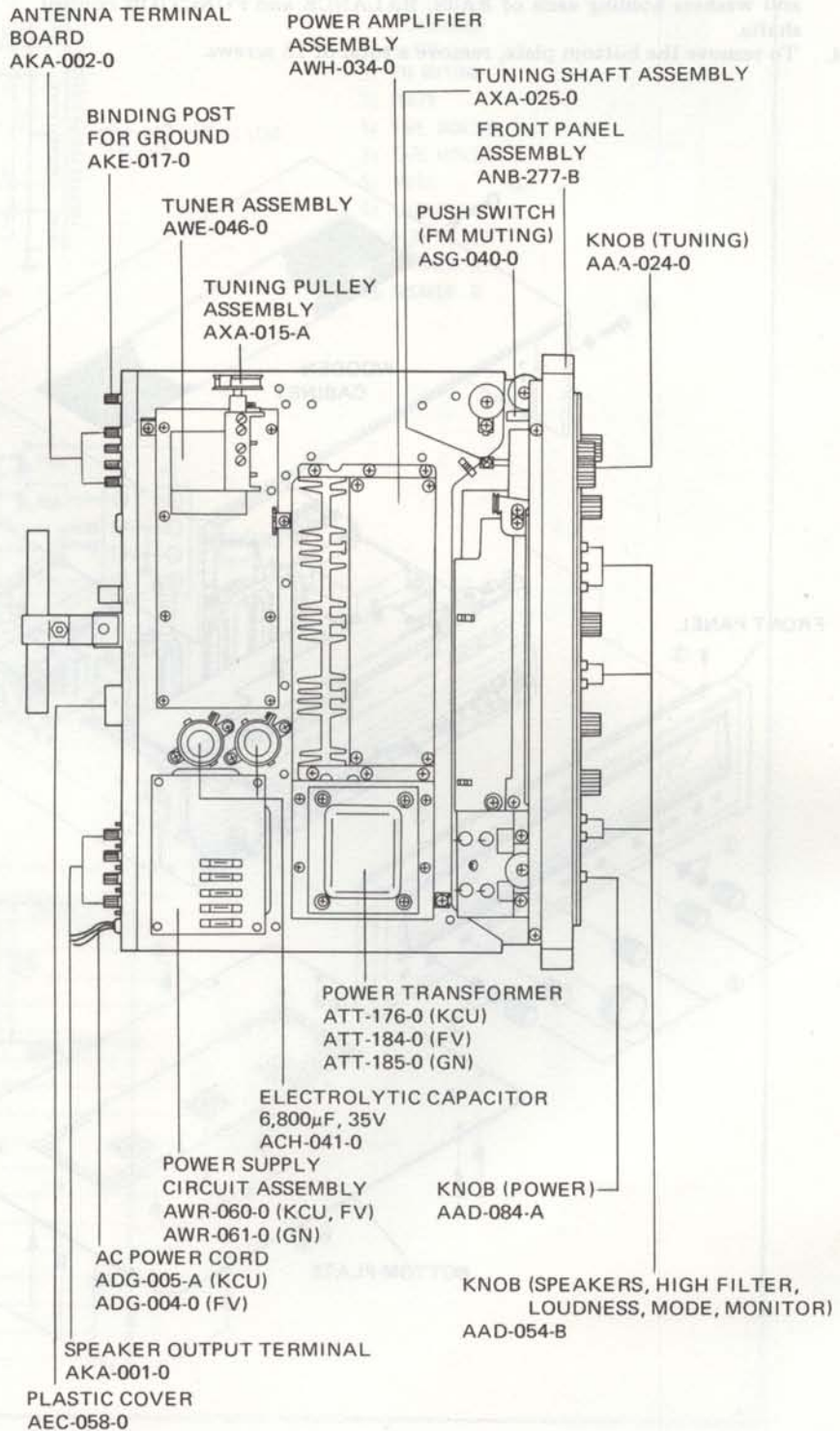

Bottom View

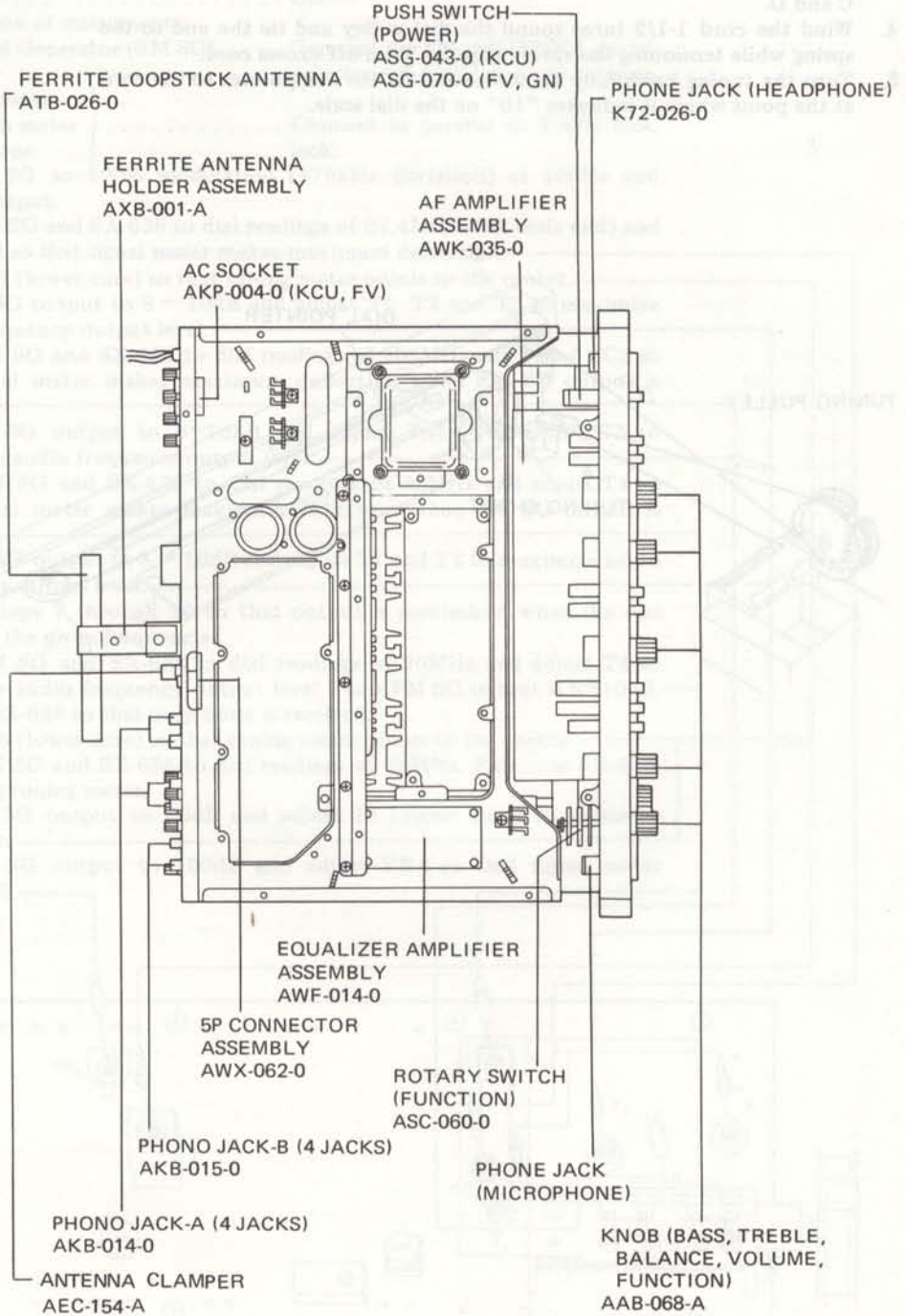

## 7. DIAL CORD STRINGING

1. Turn the tuning knob until the plates of the tuning capacitor are as far out as possible.
2. Fasten one end of the cord to the spring on the tuning pulley and lead it round pulley A.
3. Wind the cord 3 turns round the tuning shaft and run it round pulleys B, C and D.
4. Wind the cord 1-1/2 turns round the dial pulley and tie the end to the spring while tensioning the spring slightly. Trim off excess cord.
5. Turn the tuning knob fully clockwise and fix the dial pointer to the cord at the point where it indicates "10" on the dial scale.

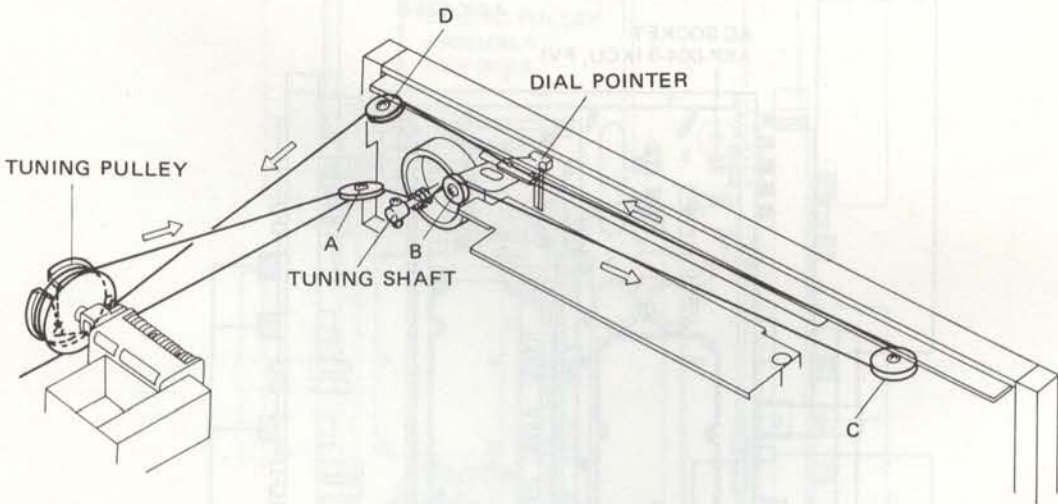

## 8. ADJUSTMENTS

### FM Section

1. Switch positions on the SX-636:  
 FUNCTION . . . . . FM  
 FM MUTING . . . . . OFF (pressed in)  
 POWER . . . . . ON
2. Connection of instruments:  
 FM Signal Generator (FM SG) . . . . . Connect to FM ANTENNA terminals through 300Ω dummy antenna.  
 AC Voltmeter }  
 Distortion meter } . . . . . Connect in parallel to TAPE REC  
 Oscilloscope } jack.
3. Set FM SG to 100% modulation ( $\pm 75\text{kHz}$  deviation) at 400Hz and 100dB output.
4. Tune FM SG and SX-636 to dial readings of 87.4MHz (left scale end) and adjust T3 so that signal meter makes maximum deflection.
5. Adjust T5 (lower core) so that tuning meter points to the center.
6. Set FM SG output to 8 ~ 10dB and adjust T1 T2 and T3 to maximize audio frequency output level.
7. Tune FM SG and SX-636 to dial readings of 106MHz and adjust TC3 so that signal meter makes maximum deflection when FM SG output is 100dB.
8. Set FM SG output to 8~10dB and adjust TC1, TC2 and TC3 to maximize audio frequency output level.
9. Tune FM SG and SX-636 to dial readings of 90MHz and adjust T4 so that signal meter makes maximum deflection when FM SG output is 100dB.
10. Set FM SG output to 8 ~ 10dB and adjust T1 and T2 to maximize audio frequency output level.
- Repeat steps 7 through 10 so that output is maximized when the dial indicates the given frequencies.
11. Tune FM SG and SX-636 to dial readings of 90MHz and adjust T4 to maximize audio frequency output level when FM SG output is 8~10dB.
12. Detune SX-636 so that only noise is received.
13. Adjust T5 (lower core) so that tuning meter points to the center.
14. Tune FM SG and SX-636 to dial readings of 98MHz. Fine tune SX-636, observing tuning meter.
15. Set FM SG output to 60dB and adjust T5 (upper core) to minimize distortion.
16. Set FM SG output to 100dB and adjust VR4 so that signal meter readings 5.

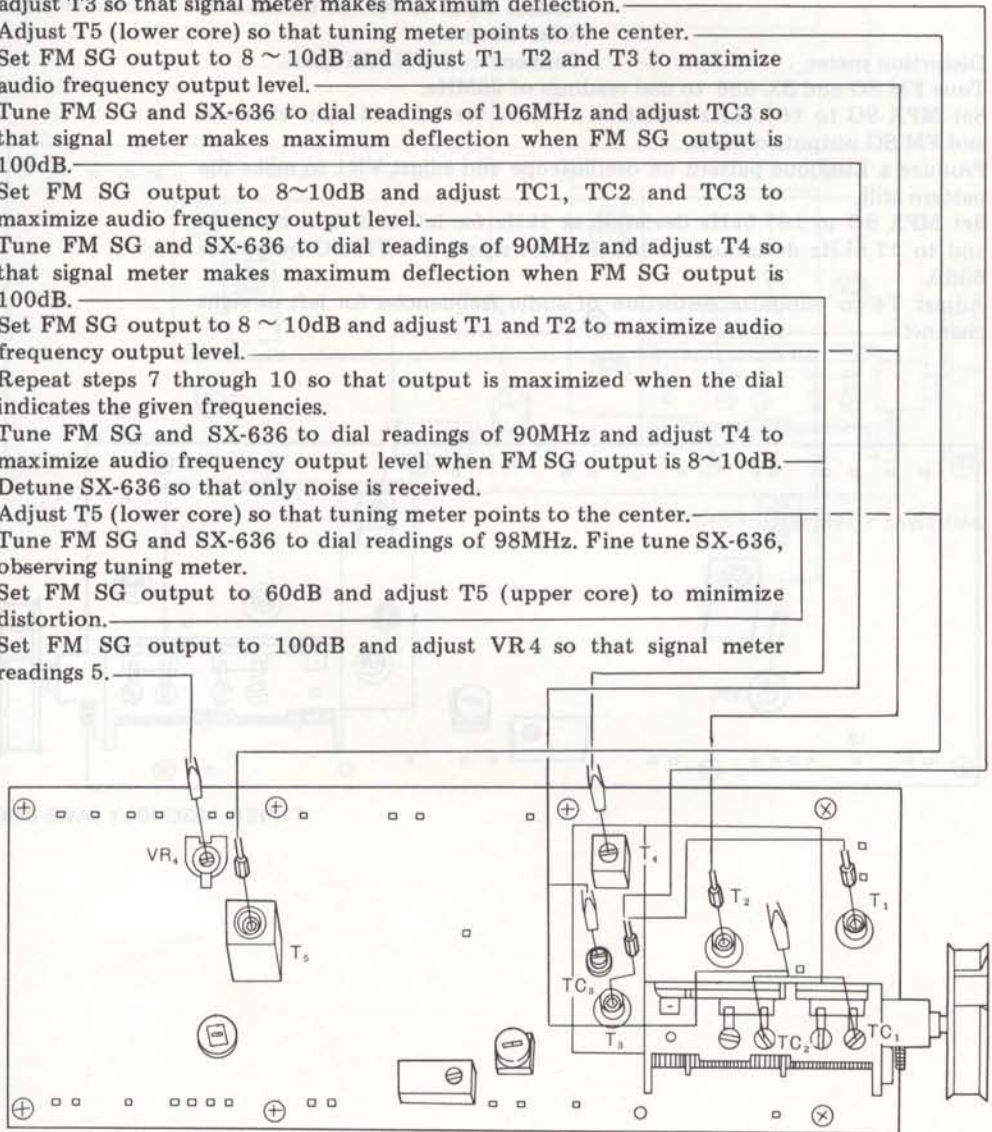

TUNER ASSEMBLY (AWE-046)



## FM MPX Section

- The SX-636 incorporates a PLL demodulator circuit. This adjustment should only be made when MPX IC has been replaced.
  - This adjustment should be made after completion of FM section adjustment.
1. Switch positions on the SX-636:  
 FUNCTION . . . . . FM  
 FM MUTING . . . . . OFF (pressed in)  
 POWER . . . . . ON
  2. Connection of instruments:  
 FM Signal Generator (FM SG) . . . . Connect to FM ANTENNA terminals through 300Ω dummy antenna.  
 MPX Signal Generator (MPX SG) . . . Connect to FM SG's external modulator terminals.  
 Oscilloscope . . . . . Connect horizontal input to MPX SG's PILOT OUT terminals and vertical input to No. 18 terminal of tuner assembly.  
 Distortion meter . . . . . Connect to TAPE REC jack.
  3. Tune FM SG and SX-636 to dial readings of 98MHz.
  4. Set MPX SG to ±67.5kHz deviation at 1kHz for left and right channels and FM SG output to 60dB.
  5. Produce a Lissajous pattern on oscilloscope and adjust VR1 to make the pattern still.
  6. Set MPX SG to ±67.5kHz deviation at 1kHz for left and right channels and to ±7.5kHz deviation for 19kHz pilot signal. Set FM SG output to 60dB.
  7. Adjust T4 to minimize distortion of audio frequencies for left or right channel.

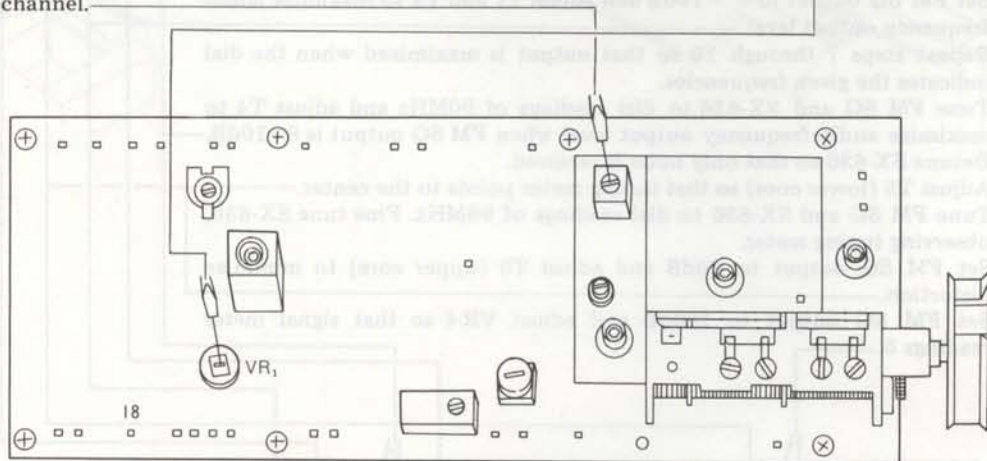

TUNER ASSEMBLY (AWE-046)

AM Section

1. Switch positions on the SX-636:  
 FUNCTION . . . . . AM  
 POWER . . . . . ON
2. Connection of instruments:  
 AM Signal Generator (AM SG) . . . . Connect to AM ANTENNA terminals in series with dummy antenna (1kΩ resistor).  
 AC Voltmeter . . . . . Connect to TAPE REC jack.
3. Set AM SG to 30% modulation at 400Hz and 30dB output.
4. Tune AM SG and SX-636 to dial readings of 600kHz and adjust T6 to maximize audio frequency output level. (Adjust core of ferrite loopstick antenna at the same time.)
5. Tune AM SG and SX-636 to dial readings of 1,400kHz and adjust TC4 and TC5 to maximize audio frequency output level.
- Repeat steps 4 and 5 so that output is maximized when the dial indicates these frequencies.

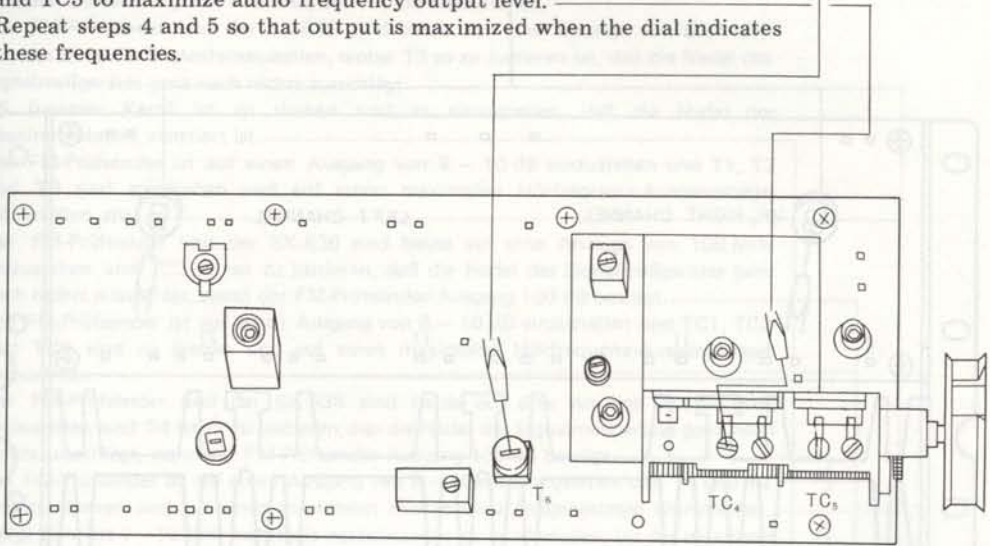

TUNER ASSEMBLY (AWE-046)

## Power Amplifier

- Do this adjustment when any of the transistors in the power amplifier has been replaced.
  - Terminal and VR numbers given first are for the left channel and those in brackets are for the right channel.
1. Switch positions on the SX-636:  
FUNCTION . . . . . AUX  
POWER . . . . . ON  
SPEAKER . . . . . A (A button pressed in)
  2. Connect  $8\Omega$  dummy load to SPEAKER A terminals. (Keep AUX jacks free.)
  3. Connect DC voltmeter between No. 21 (8) and No. 17 (11) terminals.
  4. Adjust VR1(VR2) so that voltmeter reads 20mV at 10 minutes after power is switched on.

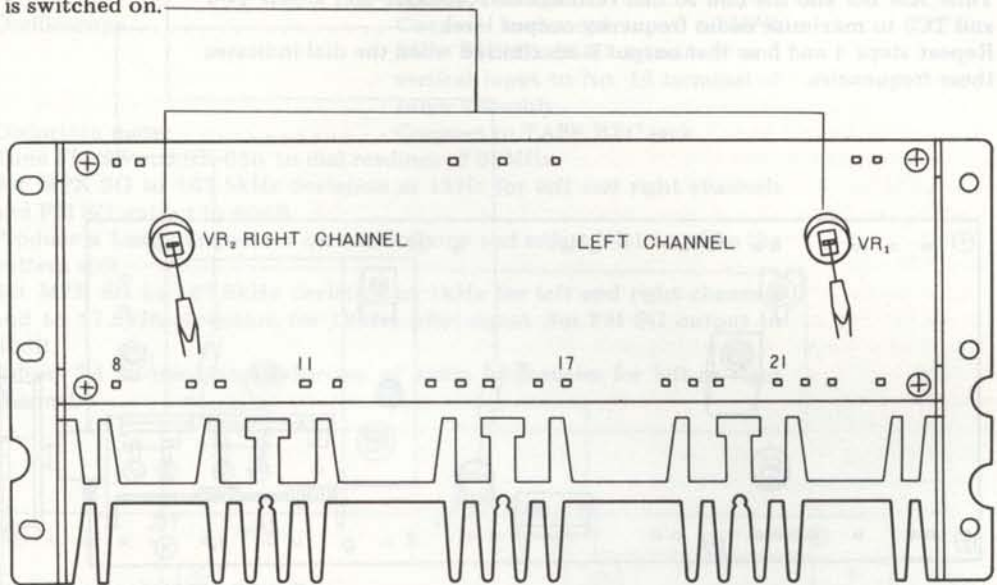

POWER AMPLIFIER ASSEMBLY (AWH-034)

9. PACKING METHOD AND PARTS NUMBERS

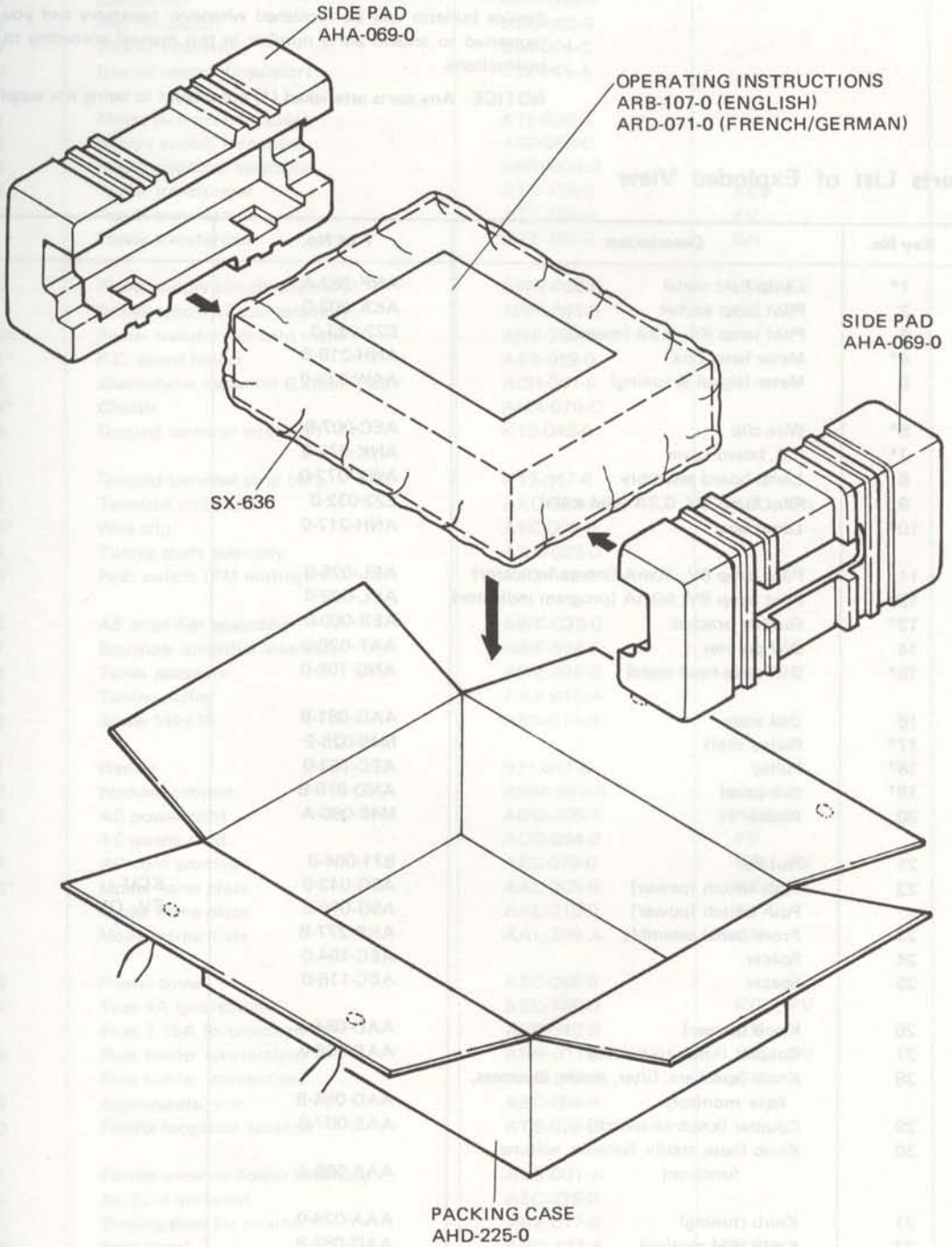

# 10. EXPLODED VIEW AND PARTS LIST

**NOTE:**

Parts number is subject to change for the purpose of improvement with notice of a service bulletin.

Service bulletin will be furnished whenever necessary and you are requested to amend parts number in this manual according to the instructions.

NOTICE: Any parts asterisked (\*) are subject to being not supplied.

## Parts List of Exploded View

Key No.	Description	Part No.	
1*	Lamp-held metal	ANF-262-A	
2	Pilot lamp socket	AKK-002-0	
3	Pilot lamp 8V, 0.3A (meter)	E22-032-0	
4*	Meter lamp box	ANH-219-B	
5	Meter (signal & tuning)	AAW-033-0	
6*	Wire clip	AEC-007-0	
7*	P.C. board cover	ANK-072-0	
8	Lamp board assembly	AWX-072-0	
9	Pilot lamp 8V, 0.3A (dial scale)	E22-032-0	
10*	Lamp box	ANH-217-0	
11	Pilot lamp 6V, 30mA (stereo indicator)	AEL-025-0	
12	Pilot lamp 8V, 50mA (program indicator)	AEL-022-0	
13*	Rubber bracket	AEB-060-0	
14	Dial pointer	AAF-020-0	
15*	Dial scale-head metal	ANG-105-0	
16	Dial scale	AAG-081-B	
17*	Pulley shaft	M49-025-E	
18*	Pulley	AEC-153-0	
19*	Sub-panel	AND-076-B	
20	Washer 1t	M45-086-A	
21	Nut 9φ	B71-004-0	
22	Push switch (power)	ASG-043-0	KCU FV, GN
	Push switch (power)	ASG-070-0	
23	Front panel assembly	ANB-277-B	
24	Spacer	AEC-164-0	
25	Spacer	AEC-116-0	
26	Knob (power)	AAD-084-A	
27	Coupler (knob-to-switch)	AAE-008-0	
28	Knob (speakers, filter, mode, loudness, tape monitor)	AAD-054-B	
29	Coupler (knob-to-switch)	AAE-007-0	
30	Knob (bass, treble, balance, volume, function)	AAB-068-A	
31	Knob (tuning)	AAA-024-0	
32	Knob (FM muting)	AAD-082-B	
33	Phone jack (headphone)	K72-026-0	
34*	Wire clip	AEC-004-0	
35*	Pulley (small)	AEC-101-0	

NOTICE: Any parts asterisked (\*) are subject to being not supplied.

Key No.	Description	Part No.	
36*	Pulley-held metal	ANG-107-A	
37	Special nut	ALA-008-0	
38	Nut (insulator)	AEC-085-0	
39	Washer (insulator)	E34-004-0	
40	Special washer (insulator)	E32-045-A	
41	Phone jack (microphone)	K72-020-0	
42	Rotary switch (function)	ASC-060-0	
43	Power amplifier assembly	AWH-034-0	
44	Power transformer	ATT-176-0	KCU
	Power transformer	ATT-184-0	FV
	Power transformer	ATT-185-0	GN
45	Power supply circuit assembly	AWR-060-0	KCU, FV
	Power supply circuit assembly	AWR-061-0	GN
46*	Power transformer-held metal	ANF-263-0	
47*	P.C. board holder	AEB-019-0	
48	Electrolytic capacitor 6,800 $\mu$ F, 35V	ACH-041-0	
49*	Chassis	ANA-070-C	
50	Ground terminal strip (2P)	K13-048-0	
51	Ground terminal strip (4P)	K13-047-0	
52	Terminal strip (2P)	AKC-023-A	KCU, GN
53*	Wire clip	AEC-005-0	
54	Tuning shaft assembly	AXA-025-0	
55	Push switch (FM muting)	ASG-040-0	
56	AF amplifier assembly	AWK-035-0	
57	Equalizer amplifier assembly	AWF-014-0	
58	Tuner assembly	AWE-046-0	
59	Tuning pulley	AXA-015-A	
60	Screw M4 x15	ABA-010-A	
61	Washer	B21-011-0	
62	Wooden cabinet	AMM-041-A	
63	AC power cord	ADG-005-A	KCU
	AC power cord	ADG-004-0	FV
64	AC cord grommet	AEC-079-0	KCU, FV
65*	Model name plate	AAL-208-0	KCU
	Model name plate	AAL-210-0	FV
	Model name plate	AAL-209-A	GN
66	Plastic cover	AEC-058-0	
67	Fuse 4A (protection)	AEK-100-0	KCU, FV
	Fuse 3.15A (protection)	AEK-042-0	GN
68	Fuse holder (protection)	AKR-011-0	KCU, FV
	Fuse holder (protection)	AKR-017-0	GN
69	Antenna clasper	AEC-154-A	
70	Ferrite loopstick antenna	ATB-026-0	
71	Ferrite antenna holder assembly	AXB-001-A	
72	AC cord grommet	AEC-079-0	
73	Binding post for ground	AKE-017-0	
74*	Rear panel	ANC-122-A	KCU
	Rear panel	ANC-123-A	FV
	Rear panel	ANC-124-A	GN
75	Speaker output terminal	AKA-001-0	

NOTICE: Any parts asterisked (\*) are subject to being not supplied.

Key No.	Description	Part No.	Qty Req
76	AC socket	AKP-004-0	KCU, FV
77	5P connector assembly	AWX-062-0	
78	Antenna terminal board	AKA-002-0	
79	Phono jack-A (4 jacks)	AKB-014-0	
80	Phono jack-B (4 jacks)	AKB-015-0	
81*	Pulley-held metal	ANG-106-A	
82*	Bottom plate	ANE-059-A	
83	Foot assembly	AEC-061-A	
84*	Reinforced metal	ANF-267-A	
85	Fuse holder (AC power)	AKR-001-0	FV
	Connector (AC power)	AKP-008-0	GN
86	Slide switch (de-emphasis)	ASH-008-0	FV
87	Knob spacer	AEC-152-0	
88	Bush	AEC-160-0	

Exploded View

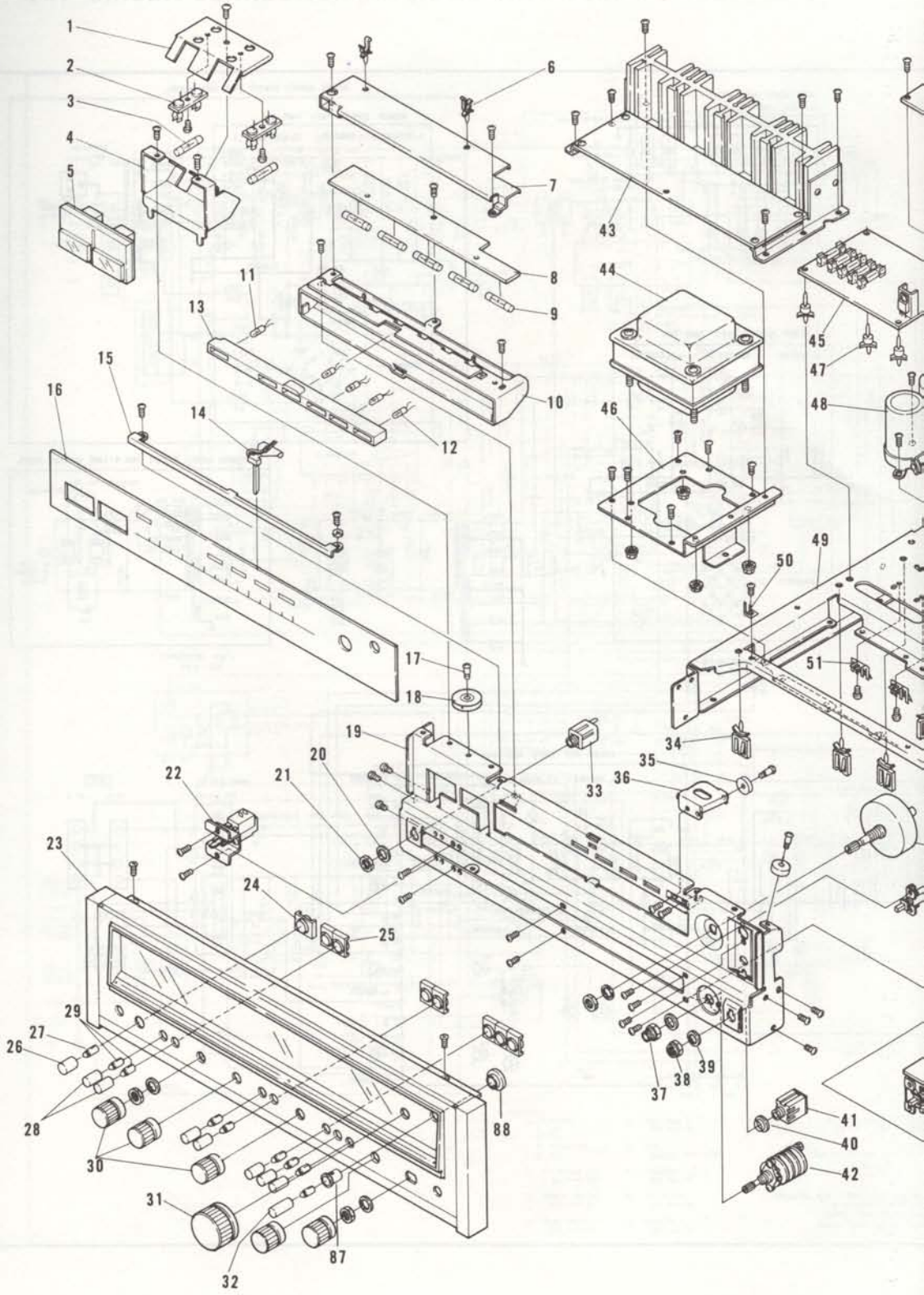



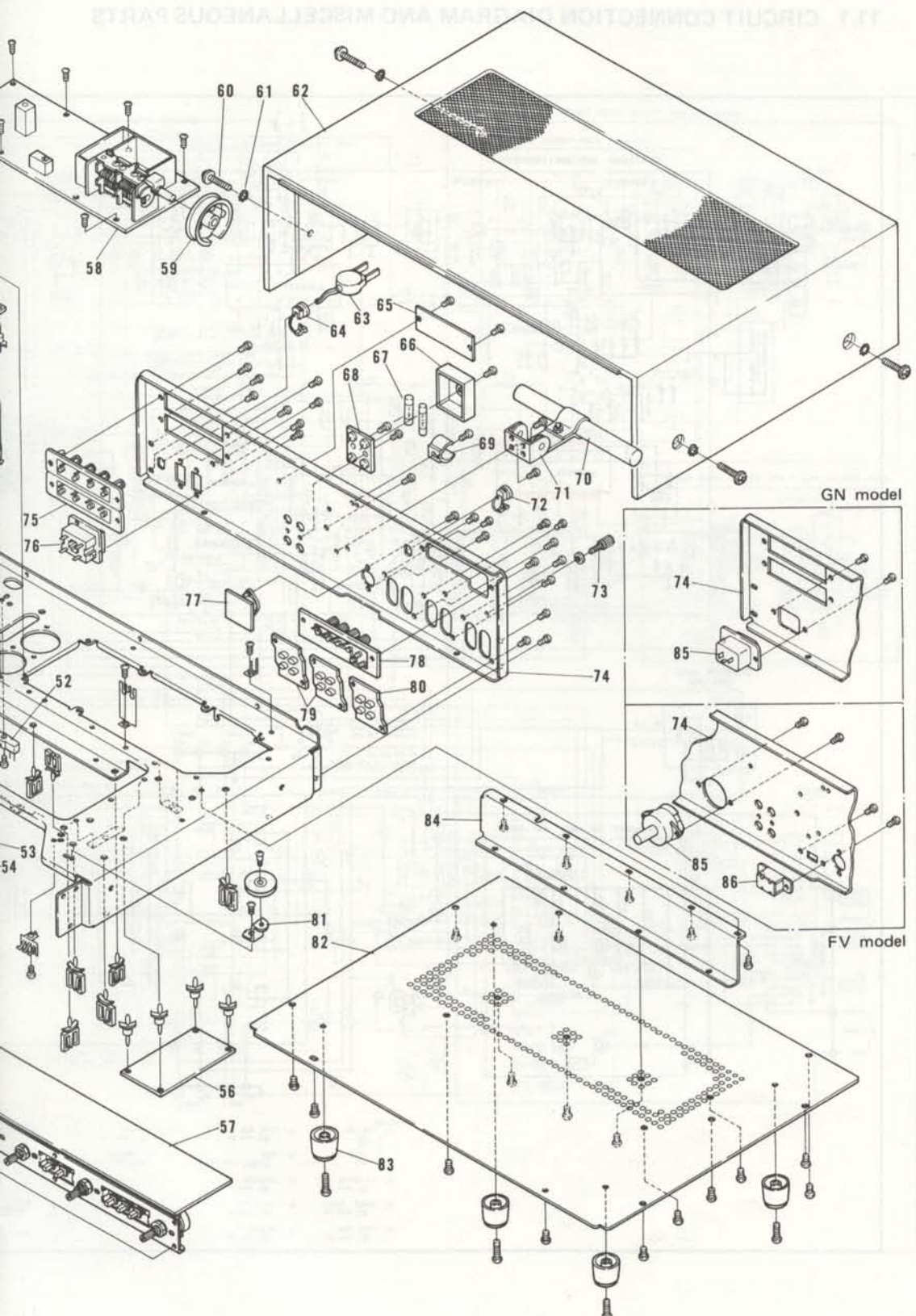

# 11. SCHEMATIC DIAGRAMS, P.C. BOARD PATTERNS A

## 11.1 CIRCUIT CONNECTION DIAGRAM AND MISCELLANEOUS PARTS

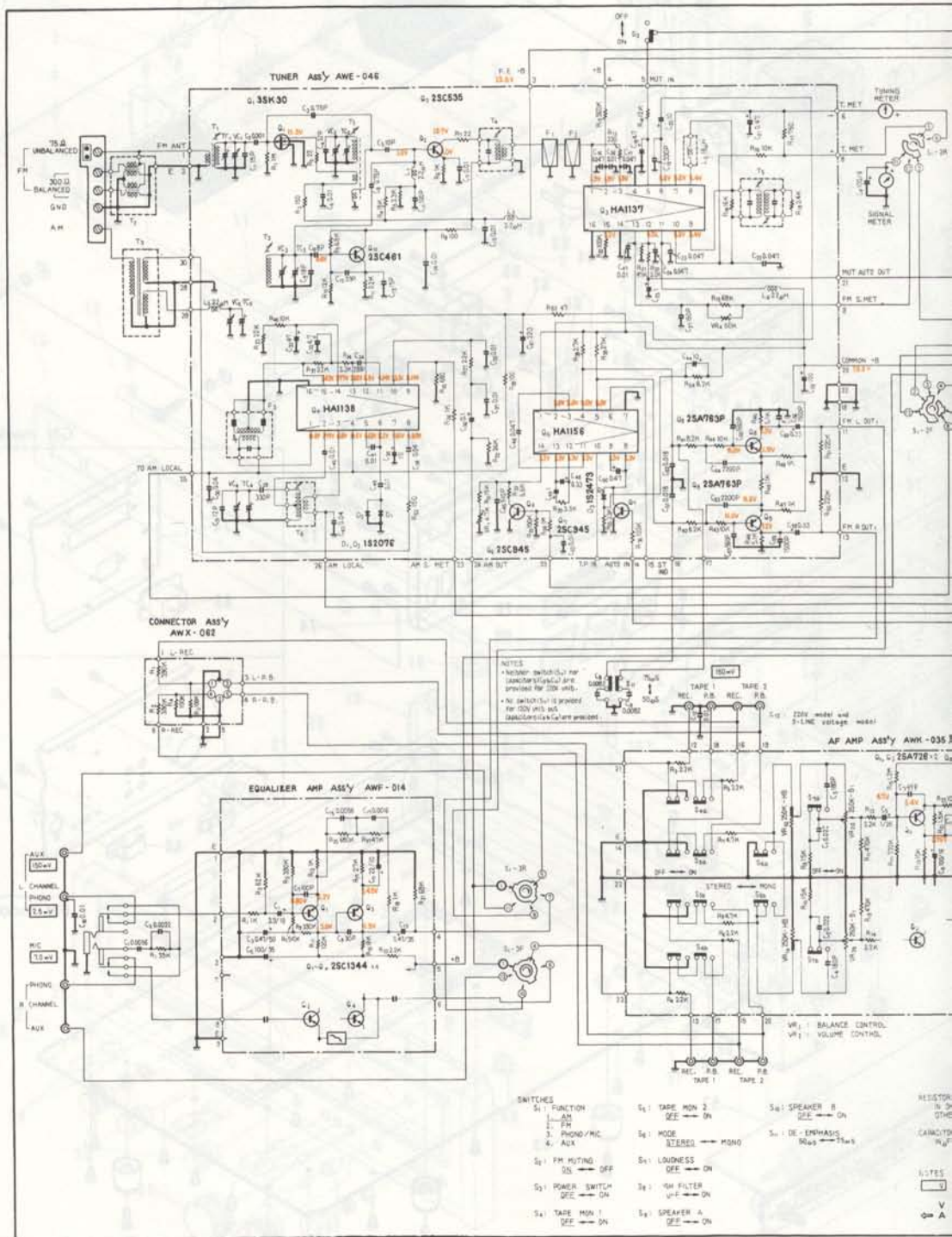

# D PARTS LIST

6X-838  
Explored View

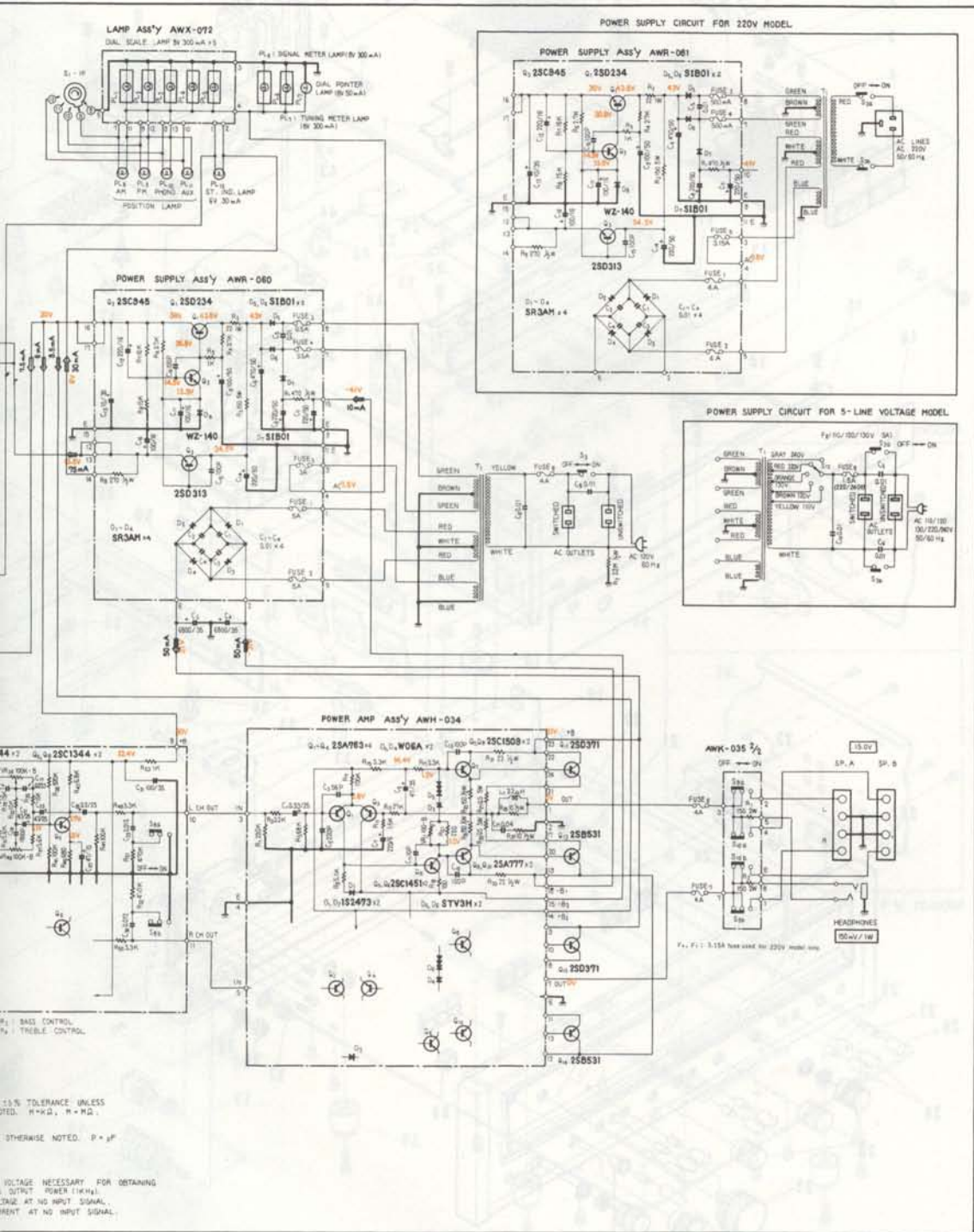

±1% TOLERANCE UNLESS NOTED. R = Ω, K = KΩ, M = MΩ.  
OTHERWISE NOTED. P = μF  
VOLTAGE NECESSARY FOR OBTAINING OUTPUT POWER (1KHz).  
GAIN AT NO INPUT SIGNAL.  
CURRENT AT NO INPUT SIGNAL.

Fig. 1-115A (continued for 220V model only)

**Miscellaneous Parts**

- CAPACITORS: IN  $\mu$ F UNLESS OTHERWISE NOTED p: pF
- RESISTORS: IN  $\Omega$ ,  $\frac{1}{4}$ W UNLESS OTHERWISE NOTED k: k $\Omega$ , M: M $\Omega$

**CAPACITORS**

Symbol	Description	Part No.	
C1	Mylar 0.0056 50V	CQMA 562K 50	
C2	Mylar 0.0022 50V	CQMA 222K 50	
C3	Electrolytic 6,800 35V	ACH-041-0	
C4	Electrolytic 6,800 35V	ACH-041-0	
C5	Ceramic 0.01 250V	ACG-001-0	KCU, FV
C6	Ceramic 0.01 250V	ACG-003-0	KCU
	Ceramic 0.01 250V	ACG-001-0	FV
C7	Ceramic 0.01 250V	ACG-001-0	FV
C8	Electrolytic 100 6V	CEA 101P 6	
C9	Mylar 0.0082 50V	CQMA 822J 50	KCU, FV
C10	Mylar 0.0082 50V	CQMA 822J 50	KCU, FV
C11	Ceramic 0.01 50V	CKDYF 103Z 50	
C12	Ceramic 0.01 50V	CKDYF 103Z 50	GN, FV

**RESISTORS**

Symbol	Description	Part No.	
R1	Carbon film 39k	RD $\frac{1}{4}$ PS 393J	
R2	Carbon film 2.2M $\frac{1}{4}$ W	RD $\frac{1}{4}$ PS 225J	

**SWITCHES**

Symbol	Description	Part No.	
S1	Rotary switch (function)	ASC-060-0	
S2	Push switch (FM muting)	ASG-040-0	
S3	Push switch (power)	ASG-043-0	KCU
	Push switch (power)	ASG-070-0	GN, FV
S11	Slide switch (de-emphasis)	ASH-008-0	FV

**TRANSFORMERS**

Symbol	Description	Part No.	
T1	Power transformer	ATT-176-0	KCU
	Power transformer	ATT-184-0	FV
	Power transformer	ATT-185-0	GN
T2	Balun	T22-025-A	
T3	Ferrite loopstick antenna	ATB-026-0	

**OTHERS**

Symbol	Description	Part No.	
	Tuner assembly	AWE-046-0	
	Equalizer amplifier assembly	AWF-014-0	
	AF amplifier assembly	AWK-035-0	
	Power amplifier assembly	AWH-034-0	
	Power supply circuit assembly	AWR-060-0	KCU, FV
	Power supply circuit assembly	AWR-061-0	GN

Continued on the Next Page

Symbol	Description	Part No.	
	5P connector assembly	AWX-062-0	
	Lamp board assembly	AWX-072-0	
	Front panel assembly	ANB-277-B	
	Foot assembly	AEC-061-A	
	Wooden cabinet	AMM-041-A	
	Tuning shaft assembly	AXA-025-0	
	Tuning pulley	AXA-015-A	
	Knob (tuning)	AAA-024-0	
	Knob (bass, treble, balance, volume, function)	AAB-068-A	
	Knob (speakers, filter, mode, loudness, tape monitor)	AAD-054-B	
	Knob (FM muting)	AAD-082-B	
	Knob (power)	AAD-084-A	
	Dial scale	AAG-081-B	
	Meter (signal & tuning)	AAW-033-0	
	Coupler (knob-to-switch)	AAE-007-0	
	Coupler (knob-to-switch)	AAE-008-0	
	Antenna terminal board	AKA-002-0	
	Phono jack-A (4 jacks)	AKB-014-0	
	Phono jack-B (4 jacks)	AKB-015-0	
	Speaker output terminal	AKA-001-0	
F1	Fuse 5A (protection)	AEK-108-0	KCU, FV
	Fuse 4A (protection)	AEK-400-0	GN
F2	Fuse 5A (protection)	AEK-108-0	KCU, FV
	Fuse 4A (protection)	AEK-400-0	GN
F3	Fuse 0.5A (protection)	AEK-107-0	KCU, FV
	Fuse 500mA (protection)	AEK-014-0	GN
F4	Fuse 0.5A (protection)	AEK-107-0	KCU, FV
	Fuse 500mA (protection)	AEK-014-0	GN
F5	Fuse 3A (protection)	AEK-101-0	KCU, FV
	Fuse 3.15A (protection)	AEK-042-0	GN
F6	Fuse 4A (protection)	AEK-100-0	KCU, FV
	Fuse 3.15A (protection)	AEK-042-0	GN
F7	Fuse 4A (protection)	AEK-100-0	KCU, FV
	Fuse 3.15A (protection)	AEK-042-0	GN
F8	Fuse 4A (protection)	AEK-202-0	KCU
	Fuse 1.5A (AC power)	AEK-108-0	FV
	Pilot lamp 6V, 30mA (stereo indicator)	AEL-025-0	
	Pilot lamp 8V, 50mA (program indicator)	AEL-022-0	
	Phone jack (microphone)	K72-020-0	
	Phone jack (headphone)	K72-026-0	
	Pilot lamp socket	AKK-002-0	
	AC socket	AKP-004-0	KCU, FV
	Fuse holder (AC power)	AKR-001-0	FV
	Connector (AC power)	AKP-008-0	GN
	Fuse holder (protection)	AKR-011-0	KCU, FV
	Fuse holder (protection)	AKR-017-0	GN

Symbol	Description	Part No.	
	Ferrite antenna holder assembly	AXB-001-A	
	Plastic cover	AEC-058-0	
	Screw M4x15	ABA-010-A	
	Washer	B21-011-0	
	Binding post for ground	AKE-017-0	
	AC power cord	ADG-005-A	KCU
	AC power cord	ADG-004-0	FV
	FM T-type antenna	ADH-002-0	
	Operating instructions (English)	ARB-107-0	
	Operating instructions (French/German)	ARD-071-0	GN, FV
	Packing case	AHD-225-0	
	Side pad	AHA-069-0	

# 11.2 TUNER ASSEMBLY (AWE-046-0)

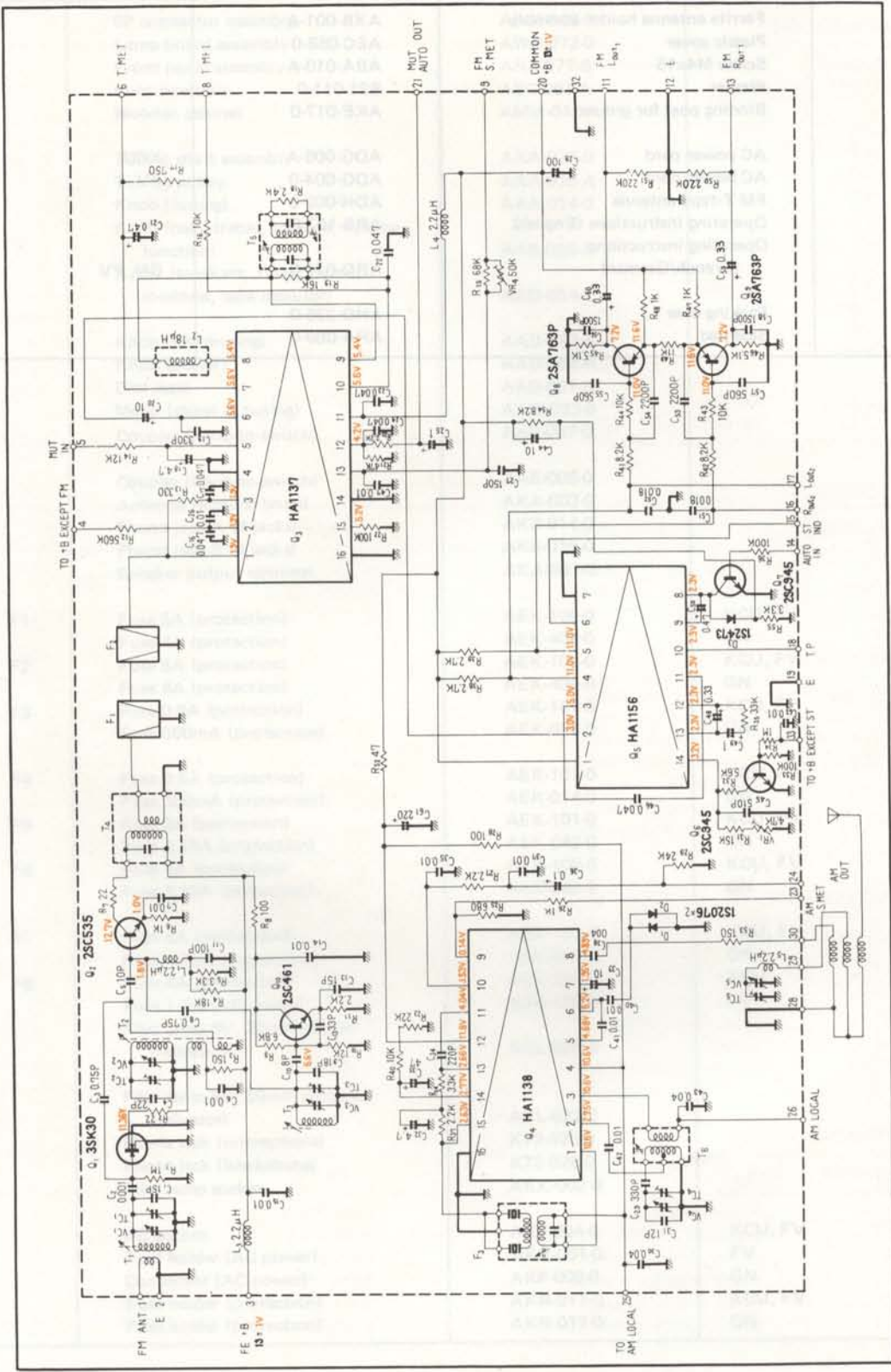

2SC535

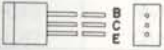

2SC461

2SC945

2SA763P



3SK30

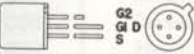

HA1156

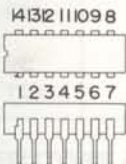

HA1137

HA1138

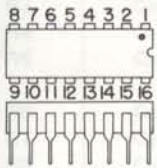

2SA725



Foil Side (AWE-046-0)

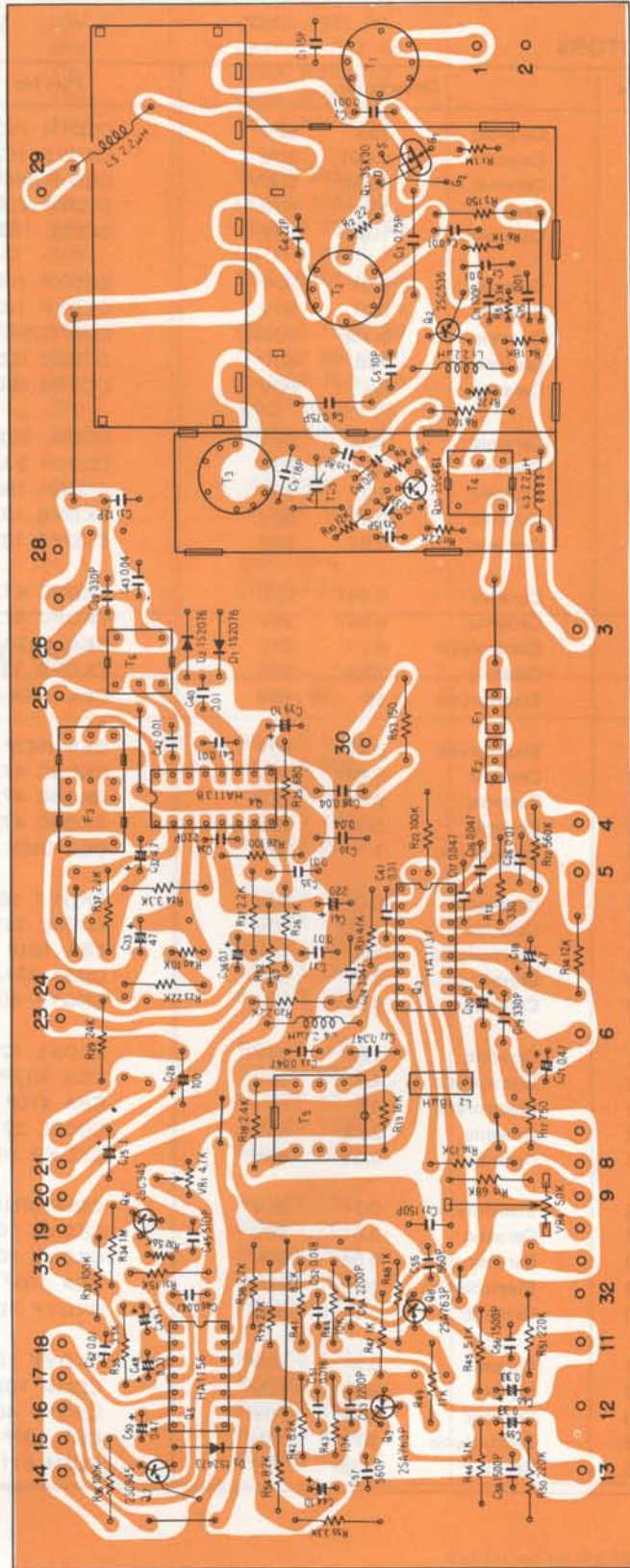



# Parts List of Tuner Assembly (AWE-046-0)

## CAPACITORS

Symbol	Description			Part No.
C1	Ceramic	15p	50V	CCDTH 150K 50
C2	Ceramic	0.001	50V	CKDYB 102K 50
C3	Ceramic	0.75p	500V	CGB R75K 500
C4	Ceramic	22p	50V	CCDTH 220K 50
C5	Ceramic	10p	50V	CCDSL 100F 50
C6	Ceramic	0.01	50V	CKDYF 103Z 50
C7	Ceramic	0.01	50V	CKDYF 103Z 50
C8	Ceramic	0.75p	500V	CGB R75K 500
C9	Ceramic	18p	50V	CCDSH 180K 50
C10	Ceramic	8p	50V	CCDTH 080F 50
C11	Ceramic	100p	50V	CCDSL 101K 50
C12	Ceramic	33p	50V	CCDCH 330K 50
C13	Ceramic	15p	50V	CCDCH 150K 50
C14	Ceramic	0.01	50V	CKDYB 103K 50
C15	Ceramic	0.01	50V	CKDYF 103Z 50
C16	Ceramic	0.047	25V	CKDBC 473Z 25
C17	Ceramic	0.047	25V	CKDBC 473Z 25
C18	Electrolytic	4.7	25V	CEA 4R7P 25
C19	Ceramic	330p	50V	CKDYB 331K 50
C20	Electrolytic	10	16V	CEA 100P 16
C21	Electrolytic	0.47	50V	CEA R47P 50
C22	Ceramic	0.047	25V	CKDBC 473Z 25
C23	Ceramic	0.047	25V	CKDBC 473Z 25
C24	Ceramic	0.047	25V	CKDBC 473Z 25
C25	Electrolytic	1	50V	CEA 010P 50
C26	Ceramic	0.01	50V	CKDYF 103Z 50
C27	Ceramic	150p	50V	CCDSL 151K 50
C28	Electrolytic	100	16V	CEA 101P 16
C29	Styrol	330P	50V	CQSA 331J 50
C30	Ceramic	0.04	50V	CKDYF 403Z 50
C31	Ceramic	12p	50V	CCDXL 120K 50
C32	Electrolytic	4.7	25V	CEA 4R7P 25
C33	Electrolytic	47	6V	CEA 470P 6
C34	Ceramic	220p	50V	CCDSL 221K 50
C35	Ceramic	0.01	50V	CKDYB 103K 50
C36	Electrolytic	0.1	25V	CSSA 0R1M 25
C37	Ceramic	0.01	50V	CKDYB 103K 50
C38	Ceramic	0.04	50V	CKDYF 403Z 50
C39	Electrolytic	10	16V	CEA 100P 16
C40	Ceramic	0.01	50V	CKDYF 103Z 50
C41	Ceramic	0.01	50V	CKDYF 103Z 50
C42	Mylar	0.01	50V	CQMA 103K 50
C43	Ceramic	0.04	50V	CKDYF 403Z 50
C44	Electrolytic	10	16V	CEA 100P 16
C45	Styrol	510p	50V	CQSH 511J 50

Symbol	Description	Part No.
C46	Mylar 0.047 50V	CQMA 473J 50
C47	Ceramic 0.01 50V	CKDYF 103Z 50
C48	Electrolytic 0.33 10V	CSSA R33M 10
C49	Electrolytic 1 10V	CSSA 010M 10
C50	Electrolytic 0.47 10V	CSSA R47M 10
C51	Mylar 0.018 50V	CQMA 183J 50
C52	Mylar 0.018 50V	CQMA 183J 50
C53	Ceramic 0.0022 50V	CKDYB 222K 50
C54	Ceramic 0.0022 50V	CKDYB 222K 50
C55	Ceramic 560p 50V	CKDYB 561K 50
C56	Ceramic 0.0015 50V	CKDYB 152K 50
C57	Ceramic 560p 50V	CKDYB 561K 50
C58	Ceramic 0.0015 50V	CKDYB 152K 50
C59	Electrolytic 0.33 25V	CSSA R33M 25
C60	Electrolytic 0.33 25V	CSSA R33M 25
C61	Electrolytic 220 16V	CEA 221P 16
C62	Ceramic 0.01 50V	CKDYF 103Z 50
VC	Tuning capacitor	ACK-012-0
TC3	Ceramic trimmer	C43-007-A

RESISTORS AND POTENTIOMETERS

Symbol	Description	Part No.
R1	Carbon film 1M	RD%VS 105J
R2	Carbon film 22	RD%VS 220J
R3	Carbon film 150	RD%VS 151J
R4	Carbon film 18k	RD%VS 183J
R5	Carbon film 3.3k	RD%VS 332J
R6	Carbon film 1k	RD%VS 102J
R7	Carbon film 22	RD%VS 220J
R8	Carbon film 100	RD%VS 101J
R9	Carbon film 6.8k	RD%VS 682J
R10	Carbon film 12k	RD%VS 123J
R11	Carbon film 2.2k	RD%VS 222J
R12	Carbon film 560k	RD%PS 564J
R13	Carbon film 330	RD%PS 331J
R14	Carbon film 12k	RD%PS 123J
R15	Carbon film 68k	RD%PS 683J
R16	Carbon film 10k	RD%PS 103J
R17	Carbon film 750	RD%PS 751J
R18	Carbon film 2.4k	RD%PS 242J
R19	Carbon film 16k	RD%PS 163J
R20	Carbon film 2.2k	RD%PS 222J
R21	Carbon film 47k	RD%PS 473J
R22	Carbon film 100k	RD%PS 104J
R23	Carbon film 22k	RD%PS 223J
R24	Carbon film 3.3k	RD%PS 332J
R25	Carbon film 680	RD%PS 681J

Continued on the Next Page

Symbol	Description	Part No.
R26	Carbon film 1k	RD%PS 102J
R27	Carbon film 2.2k	RD%PS 222J
R28	Carbon film 100	RD%PS 101J
R29	Carbon film 24k	RD%PS 243J
R30		
R31	Carbon film 15k	RD%PS 153J
R32	Carbon film 5.6k	RD%VS 562J
R33	Carbon film 100k	RD%PS 104J
R34	Carbon film 1M	RD%PS 105J
R35	Carbon film 3.3k	RD%PS 332J
R36	Carbon film 100k	RD%PS 104J
R37	Carbon film 2.2k	RD%PS 222J
R38	Carbon film 2.7k	RD%PS 272J
R39	Carbon film 2.7k	RD%PS 272J
R40	Carbon film 10k	RD%PS 103J
R41	Carbon film 8.2k	RD%PS 822J
R42	Carbon film 8.2k	RD%PS 822J
R43	Carbon film 10k	RD%PS 103J
R44	Carbon film 10k	RD%PS 103J
R45	Carbon film 5.1k	RD%PS 512J
R46	Carbon film 5.1k	RD%PS 512J
R47	Carbon film 1k	RD%PS 102J
R48	Carbon film 1k	RD%PS 102J
R49	Carbon film 11k	RD%PS 113J
R50	Carbon film 220k	RD%PS 224J
R51	Carbon film 220k	RD%PS 224J
R52	Carbon film 47	RD%PS 470J
R53	Carbon film 150	RD%PS 151J
R54	Carbon film 8.2k	RD%PS 822J
R55	Carbon film 3.3k	RD%PS 332J
VR1	Variable resistor, semi-fixed 4.7k-B	C92-051-0
VR4	Variable resistor, semi-fixed 50k-B	ACP-043-0

**SEMICONDUCTORS**

Symbol	Description	Part No.
Q1	FET 3SK30-B	
Q2	Transistor 2SC535-A or B	
Q3	IC HA1137	
Q4	IC HA1138	
Q5	IC HA1156	
Q6	Transistor 2SC945-Q or R	
Q7	Transistor 2SC945-Q or R	
Q8	Transistor 2SA763P-5 or 6 (2SA725-F or G)	
Q9	Transistor 2SA763P-5 or 6 (2SA725-F or G)	
Q10	Transistor 2SC461-B	
D1	Diode 1S2076	
D2	Diode 1S2076	
D3	Diode 1S2473	

TRANSFORMERS, COILS AND FILTERS

Symbol	Description	Part No.
T1	FM antenna coil	ATC-023-0
T2	FM RF coil	ATC-024-0
T3	FM OSC coil	ATC-025-0
T4	FM matching transformer	ATE-008-0
T5	FM IF transformer	T73-035-A
T6	AM OSC coil	ATB-013-0
F1	FM ceramic filter	ATF-013-B
F2	FM ceramic filter	ATF-013-B
F3	AM ceramic filter	ATF-009-0
L1	RF choke coil	T24-028-A
L2	Choke coil	ATH-007-0
L3	RF choke coil	T24-028-A
L4	RF choke coil	T24-028-A
L5	RF choke coil	T24-028-A

## 11.3 EQUALIZER AMPLIFIER ASSEMBLY (AWF-014-0)

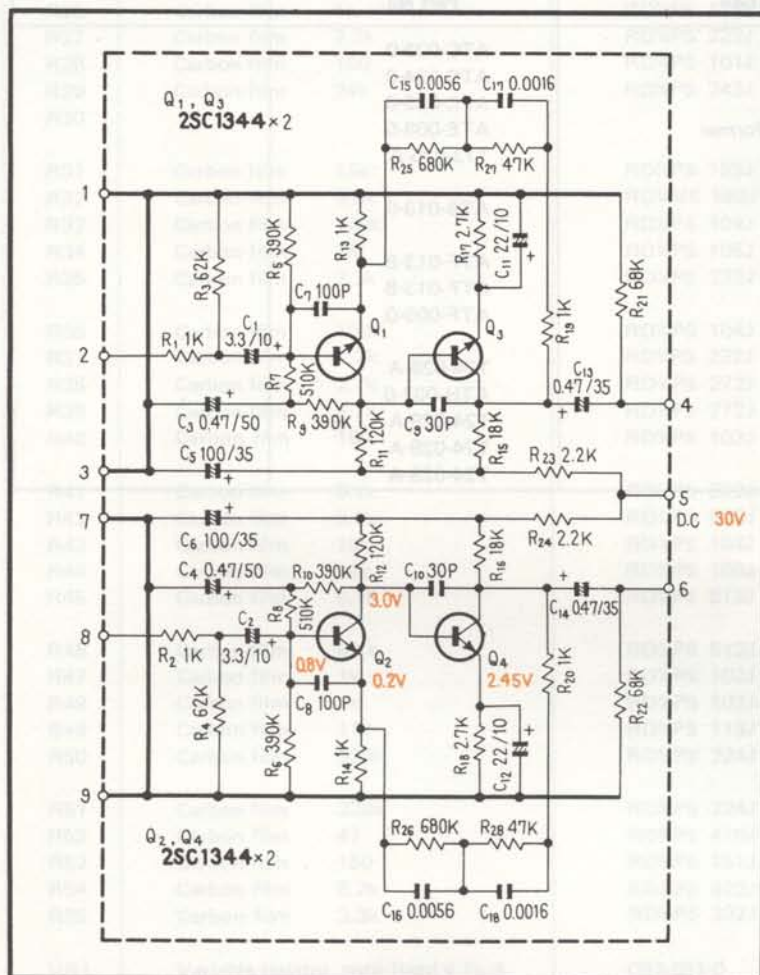

2SC1344



2SC1312

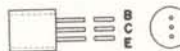

## Foil Side (AWF-014-0)

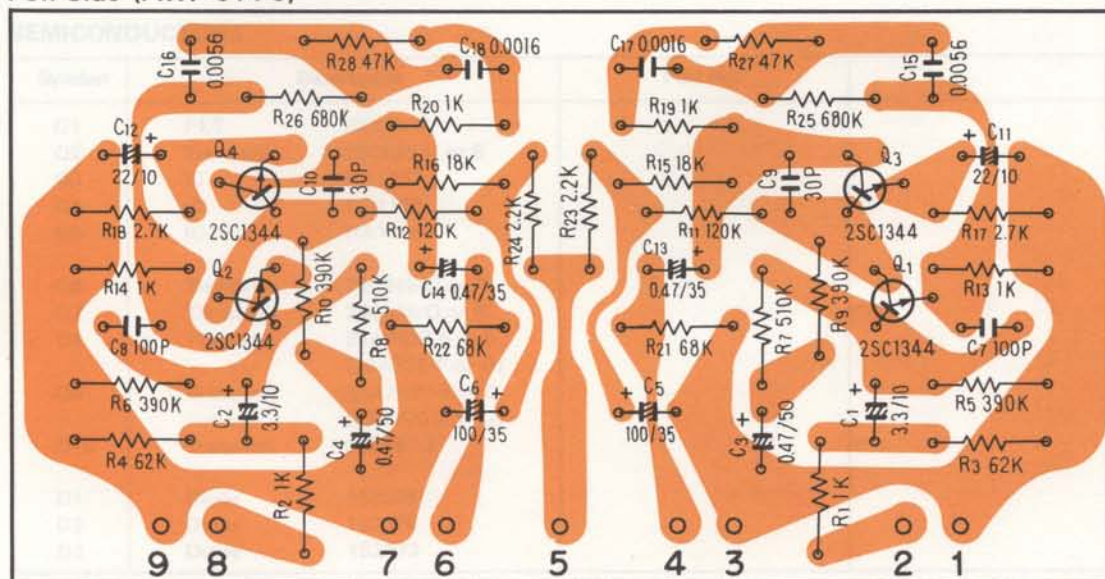

Parts List of Equalizer Amplifier Assembly (AWF-014-0)

CAPACITORS

Symbol	Description			Part No.
C1	Electrolytic	3.3	10V	CSZA 3R3M 10
C2	Electrolytic	3.3	10V	CSZA 3R3M 10
C3	Electrolytic	0.47	50V	CEA R47P 50
C4	Electrolytic	0.47	50V	CEA R47P 50
C5	Electrolytic	100	35V	CEA 101P 35
C6	Electrolytic	100	35V	CEA 101P 35
C7	Ceramic	100p	50V	CCDSL 101K 50
C8	Ceramic	100p	50V	CCDSL 101K 50
C9	Ceramic	30p	50V	CCDSL 300K 50
C10	Ceramic	30p	50V	CCDSL 300K 50
C11	Electrolytic	22	10V	CEA 220P 10
C12	Electrolytic	22	10V	CEA 220P 10
C13	Electrolytic	0.47	35V	CSZA R47M 35
C14	Electrolytic	0.47	35V	CSZA R47M 35
C15	Styrol	0.0056	50V	CQSA 562J 50
C16	Styrol	0.0056	50V	CQSA 562J 50
C17	Styrol	0.0016	50V	CQSA 162J 50
C18	Styrol	0.0016	50V	CQSA 162J 50

RESISTORS

Symbol	Description			Part No.
R1	Carbon film	1k		RD $\frac{1}{4}$ PM 102J
R2	Carbon film	1k		RD $\frac{1}{4}$ PM 102J
R3	Carbon film	62k		RD $\frac{1}{4}$ PM 623J
R4	Carbon film	62k		RD $\frac{1}{4}$ PM 623J
R5	Carbon film	390k		RD $\frac{1}{4}$ PM 394J
R6	Carbon film	390k		RD $\frac{1}{4}$ PM 394J
R7	Carbon film	510k		RD $\frac{1}{4}$ PM 514J
R8	Carbon film	510k		RD $\frac{1}{4}$ PM 514J
R9	Carbon film	390k		RD $\frac{1}{4}$ PM 394J
R10	Carbon film	390k		RD $\frac{1}{4}$ PM 394J
R11	Carbon film	120k		RD $\frac{1}{4}$ PM 124J
R12	Carbon film	120k		RD $\frac{1}{4}$ PM 124J
R13	Carbon film	1k		RD $\frac{1}{4}$ PM 102J
R14	Carbon film	1k		RD $\frac{1}{4}$ PM 102J
R15	Carbon film	18k		RD $\frac{1}{4}$ PM 183J
R16	Carbon film	18k		RD $\frac{1}{4}$ PM 183J
R17	Carbon film	2.7k		RD $\frac{1}{4}$ PM 272J
R18	Carbon film	2.7k		RD $\frac{1}{4}$ PM 272J
R19	Carbon film	1k		RD $\frac{1}{4}$ PM 102J
R20	Carbon film	1k		RD $\frac{1}{4}$ PM 102J
R21	Carbon film	68k		RD $\frac{1}{4}$ PM 683J
R22	Carbon film	68k		RD $\frac{1}{4}$ PM 683J
R23	Carbon film	2.2k		RD $\frac{1}{4}$ PM 222J
R24	Carbon film	2.2k		RD $\frac{1}{4}$ PM 222J
R25	Carbon film	680k		RD $\frac{1}{4}$ PM 684J

Continued on the Next Page

Symbol	Description	Part No.
R26	Carbon film 680k	RD4PM 684J
R27	Carbon film 47k	RD4PM 473J
R28	Carbon film 47k	RD4PM 473J

**SEMICONDUCTORS**

Symbol	Description	Part No.
Q1	Transistor 2SC1344-E or O (2SC1312-G or F)	
Q2	Transistor 2SC1344-E or O (2SC1312-G or F)	
Q3	Transistor 2SC1344-E or O (2SC1312-G or F)	
Q4	Transistor 2SC1344-E or O (2SC1312-G or F)	

# 11.4 AF AMPLIFIER ASSEMBLY (AWK-035-0)

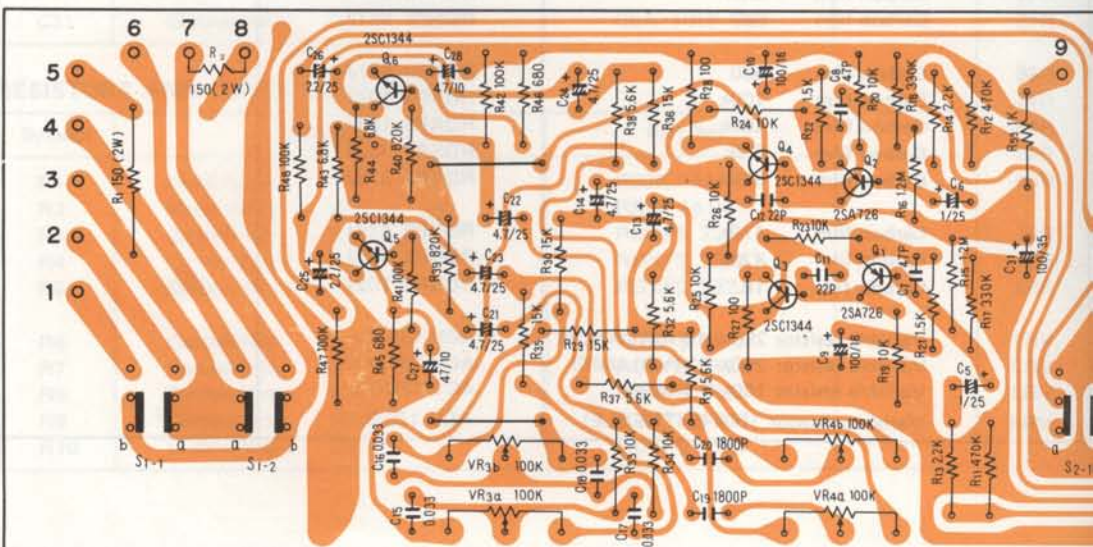
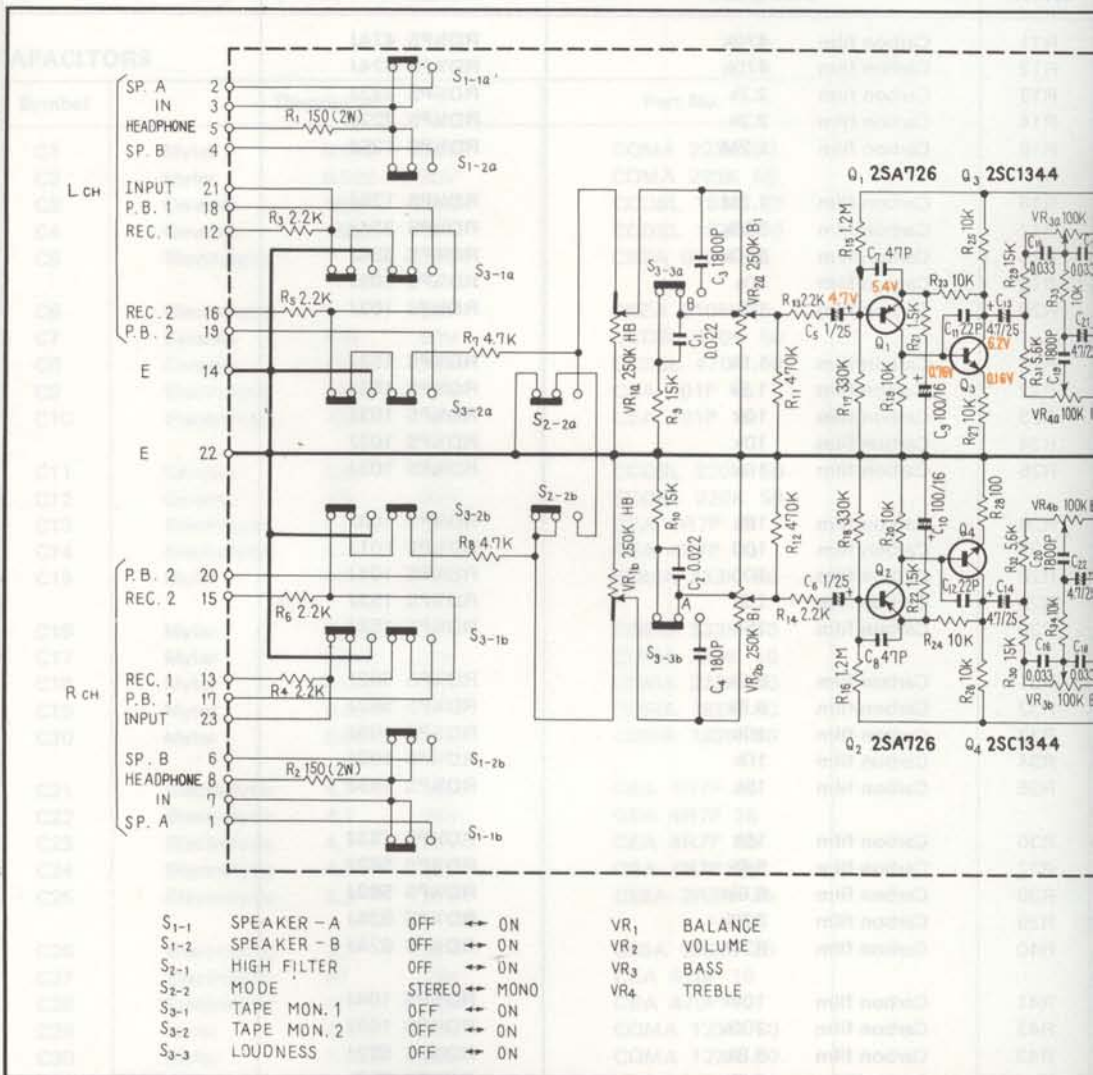



## Parts List of AF Amplifier Assembly (AWK-035-0)

### CAPACITORS

Symbol	Description			Part No.
C1	Mylar	0.022	50V	CQMA 223K 50
C2	Mylar	0.022	50V	CQMA 223K 50
C3	Ceramic	180p	50V	CCDSL 181K 50
C4	Ceramic	180p	50V	CCDSL 181K 50
C5	Electrolytic	1	25V	CSZA 010M 25
C6	Electrolytic	1	25V	CSZA 010M 25
C7	Ceramic	47p	50V	CCDSL 470K 50
C8	Ceramic	47p	50V	CCDSL 470K 50
C9	Electrolytic	100	16V	CEA 101P 16
C10	Electrolytic	100	16V	CEA 101P 16
C11	Ceramic	22p	50V	CCDSL 220K 50
C12	Ceramic	22p	50V	CCDSL 220K 50
C13	Electrolytic	4.7	25V	CEA 4R7P 25
C14	Electrolytic	4.7	25V	CEA 4R7P 25
C15	Mylar	0.033	50V	CQMA 333K 50
C16	Mylar	0.033	50V	CQMA 333K 50
C17	Mylar	0.033	50V	CQMA 333K 50
C18	Mylar	0.033	50V	CQMA 333K 50
C19	Mylar	0.0018	50V	CQMA 182K 50
C20	Mylar	0.0018	50V	CQMA 182K 50
C21	Electrolytic	4.7	25V	CEA 4R7P 25
C22	Electrolytic	4.7	25V	CEA 4R7P 25
C23	Electrolytic	4.7	25V	CEA 4R7P 25
C24	Electrolytic	4.7	25V	CEA 4R7P 25
C25	Electrolytic	2.2	25V	CSSA 2R2M 25
C26	Electrolytic	2.2	25V	CSSA 2R2M 25
C27	Electrolytic	47	10V	CEA 470P 10
C28	Electrolytic	47	10V	CEA 470P 10
C29	Mylar	0.012	50V	CQMA 123K 50
C30	Mylar	0.012	50V	CQMA 123K 50
C31	Electrolytic	100	35V	CEA 101P 35

### RESISTORS AND POTENTIOMETERS

Symbol	Description			Part No.
R1	Metal oxide	150	2W	RS2P 151K
R2	Metal oxide	150	2W	RS2P 151K
R3	Carbon film	2.2k		RD $\frac{1}{4}$ PS 222J
R4	Carbon film	2.2k		RD $\frac{1}{4}$ PS 222J
R5	Carbon film	2.2k		RD $\frac{1}{4}$ PS 222J
R6	Carbon film	2.2k		RD $\frac{1}{4}$ PS 222J
R7	Carbon film	4.7k		RD $\frac{1}{4}$ PS 472J
R8	Carbon film	4.7k		RD $\frac{1}{4}$ PS 472J
R9	Carbon film	15k		RD $\frac{1}{4}$ PS 153J
R10	Carbon film	15k		RD $\frac{1}{4}$ PS 153J

Symbol	Description	Part No.
R11	Carbon film 470k	RD%PS 474J
R12	Carbon film 470k	RD%PS 474J
R13	Carbon film 2.2k	RD%PS 222J
R14	Carbon film 2.2k	RD%PS 222J
R15	Carbon film 1.2M	RD%PS 125J
R16	Carbon film 1.2M	RD%PS 125J
R17	Carbon film 330k	RD%PS 334J
R18	Carbon film 330k	RD%PS 334J
R19	Carbon film 10k	RD%PS 103J
R20	Carbon film 10k	RD%PS 103J
R21	Carbon film 1.5k	RD%PS 152J
R22	Carbon film 1.5k	RD%PS 152J
R23	Carbon film 10k	RD%PS 103J
R24	Carbon film 10k	RD%PS 103J
R25	Carbon film 10k	RD%PS 103J
R26	Carbon film 10k	RD%PS 103J
R27	Carbon film 100	RD%PS 101J
R28	Carbon film 100	RD%PS 101J
R29	Carbon film 15k	RD%PS 153J
R30	Carbon film 15k	RD%PS 153J
R31	Carbon film 5.6k	RD%PS 562J
R32	Carbon film 5.6k	RD%PS 562J
R33	Carbon film 10k	RD%PS 103J
R34	Carbon film 10k	RD%PS 103J
R35	Carbon film 15k	RD%PS 153J
R36	Carbon film 15k	RD%PS 153J
R37	Carbon film 5.6k	RD%PS 562J
R38	Carbon film 5.6k	RD%PS 562J
R39	Carbon film 820k	RD%PS 824J
R40	Carbon film 820k	RD%PS 824J
R41	Carbon film 100k	RD%PS 104J
R42	Carbon film 100k	RD%PS 104J
R43	Carbon film 6.8k	RD%PS 682J
R44	Carbon film 6.8k	RD%PS 682J
R45	Carbon film 680	RD%PS 681J
R46	Carbon film 680	RD%PS 681J
R47	Carbon film 100k	RD%PS 104J
R48	Carbon film 100k	RD%PS 104J
R49	Carbon film 3.3k	RD%PS 332J
R50	Carbon film 3.3k	RD%PS 332J
R51	Carbon film 470k	RD%PS 474J
R52	Carbon film 470k	RD%PS 474J
R53	Carbon film 1k	RD%PS 102J
VR1	Variable resistor 250k-HB (BALANCE)	ACV-135-0
VR2	Variable resistor 250k-B1 (VOLUME)	ACV-139-0
VR3	Variable resistor 100k-B (BASS)	ACV-136-0
VR4	Variable resistor 100k-B (TREBLE)	ACV-136-0

SEMICONDUCTORS

Symbol	Description	Part No.
Q1	Transistor 2SA726-F or G	
Q2	Transistor 2SA726-F or G	
Q3	Transistor 2SC1344-E or F (2SC1312-E, F or G)	
Q4	Transistor 2SC1344-E or F (2SC1312-E, F or G)	
Q5	Transistor 2SC1344-E or F (2SC1312-E, F or G)	
Q6	Transistor 2SC1344-E or F (2SC1312-E, F or G)	

SWITCHES

Symbol	Description	Part No.
S1	Push switch (speaker)	ASG-073-0
S2	Push switch (filter, mode)	ASG-073-0
S3	Push switch (tape monitor, loudness)	ASG-074-0

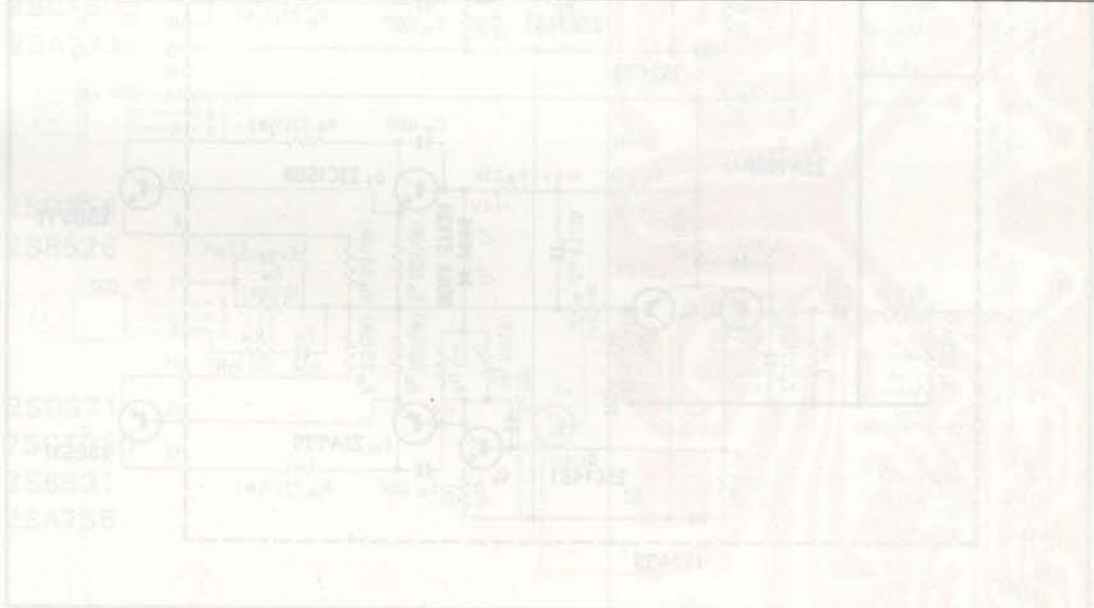

# 11.5 POWER AMPLIFIER ASSEMBLY (AWH-034-0)

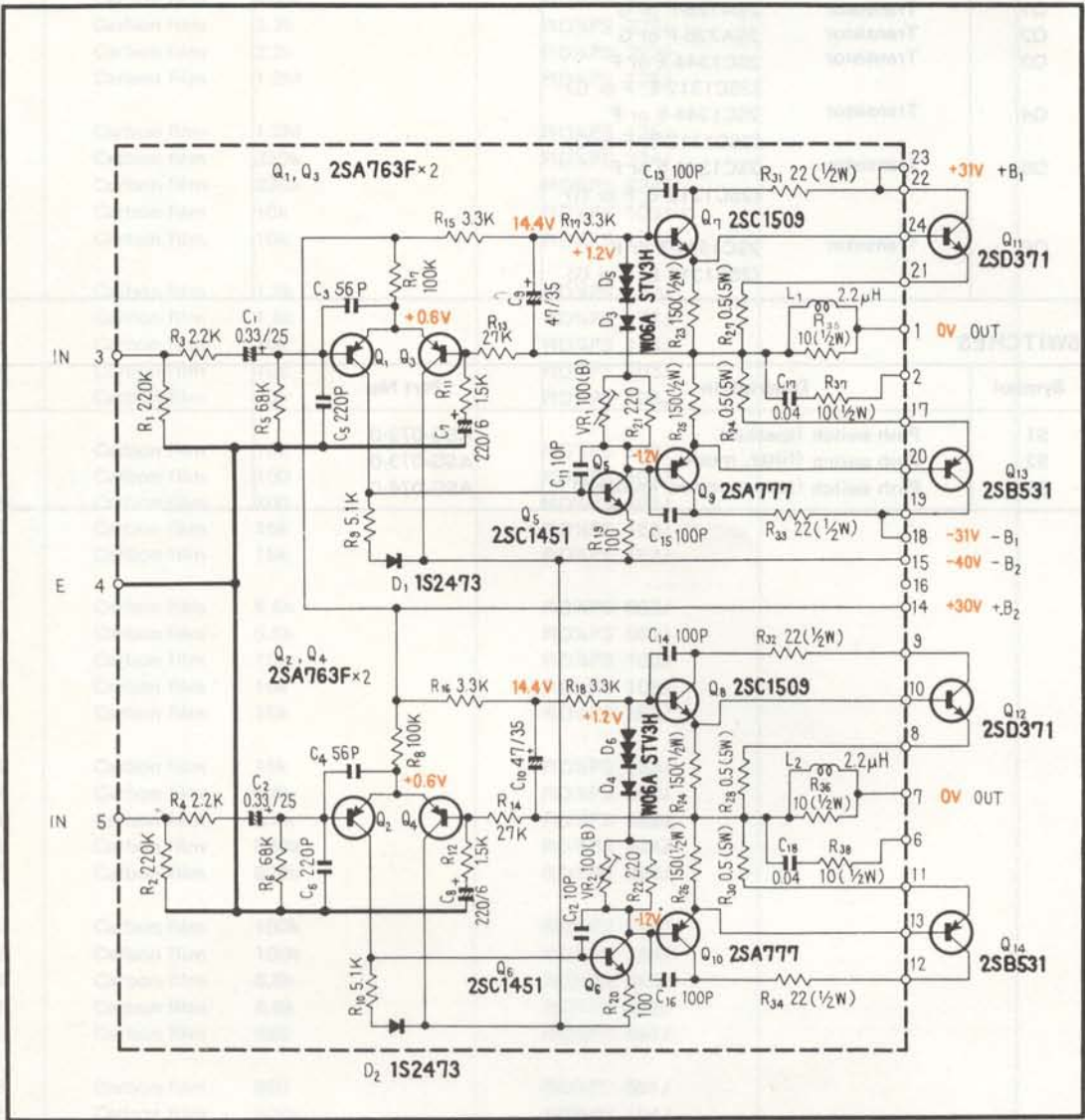

Foil Side (AWH-034-0)

2SA640  
2SA763F



2SA726



2SC1451

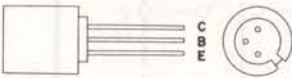

2SC1509  
2SA777

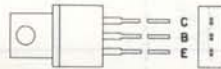

2SD356  
2SB526

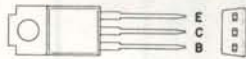

2SD371  
2SC1030  
2SB531  
2SA756

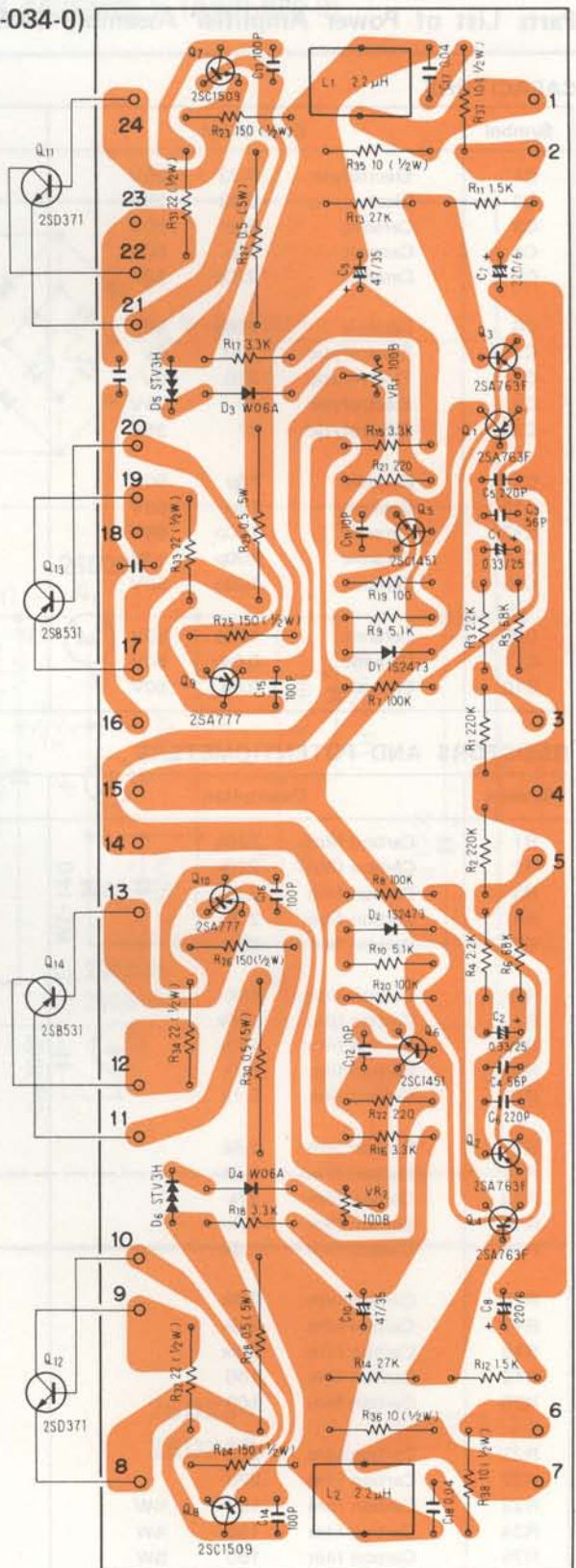
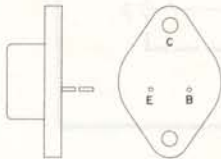

# Parts List of Power Amplifier Assembly (AWH-034-0)

## CAPACITORS

Symbol	Description			Part No.
C1	Electrolytic	0.33	25V	CSSA R33M 25
C2	Electrolytic	0.33	25V	CSSA R33M 25
C3	Ceramic	56p	50V	CCDSL 560K 50
C4	Ceramic	56p	50V	CCDSL 560K 50
C5	Ceramic	220p	50V	CCDSL 221K 50
C6	Ceramic	220p	50V	CCDSL 221K 50
C7	Electrolytic	220	6V	CEA 221P 6
C8	Electrolytic	220	6V	CEA 221P 6
C9	Electrolytic	47	35V	CEA 470P 35
C10	Electrolytic	47	35V	CEA 470P 35
C11	Ceramic	10p	50V	CCDSL 100F 50
C12	Ceramic	10p	50V	CCDSL 100F 50
C13	Ceramic	100p	50V	CCDSL 101K 50
C14	Ceramic	100p	50V	CCDSL 101K 50
C15	Ceramic	100p	50V	CCDSL 101K 50
C16	Ceramic	100p	50V	CCDSL 101K 50
C17	Ceramic	0.04	50V	CKDYF 403Z 50
C18	Ceramic	0.04	50V	CKDYF 403Z 50

## RESISTORS AND POTENTIOMETERS

Symbol	Description			Part No.
R1	Carbon film	220k		RD $\frac{1}{4}$ PS 224J
R2	Carbon film	220k		RD $\frac{1}{4}$ PS 224J
R3	Carbon film	2.2k		RD $\frac{1}{4}$ PS 222J
R4	Carbon film	2.2k		RD $\frac{1}{4}$ PS 222J
R5	Carbon film	68k		RD $\frac{1}{4}$ PS 683J
R6	Carbon film	68k		RD $\frac{1}{4}$ PS 683J
R7	Carbon film	100k		RD $\frac{1}{4}$ PS 104J
R8	Carbon film	100k		RD $\frac{1}{4}$ PS 104J
R9	Carbon film	5.1k		RD $\frac{1}{4}$ PS 512J
R10	Carbon film	5.1k		RD $\frac{1}{4}$ PS 512J
R11	Carbon film	1.5k		RD $\frac{1}{4}$ PS 152J
R12	Carbon film	1.5k		RD $\frac{1}{4}$ PS 152J
R13	Carbon film	27k		RD $\frac{1}{4}$ PS 273J
R14	Carbon film	27k		RD $\frac{1}{4}$ PS 273J
R15	Carbon film	3.3k		RD $\frac{1}{4}$ PS 332J
R16	Carbon film	3.3k		RD $\frac{1}{4}$ PS 332J
R17	Carbon film	3.3k		RD $\frac{1}{4}$ PS 332J
R18	Carbon film	3.3k		RD $\frac{1}{4}$ PS 332J
R19	Carbon film	100		RD $\frac{1}{4}$ PS 101J
R20	Carbon film	100		RD $\frac{1}{4}$ PS 101J
R21	Carbon film	220		RD $\frac{1}{4}$ PS 221J
R22	Carbon film	220		RD $\frac{1}{4}$ PS 221J
R23	Carbon film	150	$\frac{1}{2}$ W	RD $\frac{1}{2}$ PS 151J
R24	Carbon film	150	$\frac{1}{2}$ W	RD $\frac{1}{2}$ PS 151J
R25	Carbon film	150	$\frac{1}{2}$ W	RD $\frac{1}{2}$ PS 151J

Symbol	Description	Part No.
R26	Carbon film 150 ½W	RD½PS 151J
R27	Wire wound 0.5 5W	RT5B 0R5K
R28	Wire wound 0.5 5W	RT5B 0R5K
R29	Wire wound 0.5 5W	RT5B 0R5K
R30	Wire wound 0.5 5W	RT5B 0R5K
R31	Carbon film 22 ½W	RD½PS 220J
R32	Carbon film 22 ½W	RD½PS 220J
R33	Carbon film 22 ½W	RD½PS 220J
R34	Carbon film 22 ½W	RD½PS 220J
R35	Carbon film 10 ½W	RD½PS 100J
R36	Carbon film 10 ½W	RD½PS 100J
R37	Carbon film 10 ½W	RD½PS 100J
R38	Carbon film 10 ½W	RD½PS 100J
VR1	Variable resistor 100-B, semi-fixed	C92-063-0
VR2	Variable resistor 100-B, semi-fixed	C92-063-0

### SEMICONDUCTORS

Symbol	Description	Part No.
Q1	Transistor 2SA763F-6 or 5 (2SA726-F or G) (2SA640-K or L)	
Q2	Transistor 2SA763F-6 or 5 (2SA726-F or G) (2SA640-K or L)	
Q3	Transistor 2SA763F-6 or 5 (2SA726-F or G) (2SA640-K or L)	
Q4	Transistor 2SA763F-6 or 5 (2SA726-F or G) (2SA640-K or L)	
Q5	Transistor 2SC1451-G, B or V	
Q6	Transistor 2SC1451-G, B or V	
Q7	Transistor 2SC1509-Q or R (2SD356-D or C)	
Q8	Transistor 2SC1509-Q or R (2SD356-D or C)	
Q9	Transistor 2SA777-Q or R (2SB526-D or C)	
Q10	Transistor 2SA777-Q or R (2SB526-D or C)	
Q11	Transistor 2SD371-0, Y or R (2SC1030-B, C or A)	
Q12	Transistor 2SD371-0, Y or R (2SC1030-B, C or A)	
Q13	Transistor 2SB531-0, Y or R (2SA756-B, C or A)	
Q14	Transistor 2SB531-0, Y or R (2SA756-B, C or A)	
D1	Diode 1S2473	
D2	Diode 1S2473	
D3	Diode W06A	
D4	Diode W06A	
D5	Varistor STV3H	

Symbol	Description	Part No.
D6	Varistor STV3H	

**OTHERS**

Symbol	Description	Part No.
	AF choke coil	T63-009-0
	Power transistor socket	AKH-001-0
	Spacer (insulator)	AEC-076-0

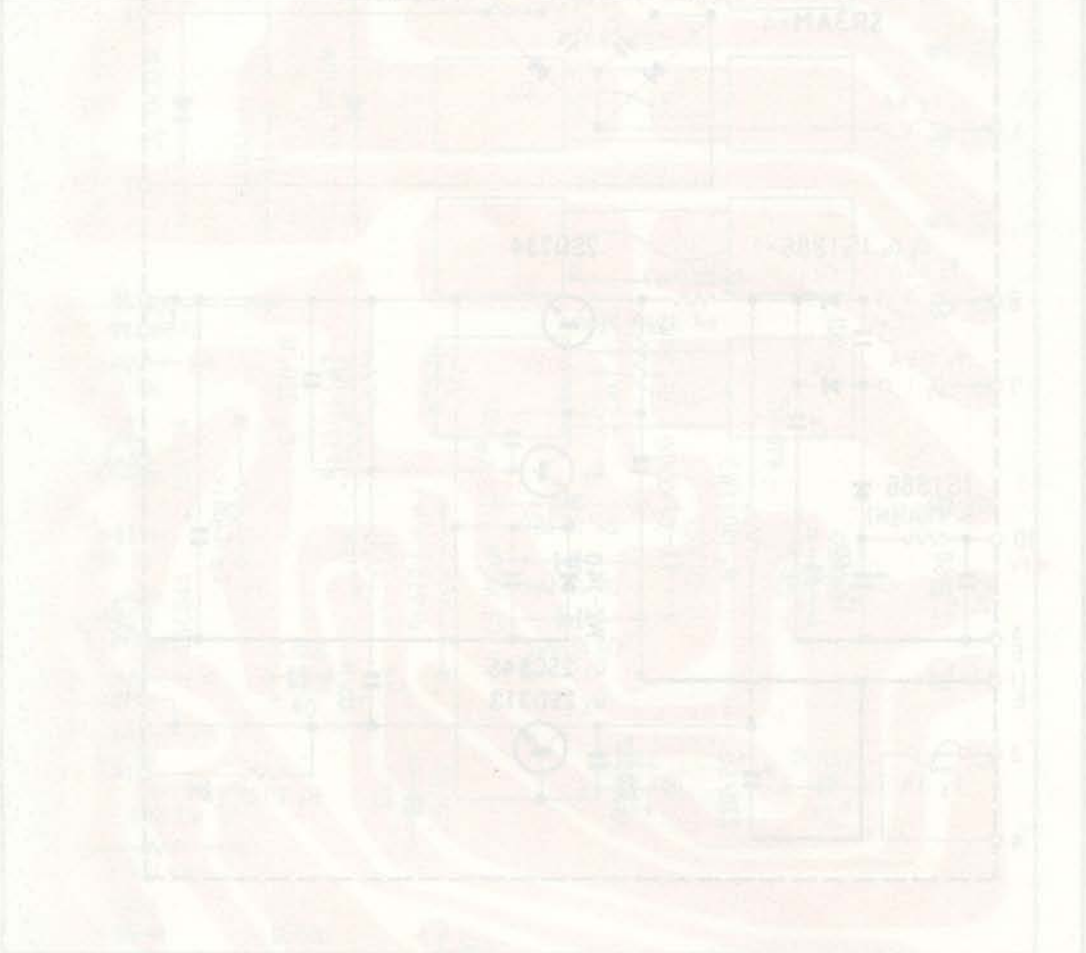



### 11.6 POWER SUPPLY CIRCUIT ASSEMBLY (AWR-060-0)

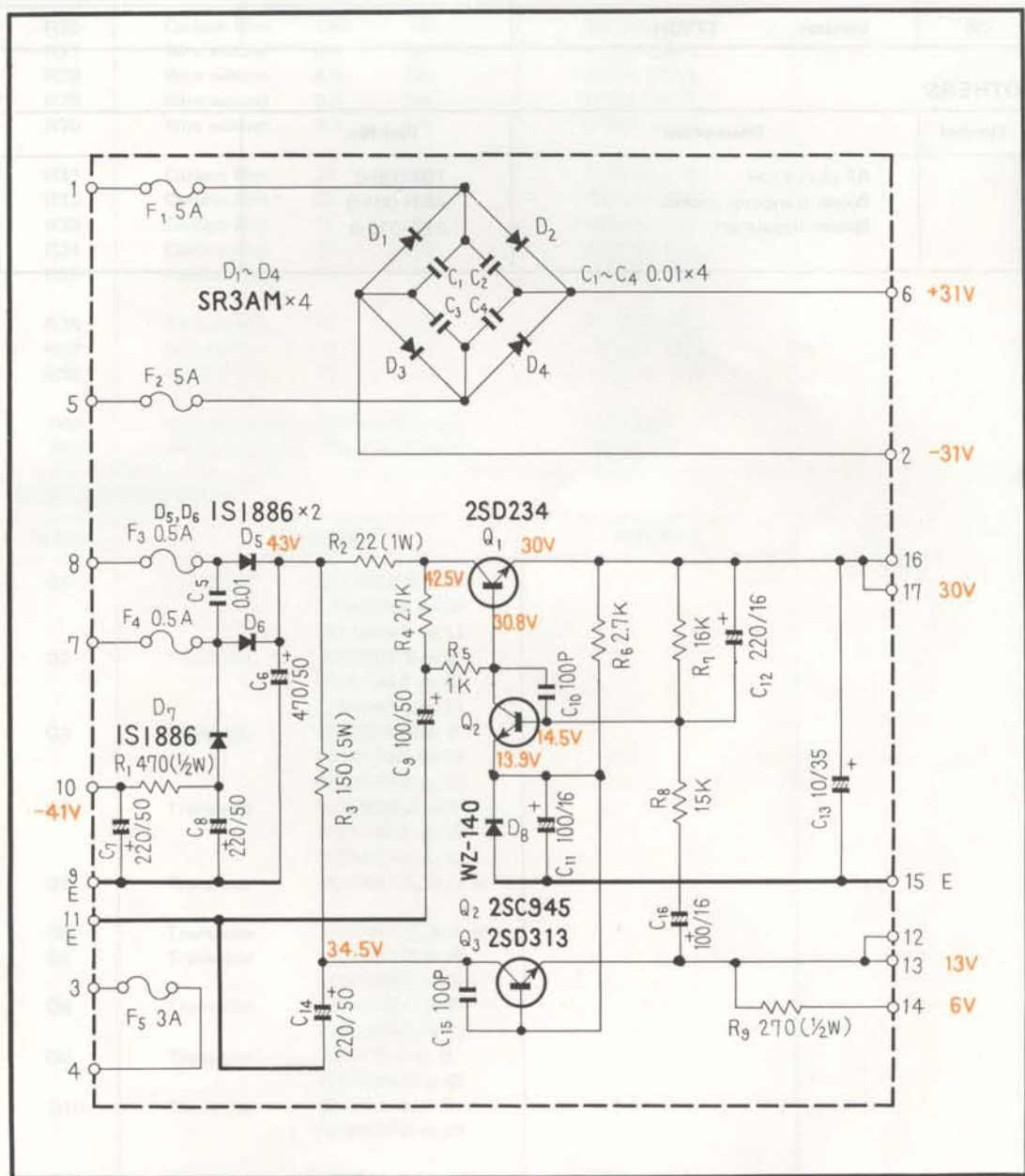

2SC945



2SD234  
2SD313

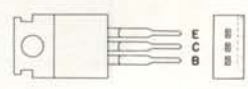

Foil Side (AWR-060-0)

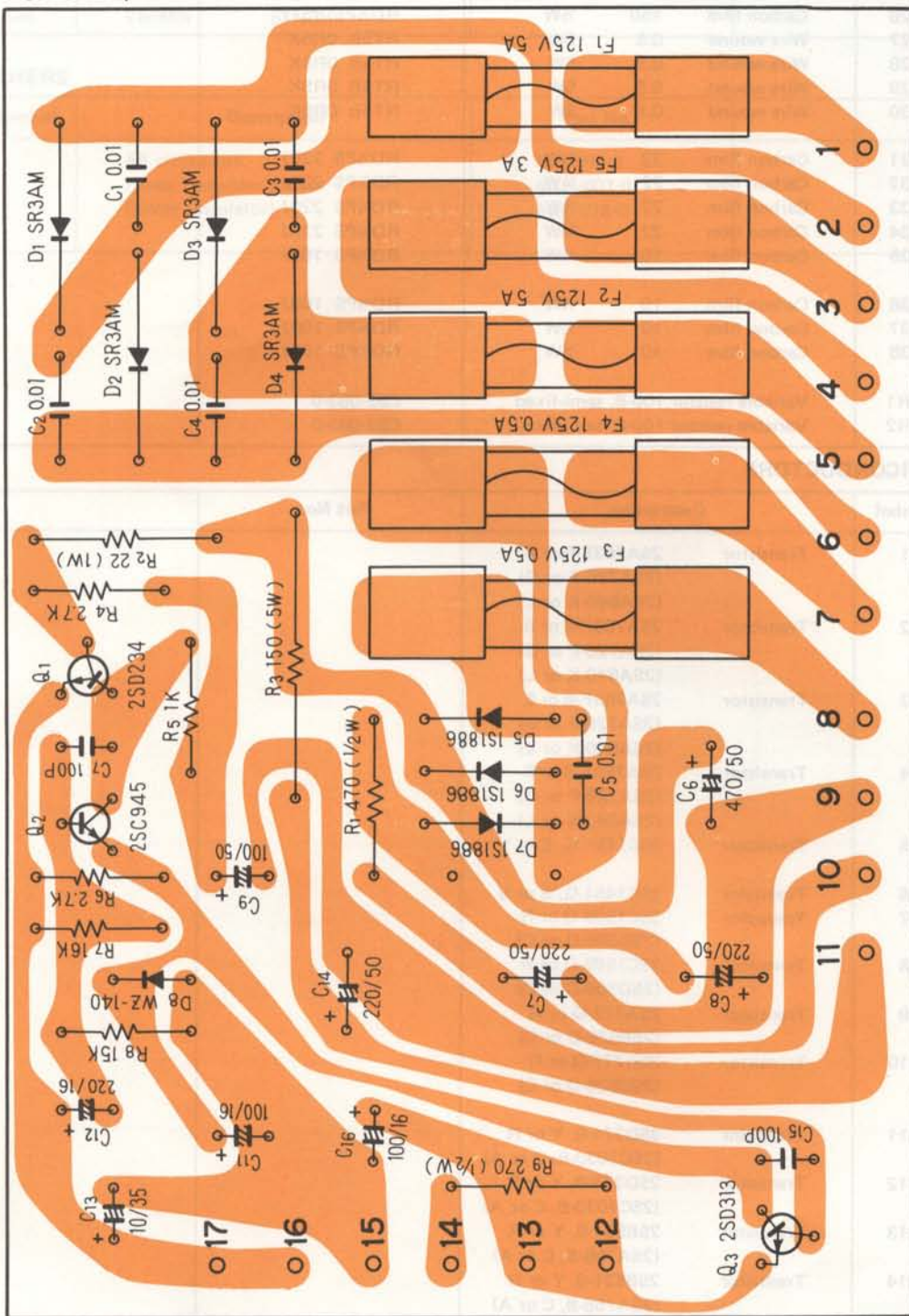

Parts List of Power Supply Circuit Assembly (AWR-060-0)

CAPACITORS

Symbol	Description			Part No.
C1	Ceramic	0.01	150V	ACG-004-0
C2	Ceramic	0.01	150V	ACG-004-0
C3	Ceramic	0.01	150V	ACG-004-0
C4	Ceramic	0.01	150V	ACG-004-0
C5	Ceramic	0.01	150V	ACG-004-0
C6	Electrolytic	470	50V	CEA 471P 50
C7	Electrolytic	220	50V	CEA 221P 50
C8	Electrolytic	220	50V	CEA 221P 50
C9	Electrolytic	100	50V	CEA 101P 50
C10	Ceramic	100p	50V	CCDSL 101Z 50
C11	Electrolytic	100	16V	CEA 101P 16
C12	Electrolytic	220	16V	CEA 221P 16
C13	Electrolytic	10	35V	CEA 100P 35
C14	Electrolytic	220	50V	CEA 221P 50
C15	Ceramic	100p	50V	CCDSL 101Z 50
C16	Electrolytic	100	16V	CEA 101P 16

RESISTORS

Symbol	Description			Part No.
R1	Carbon film	470	½W	RD½PS 471J
R2	Metal oxide	22	1W	RS1P 220K
R3	Wire wound	150	5W	RT5B 151K
R4	Carbon film	2.7k		RD½PS 272J
R5	Carbon film	1k		RD½PS 102J
R6	Carbon film	2.7k		RD½PS 272J
R7	Carbon film	16k		RD½PS 163J
R8	Carbon film	15k		RD½PS 153J
R9	Carbon film	270	½W	RD½PS 271J

SEMICONDUCTORS

Symbol	Description		Part No.
Q1	Transistor	2SD234-O or Y	
Q2	Transistor	2SC945-Q or R	
Q3	Transistor	2SD313-D or E	
D1	Diode	SR3AM-4	
D2	Diode	SR3AM-4	
D3	Diode	SR3AM-4	
D4	Diode	SR3AM-4	
D5	Diode	1S1886 (SIB01-02)	
D6	Diode	1S1886 (SIB01-02)	
D7	Diode	1S1886 (SIB01-02)	
D8	Zener diode	WZ-140	

OTHERS

Symbol	Description	Part No.
	Clip-in type fuse holder	AKR-013-0
	Heat sink	ANH-117-0

11.7 POWER SUPPLY CIRCUIT ASSEMBLY (AWR-061-0) FOR 220V ONLY MODEL

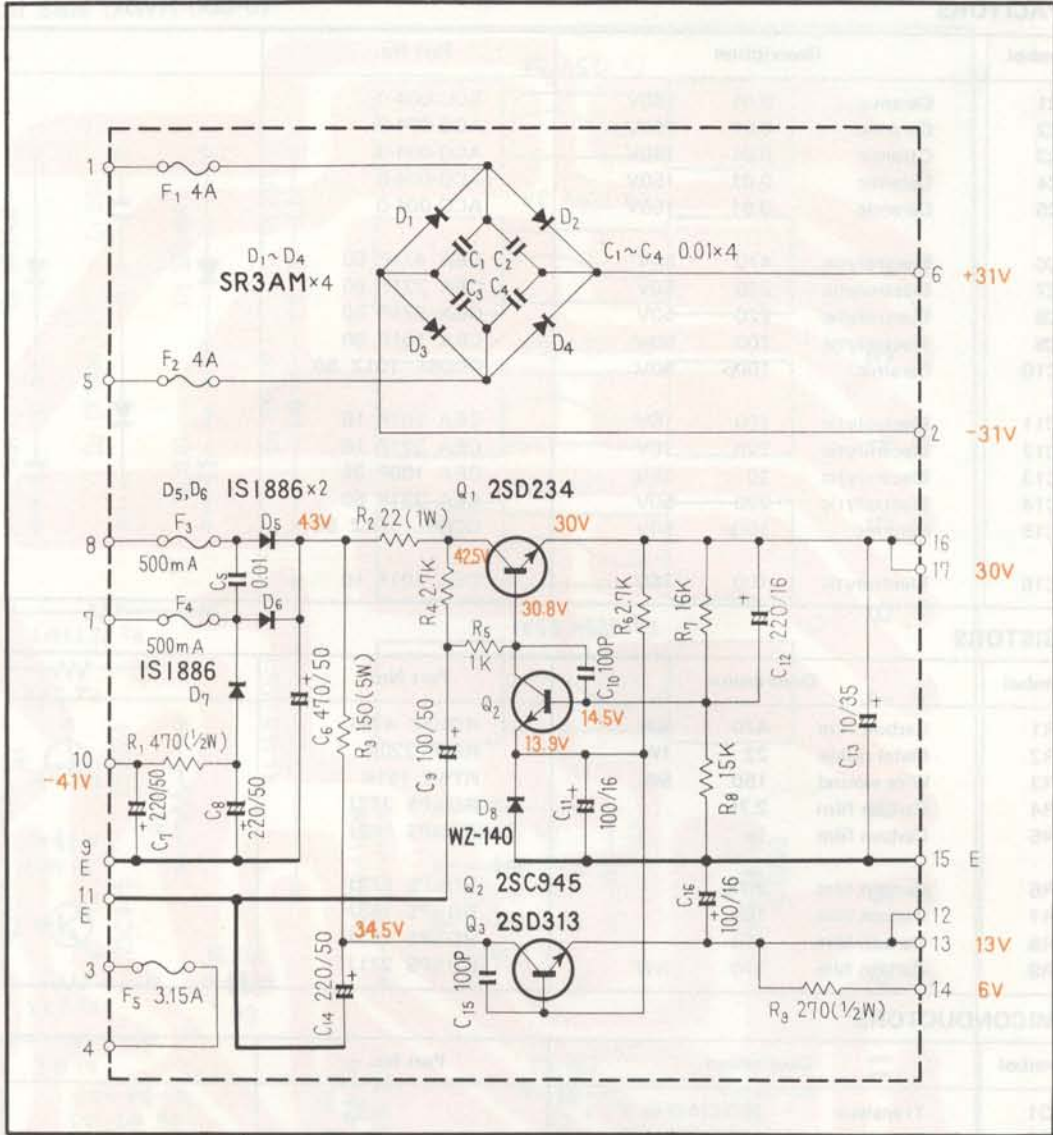

2SD234

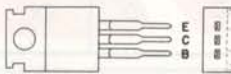

2SD313

2SC945

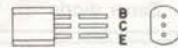

Foil Side (AWR-061-0)

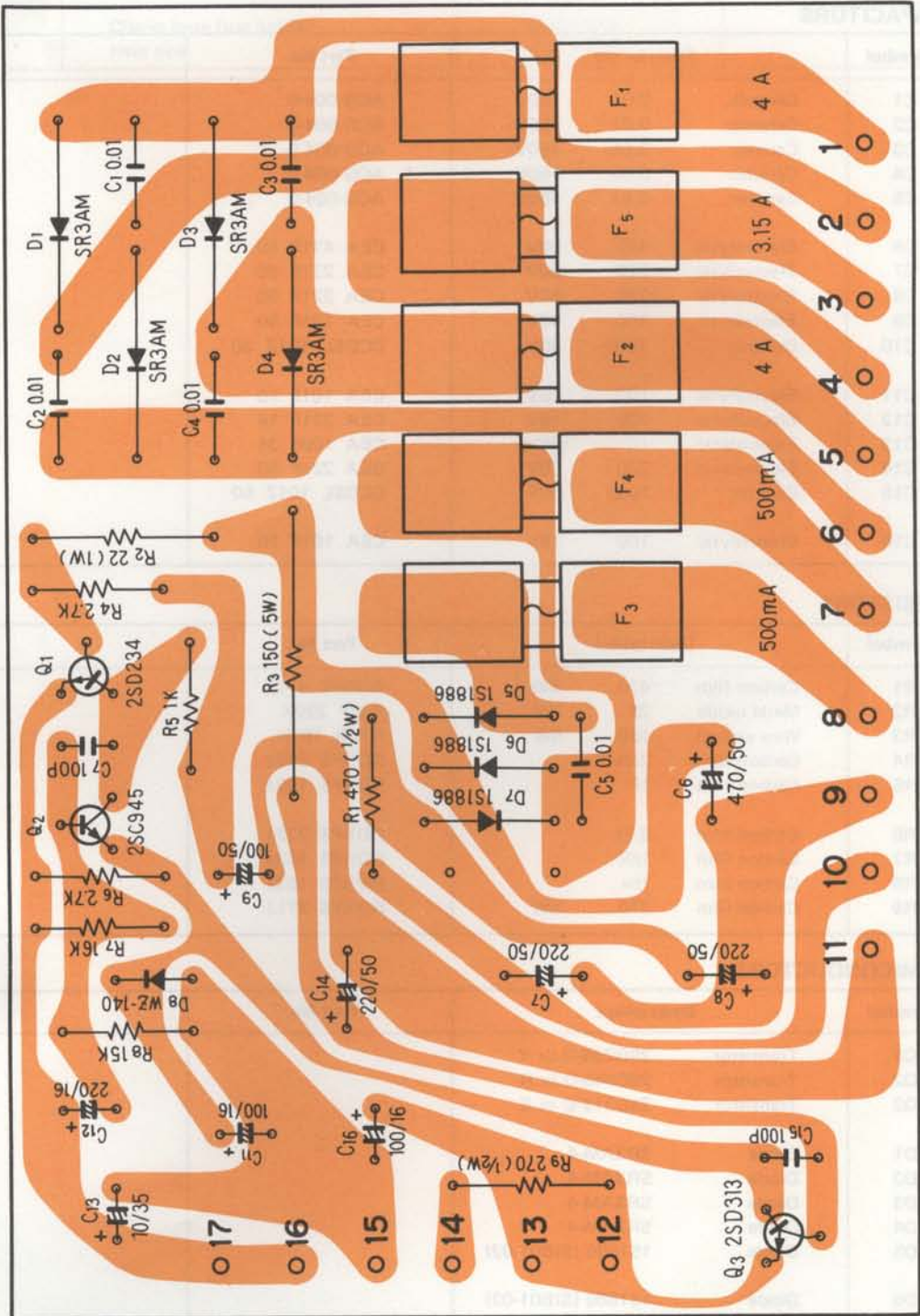

Parts List of Power Supply Circuit Assembly (AWR-061-0) for 220V only model

CAPACITORS

Symbol	Description			Part No.
C1	Ceramic	0.01	150V	ACG-004-0
C2	Ceramic	0.01	150V	ACG-004-0
C3	Ceramic	0.01	150V	ACG-004-0
C4	Ceramic	0.01	150V	ACG-004-0
C5	Ceramic	0.01	150V	ACG-004-0
C6	Electrolytic	470	50V	CEA 471P 50
C7	Electrolytic	220	50V	CEA 221P 50
C8	Electrolytic	220	50V	CEA 221P 50
C9	Electrolytic	100	50V	CEA 101P 50
C10	Ceramic	100p	50V	CCDSL 101Z 50
C11	Electrolytic	100	16V	CEA 101P 16
C12	Electrolytic	220	16V	CEA 221P 16
C13	Electrolytic	10	35V	CEA 100P 35
C14	Electrolytic	220	50V	CEA 221P 50
C15	Ceramic	100p	50V	CCDSL 101Z 50
C16	Electrolytic	100	16V	CEA 101P 16

RESISTORS

Symbol	Description			Part No.
R1	Carbon film	470	½W	RD½PS 471J
R2	Metal oxide	22	1W	RS1P 220K
R3	Wire wound	150	5W	RT5B 151K
R4	Carbon film	2.7k		RD½PS 272J
R5	Carbon film	1k		RD½PS 102J
R6	Carbon film	2.7k		RD½PS 272J
R7	Carbon film	16k		RD½PS 163J
R8	Carbon film	15k		RD½PS 153J
R9	Carbon film	270	½W	RD½PS 271J

SEMICONDUCTORS

Symbol	Description		Part No.
Q1	Transistor	2SD234-O or Y	
Q2	Transistor	2SC945-Q or R	
Q3	Transistor	2SD313-D or E	
D1	Diode	SR3AM-4	
D2	Diode	SR3AM-4	
D3	Diode	SR3AM-4	
D4	Diode	SR3AM-4	
D5	Diode	1S1886 (SIB01-02)	
D6	Diode	1S1886 (SIB01-02)	
D7	Diode	1S1886 (SIB01-02)	
D8	Zener diode	WZ-140	

**OTHERS**

Symbol	Description	Part No.	
	Clip-in type fuse holder Heat sink	AKR-010-0 ANH-117-0	

POWER ELECTRONIC CORPORATION  
 1000 WEST 10TH AVENUE  
 DENVER, COLORADO 80202  
 (303) 733-1000  
 FAX (303) 733-1001  
 © 1988 POWER ELECTRONIC CORPORATION

17- P.C. BOARD PATTERN AND PARTS LIST

**PIONEER ELECTRONIC CORPORATION**

4-1, Meguro 1-Chome, Meguro-ku, Tokyo 153, Japan

**U.S. PIONEER ELECTRONICS CORPORATION**

75 Oxford Drive, Moonachie, New Jersey 07074, U.S.A.

**PIONEER ELECTRONIC (EUROPE) N.V.**

Luithagen-Haven 9, 2030 Antwerp, Belgium

**PIONEER ELECTRONICS AUSTRALIA PTY. LTD.**

178-184 Boundary Road, Braeside, Victoria 3195, Australia

© MAY 1976

Printed in Japan