

REF.21

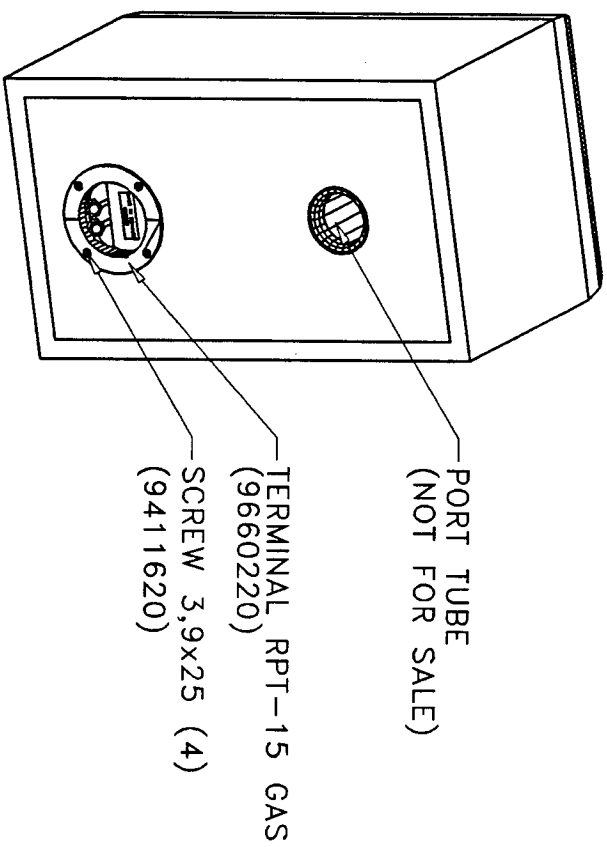
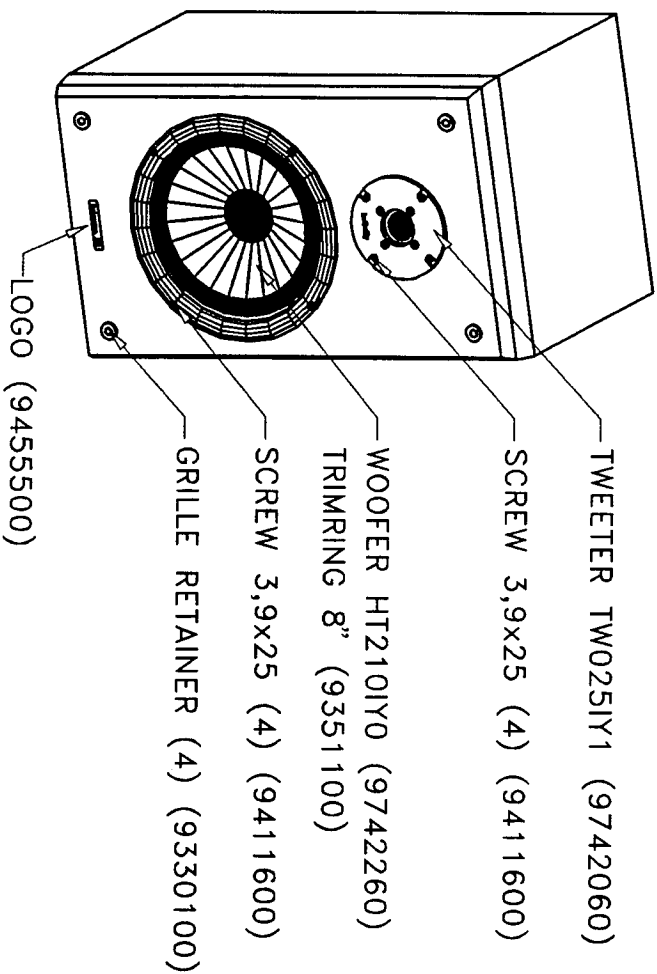

GRILLE : 2408080
NETWORK : 2708080
SCREW 4x20 (3) : 9410120