

AA-A35/L

AKAI SERVICE MANUAL

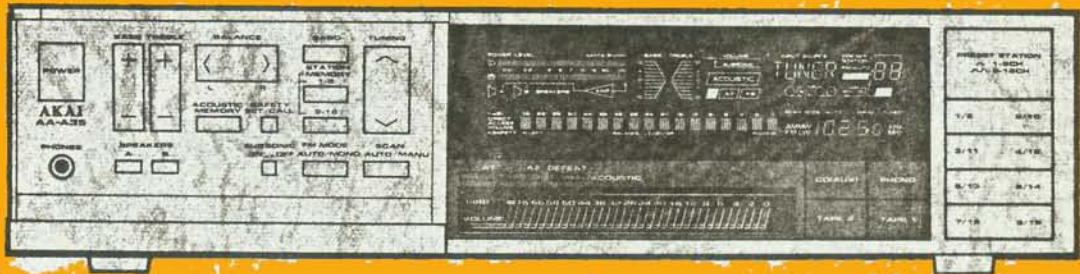

COMPUTER CONTROLLED STEREO RECEIVER

MODEL **AA-A35/L**

ABBREVIATIONS FOR SERVICE MANUAL MODEL AA-A35/L

ABBREVIATION	EXPLANATION
AC	Alternating Current
A/D	Analog/Digital
AGC	Auto Gain Control
ALC	Auto Level Control
AM	Amplitude Modulation
CK	Clock
D	Data
DET	DETECTOR
FLD (FL DISPLAY)	FLUORESCENT DISPLAY
FM	Frequency Modulation
FREQ	FREQUENCY
GND	GROUNDED
IF	Intermediate Frequency
INV	INVERT
LW	Long Wave
MANU	MANUAL
MC	Moving Coil
MM	Moving Magnet
MPX	Multi Plex
MW	Medium Wave
OSC	OSCILLATOR
PLL	Phase Locked Loop
RST	RESET
SENS	SENSITIVITY
SM	Signal Meter
ST	STROBE
SW	SWITCH

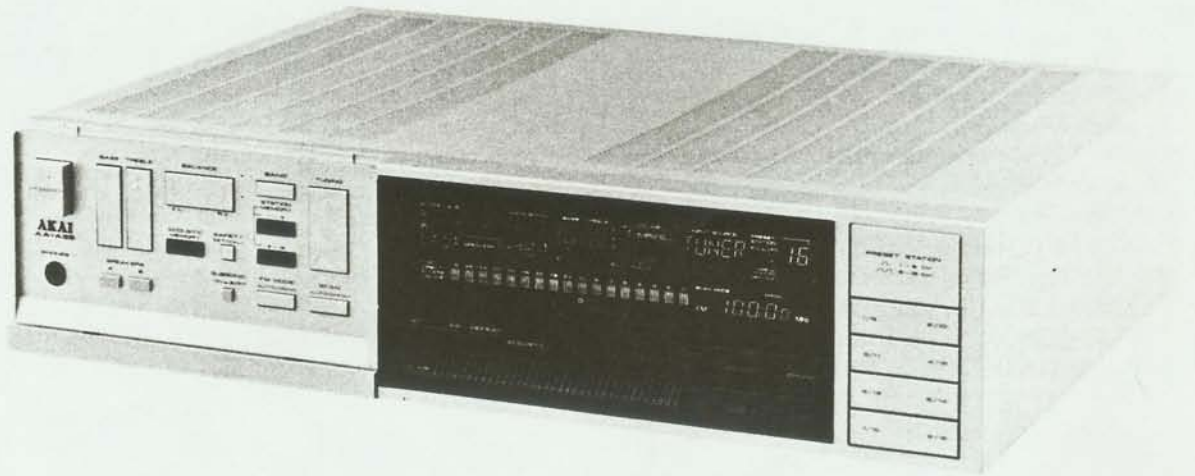

COMPUTER CONTROLLED STEREO RECEIVER

MODEL AA-A35/L

SECTION 1	SERVICE MANUAL	3
SECTION 2	PARTS LIST	23

SAFETY INSTRUCTIONS

SAFETY CHECK AFTER SERVICING

Confirm the specified insulation resistance between power cord plug prongs and externally exposed parts of the set is greater than 10 Mohms, but for equipment with external antenna terminals (tuner, receiver, etc.) and is intended for **C** or **A**, specified insulation resistance should be more than 2.2 Mohms (ground terminals, microphone jacks, headphone jacks, line-in-out jacks etc.)

PRECAUTIONS DURING SERVICING

1. Parts identified by the Δ symbol parts are critical for safety.
Replace only with parts number specified.
2. In addition to safety, other parts and assemblies are specified for conformance with such regulations as those applying to spurious radiation. These must also be replaced only with specified replacements.
Examples: RF converters, tuner units, antenna selector switches, RF cables, noise blocking capacitors, noise blocking filters, etc.
3. Use specified internal wiring. Note especially:
 - 1) Wires covered with PVC tubing
 - 2) Double insulated wires
 - 3) High voltage leads
4. Use specified insulating materials for hazardous live parts. Note especially:
 - 1) Insulation Tape
 - 2) PVC tubing
 - 3) Spacers (Insulating Barriers)
 - 4) Insulation sheets for transistors
 - 5) Plastic screws for fixing microswitch (especially in turntable)
5. When replacing AC primary side components (transformers, power cords, noise blocking capacitors, etc.), wrap ends of wires securely about the terminals before soldering.

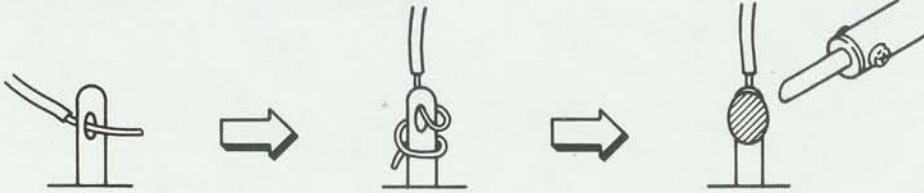

6. Observe that wires do not contact heat producing parts (heatsinks, oxide metal film resistors, fusible resistors, etc.).
7. Check that replaced wires do not contact sharp edged or pointed parts.
8. Also check areas surrounding repaired locations.
9. Use care that foreign objects (screws, solder droplets, etc.) do not remain inside the set.

VOLTAGE CONVERSION

Models for Canada, USA, Europe, UK and Australia are not equipped with this facility. Each machine is preset at the factory according to destination, but some machines can be set to 110V, 120V, 220V or 240V as required. If your machine's voltage can be converted:

Before connecting the power cord, turn the VOLTAGE SELECTOR located on the rear panel with a screwdriver until the correct voltage is indicated.

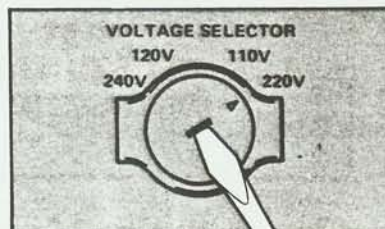

SECTION 1

SERVICE MANUAL

TABLE OF CONTENTS

I.	SPECIFICATIONS	4
II.	DISMANTLING OF UNIT	5
III.	CONTROLS	6
IV.	PRINCIPAL PARTS LOCATION	7
V.	DESCRIPTION OF THE CIRCUIT OPERATION	8
	5-1 AMPLIFIER PERFORMANCE	8
	5-2 TUNER PERFORMANCE	11
VI.	AMPLIFIER SECTION ADJUSTMENT	14
	6-1 THE INSTRUMENT CONNECTION	14
	6-2 MAIN AMP PC BOARD ADJUSTMENT POINTS	14
	6-3 POWER LEVEL METER ADJUSTMENT	14
VII.	TUNER ADJUSTMENT	15
	7-1 THE INSTRUMENT CONNECTIONS	15
	7-2 TUNER, FRONT END, MPX PC BOARD ADJUSTMENT POINTS ...	16
	7-3 HOW TO CALL THE PRESET FREQUENCY FOR THE TUNER ADJUSTMENT	17
	7-4 FM SECTION ADJUSTMENT	18
	7-5 LW SECTION ADJUSTMENT	19
	7-6 AM (MW) SECTION ADJUSTMENT	19
VIII.	PC BOARD TITLES AND IDENTIFICATION NUMBERS	20

For basic adjustments, measuring methods, and operating principles, refer to GENERAL TECHNICAL MANUAL.

I. SPECIFICATIONS

FM TUNER SECTION

TUNING FREQUENCY RANGE	87.5MHz to 108.0MHz
USABLE SENSITIVITY (IHF)	11.2dBf (300ohms)
QUIETING SENSITIVITY (IHF) (S/N = 50dB)	16.2dBf (Mono)/37.2dBf (Stereo)
CAPTURE RATIO	1.5dB
SELECTIVITY (IHF)	60dB (400kHz)
IMAGE REJECTION	85dB
IF REJECTION	90dB
SPURIOUS REJECTION	90dB
AM SUPPRESSION	60dB
S/N (IHF)	75dB (Mono)/65dB (Stereo)
HARMONIC DISTORTION	0.1% (Mono)/0.3% (Stereo)
STEREO SEPARATION	45dB (1kHz)

LW TUNER SECTION (AA-A35L only)

TUNING FREQUENCY RANGE	146kHz to 353kHz
USABLE SENSITIVITY (IHF)	800 μ V/m
SELECTIVITY (IHF)	30dB
IMAGE REJECTION	45dB
IF REJECTION	55dB
S/N	35dB
T.H.D.	2.0%
ANTENNA	Loop antenna

AM TUNER SECTION (MW for AA-A35L)

TUNING FREQUENCY RANGE	530kHz to 1,610kHz for USA and Canada 531kHz to 1,602kHz for other countries
USABLE SENSITIVITY (IHF)	300 μ V/m
SELECTIVITY (IHF)	25dB
IMAGE REJECTION	40dB
IF REJECTION	55dB
S/N	40dB
T.H.D.	1.0%
ANTENNA	Loop antenna

AMPLIFIER SECTION

RATED POWER OUTPUT		8 ohms
	20Hz to 20kHz 1kHz	45W \times 2/0.02% 53W \times 2/0.02%
MUSIC POWER		100W
POWER BANDWIDTH (IHF, -3dB, 8 ohms)		5Hz to 70kHz/0.1%
S/N	PHONO	75dB
	AUX	98dB
RESIDUAL NOISE (8 ohms)		0.5mV
CHANNEL SEPARATION (IHF)	PHONO/AUX	65dB (1kHz)
DAMPING FACTOR (1kHz, 8 ohms)		50
OUTPUT	SPEAKER	A or B 4 to 16 ohms
		A + B 8 to 16 ohms
INPUT SENSITIVITY/IMPEDANCE	PHONO	2.5mV/100kohms
	AUX/TAPE	150mV/47kohms
OUTPUT LEVEL/IMPEDANCE	TAPE REC	150mV/3kohms
FREQUENCY RESPONSE	PHONO (RIAA)	\pm 0.5dB (30Hz to 15kHz)
	AUX/TAPE	5 Hz to 100kHz, -3dB
TONE CONTROL	BASS	\pm 8dB (100Hz)
	TREBLE	\pm 8dB (10kHz)
FILTER	SUBSONIC	-3dB/18Hz
PHONO MAX. INPUT (MM)		150mV
POWER REQUIREMENTS		120V, 60Hz for USA & Canada
		220V, 50Hz for Europe except UK
		240V, 50Hz for UK & Australia
		110V/120V/220V/240V, 50/60Hz switchable for other countries
DIMENSIONS		440(W) \times 110(H) \times 345(D) mm
WEIGHT		8.4kg

* For improvement purposes, specifications and design are subject to change without notice.

II. DISMANTLING OF UNIT

In case of trouble, etc. necessitating dismantling, please dismantle in the order shown in the photographs. Reassemble in reverse order.

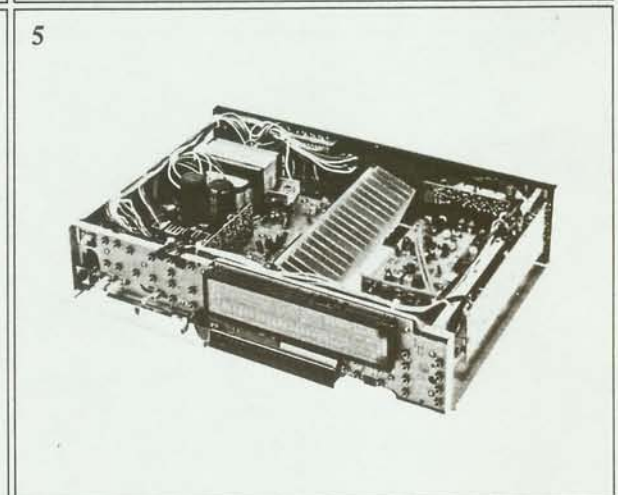
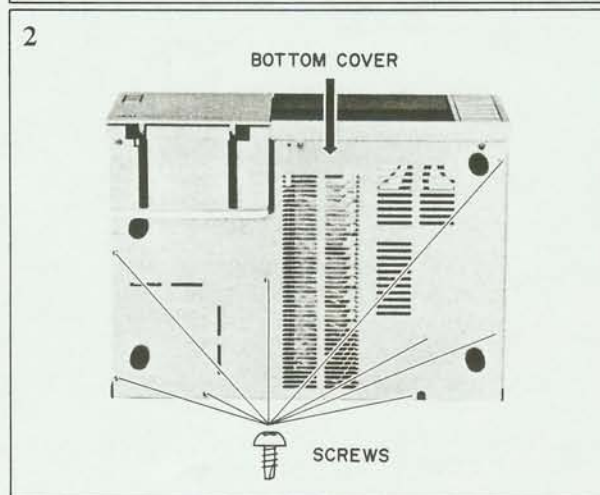
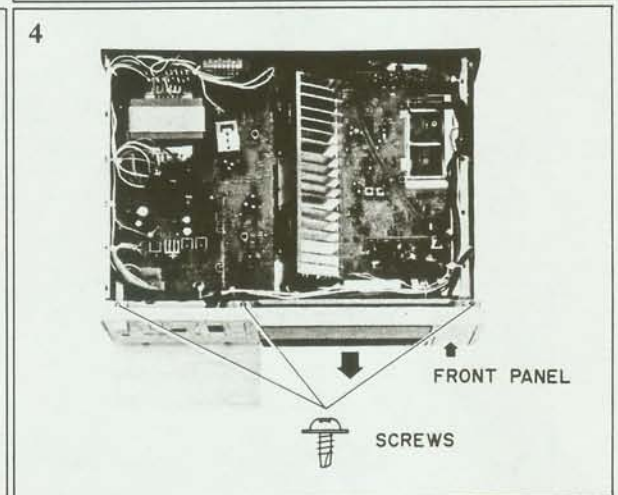
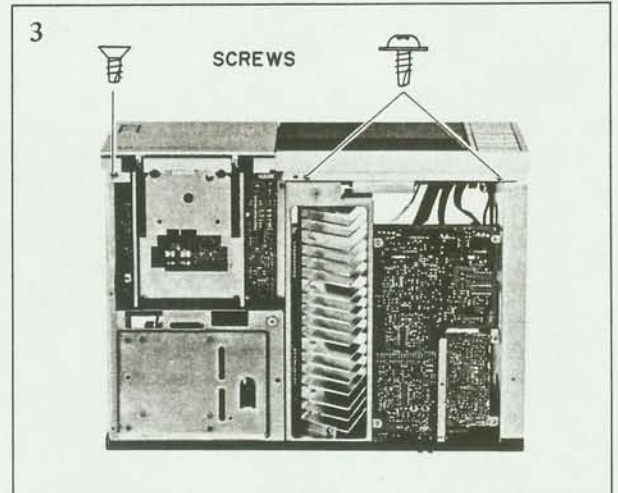
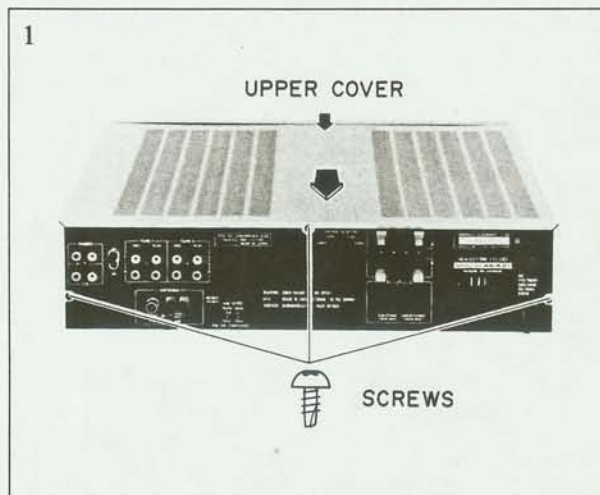

III. CONTROLS

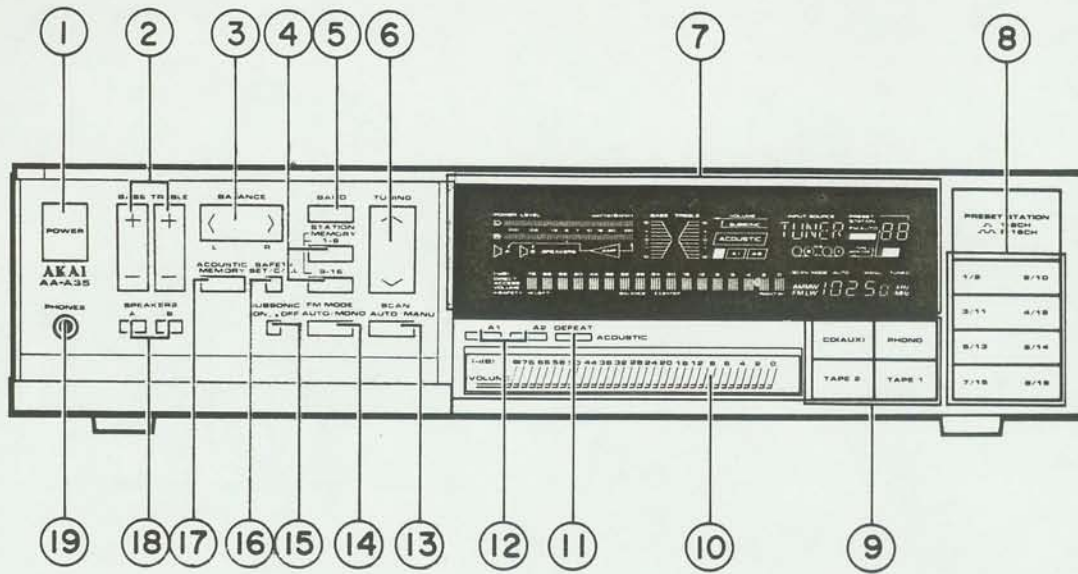

Fig. 3-1 Front View

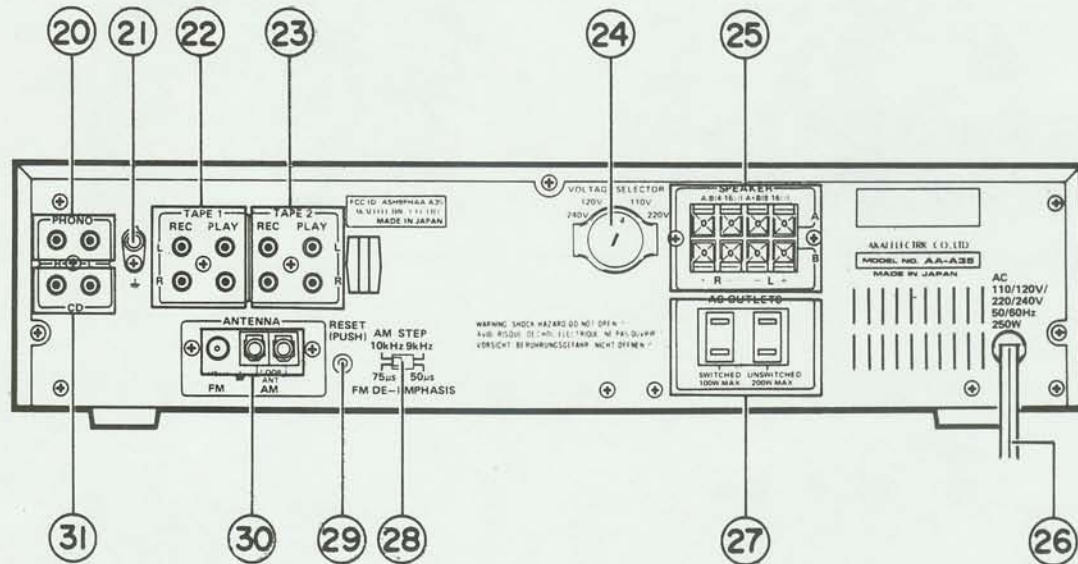

Fig. 3-2 Rear View

- | | |
|----------------------------------------------------------------------|-------------------------------------------------------|
| 1. POWER SWITCH | 17. ACOUSTIC MEMORY BUTTON |
| 2. TONE CONTROL (BASS, TREBLE) BUTTONS | 18. SPEAKER SELECTORS (A and B) |
| 3. BALANCE BUTTON | 19. PHONES JACK |
| 4. STATION MEMORY (1 to 8 & 9 to 16) BUTTONS | 20. PHONO JACKS |
| 5. BAND SELECTOR (FM, AM(MW), LW) BUTTON | 21. GROUND TERMINAL |
| 6. TUNING CONTROL BUTTON | 22. TAPE 1 (REC/PLAY) JACKS |
| 7. FL DISPLAY | 23. TAPE 2 (REC/PLAY) JACKS |
| 8. PRESET STATION BUTTONS | 24. VOLTAGE SELECTOR (U mode only) |
| 9. INPUT SOURCE SELECTOR BUTTONS
(CD(AUX), PHONO, TAPE 1, TAPE 2) | 25. SPEAKER TERMINALS (A and B) |
| 10. DIRECT ACCESS VOLUME CONTROL | 26. AC POWER CORD |
| 11. DEFEAT BUTTON | 27. AC OUTLETS |
| 12. ACOUSTIC MEMO A1 and A2 BUTTONS | 28. AM STEP/FM DE-EMPHASIS SELECTOR
(U model only) |
| 13. SCAN AUTO/MANU SELECTOR BUTTON | 29. RESET BUTTON |
| 14. FM MODE AUTO/MONO BUTTON | 30. ANTENNA TERMINALS |
| 15. SUBSONIC FILTER SWITCH | 31. CD(AUX) JACKS |
| 16. SAFETY SET/CALL BUTTON | |

IV. PRINCIPAL PARTS LOCATION

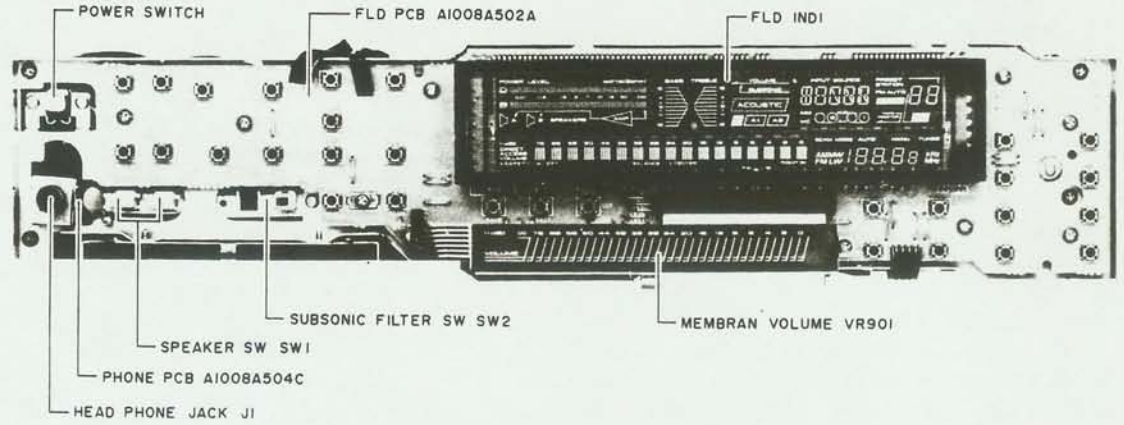

Fig. 4-1 Front View

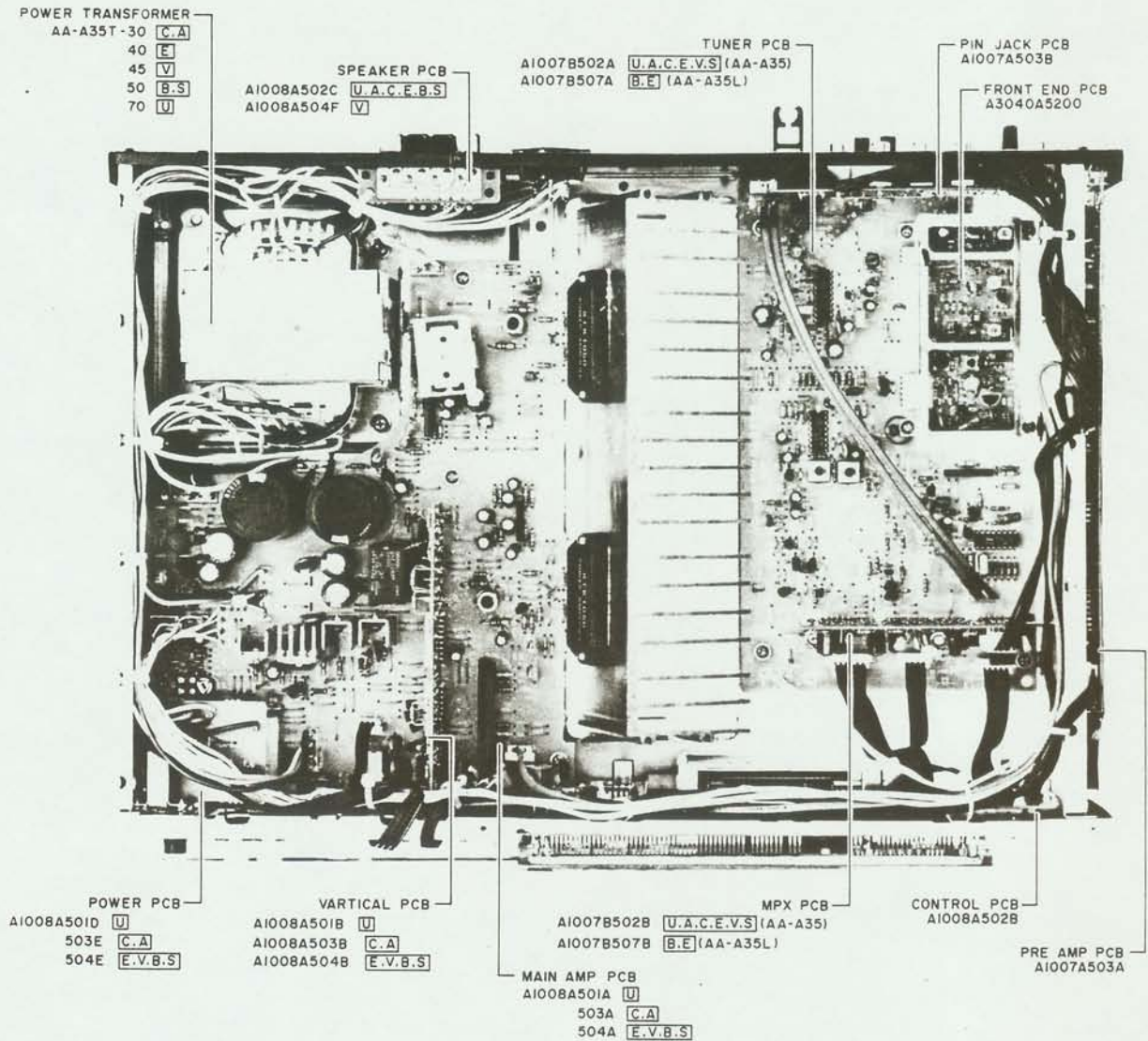

Fig. 4-2 Top View

V. DESCRIPTION OF THE CIRCUIT OPERATION

5-1 AMPLIFIER PERFORMANCE

5-1-1 General Description

(1) Functions

a) Input Selector Control

This microcomputers is capable of controlling analog switch TC9164N that serves as the input selector. Three input systems that include PHONO, CD, and TUNER, and two monitoring systems that include TAPE 1 and TAPE 2 may be controlled.

b) Direct Access Volume Control

Reads voltages detected out of the sound-volume touch control through an A/D converter, and sets the electronic potentiometer in accordance with the read data. In this process, any designated setting will be reached from the earlier potentiometer position by fading in or out.

c) Balance Control

By setting various level differences between Lch and Rch on the main control, up to a maximum of 30dB L-R level offsets may be created.

d) Tone (BASS/TREBLE) Control

Operates the tone control potentiometer (TC9156P) in 2dB steps up to a maximum of ± 10 dB, and thereby performs as an electronically controlled tone circuit.

f) Acoustic Pattern Storage

By this function, stores in the microcomputer two patterns of the tone control circuit settings, and enables the instant loading of either of the stored patterns.

g) Volume Control Safety Function

With the touch control operated direct access sound volume system that enables the instant setting of any preferred sound volume level, the danger exists that the inadvertent touch of a higher position of the control will cause a sudden emission of unexpectedly high sounds from speakers. A time lag measure in the form of fade-in's has been provided to enable coping with the above danger, but as an added and positive precaution, this safety function has been added on that suppresses all sounds louder than a level set in advance.

h) TUNER Direct Function

This function will set the input selector at TUNER upon receiving data from the microcomputer (A1007T) for the tuner that is output as soon as the tuner has been operated.

5-1-2 Key Input and Dynamic FL Display Strokes

Key inputs and FL displays are both handled dynamically, and their basic clock signals generated by the ITMR interrupt (1,024 Hz) for the output of strobe signals.

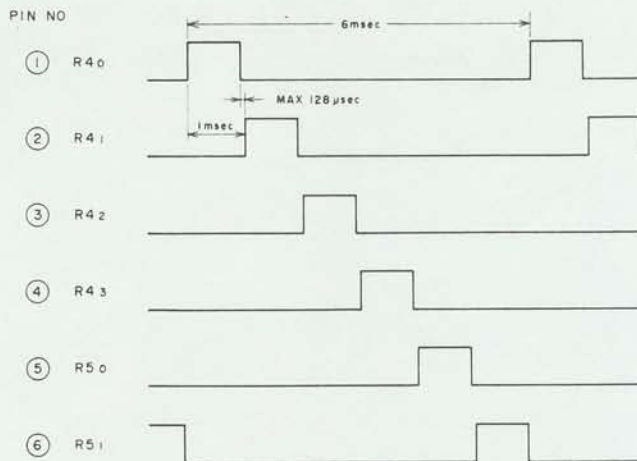

Fig. 5-1

5-1-3 Acceptance of Key Inputs

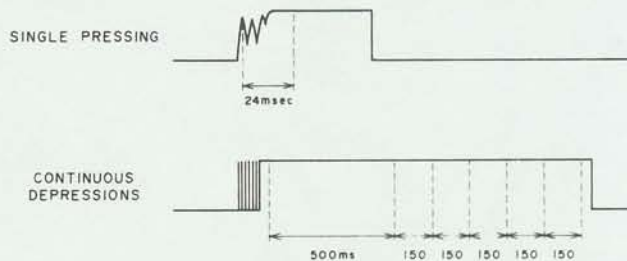

Fig. 5-2

- Chatterings will be absorbed for 24 msec.
- Continuous depressions will be accepted first at 24 msec after the depression start, second at 500 msec after the first, and then at every 150 msec thereafter.
- All multiple depressions shall be inhibited. Once a multiple depression is made, no key inputs will be accepted until after all of the depressed keys have been released.

5-1-4 Key Processings

(1) [PHONO], [CD]

Sets the input selector (TC9164N) for either of the input modes keyed in, and makes due indications for it. Nothing, however, will occur when the depressed key mode has already been engaged.

When either TAPE 1 or TAPE 2 has been keyed on, the displays for a tape monitored input will be flashed on and off for 10 times at a 1/2 duty and once every second, to alert the operator of the ongoing tape monitoring. In addition, when serial data is being transferred to the analog switch, the

electronic potentiometer will be muted, to prevent the leakage of switching noises to the output circuit. (The AA-A35/L has no "TUNER" key, but the necessary input selection will be made by command data from the micro-computer (A1007T) incorporated in the tuner.)

(2) [TAPE 1], [TAPE 2]

Each single pressing of either key will switch its monitoring status between ON and OFF from one to the other, and its indication also turn ON and OFF accordingly. In addition, during the transfer of serial data to the analog switch, the electronic potentiometer will be muted to prevent the leakage of switching noises to the output.

This, however, does not apply to TAPE 1 key operations with TAPE 2 in an ON mode.

(3) [VOLUME]

When the sound volume display is being made, either fades the sound volume display is being made, either fades in or fades out to the touched position from an immediately preceding level. The phasing speed will be 2 dB per 60 msec. However, when the touched position is above the "Safety" engaged position, the foregoing operation will be made only up to that "Safety" position. As for the display, the touched position (within the "Safety" range) will instantly be displayed upon touching.

When either the Balance or the Safety Level is being displayed, the display will be switched to the Volume. Operations thereafter will conform with the above process.

(4) [BALANCE L], [BALANCE R]

When the Balance is being displayed, data will be transferred to provide the designated level offsets between Lch and Rch of the electronic potentiometer, and the display will also synchronize therewith. When continuously depressed, however, the potentiometer setting will start varying at 500 msec after the depression start, and will thereafter vary at 2 dB per 150 msec, but linger for 750 msec at the center position when passing through it. (The display will vary at 2 dB per step in the immediate vicinity of the center position, but at 4 dB per step in all other areas.)

When these keys are pushed while either the Volume or the Safety Level is being displayed, the display will be switched to the Balance.

(5) [SAFETY]

- When either the Volume or Balance position is being displayed:

A single press of the key will first have the Safety Level position at the time displayed. This display will revert to the Volume position display 5 seconds later, but if the Safety key is depressed continuously for one second or longer, the display will be switched to that of the Volume, and the

Safety indicator will flash on and off every second at a 1/2 duty. This signifies a Safety changing mode to have been engaged, where any Volume level up to Max may be selected, and the mode will be sustained for one minute. In other words, the one minute after the beginning of the Safety flashing represents a Safety Level setting time duration.

- When the Safety indicator is flashing on and off: The Volume position touched in this duration will be set as the Safety Level that represents the sound volume level not be exceeded by any subsequent acoustic output. As long as the Safety Level set is other than the maximum potentiometer position, the Safety indicator will be lit steadily, but when it is at the maximum position, the indicator will go off.

(6) [BASS+], [BASS-], [TREBLE+], [TREBLE-]

Each single pressing of one of these keys will either raise or lower the electronic potentiometer for either BASS or TREBLE. When it is depressed continuously, the first potentiometer up/down shifting operation will be performed when 500 msec have elapsed since the depression start, and the subsequent operation at the rate of 150 msec per step. When the shifting passes through the center position, it will linger there for 750 msec before moving further on. The display will also vary conforming with individual key operations.

(7) [DEFEAT]

Restores the BASS/TREBLE positions all at the center, regardless of their earlier potentiometer positionings.

(8) [MEMO]

Engages an acoustic pattern storage standby mode. At this time, the ACOUSTIC MEMO indicator will turn on, and the A1 and A2 indicators flash on and off for 10 times at a 1/2 duty in 1-second cycles (at 1 Hz).

Even before 5 seconds are up, the standby mode may be disengaged by pushing any other key than [A1] and [A2].

(9) [A1], [A2]

- When at Standby for Acoustic Pattern Storage: Stores the current BASS/TREBLE positions in the memory, and will disengage the storage standby mode.
- When in any other mode than Acoustic Pattern Storage Standby: Loads the stored BASS/TREBLE positions, that is, sets the potentiometers instantly at those positions and their displays at the same time.

5-1-5 Input Selector Analog Switch (TC9164N)

Controls the electronic potentiometer (TC9176P) and the tone potentiometer (TC9156P).

(1) Serial Data Structure

The serial data is composed of 3 parallel bits that include DATA, CK, and ST, and the numbers of serial bits of the individual potentiometers have been made as follows:

- TC9164N → 14 bits
- TC9176P → 20 bits
- TC9156P → 18 bits

Control lines DATA and CK for the TC9176P and TC9156P have been made common with control lines ST-WR and CE for A/D converter LC7910, because A/D conversion and data transfers to the potentiometers will never occur simultaneously, and no changes in the status of potentiometers will take place as long as no ST are issued.

[Data Timing Schematic Diagram]

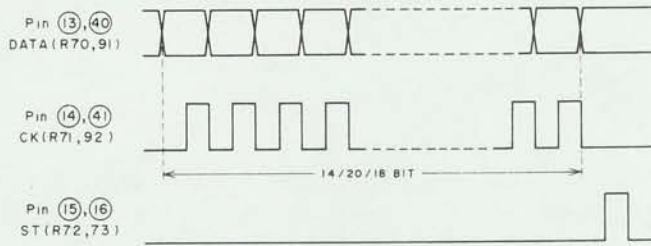

Fig. 5-3

(2) Data Buffers

Data buffers for the TC9164N are formed in RAMs MFSRD0 through MFSRD3, and those for the TC9176P and TC9156P in RAMs MVSRD0 through MVSRD4. Their allocation charts are shown in Tables 5-1 to 5-3.

a) Buffers for the Input Selector Switch (TC9164N)

MFSRD3				MFSRD2				MFSRD1		MFSRD0			
Unused	PHONO	CD	TUNER	SOURCE 1	TAPE1 PB	SOURCE 2	TAPE2 PB	L	R	C ₁	C ₂	C ₃	C ₄
0				0	1	1	0	1	1	0	1	0	0

→ Fixed Data

ON OFF

Table 5-1

Bits 2 and 3 of MFSRD1 will not be transmitted.

b) Buffers for the Master Potentiometer (TC9176P)

MVSRD4			MVSRD3				MVSRD2				MVSRD1				MVSRD0			
L	R	0	2	4	6	8	0	10	20	30	40	50	60	70	C ₁	C ₂	C ₃	C ₄
		0													0	0	0	1

→ Fixed Data

Table 5-2

c) Buffers for the Tone Potentiometer (TC9156P)

MVSRD4				MVSRD3		MVSRD2				MVSRD1		MVSRD0			
+5	+4	+3	+2	+1	0	1	-2	-3	-4	-5	L	R	C ₁	C ₂	C ₃
				0	0					1		1	0	1	0
				0	0					1		1	1	0	0

→ For BASS
→ For TREBLE

Table 5-3

5-2 TUNER PERFORMANCE

5-2-1 General Description

(1) Functions

- a) 20-Ch or 16-Ch Random Presetting of Stations
When initialized, discriminates between A45 and A35/25, and against A45, enables 10 stations each front (1 to 10) and back (11 to 20) or a total of 20 stations to be preset, while against A35/25, enables 8 stations each front (1 to 8) and back (9 to 16) or a total of 16 stations to be preset. The presetting permits the random storage of station data irrespective of band, and for FM stations, the MONO/STEREO segregating data will also be contained in the storage.
- b) Two Tuning Styles: AUTO and MANUAL
The AUTO Scan Tuning that once the UP/DOWN key is pushed, will continue scanning until a station is captured, and once it is captured, will stop scanning, and the MANUAL Tuning that will scan only when the key is held down, and when it is released, will stop scanning, are the two tuning styles enabled.
(LW is shifted in 1K steps for MANUAL and 9K steps for AUTO.)
- c) Switching of MONO and STEREO Receiving Modes
The MONO/STEREO mode switching function has been incorporated for FM reception, and is also included in the stored station presetting data.

5-2-2 Acceptance of Key Input

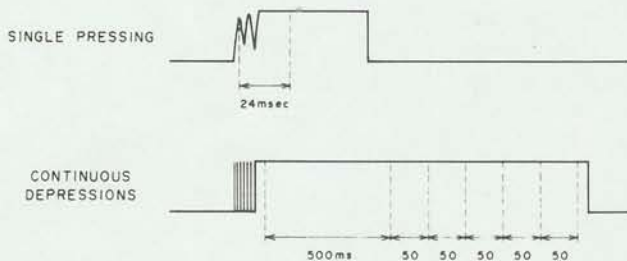

Fig. 5-4

- Chatterings will be absorbed for 24 msec.
- Continuous depressions will be accepted first at 24 msec after the depression start, second at 500 msec after the first, and then at every 50 msec thereafter.
- All multiple depressions shall be inhibited. Once a multiple depression is made, no key inputs will be accepted until after all of the depressed keys have been released.

5-2-3 Initial Setting (RST Mode)

- a) FL Display:



Fig. 5-5

- b) The received frequency will be at the lowest in the FM band for each destination:
- c) The mode will be STEREO (FM AUTO).
- d) The scan mode will be MANUAL.
- e) All the preset channels will be at the lowest FM frequency.
- f) The last frequencies of individual bands of the tuner will be the lowest frequencies.

5-2-4 Status in a Backup Mode

Basically, the status immediately before engaging the backup will all be sustained, but slight deviations will be involved, as listed below.

- a) When a backup mode is engaged during AUTO SCAN, the scanning will stop.
- b) When a backup mode is engaged in a storage standby mode, the standby will be disengaged.
- c) The pre-backup status will be sustained for about 3 weeks.

5-2-5 Active and Non-Active Modes at Tuner

(1) Active Mode

This is a mode after the data has been transmitted to the microcomputer (A1007A) of AMP to have the input selector of AMP switched to TUNER, that is, a mode where all the tuner performance has been enabled.

The data for the microcomputer of AMP will be transmitted from port R4₁ (A1007T Pin ②) when the BAND, UP/DOWN, and Preset CH keys have been pushed, and its timing will be as illustrated below.

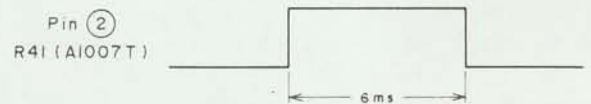

Fig. 5-6

(2) Non-Active Mode

This is a mode where the tuner performance has been partially constrained. It is engaged by detecting an [H] level of the line connected to R7₂ (A1007T Pin 15) of the subject microcomputer, which has been brought about by the microcomputer of AMP in switching the input selector of AMP to other than TUNER, either PHONO or CD, and by judging the tuner thereby not to be listened to.

Relative to the display, the frequency display will be extinguished, and bars displayed instead, to signify a non-active mode.



Fig. 5-7

Relative to the operating performance, will accept only the BAND, UP/DOWN, and Preset CH keys, and reject all the other keys.

5-2-6 Auto-Tuning

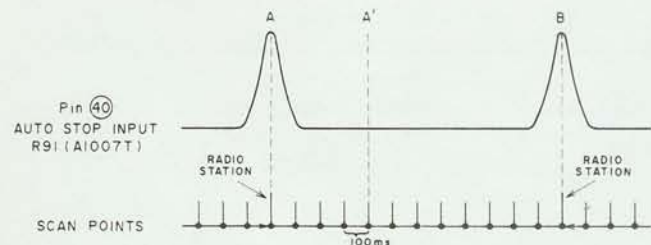

Fig. 5-8

The starting point in auto tuning modes may either be a broadcast receiving point or a point where no broadcast is received.

Since stopping the scan merely at an [H] level of the auto-stop signal may therefore cause nonconformities, the process employed is to stop scanning only when the auto-stop signal has first dropped to an [L] level after the scanning start and then has climbed to an [H] level.

The scanning speed is about 100 msec per step. The step will be a single channel spacing in the receiving band that varies by destination. Auto-scanning of LW, however, is an exception to this rule and 9 kHz steps have been assigned to it, where fixed points $9N+2$ or $9N$ ($N = \text{an integer}$) will be scanned.

In other words, against any given point selected earlier by a manual scan, the scanning start when an auto-scanning mode is engaged will always be at a point $9N+2$ or $9N$.

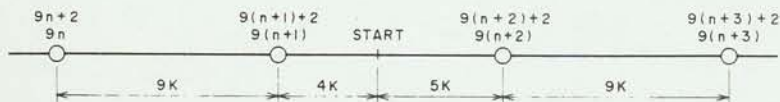

Fig. 5-9

5-2-7 Tuner Output Muting

This microcomputer will mute the tuner signal when the BAND data or PLL data is changed by the [BAND], [UP], [DOWN], [MODE], or Preset CH key, or when the receiving mode is changed.

In the muting process, when 50 msec have elapsed since the initial muting start, data transfer and other processings will be made, and then, 450 msec after these processes have been concluded, the muting will be disengaged. We will call the initial part "pre-muting" and the latter trailing part "after-muting".

The diagram below illustrates the above arrangement.

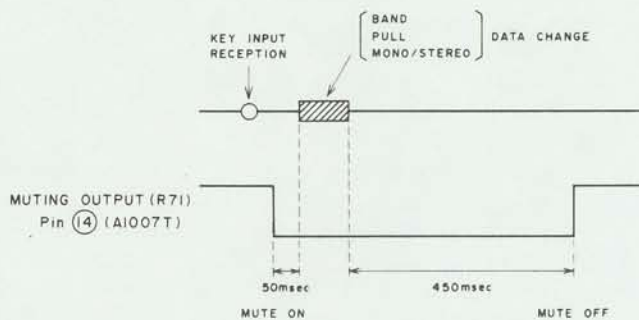

Fig. 5-10

As exceptional cases, when an earlier muting process is still ongoing upon receipt of another key input, the 50 msec pre-muting will be omitted.

5-2-8 Key Processing

(1) [BAND]

Each single press of this key will switch the band. The selecting sequences will be as follows:



Fig. 5-11

(2) [UP], [DOWN]

In a manual scan mode, each single pressing of either of these keys will shift the receiving frequency by a step, and its continuous depression will have the band scanned at 50 msec per step. In a AUTO scan mode, the band will be scanned at 100 msec per step until a station is captured, at which time an auto-stop of the scanning will be exercised. In an auto-scan mode, as soon as any other key than [UP] and [DOWN] is pushed, the scanning will be stopped at that point.

(3) **Preset CH Key**

a) When the Tuner is in an Active Mode:

Except when at standby for storage, a single pressing of one of the preset channel keys will load the front (1 to 8) and back (9 to 16) side channels under that key alternately, and the FLD will display the number of the channel thus loaded.

When at standby for storage, the frequency currently being received will be stored in either the front (1 to 8) or back (9 to 16) side memory until under the key that has been pushed, and the storage standby mode will then be disengaged.

b) When the Tuner is in a Non-Active Mode:

A push of one of the keys will have the front side preset channel (1 to 8) under that key loaded, and have data transmitted to the microcomputer of AMP to switch the input selector of AMP to TUNER.

However, when in the last active mode of the tuner, a back side (9 to 16) channel had been listened to, and that channel key is now pushed, the loading effected will not be that of the front side (1 to 8) but of the back side (9 to 16) channel.

(4) **[MEMO 1 - 8], [MEMO 9 - 16]**

These are the keys for storing a channel frequency data in the Preset CH, and used for channels 1 to 8 and 9 to 16, respectively. Specifically, when either of the keys is pushed, the MEMO Indicator will be lit, and the channel number display flashed on and off, to alert the operator as to which side of the Preset CH key, 1 to 8 or 9 to 16, is being operated.

For 1 to 8:

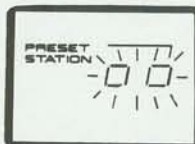

For 9 to 16:



Fig. 5-12

The above mode will be sustained for 5 seconds, and the flashing repeated for 10 times at a 1/2 duty. When, however, the Preset CH key is pushed for data storage, or when any other key is pushed, the storage standby mode will be instantly disengaged.

When the tuner is in a non-active mode, nothing will occur.

(5) **[MODE]**

Each single pressing of this key will switch the FM reception between MONO and STEREO from one to the other.

When the tuner is in a non-active mode, nothing will occur.

(6) **[SCAN MODE]**

Each single pressing of this key will switch the scan mode between AUTO and MANUAL from one to the other, and due indications made at the same time.

VI. AMPLIFIER SECTION ADJUSTMENT

6-1 THE INSTRUMENT CONNECTION

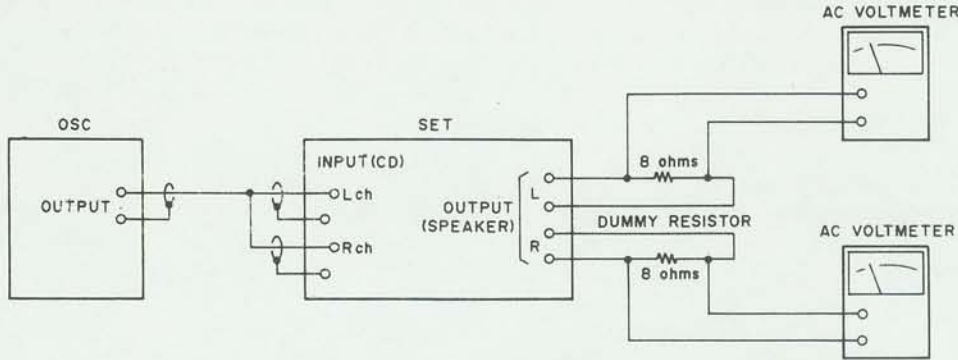

Fig. 6-1 Instrument Connections for Amplifier Section Adjustment

6-2 MAIN AMP PC BOARD ADJUSTMENT POINTS

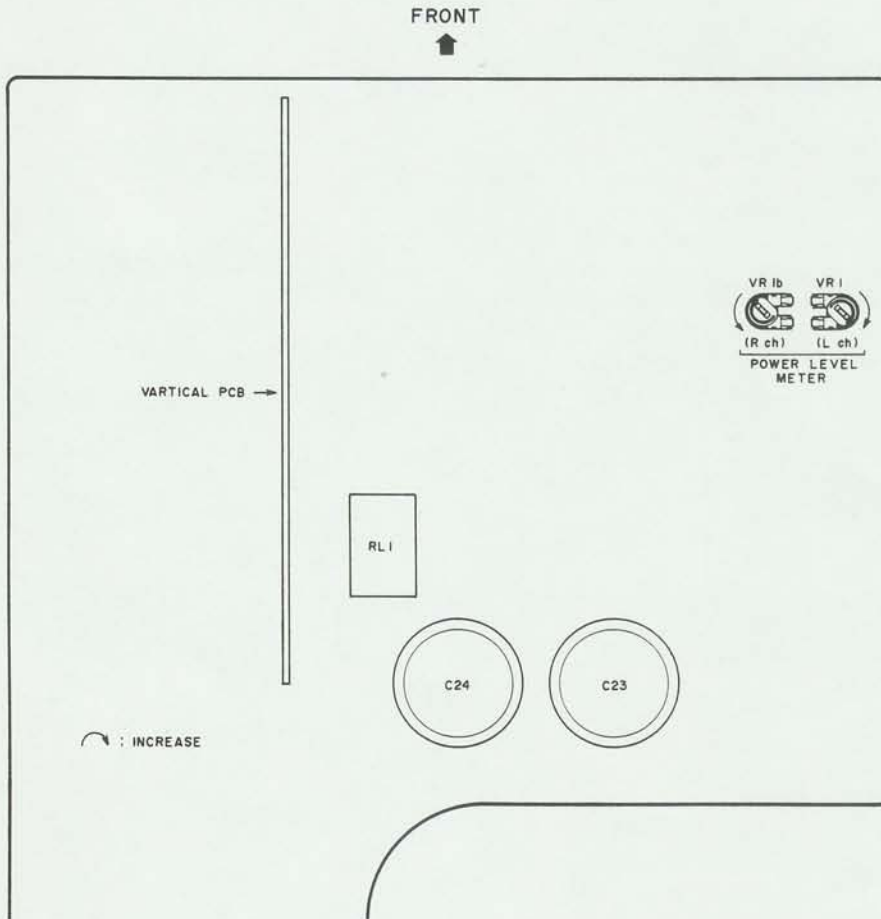

Fig. 6-2 Main-Amp PCB

6-3 POWER LEVEL METER ADJUSTMENT

Set DIRECT ACCESS VOLUME (MEMBRAN VOLUME) to maximum and TONE control to flat.

Supply 1 kHz to CD input jacks (both left and right CH) and adjust OSC output so that the AC voltmeters indicate 15.5V. Adjust VR1 so that the POWER LEVEL meter indicates 30W.

VII. TUNER ADJUSTMENT

7-1 THE INSTRUMENT CONNECTIONS

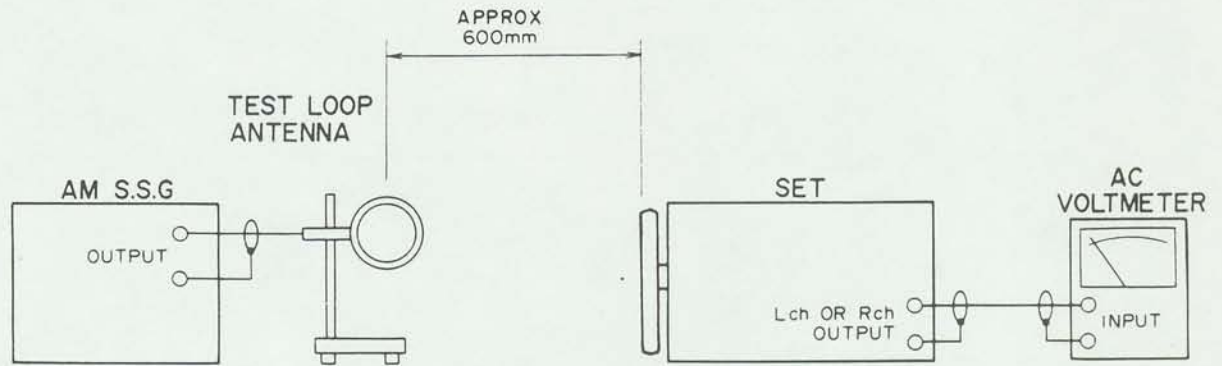

Fig. 7-1 Instrument Connections for AM (MW, LW) Section Adjustment

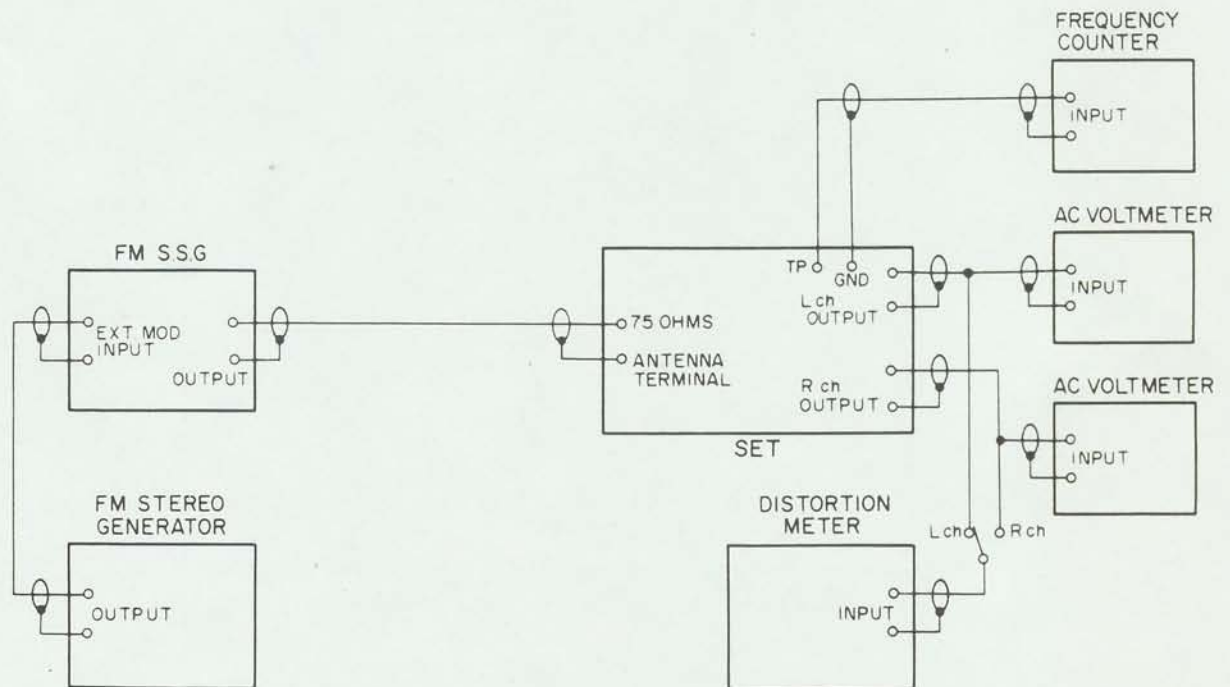

Fig. 7-2 Instrument Connections for FM Section Adjustment

7-2 TUNER, FRONT END, MPX PC BOARD ADJUSTMENT POINTS

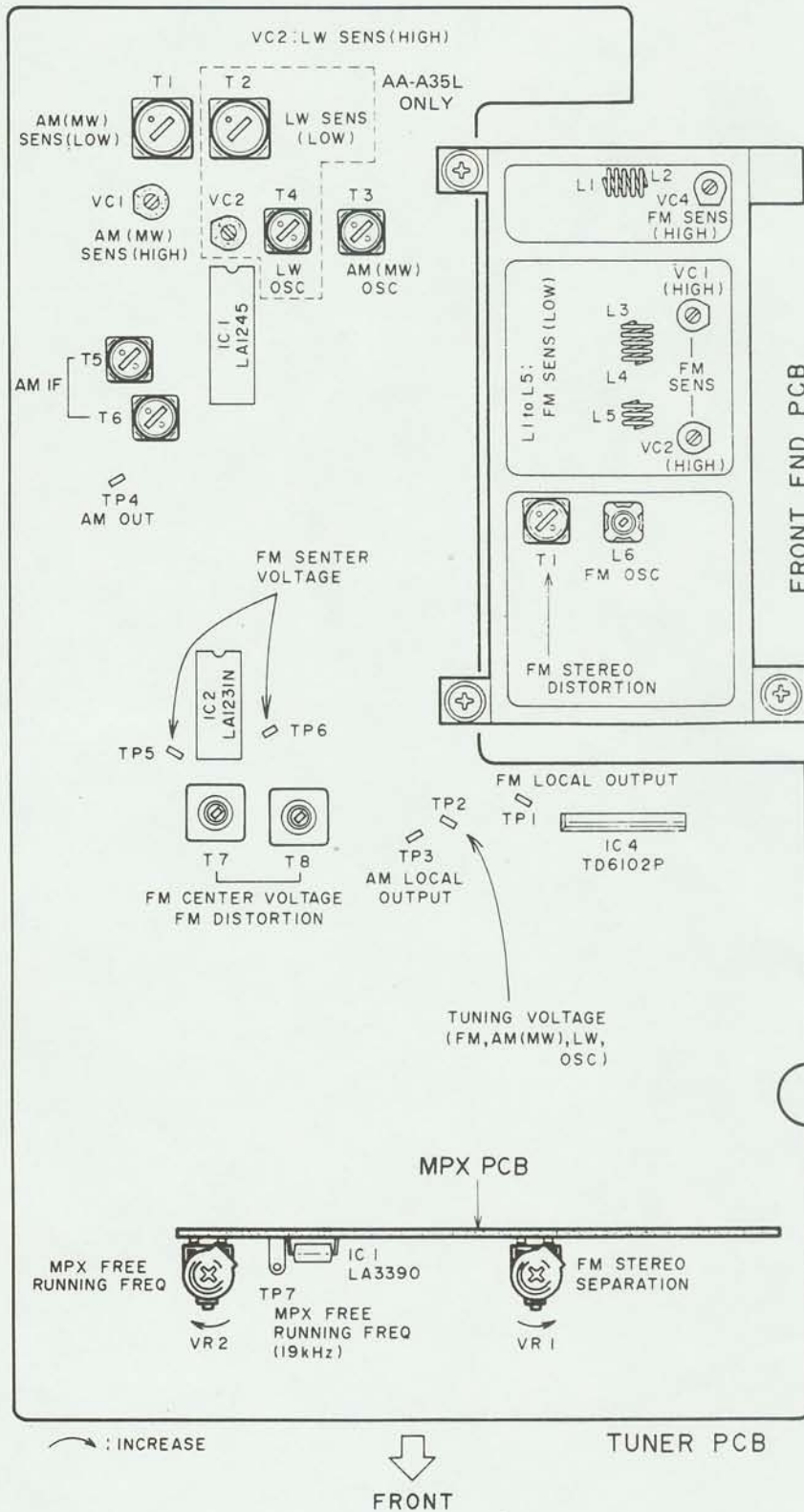

Fig. 7-3

7-3 HOW TO CALL THE PRESET FREQUENCY FOR THE TUNER ADJUSTMENT

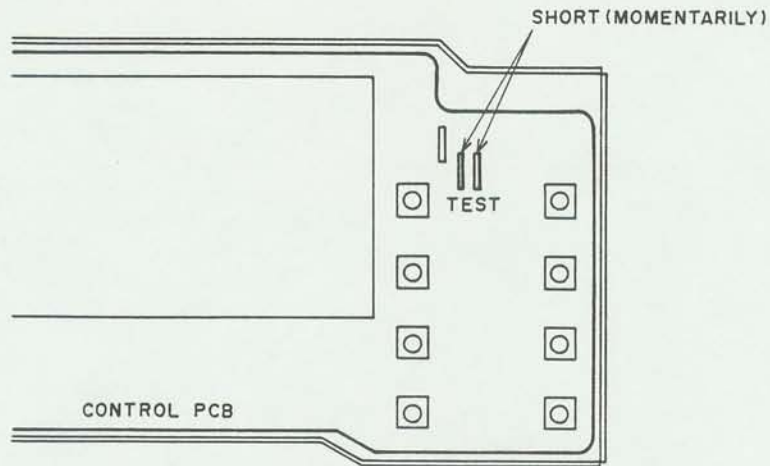

Fig. 7-4

Tuner preset frequencies for adjusting RF, IF and FM demodulator are able to preset as follows instead of operating TUNING control button to get the test frequencies from Signal Generator.

Short-circuit momentarily two test points shown in Fig. 7-4. Then select required test frequency by pushing one of the Preset Station buttons according to Chart 7-1.

	PRESET STATION CH								
	Buttons CH	1/9	2/10	3/11	4/12	5/13	6/14	7/15	8/16
USA & CANADA	1 to 8	AM 600kHz	AM 1000kHz	AM 1400kHz	FM 88.0MHz	FM 90.0MHz	FM 98.0MHz	FM 106.0MHz	FM 108.0MHz
	9 to 16	AM 530kHz	AM 1000kHz	AM 1611kHz	FM 87.4MHz	FM 90.0MHz	* FM 98.0MHz	FM 106.0MHz	FM 108.1MHz
EUROPE 3 BAND	1 to 8	MW 603kHz	MW 999kHz	MW 1404kHz	FM 88.0MHz	FM 90.0MHz	FM 98.0MHz	FM 106.0MHz	FM 108.0MHz
	9 to 16	MW 522kHz	MW 999kHz	MW 1611kHz	LW 146kHz	LW 160kHz	LW 200kHz	LW 300kHz	LW 353kHz
EUROPE 2 BAND UNIVERSAL AREA	1 to 8	AM 603kHz	AM 999kHz	AM 1404kHz	FM 88.0MHz	FM 90.0MHz	FM 98.0MHz	FM 106.0MHz	FM 108.0MHz
	9 to 16	AM 522kHz	AM 999kHz	AM 1611kHz	FM 87.4MHz	FM 90.0MHz	* FM 98.0MHz	FM 106.0MHz	FM 108.1MHz

* = FM AUTO

Chart 7-1

NOTE: For U model only, set AM STEP switch to 9kHz position, which located on the rear panel.

7-4 FM SECTION ADJUSTMENT

Step	Adjustment Item	Adjustment Point	Result	Remarks
1	FM OSC	L6 (in FRONT END PCB)	12V at 108.1MHz	Band SW to FM 108.1MHz Mono input. Display to 108.1MHz. Connect DC Voltmeter to TP2.
2	Low Range Sensitivity	L1 to L5 (in FRONT END PCB)	Less than 10dB input from SSG	FM mode SW to Mono 90MHz, Mono input. Display to 90MHz. 3% Distortion Factor.
3	High Range Sensitivity	VC1, 2, 4 (in FRONT END PCB)	Less than 10dB input from SSG	106MHz, Mono input. Display to 106MHz. 3% Distortion Factor.
4	For best Result, Repeat Steps 2 and 3 two or three times			
5	Middle Range Sensitivity (Confirmation)	None	Less than 10dB input from SSG	98MHz, Mono input. Display to 98MHz. 3% Distortion Factor.
6	FM Center Voltage	T7, T8	0V indication	DC Voltmeter between TP5 and TP6. Tune only noise without interference from broadcasting.
7	Distortion (Mono)	T7, T8	Less than 0.3%	98MHz, 60dB, Mono input. Display to 98MHz. Confirm that the DC Voltage between TP5 and TP6 is within $0 \pm 0.025V$.
8	MPX Free Running Frequency	VR2 (in MPX PCB)	19kHz	98MHz, 60dB Stereo input. Display to 98MHz. Connect Frequency Counter to TP7 (in MPX PCB).
9	Stereo Separation	VR1 (in MPX PCB)	More than 38dB	98MHz, 60dB, Stereo L-CH (R-CH) input: Display to 98MHz. Minimum output of R-CH (L-CH)
10	Distortion (Stereo)	T1 (in FRONT END PCB), T7, T8	Less than 0.5%	98MHz, 60dB Stereo (L-CH or R-CH) input. Display to 98MHz. Confirm that the DC voltage between TP5 and TP6 within $0 \pm 0.025V$.

- NOTES:**
1. Set the internal modulation signal generator to 100% (75kHz dev. (in Europe) 40kHz dev.), 1kHz of each.
 2. Adjust T1 (Front End), if the proper distortion (STEREO) could not obtained in step 10. (Confirm FM Sensitivity in case is turned more than a half turn).

7-5 LW SECTION ADJUSTMENT (for AA-A35L)

Step	Adjustment Item	Adjustment Point	Result	Remarks
1	LW OSC	T4	7.0V at 353kHz	Band SW to LW. 353kHz input. Display to 353kHz. Connect DC Voltmeter to TP2.
2	Low Range Sensitivity	T2	Less than 65 dB input from SSG	160kHz input. Display to 160kHz. 10% Distortion Factor.
3	High Range Sensitivity	VC2	Less than 65dB input from SSG	300kHz input. Display to 300kHz. 10% Distortion Factor.
4	For best Result, Repeat steps 2 and 3 two or three times			
5	Middle Range Sensitivity (Confirmation)	None	Less than 65dB input from SSG	200kHz input. Display to 200kHz. 10% Distortion Factor.
6	Distortion (Confirmation)	None	Less than 2.5%	200kHz, 74dB input. Display to 200kHz.

NOTE: Set the internal modulation signal generator to 30%, 1kHz of each.

7-6 AM (MW) SECTION ADJUSTMENT

Step	Adjustment Item	Adjustment Point	Result	Remarks
1	AM (MW) OSC (See NOTE 3)	T3	6.7V at 1400kHz (1404kHz)	Band SW to AM (MW) 1400kHz, (1404kHz) input. Display to 1400kHz (1404kHz). Connect DC Voltmeter to TP2.
2	Low Range Sensitivity	T1	Less than 60dB input from SSG	600kHz (603kHz) input. Display to 600kHz (603kHz) 10% Distortion Factor.
3	High Range Sensitivity	VC1	Less than 60dB input from SSG	1400kHz (1404kHz) input. Display to 1400kHz (1404kHz). 10% Distortion Factor.
4	For best Result, Repeat steps 2 and 3 two or three times			
5	Middle Range Sensitivity (Confirmation)	None	Less than 60dB input from SSG	1000kHz (999kHz) input. Display to 1000kHz (999kHz) 10% Distortion Factor.
6	Distortion (Confirmation)	None	Less than 2.0%	1000kHz, (999kHz) 74dB input. Display to 1000kHz (999kHz).
7	AM IF	T5, T6	Maximum output Minimum Distortion	1000kHz (999kHz) 74dB input. Display to 1000kHz (999kHz).

- NOTES:**
1. Set the internal modulation signal generator to 30%, 1kHz of each.
 2. (kHz) in Result & Remarks indicates the test frequencies in AM 9kHz STEP area.
 3. For the model AA-A35L, adjust LW OSC prior to this adjustment for the best result.

VIII. PC BOARD TITLES AND IDENTIFICATION NUMBERS

MODEL AA-A35

PC Board Title		PC Board Number	Remarks
MAIN AMP	PC BOARD	A1008A501A	U
		A1008A503A	C, A
		A1008A504A	E, V, S
POWER	PC BOARD	A1008A501D	U
		A1008A503E	C, A
		A1008A504E	E, V, S
PHONE	PC BOARD	A1008A501C	U
		A1008A503C	C, A
		A1008A504C	E, V, S
VERTICAL	PC BOARD	A1008A501B	U
		A1008A503B	C, A
		A1008A504B	E, V, S
SPEAKER	PC BOARD	A1008A502C	U, C, A, E, S
		A1008A504F	V
FILTER	PC BOARD	A1008A504G	V
PRE AMP	PC BOARD	A1007A503A	
PIN JACK	PC BOARD	A1007A503B	
FLD	PC BOARD	A1008A502A	
CONTROL	PC BOARD	A1008A502B	
TUNER	PC BOARD	A1007B502A	U, C, A, E, V, S
MPX	PC BOARD	A1007B502B	U, C, A, E, V, S
FRONT END	PC BOARD	A3040A5200	

MODEL AA-A35L

PC Board Title		PC Board Number	Remarks
MAIN AMP	PC BOARD	A1008A504A	
POWER	PC BOARD	A1008A504E	
PHONE	PC BOARD	A1008A504C	
VERTICAL	PC BOARD	A1008A504B	
SPEAKER	PC BOARD	A1008A504F	
PRE AMP	PC BOARD	A1007A503A	
PIN JACK	PC BOARD	A1007A503B	
FLD	PC BOARD	A1008A502A	
CONTROL	PC BOARD	A1008A502B	
TUNER	PC BOARD	A1007B507A	B, E
MPX	PC BOARD	A1007B507B	B, E
FRONT END	PC BOARD	A3040A5200	

SECTION 2

PARTS LIST

TABLE OF CONTENTS

RECOMMENDED SPARE PARTS	25
1. TUNER PC BOARD BLOCK	26
2. FRONT END PC BOARD BLOCK	26
3. PRE AMP PC BOARD BLOCK	27
4. MAIN AMP PC BOARD BLOCK	27
5. CONTROL PC BOARD BLOCK	28
6. ASSEMBLY BLOCK	28
7. FINAL ASSEMBLY BLOCK	30
INDEX	31

Resistors and Capacitors which are not listed in this parts list, please refer to COMMON LIST FOR SERVICE PARTS.

ATTENTION

1. When placing an order for parts, be sure to list the parts no. model no., and description. There are instances in which if any of this information is omitted, parts cannot be shipped or the wrong parts will be delivered.
2. Please be careful not to make a mistake in the parts no. If the parts no. is in error, a part different from the one ordered may be delivered.
3. Because parts number and parts unit supply in the Preliminary Parts List may be partially changed, please use this parts list for all future reference.

HOW TO USE THIS PARTS LIST

1. This Parts List shows the parts that are considered necessary for repairs. Other parts, such as resistors and capacitors, are shown in the "Common List for Service Parts". Select and order such parts from the "Common List for Service Parts".
2. The Recommended Spare Parts shows those parts in the Parts List which are considered particularly important for service.
3. Parts not shown in the Parts List and "Common List for Service Parts" will not be supplied in principle.
4. How to read list

a) Mechanism Block

b) P.C Board Block

2. HEAD BASE BLOCK

REF. NO.	PARTS NO.	DESCRIPTION
2-1x	BH-T2023A320A	HEAD BASE BLOCK GX-F66R
2-2	HP-H2206A010A	HEAD R/P PR4-8FU C
2-3	ZS-477876	PAN20x03STL CMT
2-4	ZS-536488	BID20x08STL CMT
2-5	ZG-402895	CS ANGLE ADJUST SPRING

SP (Service Parts) Classification

A small "x" indicates the inability to show that particular part in the Photo or Illustration.

This number corresponds with the individual parts index number in that figure

This number corresponds with the Figure Number

6. SYS. CON. P.C BOARD BLOCK

REF. NO.	PARTS NO.	DESCRIPTION
6-1	BA-T2034A070A	PC SYS CON BLK GX-F44R
6-IC1	EI-324536	IC HD14049BP
6-IC2	EI-336801	IC MB8841-564M
6-IC3	EI-331661	IC SN7405N
6-IC4	EI-336725	IC M54527P
6-TR1to4	ET-200985	TR 2SC2603 F,G
6-TR5to28	ET-554657	TR 2SA733A P,Q
6-D1	ED-318292	D SILICON H 1S2473T-77 T26
6-D2to4	ED-308952	D GERMA V 1K34A-LR F07
6-D5to10	ED-318292	D SILICON H 1S2473T-77 T26
6-X1	EI-318384	OSC X'TAL NC-18C

3.579545MHZ

SP (Service Parts) Classification

This reference numbers corresponds with symbol numbers of Schematic Diagrams.

5. Both the kind of part and installation position can be determined by the Parts Number. To determine where a parts number is listed, utilize Parts Index at end of Parts List. It is necessary first of all to find the Parts Number. This can be accomplished by using the Reference Number listed at right of parts number in the Parts Index.

WARNING

⚠ INDICATES SAFETY CRITICAL COMPONENTS. FOR CONTINUED SAFETY, REPLACE SAFETY CRITICAL COMPONENTS ONLY WITH MANUFACTURER'S RECOMMENDED PARTS.

AVERTISSEMENT

⚠ IL INDIQUE LES COMPOSANTS CRITIQUES DE SURETE. POUR MAINTENIR LE DEGRE DE SECURITE DE L'APPAREIL NE REMPLACER LES COMPOSANTS DONT LE FONCTIONNEMENT EST CRITIQUE POUR LA SECURITE QUE PAR DES PIECES RECOMMANDEES PAR LE FABRICANT.

RECOMMENDED SPARE PARTS

Because, if the parts listed below are on hand, almost any repair can be accomplished, we suggest that you stock these Recommended Spare Parts Items.

NO.	PARTS NO.	DESCRIPTION
1	BT-352037	Δ TRANS POWER AA-A35T-30(C,A)
2	BT-352038	Δ TRANS POWER AA-A35T-40(E)
3	BT-352706	Δ TRANS POWER AA-A35T-45(V)
4	BT-352039	Δ TRANS POWER AA-A35T-50(B,S)
5	BT-352040	Δ TRANS POWER AA-A35T-70(U)
6	EC-352419	C S-FIX H TZ03N100E 2.1-10
7	EC-330692	C S-FIX H TZ03R200E 4.2-20
8	ED-309341	D GERMA H 1K34A
9	ED-345555	D SILICON DBB10C 200/1.0A
10	ED-348990	D SILICON H DS446
11	ED-301911	D SILICON H DS448
12	ED-344280	D SILICON H GMA-01-FY2 F05
13	ED-348836	D SILICON RB602U 200/6.0A
14	ED-348205	D SILICON V MC931 DOUBLE
15	ED-349460	D VARACTER SVC321 C,D
16	ED-336832	D VARACTER SVC211SP
17	ED-346613	D ZENER H HZ11 C3
18	ED-306320	D ZENER H HZ15 2
19	ED-323836	D ZENER H HZ16 2
20	ED-346627	D ZENER H HZ33 2
21	ED-346603	D ZENER H HZ6 A1
22	ED-306010	D ZENER H HZ6 A2
23	ED-331197	D ZENER H HZ6 C1
24	EF-593706	Δ FUSE SEMKO T 250V 0.50A (E,V,S,LE,LB)
25	EF-691007	Δ FUSE SEMKO T 250V 3.15A (LB)
26	EF-242605	Δ FUSE SEMKO T 250V 6.30A (E,V,S,LE,LB)
27	EF-305703	Δ FUSE TSC 125V 0.63A (C,A)
28	EF-346115	Δ FUSE TSC 125V 6.30A (C,A)
29	EH-337327	FILTER CE BFU459C4N 0.459MHZ (EXCEPT C,A)
30	EH-337328	FILTER CE BFU460C4N 0.46MHZ (C,A)
31	EH-338338	FILTER CE MS3GKY-A 10.700MHZ (V,LE)
32	EH-336804	FILTER CE SFE10.7MA8 10.7MHZ (U,C,A,E,S,LB)
33	EH-315407	FILTER CE SFE10.7MMKA 10.7MHZ
34	EH-343352	FILTER CE SFU459B9 0.459MHZ (EXCEPT C,A)
35	EH-343353	FILTER CE SFU460B9 0.46MHZ(C,A)
36	EH-336830	FILTER LC LP BL-34HD(V)
37	EH-341654	FILTER LC LP 42W-1001
38	EI-352041	Δ IC STK-1050A (IC2)
39	EI-353059	IC A1007A2
40	EI-351969	IC A1007T
41	EI-345474	IC HA12002
42	EI-315799	IC HA12019
43	EI-322248	IC LA1231N
44	EI-202218	IC LA1245
45	EI-343349	IC LA3390
46	EI-337013	IC LB1290
47	EI-345765	IC LB1292
48	EI-345479	IC LC7910
49	EI-337228	IC M5218L0
50	EI-349719	IC M5218P
51	EI-344764	IC M5218P-21
52	EI-352041	IC STK-1050A
53	EI-352036	IC STK-3042AK
54	EI-336717	IC TC9125BP
55	EI-343373	IC TC9156P
56	EI-349392	IC TC9164N
57	EI-351966	IC TC9176P
58	EI-315381	IC TD6102P
59	EI-352673	OSC X'TAL HC-49/U 4.1MHZ
60	EI-327074	OSC X'TAL HC-18/U 9.000000MHZ
61	EM-352044	IND FL BG-215Z DOUBLE
62	EO-353176	COIL IFT PEGK0008B-01 455.0KHZ
63	EO-337640	COIL IFT 119AC-15533X 10.7MHZ

NO.	PARTS NO.	DESCRIPTION
64	EO-202216	COIL IFT 7MC-6733C 460.0KHZ
65	EO-337598	COIL VARI 2 25A-1353-01
66	EO-337599	COIL VARI 2 25A-1354-03
67	EQ-337159	RELAY POW G4Z-2282P 2NO 24V
68	ER-326169	Δ R FUSE ERD2FC S10 1/4W 22R0G
69	ER-328278	Δ R FUSE ERD2FC 1/4W 10R0G
70	ES-351965	Δ SW PUSH ESB8215V
71	ES-349070	Δ SW SELECT YKS11-0002 02-4(U)
72	ES-352043	SW PUSH FSB-62776 1-THROW
73	ES-351964	SW PUSH SUL221A 2-THROW
74	ES-347122	SW SLIDE 00420569 2-04-2S(U)
75	ES-344445	SW TACT EVQ-QHR12B
76	ES-336780	SW TACT KHH10902
77	ET-349449	TR FET 2SK161 O,Y
78	ET-423224	TR FET 2SK19 BL
79	ET-336864	TR FET 2SK223 F
80	ET-337759	TR FET 2SK246 GR
81	ET-337743	TR FET 2SK107 E
82	ET-308472	TR 2SA1115 E,F,G
83	ET-345626	TR 2SA1248 S,T
84	N ET-322244	TR 2SA608K-NP F,G
85	ET-305463	TR 2SA970 GR,BL
86	ET-307195	TR 2SC2240 GR,BL
87	ET-308141	TR 2SC2603 G
88	ET-338410	TR 2SC2878 A,B
89	ET-336869	TR 2SC2999 C,D
90	ET-336935	TR 2SC3000 D2,E,F
91	ET-353366	TR 2SC3112 A,B
92	ET-345625	TR 2SC3116 S,T
93	ET-349081	TR 2SC3383 S,T
94	ET-403413	TR 2SC536NP H
95	ET-328265	TR 2SC930 F
96	ET-344176	TR 2SD313HP F
97	ET-208012	TR 2SD571 K
98	EV-315540	R S-FIX H D8 3P 502
99	EV-344828	R S-FIX V RVF8 W01 3P 203
100	EV-352088	R S-FIX V RVF8W01 3P 103

"NOTE" N: New Parts

SYMBOL FOR DESTINATION

- A : AAL (U.S.A)
- B : UK (England)
- C : CSA (Canada)
- E : CEE (Europe)
- S : SAA (Australia)
- U : U/T (Universal Area)
- V : VDE (West Germany)

1. TUNER PC BOARD BLOCK

REF. NO.	PARTS NO.	DESCRIPTION
1-U	BA-A1008A030A	PC TUNER BLK AA-A35(U)
1-IC	BA-A1008A030B	PC TUNER BLK AA-A35(C,A)
1-E	BA-A1008A030C	PC TUNER BLK AA-A35(E,S)
1-V	BA-A1008A030D	PC TUNER BLK AA-A35(V)
1-1LE	BA-A1008A030E	PC TUNER BLK AA-A35L(E)
1-1LB	BA-A1008A030F	PC TUNER BLK AA-A35L(B)

TUNER PC BOARD

1-IC1	EI-202218	IC LA1245
1-IC2	EI-322248	IC LA1231N
1-IC3	EI-336717	IC TC9125BP
1-IC4	EI-315381	IC TD6102P
1-TR1	ET-338410	TR 2SC2878 A,B (LE,LB)
1-TR2to4	ET-403413	TR 2SC536NP H (LE,LB)
1-TR5	ET-423224	TR FET 2SK19 BL (LE,LB)
1-TR6	ET-336935	TR 2SC3000 D2,E,F
1-TR7	ET-322244	TR 2SA608K-NP F,G
1-TR8to10	ET-403413	TR 2SC536NP H
1-TR11,12	ET-353366	TR 2SC3112 A,B
1-TR13,14	ET-403413	TR 2SC536NP H
1-TR15	ET-322244	TR 2SA608K-NP F,G
1-TR16	ET-308141	TR 2SC2603 G
1-TR17	ET-349081	TR 2SC3383 S,T
1-TR18	ET-336864	TR FET 2SK223 F
1-TR19	ET-349081	TR 2SC3383 S,T
1-D1,2	ED-349460	D VARACTER SVC321 C,D
1-D3,4	ED-344280	D SILICON H GMA-01-FY2 F05 (LE,LB)
1-D5	ED-348205	D SILICON V MC931 DOUBLE
1-D6	ED-301911	D SILICON H DS448
1-D7,8	ED-344280	D SILICON H GMA-01-FY2 F05
1-D9	ED-301911	D SILICON H DS448
1-D10	ED-344280	D SILICON H GMA-01-FY2 F05
1-D11	ED-301911	D SILICON H DS448
1-SW1	ES-344445	SW TACT EVQ-OHR12B
1-SW2	ES-347122	SW SLIDE 00420569 2-04-2S(U)
1-T1	EO-337598	COIL VARI 2 25A-1353-01
1-T2	EO-337599	COIL VARI 2 25A-1354-03(LE,LB) (U,C,A,E,S,V)
1-T3U	EO-348209	COIL OSC 2 7NR-8646Y 115.0UH
1-T3L	EO-349456	COIL OSC 2 7NRS-9153Z 150.0UH (LE,LB)
1-T4	EO-352089	COIL OSC 2 7BRS-9098X 580.0UH (LE,LB)
1-T5	EO-353176	COIL IFT PEGK0008B-01 (455.0KHZ)
1-T6	EO-202216	COIL IFT 7MC-6733C 460.0KHZ
1-T7	EO-349452	COIL DET 2 78-1045-01
1-T8	EO-349453	COIL DET 2 78-1046-01
1-FL1	EH-315407	FILTER CE SFE10.7MMKA 10.7MHZ
1-FL2U	EH-336804	FILTER CE SFE10.7MA8 10.7MHZ(U,C,A,E,S,LE)
1-FL2V	EH-338338	FILTER CE MS3GKY-A 10.700MHZ(V,LE)
1-FL3U	EH-343352	FILTER CE SFU459B9 0.459MHZ(EXCEPT C,A)
1-FL3C	EH-343353	FILTER CE SFU460B9 0.460MHZ(C,A)
1-FL4U	EH-337327	FILTER CE BFU459C4N 0.459MHZ(EXCEPT C,A)
1-FL4C	EH-337328	FILTER CE BFU460C4N 0.46MHZ(C,A)
1-FL5	EH-336830	FILTER LC LP BL-34HD(V)
1-X1	EI-327074	OSC X'TAL HC-18/U 9.000000MHZ
1-VC1	EC-330692	C S-FIX H TZ03R200E 4.2-20
1-VC2	EC-330692	C S-FIX H TZ03R200E 4.2-20 (LE,LB)
1-R5	ER-324185	Δ R CB H S10 FS RDS 1/4W 221J
1-R6	ER-315046	Δ R CB H F10 RDS 1/4W 121J
1-R34,35	ER-324337	Δ R CB H S10 FS RDS 1/4W 560J
1-R36,37	ER-324480	Δ R CB H S10 FS RDS 1/4W 470J
1-R52,53	ER-324337	Δ R CB H S10 FS RDS 1/4W 560J
1-R86	ER-328067	Δ R CB H S10 FS RDS 1/4W 331J (V)

REF. NO.	PARTS NO.	DESCRIPTION
1-R96	ER-315046	Δ R CB H F10 RDS 1/4W 121J
1-R97	ER-324934	Δ R CB H S10 FS RDS 1/4W 220J
1-C22	EC-351134	C PP V F05 PP 4300G 50DC
1-C23	EC-352097	C PP V F05 PP 2700G 50DC
1-TM1	EJ-344423	TERMINAL W/SCREW YKD31-0133 P 2P

MPX PC BOARD

1-IC1B	EI-343349	IC LA3390
1-TR1Bto3B	ET-349081	TR 2SC3383 S,T
1-D1B	ED-346603	D ZENER H HZ6 A1
1-D2Bto5B	ED-301911	D SILICON H DS448
1-FL1B	EH-341654	FILTER LC LP 42W-100J
1-VR1B	EV-344828	R S-FIX V RVF8 W01 3P 203
1-VR2B	EV-352088	R S-FIX V RVF8W01 3P 103
1-R1B,2B	ER-324337	Δ R CB H S10 FS RDS 1/4W 560J
1-C4BU	EC-344486	C PP V F05 PP 391J 50DC (EXCEPT C,A)
1-C4BC	EC-344478	C PP V F05 PP 561J 50DC(C,A)
1-C5BU	EC-344486	C PP V F05 PP 391J 50DC (EXCEPT C,A)
1-C5BC	EC-344478	C PP V F05 PP 561J 50DC(C,A)
1-C6B,7B	EC-344155	C PP V F05 PP 181J 50DC(U)
1-C12B,13B	EC-344484	C PP V F05 PP 392J 50DC
1-C15B	EC-344483	C PP V F05 PP 102J 50DC

2. FRONT END PC BOARD BLOCK

REF. NO.	PARTS NO.	DESCRIPTION
2-1U	BA-A3040A040A	PC FRONT END BLK AT-M77 (U,C,A,E,S,LE,LB)
2-1V	BA-A3040A040E	PC FRONT END BLK AA-A35(V)
FRONT END PC BOARD		
2-TR1	ET-337743	TR FET 3SK107 E
2-TR2	ET-336869	TR 2SC2999 C,D
2-TR3	ET-328265	TR 2SC930 F
2-TR4	ET-349449	TR FET 2SK161 O,Y
2-D1to4	ED-336832	D VARACTOR SVC2115P
2-L1	EO-349461	COIL FIX 2 LINK
2-L2	EO-349462	COIL FIX 2 U147
2-L3	EO-349461	COIL FIX 2 LINK
2-L4,5	EO-349462	COIL FIX 2 U147
2-L6	EO-349446	COIL OSC 2 TFE2-OSC-U
2-L7	EO-336934	COIL FIX 1 LAL03KH 2R2M
2-T1	EO-337640	COIL IFT 119AC-15533X 10.7MHZ
2-VC1,2	EC-352419	C S-FIX H TZ03N100E 2.1-10
2-VC4	EC-352419	C S-FIX H TZ03N100E 2.1-10
2-C26	EC-349083	C STY V CUT CQ09S2B 101J 125DC

3. PRE AMP PC BOARD BLOCK

REF. NO.	PARTS NO.	DESCRIPTION
3-1U	BA-A1007A070C	PC PRE AMP BLK AA-A35 (U,C,A,E,S,LE,LB)
3-1V	BA-A1007A070D	PC PRE AMP BLK AA-A35(V)
PRE AMP PC BOARD		
3-IC1	EI-344764	IC M5218P-21
3-IC2	EI-349392	IC TC9164N
3-IC3	EI-349719	IC M5218P
3-IC4	EI-351966	IC TC9176P
3-IC5,6	EI-343373	IC TC9156P
3-D1,2	ED-346603	Δ D ZENER H HZ6 A1
3-VL1	EO-337684	COIL FIX 2 FL12R751E 751K(V)
3-VL2	EO-345918	COIL FIX 1 LAL03KH 220K(V)
3-R12,13	ER-200944	Δ R CB H S10 FS RDS 1/4W 152J
3-J1	EJ-336905	PIN J AJC-035-ACB P 4P
PIN JACK PC BOARD		
3-VL1 Bto4B	EO-345918	COIL FIX 1 LAL03KH 220K(V)
3-J1B,2B	EJ-336915	PIN J AJC-054-ABB P 4P

4. MAIN AMP PC BOARD BLOCK

REF. NO.	PARTS NO.	DESCRIPTION
4-1U	BA-A1008A040A	PC MAIN AMP BLK AA-A35(U)
4-1C	BA-A1008A040B	PC MAIN AMP BLK AA-A35(C,A)
4-1E	BA-A1008A040C	PC MAIN AMP BLK AA-A35 (E,S,LE)
4-1V	BA-A1008A040D	PC MAIN AMP BLK AA-A35(V)
4-1LB	BA-A1008A040E	PC MAIN AMP BLK AA-A35L(B)
MAIN AMP PC BOARD		
4-IC1	EI-352036	IC STK-3042AK
4-IC2	EI-352041	IC STK-1050A
4-IC3	EI-337228	IC M5218L0
4-IC4	EI-345474	IC HA12002
4-TR1	ET-307195	TR 2SC2240 GR,BL
4-TR2	ET-305463	TR 2SA970 GR,BL
4-TR3	ET-344176	Δ TR 2SD313HP F
4-TR4	ET-345625	Δ TR 2SC3116 S,T
4-TR5	ET-345626	Δ TR 2SA1248 S,T
4-TR6	ET-344176	Δ TR 2SD313HP F
4-TR7	ET-208012	Δ TR 2SD571 K
4-TR8,9	ET-337759	TR FET 2SK246 GR
4-D1,2	ED-301911	D SILICON H DS448
4-D3	ED-348990	D SILICON H DS446
4-D4	ED-301911	D SILICON H DS448
4-D5	ED-348990	D SILICON H DS446
4-D6	ED-309341	D GERMA H 1K34A
4-D7,8	ED-301911	D SILICON H DS448
4-D9	ED-346627	Δ D ZENER H HZ33 2
4-D10	ED-346613	Δ D ZENER H HZ11 C3
4-D11	ED-323836	Δ D ZENER H HZ16 2
4-D12,13	ED-306320	Δ D ZENER H HZ15 2
4-D14	ED-331197	Δ D ZENER H HZ6 C1
4-D15	ED-348836	Δ D SILICON RB602U 200/6.0A
4-D16,17	ED-345555	Δ D SILICON DBB10C 200/1.0A
4-D19,20	ED-348990	D SILICON H DS446
4-SW1	ES-351964	SW PUSH SUL221A 2-THROW
4-SW2	ES-352043	SW PUSH FSB-62776 1-THROW
4-L1	EO-337880	COIL FIX 2 202AK-018 2R2K
4-RL1	EQ-337159	RELAY POW G4Z-2282P 2NO 24V
4-VL2	EO-336934	COIL FIX 1 LAL03KH 2R2M(V)
4-VR1	EV-315540	R S-FIX H D8 3P 502
4-FR1	ER-328278	Δ R FUSE ERD2FC 1/4W 10R0G

REF. NO.	PARTS NO.	DESCRIPTION
4-FR2,3	ER-326169	Δ R FUSE ERD2FC S10 1/4W 22R0G
4-FR4	ER-328278	Δ R FUSE ERD2FC 1/4W 10R0G
4-R7	ER-349039	Δ R OMF H SNP FS 2W 681J
4-R8,9	ER-308875	Δ R CB H S15 FS RDS 1/2W 100J
4-R10	ER-327172	Δ R OMF H SNP FS 1W 182J
4-R22	ER-333698	Δ R CB H S15 FS RDS 1/2W 821J
4-R23,28	ER-323075	Δ R CB H S10 FS RDS 1/4W 472J
4-R34	ER-658034	Δ R OMF H FS 2W 221J
4-C7,8	EC-341872	C EC V F05 NP 04W 2R2M 50DC
4-C9	EC-343855	C EC V F05 NP SM R22M 50.0DC
4-C25,26	EC-320548	C CE V F 103Z 250AC

VERTICAL PC BOARD

4-TR1B	ET-305463	TR 2SA970 GR,BL
4-TR2B,3B	ET-307195	TR 2SC2240 GR,BL
4-D1B,2B	ED-301911	D SILICON H DS448
4-R7B	ER-337773	Δ R OMF H S15 FS 1W 222J
4-R8B,10B	ER-325269	Δ R CB H S10 FS RDS 1/4W 222J
4-R12B,13B	ER-325269	Δ R CB H S10 FS RDS 1/4W 222J

PHONE PC BOARD

4-J1C	EJ-351963	PHONE J 3P YKB21-5060 6.3
-------	-----------	---------------------------

POWER PC BOARD (U)

4-SW1D	ES-351965	Δ SW PUSH ESB8215V(U)
4-C1D	EC-320548	Δ C CE V F 103Z 250AC(U)

POWER PC BOARD (EXCEPT U)

4-SW1E	ES-351965	Δ SW PUSH ESB8215V (C,A,E,S,V,LE,LB)
4-R1E	ER-672816	R CB H RD 1/2W 225J(C,A)
4-C1EC	EC-338411	Δ C CE V FZ 103P 400AC(C,A)
4-C1EE	EC-338496	Δ C CE V FZ 472P 400AC (E,S,V,LE,LB)

SPEAKER PC BOARD (V)

4-FL1F	EO-342936	COIL BALUN (V)
4-TM1F	EJ-349401	TERMINAL LEVER YKD21-0027 8P (V)

FILTER PC BOARD (V)

4-FL1G	EO-338409	COIL LF FKOB160MH02 250UH (V)
--------	-----------	----------------------------------

5. CONTROL PC BOARD BLOCK

REF. NO.	PARTS NO.	DESCRIPTION
5-1U	BA-A1008A020A	PC CONTROL BLK AA-A35(U)
5-1C	BA-A1008A020B	PC CONTROL BLK AA-A35(C,A)
5-1E	BA-A1008A020C	PC CONTROL BLK AA-A35(E,S)
5-1V	BA-A1008A020G	PC CONTROL BLK AA-A35(V)
5-1L	BA-A1008A020D	PC CONTROL BLK AA-A35L(E,B)

FLD PC BOARD

5-IC1,2	EI-345765	IC LB1292
5-IC3,4	EI-315799	IC HA12019
5-TR1	ET-308141	TR 2SC2603 G
5-TR2	ET-308472	TR 2SA1115 E,F,G
5-D1to11	ED-301911	D SILICON H DS448
5-SW3to32	ES-336780	SW TACT KHH10902
5-IND1	EM-352044	IND FL BG-215Z DOUBLE

CONTROL PC BOARD

5-IC1B	EI-353059	IC A1007A2
5-IC2B	EI-351969	IC A1007T
5-IC3B	EI-345479	IC LC7910
5-IC4B,5B	EI-337013	IC LB1290
5-IC6B	EI-345765	IC LB1292
5-TR1B,2B	ET-403413	TR 2SC536NP H
5-TR3B	ET-403413	TR 2SC536NP H (U)
5-D1B	ED-301911	D SILICON H DS448
5-D2B	ED-331197	D ZENER H HZ6 C1
5-D3B	ED-306010	D ZENER H HZ6 A2
5-D4B	ED-301911	D SILICON H DS448 (LE,LB)
5-D5B	ED-301911	D SILICON H DS448 (U,E,S,V)
5-D7B	ED-301911	D SILICON H DS448 (C,A)
5-D8B	ED-301911	D SILICON H DS448 (U)
5-X1B,2B	EI-352673	OSC X'TAL HC-49/U 4.1MHZ
5-SR1B	EH-351973	COMP R RKC1/8B4 4.7K J
5-SR3B	EH-351971	COMP R RKC1/8B5 4.7K J
5-SR4B	EH-351976	COMP R RKC1/8B7 4.7K J
5-R10B	ER-349884	Δ R OMF H SNP FS 1W 111J
5-C8B	EC-344157	C DOUBLE LAYER 473Z 5.5DC

SPEAKER PC BOARD

5-TM1C	EJ-349401	TERMINAL LEVER YKD21-0027 8P (EXCEPT V)
--------	-----------	--------------------------------------------

6. ASSEMBLY BLOCK

REF. NO.	PARTS NO.	DESCRIPTION
6-1U	BT-352040	Δ TRANS POWER AA-A35T-70(U)
6-1C	BT-352037	Δ TRANS POWER AA-A35T-30(C,A)
6-1E	BT-352038	Δ TRANS POWER AA-A35T-40(E) (E,LE)
6-1V	BT-352706	Δ TRANS POWER AA-A35T-45(V)
6-1S	BT-352039	Δ TRANS POWER AA-A35T-50(B,S) (S,LB)
6-2	ZS-345624	ST PAN40x08STL CMT CUP
6-3U	EW-374894	Δ AC CORD 2 CORES VM-0129A, VFF U/T(U)
6-3C	EW-349724	Δ AC CORD 2 CORES KP-8W, SPT-2 105C UC (C,A)
6-3E	EW-336923	Δ AC CORD 2 CORES KP-419C, LTCE-2F EV (E,V,LE)
6-3S	EW-336924	Δ AC CORD 2 CORES KP-560, LTSA-2F S (S)
6-3LB	EW-347025	Δ AC CORD 2 CORES LTBS-2F B (LB)
6-4	EZ-631945	STRAIN RELIEF SR-4N-4
6-5	ES-349070	Δ SW SELECT YKS11-0002 02-4 (U)
6-6U	SP-351925A	PANEL REAR AA-A35 (U)
6-6C	SP-351925B	PANEL REAR AA-A35 (C,A)
6-6E	SP-351925C	PANEL REAR AA-A35 (E,V)
6-6S	SP-351925D	PANEL REAR AA-A35(S)
6-6LE	SP-351925F	PANEL REAR AA-A35L(E)
6-6LB	SP-351925E	PANEL REAR AA-A35L(B)
6-7U	EJ-343362	Δ SOCKET OUTLET S2T732T174 JUC 2x2P (U)
6-7C	EJ-349837	Δ SOCKET OUTLET S2T732T124 JUC (C,A)
6-8	ZS-319460	T2BR30x06STL BZN PROJECTION
6-9	EJ-329610	TERMINAL W/SCREW UB-0067 L 1P
6-10	ZS-319460	T2BR30x06STL BZN PROJECTION
6-11	SZ-332739	HOLDER ANTENNA
6-12	ZS-351886	PT BR30x10STL BNI
6-13	EE-337976	ANT LOOP LA-200A
6-14	ZS-319460	T2BR30x06STL BZN PROJECTION
6-15	SA-332850	ROUND FOOT
6-16	ZW-698308	RV NYL30x055 BL
6-17	EI-352041	Δ IC STK-1050A (IC2)
6-18	EJ-344423	TERMINAL W/SCREW YKD31-0133 P 2P (TM1)
6-19	EF-691007	Δ FUSE SEMKO T 250V 3.13A (LB) (F1)
6-20C	EF-305703	Δ FUSE TSC 125V 0.63A (C,A) (F3)
6-20E	EF-593706	Δ FUSE SEMKO T 250V 0.50A (E,V,S,LE,LB) (F3)
6-21C	EF-305703	Δ FUSE TSC 125V 0.63A (C,A) (F4)
6-21E	EF-593706	Δ FUSE SEMKO T 250V 0.50A (E,V,S,LE,LB) (F4)
6-22C	EF-305703	Δ FUSE TSC 125V 0.63A (C,A) (F5)
6-22E	EF-593706	Δ FUSE SEMKO T 250V 0.50A (E,V,S,LE,LB) (F5)
6-23C	EF-305703	Δ FUSE TSC 125V 0.63A (C,A) (F6)
6-23E	EF-593706	Δ FUSE SEMKO T 250V 0.50A (E,V,S,LE,LB) (F6)
6-24C	EF-346115	Δ FUSE TSC 125V 6.30A (C,A) (F7)
6-24E	EF-242605	Δ FUSE SEMKO T 250V 6.30A (E,V,S,LE,LB) (F7)
6-25C	EF-346115	Δ FUSE TSC 125V 6.30A (C,A) (F8)
6-25E	EF-242605	Δ FUSE SEMKO T 250V 6.30A (E,V,S,LE,LB) (F8)
6-26x	ZW-305013	RV POP32 (C,A)

ASSEMBLY BLOCK

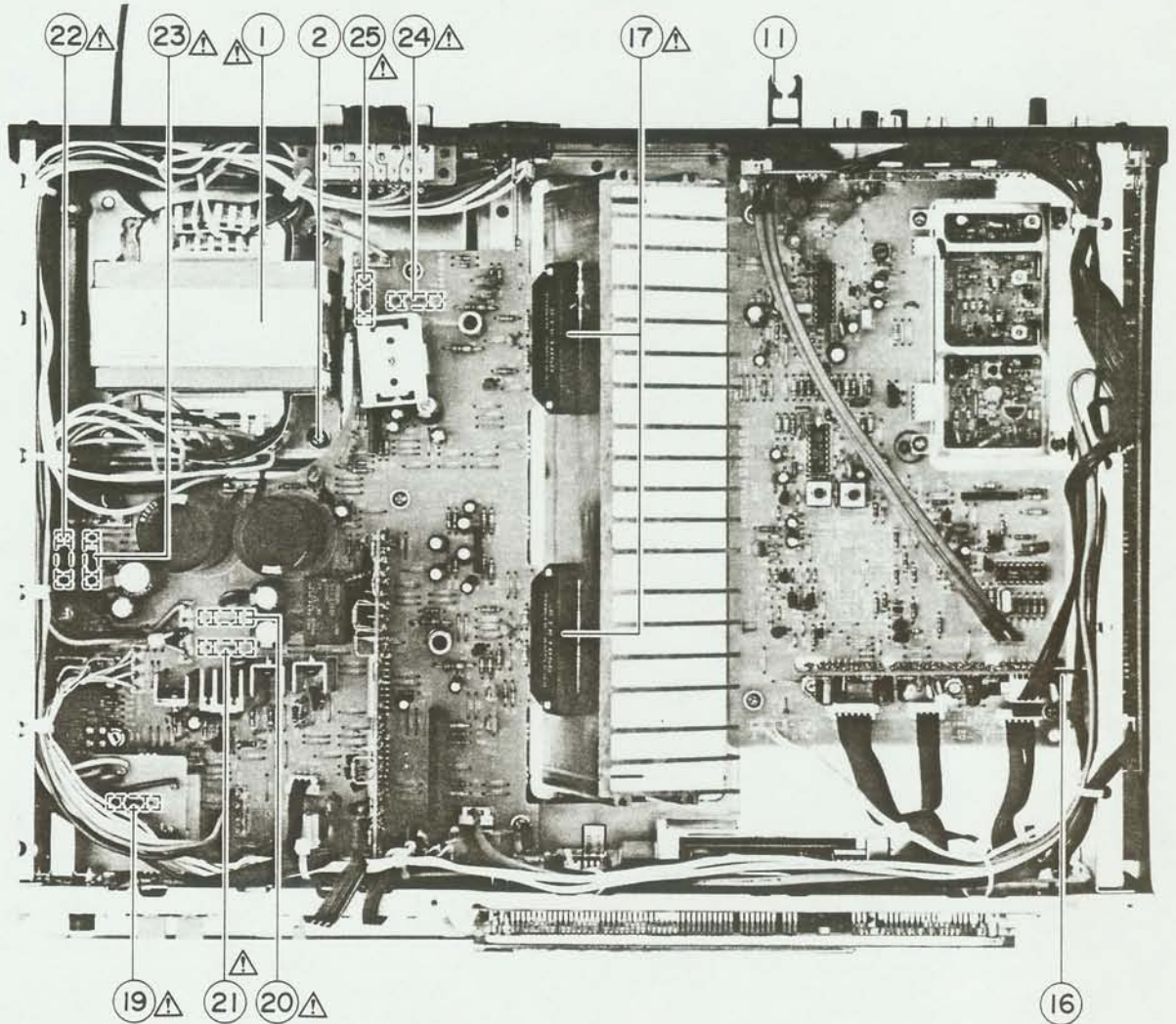
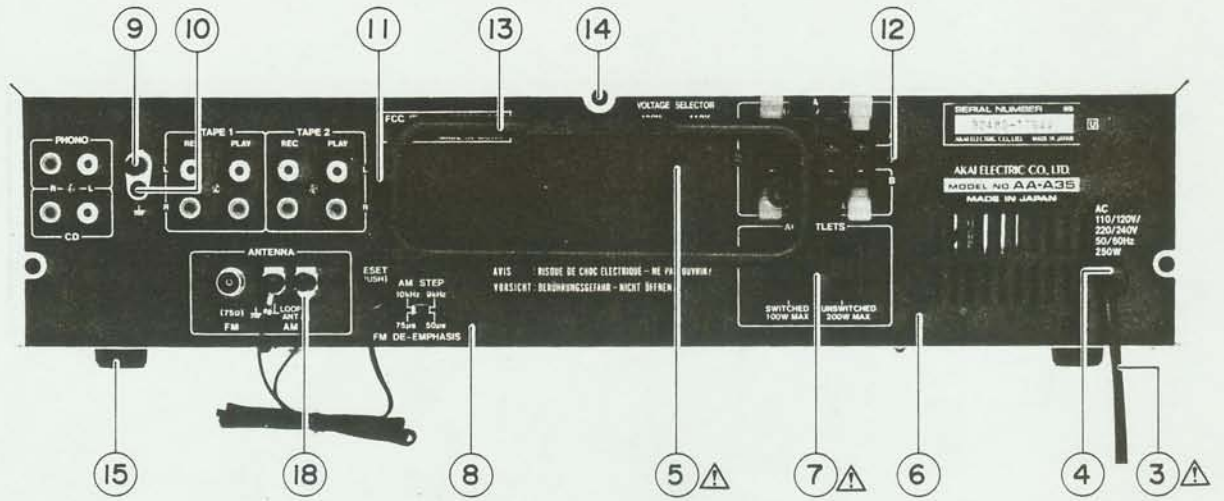

FINAL ASSEMBLY BLOCK

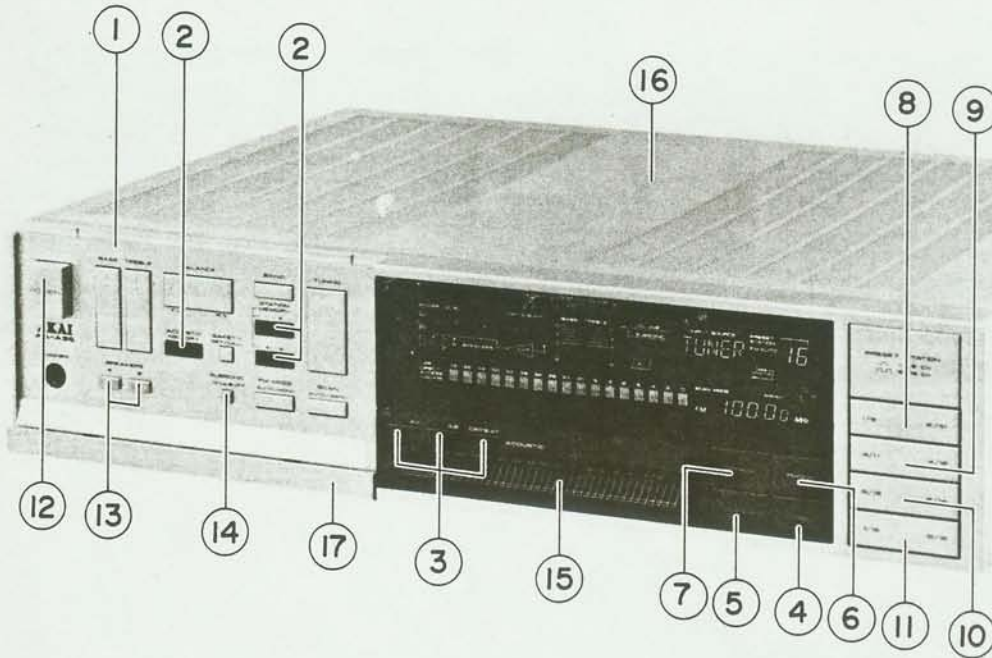

7. FINAL ASSEMBLY BLOCK

REF. NO.	PARTS NO.	DESCRIPTION
PANEL FRONT BLOCK		
7-1	BD-A1008A050A	PANEL FRONT BLK AA-A35
7-1L	BD-A1008A050C	PANEL FRONT BLK AA-A35L
7-1P	BD-A1008A050B	PANEL FRONT BLK AA-A35-P
7-1LP	BD-A1008A050D	PANEL FRONT BLK AA-A35L-P
7-1B	BD-A1008A050E	PANEL FRONT BLK AA-A35-B
7-1LB	BD-A1008A050F	PANEL FRONT BLK AA-A35L-B
7-2	SK-351913	KNOB PUSH(B) (W/P)
7-2B	SK-351913B	KNOB PUSH(B)-B
7-3	SK-351914	KNOB PUSH(C) (W/P)
7-3B	SK-351914B	KNOB PUSH(C)-B
7-4	SK-351915A	KNOB TAPE1 (W/P)
7-4B	SK-351915E	KNOB TAPE1-B
7-5	SK-351915B	KNOB TAPE2 (W/P)
7-5B	SK-351915F	KNOB TAPE2-B
7-6	SK-351915C	KNOB PHONO (W/P)
7-6B	SK-351915G	KNOB PHONO-B
7-7	SK-351915D	KNOB DAD(AUX) (W/P)
7-7B	SK-351915H	KNOB DAD(AUX)-B
7-8	SK-351918A	KNOB MEMORY(A)
7-8P	SK-351918E	KNOB MEMORY(A)-P
7-8B	SK-351918U	KNOB MEMORY(A)-B
7-9	SK-351918B	KNOB MEMORY(B)
7-9P	SK-351918F	KNOB MEMORY(B)-P
7-9B	SK-351918V	KNOB MEMORY(B)-B
7-10	SK-351918C	KNOB MEMORY(C)
7-10P	SK-351918G	KNOB MEMORY(C)-P
7-10B	SK-351918W	KNOB MEMORY(C)-B
7-11	SK-351918D	KNOB MEMORY(D)
7-11P	SK-351918H	KNOB MEMORY(D)-P
7-11B	SK-351918X	KNOB MEMORY(D)-B
7-12	SK-343017A	KNOB POWER

REF. NO.	PARTS NO.	DESCRIPTION
7-12P	SK-343017B	KNOB POWER-P
7-12B	SK-343017F	KNOB POWER-B
FINAL ASSEMBLY BLOCK		
7-13	SK-342819C	KNOB PUSH(B)
7-13P	SK-342819B	KNOB PUSH-P
7-13B	SK-342819E	KNOB PUSH(B)-B
7-14	SK-344331D	KNOB PUSH (4)
7-14P	SK-344331E	KNOB PUSH (4)-P
7-14B	SK-344331A	KNOB PUSH (1)
7-15	EV-351497	VR SPL MEMBRANE VS-115-2 B105
7-16	SP-351935A	COVER UPPER
7-16P	SP-351935B	COVER UPPER-P
7-16B	SP-351935C	COVER UPPER-B
PANEL DOOR BLOCK		
7-17	BD-A1008A060A	PANEL DOOR BLK AA-A35
7-17L	BD-A1008A060C	PANEL DOOR BLK AA-A35L
7-17P	BD-A1008A060B	PANEL DOOR BLK AA-A35-P
7-17LP	BD-A1008A060D	PANEL DOOR BLK AA-A35L-P
7-17B	BD-A1008A060E	PANEL DOOR BLK AA-A35-B
7-17LB	BD-A1008A060F	PANEL DOOR BLK AA-A35L-B
7-18x	ZG-345575A	SP PLATE (L)
7-19x	ZG-345575B	SP PLATE (R)
7-20x	MB-345576	CUSHION DOOR

SYMBOL FOR COLOR VARIATION

NON : STANDARD COLOR

P : PEARL SHADOW

B : BLACK

INDEX

PARTS NO.	REF. NO.	PARTS NO.	REF. NO.	PARTS NO.	REF. NO.	PARTS NO.	REF. NO.
BA-A1007A070C	3-1U	ED-301911	5-D4B	EI-343349	1-IC1B	ER-325269	4-R10B
BA-A1007A070D	3-1V	ED-301911	5-D2	EI-343373	3-IC6	ER-326169	4-FR3
BA-A1008A020A	5-1U	ED-301911	5-D8	EI-343373	3-IC5	ER-326169	4-FR2
BA-A1008A020B	5-1C	ED-301911	5-D5B	EI-344764	3-IC1	ER-327172	4-R10
BA-A1008A020C	5-1E	ED-301911	5-D8B	EI-345474	4-IC4	ER-328067	1-R86
BA-A1008A020D	5-1L	ED-301911	5-D7B	EI-345479	5-IC3B	ER-328278	4-FR4
BA-A1008A020G	5-1V	ED-301911	5-D1	EI-345765	5-IC6B	ER-328278	4-FR1
BA-A1008A030A	1-1U	ED-301911	5-D3	EI-345765	5-IC2	ER-333698	4-R22
BA-A1008A030B	1-1C	ED-301911	5-D11	EI-345765	5-IC1	ER-337773	4-R7B
BA-A1008A030C	1-1E	ED-301911	5-D10	EI-349392	3-IC2	ER-349039	4-R7
BA-A1008A030D	1-1V	ED-301911	5-D9	EI-349719	3-IC3	ER-349884	5-R10B
BA-A1008A030E	1-1LE	ED-301911	5-D5	EI-351966	3-IC4	ER-658034	4-R34
BA-A1008A030F	1-1LB	ED-301911	5-D4	EI-351969	5-IC2B	ER-672816	4-R1E
BA-A1008A040A	4-1U	ED-306010	5-D3B	EI-352036	4-IC1	ES-336780	5-SW21
BA-A1008A040B	4-1C	ED-306320	4-D13	EI-352041	4-IC2	ES-336780	5-SW28
BA-A1008A040C	4-1E	ED-306320	4-D12	EI-352041	6-17	ES-336780	5-SW13
BA-A1008A040D	4-1V	ED-309341	4-D6	EI-352673	5-X1B	ES-336780	5-SW17
BA-A1008A040E	4-1LB	ED-323836	4-D11	EI-352673	5-X2B	ES-336780	5-SW27
BA-A3040A040A	2-1U	ED-331197	4-D14	EI-353059	5-IC1B	ES-336780	5-SW11
BA-A3040A040E	2-1V	ED-331197	5-D2B	EJ-329610	6-9	ES-336780	5-SW15
BD-A1008A050A	7-1	ED-336832	2-D3	EJ-336905	3-J1	ES-336780	5-SW5
BD-A1008A050B	7-1P	ED-336832	2-D2	EJ-336915	3-J2B	ES-336780	5-SW25
BD-A1008A050C	7-1L	ED-336832	2-D4	EJ-336915	3-J1B	ES-336780	5-SW20
BD-A1008A050D	7-1LP	ED-336832	2-D1	EJ-343362	6-7U	ES-336780	5-SW18
BD-A1008A050E	7-1B	ED-344280	1-D3	EJ-344423	1-TM1	ES-336780	5-SW29
BD-A1008A050F	7-1LB	ED-344280	1-D7	EJ-344423	6-18	ES-336780	5-SW31
BD-A1008A060A	7-17	ED-344280	1-D4	EJ-349401	4-TM1F	ES-336780	5-SW26
BD-A1008A060B	7-17P	ED-344280	1-D8	EJ-349401	5-TM1C	ES-336780	5-SW24
BD-A1008A060C	7-17L	ED-344280	1-D10	EJ-349837	6-7C	ES-336780	5-SW8
BD-A1008A060D	7-17LP	ED-345555	4-D16	EJ-351963	4-J1C	ES-336780	5-SW12
BD-A1008A060E	7-17B	ED-345555	4-D17	EM-352044	5-IND1	ES-336780	5-SW4
BD-A1008A060F	7-17LB	ED-346603	1-D1B	EO-202216	1-T6	ES-336780	5-SW22
BT-352037	6-1C	ED-346603	3-D1	EO-336934	2-L7	ES-336780	5-SW23
BT-352038	6-1E	ED-346603	3-D2	EO-336934	4-VL2	ES-336780	5-SW7
BT-352039	6-1S	ED-346613	4-D10	EO-337598	1-T1	ES-336780	5-SW6
BT-352040	6-1U	ED-346627	4-D9	EO-337599	1-T2	ES-336780	5-SW14
BT-352706	6-1V	ED-348205	1-D5	EO-337640	2-T1	ES-336780	5-SW30
EC-320548	4-C26	ED-348836	4-D15	EO-337684	3-VL1	ES-336780	5-SW9
EC-320548	4-C1D	ED-348990	4-D5	EO-337880	4-L1	ES-336780	5-SW32
EC-320548	4-C25	ED-348990	4-D3	EO-338409	4-FL1G	ES-336780	5-SW16
EC-330692	1-VC1	ED-348990	4-D19	EO-342936	4-FL1F	ES-336780	5-SW3
EC-330692	1-VC2	ED-348990	4-D20	EO-345918	3-VL2B	ES-336780	5-SW19
EC-338411	4-C1EC	ED-349460	1-D1	EO-345918	3-VL4B	ES-336780	5-SW10
EC-338496	4-C1EE	ED-349460	1-D2	EO-345918	3-VL1B	ES-344445	1-SW1
EC-341872	4-C8	EE-337976	6-13	EO-345918	3-VL2	ES-347122	1-SW2
EC-341872	4-C7	EF-242605	6-24E	EO-345908	3-VL3B	ES-349070	6-5
EC-343855	4-C9	EF-242605	6-25E	EO-348209	1-T3U	ES-351964	4-SW1
EC-344155	1-C6B	EF-305703	6-23C	EO-349446	2-L6	ES-351965	4-SW1E
EC-344155	1-C7B	EF-305703	6-21C	EO-349452	1-T7	ES-351965	4-SW1D
EC-344157	5-C8B	EF-305703	6-20C	EO-349435	1-T8	ES-352043	4-SW2
EC-344478	1-C4BC	EF-305703	6-22C	EO-349456	1-T3L	ET-208012	4-TR7
EC-344478	1-C5BC	EF-346115	6-25C	EO-349461	2-L1	ET-305463	4-TR2
EC-344483	1-C15B	EF-346115	6-24C	EO-349461	2-L3	ET-305463	4-TR1B
EC-344484	1-C13B	EF-593706	6-22E	EO-349462	2-L4	ET-307195	4-TR2B
EC-344484	1-C12B	EF-593706	6-21E	EO-349462	2-L5	ET-307195	4-TR1
EC-344486	1-C5BU	EF-593706	6-23E	EO-349462	2-L2	ET-307195	4-TR3B
EC-344486	1-C4BU	EF-593706	6-20E	EO-352089	1-T4	ET-308141	1-TR16
EC-349083	2-C26	EF-691007	6-19	EO-353176	1-T5	ET-308141	5-TR1
EC-351134	1-C22	EH-315407	1-FL1	EQ-337159	4-RL1	ET-308472	5-TR2
EC-352097	1-C23	EH-336804	1-FL2U	ER-200944	3-R13	ET-322244	1-TR7
EC-352419	2-VC1	EH-336830	1-FL5	ER-200944	3-R12	ET-322244	1-TR15
EC-352419	2-VC2	EH-337327	1-FL4U	ER-308875	4-R9	ET-328265	2-TR3
EC-352419	2-VC4	EH-337328	1-FL4C	ER-308875	4-R8	ET-336864	1-TR18
ED-301911	1-D2B	EH-338338	1-FL2V	ER-315046	1-R6	ET-336869	2-TR2
ED-301911	1-D11	EH-341654	1-FL1B	ER-315046	1-R96	ET-336935	1-TR6
ED-301911	1-D6	EH-343352	1-FL3U	ER-323075	4-R28	ET-337743	2-TR1
ED-301911	1-D9	EH-343353	1-FL3C	ER-323075	4-R23	ET-337759	4-TR9
ED-301911	1-D5B	EH-351971	5-SR3B	ER-324185	1-R5	ET-337759	4-TR8
ED-301911	1-D4B	EH-351973	5-SR1B	ER-324337	1-R52	ET-338410	1-TR1
ED-301911	1-D3B	EH-351976	5-SR4B	ER-324337	1-R34	ET-344176	4-TR3
ED-301911	4-D8	EI-202218	1-IC1	ER-324337	1-R35	ET-344176	4-TR6
ED-301911	4-D7	EI-315381	1-IC4	ER-324337	1-R1B	ET-345625	4-TR4
ED-301911	4-D4	EI-315799	5-IC3	ER-324337	1-R53	ET-345626	4-TR5
ED-301911	4-D1	EI-315799	5-IC4	ER-324337	1-R2B	ET-349081	1-TR3B
ED-301911	4-D2	EI-322248	1-IC2	ER-324480	1-R37	ET-349081	1-TR2B
ED-301911	4-D2B	EI-327074	1-X1	ER-324480	1-R36	ET-349081	1-TR17
ED-301911	4-D1B	EI-336717	1-IC3	ER-324934	1-R97	ET-349081	1-TR19
ED-301911	5-D1B	EI-337013	5-IC4B	ER-325269	4-R12B	ET-349081	1-TR1B
ED-301911	5-D7	EI-337013	5-IC5B	ER-325269	4-R13B	ET-349449	2-TR4
ED-301911	5-D6	EI-337228	4-IC3	ER-325269	4-R8B	ET-353366	1-TR12

INDEX

PARTS NO.	REF. NO.	PARTS NO.	REF. NO.	PARTS NO.	REF. No.	PARTS NO.	REF. NO.
ET-353366	1-TR11						
ET-403413	1-TR8						
ET-403413	1-TR14						
ET-403413	1-TR9						
ET-403413	1-TR10						
ET-403413	1-TR13						
ET-403413	1-TR3						
ET-403413	1-TR2						
ET-403413	1-TR4						
ET-403413	5-TR3B						
ET-403413	5-TR2B						
ET-403413	5-TR1B						
ET-423224	1-TR5						
EV-315540	4-VR1						
EV-344828	1-VR1B						
EV-351497	7-15						
EV-352088	1-VR2B						
EW-336923	6-3E						
EW-336924	6-3S						
EW-347025	6-3LB						
EW-349724	6-3C						
EW-374894	6-3U						
EZ-631945	6-4						
MB-345576	7-20x						
SA-332850	6-15						
SK-342819B	7-13P						
SK-342819C	7-13						
SK-342819E	7-13B						
SK-343017A	7-12						
SK-343017B	7-12P						
SK-343017F	7-12B						
SK-344331A	7-14B						
SK-344331D	7-14						
SK-344331E	7-14P						
SK-351913	7-2						
SK-351913B	7-2B						
SK-351914	7-3						
SK-351914B	7-3B						
SK-351915A	7-4						
SK-351915B	7-5						
SK-351915C	7-6						
SK-351915D	7-7						
SK-351915E	7-4B						
SK-351915F	7-5B						
SK-351915G	7-6B						
SK-351915H	7-7B						
SK-351918A	7-8						
SK-351918B	7-9						
SK-351918C	7-10						
SK-351918D	7-11						
SK-351918E	7-8P						
SK-351918F	7-9P						
SK-351918G	7-10P						
SK-351918H	7-11P						
SK-351918U	7-8B						
SK-351918V	7-9B						
SK-351918W	7-10B						
SK-351918X	7-11B						
SP-351925A	6-6U						
SP-351925B	6-6C						
SP-351925C	6-6E						
SP-351925D	6-6S						
SP-351925E	6-6LB						
SP-351925F	6-6LE						
SP-351935A	7-16						
SP-351935B	7-16P						
SP-351935C	7-16B						
SZ-332739	6-11						
ZG-345575A	7-18x						
ZG-345575B	7-19x						
ZS-319460	6-10						
ZS-319460	6-14						
ZS-319460	6-8						
ZS-345624	6-2						
ZS-351886	6-12						
ZW-305013	6-26x						
ZW-698308	6-16						

AKAI

MODEL AA-A35/L

TABLE OF CONTENTS

1. SCHEMATIC DIAGRAM OF ICs	2
2. CONTROL BLOCK DIAGRAM AA-A35/L	6
3. TUNER BLOCK DIAGRAM AA-A35/L	7
4. CONNECTION DIAGRAM AA-A35/L	8
5. MAIN AMP PC BOARD, AND OTHERS AA-A35/L	9
6. CONTROL/FLD SCHEMATIC DIAGRAM AA-A35/L	10
7. CONTROL/FLD PC BOARD AA-A35/L	11
8. TUNER SCHEMATIC DIAGRAM AA-A35	12
9. TUNER PC BOARD AA-A35	13
10. TUNER SCHEMATIC DIAGRAM AA-A35L	14
11. TUNER PC BOARD AA-A35L	15
12. PRE AMP SCHEMATIC DIAGRAM AA-A35/L	16
13. PRE AMP PC BOARD AA-A35/L	17
14. MPX SCHEMATIC DIAGRAM AA-A35/L	18
15. FRONT END SCHEMATIC DIAGRAM AA-A35/L	18
16. MPX PC BOARD AA-A35/L	19
17. FRONT END PC BOARD AA-A35/L	19

A1007A

Pin No.	Functions	Pin No.	Functions
1	DIGIT 0	29	CARTRIDGE (MM/MC) SELECTION INPUT MC → "H" MM → "L"
2	DIGIT 1		
3	DIGIT 2		
4	DIGIT 3		
5	DIGIT 4		
6	DIGIT 5		
	} STROBE FOR KEY MATRIX CONVERTER FL DISPLAY	30	TEST
		31	X _{IN}
		32	X _{OUT}
		33	RESET INPUT
7	SEG 12	34	HOLD INPUT (BACK UP)
8	SEG 13	35	INPUT STATUS OUTPUT, TUNER → "L" PHONO/CD → "H"
9	SEG 11		
10	SEG 10	36	TUNER OPERATION PULSE INPUT, Switching input selector to TUNER whenever receives the pulse (6 m sec) from Tuner MI-COM (IC A1007T)
11	SEG 9		
12	SEG 8		
	} FL DISPLAY SEGMENT DRIVE		
13	INPUT SELECTOR DATA FOR ANALOGUE SW	37	MM/MC CIRCUIT SWITCHING OUTPUT.
14	INPUT SELECTOR CLOCK FOR ANALOGUE SW	38	DATA DETECTION FROM A/D CONVERTER
15	INPUT SELECTOR STROBE FOR ANALOGUE SW	39	END DETECTION FROM A/D CONVERTER
16	STROBE FOR ELECTRONIC VOLUME (MAIN, BASS, TREBLE VOLUME)	40	ST-WR (CONVERSION START) OUTPUT FOR A/D CONVERTER (LC-7910) DATA OUTPUT FOR MAIN, BASS, TREBLE CONTROL VOLUME IC (TC9176P, TC9156P × 2)
17	SEG 7		
18	SEG 6		
19	SEG 5		
20	SEG 4		
	} FL DISPLAY SEGMENT DRIVE		
21	GND	41	CE (DATA CLOCK) OUTPUT FOR A/D CONVERTER (LC7910) CLOCK OUTPUT FOR MAIN, BASS TREBLE. CONTROL VOLUME IC (IC9176P, TC9150P × 2)
22	SEG 3		
23	SEG 2		
24	SEG 1		
25	SEG 0		
	} FL DISPLAY SEGMENT DRIVE		
26	} KEY MATRIX INPUT	42	VDD +5V
27			
28			

A1007T

Pin No.	Functions	Pin No.	Functions		
1	NOT USED	17	SEG e		
2	TUNER OPERATION PULSE OUTPUT, Output 6 msec pulse to switch the input selector of Amp MI-COM (A1007A) to Tuner when operating Tuner section by depressing BAND, TUNER UP/DOWN or PRESET CH buttons.	18	SEG f		
		19	SEG g		
		20	SEG n		
		21	GND		
		22	A		
3	DIGIT 0	} STROBE FOR KEY MATRIX CONVERTER & FL DISPLAY	} DATA FOR THE PLL IC (9125BP)		
				4	DIGIT 1
				5	DIGIT 2
				6	DIGIT 3
				7	DIGIT 4
8	DIGIT 5				
9	SEG a	} FL DISPLAY SEGMENT DRIVE	30	GND	
10	SEG b		31	X _{IN}	
11	SEG c		32	X _{OUT}	
12	SEG d		33	RESET INPUT	
13	FM MODE SELECTOR OUTPUT FORCED MONO → "H"	34	HOLD INPUT (BACK UP)		
14	TUNER OUT (L & R) MUTE OUTPUT, MUTE at "L"	35	DETECTOR INPUT FOR THE PRESET CH NUMBER, 20CH → "L", 16CH → "H"		
		36	FM Band Designation Output		
15	DETECTOR INPUT FOR THE STATUS OF AMP SECTION MI-COM (A1007A) INPUT SELECTOR. PHONO/CD → "H", TUNER → "L"	37	MW Band Designation Output		
		38	LW Band Designation Output		
		39	LOAD OUTPUT TERMINAL to PLL IC (T9125BP)		
		40	DETECTOR INPUT FOR THE AUTO STOP AT SCAN MODE		
16	Becomes level "H" 1 second after power is turned on ("H" after Reset/Back up cancellation) For the models AA-A35/A45, this terminal is used for the synchronization between static display (Bar meter) and Dynamic display when power is turned on.	41	Not used and Connect to +B LINE		
		42	VDD (+5V)		

HA12002

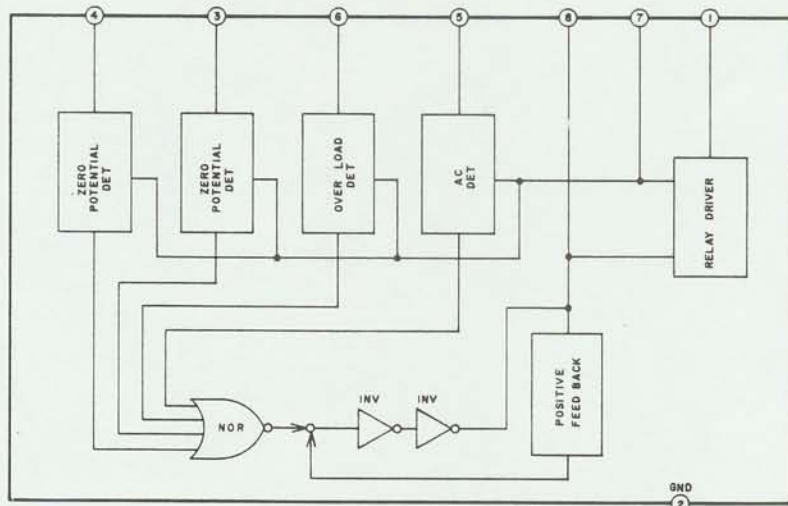

LA3390

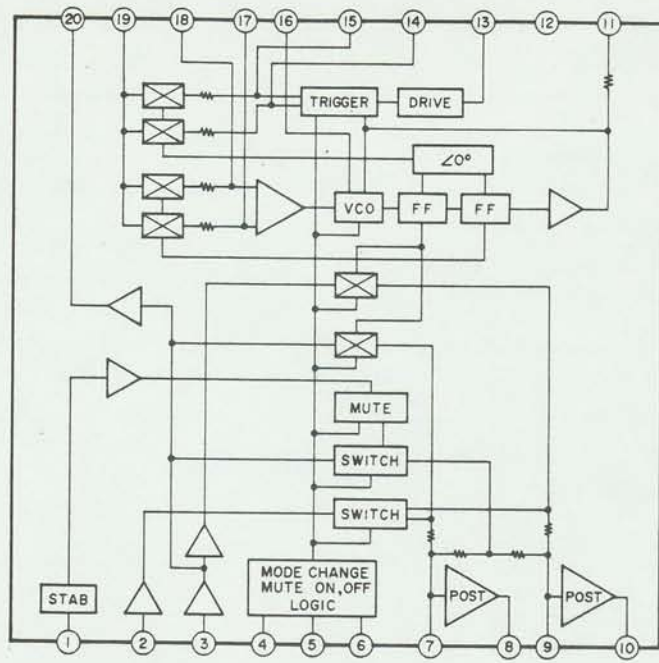

STK1050

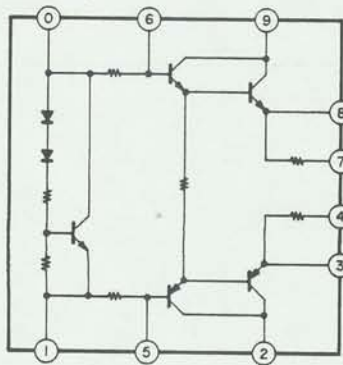

STK3042

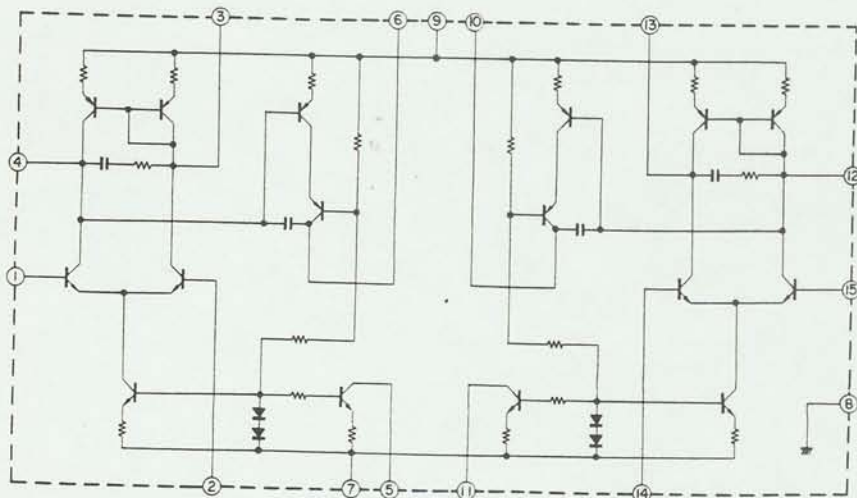

TC9125BP

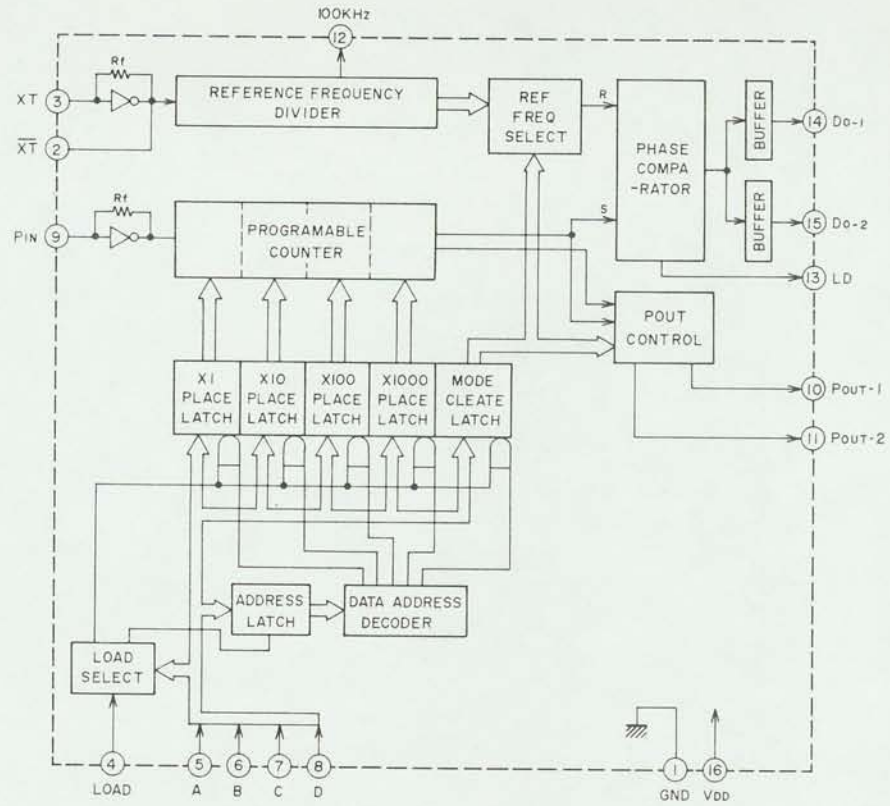

TC9156P

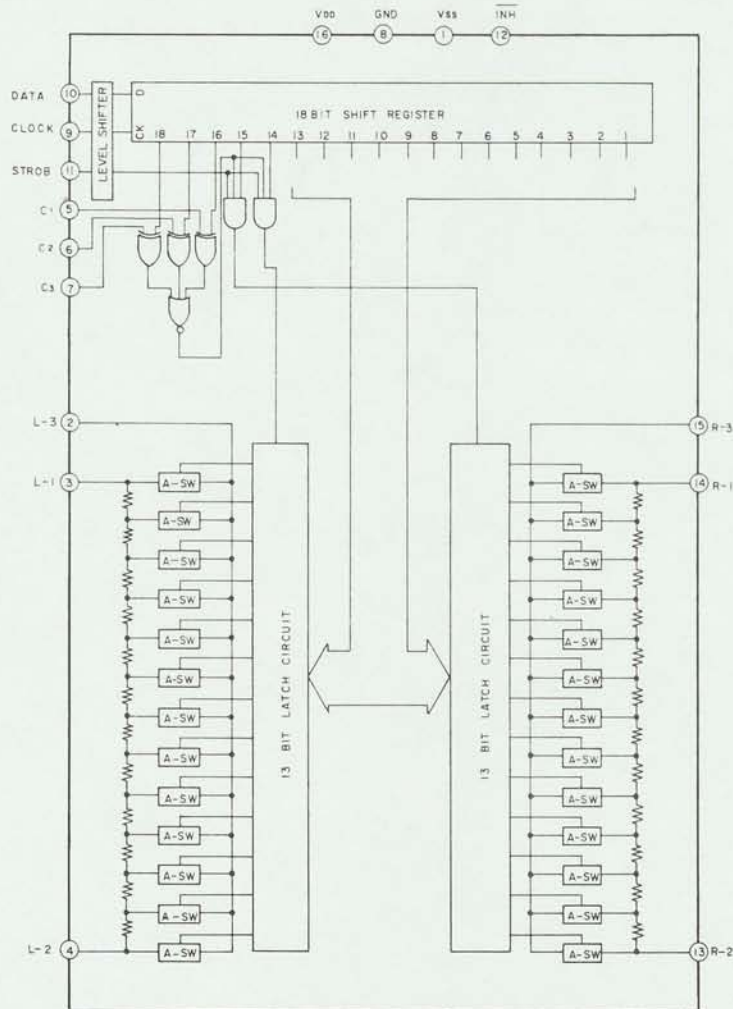

Pin No.	Symbol	Functions	Remarks
1	V _{SS}	-15V	
2	L-OUT ₁	10dB STEPS ATTENUATOR OUTPUT (Lch) Audio signal attenuate 0 to 70dB (10dB steps)	
3	L-IN ₁	10 dB STEPS ATTENUATOR INPUT (Lch)	
4	A-GND	AC GND (Lch)	
5	L-IN ₂	2dB STEPS ATTENUATOR INPUT (Lch)	
6	L-OUT ₂	2dB STEPS ATTENUATOR OUTPUT (Lch) Audio signal attenuate 0 to 8db (2dB steps)	
7	GND	GND	
8	CK	CLOCK INPUT, This terminal is the CLOCK INPUT to read data of the DATA terminal.	
9	DATA	DATA INPUT FOR THE ATTENUATION LEVEL AND CHANNEL (Lch and Rch) SELECTION DATA, Data is composed to 20 bits and input by clock signal.	
10	ST	STROBE INPUT Attenuation Levels and channel (Lch and Rch) selection are read DATA, CK terminal that is latch to activate "H" at this terminal. Holding the previous data, when "H" level doesn't apply to this terminal.	
11	R-OUT ₂	2dB STEPS ATTENUATOR OUTPUT (Rch) Audio signal attenuate 0 to 8dB (2dB steps)	
12	R-IN ₂	2dB STEPS ATTENUATOR INPUT (Rch)	
13	A-GND	AC GND (Rch)	
14	R-IN ₁	10dB STEPS ATTENUATOR INPUT (Rch)	
15	R-OUT ₁	10dB STEPS ATTENUATOR OUTPUT (Rch) Audio signal attenuate 0 to 70dB (10dB steps)	
16	V _{DD}	+15V	

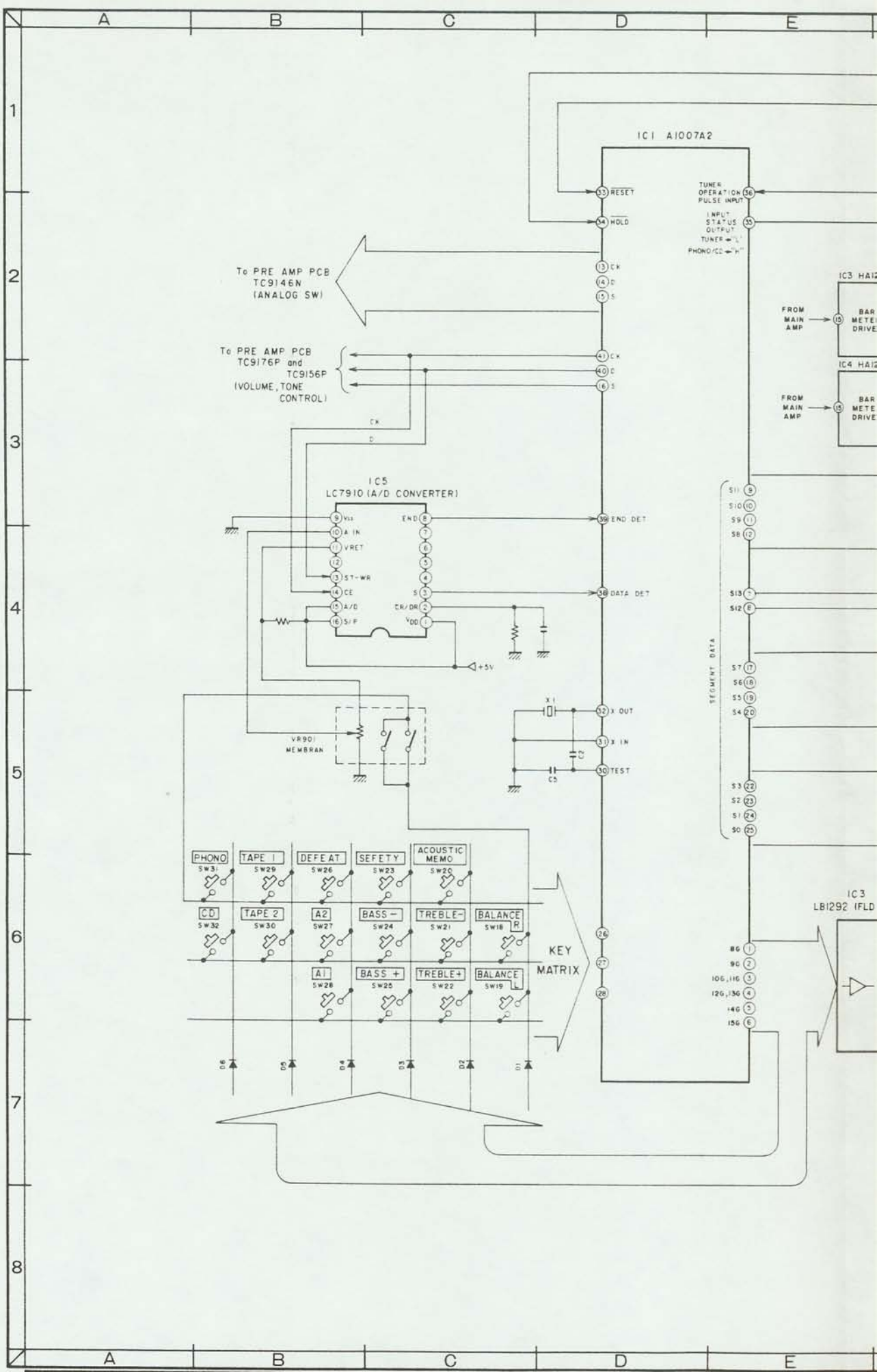

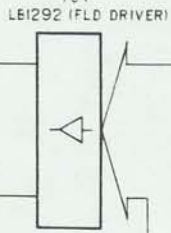
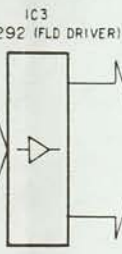
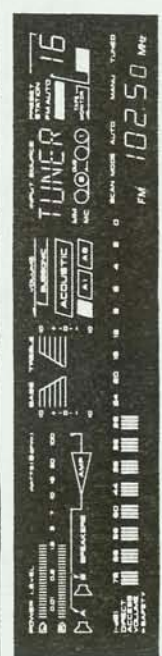
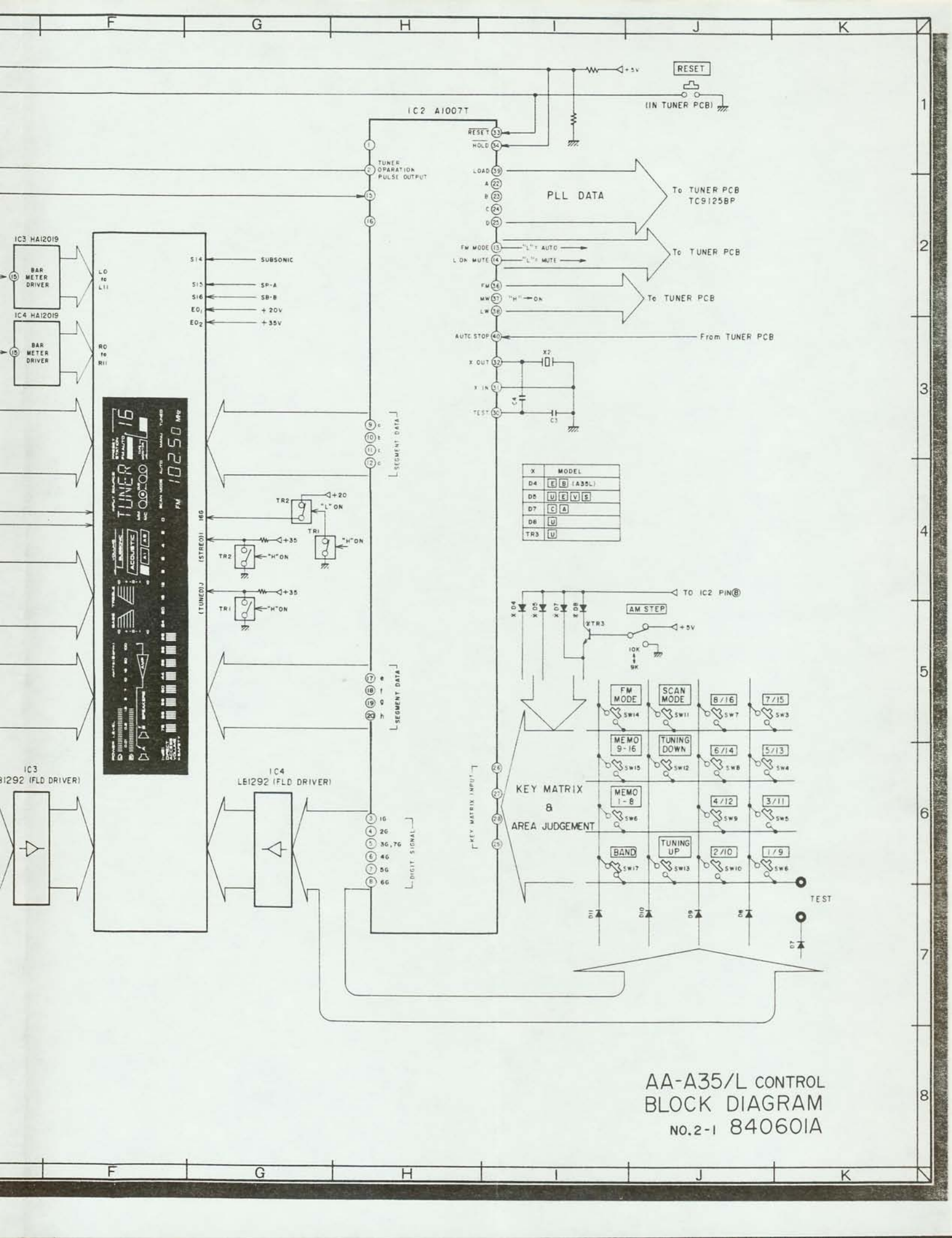

X	MODEL
D4	E B (A35L)
D8	U E V S
D7	C A
D6	U
TR3	U

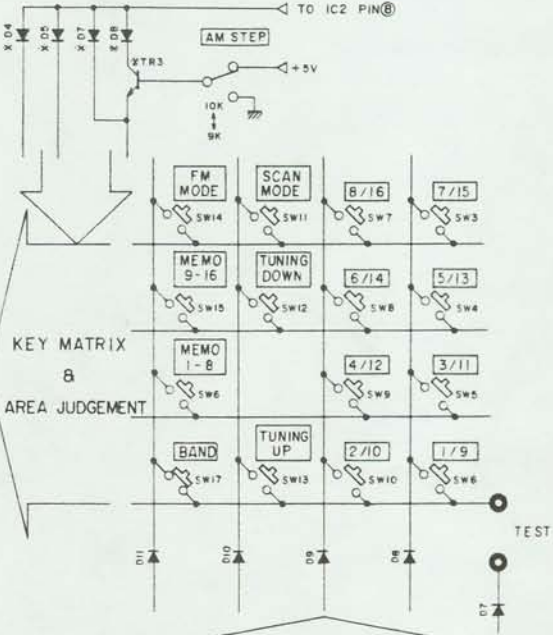

AA-A35/L CONTROL
BLOCK DIAGRAM
NO.2-1 84060IA

AA-A25/L

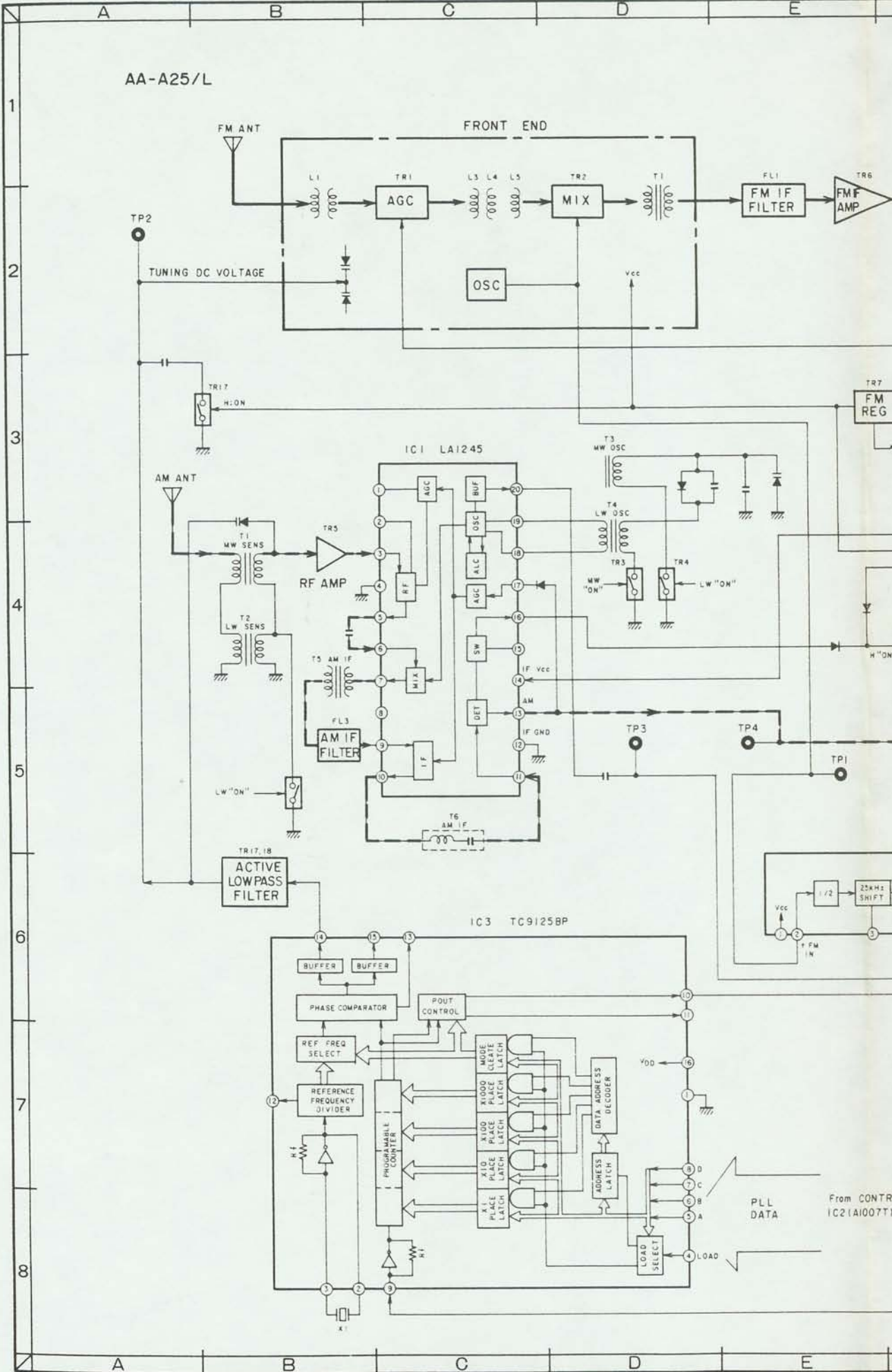

FRONT END

IC1 LA1245

IC3 TC9125BP

PLL DATA From CONTR IC2 (AI007T)

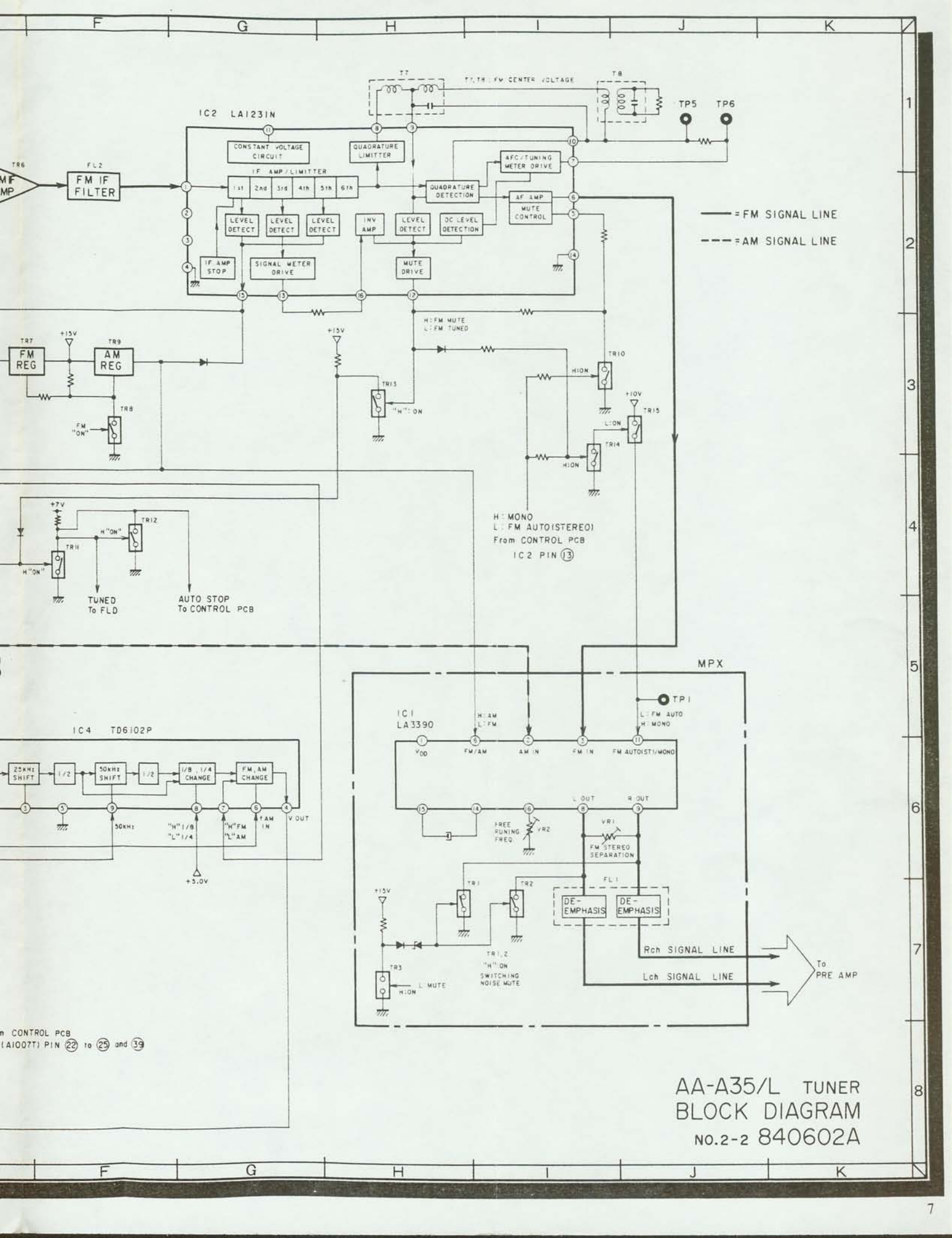

— = FM SIGNAL LINE
 - - - = AM SIGNAL LINE

AA-A35/L TUNER
 BLOCK DIAGRAM
 No.2-2 840602A

CONTROL PCB
 (A1007T) PIN 22 to 25 and 39

1
2
3
4
5
6
7
8

AA-A35/L

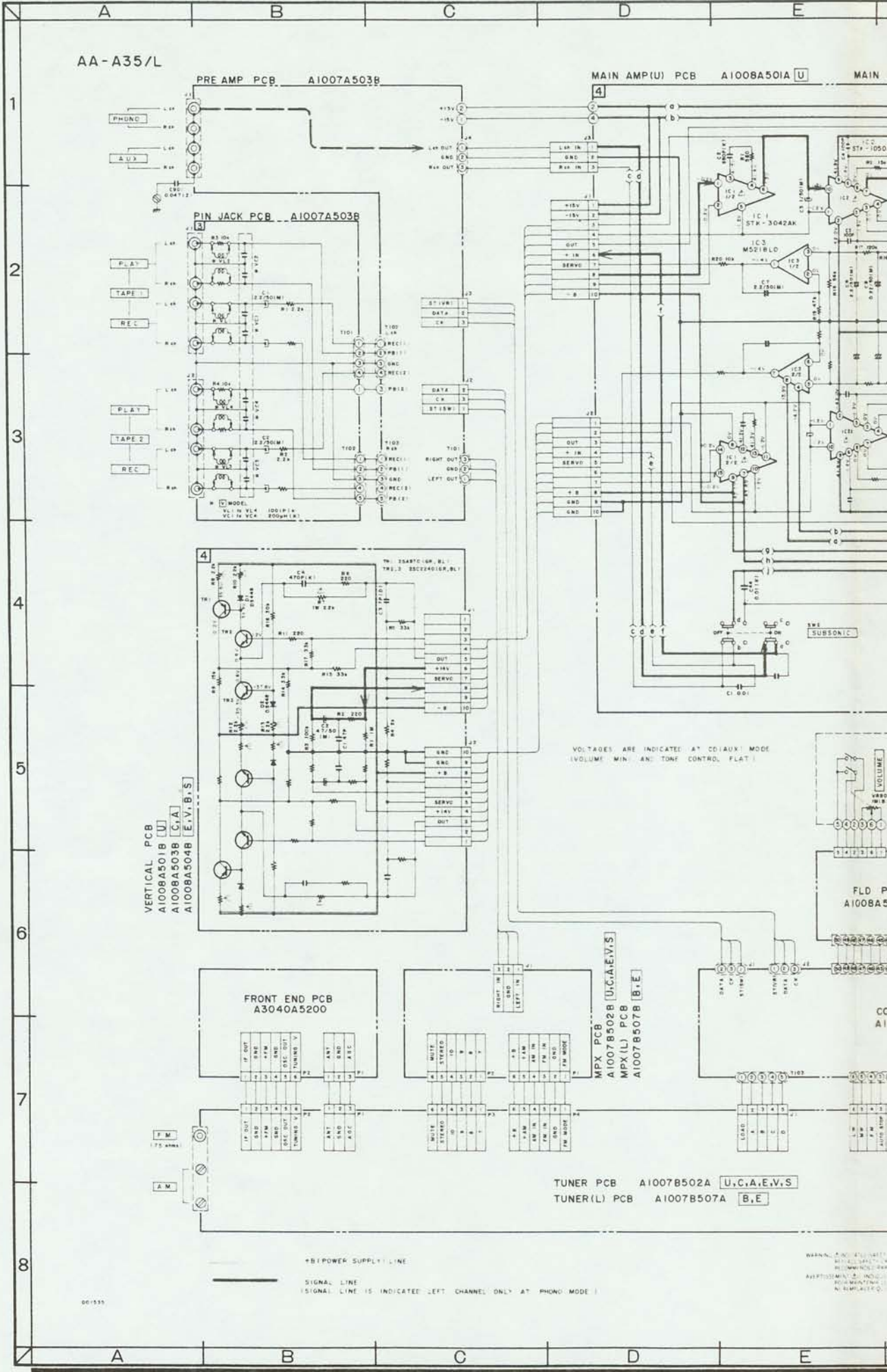

VERTICAL PCB
 A1008A501B [U]
 A1008A503B [G,A]
 A1008A504B [E,V,B,S]

VOLTAGES ARE INDICATED AT CDIAUX MODE
 (VOLUME MIN. AND TONE CONTROL FLAT)

FRONT END PCB
 A3040A5200

MPX PCB
 A1007B502B [U,C,A,E,V,S]
 A1007B507B [B,E]

TUNER PCB A1007B502A [U,C,A,E,V,S]
 TUNER (L) PCB A1007B507A [B,E]

— B+ POWER SUPPLY LINE
 — SIGNAL LINE
 (SIGNAL LINE IS INDICATED LEFT CHANNEL ONLY AT PHONO MODE)

00155

WARNING: DO NOT ATTEMPT TO REPAIR THIS UNIT WITHOUT THE NECESSARY TRAINING AND TOOLS. REPAIRS SHOULD BE PERFORMED BY A QUALIFIED TECHNICIAN.

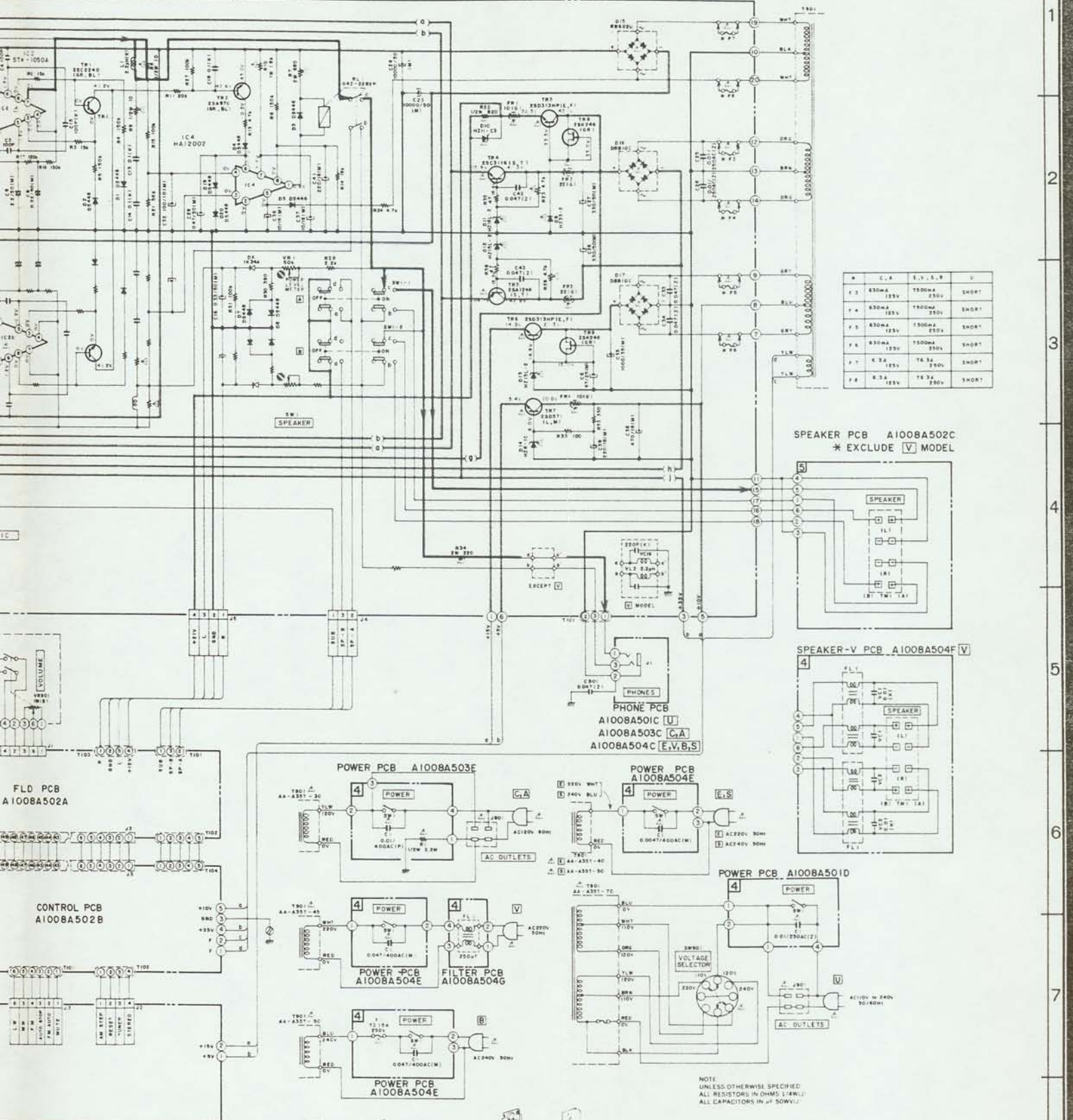

N	C, A	E, V, B, S	V
F 3	830mA 125V	1500mA 250V	SHORT
F 4	830mA 125V	1500mA 250V	SHORT
F 5	830mA 125V	1500mA 250V	SHORT
F 6	830mA 125V	1500mA 250V	SHORT
F 7	8.3A 125V	15.3A 250V	SHORT
F 8	8.3A 125V	15.3A 250V	SHORT

SPEAKER PCB A1008A502C * EXCLUDE [V] MODEL

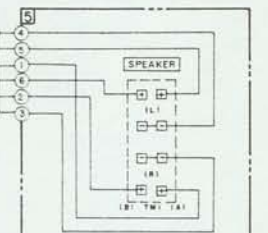

SPEAKER-V PCB A1008A504F [V]

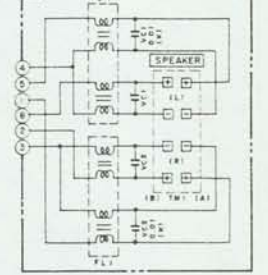

POWER PCB A1008A503E

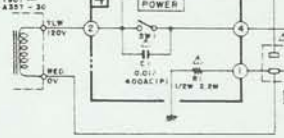

POWER PCB A1008A504E

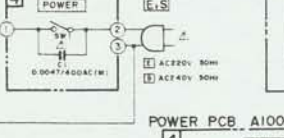

POWER PCB A1008A501D

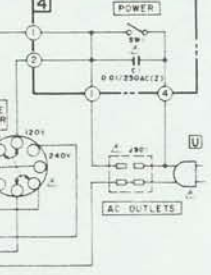

POWER PCB A1008A504E

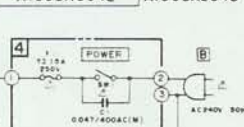

FILTER PCB A1008A504G

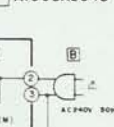

POWER PCB A1008A504E



NOTE: UNLESS OTHERWISE SPECIFIED ALL RESISTORS IN OHMS (1/4W) ALL CAPACITORS IN μF (50V/1)



AA-A35/L CONNECTION DIAGRAM NO. 7-1 840631A

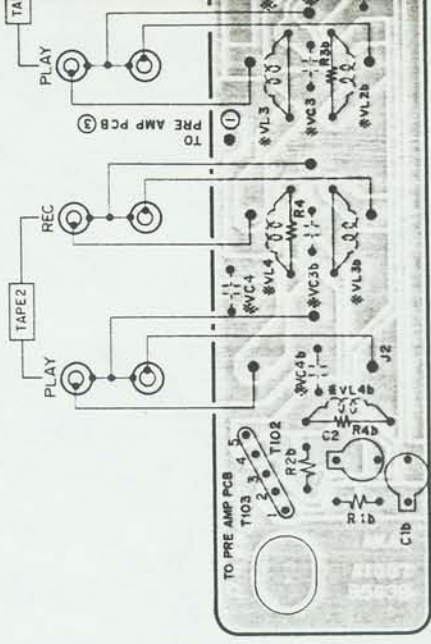

PIN JACK PCB A1007B503B

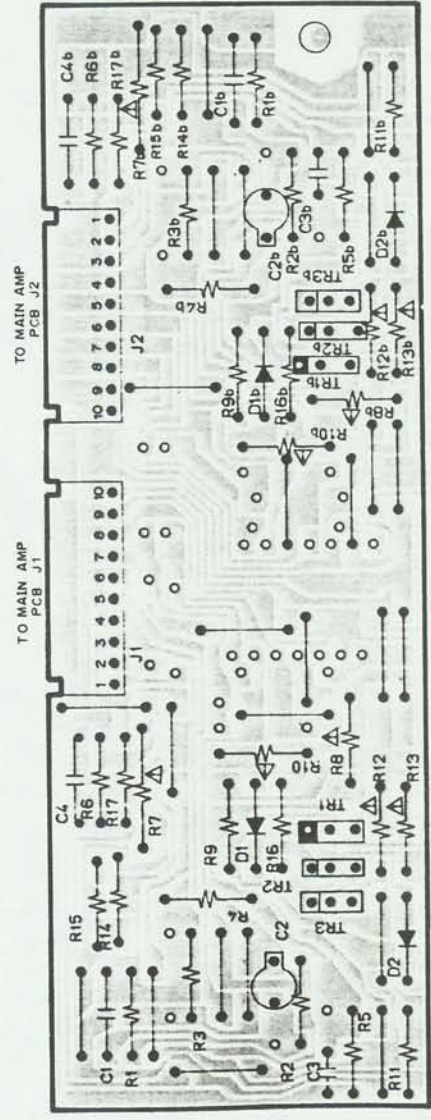

VERTICAL PCB

- A1008A501B U
- A1008A503B C
- A1008A504B E
- A V
- B
- S

- TR1..... 2SA970 (GR, BL)
- TR2, 3..... 2SC2240 (GR, BL)

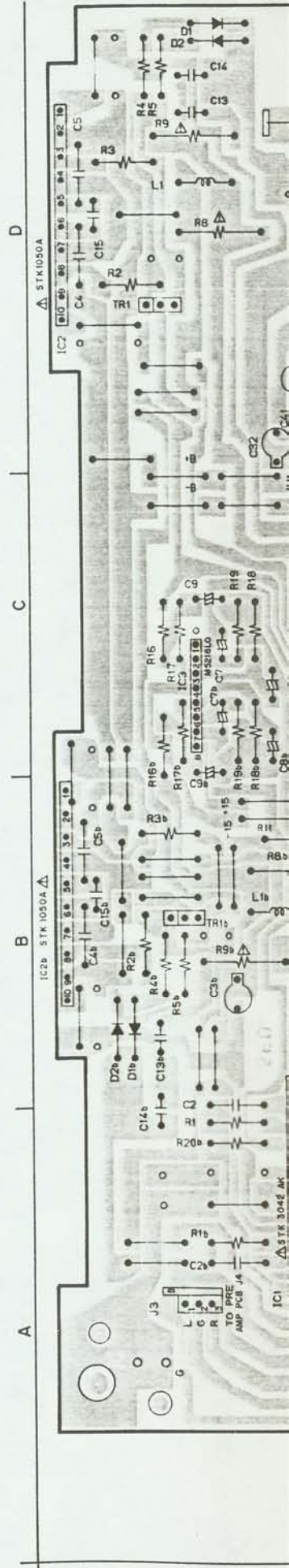
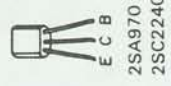

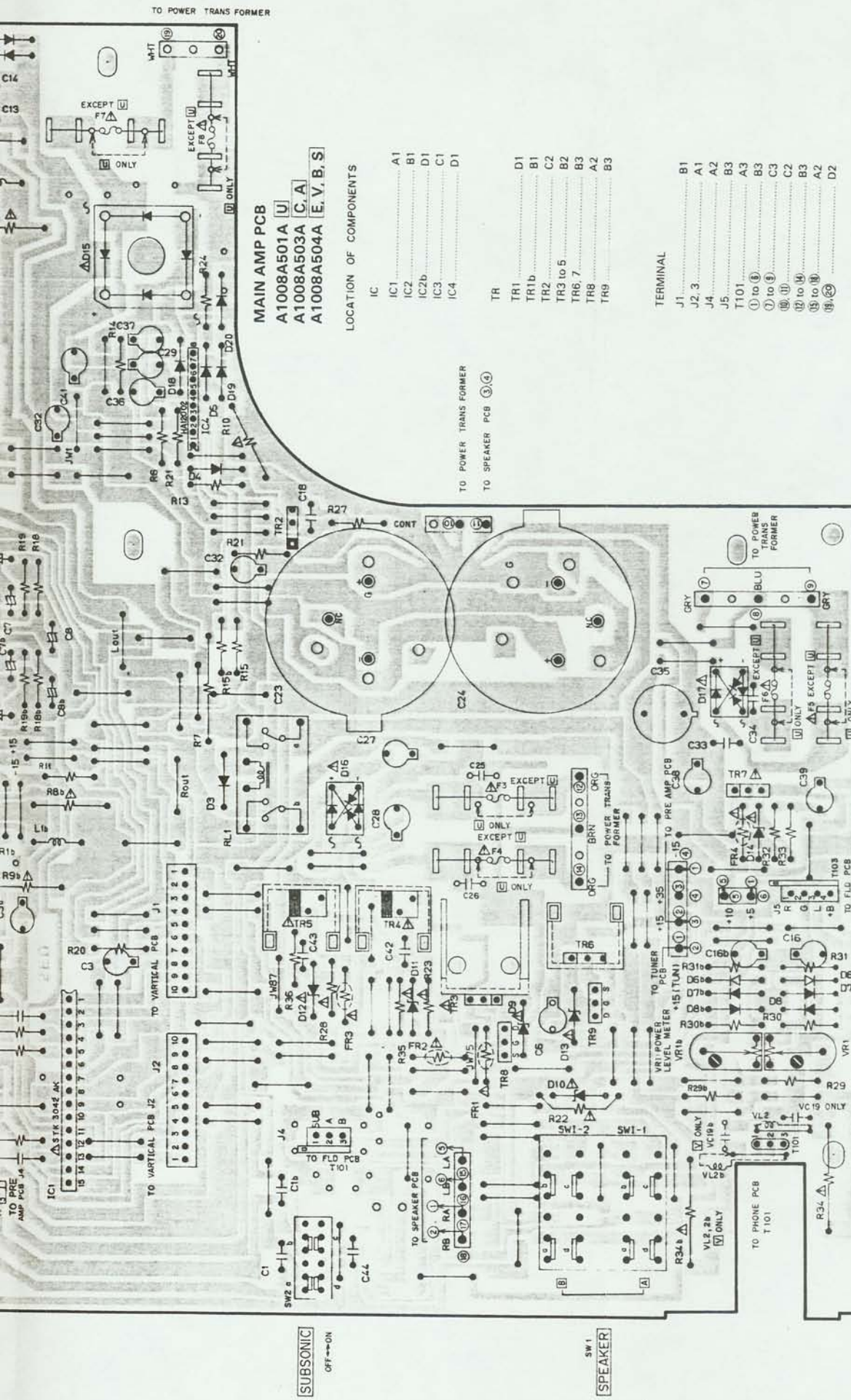

MAIN AMP PCB
A1008A501A U
A1008A503A C, A
A1008A504A E, V, B, S

LOCATION OF COMPONENTS

- | | | |
|----|------|----|
| IC | IC1 | A1 |
| | IC2 | B1 |
| | IC2b | D1 |
| | IC3 | C1 |
| | IC4 | D1 |
-
- | | | |
|----|----------|----|
| TR | TR1 | D1 |
| | TR1b | B1 |
| | TR2 | C2 |
| | TR3 to 5 | B2 |
| | TR6, 7 | B3 |
| | TR8 | A2 |
| | TR9 | B3 |
-
- | | | |
|----------|--------|----|
| TERMINAL | J1 | B1 |
| | J2, 3 | A1 |
| | J4 | A2 |
| | J5 | B3 |
| | T101 | A3 |
| | ① to ⑥ | B3 |
| | ⑦ to ⑧ | C3 |
| | ⑨ to ⑩ | C2 |
| | ⑪ to ⑭ | B3 |
| | ⑮ to ⑰ | A2 |
| | ⑱, ⑳ | D2 |

TO POWER TRANSFORMER
 TO SPEAKER PCB ①, ②

- | | |
|--------|------------------|
| TR1 | 25C2240 (GR, BL) |
| TR2 | 25A970 (GR, BL) |
| TR3, 6 | 25D313HP (E, F) |
| TR4 | 25C3116 |
| TR5 | 25A1248 (S, T) |
| TR7 | 25D571 (L, M) |
| TR8, 9 | 25K246 (G, R) |

- | | |
|---|-----------------|
| ③ | TO CONTROL PCB |
| ⑥ | TO TUNER PCB |
| ⑦ | TO POWER FORMER |
| ⑩ | TO FLD PCB |
-
- | | | | | | |
|---------|--------|--------|--------|----------|---------|
| 25C2240 | 25A970 | 25D571 | 25K246 | 25D313HP | 25C3116 |
|---------|--------|--------|--------|----------|---------|

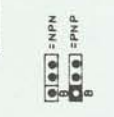

WARNING: Δ INDICATES SAFETY CRITICAL COMPONENTS. FOR CONTINUED SAFETY, REPLACE SAFETY CRITICAL COMPONENTS ONLY WITH MANUFACTURER'S RECOMMENDED PARTS.
AVERTISSEMENT: Δ IL INDIQUE LES COMPOSANTS CRITIQUES DE SECURITE. POUR MAINTENIR LE NIVEAU DE SECURITE DE L'APPAREIL, NE REMPLACER QUE DES PIECES RECOMMANDEES PAR LE FABRICANT.

SUBSONIC
 OFF ↔ ON

SPEAKER
 SW1

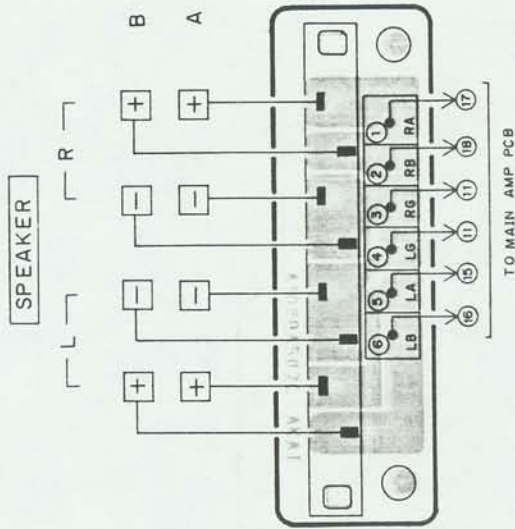

SPEAKER PCB
A1008A502C U C A E B S

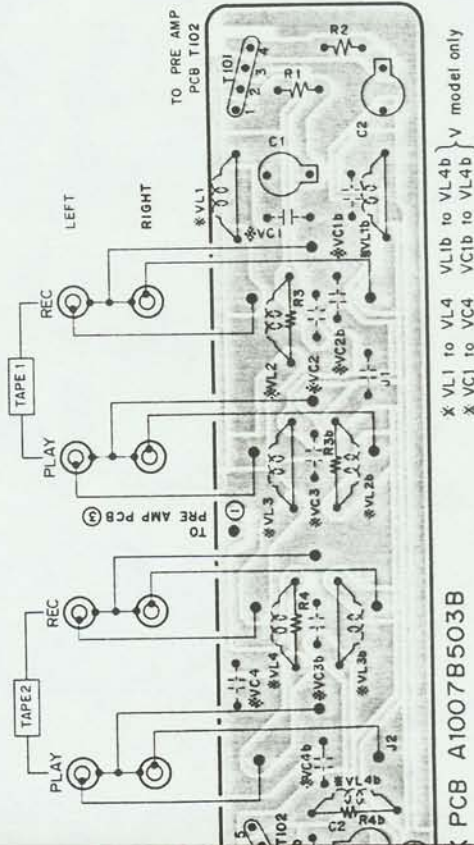
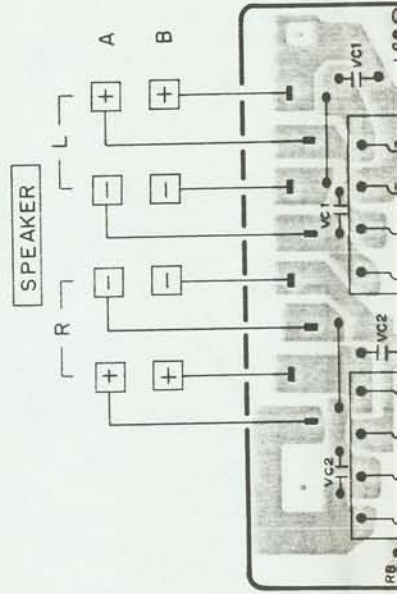

PCB A1007B503B

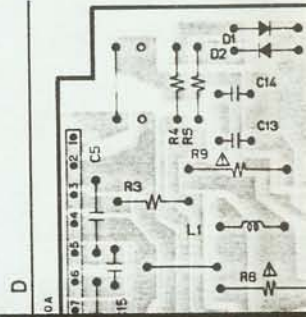
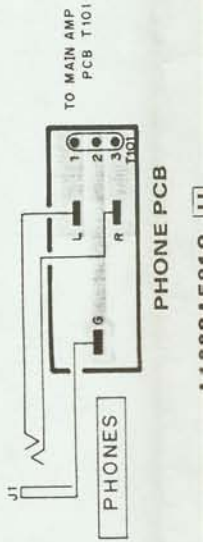

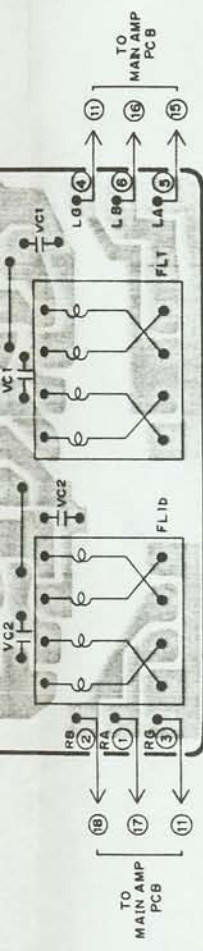

SPEAKER PCB A1008A504F V

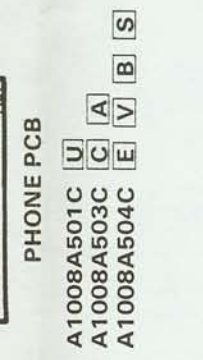

PHONE PCB

- A1008A501C U
- A1008A503C C A
- A1008A504C E V B S

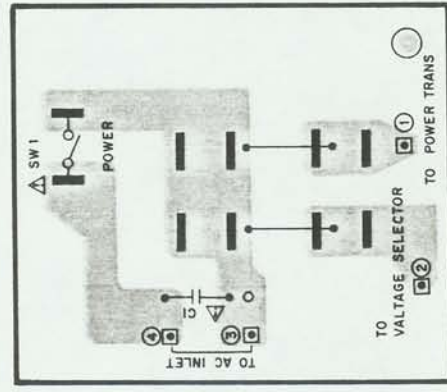

POWER PCB A1008A501D U

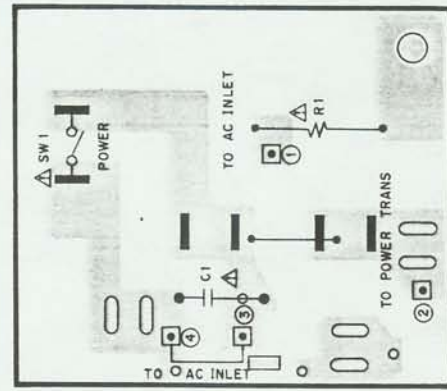

POWER PCB A1008A503E C A

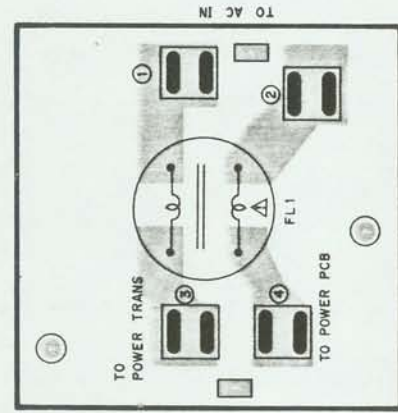

FILTER PCB A1008A504G V

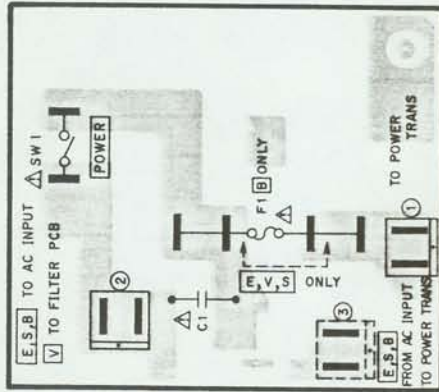

POWER PCB A1008A504E E V B S

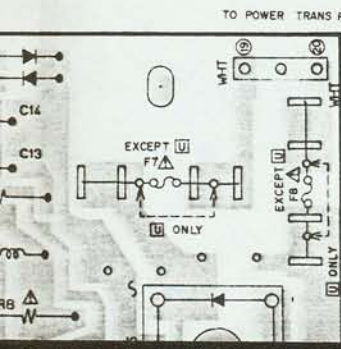

P PCB

- 01A U
- 03A C A
- 04A E V B S

COMPONENTS

- A1
- B1
- D1
- C1
- D1

- D1
- B1
- C2
- B2
- B3
- A2
- A3
- B3

- B1
- A1
- A2
- B3
- A3
- B3
- C3
- C2
- B3
- A2
- D2

INDICATES SAFETY CRITICAL COMPONENTS FOR CONTINUED SAFETY.
 INDICATE SAFETY CRITICAL COMPONENTS ONLY WITH MANUFACTURER'S
 RECOMMENDED PARTS
 L'INDIQUE LES COMPOSANTS CRITIQUES DE SECURITE
 MAINTIENIR LE DEGRE DE SECURITE RECOMMANDEE
 UTILISER SEULEMENT LES PIECES RECOMMANDEES PAR LE FABRICANT

K

J

I

H

G

F

1

2

3

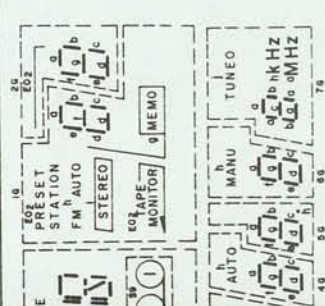



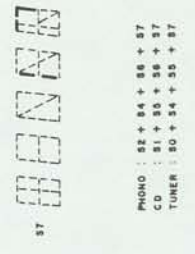

FLD
IND 1 : 86-215Z

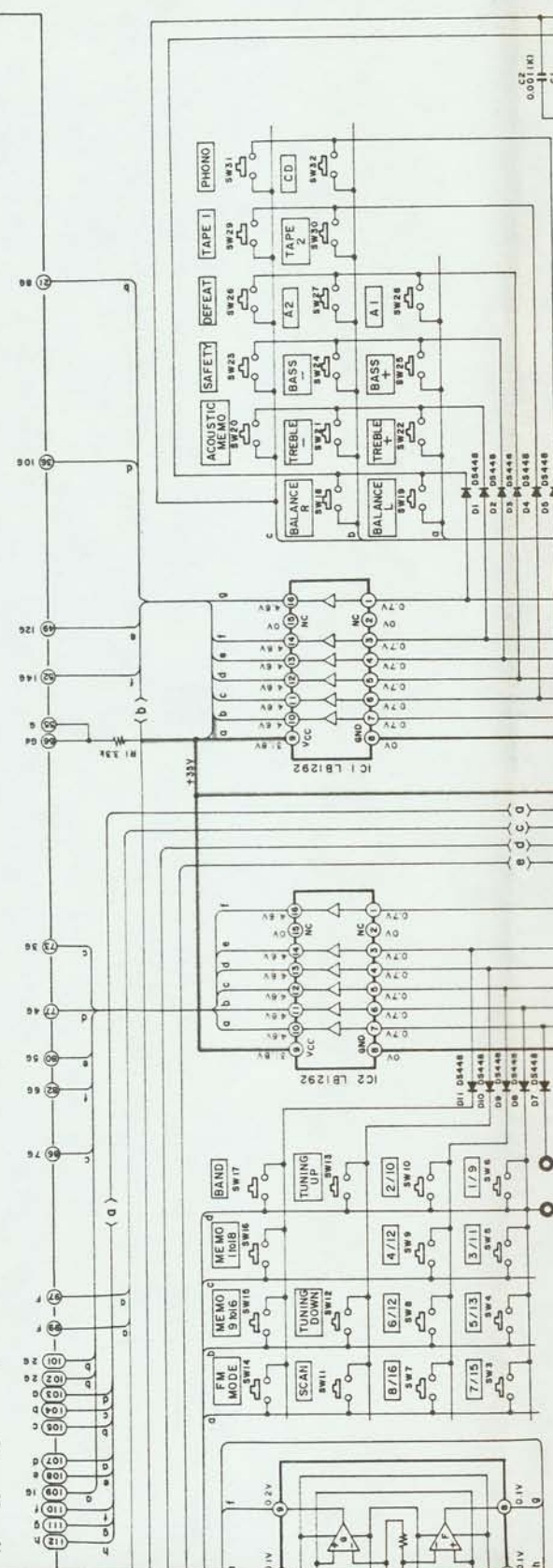

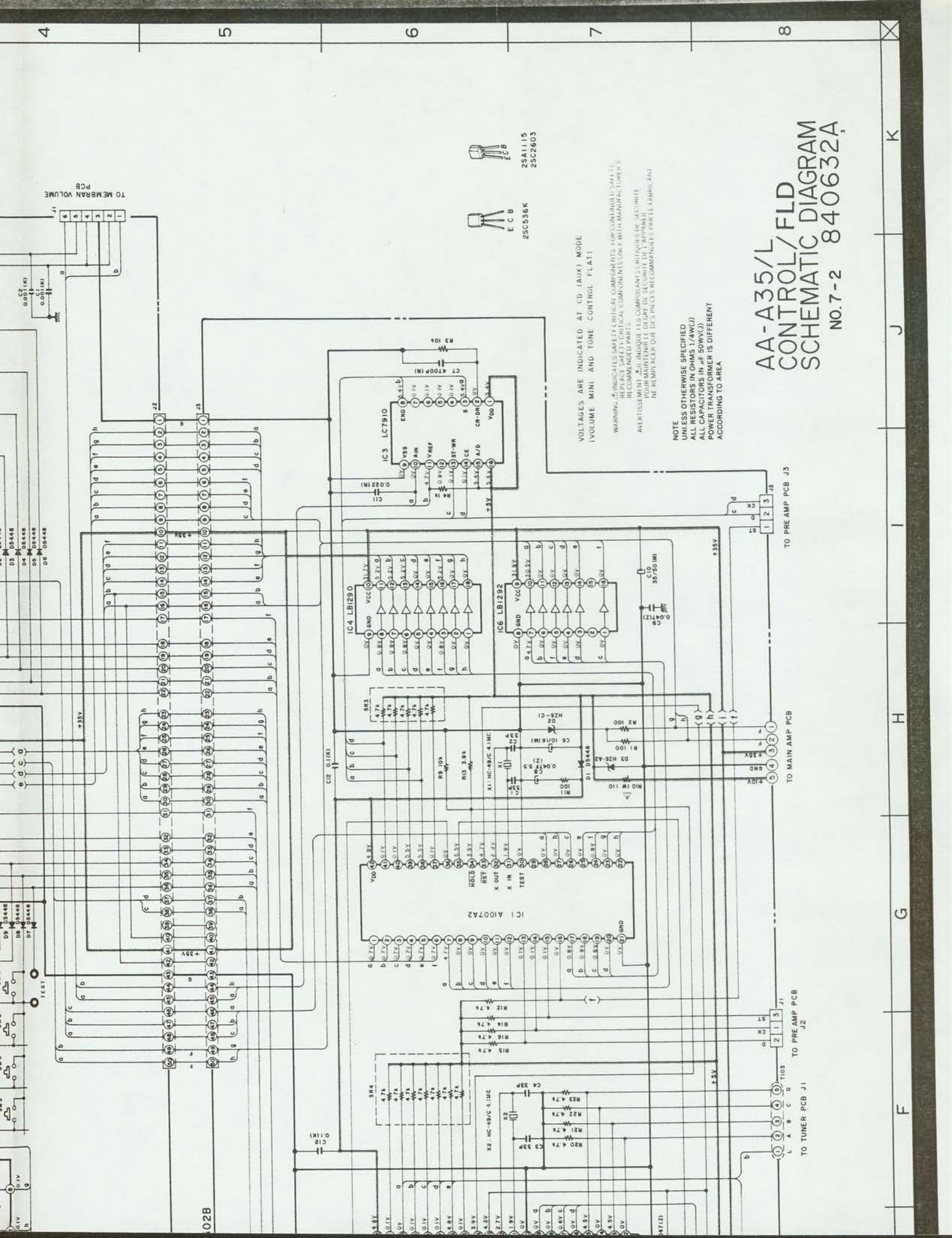
PHONO : 82 + 84 + 86 + 87
CD : 81 + 83 + 85 + 87
TUNER : 80 + 84 + 85 + 87





 25C536K
 28A1115
 25C2603

VOLTAGES ARE INDICATED AT CD 1AUX1 MODE (VOLUME MINI AND TONE CONTROL FLAT)

WARNING: INDICATES SAFETY CRITICAL COMPONENTS FOR LUMINATED SAFETY. REPLACE SAFETY CRITICAL COMPONENTS ONLY WITH MANUFACTURER'S RECOMMENDED PARTS.
 AVERTISSEMENT: INDIQUE LES COMPOSANTS CRITIQUES EN SÉCURITÉ POUR MANUTENIR LE DEGRÉ DE SÉCURITÉ RECOMMANDÉ PAR LE FABRICANT. NE REMPLACEZ QUE LES PIÈCES RECOMMANDÉES PAR LE FABRICANT.

NOTE
 UNLESS OTHERWISE SPECIFIED
 ALL RESISTORS IN OHMS (1/4W/0.1)
 ALL CAPACITORS IN μF (50V/CD)
 POWER TRANSFORMER IS DIFFERENT
 ACCORDING TO AREA

AA-A35/L CONTROL/FLD SCHEMATIC DIAGRAM

NO.7-2 840632A

F G H J K

4

5

6

7

8

02B

TEST

TO TUNER PCB J1

TO PRE AMP PCB J2

TO MAIN AMP PCB

TO PRE AMP PCB J3

TO MAIN AMP PCB

TO MEMBRAN VOLUME PCB

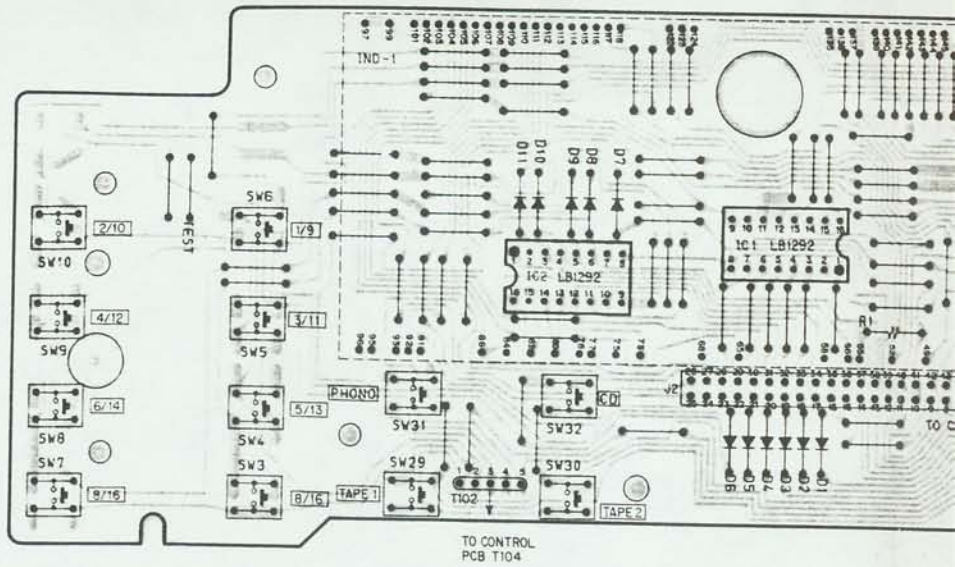

	D4	D5	D7	D8	TR3	R19
U		○		○	○	○
C, A			○			
E.V.S		○				
A35L	○					

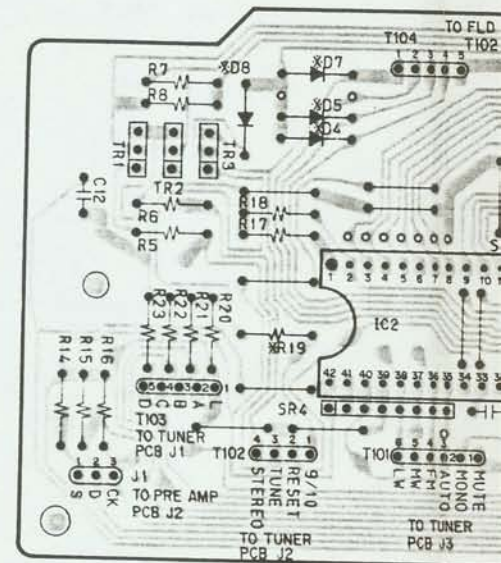

TR1, 2, 3 2SC536K (E, F)



2SC536

● ● ● = NPN
B

SR1, SR3, SR4
● ● ● ●

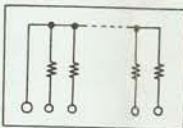

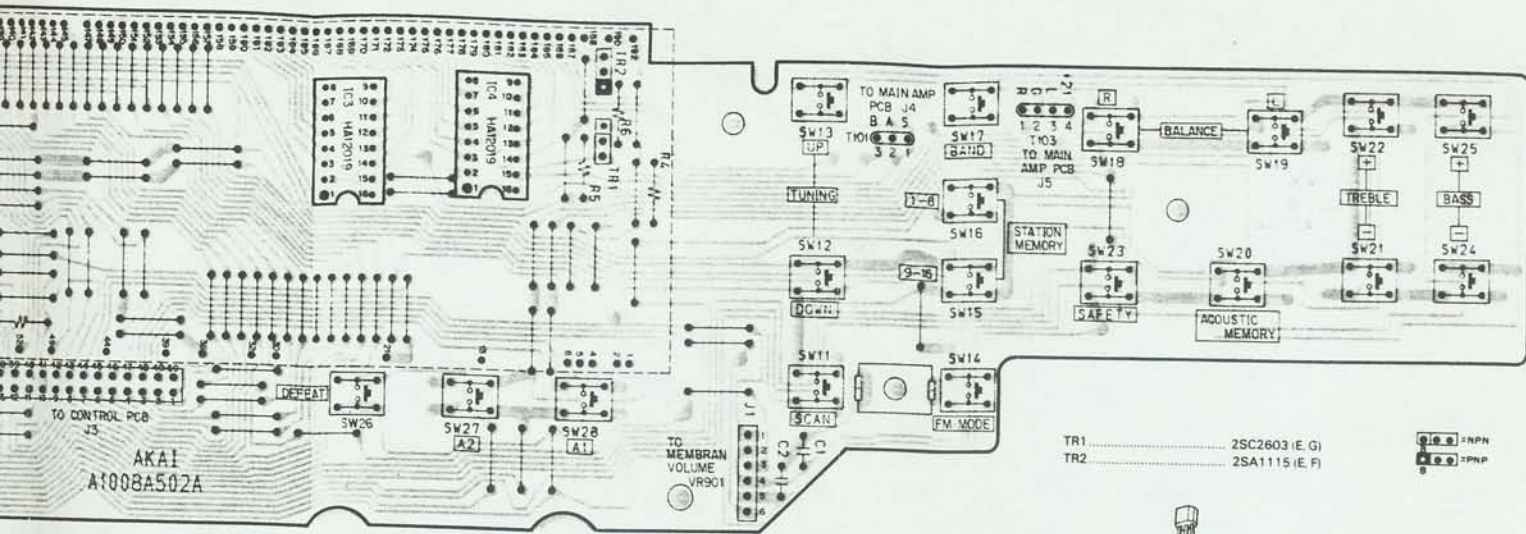

FLD PCB A1008A502A

TR1 2SC2603 (E, G)
 TR2 2SA1115 (E, F)



2SA1115
 2SC2603

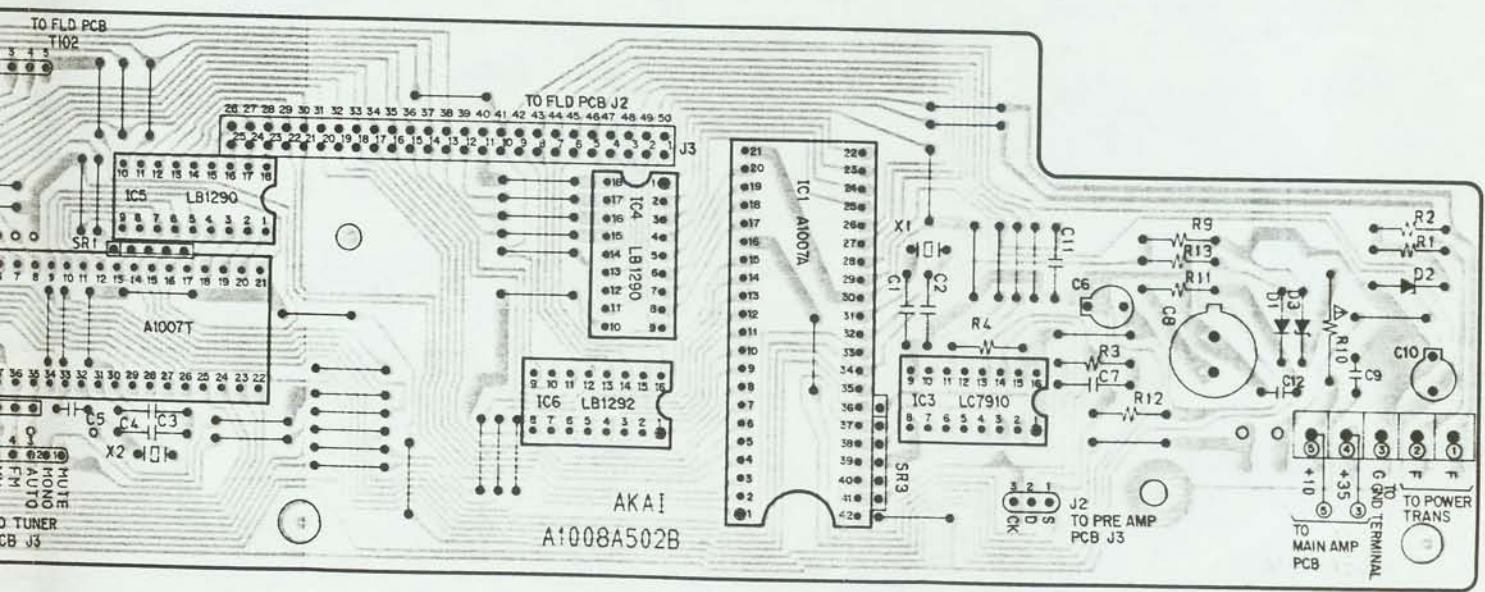

CONTROL PCB A1008A502B

SR1 (4.7 kohmsx4)
 SR3 (4.7 kohmsx5)
 SR4 (4.7 kohmsx7)



AA-A35

TUNER PCB A1007B502A

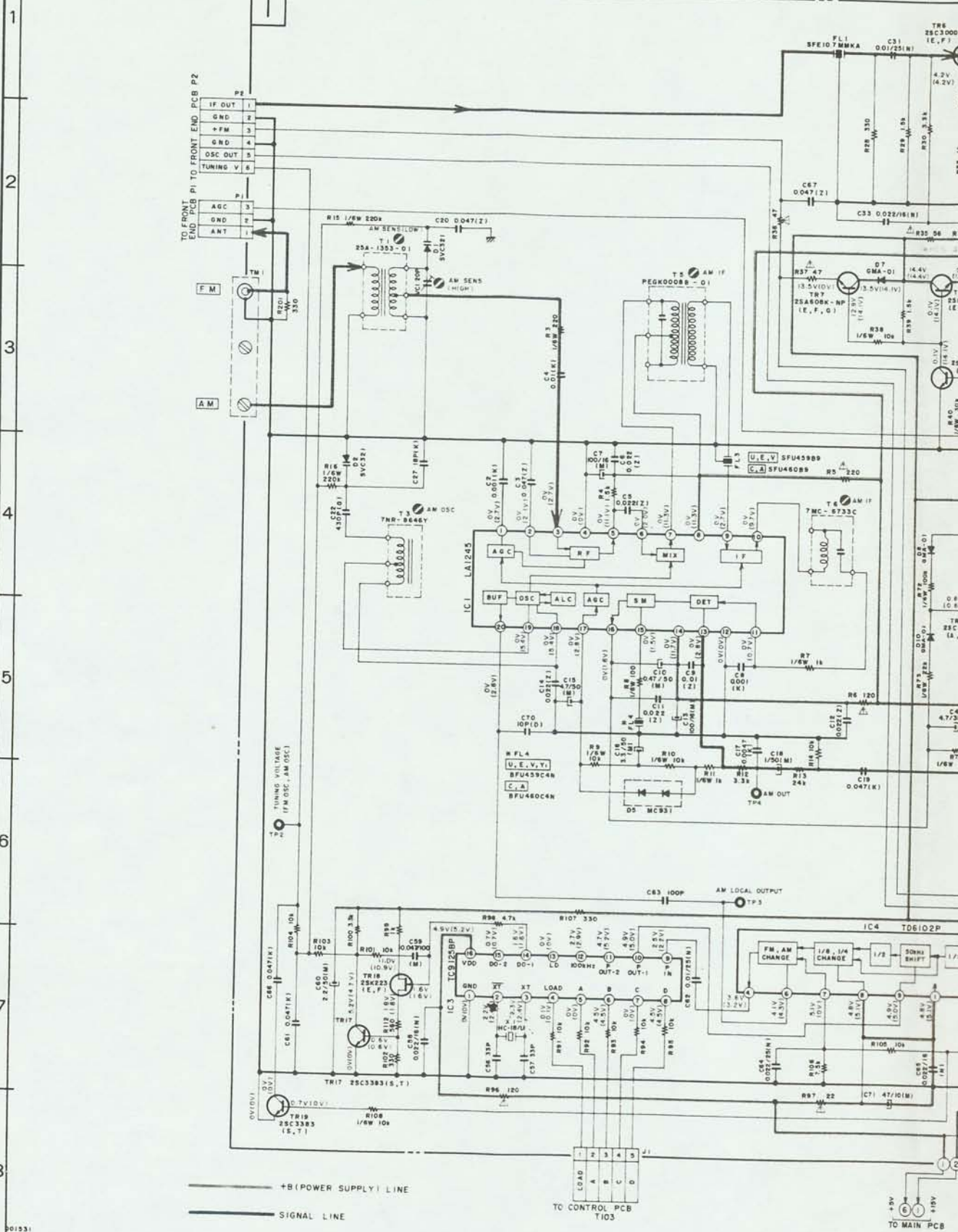

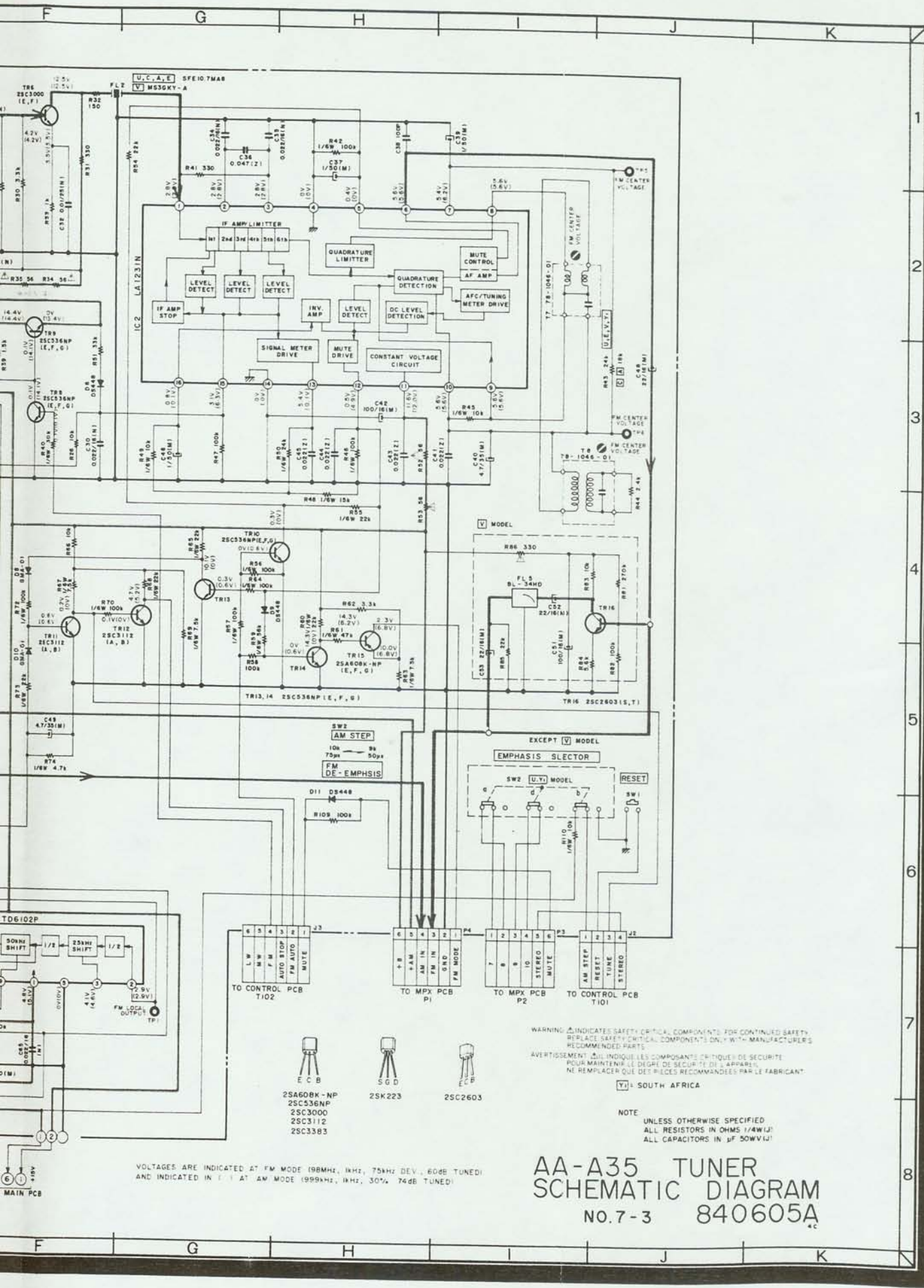

VOLTAGES ARE INDICATED AT FM MODE (98MHz, 1kHz, 75kHz DEV., 60dB TUNED) AND INDICATED IN () AT AM MODE (999kHz, 1kHz, 30% 74dB TUNED)

WARNING: INDICATES SAFETY CRITICAL COMPONENTS. FOR CONTINUED SAFETY, REPLACE SAFETY CRITICAL COMPONENTS ONLY WITH MANUFACTURER'S RECOMMENDED PARTS.
 AVERTISSEMENT: Δ INDIQUE LES COMPOSANTS CRITIQUES DE SECURITE. POUR MAINTENIR LE DEGRE DE SECURITE DE L'APPAREIL, NE REMPLACER QUE DES PIECES RECOMMANDEES PAR LE FABRICANT.

Δ: SOUTH AFRICA

NOTE: UNLESS OTHERWISE SPECIFIED, ALL RESISTORS IN OHMS 1/4W/1%; ALL CAPACITORS IN μF 50WV/10%

AA-A35 TUNER SCHEMATIC DIAGRAM

No. 7-3 840605A

ADJUSTMENT ITEM	POINT
AM SENS (HIGH)	VC1
AM SENS (LOW)	T1
AM OSC	T3
AM IF	T5,T6
FM CENTER VOLTAGE	T7,T8
FM LOCAL OUT PUT	TP1
TUNING VOLTAGE (FM, AM OSC)	TP2
AM LOCAL OUT PUT	TP3
AM OUT PUT	TP4
FM CENTER VOLTAGE	TP5,6

AM STEP
10kHz ↔ 9kHz
75μs ↔ 50μs
EM DE-EMPHASIS

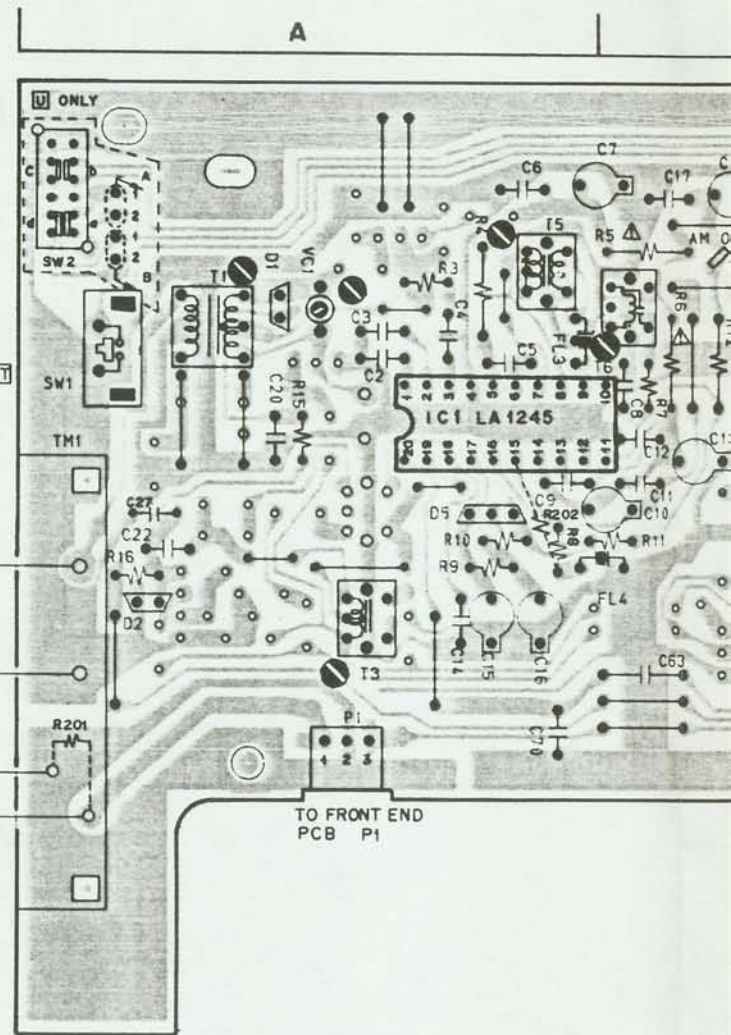

LOCATION OF COMPONENTS

- IC
 IC 1 A 2
 IC 2 B 2
 IC 3,4 C 4
- TR
 TR 6 B 2
 TR 7 to 9 D 3
 TR 10,11 C 1
 TR 12 D 2
 TR 13,14 D 1
 TR 15 D 2
 TR 16 C 2
 TR 17,18 C 4
 TR 19 C 3

- TR 6 2SC 3000 (E,F)
 TR 7 2SA 608K-NP (E,F,G)
 TR 8 to 10 2SC 536 NP (E,F,G)
 TR 11,12 2SC 3112 (A,B)
 TR 13,14 2SC 536 NP (E,F,G)
 TR 15 2SA 608K-NP (E,F,G)
 TR 16 2SC 2603 (S,T)
 TR 17 2SC 3383 (S,T)
 TR 18 2SK 223 (E)
 TR 19 2SC 338 (S,T)

TERMINAL

- P1 A 3
 P2 B 3
 P3 D 4
 P4 D 2
 J1 D 4
 J2 D 3
 J3 D 2
 ① ④ D 1

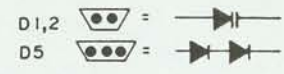
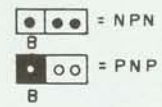

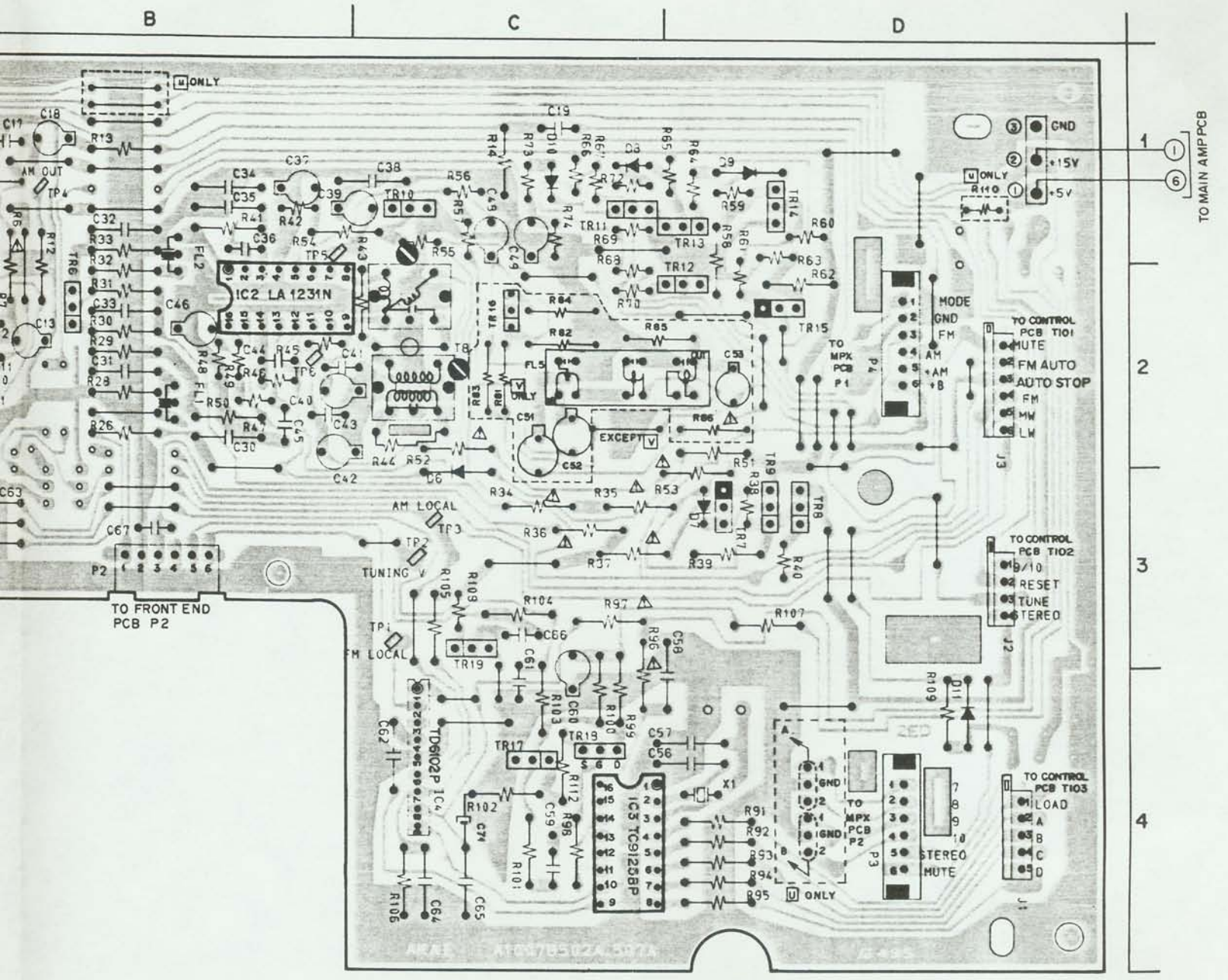

TUNER PCB A1007B502A U C A E V S

WARNING: Δ INDICATES SAFETY CRITICAL COMPONENTS FOR CONTINUED SAFETY. REPLACE SAFETY CRITICAL COMPONENTS ONLY WITH MANUFACTURER'S RECOMMENDED PARTS

AVERTISSEMENT: Δ IL INDIQUE LES COMPOSANTS CRITIQUES DE SÉCURITÉ. POUR MAINTENIR LE DEGRÉ DE SÉCURITÉ DE L'APPAREIL, NE REMPLACER QUE DES PIÈCES RECOMMANDÉES PAR LE FABRICANT

AA-A35L

TUNER PCB A1007B507A

TO FRONT
END PCB P1
TO FRONT
END PCB P2

P2
IF OUT 1
GND 2
+FM 3
GND 4
OSC OUT 5
TUNING V 6

P1
AGC 3
GND 2
ANT 1

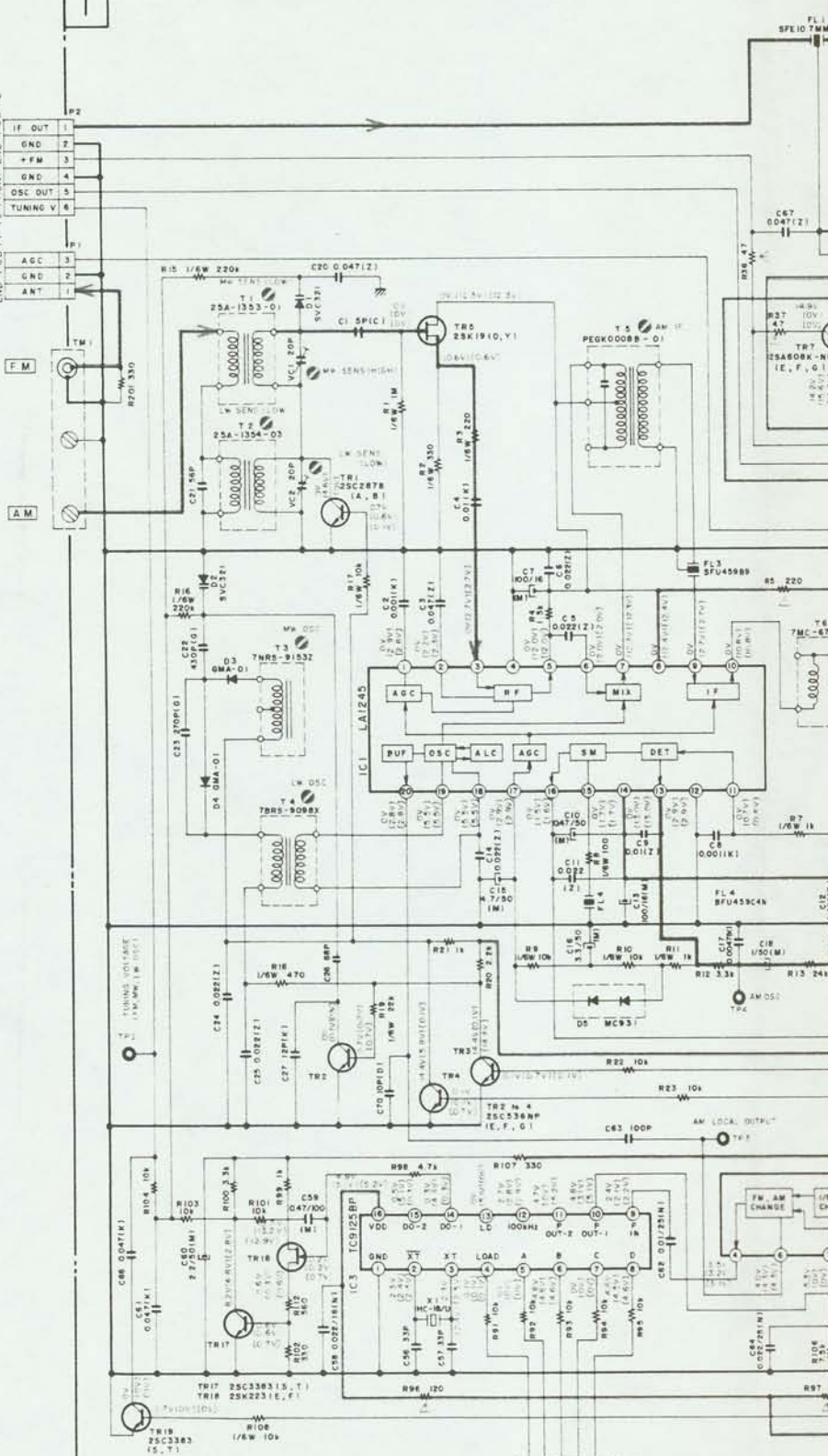

— +B (POWER SUPPLY) LINE
— SIGNAL LINE

TO CONTROL PCB
T103

001532

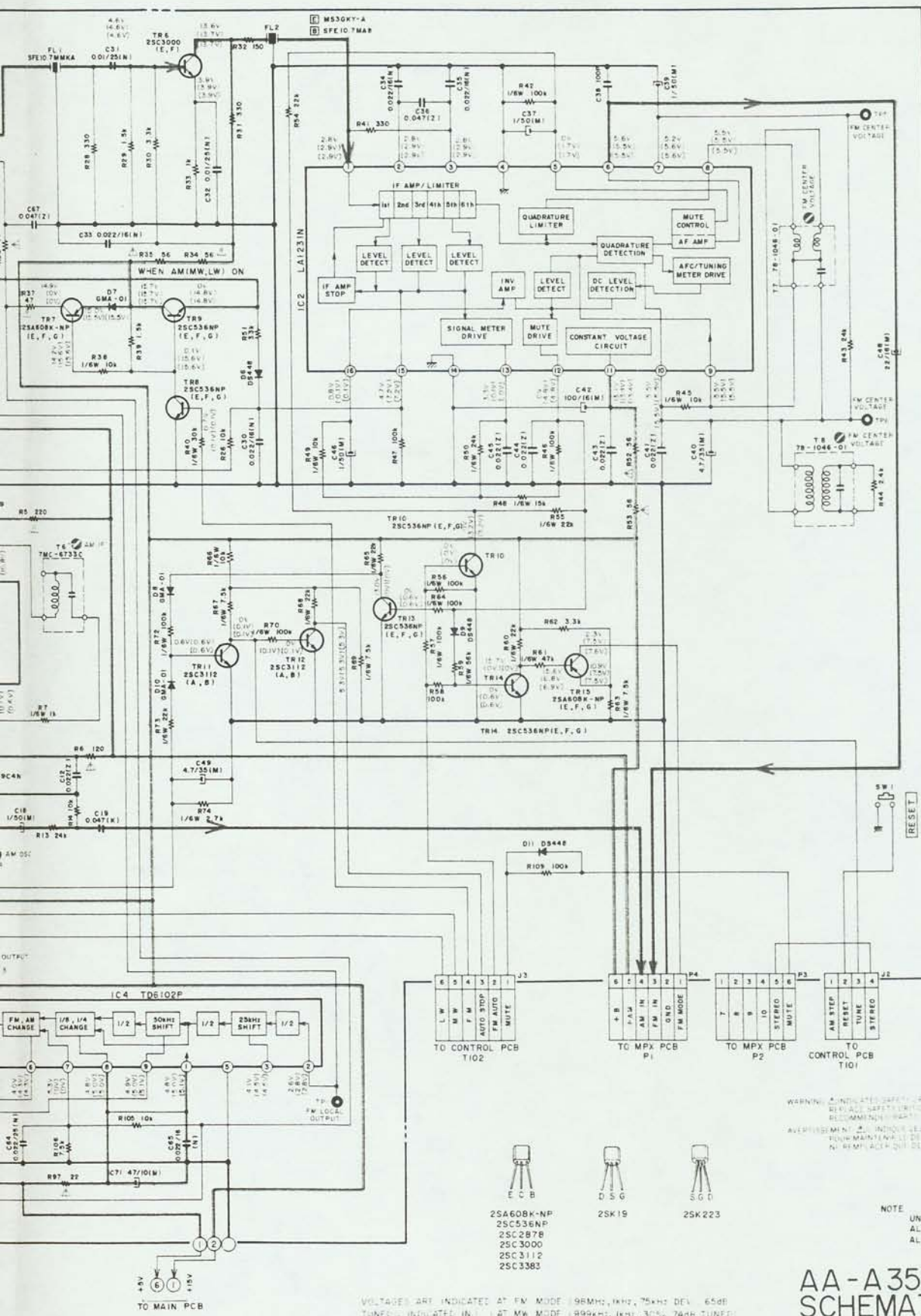

WARNING: INDICATED SAFETY CRITICAL COMPONENTS FOR CONTINUED SAFETY. ALL SAFETY CRITICAL COMPONENTS ON 1 WITH MANUAL TUNER IS RECOMMENDED PART.

AVOID COMPONENTS WITH UNUSUAL COMPONENTS (ELECTRICAL SPECIFICATIONS) FROM MANUFACTURERS WHOSE QUALITY OF SUPPLY IS NOT KNOWN. RECOMMENDED PARTS LIST IS AVAILABLE.

NOTE: UNLESS OTHERWISE SPECIFIED, ALL RESISTORS IN OHMS (1/4W/1%), ALL CAPACITORS IN μF 50 WV/10%

- 2SA608K-NP
- 2SC536NP
- 2SC287B
- 2SC3000
- 2SC3112
- 2SC3383
- 2SK19
- 2SK223

VOLTAGES ARE INDICATED AT FM MODE (98MHz, 1kHz, 75kHz DEV, 65dB TUNED); INDICATED IN () AT MW MODE (895kHz, 1kHz, 30% 74dB TUNED); ANT INDICATED IN () AT LW MODE (200kHz, 1kHz, 30% 90dB TUNED)

AA-A35L TUNER SCHEMATIC DIAGRAM

NO. 7-4 840606B

ADJUSTMENT ITEM	POINT
MW SENS (LOW)	T 1
MW SENS (HIGH)	VC 1
LW SENS (LOW)	T 2
LW SENS (HIGH)	VC 2
LW OSC	T 4
MW OSC	T 3
AM IF	T 5, T 6
FM CENTER VOLTAGE	T 7, T 8
FM LOCAL OUT PUT	TP 1
TUNING VOLTAGE (FM, LW, MW OSC)	TP 2
AM LOCAL OUTPUT	TP 3
AM OUT PUT	TP 4
FM CENTER VOLTAGE	TP 5, 6

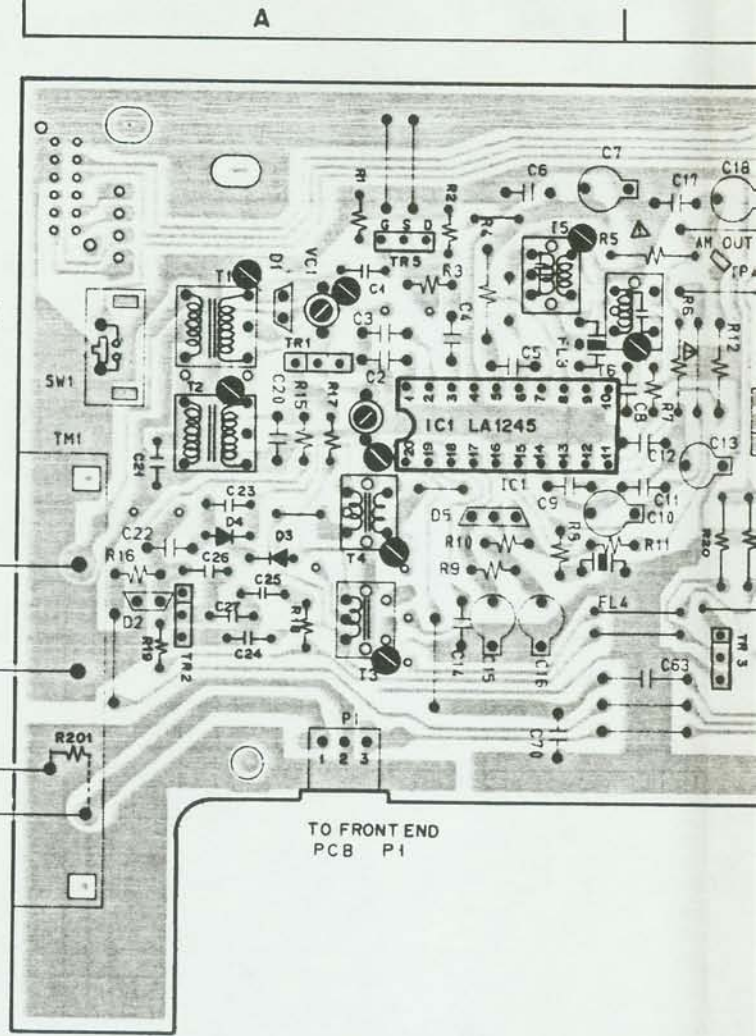
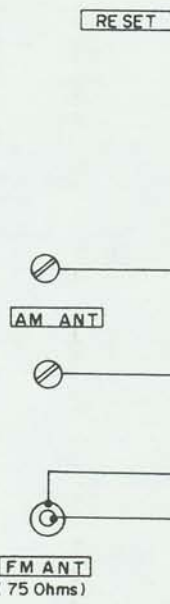

LOCATION OF COMPONENTS

IC

- IC 1 A2
- IC 2 B2
- IC 3,4 C4

TR

- TR 1 A1
- TR 2 A2
- TR 3,4 B3
- TR 5 A1
- TR 6 B2
- TR 7 to 9 D3
- TR 10, 11 C1
- TR 12 D2
- TR 13, 14 D1
- TR 15 D2
- TR 17, 18 C4
- TR 19 C3

- TR 4 2SC2878 (A, B)
- TR 2 to 4 2SC536NP (E, F, G)
- TR 5 2SK19 (O, Y)
- TR 6 2SC3000 (E, F)
- TR 7 2SA608K-NP (E, F, G)
- TR 8 to 10 2SC536NP (E, F, G)
- TR 11, 12 2SC3112 (A, B)
- TR 13, 14 2SC536NP (E, F, G)
- TR 15 2SA608K-NP (E, F, G)
- TR 17 2SC3383 (S, T)
- TR 18 2SK223 (E)
- TR 19 2SC3383 (S, T)

TERMINAL

- P1 A3
- P2 B3
- P3 D4
- P4 D2
- J1 D4
- J2 D3
- J3 D2
- ① to ④ D1

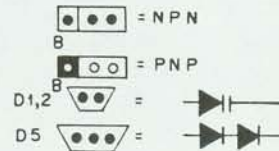

TO FRONT END
PCB P1

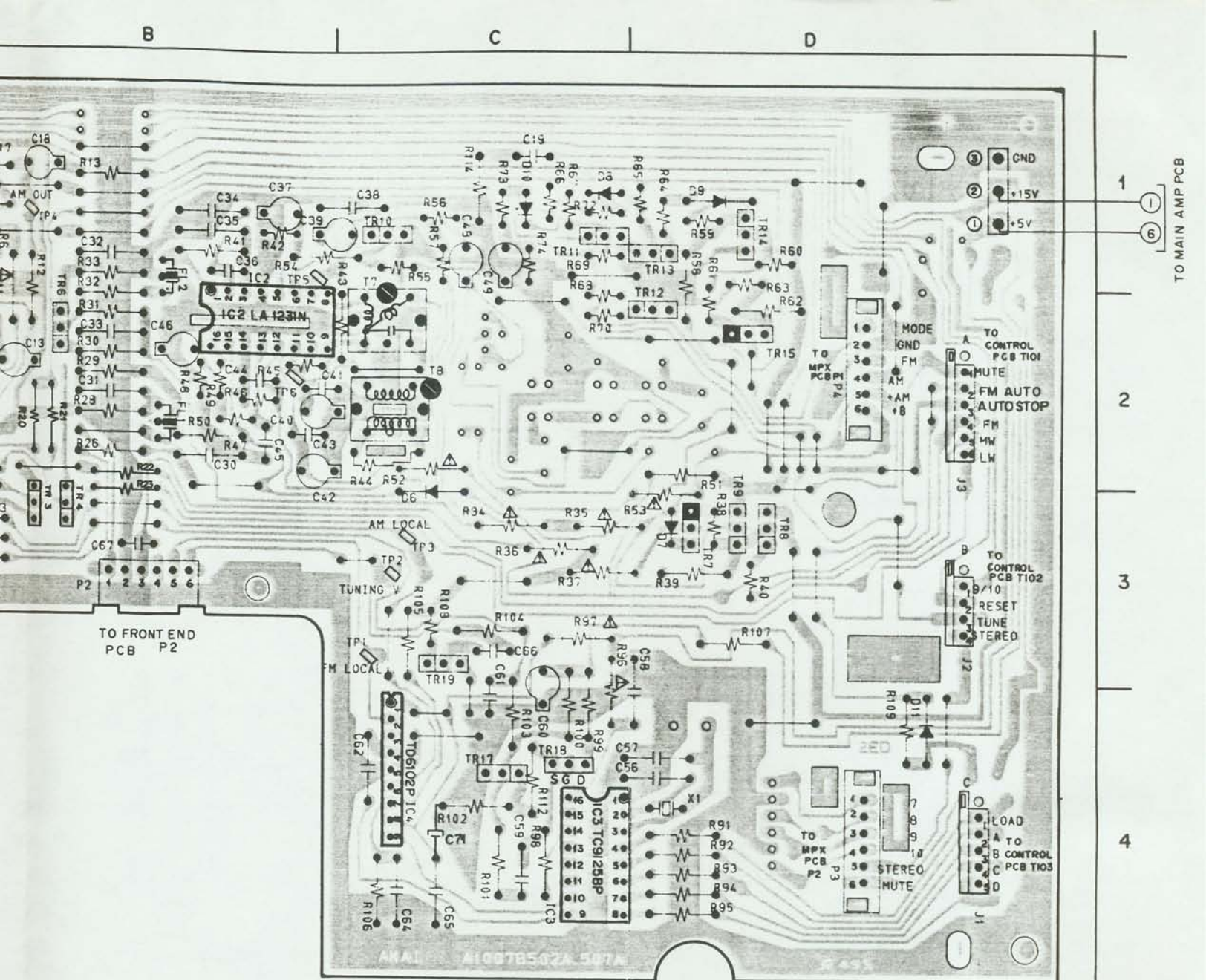

TUNER PCB A1007B507A (2ED) B E

WARNING: Δ INDICATES SAFETY CRITICAL COMPONENTS. FOR CONTINUED SAFETY, REPLACE SAFETY CRITICAL COMPONENTS ONLY WITH MANUFACTURER'S RECOMMENDED PARTS.

AVERTISSEMENT: Δ IL INDIQUE LES COMPOSANTS CRITIQUES DE SÉCURITÉ. POUR MAINTENIR LE DEGRÉ DE SÉCURITÉ DE L'APPAREIL, NE REMPLACER QUE DES PIÈCES RECOMMANDÉES PAR LE FABRICANT.

AA-A35/L

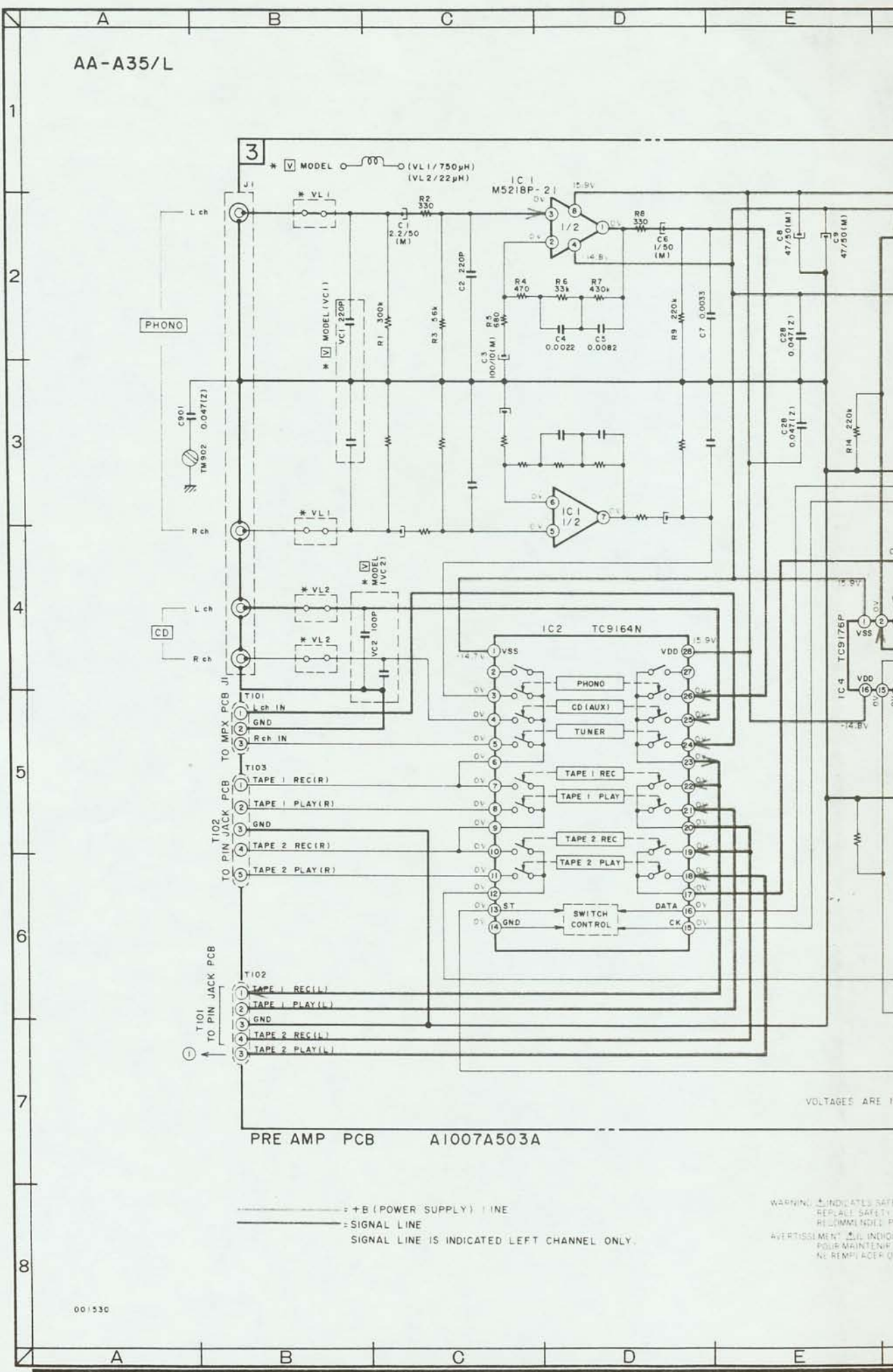

PRE AMP PCB A1007A503A

- - - - - +B (POWER SUPPLY) LINE
 ———— SIGNAL LINE
 ———— SIGNAL LINE IS INDICATED LEFT CHANNEL ONLY.

VOLTAGES ARE IN

WARNING: ⚡ INDICATES SAFETY
 REPLACEMENT SAFETY C
 RECOMMENDED PA
 AVERTISSEMENT: ⚡ IL INDICQ
 POUR MAINTENIR L
 NE REMPLACER QU

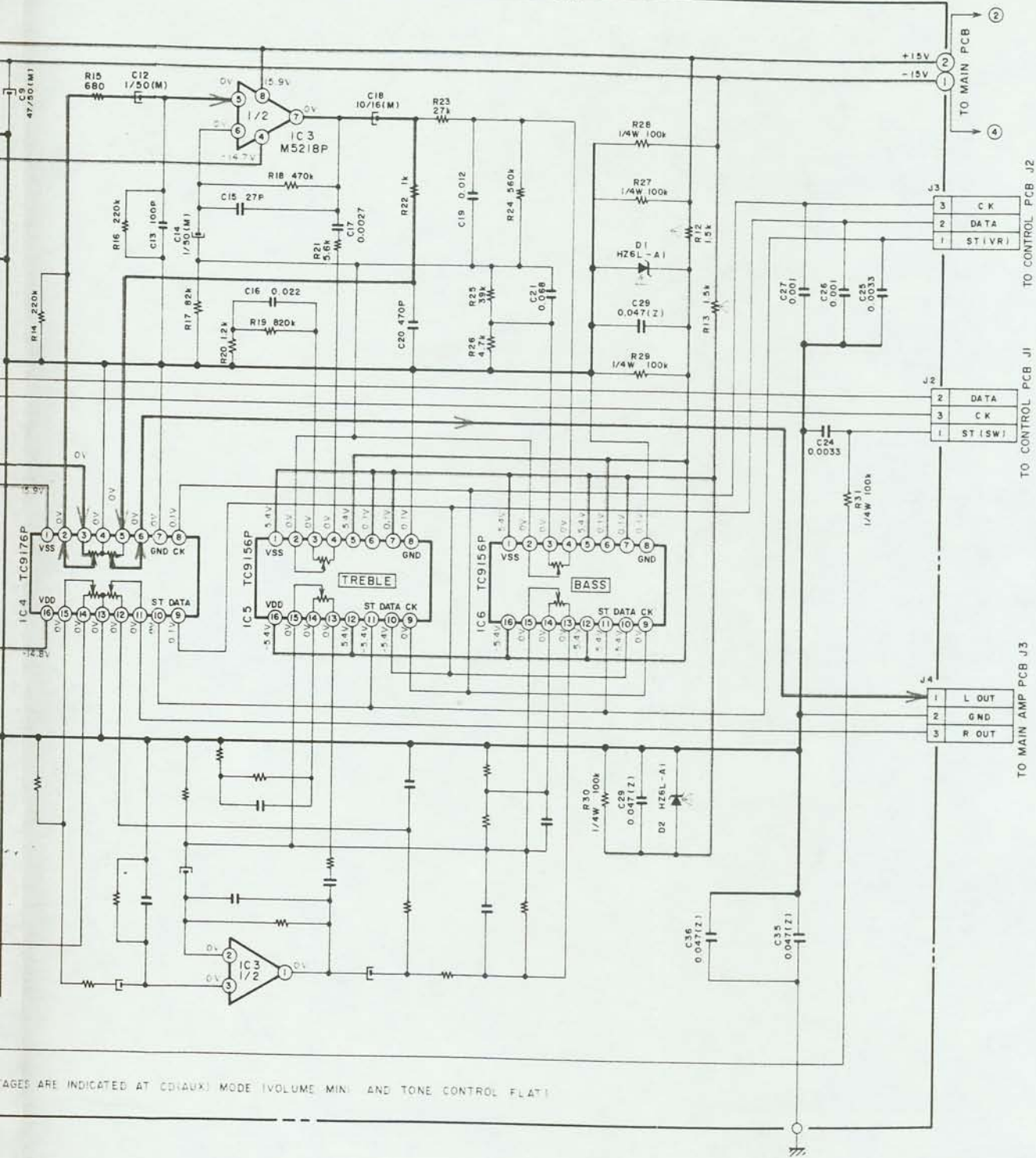

AGES ARE INDICATED AT (C) (AUX) MODE (VOLUME MIN) AND TONE CONTROL (FLAT)

INDICATES SAFETY CRITICAL COMPONENTS FOR CONTINUED SAFETY
 PLACE SAFETY CRITICAL COMPONENTS ONLY WITH MANUFACTURER'S
 COMMENDED PART

NOTE
 UNLESS OTHERWISE SPECIFIED
 ALL RESISTORS IN OHMS 1/6W(J)
 ALL CAPACITORS IN μ F 50 WV(J)

AA-A35/L PRE AMP
 SCHEMATIC DIAGRAM
 NO. 7-5 840607A (A2)
 4C

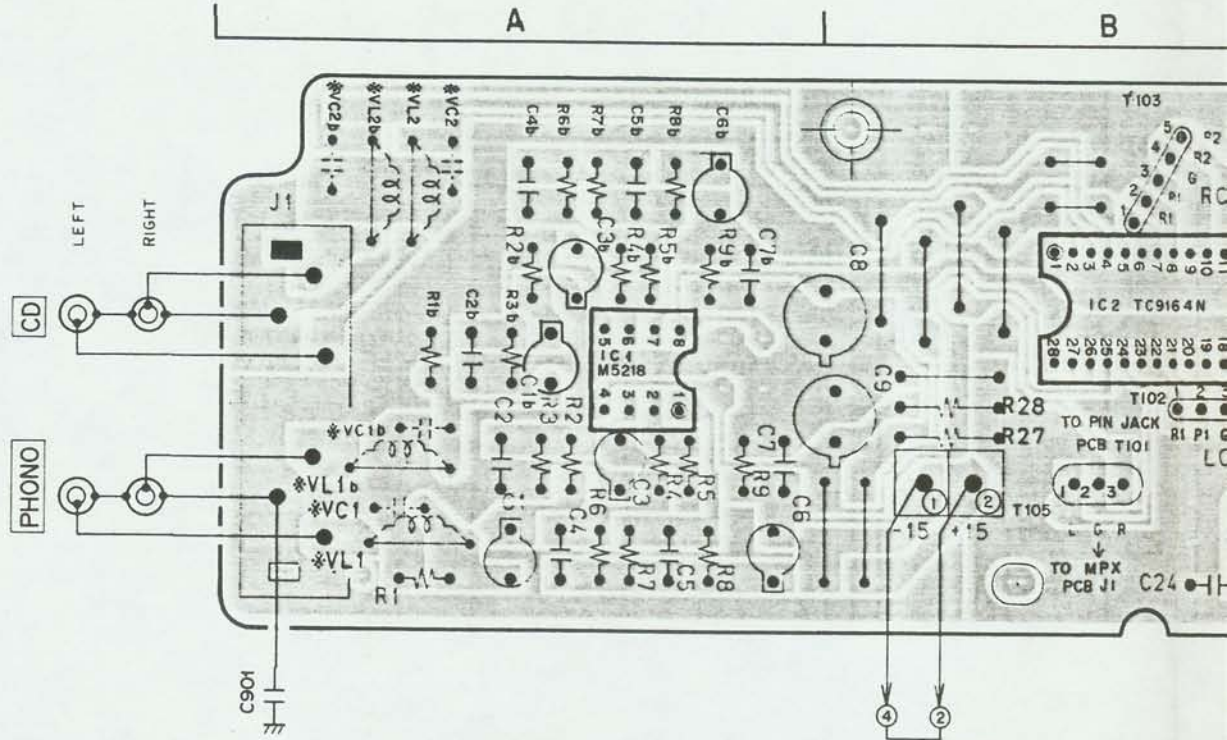

VL1, 1b, 2, 2b } model only
 VC1, 1b, 2, 2b }

LOCATION OF COMPONENTS

IC		TERMINAL	
IC1	A1	T103	B1
IC2	B1	T104,105	B2
IC3,4	C1	J2	B2
IC5,6	D1	J3	D2
		J4	C2
		①②	B2

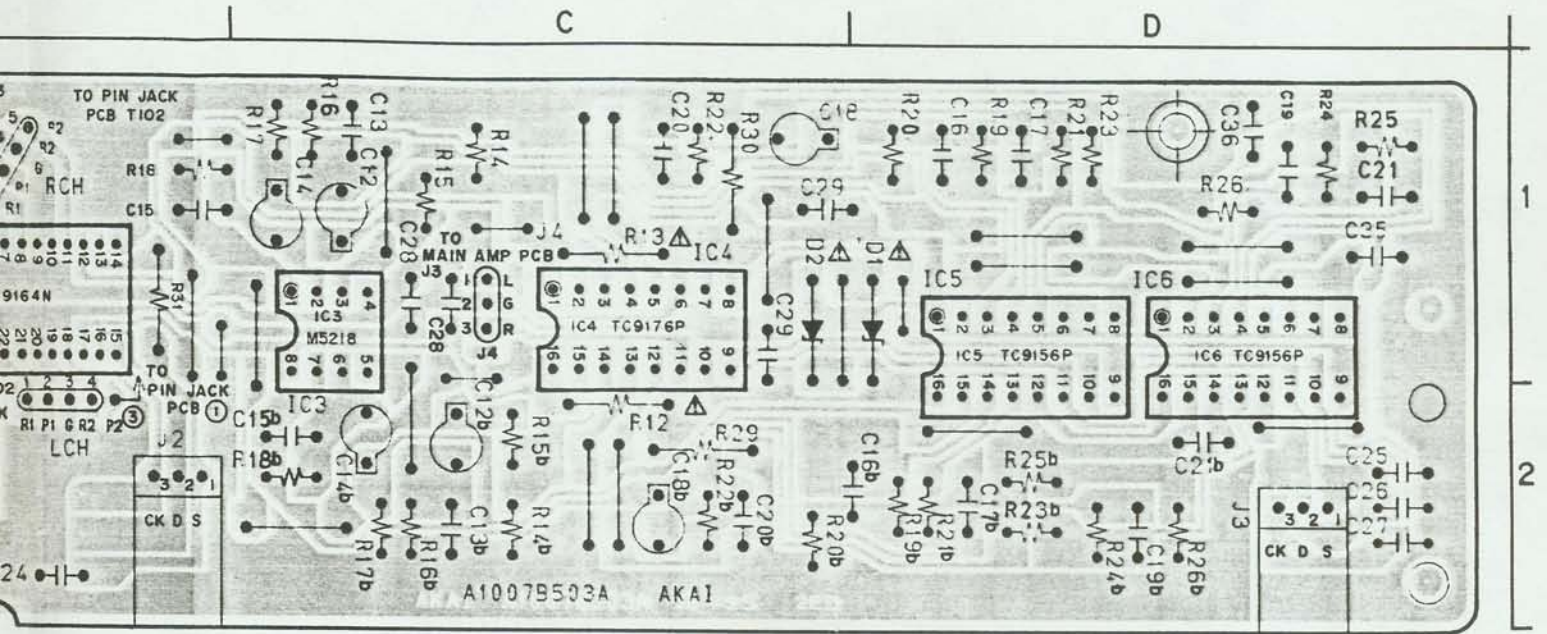

PRE AMP PCB A1007B503A

TO CONTROL (A) PCB
T110

TO CONTROL (A) PCB
T109

WARNING: ⚠ INDICATES SAFETY CRITICAL COMPONENTS. FOR CONTINUED SAFETY,
REPLACE SAFETY CRITICAL COMPONENTS ONLY WITH MANUFACTURER'S
RECOMMENDED PARTS
AVERTISSEMENT: ⚠ IL INDIQUE LES COMPOSANTS CRITIQUES DE SÉCURITÉ
POUR MAINTENIR LE DEGRÉ DE SÉCURITÉ DE L'APPAREIL,
NE REMPLACER QUE DES PIÈCES RECOMMANDÉES PAR LE FABRICANT

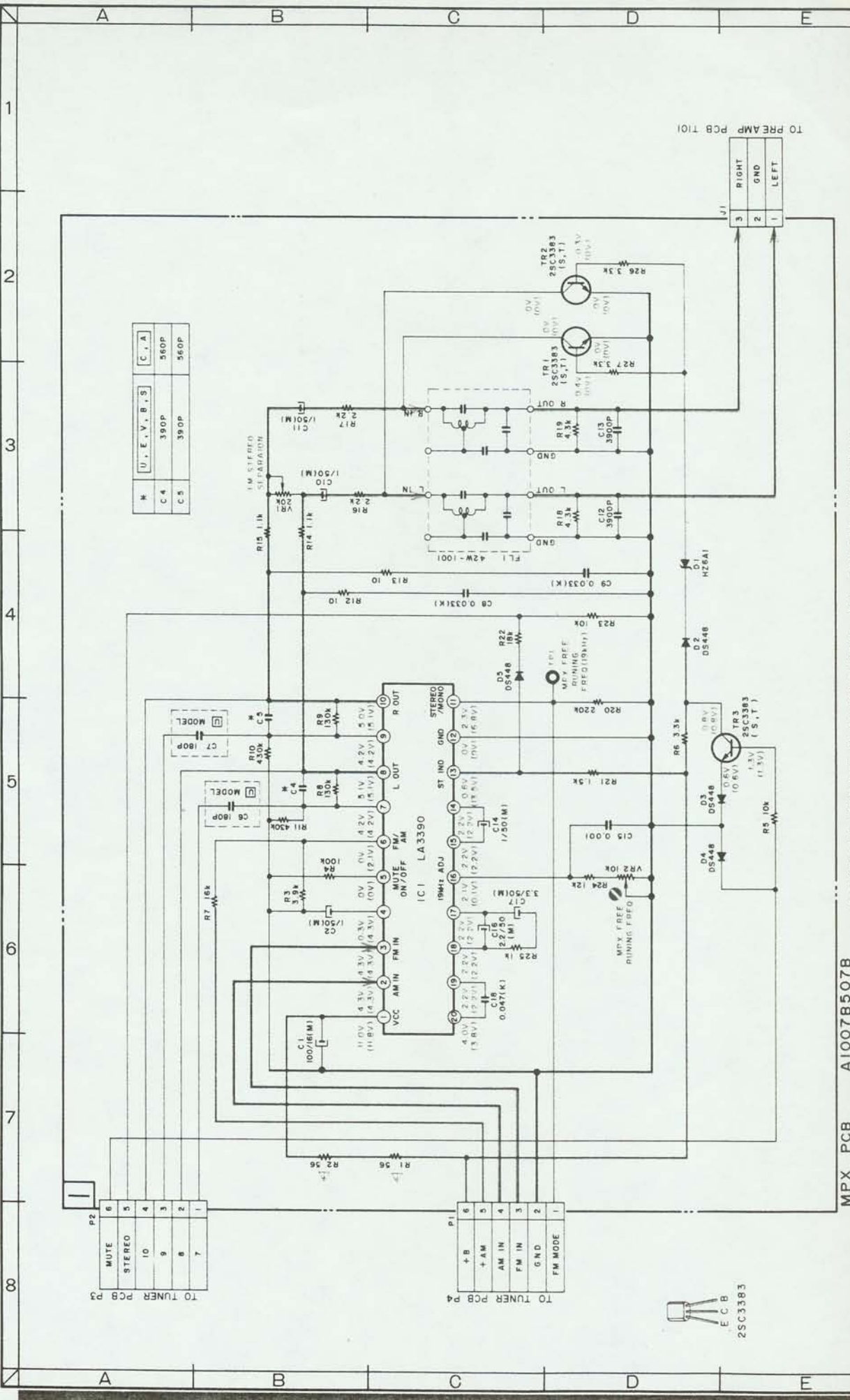

#	U, E, V, B, S	C, A
C4	390P	560P
C5	390P	560P

TO TUNER PCB P3	
6	MUTE
5	STEREO
4	10
3	9
2	8
1	7

TO TUNER PCB P4	
6	+B
5	+AM
4	AM IN
3	FM IN
2	GND
1	FM MODE

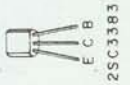

MPX PCB A100785078

VOLTAGES ARE INDICATED AT FM MODE (98MHz, 1kHz, 75kHz DEV., 60Hz TUNED)
AND INDICATED IN () AT AM MODE (500kHz, 1kHz, 30%, 74Hz TUNED)

AA-A35/L
SCHEMATIC DIAGRAM

+B(POWER SUPPLY) LINE

NOTE

AA-A35/L MPX SCHEMATIC DIAGRAM 840608A (A3)

NO. 7 - 6

VOLTAGES ARE INDICATED AT FM MODE (98MHz, 1kHz, 75kHz DEV, 50dB TUNED) AND INDICATED IN () AT AM MODE (99kHz, 1kHz, 30%, 74dB TUNED)

NOTE
UNLESS OTHERWISE SPECIFIED
ALL RESISTORS IN OHMS (AW(U))
ALL CAPACITORS IN μ F 50 WV(U)

WARNING: INDICATES SAFETY CRITICAL COMPONENTS FOR CONSUMER SAFETY.
UNLESS OTHERWISE SPECIFIED, ALL SAFETY CRITICAL COMPONENTS ARE TO BE USED WITH ORIGINAL PARTS.
AVERTISSEMENT: IL INDIQUE LES COMPOSANTS CRITIQUES DE SECURITE.
POUR MAINTENIR LE DEGRÉ DE SECURITE DE L'APPAREIL,
NE REMPLACER QUE DES PIÉCES RECOMMANDÉES PAR LE FABRICANT.

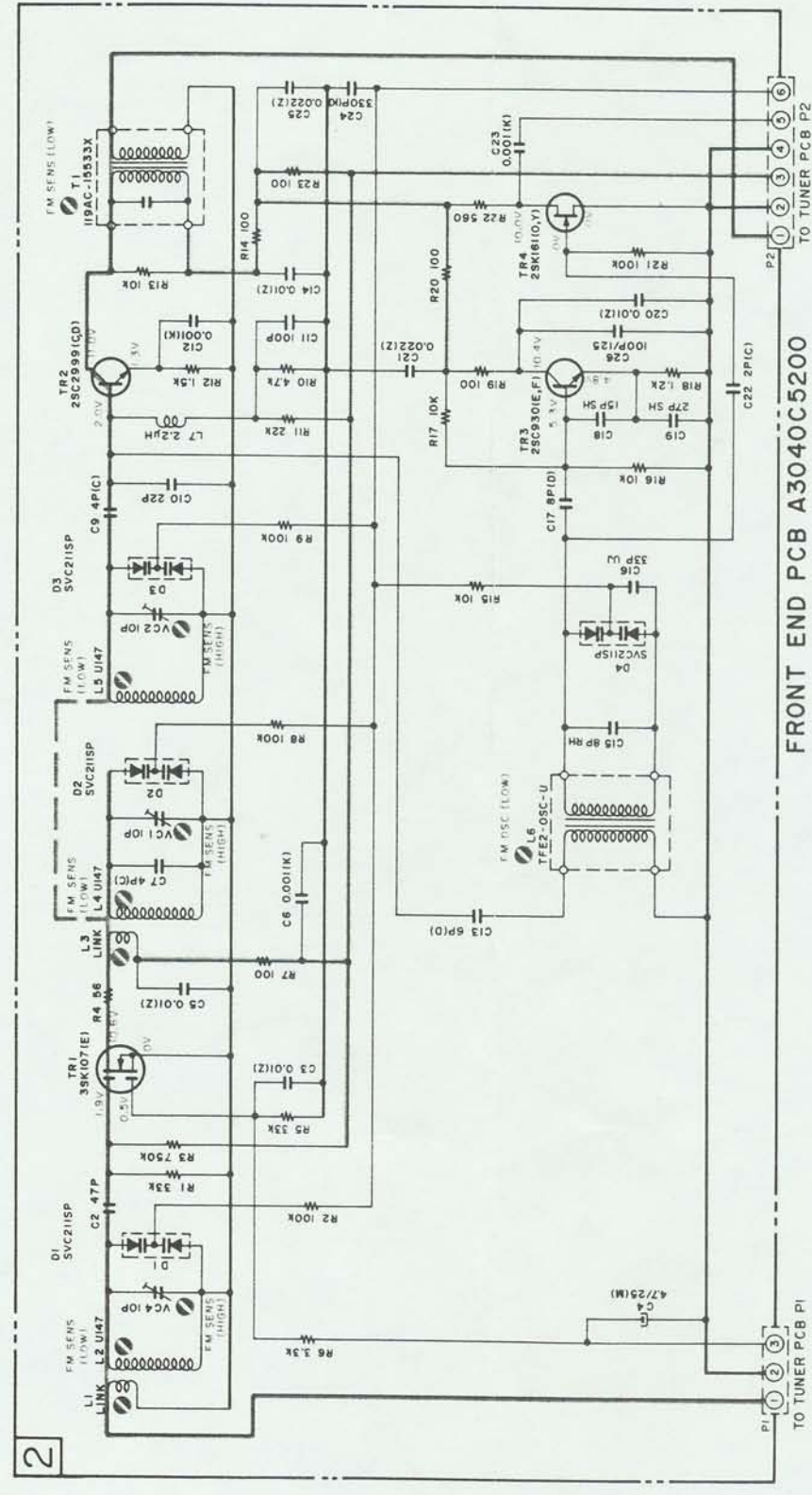

--- : +B (POWER SUPPLY) LINE
--- : FM SIGNAL LINE

- 25C930 E C B
- 25C2999 E C B
- 25K161 D S G
- 35K107 G2 D S

VOLTAGES ARE INDICATED AT FM MODE
(98MHz, 1kHz, 75kHz DEV, 60dB TUNED)

AA-A35/L FRONT END SCHEMATIC DIAGRAM NO.7-7 840224B (A3)

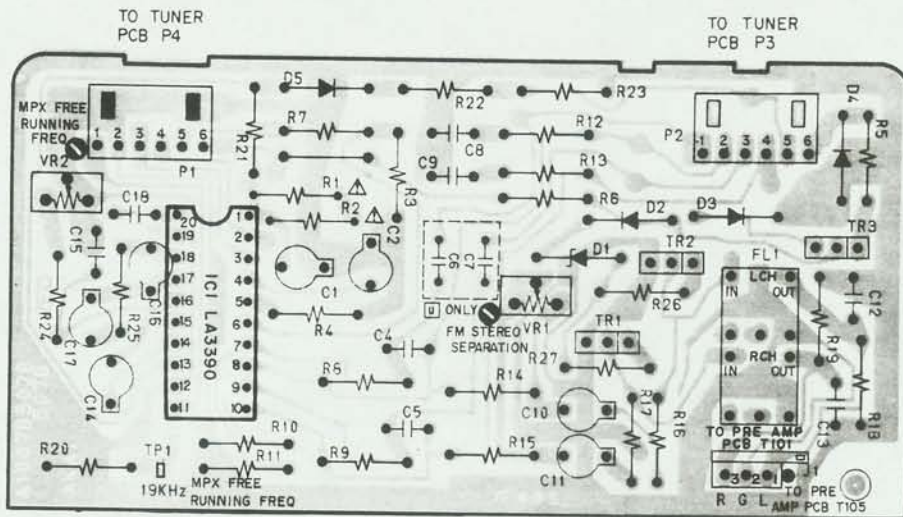

MPX PCB
 AI007B502B UCAEVS
 AI007B507B BE (AA-A35L)

TR1,2,3 --- 2SC3383(S,T)

••• = NPN
 B



2SC3383(S,T)

WARNING: Δ INDICATES SAFETY CRITICAL COMPONENTS. FOR CONTINUED SAFETY, REPLACE SAFETY CRITICAL COMPONENTS ONLY WITH MANUFACTURER'S RECOMMENDED PARTS.
 AVERTISSEMENT: Δ IL INDIQUE LES COMPOSANTS CRITIQUES DE SÉCURITÉ. POUR MAINTENIR LE DEGRÉ DE SÉCURITÉ DE L'APPAREIL, NE REMPLACER QUE DES PIÈCES RECOMMANDÉES PAR LE FABRICANT.

ADJUSTMENT POINT	
LI to 5	FM SENS (LOW)
VC1,2,4	FM SENS (HIGH)
L6	FM OSC (LOW)
T1	◦ FM SENS (LOW)
	◦ FM STEREO DISTORTION

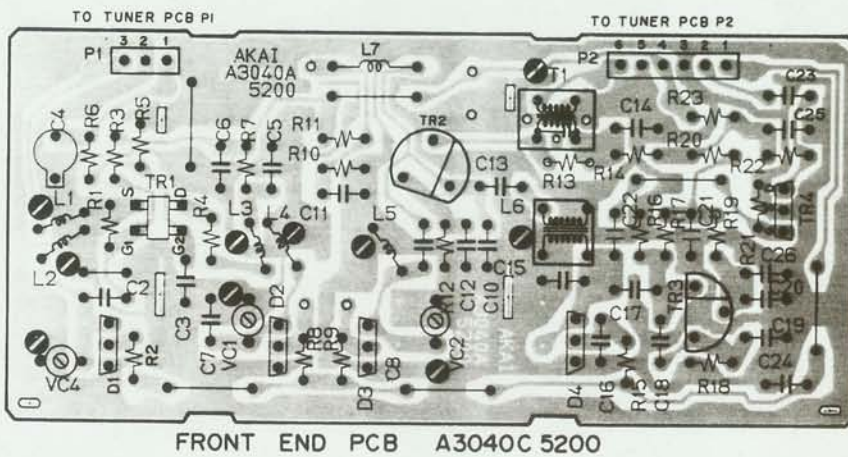

FRONT END PCB A3040C 5200

TR1-----3SK107 (E)
 TR2-----2SC2999 (C,D)
 TR3-----2SC930 (E,F)
 TR4-----2SK161 (O,Y)



2SC930



2SC2999



2SK161



3SK107

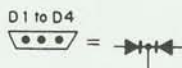

AA-A35/L

AKAI ELECTRIC CO., LTD.

12-14-2 Chome, Higashi-Kojima, Ohta-Ku, Tokyo, Japan
TEL: Tokyo 742-5111 CABLE: HIFAKAI TOKYO TB EX: J28261
Printed No. 840619 (3/8700) Printed Date: Jun. 18, 1984
Printed in Japan