



NSX-WVT77 HR

SERVICE MANUAL

COMPACT DISC
STEREO CASSETTE RECEIVER

BASIC CD MECHANISM: 6ZG-1 VZRNDM
BASIC TAPE MECHANISM: 2ZM-3MK2 PR4NM

- Replace this Service manual with "Revision Publishing" when it is issued.

aiwa
S/M Code No. 09-006-433-1T1

SIMPLE

DATA

ELECTRICAL MAIN PARTS LIST - 1/10

NOTE: The characters in the suffix column indicate the part usage.

HR	REF.NO	PARTS NO.	DESCRIPTION	SUFFIX
			XX.....A.....	
			KANRI	
			NO.	
C	603	87-010-112-040	CAP,E 100-16	A.....
C	602	87-010-186-080	CAP,CHIP 4700P	A.....
C	601	87-010-196-080	CHIP CAPACITOR,0.1-25	A.....
C	606	87-010-320-080	CHIP CAP 68P	A.....
C	604	87-010-405-040	CAP,E 10-50	A.....
C	605	87-010-546-040	CAP,E 0.33-50	A.....
C	608	87-012-157-080	C-CAP,S 330P-50 CH	A.....
C	621	87-010-178-080	CHIP CAP 1000P	A.....
CN	602	87-A60-082-010	CONN,05P H 9604S-05F	A.....
J	602	87-A61-242-010	JACK,6.3 BLK MONO W/SW V KM	A.....
J	601	87-A61-242-010	JACK,6.3 BLK MONO W/SW V KM	A.....
L	601	87-003-098-080	COIL,2.2UH	A.....
Q	604	87-A30-075-080	C-TR,2SA1235F	A.....
*		8A-NF3-204-010	GUIDE,LED-CASS	A.....
C	161	87-010-178-080	CHIP CAP 1000P	A.....
C	162	87-012-156-080	C-CAP,S 220P-50 CH	A.....
C	401	87-010-196-080	CHIP CAPACITOR,0.1-25	A.....
C	407	87-010-322-080	C-CAP,S 100P-50 CH	A.....
C	410	87-010-196-080	CHIP CAPACITOR,0.1-25	A.....
C	417	87-010-322-080	C-CAP,S 100P-50 CH	A.....
C	423	87-010-196-080	CHIP CAPACITOR,0.1-25	A.....
C	424	87-010-196-080	CHIP CAPACITOR,0.1-25	A.....
C	501	87-010-178-080	CHIP CAP 1000P	A.....
C	502	87-012-156-080	C-CAP,S 220P-50 CH	A.....
C	532	87-010-196-080	CHIP CAPACITOR,0.1-25	A.....
C	531	87-010-196-080	CHIP CAPACITOR,0.1-25	A.....
CN	104	87-099-750-010	CONN,15P V 9604SC	A.....
CN	302	87-A60-059-010	CONN,08P V 9604S-08C	A.....
IC	401	87-070-289-040	IC,BU 2092F	A.....
IC	402	87-A21-021-040	C-IC,BU2099FV	A.....
LED	101	87-A40-317-080	LED,SLR-342VCT31 RED	A.....
LED	421	87-A40-831-010	LED,SELU1E10CXM-LF70 BLUE-DEF	A.....
LED	422	87-A40-831-010	LED,SELU1E10CXM-LF70 BLUE-DEF	A.....
LED	444	87-A40-380-180	LED,SEL6510C-TP5 GRN	A.....
LED	449	87-A40-380-180	LED,SEL6510C-TP5 GRN	A.....
LED	441	87-A40-380-180	LED,SEL6510C-TP5 GRN	A.....
LED	447	87-A40-380-180	LED,SEL6510C-TP5 GRN	A.....
LED	443	87-A40-380-180	LED,SEL6510C-TP5 GRN	A.....
LED	448	87-A40-380-180	LED,SEL6510C-TP5 GRN	A.....
LED	445	87-A40-380-180	LED,SEL6510C-TP5 GRN	A.....
LED	440	87-A40-380-180	LED,SEL6510C-TP5 GRN	A.....
LED	446	87-A40-380-180	LED,SEL6510C-TP5 GRN	A.....
LED	442	87-A40-380-180	LED,SEL6510C-TP5 GRN	A.....
LED	451	87-A40-809-040	LED,LTL-307KK PGRN	A.....
LED	455	87-A40-809-040	LED,LTL-307KK PGRN	A.....
LED	452	87-A40-809-040	LED,LTL-307KK PGRN	A.....
LED	454	87-A40-809-040	LED,LTL-307KK PGRN	A.....
LED	453	87-A40-809-040	LED,LTL-307KK PGRN	A.....
LED	456	87-A40-809-040	LED,LTL-307KK PGRN	A.....
LED	465	87-A40-317-080	LED,SLR-342VCT31 RED	A.....
LED	461	87-A40-317-080	LED,SLR-342VCT31 RED	A.....
LED	463	87-A40-317-080	LED,SLR-342VCT31 RED	A.....
LED	464	87-A40-317-080	LED,SLR-342VCT31 RED	A.....
LED	462	87-A40-317-080	LED,SLR-342VCT31 RED	A.....
LED	521	87-A40-678-010	LED,SELU1E10CXM BLUE-DEF	A.....
LED	522	87-A40-678-010	LED,SELU1E10CXM BLUE-DEF	A.....
S	206	87-A90-095-080	SW,TACT EVQ11G04M	A.....
S	201	87-A90-095-080	SW,TACT EVQ11G04M	A.....
S	202	87-A90-095-080	SW,TACT EVQ11G04M	A.....
S	207	87-A90-095-080	SW,TACT EVQ11G04M	A.....
S	204	87-A90-095-080	SW,TACT EVQ11G04M	A.....
S	203	87-A90-095-080	SW,TACT EVQ11G04M	A.....
S	205	87-A90-095-080	SW,TACT EVQ11G04M	A.....
S	208	87-A90-095-080	SW,TACT EVQ11G04M	A.....
S	211	87-A90-095-080	SW,TACT EVQ11G04M	A.....
S	215	87-A90-095-080	SW,TACT EVQ11G04M	A.....
S	216	87-A90-095-080	SW,TACT EVQ11G04M	A.....
S	213	87-A90-095-080	SW,TACT EVQ11G04M	A.....
S	212	87-A90-095-080	SW,TACT EVQ11G04M	A.....
S	214	87-A90-095-080	SW,TACT EVQ11G04M	A.....
S	217	87-A90-095-080	SW,TACT EVQ11G04M	A.....
S	228	87-A90-095-080	SW,TACT EVQ11G04M	A.....
S	229	87-A90-095-080	SW,TACT EVQ11G04M	A.....
S	222	87-A90-095-080	SW,TACT EVQ11G04M	A.....
S	227	87-A90-095-080	SW,TACT EVQ11G04M	A.....
S	221	87-A90-095-080	SW,TACT EVQ11G04M	A.....
S	225	87-A90-095-080	SW,TACT EVQ11G04M	A.....
S	224	87-A90-095-080	SW,TACT EVQ11G04M	A.....
S	226	87-A90-095-080	SW,TACT EVQ11G04M	A.....
S	223	87-A90-095-080	SW,TACT EVQ11G04M	A.....
S	230	87-A90-095-080	SW,TACT EVQ11G04M	A.....

ELECTRICAL MAIN PARTS LIST -2/10

S	233	87-A90-095-080	SW, TACT	EVQ11G04M	A
S	232	87-A90-095-080	SW, TACT	EVQ11G04M	A
S	231	87-A90-095-080	SW, TACT	EVQ11G04M	A
S	234	87-A90-095-080	SW, TACT	EVQ11G04M	A
S	245	87-A90-095-080	SW, TACT	EVQ11G04M	A
S	246	87-A90-095-080	SW, TACT	EVQ11G04M	A
S	247	87-A90-095-080	SW, TACT	EVQ11G04M	A
S	243	87-A90-095-080	SW, TACT	EVQ11G04M	A
S	248	87-A90-095-080	SW, TACT	EVQ11G04M	A
S	241	87-A90-095-080	SW, TACT	EVQ11G04M	A
S	244	87-A90-095-080	SW, TACT	EVQ11G04M	A
S	242	87-A90-095-080	SW, TACT	EVQ11G04M	A
S	249	87-A90-095-080	SW, TACT	EVQ11G04M	A
S	252	87-A90-095-080	SW, TACT	EVQ11G04M	A
S	251	87-A90-095-080	SW, TACT	EVQ11G04M	A
S	250	87-A90-095-080	SW, TACT	EVQ11G04M	A
S	253	87-A90-095-080	SW, TACT	EVQ11G04M	A
S	514	87-A90-095-080	SW, TACT	EVQ11G04M	A
S	511	87-A90-095-080	SW, TACT	EVQ11G04M	A
S	513	87-A90-095-080	SW, TACT	EVQ11G04M	A
S	512	87-A90-095-080	SW, TACT	EVQ11G04M	A
S	515	87-A90-095-080	SW, TACT	EVQ11G04M	A
SW	101	87-A91-740-010	SW, RTRY	EC12E24308-30MM	A
SW	501	87-A91-739-010	SW, RTRY	EC12E12404-25MM RT	A
		87-067-703-010	TAPPING SCREW,	BVT2+3-10	A
C	1	87-010-387-080	CAP, E	470-25 SME	A
C	8	87-A11-148-080	CAP, TC U	0.1-50 Z F	A
C	9	87-A11-148-080	CAP, TC U	0.1-50 Z F	A
C	16	87-010-403-040	CAP, E	3.3-50 SME	A
C	13	87-010-917-000	CAP, E	3300-50 M SMG	A
C	12	87-010-917-000	CAP, E	3300-50 M SMG	A
C	18	87-A11-148-080	CAP, TC U	0.1-50 Z F	A
C	10	87-A11-148-080	CAP, TC U	0.1-50 Z F	A
C	11	87-A11-148-080	CAP, TC U	0.1-50 Z F	A
C	19	87-A11-148-080	CAP, TC U	0.1-50 Z F	A
C	22	87-A10-231-090	CAP, E	3300-80	A
C	23	87-A10-231-090	CAP, E	3300-80	A
C	28	87-A11-148-080	CAP, TC U	0.1-50 Z F	A
C	20	87-A11-148-080	CAP, TC U	0.1-50 Z F	A
C	27	87-A11-148-080	CAP, TC U	0.1-50 Z F	A
C	21	87-A11-148-080	CAP, TC U	0.1-50 Z F	A
C	29	87-A11-148-080	CAP, TC U	0.1-50 Z F	A
C	34	87-A11-148-080	CAP, TC U	0.1-50 Z F	A
C	36	87-A11-148-080	CAP, TC U	0.1-50 Z F	A
C	37	87-A11-148-080	CAP, TC U	0.1-50 Z F	A
C	32	87-A11-148-080	CAP, TC U	0.1-50 Z F	A
C	38	87-A11-148-080	CAP, TC U	0.1-50 Z F	A
C	30	87-A11-148-080	CAP, TC U	0.1-50 Z F	A
C	35	87-A11-148-080	CAP, TC U	0.1-50 Z F	A
C	33	87-A11-148-080	CAP, TC U	0.1-50 Z F	A
C	31	87-A11-148-080	CAP, TC U	0.1-50 Z F	A
CN	2	87-A61-108-010	CONN, 5P V	TID-A	A
CN	1	87-A61-110-010	CONN, 9P V	TID-A	A
D	2	87-017-447-010	DIODE, GBU4DL		A
D	3	87-017-654-060	DIODE, GBU6J		A
FC	4	87-033-213-080	CLAMP, FUSE		A
FC	2	87-033-213-080	CLAMP, FUSE		A
FC	3	87-033-213-080	CLAMP, FUSE		A
FC	1	87-033-213-080	CLAMP, FUSE		A
PR	3	87-A90-195-080	PROTECTOR	7A 125V 49	A
PT	2	8A-NF8-673-010	PT, SUB ANF-8	(H) KAMI	A
Q	1	87-026-245-080	TR, DTC114ES		A
Q	2	87-A30-198-080	TR, KTC3199GR		A
RY	2	87-A91-300-010	RELAY, AC	12V-ALA2PF12	A
S	1	87-A90-165-010	SW, SL	1-2-3 SWS2301	A
T	1	87-A60-317-010	TERMINAL, 1P	MSC	A
T	2	87-A60-317-010	TERMINAL, 1P	MSC	A
		87-067-703-010	TAPPING SCREW,	BVT2+3-10	A
*		8A-NF3-215-010	HLDR, TR		A
*		8A-NF3-217-110	HLDR, TR-SW		A
C	101	87-010-183-080	C-CAP, S	2700P-50 B	A
C	102	87-010-183-080	C-CAP, S	2700P-50 B	A
C	105	87-010-186-080	CAP, CHIP	4700P	A
C	106	87-010-186-080	CAP, CHIP	4700P	A
C	104	87-010-405-080	CAP, ELECT	10-50V	A
C	103	87-010-405-080	CAP, ELECT	10-50V	A
C	107	87-010-406-080	CAP, ELECT	22-50	A
C	108	87-010-406-080	CAP, ELECT	22-50	A
C	119	87-010-197-080	CAP, CHIP	0.01 DM	A
C	111	87-010-322-080	C-CAP, S	100P-50 CH	A
C	112	87-010-322-080	C-CAP, S	100P-50 CH	A
C	113	87-A10-812-080	C-CAP, S	220P-200 J CH	A
C	114	87-A10-812-080	C-CAP, S	220P-200 J CH	A
C	120	87-010-197-080	CAP, CHIP	0.01 DM	A
C	121	87-010-260-080	CAP, ELECT	47-25V	A
C	122	87-010-260-080	CAP, ELECT	47-25V	A
C	174	87-010-186-080	CAP, CHIP	4700P	A

ELECTRICAL MAIN PARTS LIST -3/10

C	173	87-010-186-080	CAP,CHIP 4700P	A
C	249	87-012-368-080	C-CAP,S 0.1-50 F	A
C	402	87-010-196-080	CHIP CAPACITOR,0.1-25	A
C	413	87-A10-119-080	CAP,E 10-100 REA	A
C	414	87-A10-119-080	CAP,E 10-100 REA	A
CNA	102	8A-NF8-655-010	CONN ASSY,7P TID-A(150)	A
CNA	103	8A-NF8-656-010	CONN ASSY,5P TID-A 400	A
CON	103	87-A60-058-010	CONN,10P V 9604S-10C	A
CON	101	87-A61-011-010	CONN,13P H BLK TAC-L13P-A3	A
CON	102	87-A61-011-010	CONN,13P H BLK TAC-L13P-A3	A
D	101	87-A40-269-080	C-DIODE,MC2836	A
D	103	87-A40-313-080	C-DIODE,MC 2840	A
D	113	87-020-331-080	CHIP-DIODE,DAN202K	A
D	117	87-A40-488-080	DIODE,1SS244	A
D	171	87-A40-270-080	C-DIODE,MC2838	A
D	419	87-A40-747-080	ZENER,UZ5.1BSB	A
D	418	87-A40-751-080	ZENER,UZ6.2BSB	A
D	417	87-A40-764-080	ZENER,UZ10BSC	A
D	421	87-A40-646-010	DIODE,FMB-G16L	A
D	422	87-A40-646-010	DIODE,FMB-G16L	A
D	428	87-A40-764-080	ZENER,UZ10BSC	A
Q	111	87-A30-107-070	C-TR,CMBT5401	A
Q	119	87-A30-190-080	TR,CC5551	A
Q	120	87-A30-190-080	TR,CC5551	A
Q	131	87-A30-204-010	TR,2SD2439	A
Q	132	87-A30-204-010	TR,2SD2439	A
Q	134	87-A30-205-010	TR,2SB1588	A
Q	133	87-A30-205-010	TR,2SB1588	A
Q	172	87-A30-106-040	C-TR,CMBT5551	A
Q	405	87-A30-186-010	FET,2SK3053	A
Q	406	87-A30-186-010	FET,2SK3053	A
Q	401	87-A30-484-080	C-TR,KRA102S	A
Q	403	87-A30-484-080	C-TR,KRA102S	A
Q	606	87-A30-186-010	FET,2SK3053	A
R	166	87-A00-418-010	RES,M/F 0.15-3W J	A
R	161	87-A00-418-010	RES,M/F 0.15-3W J	A
R	165	87-A00-418-010	RES,M/F 0.15-3W J	A
R	162	87-A00-418-010	RES,M/F 0.15-3W J	A
RY	201	87-A91-686-010	RELAY, G5PA-28 (OMRON)	A
TH	101	87-A91-042-080	C-THMS,100K 55001	A
TH	102	87-A91-042-080	C-THMS,100K 55001	A
WH	103	87-A90-459-010	HLDR,WIRE 2.5-5P	A
WH	102	87-A90-460-010	HLDR,WIRE 2.5-7P	A
*		8A-NF3-222-010	HLDR,TR-2F	A
C	101	87-010-178-080	CHIP CAP 1000P	A
C	102	87-010-178-080	CHIP CAP 1000P	A
C	104	87-010-405-080	CAP, ELECT 10-50V	A
C	103	87-010-405-080	CAP, ELECT 10-50V	A
C	107	87-010-405-080	CAP, ELECT 10-50V	A
C	108	87-010-405-080	CAP, ELECT 10-50V	A
C	112	87-010-176-080	C-CAP,S 680P-50 SL	A
C	111	87-010-176-080	C-CAP,S 680P-50 SL	A
C	119	87-010-196-080	CHIP CAPACITOR,0.1-25	A
C	118	87-010-196-080	CHIP CAPACITOR,0.1-25	A
C	114	87-010-260-080	CAP, ELECT 47-25V	A
C	113	87-010-260-080	CAP, ELECT 47-25V	A
C	116	87-010-405-080	CAP, ELECT 10-50V	A
C	115	87-010-405-080	CAP, ELECT 10-50V	A
C	121	87-010-190-080	S CHIP F 0.01	A
C	122	87-010-190-080	S CHIP F 0.01	A
C	157	87-010-190-080	S CHIP F 0.01	A
C	155	87-010-190-080	S CHIP F 0.01	A
C	156	87-010-190-080	S CHIP F 0.01	A
C	151	87-012-368-080	C-CAP,S 0.1-50 F	A
C	152	87-012-368-080	C-CAP,S 0.1-50 F	A
C	153	87-A11-595-080	C-CAP,S 0.056-50 K B	A
C	154	87-A11-595-080	C-CAP,S 0.056-50 K B	A
C	160	87-010-186-080	CAP,CHIP 4700P	A
C	161	87-010-186-080	CAP,CHIP 4700P	A
C	201	87-010-186-080	CAP,CHIP 4700P	A
C	208	87-010-197-080	CAP, CHIP 0.01 DM	A
C	202	87-010-258-080	CAP,E 22-35 SME	A
C	205	87-010-260-080	CAP, ELECT 47-25V	A
C	209	87-010-260-080	CAP, ELECT 47-25V	A
C	203	87-010-322-080	C-CAP,S 100P-50 CH	A
C	206	87-012-156-080	C-CAP,S 220P-50 CH	A
C	204	87-015-685-080	CAP,E 10-25 7L	A
C	210	87-010-260-080	CAP, ELECT 47-25V	A
C	258	87-010-178-080	CHIP CAP 1000P	A
C	251	87-012-368-080	C-CAP,S 0.1-50 F	A
C	253	87-A11-595-080	C-CAP,S 0.056-50 K B	A
C	252	87-A11-595-080	C-CAP,S 0.056-50 K B	A
CN	102	87-A60-135-010	CONN,10P V FE	A
CN	101	87-A61-109-010	CONN,7P V TID-A	A
D	101	87-A40-269-080	C-DIODE,MC2836	A
D	103	87-A40-313-080	C-DIODE,MC 2840	A
D	160	87-A40-270-080	C-DIODE,MC2838	A

ELECTRICAL MAIN PARTS LIST -4/10

D	209	87-A40-455-080	DIODE,RL203 GW	A
D	214	87-A40-313-080	C-DIODE,MC 2840	A
D	210	87-A40-455-080	DIODE,RL203 GW	A
D	212	87-A40-749-080	ZENER,UZ5.6BSB	A
D	211	87-A40-749-080	ZENER,UZ5.6BSB	A
IC	101	87-A21-397-010	IC,STK490-070	A
J	101	87-A61-159-010	JACK,PIN 4P R/W/B/O KM	A
L	151	87-A50-610-010	COIL,1UH K(MDEC)	A
L	152	87-A50-610-010	COIL,1UH K(MDEC)	A
L	251	87-A50-610-010	COIL,1UH K(MDEC)	A
Q	161	87-A30-106-080	C-TR,CMBT5551	A
Q	206	87-A30-190-080	TR,CC5551	A
Q	209	87-A30-256-010	TR,2SD1933	A
Q	210	87-A30-255-010	TR,2SB1342	A
Q	212	87-A30-255-010	TR,2SB1342	A
Q	211	87-A30-256-010	TR,2SD1933	A
Q	214	87-A30-484-080	C-TR,KRA102S	A
R	131	87-A00-258-080	RES,M/F 0.22-1W J	A
R	132	87-A00-258-080	RES,M/F 0.22-1W J	A
R	171	87-A00-258-080	RES,M/F 0.22-1W J	A
R	172	87-A00-258-080	RES,M/F 0.22-1W J	A
R	218	87-A00-257-080	RES,M/F 0.15-1W J	A
R	278	87-A00-257-080	RES,M/F 0.15-1W J	A
TH	201	87-A91-042-080	C-THMS,100K 55001	A
*		8Z-NF3-210-010	GUIDE,FL	A
C	103	87-010-196-080	CHIP CAPACITOR,0.1-25	A
C	104	87-010-313-080	CAP,CHIP 18P	A
C	105	87-010-322-080	C-CAP,S 100P-50 CH	A
C	109	87-010-401-040	CAP,E 1-50 SME	A
C	106	87-012-145-080	CAP,CHIP S 270P CH	A
C	107	87-012-157-080	C-CAP,S 330P-50 CH	A
C	108	87-015-681-040	E/CAP 10-16	A
C	118	87-010-194-080	CAP,CHIP 0.047	A
C	114	87-010-196-080	CHIP CAPACITOR,0.1-25	A
C	110	87-010-196-080	CHIP CAPACITOR,0.1-25	A
C	115	87-010-198-080	CAP,CHIP 0.022	A
C	116	87-010-493-040	CAP,E 0.47-50 GAS	A
C	117	87-010-498-040	CAP,E 10-16 GAS	A
C	112	87-016-460-080	C-CAP,S 0.22-16 B	A
C	113	87-A10-189-040	CAP,E 220-10	A
C	119	87-A10-797-040	CAP,E 47-35 M 5L SRM	A
C	128	87-010-178-080	CHIP CAP 1000P	A
C	129	87-010-194-080	CAP,CHIP 0.047	A
C	125	87-010-196-080	CHIP CAPACITOR,0.1-25	A
C	123	87-010-196-080	CHIP CAPACITOR,0.1-25	A
C	122	87-010-197-080	CAP,CHIP 0.01 DM	A
C	121	87-015-699-040	CAP,E 10-50 7L	A
C	120	87-015-699-040	CAP,E 10-50 7L	A
C	131	87-A10-189-040	CAP,E 220-10	A
C	132	87-A10-189-040	CAP,E 220-10	A
C	151	87-010-194-080	CAP,CHIP 0.047	A
C	197	87-010-194-080	CAP,CHIP 0.047	A
C	196	87-010-194-080	CAP,CHIP 0.047	A
C	192	87-015-785-080	CHIP CAPACITOR,0.1FZ-25Z	A
C	213	87-A10-189-040	CAP,E 220-10	A
C	305	87-010-196-080	CHIP CAPACITOR,0.1-25	A
C	306	87-010-196-080	CHIP CAPACITOR,0.1-25	A
C	301	87-010-318-080	C-CAP,S 47P-50 CH	A
C	304	87-016-460-080	C-CAP,S 0.22-16 B	A
C	303	87-016-460-080	C-CAP,S 0.22-16 B	A
C	310	87-010-067-040	CAP,E 0.1-50 5L	A
C	701	87-010-981-040	CAP,E 22-35 5L SRE	A
C	902	87-010-176-080	C-CAP,S 680P-50 SL	A
C	906	87-010-176-080	C-CAP,S 680P-50 SL	A
C	909	87-010-176-080	C-CAP,S 680P-50 SL	A
C	907	87-010-176-080	C-CAP,S 680P-50 SL	A
C	904	87-010-176-080	C-CAP,S 680P-50 SL	A
C	903	87-010-176-080	C-CAP,S 680P-50 SL	A
C	905	87-010-176-080	C-CAP,S 680P-50 SL	A
C	908	87-010-176-080	C-CAP,S 680P-50 SL	A
C	901	87-012-157-080	C-CAP,S 330P-50 CH	A
C	912	87-010-176-080	C-CAP,S 680P-50 SL	A
C	911	87-010-176-080	C-CAP,S 680P-50 SL	A
C	910	87-010-176-080	C-CAP,S 680P-50 SL	A
C	913	87-010-176-080	C-CAP,S 680P-50 SL	A
C	914	87-012-145-080	CAP,CHIP S 270P CH	A
CN	101	87-099-720-010	CONN,30P TYK-B(P)	A
CN	103	87-099-750-010	CONN,15P V 9604SC	A
CN	102	87-A60-054-010	CONN,14P V 9604S-14C	A
CN	301	87-A60-079-010	CONN,08P H 9604S-08F	A
CN	601	87-A60-062-010	CONN,05P V 9604S-05C	A
CN	701	87-099-750-010	CONN,15P V 9604SC	A
D	109	87-017-154-080	ZENER,HZS6C3L	A
D	103	87-020-465-080	DIODE,1SS133 (110MA)	A
D	310	87-A40-747-080	ZENER,UZ5.1BSB	A
D	701	87-A40-269-080	C-DIODE,MC2836	A
FL	101	8A-NF3-613-010	FL,BJ752GK-ANF3	A

ELECTRICAL MAIN PARTS LIST -5/10

IC	102	87-A21-482-010	IC,RPM6938-H4	A
IC	101	8A-NH3-635-010	C-IC,LC876580W-***	A
IC	380	87-A21-577-040	C-IC,M61506FP	A
JR	102	83-XM1-617-080	C-COIL,BK2125HM601	A
JW	316	87-A90-896-080	F-BEAD, 035600STY7	A
JW	315	87-A90-896-080	F-BEAD, 035600STY7	A
L	101	87-A50-333-010	COIL,OSC 9.43MHZ	A
LED	313	87-A40-380-180	LED,SEL6510C-TP5 GRN	A
LED	314	87-A40-380-180	LED,SEL6510C-TP5 GRN	A
LED	311	87-A40-380-180	LED,SEL6510C-TP5 GRN	A
LED	312	87-A40-380-180	LED,SEL6510C-TP5 GRN	A
LED	315	87-A40-380-180	LED,SEL6510C-TP5 GRN	A
Q	104	87-026-610-080	TR,KTC3198GR	A
Q	102	87-A30-076-080	C-TR,2SC3052F	A
Q	101	87-A30-087-080	C-FET,2SK2158	A
Q	108	87-A30-468-080	C-TR,KRC102S-RTK	A
Q	111	87-A30-074-080	C-TR,RT1P 141C	A
Q	112	87-A30-074-080	C-TR,RT1P 141C	A
Q	301	87-A30-276-040	C-TR,DTA143EKA	A
Q	703	87-A30-318-080	TR,CSA952K	A
Q	702	87-A30-318-080	TR,CSA952K	A
Q	701	87-A30-329-080	TR,CD1585BC	A
S	316	87-A90-095-080	SW,TACT EVQ11G04M	A
S	317	87-A90-095-080	SW,TACT EVQ11G04M	A
S	311	87-A90-095-080	SW,TACT EVQ11G04M	A
S	312	87-A90-095-080	SW,TACT EVQ11G04M	A
S	315	87-A90-095-080	SW,TACT EVQ11G04M	A
S	314	87-A90-095-080	SW,TACT EVQ11G04M	A
S	313	87-A90-095-080	SW,TACT EVQ11G04M	A
C	806	87-010-071-040	CAP,E 1-50 M 5L SRE	A
C	802	87-010-176-080	C-CAP,S 680P-50 SL	A
C	803	87-010-187-080	CAP CHIP S5600P	A
C	807	87-010-197-080	CAP, CHIP 0.01 DM	A
C	805	87-010-197-080	CAP, CHIP 0.01 DM	A
C	804	87-010-213-080	C-CAP,S 0.015-50 B	A
C	809	87-012-155-080	C-CAP 180P-50CH	A
C	801	87-012-156-080	C-CAP,S 220P-50 CH	A
C	811	87-010-244-040	CAP,E 22-16 5L	A
C	810	87-010-264-040	CAP,E 100-10 5L	A
C	812	87-016-044-040	CAP,E 100-16 GAS	A
C	821	87-010-196-080	CHIP CAPACITOR,0.1-25	A
C	833	87-010-322-080	C-CAP,S 100P-50 CH	A
D	801	87-A40-749-080	ZENER,UZ5.6BSB	A
IC	801	87-A21-051-040	C-IC,BU9990-03FS	A
L	802	87-003-098-080	COIL,2.2UH	A
L	801	87-A50-093-010	COIL,CLOCK 5.76MHZ	A
C	307	87-010-196-080	CHIP CAPACITOR,0.1-25	A
C	301	87-010-318-080	C-CAP,S 47P-50 CH	A
C	302	87-010-318-080	C-CAP,S 47P-50 CH	A
C	305	87-012-157-080	C-CAP,S 330P-50 CH	A
C	304	87-012-157-080	C-CAP,S 330P-50 CH	A
C	306	87-012-157-080	C-CAP,S 330P-50 CH	A
C	303	87-012-157-080	C-CAP,S 330P-50 CH	A
C	316	87-010-178-080	CHIP CAP 1000P	A
C	315	87-010-178-080	CHIP CAP 1000P	A
C	313	87-010-180-080	C-CER 1500P	A
C	314	87-010-180-080	C-CER 1500P	A
C	311	87-010-198-080	CAP, CHIP 0.022	A
C	312	87-010-198-080	CAP, CHIP 0.022	A
C	319	87-012-141-080	CHIP-CAPACITOR,0.22-16F	A
C	317	87-A10-201-080	C-CAP,S0.33-16 KB	A
C	318	87-A10-201-080	C-CAP,S0.33-16 KB	A
C	324	87-010-260-080	CAP, ELECT 47-25V	A
C	325	87-010-370-080	CAP,E 330-6.3 SME	A
C	327	87-010-404-080	CAP, ELECT 4.7-50V	A
C	328	87-010-404-080	CAP, ELECT 4.7-50V	A
C	320	87-012-141-080	CHIP-CAPACITOR,0.22-16F	A
C	322	87-012-141-080	CHIP-CAPACITOR,0.22-16F	A
C	321	87-012-141-080	CHIP-CAPACITOR,0.22-16F	A
C	339	87-010-196-080	CHIP CAPACITOR,0.1-25	A
C	337	87-010-196-080	CHIP CAPACITOR,0.1-25	A
C	332	87-010-196-080	CHIP CAPACITOR,0.1-25	A
C	336	87-010-401-080	CAP, ELECT 1-50V	A
C	335	87-010-401-080	CAP, ELECT 1-50V	A
C	340	87-010-196-080	CHIP CAPACITOR,0.1-25	A
C	354	87-010-175-080	CAP 560P	A
C	358	87-010-183-080	C-CAP,S 2700P-50 B	A
C	359	87-010-183-080	C-CAP,S 2700P-50 B	A
C	357	87-010-197-080	CAP, CHIP 0.01 DM	A
C	356	87-010-260-080	CAP, ELECT 47-25V	A
C	351	87-012-140-080	CAP 470P	A
C	352	87-012-140-080	CAP 470P	A
C	355	87-012-349-080	C-CAP,S 1000P-50 CH	A
C	360	87-010-183-080	C-CAP,S 2700P-50 B	A
C	372	87-010-175-080	CAP 560P	A
C	371	87-010-175-080	CAP 560P	A
C	374	87-010-179-080	CAP,CHIP S B1200P	A

ELECTRICAL MAIN PARTS LIST -6/10

C	373	87-010-179-080	CAP,CHIP S B1200P	A
C	378	87-010-196-080	CHIP CAPACITOR,0.1-25	A
C	370	87-010-196-080	CHIP CAPACITOR,0.1-25	A
C	375	87-010-545-080	CAP, ELECT 0.22-50V	A
C	376	87-010-545-080	CAP, ELECT 0.22-50V	A
C	385	87-010-184-080	CHIP CAPACITOR 3300P(K)	A
C	386	87-010-196-080	CHIP CAPACITOR,0.1-25	A
C	383	87-010-197-080	CAP, CHIP 0.01 DM	A
C	381	87-010-197-080	CAP, CHIP 0.01 DM	A
C	382	87-010-318-080	C-CAP,S 47P-50 CH	A
C	384	87-010-402-080	CAP, ELECT 2.2-50V	A
C	388	87-012-156-080	C-CAP,S 220P-50 CH	A
CN	301	87-A60-620-010	CONN,3P V 2MM JMT	A
CN	351	87-A60-625-010	CONN,8P V 2MM JMT	A
IC	302	87-A20-355-010	IC,CXA1553P	A
IC	303	87-A20-783-040	C-IC,BA7762AFS	A
L	301	87-A50-625-010	COIL,TRAP 85KHZ (SANWA)	A
L	302	87-A50-625-010	COIL,TRAP 85KHZ (SANWA)	A
L	351	87-007-342-010	COIL,OSC 85K BIAS	A
Q	357	87-026-609-080	TR,KTA1266GR	A
Q	358	87-026-610-080	TR,KTC3198GR	A
Q	359	87-026-610-080	TR,KTC3198GR	A
Q	355	87-A30-063-080	C-TR,KRA104S	A
SFR	302	87-024-355-080	SFR,33K DIA6 H	A
SFR	301	87-024-355-080	SFR,33K DIA6 H	A
SFR	303	87-024-355-080	SFR,33K DIA6 H	A
SFR	304	87-024-355-080	SFR,33K DIA6 H	A
SFR	306	87-024-356-080	SFR,47K DIA6 H	A
SFR	305	87-024-356-080	SFR,47K DIA6 H	A
SFR	352	87-024-356-080	SFR,47K DIA6 H	A
SFR	351	87-024-356-080	SFR,47K DIA6 H	A
C	557	87-010-183-080	C-CAP,S 2700P-50 B	A
C	559	87-010-196-080	CHIP CAPACITOR,0.1-25	A
C	555	87-012-145-080	CAP, CHIP S 270P CH	A
C	556	87-012-145-080	CAP, CHIP S 270P CH	A
C	554	87-012-154-080	C-CAP,S 150P-50 CH	A
C	553	87-012-154-080	C-CAP,S 150P-50 CH	A
C	551	87-A10-060-080	C-CAP,S 0.18-16 K B	A
C	552	87-A10-060-080	C-CAP,S 0.18-16 K B	A
C	560	87-010-177-080	C-CAP,S 820P-50 SL	A
C	561	87-010-177-080	C-CAP,S 820P-50 SL	A
C	567	87-010-183-080	C-CAP,S 2700P-50 B	A
C	562	87-010-196-080	CHIP CAPACITOR,0.1-25	A
C	564	87-010-196-080	CHIP CAPACITOR,0.1-25	A
C	565	87-010-263-080	CAP, ELECT 100-10V	A
C	563	87-010-374-080	CAP, ELECT 47-10V	A
C	577	87-010-196-080	CHIP CAPACITOR,0.1-25	A
C	571	87-016-460-080	C-CAP,S 0.22-16 B	A
C	573	87-016-460-080	C-CAP,S 0.22-16 B	A
C	572	87-016-460-080	C-CAP,S 0.22-16 B	A
CN	551	87-A60-689-010	CONN,7P H GRY TUC-P07X-C1	A
D	551	87-A40-747-080	ZENER,UZ5.1BSB	A
IC	551	87-A20-561-040	C-IC,M65847AFP	A
C	116	87-010-401-080	CAP, ELECT 1-50V	A
C	115	87-010-401-080	CAP, ELECT 1-50V	A
C	152	87-010-260-080	CAP, ELECT 47-25V	A
C	163	87-010-196-080	CHIP CAPACITOR,0.1-25	A
C	160	87-012-140-080	CAP 470P	A
C	178	87-010-197-080	CAP, CHIP 0.01 DM	A
C	177	87-010-197-080	CAP, CHIP 0.01 DM	A
C	174	87-012-368-080	C-CAP,S 0.1-50 F	A
C	172	87-012-368-080	C-CAP,S 0.1-50 F	A
C	171	87-012-368-080	C-CAP,S 0.1-50 F	A
C	173	87-012-368-080	C-CAP,S 0.1-50 F	A
C	175	87-A11-572-080	C-CAP,S 0.015-50 K B	A
C	176	87-A11-572-080	C-CAP,S 0.015-50 K B	A
CN	101	87-A60-996-010	CONN,13P V BLK TAC-L13X-A3	A
J	102	87-A60-238-010	TERMINAL,SP 4P (MSC)	A
J	103	87-A60-483-010	JACK,DIA6.3 BLK ST W/S KM	A
L	101	87-A50-610-010	COIL,1UH K(MDEC)	A
L	102	87-A50-610-010	COIL,1UH K(MDEC)	A
Q	111	87-A30-086-040	C-TR,CSD1306E	A
Q	114	87-A30-105-080	C-TR,RT1P 441C	A
R	161	87-A00-443-050	RES,390-1/2W J RP	A
R	162	87-A00-443-050	RES,390-1/2W J RP	A
R	163	87-A00-443-050	RES,390-1/2W J RP	A
R	164	87-A00-443-050	RES,390-1/2W J RP	A
C	973	87-010-197-080	CAP, CHIP 0.01 DM	A
C	974	87-010-197-080	CAP, CHIP 0.01 DM	A
C	979	87-010-322-080	C-CAP,S 100P-50 CH	A
C	971	87-010-381-080	CAP, ELECT 330-16V	A
C	972	87-010-404-080	CAP, ELECT 4.7-50V	A
C	982	87-010-196-080	CHIP CAPACITOR,0.1-25	A
C	987	87-010-197-080	CAP, CHIP 0.01 DM	A
C	989	87-010-197-080	CAP, CHIP 0.01 DM	A
C	984	87-010-197-080	CAP, CHIP 0.01 DM	A
C	983	87-010-197-080	CAP, CHIP 0.01 DM	A

ELECTRICAL MAIN PARTS LIST - 7/10

C	981	87-010-260-080	CAP, ELECT 47-25V	A
C	995	87-010-178-080	CHIP CAP 1000P	A
C	993	87-010-178-080	CHIP CAP 1000P	A
C	997	87-010-196-080	CHIP CAPACITOR, 0.1-25	A
C	998	87-010-260-080	CAP, ELECT 47-25V	A
C	991	87-010-312-080	C-CAP, S 15P-50 CH	A
C	992	87-010-312-080	C-CAP, S 15P-50 CH	A
C	999	87-A11-155-080	CAP, TC U 0.01-16 Z F	A
D	991	87-017-149-080	ZENER, HZS6A2L	A
IC	991	87-070-127-110	IC, LC72131 D	A
Q	981	87-A30-234-080	TR, CSC4115BC	A
R	991	87-010-322-080	C-CAP, S 100P-50 CH	A
R	993	87-010-322-080	C-CAP, S 100P-50 CH	A
R	995	87-010-322-080	C-CAP, S 100P-50 CH	A
X	991	87-A70-061-010	VIB, XTAL 4.500MHZ CSA-309	A
C	773	87-010-184-080	CHIP CAPACITOR 3300P(K)	A
C	774	87-010-184-080	CHIP CAPACITOR 3300P(K)	A
C	772	87-010-197-080	CAP, CHIP 0.01 DM	A
C	771	87-010-263-080	CAP, ELECT 100-10V	A
C	788	87-010-149-080	C-CAP, S 5P-50 CH	A
C	782	87-010-197-080	CAP, CHIP 0.01 DM	A
C	783	87-010-197-080	CAP, CHIP 0.01 DM	A
C	784	87-010-197-080	CAP, CHIP 0.01 DM	A
C	786	87-010-197-080	CAP, CHIP 0.01 DM	A
C	785	87-010-197-080	CAP, CHIP 0.01 DM	A
C	789	87-A10-592-080	C-CAP, S 0.015-50 J B	A
C	791	87-010-196-080	CHIP CAPACITOR, 0.1-25	A
C	795	87-010-197-080	CAP, CHIP 0.01 DM	A
C	796	87-010-197-080	CAP, CHIP 0.01 DM	A
C	792	87-010-197-080	CAP, CHIP 0.01 DM	A
C	798	87-010-197-080	CAP, CHIP 0.01 DM	A
C	793	87-010-404-080	CAP, ELECT 4.7-50V	A
C	797	87-010-405-080	CAP, ELECT 10-50V	A
C	799	87-010-407-080	CAP, ELECT 33-50V	A
C	790	87-A10-592-080	C-CAP, S 0.015-50 J B	A
C	803	87-010-198-080	CAP, CHIP 0.022	A
C	804	87-010-263-080	CAP, ELECT 100-10V	A
C	807	87-010-400-080	CAP, ELECT 0.47-50V	A
C	808	87-010-401-080	CAP, ELECT 1-50V	A
C	809	87-010-401-080	CAP, ELECT 1-50V	A
C	801	87-010-403-080	CAP, ELECT 3.3-50V	A
C	802	87-012-369-080	C-CAP, S 0.047-50F	A
C	800	87-012-369-080	C-CAP, S 0.047-50F	A
C	819	87-010-179-080	CAP, CHIP S B1200P	A
C	810	87-010-196-080	CHIP CAPACITOR, 0.1-25	A
C	814	87-010-197-080	CAP, CHIP 0.01 DM	A
C	816	87-010-400-080	CAP, ELECT 0.47-50V	A
C	815	87-010-400-080	CAP, ELECT 0.47-50V	A
C	812	87-010-403-080	CAP, ELECT 3.3-50V	A
C	811	87-010-403-080	CAP, ELECT 3.3-50V	A
C	823	87-010-177-080	C-CAP, S 820P-50 SL	A
C	820	87-010-179-080	CAP, CHIP S B1200P	A
C	821	87-010-405-080	CAP, ELECT 10-50V	A
C	824	87-010-405-080	CAP, ELECT 10-50V	A
C	825	87-010-596-080	CAP, S 0.047-16	A
IC	801	87-A21-560-010	IC, LA1844L-A	A
L	801	87-A50-608-010	COIL, FM DET-N(TOK)	A
L	802	87-A91-552-010	FLTR, CFMT-450AL (TOK)	A
L	811	87-005-847-080	COIL, 2.2UH(CECS)	A
L	822	87-A50-027-010	COIL, 1 POLE MPX(TOK)	A
L	821	87-A50-027-010	COIL, 1 POLE MPX(TOK)	A
R	790	87-010-197-080	CAP, CHIP 0.01 DM	A
C	844	87-010-197-080	CAP, CHIP 0.01 DM	A
C	842	87-010-197-080	CAP, CHIP 0.01 DM	A
C	858	87-010-196-080	CHIP CAPACITOR, 0.1-25	A
C	859	87-010-196-080	CHIP CAPACITOR, 0.1-25	A
C	851	87-010-197-080	CAP, CHIP 0.01 DM	A
C	853	87-010-197-080	CAP, CHIP 0.01 DM	A
C	852	87-010-197-080	CAP, CHIP 0.01 DM	A
C	850	87-010-260-080	CAP, ELECT 47-25V	A
C	860	87-010-197-080	CAP, CHIP 0.01 DM	A
C	948	87-010-148-080	CAP, CHIP S 75P SL	A
C	947	87-010-197-080	CAP, CHIP 0.01 DM	A
C	940	87-010-197-080	CAP, CHIP 0.01 DM	A
C	943	87-010-197-080	CAP, CHIP 0.01 DM	A
C	945	87-010-197-080	CAP, CHIP 0.01 DM	A
C	941	87-010-314-080	C-CAP, S 22P-50V	A
C	946	87-010-971-080	C-CAP, S 4700P-50 B J	A
C	959	87-010-196-080	CHIP CAPACITOR, 0.1-25	A
C	952	87-010-197-080	CAP, CHIP 0.01 DM	A
C	953	87-010-197-080	CAP, CHIP 0.01 DM	A
C	956	87-010-263-080	CAP, ELECT 100-10V	A
C	954	87-010-400-080	CAP, ELECT 0.47-50V	A
C	962	87-010-401-080	CAP, ELECT 1-50V	A
C	964	87-010-854-080	C-CAP, S 560PCH	A
C	963	87-015-785-080	CHIP CAPACITOR, 0.1FZ-25Z	A
CF	831	87-008-261-010	FILTER, SFE10.7MA5-A	A

ELECTRICAL MAIN PARTS LIST - 8/10

CF	832	87-008-261-010	FILTER, SFE10.7MA5-A	A
D	951	87-A40-618-080	VARI-CAP, SVC 348 (S/T)	A
FFE	831	A8-8ZA-190-030	8ZA-1 FEUNM	A
J	831	87-A60-202-010	TERMINAL, ANT 4P MSP-154V-02	A
J	940	87-A60-633-010	CONN, 2P H 2.5MM JMT	A
L	832	87-005-847-080	COIL, 2.2UH (CECS)	A
L	941	87-A50-022-010	COIL, ANT SW (COI)	A
L	944	87-A50-159-010	COIL, 10MH K C2B	A
L	943	87-A50-522-080	COIL, 1MH K CEC	A
L	942	87-A50-550-010	COIL, OSC SW-2N (COI)	A
L	952	87-A50-430-010	COIL, ANT MW (3BSW)	A
L	953	87-A50-431-010	COIL, OSC MW (3BSW)	A
Q	837	87-A30-489-080	C-TR, KRA107S	A
Q	836	87-A30-489-080	C-TR, KRA107S	A
Q	835	89-327-143-080	TR, 2SC2714 (0.1W)	A
Q	941	87-A30-484-080	C-TR, KRA102S	A
Q	951	87-A30-484-080	C-TR, KRA102S	A
Q	953	89-503-602-080	C-FET, 2SK360E	A
TC	943	87-011-253-080	TRIMER, 30P LAR	A
TC	941	87-011-254-080	TRIMER, 20P LAR	A
		87-067-703-010	TAPPING SCREW, BVT2+3-10	A
C	4	87-012-368-080	C-CAP, S 0.1-50 F	A
C	3	87-012-368-080	C-CAP, S 0.1-50 F	A
C	25	87-010-990-080	CAP, E 33-100 SME	A
C	27	87-010-990-080	CAP, E 33-100 SME	A
C	22	87-016-035-090	CAP, E 6800-35 VR	A
C	21	87-016-035-090	CAP, E 6800-35 VR	A
C	26	87-016-300-080	CAP, E 22-100 SME	A
C	28	87-016-300-080	CAP, E 22-100 SME	A
C	32	87-010-197-080	CAP, CHIP 0.01 DM	A
C	34	87-010-247-080	CAP, ELECT 100-50V	A
C	33	87-010-263-080	CAP, ELECT 100-10V	A
C	31	87-010-263-080	CAP, ELECT 100-10V	A
C	36	87-010-381-080	CAP, ELECT 330-16V	A
C	39	87-010-393-080	CAP, ELECT 100-35V	A
C	38	87-010-393-080	CAP, ELECT 100-35V	A
C	35	87-010-406-080	CAP, ELECT 22-50	A
C	40	87-010-190-080	S CHIP F 0.01	A
C	60	87-010-403-080	CAP, ELECT 3.3-50V	A
C	82	87-010-260-080	CAP, ELECT 47-25V	A
C	81	87-010-374-080	CAP, ELECT 47-10V	A
C	80	87-010-401-080	CAP, ELECT 1-50V	A
CN	1	87-A60-996-010	CONN, 13P V BLK TAC-L13X-A3	A
CN	91	87-A60-619-010	CONN, 2P V 2MM JMT	A
CN	92	87-A60-619-010	CONN, 2P V 2MM JMT	A
CNA	3	87-049-919-010	CONN, 3P EH V WHT	A
CNA	2	8A-NF3-640-110	CONN ASSY, 3P (VM) ANF-3	A
CNA	1	8A-NF8-653-010	CONN ASSY, 9P TID-A (480)	A
D	1	87-A40-673-090	DIODE, D10XB20	A
D	25	87-A40-553-080	DIODE, 1N4003 LES	A
D	29	87-A40-781-080	ZENER, UZ36BSA	A
D	33	87-070-274-080	DIODE, 1N4003 SEM	A
D	31	87-A40-764-080	ZENER, UZ10BSC	A
D	64	87-A40-269-080	C-DIODE, MC2836	A
D	63	87-A40-270-080	C-DIODE, MC2838	A
D	65	87-A40-768-080	ZENER, UZ16BSA	A
Q	5	87-026-610-080	TR, KTC3198GR	A
Q	2	87-A30-217-010	TR, 2SB1436 (R)	A
Q	1	87-A30-217-010	TR, 2SB1436 (R)	A
Q	9	87-A30-318-080	TR, CSA952K	A
Q	14	89-213-702-010	TR, 2SB1370 (1.8W)	A
Q	13	89-213-702-010	TR, 2SB1370 (1.8W)	A
Q	82	87-026-610-080	TR, KTC3198GR	A
Q	84	87-A30-218-080	TR, 2SB1237 (Q)	A
R	25	87-A00-261-080	RES, M/F 0.56-1W J	A
WH	1	87-A90-510-010	HLDR, WIRE 2.5-9P	A
C	401	87-010-176-080	C-CAP, S 680P-50 SL	A
C	402	87-010-176-080	C-CAP, S 680P-50 SL	A
C	409	87-010-196-080	CHIP CAPACITOR, 0.1-25	A
C	407	87-010-401-080	CAP, ELECT 1-50V	A
C	408	87-010-401-080	CAP, ELECT 1-50V	A
C	403	87-010-958-080	CHIP -CAP, S 0.01-25BJ	A
C	405	87-010-958-080	CHIP -CAP, S 0.01-25BJ	A
C	406	87-010-958-080	CHIP -CAP, S 0.01-25BJ	A
C	404	87-010-958-080	CHIP -CAP, S 0.01-25BJ	A
C	417	87-010-221-080	CAP, ELECT 470-10V	A
C	410	87-010-384-080	CAP, ELECT 100-25V	A
C	413	87-010-401-080	CAP, ELECT 1-50V	A
C	411	87-010-401-080	CAP, ELECT 1-50V	A
C	412	87-010-401-080	CAP, ELECT 1-50V	A
C	416	87-010-492-080	CAP, E 0.33-50 M 5L SRE	A
C	415	87-010-492-080	CAP, E 0.33-50 M 5L SRE	A
C	414	87-010-494-080	CAP ELECT GAS 1/50	A
C	419	87-A10-800-080	C-CAP, S 6800P-16 J B CM	A
C	418	87-A10-891-080	CAP, E 4.7-25 SME (K)	A
C	425	87-010-196-080	CHIP CAPACITOR, 0.1-25	A
C	421	87-010-196-080	CHIP CAPACITOR, 0.1-25	A

ELECTRICAL MAIN PARTS LIST - 9/10

C	420	87-010-374-080	CAP, ELECT 47-10V	A
C	424	87-010-374-080	CAP, ELECT 47-10V	A
C	429	87-010-545-080	CAP, ELECT 0.22-50V	A
C	428	87-012-156-080	C-CAP, S 220P-50 CH	A
C	422	87-A10-804-080	C-CAP, S 0.1-25 J B	A
C	439	87-010-805-080	CAP, S 1-16	A
C	437	87-010-971-080	C-CAP, S 4700P-50 B J	A
C	431	87-010-971-080	C-CAP, S 4700P-50 B J	A
C	432	87-012-349-080	C-CAP, S 1000P-50 CH	A
C	438	87-012-349-080	C-CAP, S 1000P-50 CH	A
C	430	87-A10-201-080	C-CAP, S 0.33-16 KB	A
C	435	87-A11-182-080	C-CAP, S 0.27-16 J B	A
C	434	87-A11-182-080	C-CAP, S 0.27-16 J B	A
C	433	87-A11-183-080	C-CAP, S 0.12-16 J B	A
C	436	87-A11-183-080	C-CAP, S 0.12-16 J B	A
C	440	87-010-401-080	CAP, ELECT 1-50V	A
C	446	87-010-404-080	CAP, ELECT 4.7-50V	A
C	447	87-010-404-080	CAP, ELECT 4.7-50V	A
C	449	87-016-460-080	C-CAP, S 0.22-16 B	A
C	448	87-016-460-080	C-CAP, S 0.22-16 B	A
C	445	87-016-460-080	C-CAP, S 0.22-16 B	A
C	444	87-016-460-080	C-CAP, S 0.22-16 B	A
C	443	87-A10-229-080	C-CAP, S 0.68-10 K W5	A
C	441	87-A10-799-080	C-CAP, S 5600P-16 J B CM	A
C	442	87-A10-802-080	C-CAP, S 0.047-16 J B CM	A
C	457	87-016-081-080	C-CAP, S 0.1-16 RK	A
C	454	87-016-081-080	C-CAP, S 0.1-16 RK	A
C	450	87-016-081-080	C-CAP, S 0.1-16 RK	A
C	453	87-016-081-080	C-CAP, S 0.1-16 RK	A
C	455	87-A10-801-080	C-CAP, S 0.022-16 J B CM	A
C	456	87-A10-801-080	C-CAP, S 0.022-16 J B CM	A
C	451	87-A10-802-080	C-CAP, S 0.047-16 J B CM	A
C	452	87-A10-802-080	C-CAP, S 0.047-16 J B CM	A
C	461	87-010-196-080	CHIP CAPACITOR, 0.1-25	A
C	463	87-010-196-080	CHIP CAPACITOR, 0.1-25	A
C	465	87-012-141-080	CHIP-CAPACITOR, 0.22-16F	A
C	468	87-A10-060-080	C-CAP, S 0.18-16 K B	A
C	467	87-A10-201-080	C-CAP, S 0.33-16 KB	A
C	479	87-010-179-080	CAP, CHIP S B1200P	A
C	478	87-010-265-080	CAP, ELECT 33-16V	A
C	477	87-012-140-080	CAP 470P	A
C	473	87-012-140-080	CAP 470P	A
C	475	87-012-140-080	CAP 470P	A
C	474	87-012-140-080	CAP 470P	A
C	476	87-012-140-080	CAP 470P	A
C	472	87-012-140-080	CAP 470P	A
C	482	87-010-179-080	CAP, CHIP S B1200P	A
C	481	87-010-179-080	CAP, CHIP S B1200P	A
C	480	87-010-179-080	CAP, CHIP S B1200P	A
C	483	87-010-265-080	CAP, ELECT 33-16V	A
C	489	87-010-402-080	CAP, ELECT 2.2-50V	A
C	491	87-010-402-080	CAP, ELECT 2.2-50V	A
C	492	87-010-402-080	CAP, ELECT 2.2-50V	A
CNA	402	8Z-NFS-610-010	CONN ASSY, 2P V DA (170MM)	A
D	402	87-A40-747-080	ZENER, UZ5.1BSB	A
D	401	87-A40-760-080	ZENER, UZ9.1BSA	A
IC	401	87-A21-097-040	C-IC, M62463AFP	A
IC	431	87-A21-015-040	C-IC, M62491FP	A
J	431	87-A61-069-010	JACK, PIN 6P R/W, R/W, O/B MSC	A
R	407	87-022-214-080	C-RES S100K-1/10WF	A
R	445	87-010-198-080	CAP, CHIP 0.022	A
C	604	87-010-318-080	C-CAP, S 47P-50 CH	A
C	603	87-010-318-080	C-CAP, S 47P-50 CH	A
C	605	87-010-318-080	C-CAP, S 47P-50 CH	A
C	606	87-010-318-080	C-CAP, S 47P-50 CH	A
C	616	87-010-180-080	C-CER 1500P	A
C	613	87-010-197-080	CAP, CHIP 0.01 DM	A
C	617	87-010-198-080	CAP, CHIP 0.022	A
C	619	87-010-263-080	CAP, ELECT 100-10V	A
C	612	87-010-369-080	C-CAP, S 0.033-25 K B	A
C	618	87-010-401-080	CAP, ELECT 1-50V	A
C	611	87-010-956-080	CHIP-CAP, S 0.068-25B	A
C	614	87-016-669-080	C-CAP, S 0.1-25 K B	A
C	621	87-010-197-080	CAP, CHIP 0.01 DM	A
C	627	87-010-400-080	CAP, ELECT 0.47-50V	A
C	628	87-010-400-080	CAP, ELECT 0.47-50V	A
C	624	87-010-401-080	CAP, ELECT 1-50V	A
C	623	87-010-401-080	CAP, ELECT 1-50V	A
C	626	87-010-992-080	C-CAP, S 0.047-25 B	A
C	629	87-010-992-080	C-CAP, S 0.047-25 B	A
C	620	87-016-669-080	C-CAP, S 0.1-25 K B	A
C	631	87-010-185-080	C-CAP, S 3900P-50 B	A
C	632	87-010-185-080	C-CAP, S 3900P-50 B	A
C	634	87-010-196-080	CHIP CAPACITOR, 0.1-25	A
C	630	87-010-383-080	CAP, ELECT 33-25V	A
C	639	87-010-405-080	CAP, ELECT 10-50V	A
C	638	87-A10-307-080	CAP, M 0.1-50 J	A

ELECTRICAL MAIN PARTS LIST - 10/10

C	636	87-A10-307-080	CAP,M 0.1-50 J	A.....
C	635	87-A10-307-080	CAP,M 0.1-50 J	A.....
C	637	87-A10-307-080	CAP,M 0.1-50 J	A.....
C	643	87-010-196-080	CHIP CAPACITOR,0.1-25	A.....
C	644	87-010-401-080	CAP, ELECT 1-50V	A.....
C	642	87-010-401-080	CAP, ELECT 1-50V	A.....
C	641	87-010-401-080	CAP, ELECT 1-50V	A.....
C	675	87-010-196-080	CHIP CAPACITOR,0.1-25	A.....
C	679	87-010-196-080	CHIP CAPACITOR,0.1-25	A.....
C	673	87-010-197-080	CAP, CHIP 0.01 DM	A.....
C	671	87-010-322-080	C-CAP,S 100P-50 CH	A.....
C	672	87-010-322-080	C-CAP,S 100P-50 CH	A.....
C	682	87-010-196-080	CHIP CAPACITOR,0.1-25	A.....
C	680	87-010-197-080	CAP, CHIP 0.01 DM	A.....
CN	605	87-099-568-010	CONN,11P TUC-P11P-B1	A.....
CN	601	87-099-719-010	CONN,30P TYK-B(X)	A.....
CN	602	87-A60-131-010	CONN,6P V FE	A.....
D	602	87-A40-438-080	ZENER,MTZJ4.7A	A.....
IC	601	87-A21-452-030	C-IC,BD3876KS2	A.....
J	601	87-A60-885-010	JACK,PIN 6P R/W MSC	A.....
Q	601	87-026-610-080	TR,KTC3198GR	A.....
C	535	87-010-178-080	CHIP CAP 1000P	A.....
C	536	87-010-196-080	CHIP CAPACITOR,0.1-25	A.....
C	532	87-010-196-080	CHIP CAPACITOR,0.1-25	A.....
C	533	87-010-196-080	CHIP CAPACITOR,0.1-25	A.....
C	531	87-010-560-080	CAP,E 10-50 GAS	A.....
C	534	87-012-156-080	C-CAP,S 220P-50 CH	A.....
C	541	87-010-178-080	CHIP CAP 1000P	A.....
C	201	87-010-402-080	CAP, ELECT 2.2-50V	A.....
C	202	87-010-402-080	CAP, ELECT 2.2-50V	A.....
C	205	87-010-404-080	CAP, ELECT 4.7-50V	A.....
C	209	87-016-460-080	C-CAP,S 0.22-16 B	A.....
C	207	87-016-669-080	C-CAP,S 0.1-25 K B	A.....
C	208	87-016-669-080	C-CAP,S 0.1-25 K B	A.....
C	219	87-010-183-080	C-CAP,S 2700P-50 B	A.....
C	215	87-010-197-080	CAP, CHIP 0.01 DM	A.....
C	216	87-010-197-080	CAP, CHIP 0.01 DM	A.....
C	218	87-010-198-080	CAP, CHIP 0.022	A.....
C	217	87-010-198-080	CAP, CHIP 0.022	A.....
C	214	87-010-956-080	CHIP-CAP,S 0.068-25B	A.....
C	213	87-010-956-080	CHIP-CAP,S 0.068-25B	A.....
C	211	87-012-365-080	C-CAP,S 0.027-25VBK	A.....
C	212	87-012-365-080	C-CAP,S 0.027-25VBK	A.....
C	210	87-016-460-080	C-CAP,S 0.22-16 B	A.....
C	227	87-010-112-080	CAP, ELECT 100-16V	A.....
C	223	87-010-178-080	CHIP CAP 1000P	A.....
C	224	87-010-178-080	CHIP CAP 1000P	A.....
C	226	87-010-182-080	C-CAP,S 2200P-50 B	A.....
C	225	87-010-182-080	C-CAP,S 2200P-50 B	A.....
C	220	87-010-183-080	C-CAP,S 2700P-50 B	A.....
C	221	87-010-188-080	CAP,CHIP 6800P	A.....
C	222	87-010-188-080	CAP,CHIP 6800P	A.....
C	228	87-010-196-080	CHIP CAPACITOR,0.1-25	A.....
C	229	87-010-322-080	C-CAP,S 100P-50 CH	A.....
C	230	87-010-322-080	C-CAP,S 100P-50 CH	A.....
C	231	87-010-322-080	C-CAP,S 100P-50 CH	A.....
CN	201	87-A60-546-010	CONN,11P H GRY TUC-P11X-C1	A.....
IC	201	87-A20-869-040	C-IC,M62449FP	A.....

MECHANICAL PARTS LIST - 1/1

NOTE: The characters in the suffix column indicate the part usage.

REF.NO	PARTS NO.	NO.	DESCRIPTION	SUFFIX
HRJSM	XX.....	KANRI	A.....
	87-CE3-023-010		BADGE,AIWA 30N SILV	A.....
	8A-NF7-003-010		BOX,CASS 1	A.....
	8A-NF7-004-010		BOX,CASS 2	A.....
	8A-NF7-008-010		PANEL,CD	A.....
	8A-NF7-010-010		WINDOW,CASS 1	A.....
	8A-NF7-011-010		WINDOW,CASS 2	A.....
	8A-NF7-012-010		PANEL,DIRECT	A.....
	8A-NF7-053-010		COVER, REAR H	A.....
	8A-NF7-081-010		CABI,FR HR	A.....
	8A-NF7-112-010		PANEL,RIGHT V-2	A.....
	8A-NF8-005-010		PANEL, TOP	A.....
	8A-NF8-006-010		WINDOW, TOP	A.....
	8A-NF8-007-010		PANEL, LEFT V-2	A.....
	8A-NH7-003-010		PANEL,ASSY FR HR	A.....
	8A-NH7-005-010		PANEL, TRAY H	A.....
	8A-NH7-006-010		WINDOW, DISP H	A.....
	8A-NH7-010-010		PANEL, REAR HRJSM-F	A.....
	8A-NF7-021-010		KEY, BBE	A.....
	8A-NF7-022-010		KEY, SPICE	A.....
	8A-NF7-023-010		KEY, ENTER	A.....
	8A-NF7-024-010		KEY, SURROUND	A.....
	8A-NF7-026-010		KEY, ASSY OPE	A.....
	8A-NF7-029-010		KEY, GEQ	A.....
	8A-NF7-034-010		KEY, MIC	A.....
	8A-NF7-035-010		KEY, ASSY FUN	A.....
	8A-NF7-041-010		KEY, ASSY CD	A.....
	8A-NF7-046-010		KEY, KARAOKE	A.....
	8A-NF7-048-110		KNOB, RTRY ASSY JOG	A.....
	8A-NF7-049-010		KNOB, RTRY ASSY VOL	A.....
	8A-NH7-008-010		KEY, PBC	A.....
	81-532-080-010		LABEL, CASS. COMPT	A.....
	86-NF6-061-010		REFLECTOR, CASS	A.....
	87-NF6-615-010		CONN ASSY, 3P PB	A.....
	87-NF6-616-010		CONN ASSY, 8P RPB	A.....
	84-ZG1-245-210		CAP, OPTICAL	A.....
	82-NF5-218-010		SPR-T, EJECT 1 (SIN)	A.....
	82-NF5-219-010		SPR-T, EJECT 2 (SIN)	A.....
	82-NF5-229-010		PLATE, LOCK	A.....
	86-NF9-224-010		SPR-C, LOCK	A.....
	87-085-221-010		FOOT, H13.5	A.....
	87-NF4-216-010		HLDR, LOCK 1	A.....
	87-NF4-217-110		HLDR, LOCK 2	A.....
	87-NF4-221-010		HLDR, CABLE	A.....
	8A-NF6-217-010		HLDR, PWB PT	A.....
	8A-NF6-219-010		HLDR, FAN	A.....
	8A-NF7-207-010		HLDR, HT L	A.....
	8A-NF7-208-010		HLDR, HT R	A.....
	8A-NF7-209-010		HLDR, PWB-M BTM	A.....
	8A-NF7-226-010		HLDR, IC2-T2	A.....
	8Z-NB8-240-010		COVER, PL	A.....
	8Z-NB8-254-010		COVER, PL M3	A.....
	8Z-NF6-210-010		DMPR, 150 N	A.....
	8Z-NH8-201-010		HLDR, PWB	A.....
*	8A-NF8-206-010		HLDR, PWB M	A.....
	87-067-581-010		TAPPING SCREW, BVT2+3-15	A.....
	87-067-641-010		UTT2+3-8 (W/O SLOT) BL	A.....
	87-067-688-010		BVTT+3-6	A.....
	87-067-703-010		TAPPING SCREW, BVT2+3-10	A.....
	87-078-191-010		S-SCREW, IT+4-10	A.....
	87-721-097-410		QT2+3-12 GLD	A.....
	87-723-096-410		QT2+3-10W/O SLOT BL	A.....
	87-NF4-224-010		S-SCREW, IT3B+3-8 CU	A.....
	87-NF5-203-110		GUIDE, FL(*)	A.....
	8A-NF7-213-010		GUIDE, FUN	A.....
	8A-NF7-214-010		GUIDE, OPE	A.....
	87-067-001-010		FW, 3.1-5.4-1	A.....
	85-NF5-617-010		CABLE, FFC 6P-1.25	A.....
	85-NF5-618-010		CABLE, FFC 13P-1.25	A.....
	87-085-185-010		BUSHING, AC CORD (E)	A.....
	88-915-111-110		FF-CABLE, 15P 1.25	A.....
PT	101	8A-NF7-622-010	PT, ANF-7 H	A.....
W	101	87-A80-157-010	AC CORD ASSY, E BLK CC	A.....
		87-A91-711-010	FAN, 3110GL-B4W-B34-H02 -400MM	A.....
WH	1	87-A90-510-010	HLDR, WIRE 2.5-9P	A.....
WH	101	87-A90-459-010	HLDR, WIRE 2.5-5P	A.....

ACCESSORIES / PACKAGE LIST - 1/1

NOTE: The characters in the suffix column indicate the part usage.

REF.NO	PARTS NO.	NO.	DESCRIPTION	SUFFIX
HR		XX.....		A.....
		KANRI		
	8A-NHR-901-010		IB,H (EC-H) M	A.....
	87-006-226-010		AM-LOOPANT CO	A.....
	87-043-115-010		ANT,FEEDER FM	A.....
	87-050-103-010		CORD,PIN 1PY1.5M	A.....
	87-A90-119-010		ANT,WIRE SW(5M)	A.....
	87-A91-017-010		PLUG,CONVERSION JT-0476	A.....
	8Z-NHT-702-010		RC UNIT,RC-ZAS08	A.....

SCHEMATIC DIAGRAM - 1 (MAIN: AMP SECTION)

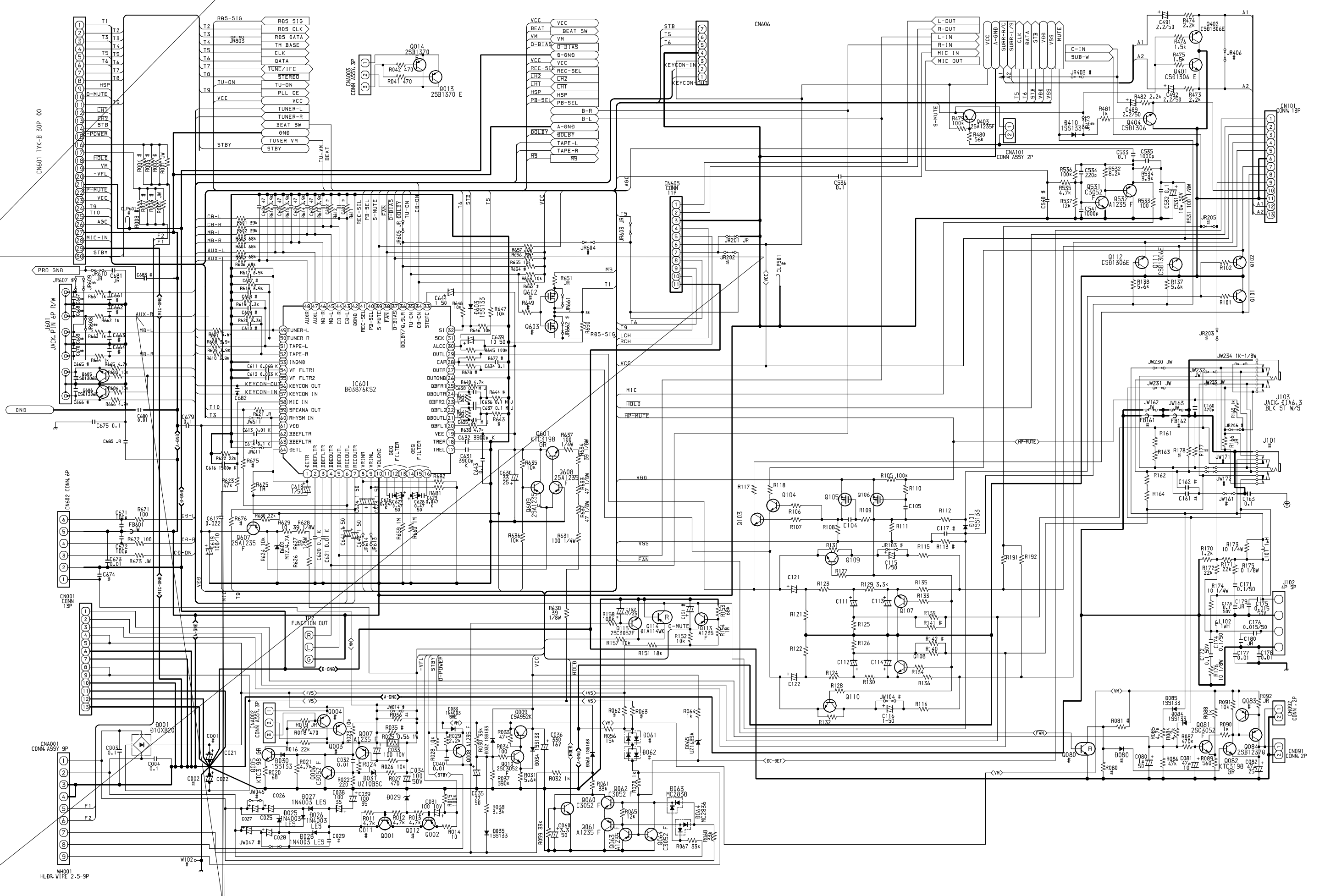

SCHEMATIC DIAGRAM - 2 (MAIN: POLOGIC SECTION)

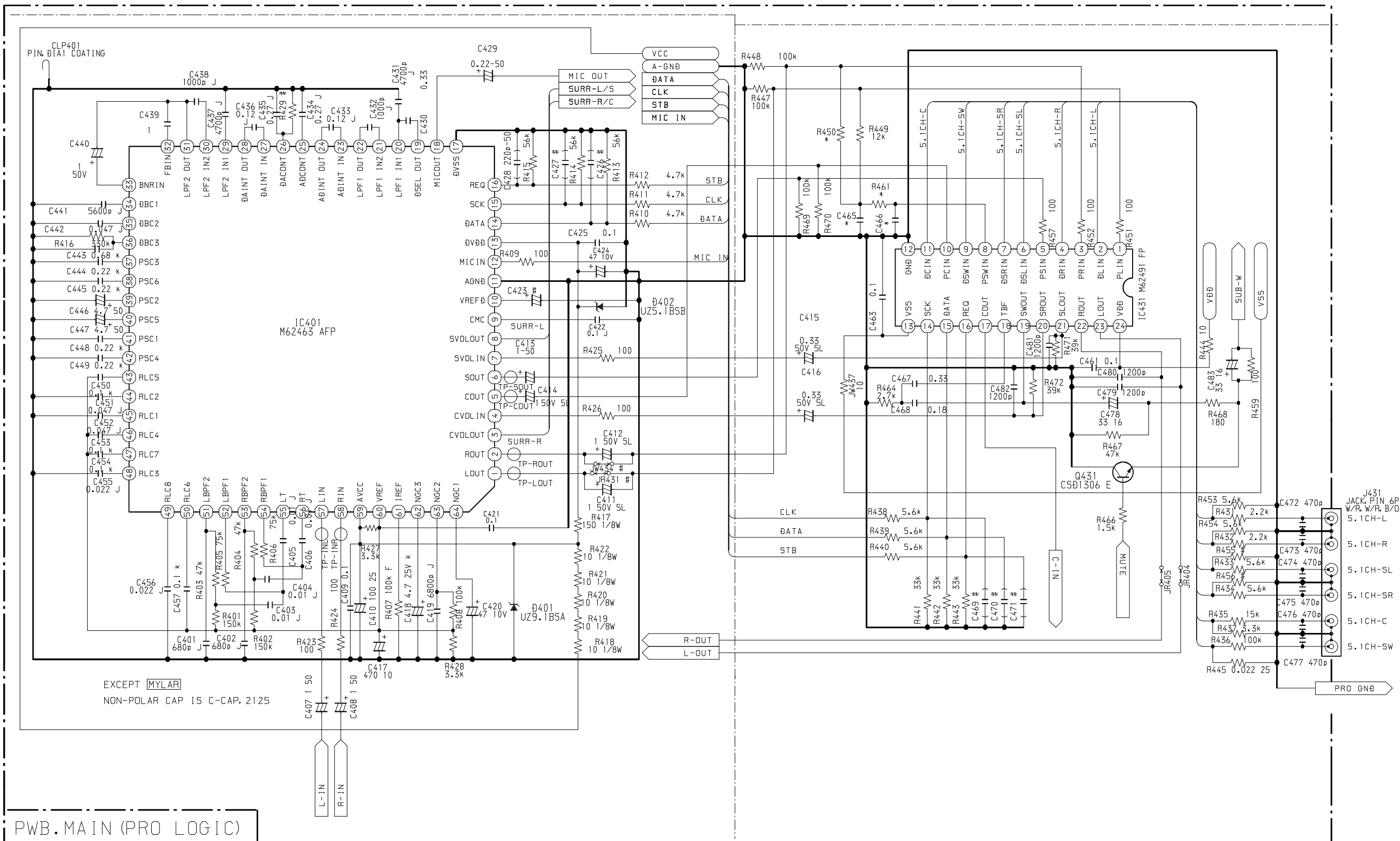

DIFFERENCE LIST

	(1) ANF-24 U	(2) ANH-23 HR	(3) ANH-24 HR
C465	0.22		0.22
C466	0.047		0.047
R450	27k		27k
R461	2.2k		2.2k

T-ANF24-MAIN-ALL (P4)

RAO TA LOW
PROLOGIC
SCHEMATIC DIAGRAM

8A NF6 671 01

ALL

ANF-24/ANH-23/24

06 APR 2000

TABLE - 1 (MAIN: AMP SECTION)

DIFFERENCE LIST

	(1) ANF-24 U	(2) ANH-23 HR	(3) ANH-24 HR
C021	6800/35	4700/35	6800/35
C022	6800/35	4700/35	6800/35
C025	33/100	22/100	22/100
C026	22/100	33/100	
C027	33/100	22/100	22/100
C028	22/100	33/100	
C104	#	0.1	
C105	#	0.1	
C111	#	1/50	
C112	#	1/50	
C113	#	0.68 50 TF	
C114	#	0.68 50 TF	
C121	#	22/50	
C122	#	22/50	
C682	0.1	#	0.1
CN606	#	7P TUC-P7P-B1	
D029	UZ36BSA	UZ39BSB	UZ36BSA
JR611	#	#	JR
JR613	5.6K	5.6K	JR
JR614	5.6K	5.6K	JR
JR661	JR		
JR803	#		
JW611		JW	JW
Q001	2SB1436	2SB1370E	2SB1436
Q002	2SB1436	2SB1370E	2SB1436
Q101		CSB1306E	
Q102		CSB1306E	
Q103	#	2SC3052F	
Q104	#	2SC3052F	
Q105	#	2SJ461-T1	
Q106	#	2SJ461-T1	
Q107	#	2SC3052F	
Q108	#	2SC3052F	
Q109	#	2SC3052F	
Q110	#	2SC3052F	
R101		5.6k	
R102		5.6k	
R106	#	10k	
R107	#	10k	
R108	#	100k	
R109	#	220k	
R110	#	220k	
R111	#	100k	
R112	#	100	
R115	2.7k	10k	470
R116	2.7k	10k	470
R117	2.2k	0.1	2.2k
R118	2.2k	0.1	2.2k
R121	#	100k	

	(1) ANF-24 U	(2) ANH-23 HR	(3) ANH-24 HR
R122	#	100k	
R123	#	1k	
R124	#	1k	
R125	#	180	
R126	#	180	
R127	#	10k	
R128	#	10k	
R130	#	3.3k	
R131	JR	470k	JR
R132	JR	470k	JR
R133	#	10k	
R134	#	10k	
R135	#	3.3k	
R136	#	3.3k	
R139	#	8.2k	
R140	#	8.2k	
R161	390 1/2W	270 1/2W	390 1/2W
R162	390 1/2W	270 1/2W	390 1/2W
R163	390 1/2W	270 1/2W	390 1/2W
R164	390 1/2W	270 1/2W	390 1/2W
R191		82k	#
R192		82k	#
R611	22k	8.2k	8.2k
R612	22k	8.2k	8.2k
R626	47 1/4W	68 1/4W	47 1/4W
R681	15k	15k	
R682	15k	15k	

RAO TA LOW
 (DIFFERENT LIST)
 SCHEMATIC DIAGRAM (2/2)
 MAIN ALL 8A NF6 671 01

SCHEMATIC DIAGRAM - 3 (MAIN: DECK SECTION)

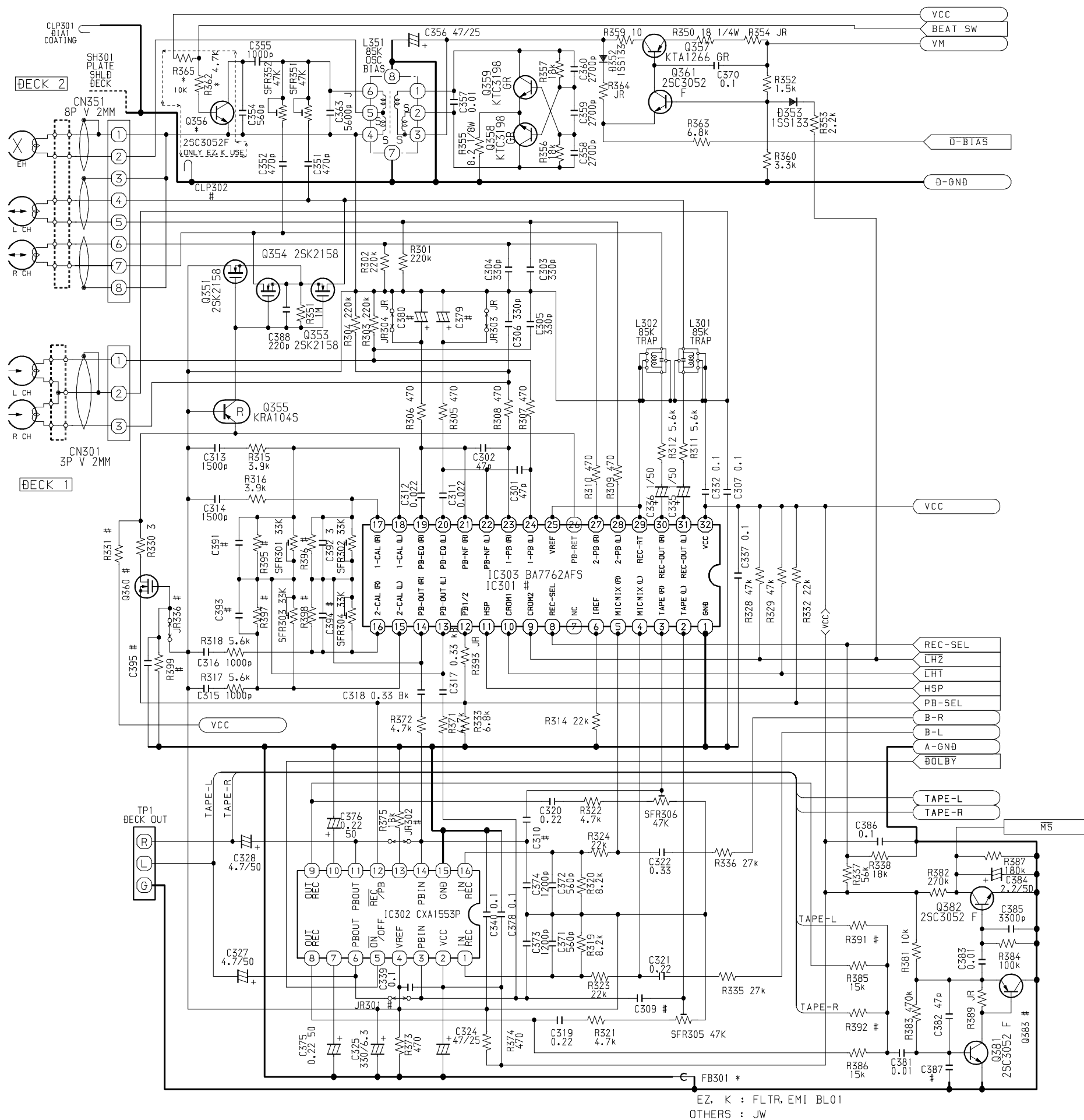

	WITH DOLBY	W/O_DOLBY (R+R)	W/O_DOLBY (R+1_1+1)
JR303	C-JR	X	X
JR304	C-JR	X	X
C379	X	22/25	22/50
C380	X	22/50	22/50
C313	1200P	1000P	1500P
C314	1200P	1000P	1500P
R315	4.7K	5.6K	5.6K
R316	4.7K	5.6K	5.6K
C315	1000P	1000P	2200P
C316	1000P	1000P	2200P
R317	5.6K	5.6K	5.6K
R318	5.6K	5.6K	5.6K
C391	270P	56P	56P
C392	270P	56P	56P
C393	270P	56P	56P
C394	270P	56P	56P
R395	X	100K	100K
R396	X	100K	100K
R397	X	100K	100K
R398	X	100K	100K
SFR301	33K	X	X
SFR302	33K	X	X
SFR303	33K	X	X
SFR304	33K	X	X
C317	0.33 BK	C-JR	C-JR
C318	0.33 BK	C-JR	C-JR
R371	4.7K	39	39
R372	4.7K	39	39
C375	0.22/50	X	X
C376	0.22/50	X	X
R375	18K	X	X
JR301	X	C-JR	C-JR
JR302	X	C-JR	C-JR

	WITH DOLBY	W/O_DOLBY (R+R+1_1+1)
IC302	CXA1553P	X
C309	X	0.1
C310	X	0.1
C319	0.22	X
C320	0.22	X
R321	4.7K	X
R322	4.7K	X
SFR305	50K	X
SFR306	50K	X
C371	820P	X
C372	820P	X
C373	1200P	0.15
C374	1200P	0.15
R319	4.7K	22K
R320	4.7K	22K
R323	22K	C-JR
R324	22K	C-JR
C321	0.22	0.33
C322	0.22	0.33
R335	27K	22K
R336	27K	22K
R391	X	15K
R392	X	15K
R385	15K	X
R386	15K	X
R383	470K	820K
C387	X	270P
C382	47P	15P
R389	C-JR	6.8K
Q383	X	2SA1235
C385	3300P	X

	USE BA7762AF5	USE HA12211
Q360	X	2SK2158
R330	X	C-JR
R331	X	33K
JR336	X	C-JR

	EZ K MODEL	EXCEPT EZ K
Q356	2SC3052F	X
R362	4.7K	X
R365	10K	X

	EZ K MODEL	EXCEPT EZ
FB301	EM1BL01RN1	JW

TA LOW TA LOW
 SCHEMATIC DIAGRAM (DECK)
 8A NF6 631 01
 ALL
 ANF3/4-DECK

T-ANF3/4-DECK-ALL

23 DEC 1999

EZ, K : FLTR, EMI BL01
 OTHERS : JW

SCHEMATIC DIAGRAM - 4 (MAIN: TUNER SECTION)

IFT COIL

	PARTS NO./ PARTS CODE		
	U/LH, EZ, K, G, V	HE/HR/HC	D/HD
1ST	87-A91-551-01 FLTR, PCFJZH-450 L (TOK)	87-A91-552-01 FLTR, CFMT-45DAL (TOK)	87-A91-553-01 FLTR, PCFMT-060L (TOK)
2ND			
3RD			

AM PACK

	PARTS NO./ PARTS CODE	
	U/LH, D/HD, V	EZ, K, G
1ST	8A-NF8-667-01 COIL, AM PACK4 (TOK)	8A-NF8-668-01 COIL, AM PACK (TOK)
2ND		
3RD		

*EXCEPT SW BAND MODEL (HE/HR/HC)

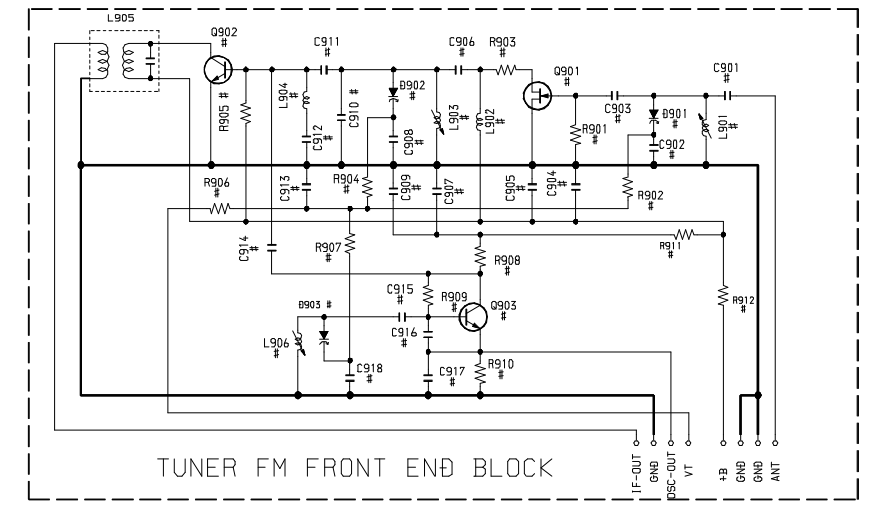

TUNER FM FRONT END BLOCK

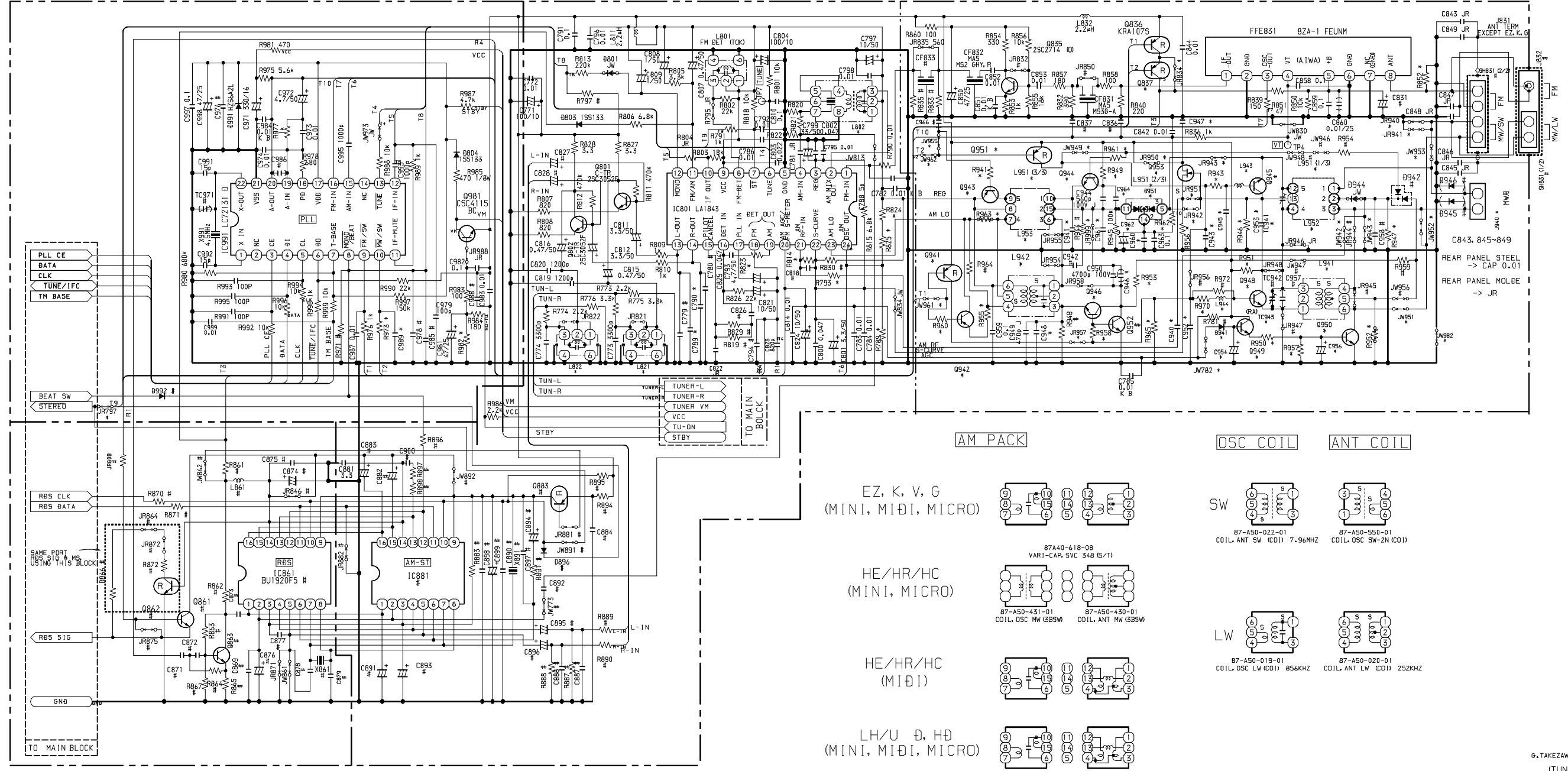

AM PACK

EZ, K, V, G
(MINI, MIDI, MICRO)

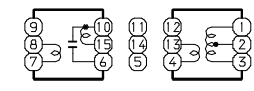

HE/HR/HC
(MINI, MICRO)

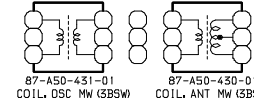

HE/HR/HC
(MIDI)

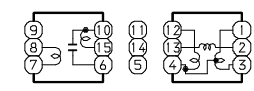

LH/U D, HD
(MINI, MIDI, MICRO)

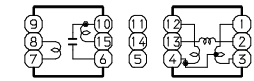

OSC COIL

SW

87-A50-022-01
COIL, ANT SW (CO1) 7.96MHZ

87-A50-550-01
COIL, OSC SW-2N (CO1)

LW

87-A50-019-01
COIL, OSC LW (CO1) 856KHZ

87-A50-020-01
COIL, ANT LW (CO1) 252KHZ

T-ANF-TUNER-HIGH

DIFFERENCE LIST

	(1) ANF-24 U	(2) ANH-23 HR	(3) ANH-24 HR
C789	0.027	0.015	0.015
C790	0.027	0.015	0.015
C940	JR	0.01	0.01
C941	#	22p	22p
C943	#	0.01	0.01
C945	#	0.01	0.01
C946	#	4700p	4700p
C947	#	0.01	0.01
C948	#	4p	4p
C952	#	0.01	0.01
C953	#	0.01	0.01
C954	#	0.47/50	0.47/50
C956	#	100/10	100/10
C960	0.1	#	#
C961	8p	#	#
C962	#	1/50	1/50
C964	#	560p	560p
C989	#	0.01	0.01
R941	#	155133	155133
R951	#	5VC384 (S/T)	5VC 348
J940	#	2P H 2.5MM JMT	2P
JR797	JR	#	#
JR834	JR	#	#
JR940	#	JR	JR
JR941	#	JR	JR
JR942	#	JR	JR
JR943	JR	#	#
JR950	#	JR	JR
JR951	JR	#	#
JR957	#	JR	JR
JR989	#	JR	JR
JW782	#	JW	JW
JW942	JW	#	#
JW943	#	JW	JW
JW949	#	JW	JW
JW951	#	330	330-1/8W
JW952	JW	#	#
JW953	JW	#	#
JW955	#	JW	JW
JW961	#	JW	JW
JW962	#	JW	JW
JW982	#	JW	JW
L802	FLTR PCFJZH-450	FLTR CFMT-450AL (TOK)	CFMT-450AL
L821	COIL 1POLE MPX (MIT)	COIL 1 POLE MPX (TOK)	1 POLE MPX
L822	COIL 1POLE MPX (MIT)	COIL 1 POLE MPX (TOK)	1 POLE MPX
Q41	#	ANT SW (C01) 7.96MHz	ANT SW 7.96MHz
Q42	#	OSC SW-2N (C01)	OSC SW-2N
Q43	#	1mH K	1mH K CEC
Q44	#	1.0mH K	1.0mH K C2B

	(1) ANF-24 U	(2) ANH-23 HR	(3) ANH-24 HR
L951	COIL AM PACK 4 (TOK)	ANT MW (3BSW)	ANT MW
L952	#	ANT MW (3BSW)	OSC MW
L953	#	OSC MW (3BSW)	KRA1075
R837	#	KRA1075	KRA1025
R942	#	2SA1235F	2SA1235F
R943	#	2SA1235F	2SA1235F
R944	#	2SC3052F	2SC3052F
R945	#	2SC3052F	2SC3052F
R946	#	C501306E	C501306F
R948	#	C501306E	C501306F
R949	#	2SC3052F	2SC3052F
R950	#	C501306E	C501306E
R951	#	KRA1025	KRA1025
R953	#	25K360E	25K360E
R789	#	100k	100k
R814	1M	220	220
R823	33k	2.2k	2.2k
R824	1k	#	22k
R825	47k	#	#
R852	1.0k	#	#
R941	#	2.2k	2.2k
R943	#	3.9k	#
R946	#	3.3M	3.5M
R947	#	JR	JR
R949	#	3.3M	3.3M
R950	#	15k	15k
R951	#	3.3M	3.3M
R952	#	3.3M	3.3M
R953	#	22	22
R954	#	1k	1k
R956	#	4.7k	4.7k
R957	#	4.7k	4.7k
R958	#	10k	10k
R960	#	18k	18k
R961	#	1k	1k
R962	220	1k	1k
R963	33	JR	JR
R965	#	470k	470k
R970	#	1k	1k
R973	#	1k	1k
R982	8.2k	10k	10k
TC941	#	20P 4.0X4.5 ECR	CER 20P 4.0X4.5 ECR
TC943	#	30P 4.0X4.5 ECRLA	CER 30P 4.0X4.5

TUNER RAO TA LOW
 SCHEMATIC DIAGRAM (2/2)
 8A NF6 671 01

SCHEMATIC DIAGRAM - 5 (MAIN: GEQ SECTION)

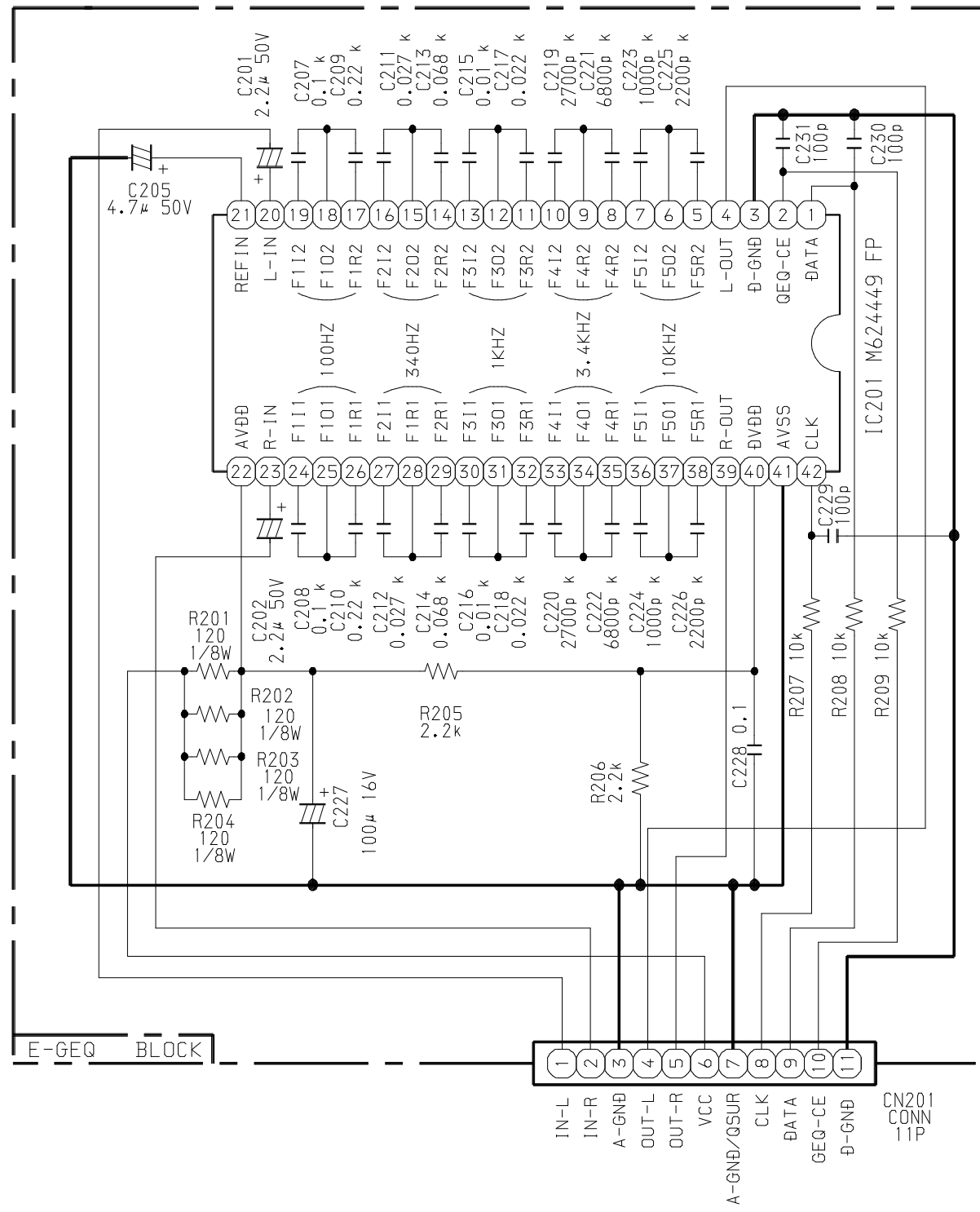

TA LOW TA LOW
 (E-GEQ)
 SCHEMATIC DIAGRAM
 8A NF6 634 01

ALL

ANF3/4-GEQ

SCHEMATIC DIAGRAM - 6 (MAIN: K-CON SECTION)

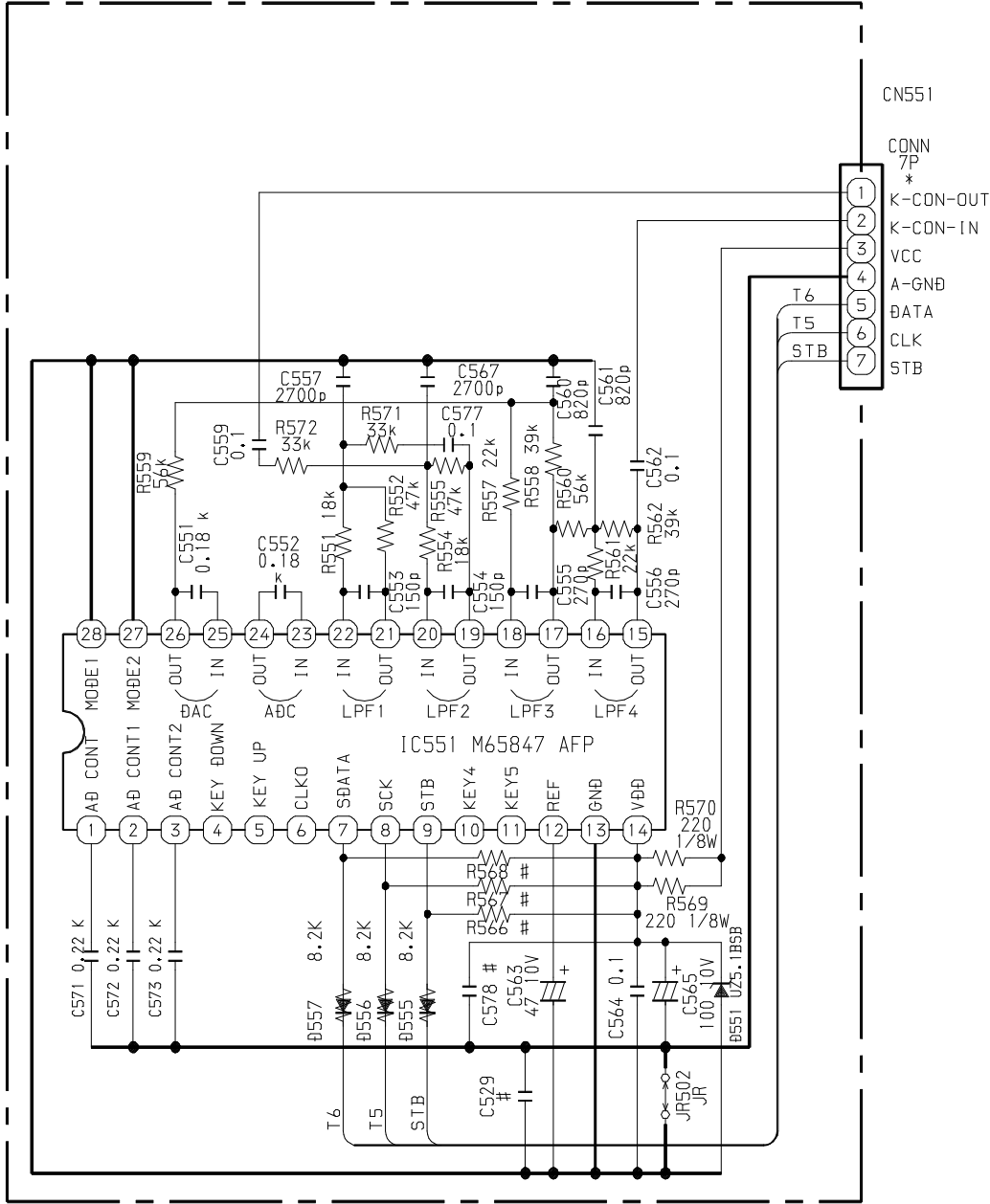

TALOW TALOW

SCHEMATIC DIAGRAM (K-CON)

8A NF6 633 01

ANF3-KCON-HR

23 DEC 1999

ANF3-KCON-HR

SCHEMATIC DIAGRAM-9 (AMP)

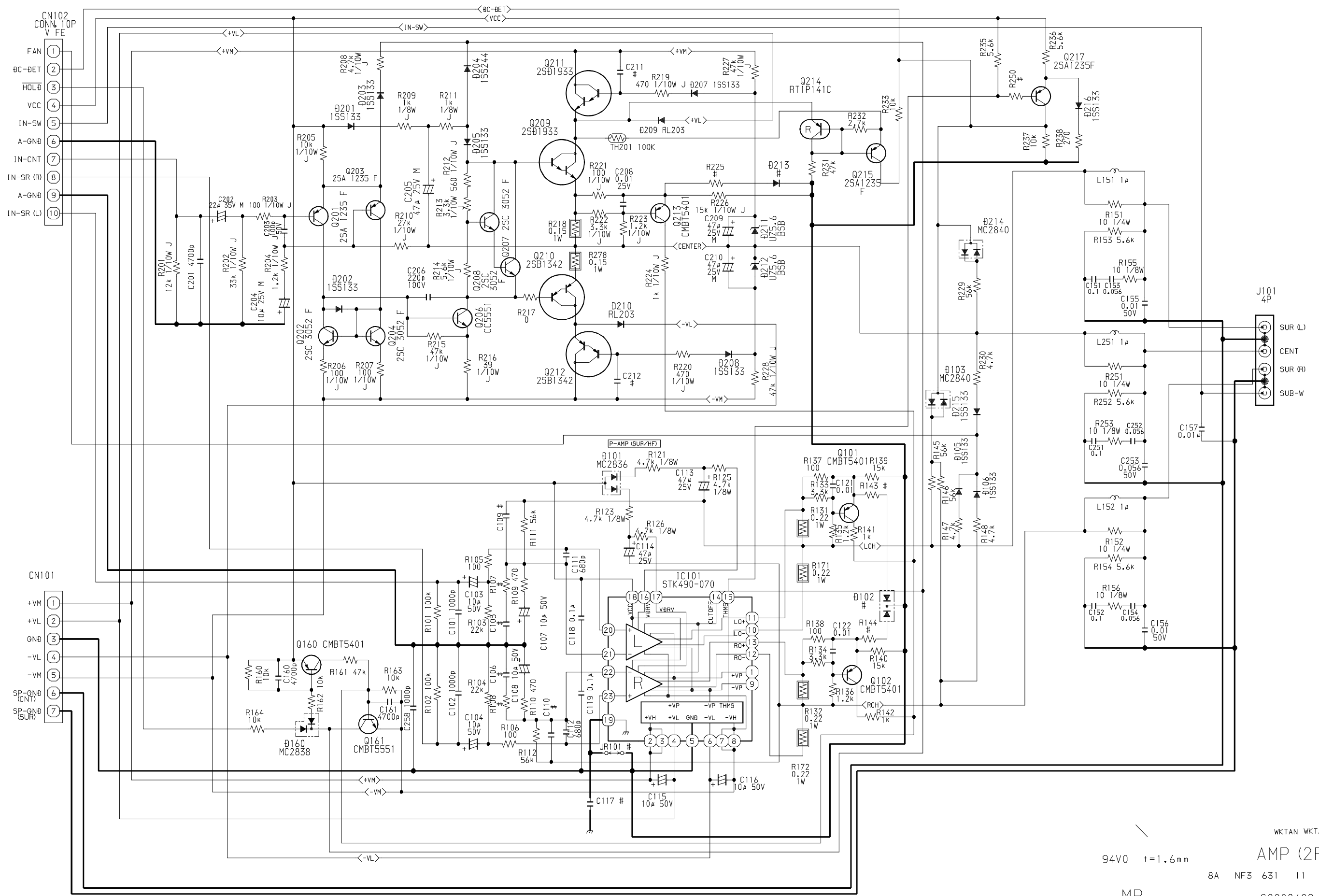

WKTAN WKTAN
 94V0 t=1.6mm AMP (2F)
 8A NF3 631 11
 MP C0000402
 ANF-24/ANH-24
 08 APR 00

SCHEMATIC DIAGRAM - 10 (PT)

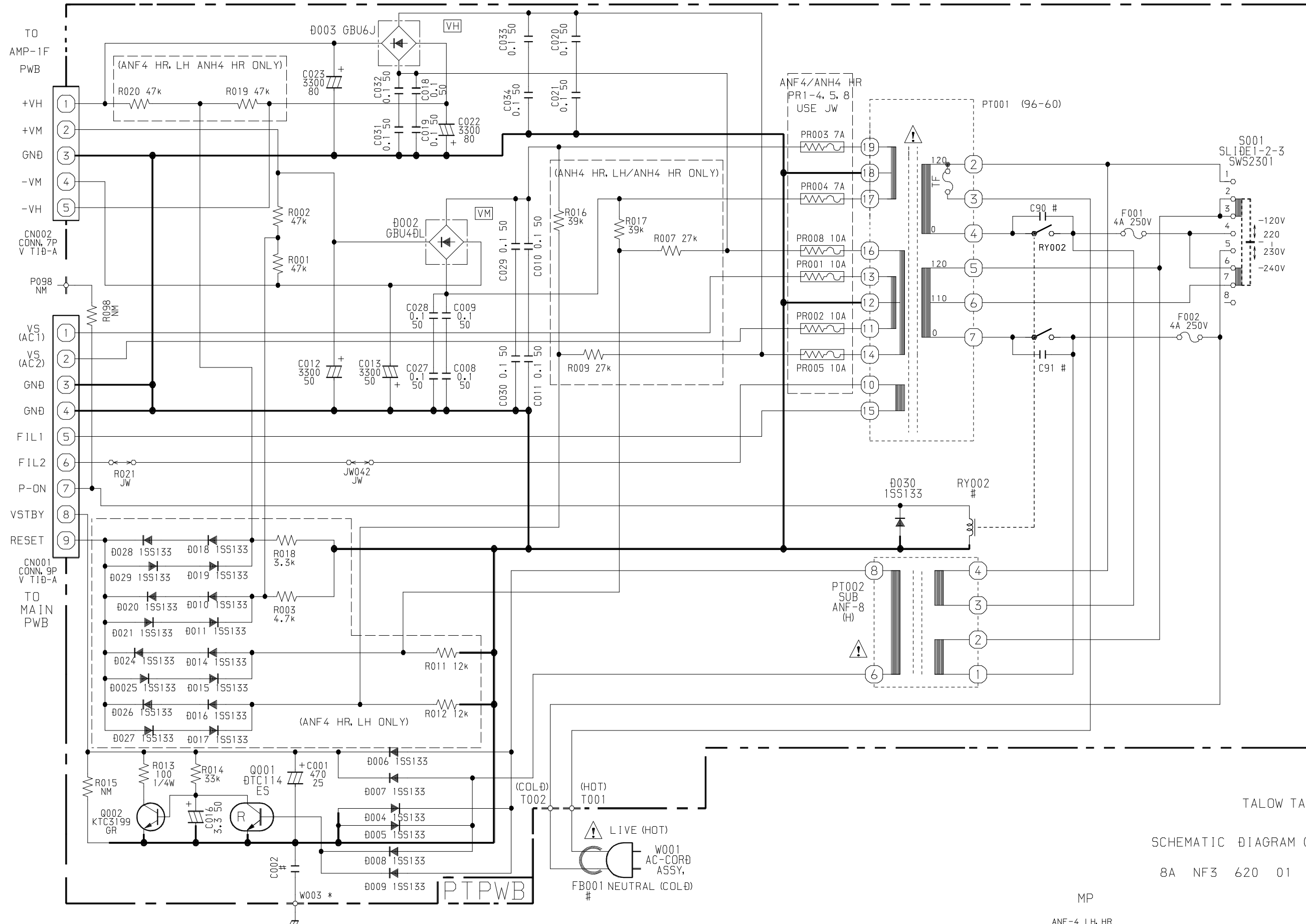

TALOW TALOW
 SCHEMATIC DIAGRAM (PT)
 8A NF3 620 01

MP

ANF-4 LH, HR
 ANF-3/ANH-3/4/24 HR

07 APR 2000

アイワ株式会社 〒110-8710 東京都台東区池之端1-2-11 ☎03(3827)3111 (代表)
AIWA CO.,LTD. 2-11, IKENOHATA 1-CHOME, TAITO-KU, TOKYO 110, JAPAN TEL:03 (3827) 3111