

CAT. NO. **B2M**

2855



As Featured in

IOR
SCIENCE
KITS

INTERNATIONAL RECTIFIER

SELENIUM PHOTOCELL & **SUN BATTERY**

Approximate Output in Sunlight: $\frac{1}{3}$ to 0.4 Volt, $1\frac{1}{2}$ to 2 MA.

SUITABLE FOR LIGHTMETERS, OPTICAL DEVICES, POWERING
SMALL RADIOS, SCIENTIFIC PROJECTS, ETC.

THIS 24 PAGE
HANDBOOK,
PRICED AT 50c

FREE
WITH PURCHASE
OF CELL.

See the All-New Science Labs
that Feature Exciting Experiments
"Powered by the Sun"!



IOR
INTERNATIONAL RECTIFIER

SCIENCE KITS



**SOLAR ENERGY
CONVERSION KIT...**
features an electric motor driven directly by a solar cell, gears, pulleys, whirling discs, propeller, mounting brackets and base... everything you need to demonstrate solar energy in action. Ideal for building small solar powered models!

7 NEW LAB KITS... including electricity labs, photo-electric labs and transistor electronic labs. All feature space satellite solar coils for exciting experiments and professional-type control panel. Lots of new features... Hours of Fun! Top quality components throughout. Ask your dealer for a brochure on this new line of space age labs.

SEE THESE NEW KITS AT YOUR DEALER'S!



SOLAR CELLS FOR EXPERIMENTERS

By Donald L. Stoner, W6TNS

CHAPTER 1 — MEET THE SOLAR CELL

The earliest practical use for sun generated electricity is the light meter which is used to indicate the correct exposure settings for cameras. In this device a photocell is connected to a moving coil meter (see Fig. 1).

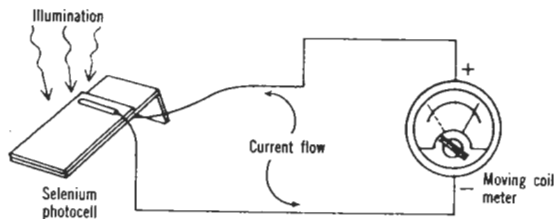

Fig. 1 Meter measures selenium photocell output

When light strikes the cell, a tiny electrical current is generated. This current flows through the meter coil and causes the pointer to move. When the sun is bright, the meter reads higher than it would on a cloudy day, for example. The meter is calibrated in light units and indicates the correct settings for the camera.

More recently, our space scientists became interested in converting the sun to electric-

ity. They faced the problem of spending millions of dollars to orbit a satellite, only to have its batteries run down after a few weeks of operation. In effect, the solar cell provided the scientist with an extension cord to the sun! The "space man" devised a system with solar cells and batteries which would recharge when the satellite zoomed around the sunlit side of the earth. One example is the Tiros satellite which takes pictures of the earth for weather forecasting. It is powered by the sun's rays falling on panels made up of solar cells. These panels maintain a full charge on the batteries and keep the electronic equipment working properly.

How They Work

Cells which convert sunlight directly into electricity can be made in many ways and vary in size, shape and characteristics. The theory of operation for all types is much the same, however. From high-school physics we know that an electric current is created whenever we set electrons in motion. When we switch on a flashlight, we permit electrons to flow from one battery terminal to the other through the bulb. Another example is the generator in an automobile which moves a wire through a magnetic field. This forces electrons through the wire, and creates an electrical current.

Like the wire, cells which convert sunlight into electricity contain many electrons, but these are held tightly in place. When the cells are illuminated, the rays of light activate electrons and send them through an electrical circuit. This movement of electrons constitutes electrical current. It's as simple as that!

Photocells and Solar Cells

The cells used in the camera light meter, mentioned earlier, are called *photocells*. Scientifically, these cells are known as photovoltaic cells. The cells are made from an element known as selenium, which is carefully processed to permit electrons to be freed by light. Selenium is placed on a metal plate, so it can be handled without damage, and wire leads are attached. Selenium cells "see" the same light spectrum as the human eye. Another type of cell, the one used in satellites, is made of the element silicon, and is correctly called a *solar cell*. Silicon is the most common element found on our planet, and it is the same material which we use to make glass. However, to process silicon so that sunlight will free electrons is a costly operation and therefore this type of cell is relatively expensive. These cells are very delicate and are enclosed in plastic cases for easy use by experimenters.

A third type of cell made from cadmium

sulfide does not generate electricity from sunlight. This cell has the very useful characteristic of changing resistance when illuminated. Some types when removed from light to dark, change in resistance by a factor of millions. By connecting it in series with a battery or an AC supply, the cadmium-sulfide cell can control the flow of current in relays, transistor circuits and meters (see Fig. 2).

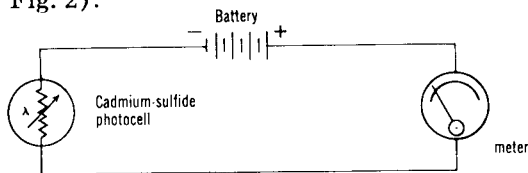

Fig. 2 Cadmium sulphide photocell controls current flow (Minimum resistance when cell is illuminated permits maximum current flow)

When the cell is dark, maximum resistance permits only a small amount of current to flow in the controlled circuit. When the cell is illuminated, its resistance drops to a low value and almost the entire supply voltage reaches the controlled circuit.

A Home-Made Sun

It is not always convenient to wait until the sun makes an appearance to experiment with solar cells. You can make your own "sun" by mounting a 150 watt reflector-type floodlamp one foot above your work surface. Don't be tempted to move it closer to the

cell because the heat can destroy the material. Vary the distance between the cell and light to demonstrate the effect of intensity changes.

CHAPTER 2 — MEASURING SOLAR POWER

Experiment #1

For the following experiment you should use a volt-ohm-milliammeter which can measure as low as one milliampere of current and has a 0-3 volt scale. You will also require a 22 ohm resistor, and of course, a cell.

Connect the cell to the meter and switch to the 3 volt scale. Illuminate the cell and measure the voltage. If you have a B2M, B3M or S1M cell, the voltage will read between one third and one half volt with bright illumination, such as direct sunlight. (Type S3M or S5M gives twice this voltage.) Now connect the 22 ohm resistor across the meter and cell as shown in Fig. 3.

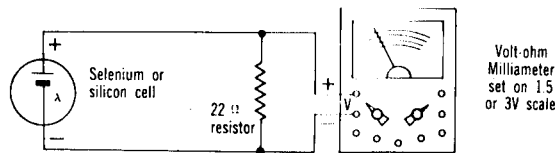

Fig. 3 Meter measures cell output voltage

You will find the B2M and B3M now produce only a tiny voltage. The S1M, however, will produce between 0.2 and 0.3 volts.

The 22 ohm resistor is called a "load" and represents the circuit which uses the power generated by the cell. From this experiment you can conclude that the silicon cell can deliver more power than can the selenium cell. This is, in part, caused by the fact that the silicon cells convert not only visible light, but also some of the invisible spectrum into electricity. Selenium cells, however, have a response very similar to the human eye and are therefore recommended for photographic or similar optical applications.

Experiment #2

Set the meter on its 25 ma. range and connect it in series with cell as shown in Fig. 4.

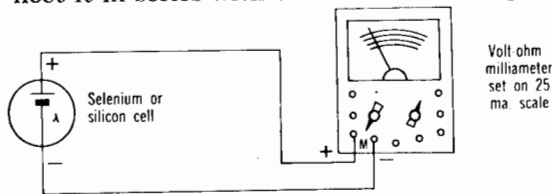

Fig. 4 Meter measures cell output current

With these connections we can observe the current produced by the cell. The B2M and B3M will produce approximately one to two ma, while the S1M may generate up to 15 ma. Thus you can conclude that the S1M pro-

duces more current than the B2M or B3M under the same illumination.

Experiment #3

You can determine the actual power your cell produces by multiplying the voltage times the current in ma. The answer will be in milliwatts (1,000 mw. equals one watt). For example, if your S1M produces 0.4 volt at 14 ma. ($14 \times 0.4 = 5.6$), the cell produces 5.6 mw. of power. A typical B2M or B3M might generate 0.4 volt at 1.5 ma., or 0.6 mw. of power.

Experiment #4

Connect a cadmium-sulfide cell Type CS-120 to the highest ohmmeter range. When the cell is covered, or dark, the resistance will measure more than half a million ohms. Now, illuminate the cell. The resistance when illuminated will drop to several thousand ohms or less, depending on the amount of light. This experiment shows that the cadmium-sulfide cell produces a large change in resistance when illuminated, which can be used to control electrical circuits.

Experiment #5

You can make a perpetual battery by connecting the circuit shown in Fig. 5.

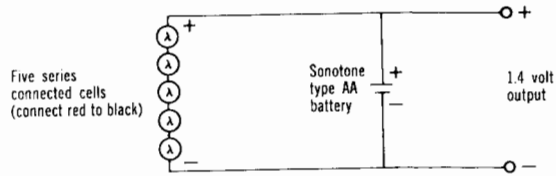

Fig. 5 Perpetual battery similar to the same basic system used in sun powered satellites

This is the same basic system used in our sun powered satellites, but on a much smaller scale. The circuit uses a single Sonotone Type AA nickel-cadmium rechargeable battery.

Five B2M or five B3M cells will charge the battery at approximately one ma., while the S1M cells will charge at a rate of 10 ma. More cells can be connected in series parallel for higher charging rates, or you may use the higher output types S3M or S5M cells. The battery will lose its charge only if more current is drawn from it than the cells are able to replace.

CHAPTER 3 — SUN RELAYS

Like the battery just described, you can construct a perpetual sun relay. Whenever the sun is shining, the current from the cell can be used to energize a relay without the aid of batteries, transistors or other accessory devices.

Figure 6 shows the connections for a per-

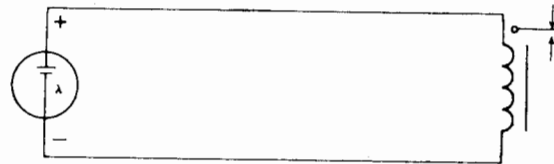

Fig. 6 Perpetual sun relay with ultra-sensitive relay powered by one cell.

petual sun relay circuit. The relay is an ultra-sensitive type made by Barber-Coleman of Rockford, Ill., and is called a "micropositioner." The relay will trip, or energize, on the current generated by only one cell.

If type B2M or B3M cell is used, model AYLZ7303-100 is best suited. If silicon cell such as S1M is used, type AYLZ7325-100 is recommended. These relays are expensive and run over \$20.00 a piece. Another relay which will work satisfactorily with one or two silicon cells, and sells for around \$11.00 is the Sigma type 5F-16SS-PAL.

Another type of perpetual sun relay is shown in Fig. 7. This circuit requires six

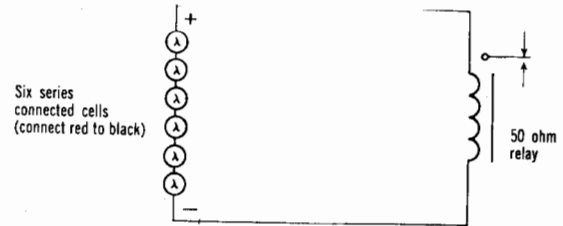

Fig. 7 Perpetual sun relay with 50 ohm model airplane radio control relay powered by six S1M cells

S1M or three S3M cells to trip a 50 ohm model airplane radio control relay. These are sold through model or hobby shops and manufactured by W. S. Deans Co., 8512 Gardendale St., Downey, Calif., also by Jaico Products Co., 1921 W. Hubbard, Chicago.

A third type of light relay uses the cadmium-sulfide cell, but requires a power supply and therefore does not qualify as a "perpetual" type. The circuit is shown in Fig. 8.

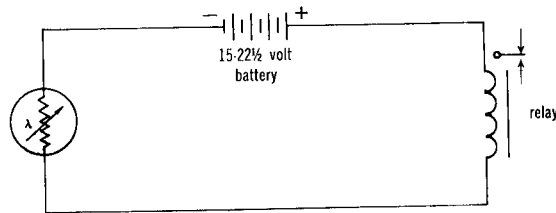

Fig. 8 Sun relay controlled by cadmium sulfide photocell

When light shines on the cadmium sulfide cell, its resistance drops and permits the current to energize the relay. The relay in this circuit is a 5,000 ohm type as used for model airplane radio control.

Other relays which work satisfactorily are the Sigma 41 series with 1000 or 2500 ohm coil resistance.

For continuous use, such as for turning on lights in the evening, the same circuit can be used by substituting a bell type transformer (available from electricians) for the battery and operating the circuit from the regular

115 volt AC line. The relay, in this case, should be of the AC type.

As the cadmium sulfide cell, type CS-120 may be operated on voltages up to 120 volts AC or DC, the use of a transformer is not necessary and the circuit may be operated directly from the line current. However, the coil resistance of the relay should be around 10,000 ohms in this case. As there are certain hazards connected with working directly with a full line voltage, this circuit should only be assembled by someone familiar with the problems and aware of the dangers. Practically no hazard exists when using batteries or a bell type transformer circuit.

Experiment #6

By using an inexpensive transistor and battery, you can eliminate the need for expensive relays and still use only one B2M, B3M or S1M cell.

The transistor is a sensitive device for amplifying current flow. For example, a current of one ma. from a solar cell in the transistor base can control 10 ma. in the collector circuit. We call this process *current amplification*. (See Fig. 9.)

When wiring this type of circuit be careful to connect the plus and minus points correctly. The battery will be clearly marked. The plus end of the cell is red, and the minus

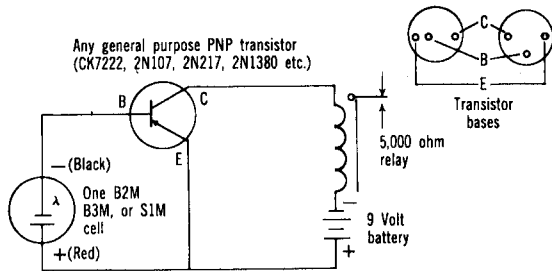

Fig. 9 Transistor current amplifier powered by solar cell

end is black. This experiment illustrates the fact that inexpensive transistors are useful for replacing more sensitive, but expensive components.

Experiment #7

The same transistor amplification system can be used with the cadmium-sulfide cell to trip a 5,000 ohm relay. The circuit is connected as shown in Fig. 10.

In this circuit, the battery current applied

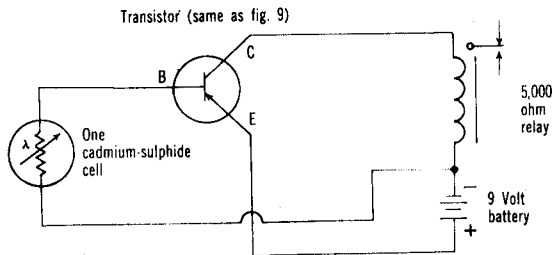

Fig. 10 Sun relay controlled by cadmium sulfide cell

to the transistor for amplification passes through the CS-120 cell. Different light levels vary the cell resistance which changes the amount of current available for amplification. The transistor steps up this current, or amplifies it, which actuates the relay.

Experiment #8

By adding a second transistor to experiment #6, you can build a super-sensitive sun relay as shown in Fig. 11.

Transistors (same as fig. 9)

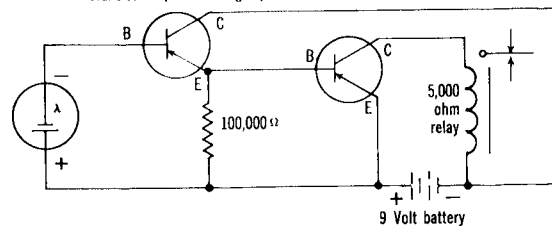

Fig. 11 Supersensitive sun relay powered by one S1M solar cell

In this circuit, the current from the cell is increased by transistor 1. This amplified current is then passed to transistor 2 where it is again stepped up. As a result, only a tiny voltage which corresponds to very little illumination is sufficient to trip the relay. The sensitivity is determined by adjustment of the relay spring or you may partially cover the cell with cardboard or tape. The circuit will trip the relay on virtually any amount of light and a flashlight at 100 feet will easily

close the relay.

In this and the preceding circuits, the relay can be connected to ring a bell, flash a warning light, or energize other types of alarm systems. It can also be connected to turn on porch, store or street lights whenever the sun drops below a certain point.

CHAPTER 4 — SUN POWERED RADIOS

One of the most fascinating projects you can build is a radio which derives its power from the sun. Contrary to what you might think, it is not expensive—in fact, the bill of materials should run not much over five dollars. A one transistor sun-radio is shown in Fig. 12.

Experiment #9

Here's how it works: The signal from the

General purpose PNP transistor (see fig. 9)

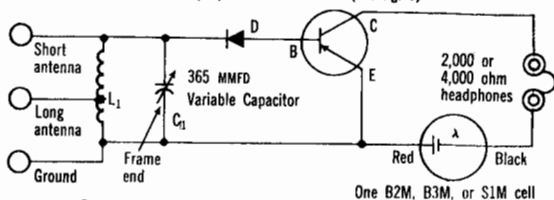

Parts list:

- C₁—365 mmfd variable capacitor (J. W. Miller #2111 or equivalent)
- D—Crystal diode, 1N34, 1N48, etc.
- L₁—Transistor loopstick antenna (J. W. Miller #2001 or equivalent)

Fig. 12 Transistor radio powered by one solar cell

radio station is intercepted by the antenna which is connected to a coil and tuning capacitor. It is the purpose of this "team" to tune in the desired frequency from the many signals traveling through the air. Once the desired signal is selected, a device called a diode detector converts the radio frequency energy to audio frequencies, so that they can be heard.

The tiny electrical signal from the detector is passed on to a transistor for amplification as described in chapter 3. The amplified signals then energize the headphones which convert the electrical impulses to sound waves. No battery other than the photocell is required to power the radio; however, a penlight or other small flashlight cell could be used to operate the set at night. The radio is designed to use either a short (10-20 ft.) or long antenna (20 ft. or more).

When you examine the coil (L₁), you will see three wires. One of the wires will be doubled up (two wires in one) and this lead connects to the long antenna. The lead nearest the double wire goes to the frame of the tuning capacitor and to earth ground. The remaining wire goes to the lugs on the side of the tuning capacitor. Connections to the frame of the tuning capacitor can be made by inserting a short screw in one of the front holes and wrapping a wire under the screw head. Be sure the screw does not touch the

aluminum plates. The connections to the transistor are similar to those in Fig. 9, except that headphones are used in place of the relay.

For best performance, connect the receiver to an antenna of 20 feet or more. Remember, the longer the antenna, the greater the volume and number of stations you can receive. In metropolitan areas, a long antenna may create the problem of station interference. A good ground will also improve reception. A suitable ground can be made by connecting the receiver to a cold water pipe or by driving a four-foot copper stake into moist earth.

When testing the radio, try both antenna connections and use the one which provides the best performance. You may have more volume by using the short antenna connection, but separation between stations will be better using the long antenna connection. For additional volume, on weak stations, you can connect two or more cells in series to increase the sun voltage, or use a type S3M cell.

This experiment proves that the sun powered amplifier greatly improves the volume of a diode detector. To hear the difference with and without the transistor amplifier, connect the headphones between the base and emitter of the transistor. The signal at this point is not amplified and will be much weaker.

Experiment #10

You can increase the output of the one transistor solar-powered radio by adding a second transistor amplifier stage. The circuit is shown in Fig. 13.

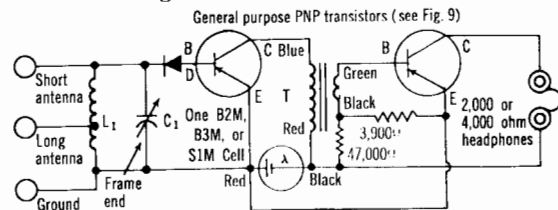

Parts list:
 T — 10,000 ohm to 2,000 ohm interstage transformer (Stancor TA-35 or equivalent)
 (Other parts, same as Fig. 12)

Fig. 13 Two transistor radio powered by one solar cell

A transformer is needed to couple the output of one transistor to the input of the next. The transformer may be any interstage type, such as the Stancor TA-35, or a Triad No. TY56X, rated at 10,000 ohms to 2,000 ohms. The transistor types and connections are the same as in Fig. 9.

This radio will always work best with the antenna on the long connection. Even so, you may find it has too much volume for clear reception. If this is the case, you can connect a 100 mmfd. (or less) capacitor in series with the antenna. For weak stations you can obtain more volume by connecting several cells in series or by using a type S3M cell.

If additional cells are used and if you use different transistors or headphones, it may be necessary to vary the value of the 3,900 ohm resistor for best reception.

From this experiment you can conclude that a single cell, powered by the sun, provides enough energy for very loud earphone volume. If you use several cells, you may even use a small speaker, but do not expect too high a volume.

CHAPTER 5

SUN POWERED OSCILLATORS

Earlier we mentioned that electrons forced to flow through a wire are an electric current. If the electrons move in only one direction, we call this a direct current. If they are made to move first in one direction, then in the opposite, we call this an alternating current.

Slow alternations, known as low frequency cycles, will be in the audio range. This band is generally considered to be between 16 and 20,000 cycles per second. If the electron alternations are speeded up, to several million cycles per second, we generate radio frequency energy which can be sent through space.

Let's build several of these oscillators in different frequency bands, solar powered of course, and see how they work.

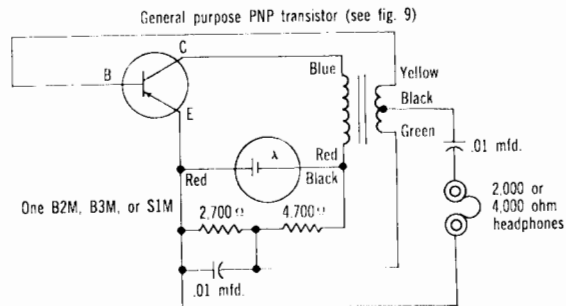

Fig. 14 Audio oscillator powered by one solar cell

Experiment #11

Fig. 14 shows a solar powered audio oscillator. Its frequency of alternations, or oscillations, is about 400 cycles per second. In this circuit, the energy amplified by the transistor is applied to the transformer primary (blue-red). A portion of the energy is fed back to the base of the transistor where it is again reamplified. Connected in this manner, the circuit current constantly builds up, then breaks down. In other words, it oscillates.

The transformer can be any interstage type rated at 10,000 ohms to 2,000 ohms, center-tapped. Although 2,000 or 4,000 ohm headphones are specified, almost any type can be used. With only a single cell, you will find that the volume is extremely high. You can use the audio oscillator for code practice by inserting a telegraph key in series with the cell.

Experiment #12

A tunnel diode radio frequency transmitter, which will generate a strong signal on the broadcast band (550 to 1600 Kc.) is shown in Fig. 15.

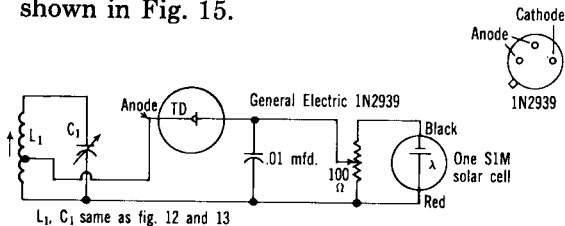

Fig. 15 Tunnel diode radio frequency transmitter powered by one S1M solar cell

It uses the same coil and tuning capacitor as in Figs. 12 and 13. In this circuit, the anode end of the tunnel diode is connected to the long antenna connection shown in the radio circuits. A single solar cell provides approximately 0.5 volt, and a small portion of this voltage is applied to the diode through a 100 ohm potentiometer.

The circuit is adjusted as follows: Place a portable radio, tuned to a weak station near the high end of the band, near the coil. Rotate the potentiometer and tuning capacitor at the same time. At one setting you should hear the radio station disappear, indicating oscillation of the tunnel diode. You will find one position on the potentiometer where the signal will be very strong. As you move the radio away from the tunnel diode

oscillator, the signal will get weaker and become a whistle on the weak station you tuned in originally.

The tunnel diode is available at electronic supply houses selling General Electric tubes and costs about \$6.00 each. Mail-order houses also stock them.

Experiment #13

Let's build a solar powered Citizens Band 27 mc. transmitter. The circuit is illustrated in Fig. 16.

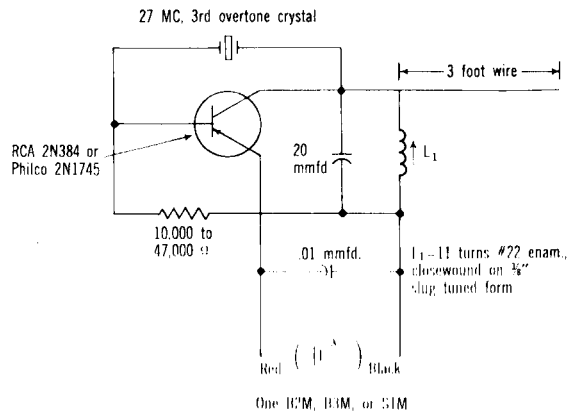

Fig. 16 Citizens Band 27mc transmitter powered by one solar cell

The frequency of the transmitter is controlled by a quartz crystal (at 27 mc. third overtone type, commonly found in Citizens Band transmitters). The coil and its asso-

ciated capacitor tunes the transistor to amplify and oscillate at the crystal frequency. The small length of wire serving as an antenna permits the radio frequency energy to travel several hundred yards.

The transistor may be any of the Philco MADT types such as the 2N1745 or an RCA drift type 2N384. After the circuit is completed, it may be necessary to vary the value of the resistor between 10,000 and 47,000 ohms to obtain maximum signal.

SOME ADDITIONAL VALUABLE POINTS:

How Do I Mount My Cells?

The B2M has a bracket with a hole for mounting. It is shipped flat but can be bent in any angle (see picture on inside back cover). All other experimenter type cells come in a plastic case. A double faced, pressure sensitive adhesive disc is shipped with each cell. Just peel off the backing on one side and press it to the cell. Then remove the backing of the other side, and you can attach the cell to almost any surface.

All cells are 100% checked before shipping. With proper care they will last indefinitely (some have been used daily in International Rectifier Photocell Labs for over 12 years and are as good as new). However, cells are not guaranteed against damage through rough handling, moisture or excessive heat.

How Much Power Can You Get From Sun Batteries?

There is no limit to the amount of electricity you can produce from sunlight. The more cells you use, the more power you get. Just remember that you increase the voltage by connecting the cells in series, as shown in Figs. 5 and 7. If you make the connection in parallel, you increase the current (amperage). Cells may be put in parallel and in series to get more voltage and more current.

How To Get The Maximum Power From The Cells

Some applications, such as operating a relay or a motor make it necessary to get maximum cell efficiency. To do this, you must "match the load to the cell." With a silicon cell, operated in sunlight, the load (relay coil, etc.) should be in the 15-25 ohm range. For selenium cells, 75 to 125 ohms is most efficient. When you put cells in series, the load resistance should go up proportionately. If, for instance, you use three S1M sun batteries, the best value for your load will be about 50 to 70 ohms. Types S3M and S5M sun batteries contain 2 cells, wired in series.

EXPERIMENT WITH MOTORS

One of the most effective demonstrations of the use of power from the sun can be given by driving a small DC motor directly from a sun battery.

Suitable motors are the International Rectifier Corp., type EP-50, and the Aristorev type #1. Two S1M, or one S3M or S5M cells will drive these motors nicely. They are available through most hobby shops.

A cardboard or foil disc, using some imaginative designs and glued to the shaft of the motor, will make a very fine demonstration.

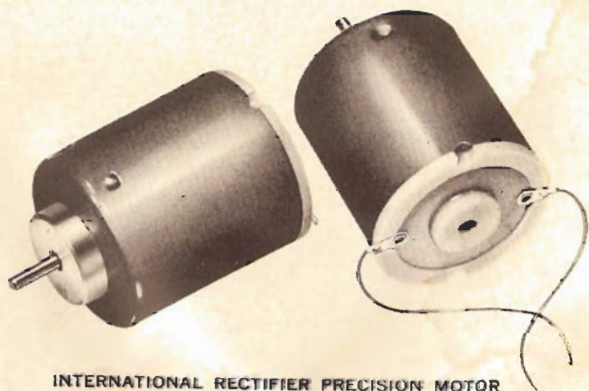

INTERNATIONAL RECTIFIER PRECISION MOTOR
TYPE EP-50 (shown approximately full size)

PRICE \$3.95

SPECIFICATIONS

FOR INTERNATIONAL RECTIFIER
EXPERIMENTER TYPE CELLS.

Cat. No.	Description and Size	OUTPUT*		Net Price
		Volts	MA.	
B2M	Selenium cell with mounting bracket. Cell size $1/2'' \times 3/4''$	$1/3$ to 0.4	2	\$1.50
B3M	Selenium cell in molded plastic case, Case Dim. $1 1/8'' \times 1 1/8'' \times 3/16''$	$1/3$ to 0.4	$1 1/2 - 2 1/2$	1.75
S1M	Silicon cell in molded plastic case, Case Dim. $1 1/8'' \times 1 1/8'' \times 3/16''$	0.3 to 0.45	10-16	2.25
S3M	Selenium cell contains 2 elements in series, therefore doubling voltage. Same size as S1M	0.6 to 0.85	10-16	3.95
S5M	Same as S3M but extra-high efficiency type	0.6 to 0.85	18-25	4.95
CS-120	Cadmium Sulphide cell, $1 1/8'' \times 1 1/8'' \times 3/16''$. Maximum voltage 120V AC or DC. 0.2 Watt Maximum Power Dissipation. Resistance: 200 OHM to 1.5 Megohm, Dep. on Illumination			2.35

* In full sunlight, using conventional volt and milliamp meters.

The B2M, B3M, S1M and CS 120 Cells are carried by your dealer. Extra-High-Efficiency types S3M and S5M can be obtained on special order through your dealer.

Actual size of all cells listed, except B2M

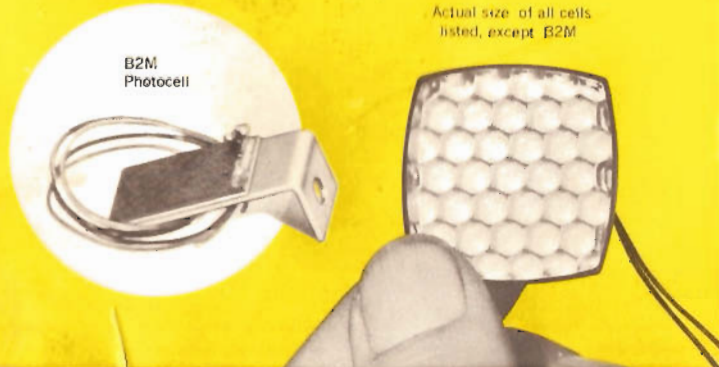

B2M
Photocell

NOW! It's easy and fun
to build your own

Solar Powered Transistor Radio!

Two new
International Rectifier
Kits feature space-
satellite solar cells —
the most efficient
circuit ever designed and
handsome, unbreakable
plastic cases.



No Tools Required — No Soldering!

It's a cinch to put together this portable radio that will be a constant companion day or night. Powered from the sunshine in daytime...from batteries at night! A flick of the switch changes from solar power to pen-light batteries for hours of listening. Choose from personal ear-phone type or speaker type...both transistorized...both radios that you will be proud of!

See These Kits at Your Dealer's!

International Rectifier Corporation
El Segundo, California