

**BUILD—\$10 Experimenters' IC decimal readout**

60c ■ NOV. 1968

# Radio IND Electronics

TELEVISION • SERVICING • HIGH FIDELITY

A  
**GERNSBACK**  
PUBLICATION

**R-E EXCLUSIVE...**

**Make Go-Go Music—**

**Build 8 solid-state instruments**

**SPECIAL REPORT  
TV X-RAYS  
One Year Later**

**Portable Tach  
for your shop**

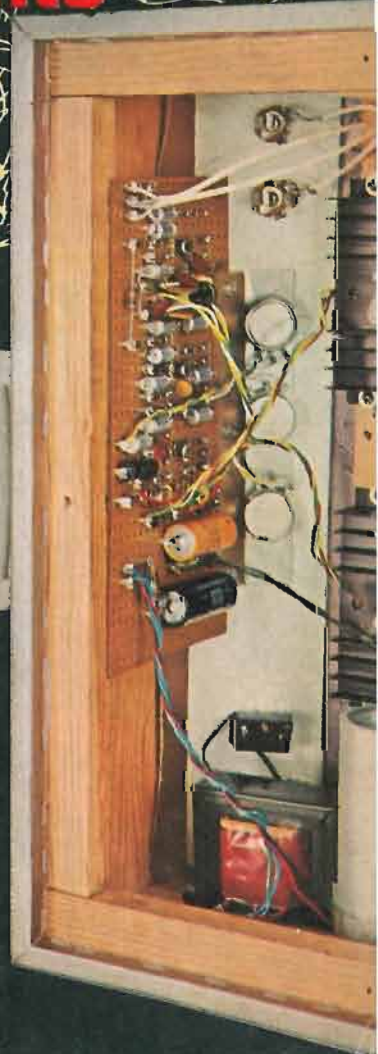

# This is more amplifier than you may think you need.

## But after you see the price, why settle for less.

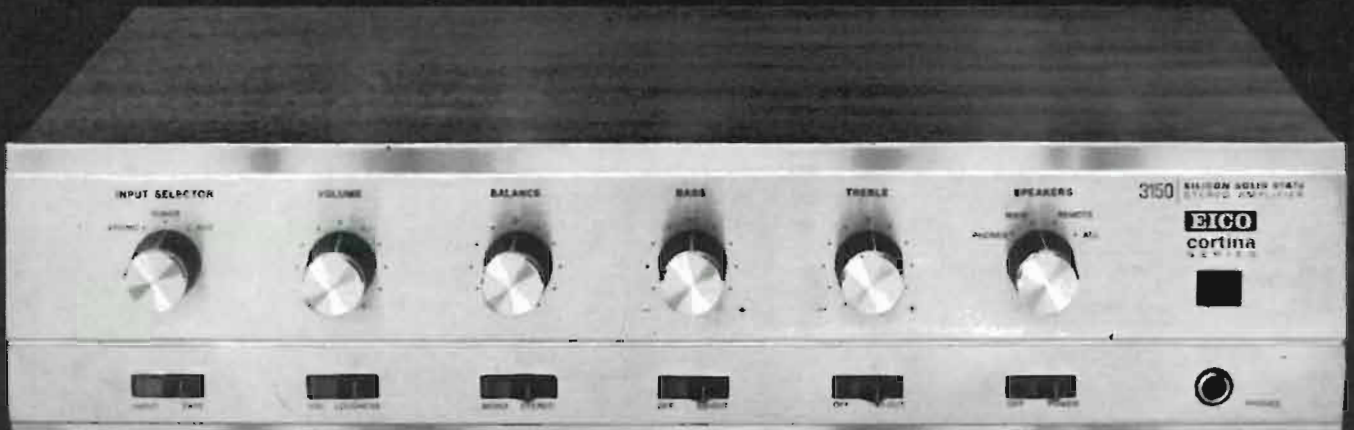

The EICO "Cortina 3150" all-silicon solid-state 150 watt stereo amplifier is truly a lot of amplifier. It combines wide-range preamplifiers, controls, and power amplifiers, all on one uniquely compact chassis. It delivers clean power to two sets of speaker systems, stereo headphones (for which there is a jack on the front panel) and a tape recorder. The Cortina "3150" gives you complete control facilities.

Most people think that, while all this would be very nice to have they don't want to pay a lot of extra money for it.

We agree. That's why we designed the "3150." Fully wired it costs \$225.00. If you want to buy it as a kit — and it is a particularly easy kit to assemble because of our advanced modular circuitry techniques — It's a mere \$149.95. The beautiful Danish

walnut vinyl clad cabinet is included at no additional cost. At these prices, the "3150" is no longer a luxury. It's virtually a necessity. The power delivered by the "3150" is enough to give faithful reproduction of the highest peaks in music even when it is used with inefficient speaker systems.

The "3150" gives you more than just power. With both channels driven the harmonic distortion is less than 0.1%, IM distortion is less than 0.6%, frequency response is  $\pm 1.5$ db, 5Hz to 30 KHz, all at full output, hum and noise 75db below rated output; channel separation is more than 50db; input sensitivity is 4.7MV at magnetic phono input, 280MV at all other inputs.

Phase shift distortion is negligible due to the differential amplifier input circuit and the transformerless driver and output

circuits. All electronic protection (no fuses) of output transistors and speakers makes overloads and shorts impossible.

The "3150" also provides ten versatile control facilities: volume, balance, full range bass and treble controls. Input Selector (phono, tuner, aux), tape monitor, loudness contour, low and high cut filters, and speakers system selector switches.

See and hear this most advanced of all silicon solid-state amplifiers at your EICO dealer. We are confident it will quickly change your mind as to how much amplifier you really need.

**cortina by EICO**  
Designed, manufactured in U.S.A. and guaranteed by EICO.

### See the complete Cortina® Line at your EICO Dealer.



"The EICO Cortina Series are low-cost audio components that look and sound like high cost components."

Popular Science Magazine.

**Cortina 3070** a full capability 70-Watt All Silicon Solid-State Stereo Amplifier for \$99.95 kit, \$139.95 wired, including cabinet.

**Cortina 3200** Solid-State Automatic FM Stereo Tuner for \$99.95 kit, \$139.95 wired, including cabinet.



**Sound n' Color** is an exciting innovation in the home entertainment field. It adds a new dimension to your musical enjoyment. See the music you hear spring to life as a vibrant, ever shifting interplay of colors.

See every tone, every note, every combination of instruments create its own vivid pattern. EICO Model 3440—Kit \$49.95, Wired \$79.95.

Circle 7 on reader's service card



**Cortina 3570** 70-Watt All Solid-State FM Stereo Receiver for \$169.95 kit, \$259.95 wired, including cabinet.

Pre-assembled and pre-aligned front end, multiplex, and IF circuits speed and simplify assembly — you'll enjoy building this deluxe kit.

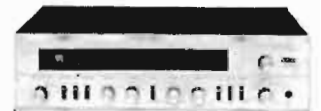

**New Cortina 3770** 70-Watt All Solid-State AM/FM Stereo Receiver for \$189.95 kit, \$279.95 wired, including cabinet.

EICO Electronic Instrument Co., Inc.  
283 Malta Street, Brooklyn, N.Y. 11207

- Tell me where I can have a free Cortina demonstration.
- Send me free 32-page catalog on EICO's 200 "best-buys."

Name \_\_\_\_\_  
Address \_\_\_\_\_  
City \_\_\_\_\_  
State \_\_\_\_\_ Zip \_\_\_\_\_

# Success in Electronics Comes as Naturally as 1-2-3 through Education

There they are — three big steps — three deliberate steps which lead directly to success in electronics. Your future is shaped by the moves *you* make — by the steps *you* take. Begin now with Step #1.

**STEP #1** is a simple request for full information on the Grantham Associate Degree Program in Electronics. You take this step by filling out and mailing the coupon. We mail our catalog to you; we do not send a salesman.

**STEP #2** is earning your FCC first class radiotelephone LICENSE and radar endorsement. You complete this step in the first two semesters of the Grantham educational program (by correspondence or in residence). Train with the school which gives associate-degree credits for your license training, offering you the opportunity to advance beyond the FCC license level to a college degree in electronics.

**STEP #3** is earning your ASEE DEGREE. This degree is conferred when you have earned credit for all six semesters of the Grantham curriculum.

The Grantham Associate Degree Program offers in-depth technical education, and prepares you for employment as an *engineering* technician—a big step above an ordinary technician. (Most of our students are already technicians when they begin the course.) Engineering technicians usually work directly with scientists and engineers, analyzing and solving engineering problems. *You can make more money as an engineering technician!*

## Accreditation, and G.I. Bill Approval

Grantham School of Electronics is *accredited* by the Accrediting Commission of the National Home Study Council, and is *approved* for both correspondence and resident training under the G.I. Bill. Just mail the coupon, or write or telephone us for full information without obligation.

## Grantham School of Electronics

1505 N. Western Ave.      818 18th Street, N.W.  
Hollywood, Calif. 90027      or      Washington, D.C. 20006

Telephone:  
(213) 469-7878

Telephone:  
(202) 298-7460

1

**Grantham School of Electronics** RE 11-68  
1505 N. Western Ave., Hollywood, Calif. 90027

Please mail me your free catalog, which explains how Grantham training can prepare me for my FCC License and Associate Degree, in electronics. I understand no salesman will call.

Name \_\_\_\_\_ Age \_\_\_\_\_

Address \_\_\_\_\_

City \_\_\_\_\_ State \_\_\_\_\_ Zip \_\_\_\_\_

2



3

## Grantham School of Electronics

has conferred on

**John Doe**

the degree of

Associate in Science in Electronics Engineering

with all the rights and privileges thereunto appertaining. In witness thereof this diploma duly signed has been issued by the School Administration upon recommendation of the faculty at the School on this

first day of October, 1968.



*D.J. Grantham*  
President  
*E. Whittier*  
Assoc. Dean

# LOOKING AHEAD

By **DAVID LACHENBRUCH**  
CONTRIBUTING EDITOR

## 'New' color tubes

A 21-inch (viewable diagonal) shadow-mask color tube which has proved popular in Europe is being introduced in the U.S. and Canada. Manufactured by Philips Lamp Works of the Netherlands, it differs from American 20-inch tubes in shape and contour, although its total viewing area is almost exactly the same. The new tube has a very square-cornered screen and a flatter face than American types. In addition, its aspect ratio (height-by-width) more closely approaches the 3-by-4 dimensions of home slides and movies than does the 4-by-5 ratio of most picture tubes. The new tube is featured in two sets made by Electrohome of Canada; demonstrations to U.S. television set manufacturers had just begun at press time.

General Electric's pioneer mini-color 10-inch picture tube has been redesigned to produce a picture sharper, brighter and more contrasty than its predecessor, which has been in service for more than three years. Resolution has been enhanced by increasing the number of aperture-mask holes per square inch to 1820 from 1080, and reducing phosphor dot size to 14.7 from 18.7 mils. A higher-contrast faceplate and brighter rare-earth phosphors have been added, along with a new electron gun. The in-line gun configuration has been retained. The new tube is physically and electrically interchangeable with the older version.

## Taped music boom

Prerecorded music on tape is now becoming an important medium, and in terms of retail dollar volume it could be close to one-quarter the size of the phonograph record market this year. Ampex Stereo Tapes, which duplicates and distributes recorded tape, has raised its estimate of the 1968 market by 50% to \$250 million from its previous forecast of \$160 million.

The growing circulation of 8-track automobile stereo players is largely credited for the increase in sales. Ampex's estimates now indicate that 8-track cartridges alone will sharply exceed \$160 million in sales this year, with 4-track cartridge sales running about the same as last year's \$27 million, and reel-to-reel tapes declining a modest 5% from 1967 to \$19 million. Sales of pre-recorded tape in the 2-reel cassette format is not a serious factor yet, according to Ampex.

It's estimated that as many as three million 8-track tape players will be in use by the end of 1968, tripling the number in a single year. Most of them probably will be in automobiles, but sales of both home and battery-operated portable players are said to be rising. Although cassette recorder sales are picking up at an even faster pace, the principal use of the cassette machine so far is as a portable recording medium, while the 8-track cartridge unit—which can't record—relies solely on pre-recorded material.

Last year's recorded tape sales totaled about \$160 million. Phonograph record sales in 1967 exceeded \$1 billion.

While we're on the subject, the output of phonograph records has increased so rapidly that just keeping

up with new releases would be a full-time job. If you spent eight hours a day, six days a week listening to every one of the 7,231 single discs and 4,328 LPs issued in the United States in 1967, it would take you exactly a year. (With Sunday off to replay favorites.)

## Electronics vs. noise

Already beset by the radar speed trap, the careless motorist soon will have another worry—the electronic noise trap. Seeking a method to establish legal evidence of violations of its antinoise-pollution law, the state



of Connecticut has awarded a \$69,000 contract to CBS Laboratories to develop a vehicle noise detector-recorder whose readings will stand up in court

and provide positive identification of offenders.

CBS Labs' design is for a suitcase-sized device that can be operated from a police car at roadside. A recording decibel meter makes a chart of the noise level of a passing vehicle. If the volume exceeds the legal limit, a camera snaps a picture of the offending vehicle's license plate and, on the same frame, a photo of the chart. The resulting split-screen photograph, in the opinion of the state's legal authorities, will be lawyer-proof.

## Q-&A via FM

You soon will be able to take courses at home from an FM set you can answer back to—and it will tell you whether your answer is right or wrong, and why. A new firm, Educating Services Inc., has already tested such a system with approval of the FCC and now says it is ready for large-scale home teaching operations.

Educating combines programmed learning techniques with teaching-by-radio. When a student signs up for a home study course, he receives his regular lesson books plus a special leased radio (the first 10,000 units have already been built by Sylvania). The fix-tuned FM set has four pushbuttons. With button number one depressed, the student hears the instructor give his lecture—and ask questions. The student can select one of three possible answers by pushing button number two, three or four. After he chooses and presses the answer button, he hears the instructor's voice tell him whether his answer was right or wrong and why. Button one then restarts the lesson.

Educating courses can be broadcast by any FM station without interfering with regular monophonic programming. The system makes possible the simultaneous transmission of four multiplex subcarriers, one for each of the pushbutton channels, in addition to a regular entertainment program. The special receiver picks up only the multiplex subcarriers. In the studio, a four-track tape feeds lessons to the four subcarriers. **R-E**

# Radio-Electronics

November 1968 • Over 60 Years of Electronics Publishing

## EDITORIAL

- X-Rays One Year Later ..... **32** ..... Larry Steckler  
 X-Rays And Your Color Set ..... **32**

## BUILD ONE OF THESE

- Go-Go Guitar Amplifier ..... **37** ..... Jack Jacques  
*For the musically inclined*
- Aircraft Weather Receiver ..... **42** ... Lauren A. Colby  
*Inexpensive AM tuner conversion*
- Phototach For Your Shop ..... **46** ..... Brice Ward  
*A neat trick to measure rpm*
- Build a \$10 Experimenter's  
 IC Decimal Readout Module ..... **60** ..... Ralph Genter  
*Building block for a digital voltmeter*

## TELEVISION

- In The Shop . . . With Jack ..... **24** ..... Jack Darr
- Service Clinic ..... **27** ..... Jack Darr
- Simple Detector Spots TV X-Rays ..... **33** .. Richard K. Stoms  
*An instrument used by professional X-Ray hunters* and Edward Kuerze
- The Case of the Mysterious Glitch-Hausen ... **36** ..... Jack Darr  
*TV troubles can be catching?*
- Solid-State Rectifier Repairs ..... **52** ... Matthew Mandl  
*Expert tips on semiconductor problems*
- Equipment Report: B & K 465 CRT Tester .... **88**

## AUDIO

- Curtain of Sound ..... **13** .... Winston Tharp  
*Where to put those microphones*
- What's New In FM Tuners ..... **50** ... Peter E. Sutheim  
*No-gain front ends and 100 dB rejection*

## GENERAL ELECTRONICS

- Looking Ahead ..... **2** .David Lachenbruch  
*Current happenings with future overtones*
- Look What They're Doing With Electrosleep .. **44** .L. George Lawrence  
*Tuning in on dreams*
- Electrons and Magnetic Fields ..... **70** . James G. Holbrook  
*An easy rule to predict electron motion*

## DEPARTMENTS

- |                      |           |                                  |           |
|----------------------|-----------|----------------------------------|-----------|
| Correspondence ..... | <b>16</b> | New Products .....               | <b>77</b> |
| New Books .....      | <b>99</b> | News Briefs .....                | <b>4</b>  |
| New Literature ..... | <b>81</b> | New IC's and Semiconductors..... | <b>92</b> |
|                      |           | Noteworthy Circuit .....         | <b>98</b> |
|                      |           | Readers Service .....            | <b>74</b> |



Build a 10-watt guitar amplifier. First of an exclusive eight-part R-E series. See page 40 for more projects to come.

starts on page 37



Convert AM tuner for aircraft and weather reception. see page 42

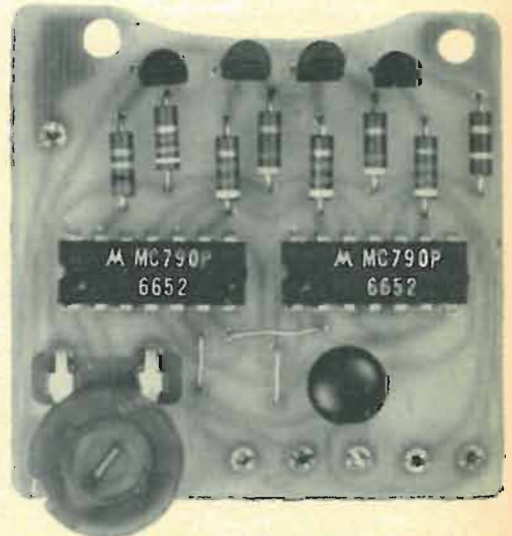

Decade counting module. A decimal readout that uses three IC's and costs only \$10.

see page 60

RADIO-ELECTRONICS, NOVEMBER 1968, Volume XXXIX, No. 11  
 Published monthly by Gernsback Publications, Inc., at Ferry St., Concord, N. H. 03302  
 Editorial, Advertising, and Executive offices: 200 Park Ave. S., New York, N.Y. 10003. Subscription Service: Boulder, Colo. 80302.  
 Second-class postage paid at Concord, N. H. Printed in U.S.A. One-year subscription rate: U.S. and possessions, Canada, \$6.  
 Pan-American countries, \$7. Other countries, \$7.50. Single copies: 60¢. ©1968, by Gernsback Publications, Inc. All rights reserved.  
 POSTMASTER: Notices of undelivered copies (Form 3579) to Boulder, Colo. 80302.



Member,  
 Institute of High Fidelity.  
 Radio-Electronics is indexed in  
*Applied Science & Technology  
 Index (formerly Industrial  
 Arts Index)*

# NEWS BRIEFS

## Low-Cost 8mm Sound Movie System



New camera system announced by Bell & Howell puts lip-sync sound in 8-mm home movies. The new Film-sound 8 system coordinates camera and projector with a portable cassette recorder that tapes sound accompanying the filming and plays back during projection. The cassette machine records and plays 4-minute tape cassettes, the filming time for a standard super 8 cartridge.

During filming, sounds from the microphone are recorded magnetically on the audio track of the cassette tape while an 18-frame-per-second pulsed signal is recorded on the synchronous control track of the tape. The pulsing signal serves as a speed control for the projector, keeping both picture and sound in frame-by-frame sync.

The complete system consists of the Autoload 442 camera (\$159.95), Autoload 458 projector (\$169.95) and Filmsound 450 recorder (\$99.95).

### DEAFENING MUSIC?

The guinea pig says yes. Tests at the University of Tennessee subjected a guinea pig to go-go music recorded at a local discotheque, played at high levels (120 db) to duplicate the sound level of the discotheque. After 88 hours of listening, spread over a three-month time, the sound-sensitive cells in the guinea pig's ears began to deteriorate.

True, guinea pig ears are not human ears, but there is some evidence

that there is a connection. A recently completed study at the University of Tennessee revealed an unusually high proportion of students with measurable hearing loss. The hearing of many freshman students had already deteriorated to a level of the average 65-year-old person.

### MOTH JAMMING

Electronic sensors in the antennae on this night-flying *Cecropia* moth are remarkably similar to the radar detectors first used in World War II. Instead of reacting to radar, however,



American Institute of Physics

the detectors are so microscopically small (0.0026" long and 0.00026" in diameter) they are sensitive to light waves. This property was discovered by Dr. Philip S. Callahan, a U.S. Department of Agriculture scientist, during studies to find a signal that would attract the crop-damaging corn earworm moth. The scientist found that moths drop to the ground as a defense when exposed to light because the light-sensitive detectors "short circuit" their antennae, blocking impulses from several other sensory antenna spines. Dr. Callahan reported his findings in the publication, *Applied Optics*.

### TRANSISTORS ON PAPER

This array of 100 tellurium transistors deposited on a playing card may be the forerunner of mass-produced semiconductors costing a penny each or less. Experimentally produced in Westinghouse labs, these thin-film flexible transistors have been formed on a variety of substrate materials. They have stable operating charac-



teristics and have worked at 60 MHz. Over 600 of the devices can be deposited in a one-square-inch area. Although commercial applications are several years off, the devices should greatly reduce the costs of toys, novelties, hobby kits, teaching aids and other items where high power, high temperature, and very high frequencies are not present. The company also predicts applications of highly flexible electronic circuits.

### EYES FOR SPACE

Four viewing methods to permit future spacecraft crews to see earth during reentry are under test by NASA pilots. This system, produced by Kollsman Instrument Corp., mounts in a

# There's nothing wrong with the set.

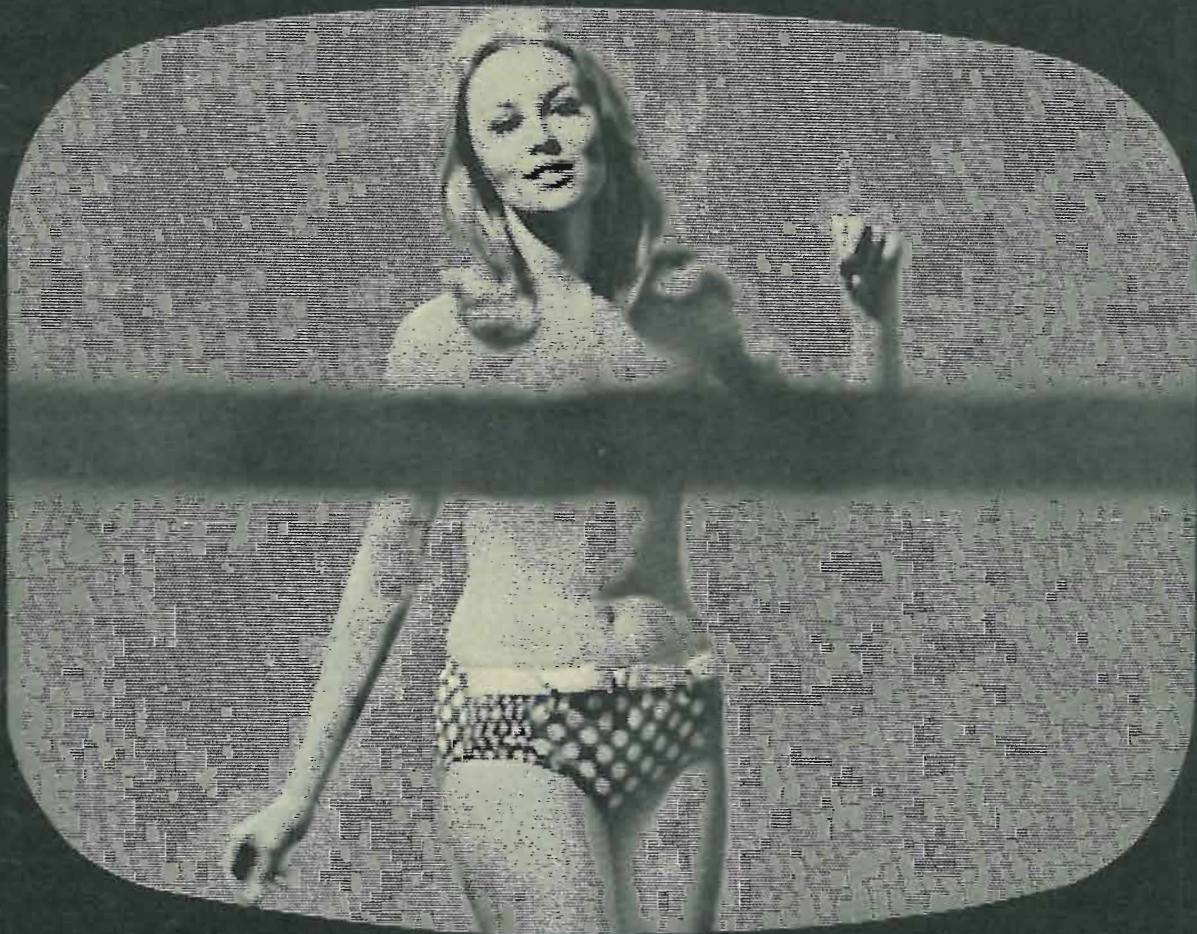

You fixed the picture a week ago, now you're back repairing your repair job. And paying for it.

Replacement parts are supposed to last longer than that.

Like electrolytic capacitors. If they're wound in computer-grade, 99.99% pure aluminum foil, they'll hold up for a long time at continuous temperatures of 85 C.

Like Arcolytic capacitors do.

Even though they cost the same as any other home entertainment capacitor. And come in more than 2000 exact replacement values to maintain the set's stability.

Any Arcolytic distributor can fill you in on the whole line of

Arcolytic types—twist mounts, printed circuit twist mounts, tubular electrolytics (including very high capacitance values) and miniature tubulars in the smallest physical sizes. He can also sell you Elmenco capacitors.

Then you won't have to do repair jobs twice. If the lady in the set seems to be missing something, a week after you've done a repair job, it's her problem. Not yours.

## **Loral Distributor Products**

A DIVISION OF LORAL CORPORATION  
Pond Hill Industrial Park, Great Neck, New York 11022

*Circle 9 on reader's service card*

# Serious Disagreement on Quam Baffles

Perplexes Sound Industry Experts!

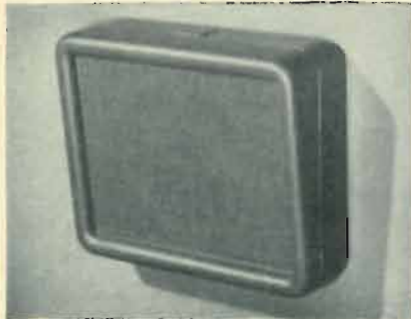

Molded of rugged polystyrene, blonde or walnut finish. Easy installation; just hang it on the wall! (Wall bracket supplied.)

**Chicago, 1968**—Agreeing unanimously that Quam baffles are tops, leading sound experts differ sharply on why. Some credit the sound (exceptional low end response). Others like the modernistic, unobtrusive design. One vociferous group hails the low price, while another segment praises the ease of installation.

## Value Unquestioned

Asked to referee the raging debate, a factory spokesman declared, "The best reason for choosing Quam baffles is *value*. Whether the emphasis is on good looks, good performance, or good construction—not to mention good sound—Quam buyers know they get their money's worth!"

## Choice of Speakers



The baffles are available if desired with speakers (and transformers) premounted. Any of 10 Quam 8" background music, public address, or outdoor speakers can be selected. There is no charge for the mounting. You pay only for the components themselves.

Complete information about Quam baffles and speakers is available from the factory,

Quam-Nichols Company,  
234 E. Marquette Rd.  
Chicago, Illinois 60637.

Circle 10 on reader's service card



helicopter and lets pilots compare the effectiveness of an optical system, simulated fiber optics, color and black-and-white TV.

## GIANT STEP IN GLASS TO METAL BONDING

Glass to metal seals have always been a problem. When the two materials to be sealed are placed on top of each other they normally touch at only a few points even if their surfaces are optically polished. But a new bonding process, discovered and developed by P. R. Mallory scientists solves this problem. Here's how it works.

The bond is formed by placing a flat piece of insulating material such as glass on a flat piece of metal. The sandwich is heated to a temperature well below the softening point of the glass and a dc potential is applied, for a short time, across the glass-metal sandwich. In most instances the glass

(continued on page 12)

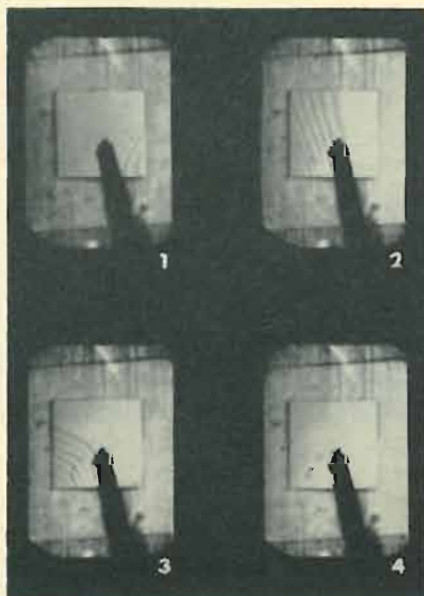

Series of micro-graphs show the bonding of a piece of flat glass to a piece of flat silicon. The bonded area (beginning in photo 1) moves across the chip in a wave-like motion behind the light interference fringes—seen as dark wavy lines.

6

# Radio - Electronics

HUGO GERNSBACK (1884-1967)  
founder

M. HARVEY GERNSBACK,  
editor and publisher

LARRY STECKLER, managing editor

Robert F. Scott, W2PWC

senior technical editor

John R. Free, associate editor

Jack Darr, service editor

I. Queen, editorial associate

Matthew Mandl, contributing editor

David Lachenbruch, contributing editor

Bruce Ward, production manager

Sandra Esteves, production assistant

G. Aliquo, circulation manager

Cover by Harry Schlack

RADIO-ELECTRONICS is published by Gernsback Publications, Inc.  
200 Park Ave. South  
New York, N.Y. 10003  
(212) 777-6400

President: M. Harvey Gernsback  
Vice President-Secretary: G. Aliquo

## ADVERTISING REPRESENTATIVES

### EAST

John J. Lamson, Eastern Sales Manager

### MIDWEST/N.&S. Car., Ga., Tenn.

Robert Pattis, the Bill Pattis Co., 4761 West Touhy Ave., Lincolnwood, Ill. 60646  
(312) 679-1100

### W. COAST/Texas/Arkansas/Oklahoma

J. E. Publishers Representative Co., 8380 Melrose Ave., Los Angeles, Calif. 90069,  
(213) 653-5841; 420 Market St. San Francisco, Calif. 94111, (415) 981-4527

### UNITED KINGDOM

Publishing & Distributing Co., Ltd., Mitre House, 177 Regent St., London W.1, England

**SUBSCRIPTION SERVICE:** Send all subscription correspondence and orders to RADIO-ELECTRONICS, Subscription Department, Boulder, Colo. 80302. For change of address, allow six weeks, furnishing both the old and new addresses and if possible enclosing label from a recent issue.

**MOVING?** Or writing about subscription? Be sure to fill out form below.

For FASTEST service on address change, missing copies, etc., attach old mailing label in first space below. Otherwise please print clearly your address as we now have it.

OLD ADDRESS (Attach old label if available)

Name .....

Address .....

City ..... State .....

Zip Code .....

### NEW ADDRESS

Name .....

Address .....

City ..... State .....

Zip Code .....

Mail to: RADIO-ELECTRONICS  
Subscription Dept. Boulder, Colo. 80302



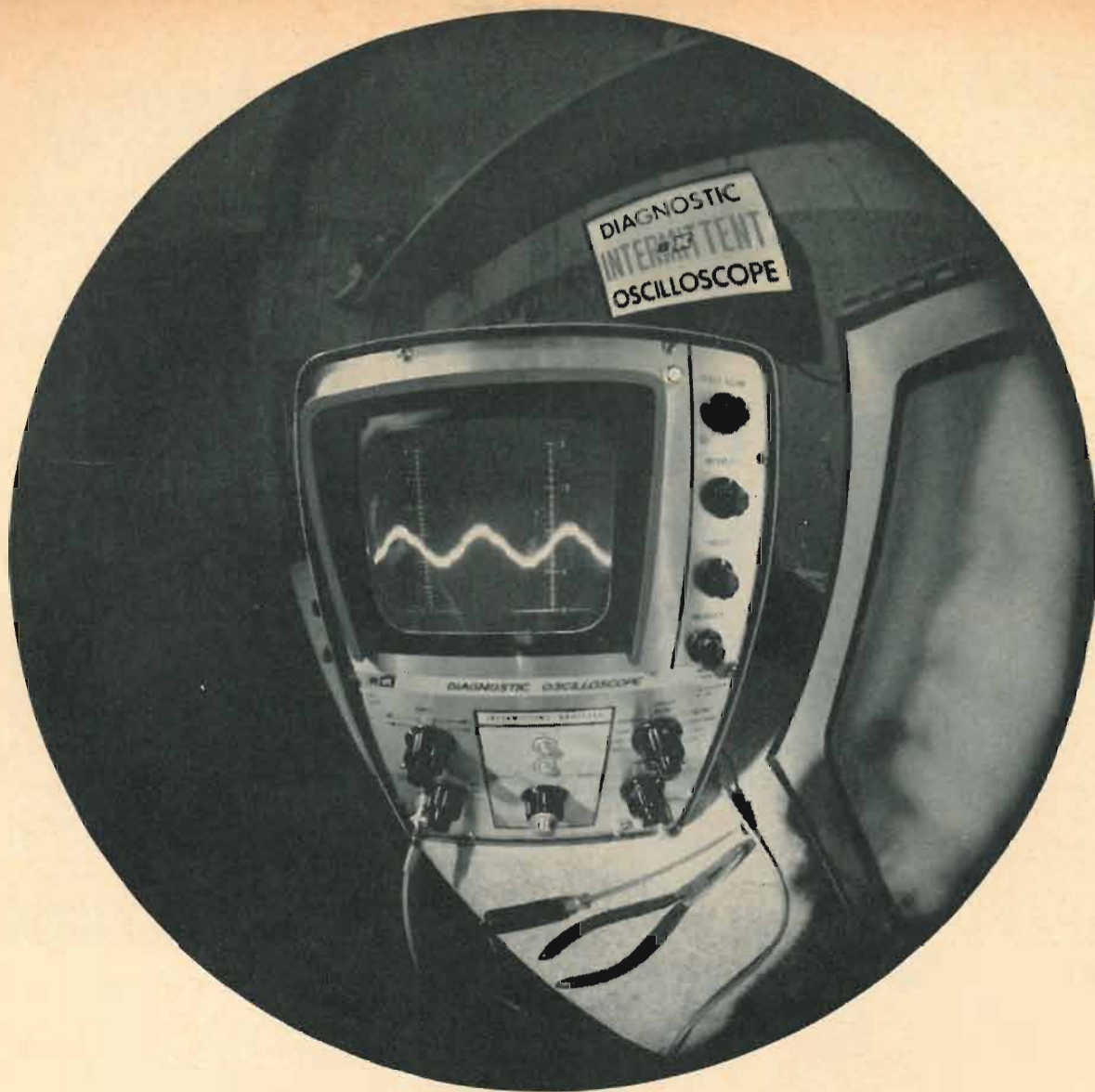

## Another benchwarmer?

Not this one. Our new B&K Diagnostic Oscilloscope is more than re-engineering of an old model to keep pace with TV technology. It is instead a basic departure from all other oscilloscopes. A departure that has simplified a complex instrument to make it easier for you to use. But there's something else.

What this oscilloscope has is exclusive. An Intermittent Analyzer with electronic memory—and optional remote Audio/Visual Alarm.

With it, the elusive intermittent conditions that make so many TV sets tough dogs can now be detected and identified in your absence. Preset one control.



When the faulty stage is detected, you'll know about it as soon as you come back from service calls. Then run the scope overnight to check another set for an intermittent condition.

All this adds up to greater shop efficiency, more time for profit-making service calls and a lot more mileage out of a very fine diagnostic oscilloscope.

An oscilloscope that shows vector patterns exactly as specified by color TV manufacturers. (All vectorscope inputs and controls are conveniently located on the front panel.) Also allows you to read peak-to-peak voltages in all ranges on a double-scale calibrated screen—just by turning a switch. (As the range is selected, the appropriate scale lights automatically.)

*Circle 11 on reader's service card*

Automatic synchronization locks in all patterns at any signal level or frequency. There are also fewer controls and these are positioned for easier operation.

Give our Diagnostic Oscilloscope some thought. It's worth it not to be sidelined with a benchwarmer. See your B&K Distributor or drop us a note for detailed literature on Model 1450 and our full-line test equipment catalog, AP-24.

**DIAGNOSTIC OSCILLOSCOPE**  
Model 1450, Net: \$279<sup>95</sup>



*B & K Division of DYNASCAN CORPORATION*  
1801 W. Belle Plaine • Chicago, Illinois 60613  
*Where electronic innovation is a way of life.*

# NRI "hands-on" training in TV-Radio, Electronics can give you as much as 2 years of on-the-job experience.

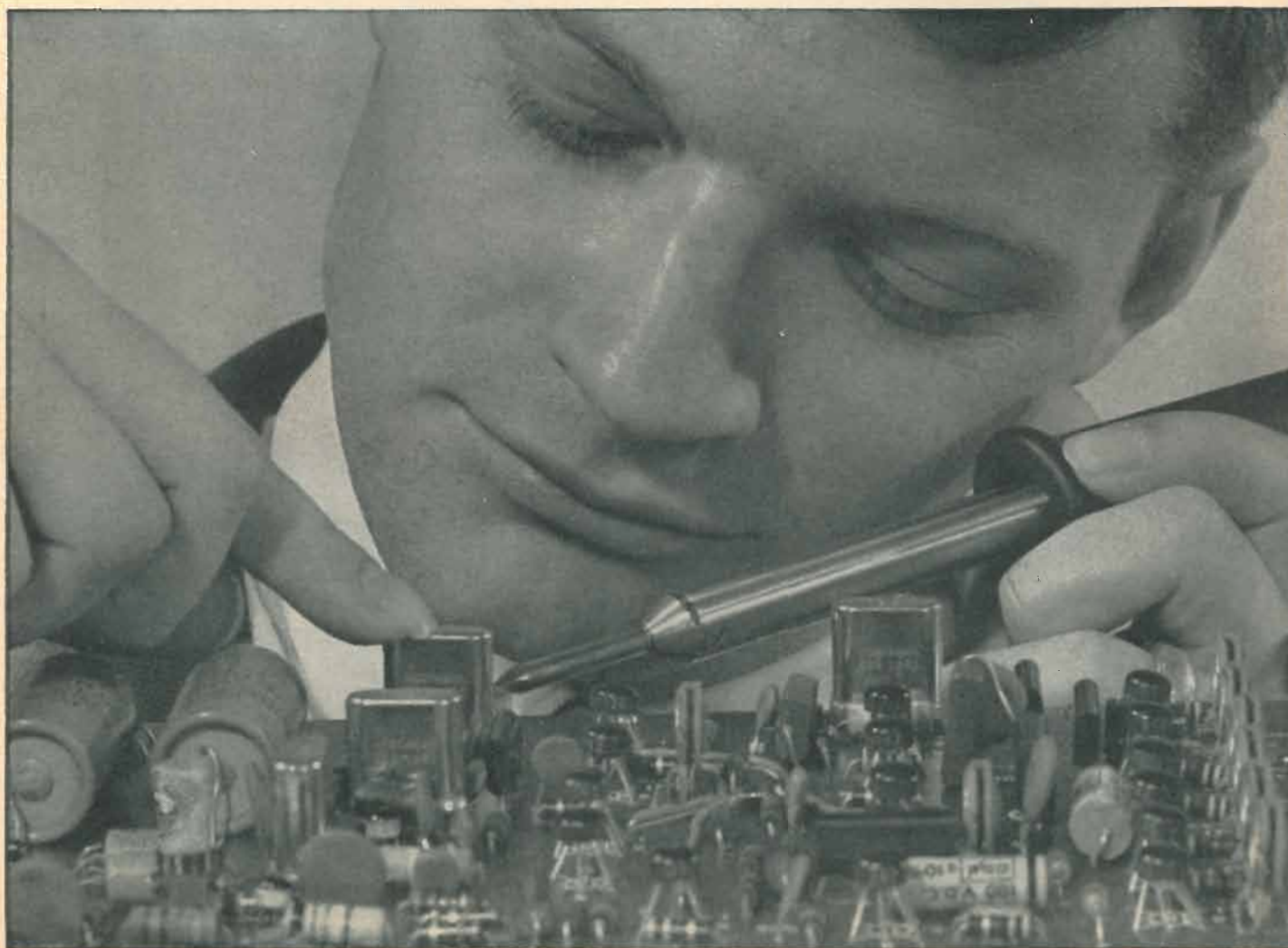

## EARN YOUR FCC LICENSE – OR YOUR MONEY BACK

NRI Communications training programs will qualify you for a First Class Commercial Radiotelephone License issued by the FCC. If you fail to pass the FCC examinations for this license after successfully completing an NRI Communications course we will, on request, refund in full the tuition you have paid. This agreement is valid for the period of your active student membership and *for six months* after completion of your training. No school offers a more liberal FCC License agreement.

# Experience is still your best teacher



**NRI Achievement Kit** is educator-acclaimed and the original "starter" kit in home study training. Imitated but never duplicated, this kit is designed and personalized for you and your training objective. It has one purpose — to get you started quickly and easily.



**"Bite-Size" Texts** average an easily-digested 40 pages of well-illustrated, scientifically prepared subject matter in the course of your choice. Questions in each book are carefully hand-graded and returned to you with helpful instructional notes. You get unlimited personal help from the day you enroll.



## Designed-For-Learning Equipment

Like this phone-cw transmitter (Kit #7 in the Communications course) is engineered from chassis up to demonstrate principles you must know. NRI does not use modified hobby kits for training, but the finest parts money can buy, professionally and educationally applied.

*...here's how you get it with unique NRI training at home*

Ask any teacher, job counselor, engineer, technician or prospective employer about the need for practical application of theory in Electronics. He'll tell you Electronics is as much a "hands-on" profession as dentistry or chemistry. That's how you learn at home with NRI. You prove the theory you read in "bite-size" texts, by actual experimentation with the type of solid-state, transistor and tube circuits you'll find on the job today — *not* hardware or hobby kits. You introduce circuit defects, analyze results, discover quickly the kind of trouble-shooting and design techniques that will make you employable in Electronics.

## Train with the leader — NRI

NRI lab equipment is designed from chassis up for effective, fascinating training — not for entertainment. The fact that end results are usable, quality products is a bonus. In Communications, for example, you build and analyze, stage by stage, your own 25-watt phone/cw transmitter. It's suitable for use on the 80-meter amateur band, if you have an interest in ham radio. In TV-Radio Servicing your practical training gives you your choice of monochrome or color TV sets. All training equipment is included in the low tuition — you pay nothing extra. Discover for yourself the ease, excitement and *value* of NRI training. Mail postage-free card today for new NRI Catalog . . . or use the coupon below. No obligation. No salesman will call on you. NATIONAL RADIO INSTITUTE, Washington, D.C. 20016.

### APPROVED UNDER NEW GI BILL

If you have served since January 31, 1955, or are in service now, check GI line on postage-free card or in coupon.

MAIL THIS COUPON IF CARD IS GONE



### NATIONAL RADIO INSTITUTE

Washington, D.C. 20016

3-118

Please send me your new NRI Catalog. I understand no salesman will call and there is no obligation.

Name \_\_\_\_\_ Age \_\_\_\_\_

Address \_\_\_\_\_

City \_\_\_\_\_ State \_\_\_\_\_ Zip \_\_\_\_\_

Check for facts on new GI Bill

ACCREDITED MEMBER NATIONAL HOME STUDY COUNCIL

(continued from page 6)

should be biased negative with respect to the metal. An electrostatic attraction produced by the application of the dc potential is believed to result in the intimate surface contact required to bond the materials.

Since the bonding temperature is well below the softening point of the glass and the metal both materials remain solid and do not distort.

**SUPER TRANSISTORS**

Using a new laminated construction technology, RCA has developed transistors that can generate 1 MHz signals with a power output of 800 watts. Considerably higher powers and frequencies are expected as the experimental, walnut-size devices are refined. Ultrasonic cutting and glass hermetic sealing are used in the process. Two separate silicon wafers, the emitter-base and base-collector, are fused under heat and pressure into a single monolithic structure.

**FIVE-SIDED TEACHING MACHINE**

A random access audio information retrieval system has been installed by the Ampex Corporation at Oak Park and River Forest High School,



Oak Park, Ill. Five pentagon shaped carrels enable 25 students at a time to listen to instructional material. Each student can select a separate audio program or all may listen to the same lesson. Future phases will extend the system to include random access video instructional material.

At the heart of the system are seven

32-track master tape transports which hold a total of 224 recorded lessons. A complete 15-minute lesson is recorded on each track. Programs are transferred from the master unit to the student buffer at 120 ips and are replayed for the student at 3 ips. Transferring the program takes less than 30 seconds. **R-E**

# Zenith Tubes...

life-tested for greater dependability!

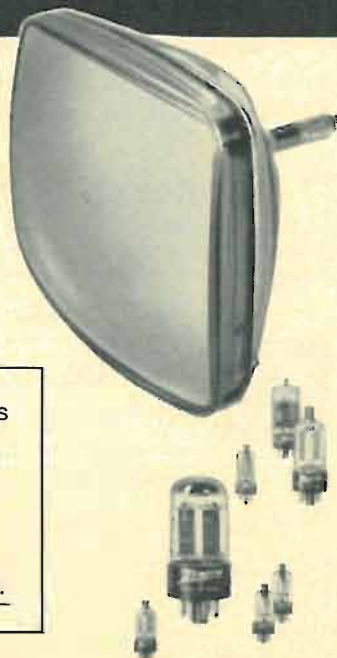

Exciting Surprises  
for You—  
and Your Family!  
Fun for all!  
Get the details  
at your Zenith  
Distributor's  
Parts Department.

**ZENITH TV PICTURE TUBES** are rigorously tested at elevated line voltages for lengthy periods. Zenith's great reliability and long life satisfies your customers better. There are more than 200 Zenith quality tubes for color TV, black-and-white TV, or special purposes.

**ZENITH "ROYAL CREST" CIRCUIT TUBES** undergo over 1½ million hours of life-testing every month. You can count on them for the same unrivaled dependability as Zenith original parts. Choose from a full line of over 900 tubes.

Zenith B&W replacement picture tubes are made only from new parts and materials except for the glass envelope in some tubes which, prior to reuse, is inspected and tested to the same high standard as a new envelope. Some color picture tubes contain used material which, prior to reuse, is carefully inspected to meet Zenith's high quality standards.

Order genuine Zenith tubes from your Zenith distributor

BEST YEAR YET TO SELL THE BEST



The quality goes in  
before the name goes on

# CURTAIN OF SOUND

Get the most out of a stereo recording session—put the mikes in the right places!

By WINSTON THARP

WHEN STEREOGRAPHIC RECORDING WAS first developed, one of the early theories tried was to place a number of uni-directional microphones in front of the musicians. The mikes formed a "curtain" and so did the playback speakers. Soon it was found that good space/sound illusion could be preserved with only two mikes. The only question—how far should they be separated?

Since then, several two-channel systems have been used. The *binaural* arrangement uses directional mikes spaced about 6 or 7 inches apart—approximately the distance between your ears. Playback is through headphones. Obviously 7-inch mike spacing is incorrect for material to be played back through relatively wide-spaced speakers. But how far apart to place the mikes then? A couple of feet might do for a small, three-piece band. A full symphony orchestra, on the other hand, might require 10 feet or more.

Moreover, loudspeaker spacing varies with each home listener. Good miking deals with this.

## Critical stereo angle

To preserve the curtain of sound illusion, it's necessary to construct an imaginary isosceles triangle, with the performers along the base and the listener at the apex. The angle formed by the two equal sides should be between 30° and 45°. The mikes are then placed along the two equal sides and equidistant from the performers.

A bit of elementary trigonometry discloses that for an apex angle  $A$ , width of performing group  $W$ , distance from mike to group  $D$ , and mike spacing  $S$

$$S = W - 2D \tan A/2$$

$$D = (\frac{1}{2} \cot A/2)(W - S).$$

Taking the extreme values of  $A$ , we see that for  $A = 30^\circ$

$$S = W - 0.5358D$$

$$D = 1.86605(W - S).$$

For  $A = 46^\circ$  (a little easier to compute than  $45^\circ$ )

$$S = W - 0.8490D$$

$$D = 1.17795(W - S).$$

For all practical purposes we may approximate these equations. For  $A = 30^\circ$

$$S = W - D/2$$

$$D = 2(W - S).$$

For  $A = 46^\circ$

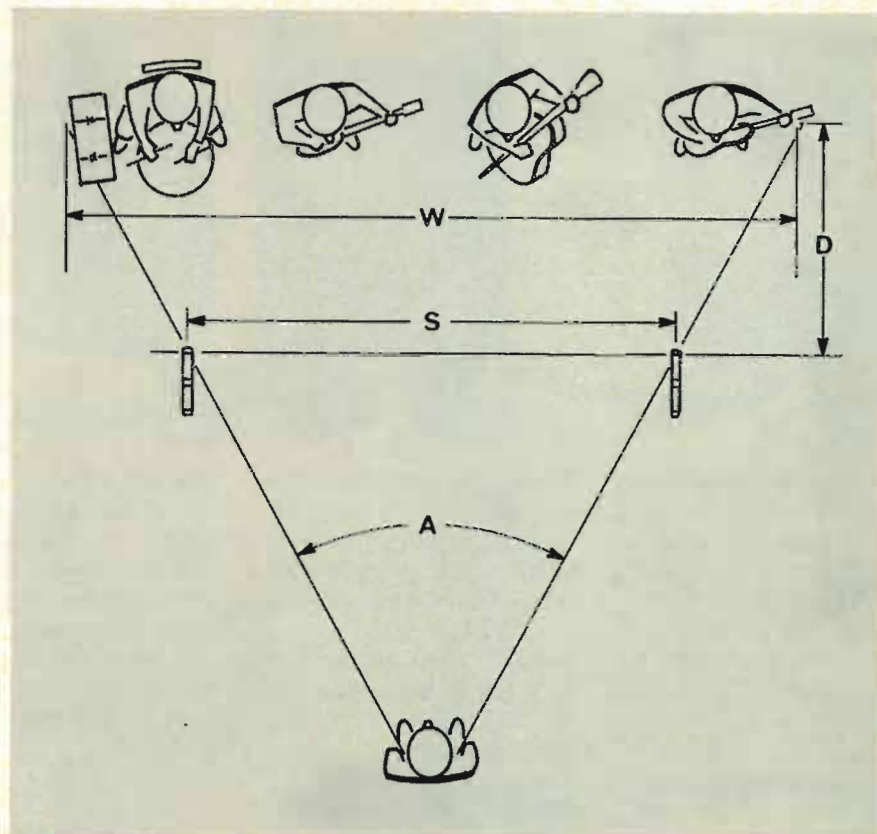

$$S = W - D$$

$$D = W - S.$$

For instance, if the sound source (the musicians) is spread across 10 feet of stage, and you want the mikes within 10 feet, simply plug these values in a formula: For an angle of  $30^\circ$ ,

$$S = 10 - \frac{10}{2} = 10 - 5 = 5$$

Therefore, you would place the mikes 5' apart, 10' from the musicians.

Given a width of performing group and either distance from performers to mikes or mike spacing, you can easily compute the unknown dimension with these formulas. The recordist usually has little control over the width of the performing group. In many instances the distance from group to mikes or mike spacing may be fixed by such factors as availability of mike supports, esthetic considerations (some performers just don't like mikes), or desire on the part of the recordist to minimize audience noise.

Theoretically, the mikes should be spaced 6 to 10 feet apart to match the spacing of the speakers used for playback, but as long as the correct angular relationship is maintained the effect

will be correct. Spacing the mikes closer than 3 feet or farther than 50 feet from each other may result in insufficient or excessive separation due to the time differences of sounds from opposite sides of the performing group hitting the mikes.

The value of angle  $A$  is determined by acoustical conditions and the type of group to be recorded, with the larger angle (and shorter  $D$ ) for recordings emphasizing "presence" and the smaller angle (and longer  $D$ ) more "liveness."

The preceding rules hold for ideal recording conditions. Note, however, that unless good cardioid mikes are used (and possibly even then) mikes will have to be closer than half the total distance from "width" line to apex. Otherwise, room noise and reverberation will probably degrade the recording—certainly the separation.

Remember also that, especially with omnidirectional mikes and in a small room, reproduced stereo may be "off center" because of absorption or reflection from the walls. This is particularly true if the recording setup is asymmetrical. **R-E**

# measure



**The RCA WV-38A** Volt-Ohm Milliammeter is a rugged, accurate, and extremely versatile instrument. We think it's your best buy. Only \$52.00.\* Also available in easy to assemble kit, WV-38A (K).



**The RCA WV-77E** Volt-Ohmyst® can be used for countless measurements in all types of electronic circuits. Reliability for budget price. Only \$52.00.\* Also available in an easy to assemble kit, WV-77E (K).



**The RCA WG-412A** R-C circuit box can help you speed the selection of standard values for resistors and capacitors, either separately or in series or parallel R C combinations. Only \$30.00.\* It's easy to use, rugged, and compact.



**The RCA-500A** all solid state, battery operated VoltOhmyst eliminates warm-up time, eliminates zero-shift that can occur in tube operated voltmeters. Completely portable. Only \$75.00.\* Comes with shielded AC/DC switch probe and cables.



**The RCA-WT-501A** in-circuit out-of-circuit transistor tester is battery operated, completely portable. It tests both low and high power transistors, has NPN and PNP sockets for convenient transistor matching for complementary symmetry applications. Only \$66.75.\*



**The RCA WC-506A** transistor-diode checker offers a fast, easy means of checking relative gain and leakage levels of out-of-circuit transistors. Compact and portable, it weighs 14 ounces, measures 3¾ by 6¼ by 2 inches. Only \$18.00.\*



**The RCA WV-98C** Senior VoltOhmyst is the finest vacuum-tube voltmeter in the broad line of famous RCA VoltOhmysts. Accurate, dependable, extremely versatile, it is a deluxe precision instrument. Only \$88.50.\* Also available in an easy to assemble kit, WV-98C (K).

For a complete catalog with descriptions and specifications for all RCA test instruments, write RCA Electronic Components, Commercial Engineering, Dept. K39WA, Harrison, N.J. 07029.

\*Optional Distributor resale price. Prices may be slightly higher in Alaska, Hawaii, and the West.

LOOK TO RCA FOR INSTRUMENTS TO TEST/MEASURE/VIEW/MONITOR/GENERATE

# VIEW

**The RCA WO-33A** Super-Portable 3-Inch Oscilloscope helps solve virtually any electronics servicing problem, inside or outside the shop. Its combination of exceptionally low cost and high performance have already made it popular as a monitoring and trouble shooting 'scope in black and white and color TV broadcasting studios, and in professional service. And why not? Here's a 3-inch 'scope that meets your requirements for gain, bandwidth, transient response, accuracy, versatility, and portability. AND IT'S ONLY \$139.00.\* Also available in an easy to assemble kit, WO-33A (K).



**The RCA WO-91C** 5-inch Dual Band Oscilloscope is a reliable, heavy-duty, precision 'scope in use in thousands of installations from classrooms to TV distribution systems...from service benches to broadcast stations. You probably can't find a better value. Applications include waveform analysis, peak-to-peak voltage measurement, square-wave testing, and observation of circuit characteristics. A front-panel switch gives you an easy choice of wide-band or narrow-band (high sensitivity) operation. It's easily portable, AND IT'S ONLY \$269.00.\* The WO-91C-V1 is available for 240V operation, no increase in price.

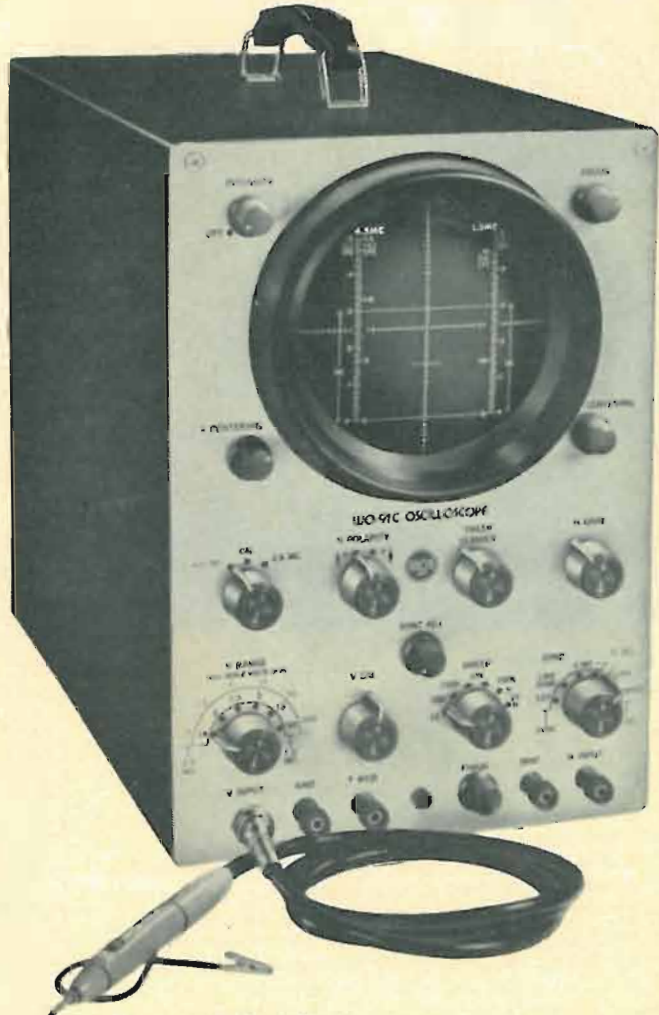

\*Optional Distributor resale price. Prices may be slightly higher in Alaska, Hawaii, and the West.

Write for a catalog with complete descriptions and specifications for all RCA test equipment: RCA Electronic Components, Commercial Engineering, Department No. K39WB, Harrison, N. J. 07029

LOOK TO RCA FOR INSTRUMENTS TO TEST/MEASURE/VIEW/MONITOR/GENERATE

# RCA

Circle 8 on reader's service card

# PHONO DRIVE KIT

For all leading  
record players



Catalog No. 1408-03  
Suggested Net . . . \$34.95

Here's a brand new kit consisting of twenty-four Walsco phono drives, providing a profit-building assortment of the most-commonly needed replacement drives for servicing all popular record players. Made from selected materials, these Walsco "Exact Replacement Drives" conform precisely to the rigid specifications established by the original equipment manufacturer, assure you and your customer of "like-new" performance whenever used. Packed in a reusable, partitioned plastic box complete with a handy cross-referenced part number list, this kit is a must for every dealer and serviceman. Order yours today . . . it could be the key to faster, easier service calls, more profits for you.

Always insist on **GC** **Walsco** **ELECTRONICS** . . .  
you'll get more for your money, every time!

## GC ELECTRONICS

A DIVISION OF HYDROMETALS, INC.  
MAIN PLANT: ROCKFORD, ILL. U.S.A.



Giant FREE Catalog...

Only GC gives you everything in electronics  
. . . has for almost 40 years. Match every  
part and service need from over 10,000  
quality items. Write for your copy today!

Circle 14 on reader's service card



has  
everything  
in  
**PHONO  
DRIVES**



**CHASSIS PUNCH KIT**  
by GREENLEE  
For making clean  
holes with minimum  
effort. Punch sizes from  
1/2" to 3/8".  
Catalog No. 3005  
Suggested Net \$38.17



**METAL STROBE DISC**  
For accurately  
checking all turntable  
speeds.  
Catalog No. 1405  
Suggested Net . . . 57¢



**CHASSIS REPAIR  
CRADLE**  
All-metal construction,  
locks chassis securely  
in place.  
Catalog No. 5212  
Suggested Net . . . \$7.95

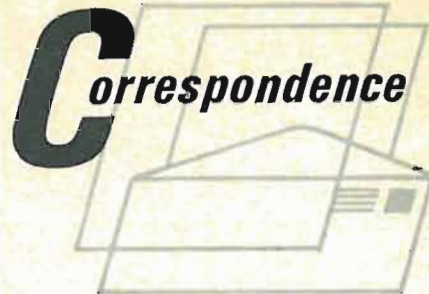

### TV DX-ER WANTS INFO

I have been dx'ing the television bands for about six months and I've been trying to collect information on TV dx'ing, TV dx'ers, antennas and equipment for use in TV dx'ing. Can any of your readers help?

MARK J. KOZLOWSKI  
306 Riverside Ave.  
Buffalo, N.Y. 14270

*Dx'ers, how about giving Mark a helping hand? We've sent him a list of dx'ing articles that have appeared in R-E. Now it's your turn to sock it to him.*

### MORE WINDSHIELD WIPER COMMENT

I read and enjoyed S. B. Gryniewicz's article in the July 1968 issue "Automatic Windshield Wiper Pause Controller." I built and installed the

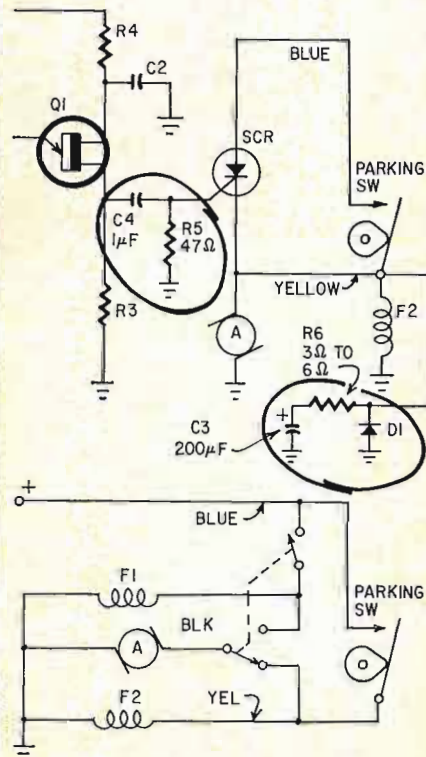

unit in my car (a 1964 Valiant) and encountered a few problems. The car has variable windshield wipers. The parking switch is between the wiper



motor and the battery. Some modifications were required to get the circuit operating properly for me. They are circled in the diagram.

C3, R6, and D1 filter out voltage transients from the wiper motor. C4 and R5 prevent the filter from interfering with proper operation of the timing network. Now the circuit works fine, except that the normal wiper cannot be turned on while the controller is operating.

HENRY L. HESS  
Colorado Springs, Colo.

*Ok, all you 1964 Valiant owners. Henry has shown you how to get the pause control to work for you. If you've been holding off waiting for this solution you can start building your pause controller now.*

#### MINI-AMP IS HOT

From the announcement of the Guitar Amplifier that was presented in the September issue, I must confess that I visualized a 60-70-watt, transformerless, all-silicon job. But let's not minimize Mr. Gill's cute 2-watt mini-amp. It has a number of good points like the CA-3020 and the diode gimmick that saves a switch by blocking reverse current from half of the 12-volt battery.

But now, let's have that same CA-3020 followed by a good class-AB power silicon complementary pair with a 50-watt output into 8 ohms or 70 watts into 4 ohms.

TONY ROCCO  
Bonita Springs, Fla.

*Tony, elsewhere in this issue you'll find a step in the right direction—a higher-wattage guitar amplifier. And within the next few months we'll show you a flock of accessories you can build to use with it or most other guitar amplifiers. Included will be a vibrato, reverb, fuzz box, mixer, inverter, bongos and—you guessed it—a 50-watt booster amplifier. So all you guitar amplifier fans, watch these next issues of R-E closely.*

#### READER SERVICE NOTES

Why don't I always get replies from all the manufacturers whose product codes I circle on your Reader Service Card?

WARREN ROY  
Brooklyn, N.Y.

*It just takes time Warren. It takes time for us to get your name to the proper manufacturers. It takes them time to get out the necessary brochure. It takes time for the post office to get that brochure to you. So don't give up, you'll get all the material you requested.*

R-E



## More power.

More exclusive features than any other all silicon transistor transceiver. Pace 2300, finest 23 channel mobil radiotelephone, gives you more talk power. The transmitter section is rated at full authorized power... delivers 4 watts at 100% modulation for reliable results at maximum range. Greater receive range, too. Plus other features including a walnut grain and chrome exterior that looks elegant in any automobile. Yet it now costs \$20 less than it used to. New low price only \$200. Write for the name of your nearest Pace dealer.

**((P)) PACE COMMUNICATIONS CORP.**  
a NOVATECH company

24040 S. Frempton Avenue  
Harbor City, California 90710  
ENGINEERED WITH THE ENGINEER IN MIND

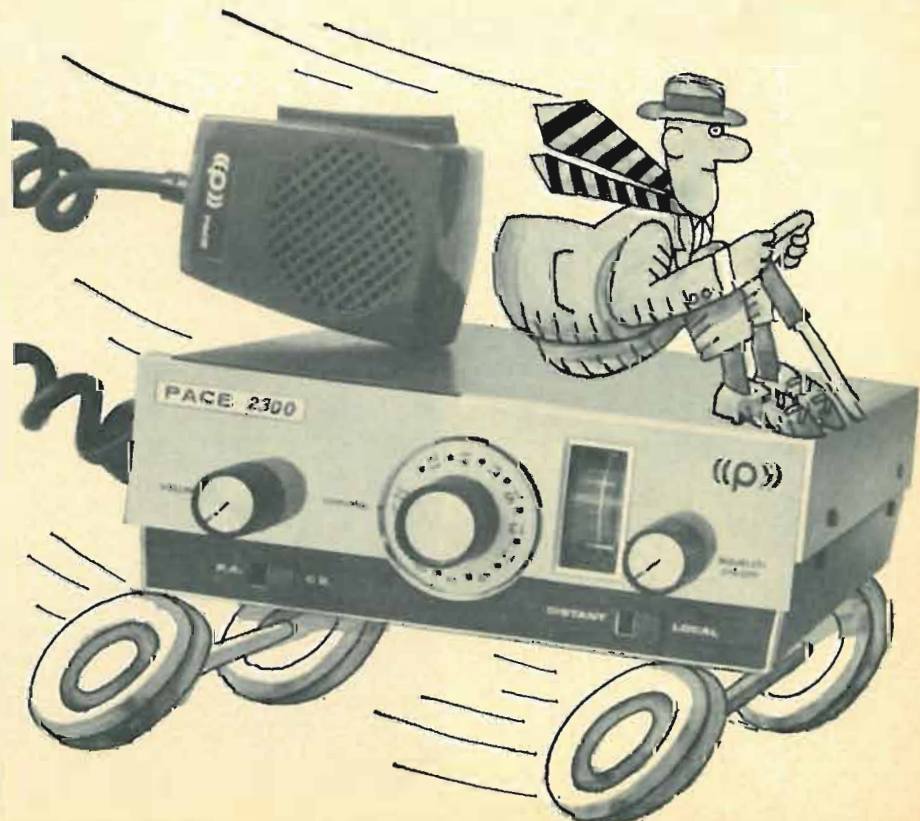

**“Get more  
education  
or  
get out of  
electronics  
...that’s my advice.”**





**Ask any man who really knows the electronics industry.**

Opportunities are few for men without advanced technical education. If you stay on that level, you'll never make much money. And you'll be among the first to go in a layoff.

But, if you supplement your experience with more education in electronics, you can become a specialist. You'll enjoy good income and excellent security. You won't have to worry about automation or advances in technology putting you out of a job.

How can you get the additional education you must have to protect your future—and the future of those who depend on you? Going back to school isn't easy for a man with a job and family obligations.

CREI Home Study Programs offer you a practical way to get more education without going back to school. You study at home, at your own pace, on your own schedule. And you study with the assurance that what you learn can be applied on the job immediately to make you worth more money to your employer.

You're eligible for a CREI Program if you work in electronics and have a high school education. Our FREE book gives complete information. Airmail postpaid card for your copy. If card is detached, use coupon below or write: CREI, Dept. 1411G, 3224 Sixteenth Street, N.W., Washington, D.C. 20010.



**CREI, Home Study Division  
McGraw-Hill Book Company  
Dept. 1411G, 3224 Sixteenth Street, N.W.  
Washington, D.C. 20010**

Please send me FREE book describing CREI Programs. I am employed in electronics and have a high school education.

NAME \_\_\_\_\_ AGE \_\_\_\_\_

ADDRESS \_\_\_\_\_

CITY \_\_\_\_\_ STATE \_\_\_\_\_ ZIP CODE \_\_\_\_\_

EMPLOYED BY \_\_\_\_\_

TYPE OF PRESENT WORK \_\_\_\_\_  G.I. BILL

- I am interested in  Electronic Engineering Technology
- Space Electronics  Nuclear Engineering Technology
- Industrial Electronics for Automation
- Computer Systems Technology

**APPROVED FOR TRAINING UNDER NEW G.I. BILL**

**Sylvania goes into the  
ghost-fighting business.**

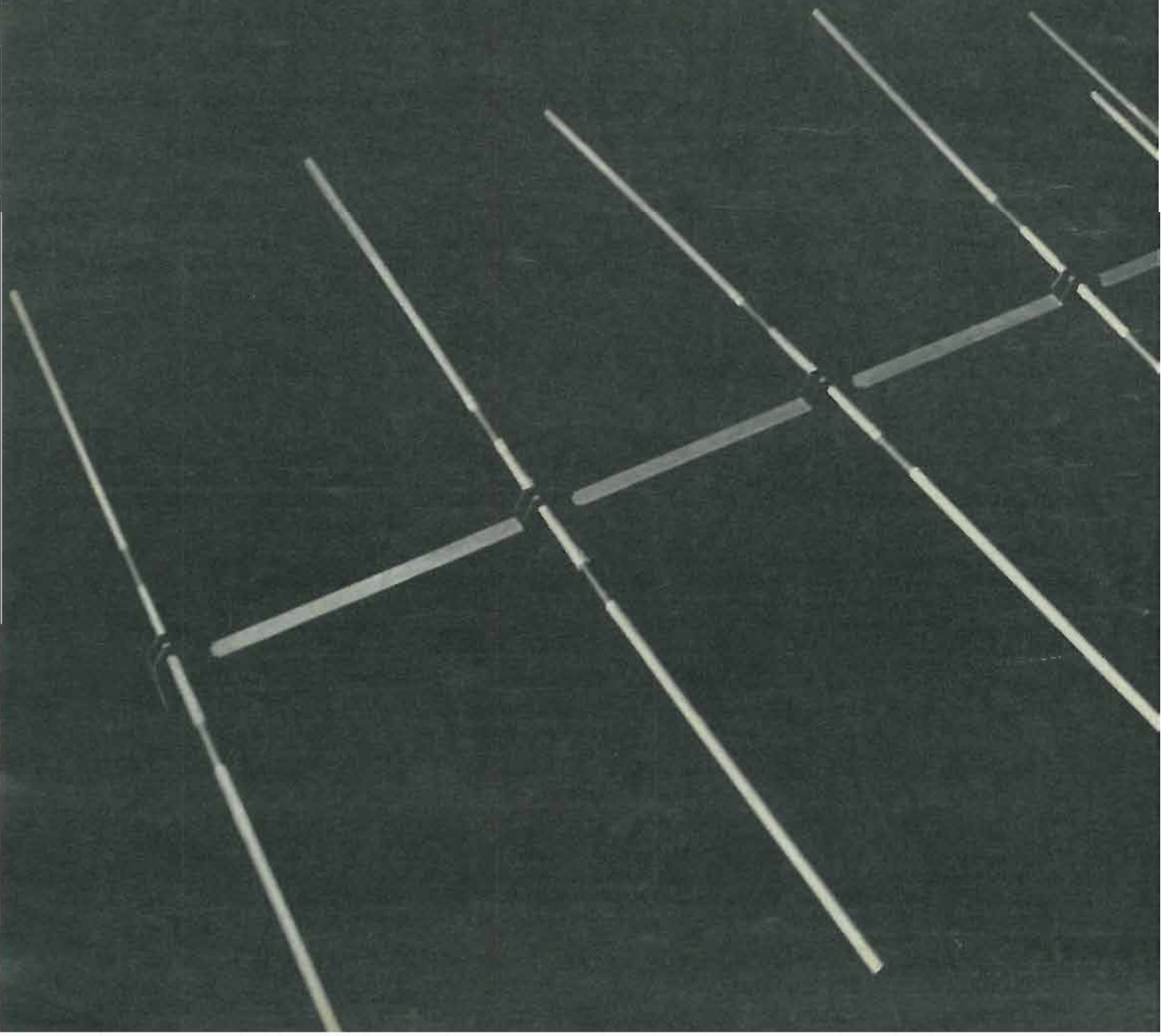



TV ghosts beware! We've got a full line of ghost-fighting antennas and we're out to get you. With all our experience in the TV business, you've got plenty of reason to be scared.

Wait till you try to creep through our 1/2" seamless tubing. You'll never make it. Or just try to cross our double booms. They'll set you straight.

And to make your life even more difficult, we've dipped our antennas in anti-corrosive material inside and out. So there'll be no rusty morsels for you to thrive on.

Take a word of warning. Before you choose another living room to haunt, check the roof. Make sure a Sylvania antenna isn't installed.

Because if it is, you don't stand a ghost of a chance.

**SYLVANIA**  
A DIVISION OF  
GENERAL TELEPHONE & ELECTRONICS

Fill 80 resistor values  
with only 20

# MAGIC NUMBERS OF ELECTRONICS



A practical reference guide and resistor stock all in one. It's a new IRC approach to using carbon composition resistors.

**MAGIC NUMBERS BOOK**—explains resistance values and how 20 values fill 80 needs. Five chapters full of helpful service information.

**CHART AND RESIST-O-GRAPHS**—reduce service time. 80/20 chart, dual range parallel and series indicators, and dual range power indicator for parallel or series. All in Magic Numbers book.

**RESISTOR STOCK**—of 20 Snap Paks. Snap Pak is the new IRC resistor package that eliminates loose parts and clutter. 1/2-watt or 1-watt stocks.

## 20 MAGIC VALUES ALSO IN FILE-O-PAK CABINET



Keeps Snap Pak stock neat. File by wattage, resistance, and tolerance. Workbench size.

MAGIC NUMBERS BOOKS NOW AT  
YOUR IRC DISTRIBUTOR



DIVISION OF TRW INC.

401 N. Broad St., Phila., Pa. 19108

Circle 17 on reader's service card

## In the Shop . . . With Jack

By JACK DARR  
SERVICE EDITOR

### Solid-State Rectifiers

AT REGULAR INTERVALS, TECHNICIANS come across funny-shaped components in radio, TV, stereo and other equipment. From their shape and size, you can't tell beans about them. But you can tell their purpose from what they're connected to. These "unidentifiables" are silicon rectifiers used in a solid-state power supply.

You may find one, two or four small units mounted on a terminal strip. Large stud-mounted rectifiers may have leads going off in all directions, or a unit may be just a featureless black blob in a rectangular case, tightly mounted on a PC board.

It doesn't matter what they look like, they all do the same thing: supply dc power for transistors or tubes. Trace the leads from an unknown unit to determine its function. If one lead goes to an electrolytic capacitor and others go to the ac source, it's the rectifier.

Three rectifier types are used in ordinary circuitry: half-wave, full-wave and bridge. You can tell which type it is by counting the number of

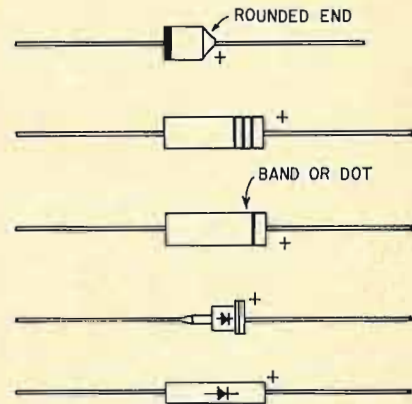

Fig. 2—Common types of rectifier cases. "Top hat" case is always the cathode.

leads on the "package." Two leads—it's a half-wave (single) rectifier. Three leads—it's a full-wave (two rectifiers with a common connection). A bridge will always have four leads. Fig. 1 shows the schematic of each.

The identification confusion results from packaging. Many rectifiers have unmarked cases with leads, prongs or studs. All you can do is look to see where they're connected.

Half-wave (2 leads): One lead will always go to the ac supply, and the other to a big electrolytic capacitor. From the capacitor, another lead will go on to the main B+ (dc) voltage circuits. Hint: Look for the power output stage. This is the point where the highest dc voltage will always be used (audio output in radios, stereo, horizontal output stage in TV, etc).

In tube equipment, the dc voltage output will always be positive. In transistor equipment, it can be positive, negative, or both, depending on the transistor types used. In a positive supply, the cathode of the diode will always go to the positive (insulated) end of the electrolytic capacitor that acts as a ripple filter.

On the very small silicon diodes now used, the cathode will be marked. This mark may be a rounded end, a band or dot of paint or, in some cases, the maker may have been thoughtful

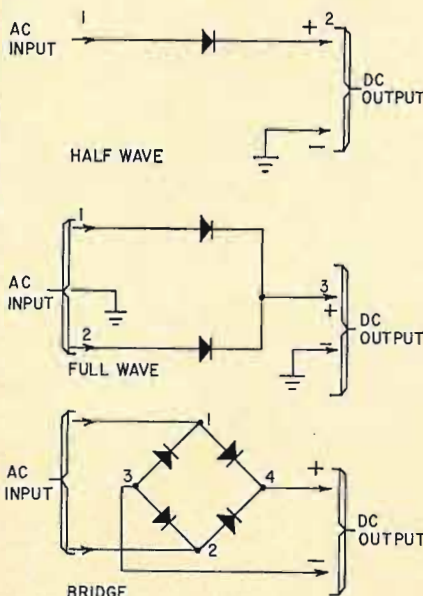

Fig. 1—Schematics of three basic rectifier types used in modern equipment.

# "QT" keeps you ahead with the fastest moving RCA parts.

"QT" is a Quick Turnover Inventory system that brings you a steady supply of the fastest-moving RCA Home Instrument replacement parts. It practically guarantees you'll have the parts you need for most of your servicing jobs.

This means you get the jobs done, without backlogging and last-minute dashes to your distributor for essential "QT" parts.

A "QT" inventory helps you cut down on those stacks of dusty boxes and trays of unused parts—and the dollars you have tied up in them.

The entire system is incredibly handy and efficient

... lets you find parts quickly while you're working ... reminds you to reorder when your supply is low ... makes inventoring and reordering so fast that it's almost automatic.

Suddenly you'll find yourself with a lot more time to devote to additional servicing jobs.

Check it out with your RCA "QT" Parts Distributor. He'll discuss the different "QT" inventory plans with you and help you select one tailored to your operation.

After that, things go very smoothly.

**Parts and Accessories, Deptford, New Jersey.**

## RCA



# new SAMS books

## How to Build Electronics Projects

by *John Potter Shields*. Clearly and thoroughly describes the methods and tools used in constructing electronics projects. Explains proper circuit layout, metal chassis and panel layout, drilling and punching. Also describes electronic components and their special characteristics; includes special data on semiconductor circuits and etched circuit board construction. 96 pages. Order 20670, only . . . . . \$2.95

## Record Changers—How They Work

by *Louis M. Dezettel*. Provides all the fundamental information on record changers, including motors and their differences, cartridges, and needles. Also describes installation procedures and information on upgrading changers for use with improved cartridges. 144 pages. Order 20661, only . . . . . \$3.95

## Electronics for the Beginner (2nd Ed.)

by *J. A. Stanley*. The author avoids dry theory and introduces the beginner to the fundamentals of constructing electronic devices in a practical manner. Each project grows more difficult, so the beginner picks up electronic theory in practice as he goes along. All projects are fully transistorized. Crystal-clear schematics and wiring diagrams, plus complete parts lists and templates, make building easy and enjoyable. Includes the color code and how to read schematics. 192 pages. Order 20677 (hardbound), only . . . . . \$5.25  
Order 20664 (softbound), only . . . . . \$3.95

## ABC's of Electronic Test Equipment

by *Donald A. Smith*. A very thorough introduction to basic test instruments. Provides a clear understanding of how to use them and how to correctly evaluate readings. Begins with a description of types of meter movements and then progresses into uses of specific instruments. 128 pages. Order 20660, only . . . . . \$2.95

## IMPORTANT RECENT BOOKS

### Using Scopes in Transistor Circuits

by *Robert G. Middleton*. The leading authority on test equipment tells when and how to use oscilloscopes to analyze and/or troubleshoot transistor circuits; major emphasis is on scope waveform analysis. The book is intended primarily for the electronic technician. It includes detailed treatment of waveforms and circuit theory in transistor oscillators, amplifiers, waveshaping circuits, monochrome and color TV, and computers. 192 pages. Order 20662, only . . . . . \$4.50

### Color-TV Servicing Guide

by *Robert G. Middleton*. This fine book is a quick, effective servicing tool for color-TV. Shows how to apply fast troubleshooting procedures, based on an analysis of trouble symptoms. Includes many full-color picture tube photos illustrating various operating troubles, accompanied by clear, concise explanations of probable causes and diagnosing procedures. The last chapter explains in detail how to test and troubleshoot with color-bar generators. 112 pages. Order 20358, only . . . . . \$4.25

### Transistor TV Training Course

by *Robert G. Middleton*. Provides a complete understanding of modern transistor television circuitry by progressive analysis of each stage of a typical receiver. Includes review questions. 128 pages. Order 20619, only . . . . . \$3.95  
These and over 300 other SAMS books are available from your Electronic Parts Distributor

## Howard W. Sams & Co., Inc.

Order from your Sams Distributor today, or mail to Howard W. Sams & Co., Inc., Dept. RE-11  
4300 W. 62nd Street, Indianapolis, Ind. 46268

Send me the following books:

- 20670  20677  20660  20358  
 20661  20664  20662  20619

\$ \_\_\_\_\_ enclosed

Name \_\_\_\_\_

Address \_\_\_\_\_

City \_\_\_\_\_

State \_\_\_\_\_ Zip \_\_\_\_\_

My Distributor is \_\_\_\_\_

Circle 19 on reader's service card

enough to put the diode symbol on the case. Fig. 2 shows the common types of single-rectifier cases. There is one "standard": the top hat case shown second from the bottom. The case of this unit is always the cathode. This holds true for a stud-mount rectifier, too; if it's reversed (anode to case), there will be an "R" suffix on the type number; if it's a JEDEC rectifier, the "R" has a "1N—" number.

Full-wave rectifiers have 3 leads (Fig. 3). They may be in any type of case, but the 3 leads will be the clue. A three-lead type is a dual, full-wave rectifier, and the lead marked "+" is the output, the other leads go to the ac supply (always a power transformer). The output can be negative, of course, in which case the marking will be "-".

A full-wave bridge, when packed in a single case, may appear like those shown in Fig. 4. The tipoff is the four leads. A manufacturer may mark all four leads as shown. If only one or two are marked, you have to trace connections by finding the filter capacitor, etc. Look for the two terminals marked "ac" and the others marked "+" and "-".

In the stud-mounted type shown at the bottom of Fig. 4, the positive terminal is sometimes marked "+" and sometimes with only a red dot. The ac leads are usually identified.

Never disconnect the unit until you've drawn a rough sketch of the connections, including wire colors and the position of the unit. If necessary, mark the rectifier case—a piece of lettered tape will do.

The most valuable clue is the filter capacitor. Electrolytics are always marked for polarity. The terminal

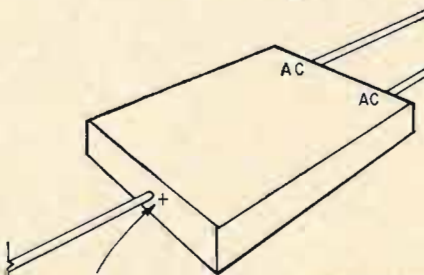
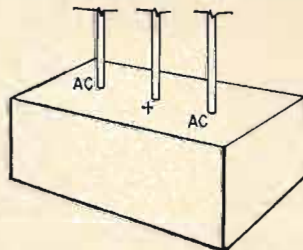

COMMON CATHODE OR (-) COMMON ANODE  
Fig. 3—Three leads designate a full-wave rectifier. Lead marked "+" is output; other leads go to ac transformer.

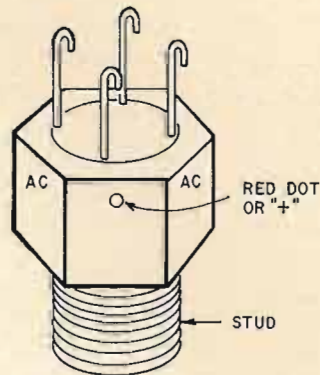
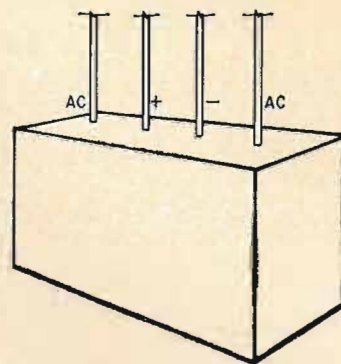

Fig. 4—Full-wave bridge rectifier always has 4 leads. This type has many case designs. The stud-mount case on bottom is for heat-sink purposes only.

connected directly to the rectifier will be the input filter, and you can determine polarity from this.

Rectifier size is an indicator of its current rating. You can get the PIV (peak inverse voltage) rating by measuring the applied ac voltage, even with the rectifier disconnected.

In small units, such as stereos, etc., you'll probably find 1-amp rectifiers. These are common; even small silicon rectifiers now have 1-amp ratings. Rectifiers such as the stud-mount type of Fig. 4, with a heat sink, will probably be from 2 to 4 amps.

To make sure of current ratings, you can disconnect the main dc voltage-supply lead from rectifier to filter capacitor, and read the full-load current. This is a good idea with "unknown" rectifiers. For instance, if you decide there should be 2-ampere rectifiers and you read a load current of about 2.5 amps, yank those rectifiers out of there and put in 4-amp types. Use an adequate safety factor.

For bridge rectifier replacements, you can always use separate units, mounted on a four-terminal strip. This doesn't take up too much room on even the most crowded chassis. If necessary, use top-hat types and put transistor heat sinks on them. However, a generous safety factor for current may eliminate heat-sinking. **R-E**



# Service Clinic

By JACK DARR  
SERVICE EDITOR

## Pattern Bounce in dc scope

*I'm thinking of buying a dc scope. Someone told me that the trace of his dc scope would bounce all the way off the screen when he touched the probe to any circuit carrying dc voltage. Is this normal?—B. F., Reading, Pa.*

Sure is! The position of the trace on a dc-coupled scope depends on the dc voltage present at the probe tip! You can even use the scope for a dc voltmeter, if you've got it calibrated. The action you describe is perfectly normal.

In the ac-coupled scope, the type used in most service shops, the pattern will jump when the input blocking capacitor is being charged up. It *should* return to its original position if the capacitor isn't leaky.

## Two-color convergence

*We can't get an RCA 21CD7856 color TV chassis to converge properly. The green and blue lines are straight but the reds are curved. This happens on horizontal and vertical lines; beyond the range of the adjustments! What causes this and what can we do to correct it?—J. Z., Aliquippa, Pa.*

Try the red-green method. Turn the blue off, and work on getting the red and green to converge to yellow. You have many adjustments on the blue, so it's easier to pull it over than to move the other two.

Watch out for one thing (it happened to me not too long ago): The red was actually "one square too far over" on a fine crosshatch pattern! Cause: incorrect adjustment of static magnet. I  
*(continued on page 90)*

This column is for your service problems—TV, radio, audio or general and industrial electronics. We answer all questions individually by mail, free of charge, and the more interesting ones will be printed here.

If you're really stuck, write us. We'll do our best to help you. Don't forget to enclose a stamped, self-addressed envelope. Write: Service Editor, Radio-Electronics, 200 Park Ave. South, New York 10003.

**FAR  
SUPERIOR  
TO  
ANY  
VTVM  
OR  
VOM**

**--and  
for  
less  
money**



## NEW FIELD EFFECT MULTIMETER

Here is the revolutionary new approach to circuit testing, the solid state Sencore FIELD EFFECT METER. This FE14 combines the advantages of a VTVM and the portability and versatility of a VOM into a single low-cost instrument. This is all made possible by the use of the new space age field effect transistor that is instant in action but operates like a vacuum tube in loading characteristics. Compare the features of the FIELD EFFECT METER to your VTVM or VOM.

**Minimum circuit loading**—15 megohm input impedance on DC is better than a VTVM and up to 750 times better than a 20,000 ohm per volt VOM—10 megohm input impedance on AC is 20 times better than a standard VTVM. The FIELD EFFECT METER is constant on all ranges, not like a VOM that changes loading with each range.

**Seven AC peak-to-peak ranges** with frequency response to 10MHz. Seven zero center scales down to 0.5 volt. Five ohmmeter ranges to 1000 megohms. DC current measurements to 1 ampere. Full meter and circuit protection. Mirrored scale. Low current drain on batteries—less than 2 milliamps. Built-in battery check. Unbreakable all-steel vinyl clad case. Optional Hi-Voltage probe adds 3KV, 10KV and 30KV ranges with minimum circuit loading for greatest accuracy in the industry... \$9.95.

**Only Sencore offers the FIELD EFFECT METER.**  
**Ask for it by name at your distributor.**

**only \$69.95 (less batteries)**



**SENCORE**

NO. 1 MANUFACTURER OF ELECTRONIC MAINTENANCE EQUIPMENT

426 SOUTH WESTGATE DRIVE, ADDISON, ILLINOIS 60101

Circle 20 on reader's service card



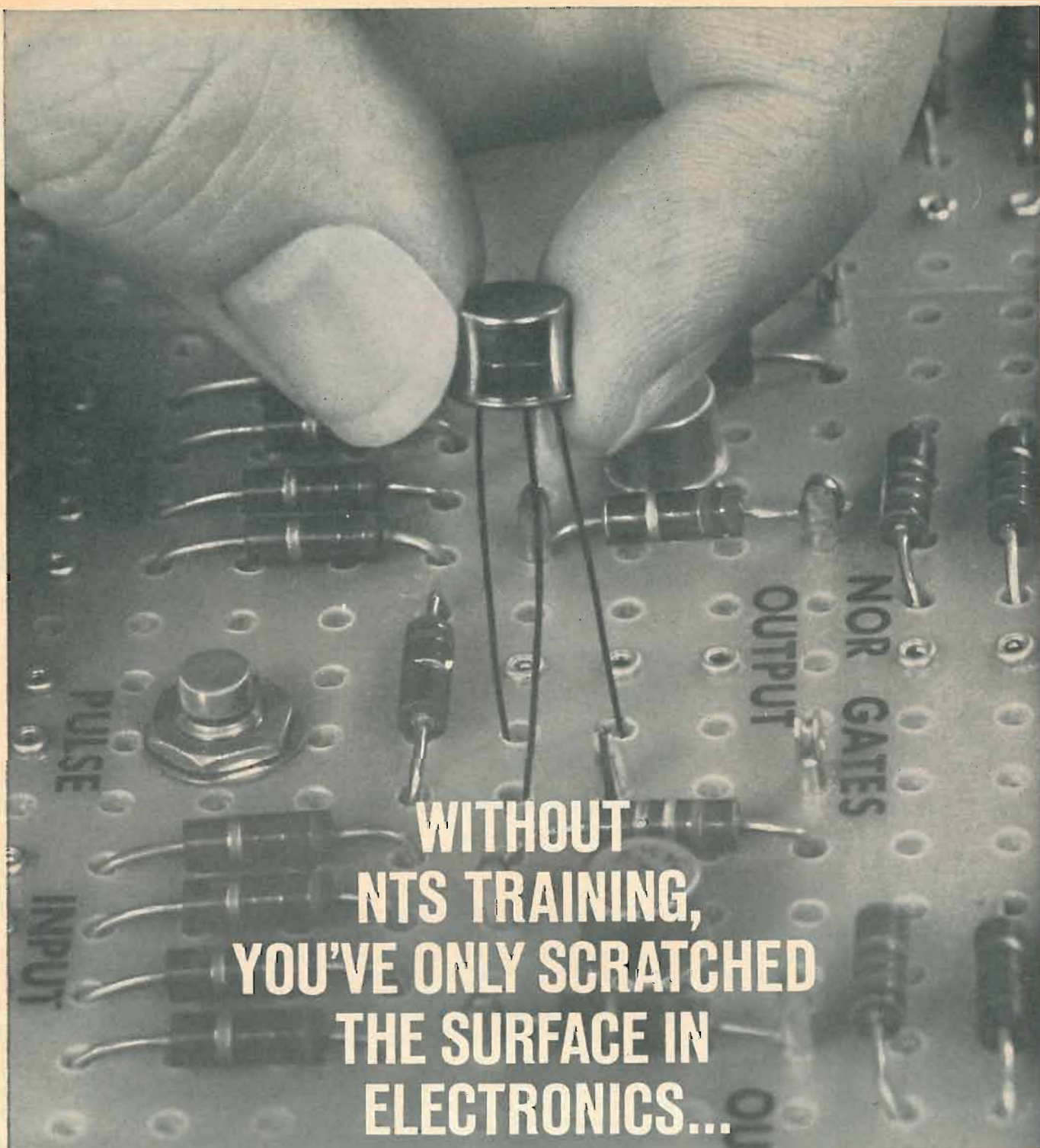

Only NTS penetrates below the surface. Digs deeper. Example? Take the above close-up of the first transistorized digital computer trainer ever offered by a home study school.

It's called The Compu-Trainer®—an NTS exclusive. Fascinating to assemble, it introduces you to the exciting world of computer electronics. Its design includes advanced solid-state NOR circuitry,

flip-flops, astable multivibrators and reset circuits. Plus two zener and transistorized voltage-regulated power supplies. The NTS' Compu-Trainer® is capable of performing 50,000 operations per second.

Sound fantastic? *It is!* And at that, it's only one of many *ultra-advanced* kits that National Technical Schools offers to give you incomparable, in-depth career training.

**PROVE IT YOURSELF. SEND FOR OUR NEW CATALOG. SEE THE LATEST,  
MOST ADVANCED KITS AND COURSES EVER OFFERED BY A HOME STUDY SCHOOL.**

## NTS...THE FIRST HOME STUDY SCHOOL TO OFFER LIVE EXPERIMENTS WITH INTEGRATED CIRCUIT KITS

You build a computer sub-system using the new, revolutionary integrated circuits. Each one, smaller than a dime, contains the equivalent of 15 resistors and 27 transistors.

And your kits come to you at no extra cost. These kits are the foundation of the exclusive *Project-Method* home study system...developed in our giant resident school and proven effective for thousands of men like yourself.

With Project-Method, all your kits are carefully integrated with lesson material. Our servicing and communication kits are *real* equipment—not school-designed versions for training only. As you work on each of the projects, you soon realize that even the most complicated circuits and components are easy to understand. You learn *how* they work. You learn *why* they work.

NTS Project-Method is a practical-experience approach to learning. The approach that works *best!* An all-theory training program can be hard to understand — difficult to remember. More than ever before you need the practical experience that comes from working with real circuits and components to make your training stick.

### NTS SENDS YOU KITS TO BUILD THESE IMPORTANT ELECTRONICS UNITS!

- ◆ 25" COLOR TV
- ◆ 21" BLACK & WHITE TV
- ◆ SOLID-STATE RADIO
- ◆ AM-SW TWIN-SPEAKER RADIO
- ◆ TUBE-TESTER
- ◆ TRANSCEIVER
- ◆ COMPU-TRAINER®
- ◆ VTVM
- ◆ SIGNAL GENERATOR
- ◆ 5" OSCILLOSCOPE

See them all illustrated in  
the new NTS Color Catalog.

**CLASSROOM TRAINING AT LOS ANGELES:** You can take classroom training at Los Angeles in sunny California. NTS occupies a city block with over a million dollars in facilities devoted exclusively to technical training. Check box in coupon.

# NATIONAL TECHNICAL SCHOOLS

WORLD-WIDE TRAINING SINCE 1905

4000 So. Figueroa Street, Los Angeles, Calif. 90037

**APPROVED FOR VETERANS**



Accredited Member: National Home Study Council  
Accredited Member: National Association of  
Trade and Technical Schools



### COMMUNICATIONS

This transceiver is included in Communications courses. You build it. With it, you easily prepare for the F.C.C. license exam. You become a fully-trained man in communications, where career opportunities are unlimited.

### 25" COLOR TV ▼

Included in Color TV Servicing Courses. With it you advance yourself into this profitable field of servicing work. Color is the future of television, you can be in on it with NTS training.

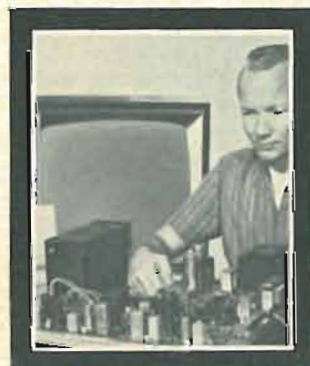

### YOUR OPPORTUNITY IS NOW

New ideas, new inventions, are opening whole new fields of opportunity. The electronic industry is still the fastest growing field in the U.S. There's a bigger, better place in it for the man who trains today. So, whatever your goals are — advanced color TV servicing, broadcasting, F.C.C. license, computers, or industrial controls, NTS has a highly professional course to meet your needs.

GET THE FACTS! SEE ALL NEW COURSES AND KITS OFFERED IN THE NEW NTS COLOR CATALOG. SEND THE CARD OR COUPON TODAY!



There's no obligation. You enroll by mail only. No salesman will call.

Dept. 206-118

### NATIONAL TECHNICAL SCHOOLS

4000 S. Figueroa St., Los Angeles, Calif. 90037

Please rush Free Color Catalog and Sample Lesson, plus information on field checked below. No obligation.

- |   |  |
|---|--|
| <input type="checkbox"/> MASTER COURSE IN COLOR TV SERVICING        | <input type="checkbox"/> PRACTICAL TV & RADIO SERVICING    |
| <input type="checkbox"/> COLOR TV SERVICING                         | <input type="checkbox"/> FCC LICENSE COURSE                |
| <input type="checkbox"/> MASTER COURSE IN TV & RADIO SERVICING      | <input type="checkbox"/> INDUSTRIAL & COMPUTER ELECTRONICS |
| <input type="checkbox"/> MASTER COURSE IN ELECTRONIC COMMUNICATIONS | <input type="checkbox"/> STEREO, HI FI & SOUND SYSTEMS     |
|   | <input type="checkbox"/> BASIC ELECTRONICS                 |

NAME \_\_\_\_\_ AGE \_\_\_\_\_

ADDRESS \_\_\_\_\_

CITY \_\_\_\_\_ STATE \_\_\_\_\_ ZIP \_\_\_\_\_

Check if interested in Veteran Training under new G.I. Bill.

Check if interested ONLY in Classroom Training at Los Angeles.

# X-Rays One Year Later

IT'S BEEN A FULL YEAR SINCE THE TV X-RAY SCARE STARTED AND THAT scare is just now fading away. Set makers were prompt in their reaction, and the new sets don't produce enough X-rays to worry about. Every manufacturer has taken drastic and thorough steps to avoid any possible recurrence. As a result, the danger to color TV viewers is almost nonexistent.

However, until color sets are built so that they produce no X-rays at all, the guy who gets into the guts of a TV receiver—the service technician, the hobbyist, the home-brew tube jockey—may find himself circumventing the protective schemes the set maker built into his product at the factory. Therefore, anyone thinking of working on color TV should observe the following rules.

- Never operate color picture tubes that do not have a bonded faceplate without a sheet of safety glass in front of the screen.
- Don't operate a black-and-white picture tube in a color set unless you use a sheet of safety glass in front of the faceplate.
- Don't operate a color picture tube with its purity shield removed.
- Never raise the high voltage above the manufacturer's recommendations.
- Don't operate receivers with the high-voltage shield removed.
- Always replace shielding and protective devices.

Follow these simple safety rules and you'll be safe from X-ray exposure.

## X-RAYS ARE DANGEROUS. COLOR TV PRODUCES X-RAYS. THEREFORE—COLOR TV IS DANGEROUS

Logical bit of logic, isn't it? Fortunately, it's not all that logical. For all X-ray exposure is not hazardous. The real hazard depends upon the level of intensity. The National Council on Radiation Protection and Measurement has set up a minimum safe level of radiation from any TV set. It states that the maximum exposure rate at any readily accessible point 5 cm (about 2 inches) from the surface of any home TV receiver shall not exceed 0.5 mR (milli-roentgens) per hour.

This radiation level is about *half* the output of most luminous dial watches. Obviously these are very conservative figures. Dr. Victor P. Bond, associate director of the Brookhaven National Laboratory, has said that these ratings "are deliberately conservative, and are set well below the levels of exposure that carry a significant probability of medical effects. . . ." In other words, there's not enough radiation to worry about.

But, and this is the big but, no one has ever demonstrated that X-rays can do us any good—other than those a doctor may use professionally for specific medical purposes. And it is my belief that the fewer X-rays I am exposed to, the better. None of us would care to discover, 20 years from now, that those low-level X-rays were dangerous after all.

Of course, the service technician who works on color sets a good part of the day and the hobbyist who gets a lot closer to his set than an ordinary viewer risk being exposed to much higher levels of radiation for longer periods of time than the average person.

What can be done? Quite a bit, and most of it has already been done. The major X-ray producer in TV is the high-voltage section. When a high-voltage vacuum tube is subjected to 20,000 volts or more, it becomes an X-ray source.

And should the voltage in the set jump from say, 25,000 volts, to 30,000 volts, X-ray output may jump 10 to 20 times.

To date, the biggest culprit in color sets has been the shunt regulator tube. But new circuits and tube designs have just about eliminated this problem. The high-voltage rectifier is another potential trouble spot. One solution is to replace the vacuum-tube rectifier with a solid-state rectifier that cannot produce radiation at any voltage level. Another alternative is proper shielding.

Another possible solution is color picture tubes, like the Sony Trinitron, that do not require the high-voltage levels that produce radiation.

In the meantime, TV service technicians must insure that the high voltage on each color set they repair is properly set. Manufacturers must continue taking steps to design sets that cannot produce X-rays.

Color TV's can produce X-rays. But the X-ray output of these sets is strictly limited and manufacturers are checking their sets carefully before they leave the factory. If and when the X-rays can be completely eliminated, and I believe that they can be, we won't have to think about them at all.

—Larry Steckler, Managing Editor

# X-Rays And Your Color Set

# SIMPLE DETECTOR SPOTS TV X-RAYS

By RICHARD K. STOMS & EDWARD KUERZE

WE NEEDED AN INSTRUMENT TO measure X-ray emission from TV sets. It had to measure levels as low as the exposure rate listed in the NCRH (National Center for Radiological Health) recommendation which states: "The exposure dose rate at any readily accessible point 5 cm from the surface of any home TV receiver shall not exceed 0.5 mR per hour under normal operating conditions."

The detector had to be portable and make accurate measurements rapidly, under field conditions. To meet these requirements we developed the instrument described here. Several were built by the Cincinnati, Ohio, facility of Electronic Products Radiations Laboratory of the NCRH.

## How it works

The detector directly integrates and measures the electrical current represented by the GM (Geiger Muller) tube pulses. Its circuit is shown in Figs. 1, 2 and 3. The main circuit is in Figs. 1 and 2 and the audio circuit is in Fig. 3.

In Fig. 1, transistor Q8 is a constant-current generator that supplies a stable reference voltage for potentiometers R14 and R20. These pots equalize the steady-state zero-signal voltage at points B and C (about 3 volts). FET (field-effect transistor) Q4 and transistor Q5 and resistor R26 compose what amounts to a source follower with the voltage at point B following Q4's gate voltage. On all range settings, gate voltage is developed across the series combination of R12 and R13 shunted by C4 as a result of the electrical charge collected from the pulses in the 1B85 GM tube. The number of these pulses, and hence, gate voltage, is related to the X-ray field incident on the 1B85.

The calibration resistor (R12 and R13) is a series combination of a 3.3-megohm resistor and 5-megohm potentiometer or a selected resistor between 3.3 and 6.8 megohms and a 1-meg pot, depending on availability of potentiometers. The pot is adjusted so the base voltage range across the meter and its range resistor on the 3K range is 0.3

volt. Thus the 10K, 30K and 100K ranges have a voltage range of 1.0, 3.0 and 10.0 volts full scale (Fig. 2).

If voltages at B and C vary equal amounts in the same direction, there will be no meter deflection. If Q7's gate were made to follow the changes of point B, then point C would also follow these changes and the meter reading would not change. Time-constant capacitor C5 is connected between point B and Q7's gate. In conjunction with R17 it determines the time constant. This capacitor allows relatively fast changes to couple to the

Q7 gate but not slow or dc voltages.

It is convenient when using this instrument, which has an appreciable time constant, to occasionally revert to a fast response for a short time to allow the meter to assume its approximate reading and then return the instrument to its longer time constant. This is done by pressing pushbutton switch S5 located on the front panel near the meter face. This shorts R17, reducing the time constant. Note that an additional "base" time constant is provided by R12 and R13 and C4.

Position 1 of RANGE switch S3 is

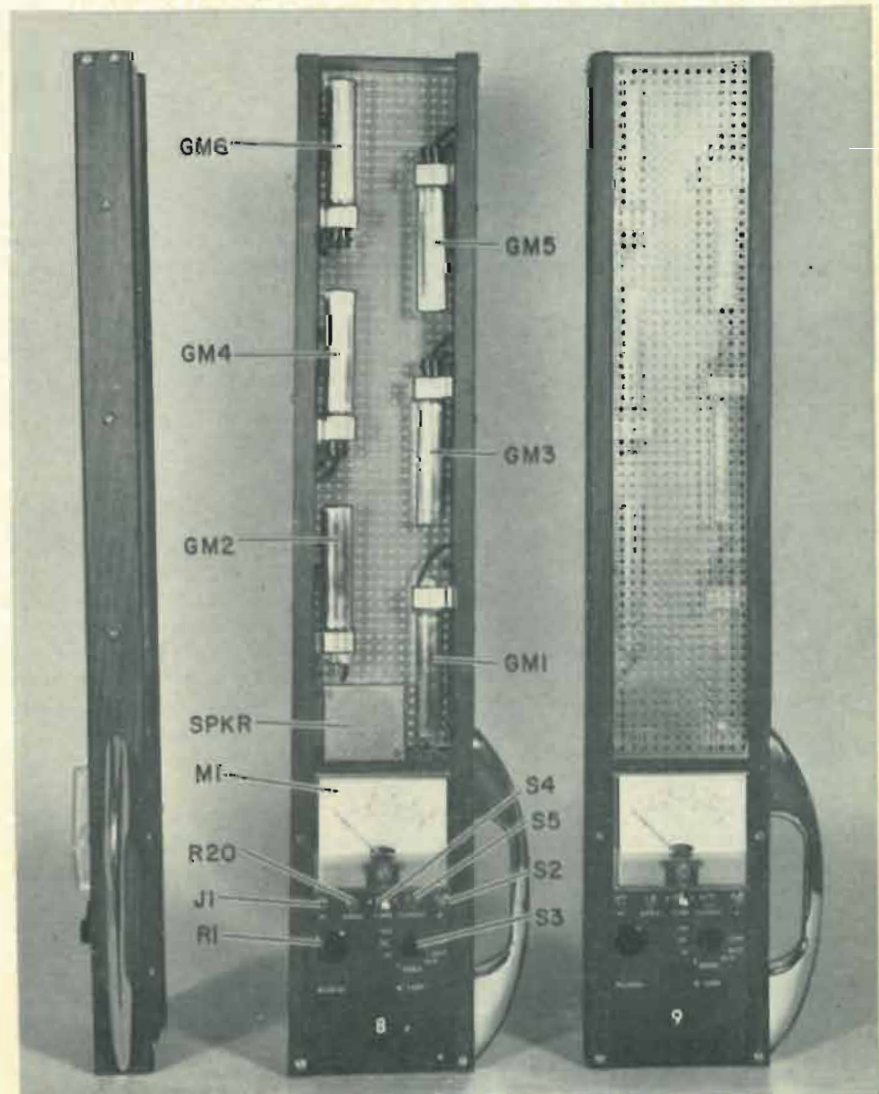

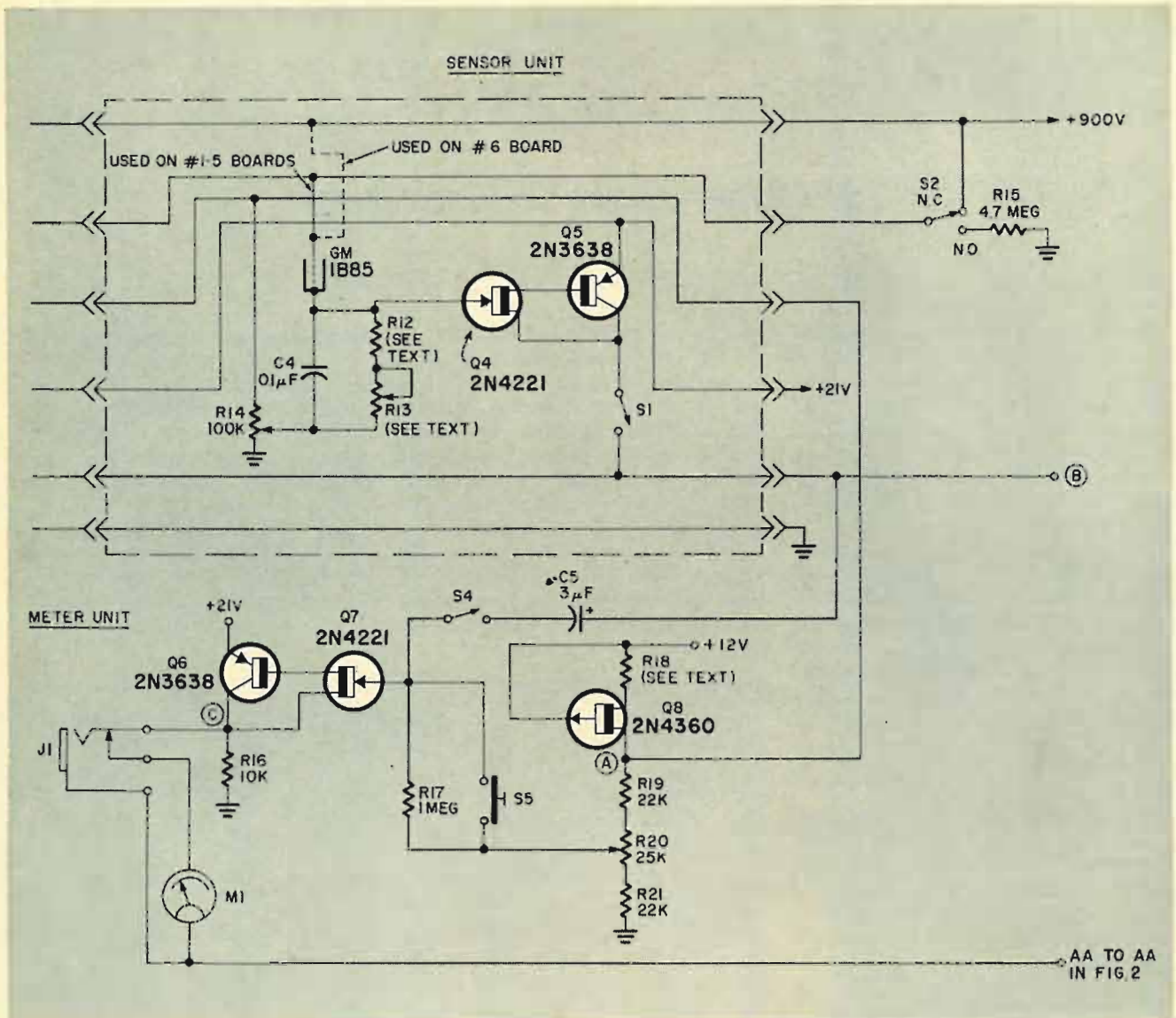

Fig. 1—In the sensor unit, Q5's gated output to B is determined by the output of the 1B85 radiation tube and calibration pot R13. Capacitor C5 in the meter section is connected between point B and Q7's gate, so only gated output pulses deflect meter.

the OFF position. Position 2 reads battery voltage under its normal load. Position 3 checks the high-voltage supply. The meter current is a portion of the GV3A 900-volt shunt regulator current. Any "on scale" reading indicates that there is shunt regulator current and that the high-voltage supply is on and regulating. Note that in this position all other circuits are off (battery voltage being blocked by D4). Position 4 is the zero check position. In this position the high-voltage supply is disabled. Positions 5 through 8 are the ranges previously described.

At this point, operation with only one GM tube has been considered. If in Figs. 1 and 2 six units identical to the sensor unit shown are paralleled and proper adjustments made, the meter will indicate only the current in the tube seeing the highest X-ray ex-

posure rate. This happens because the increase in voltage at point B due to an increase in gate voltage on one (or more) Q4 transistor will tend to cut off current through the remaining Q4, Q5 transistors. Switch S1 is provided on each of the sensor units so that each unit may be zero-set individually and also to facilitate troubleshooting.

GM tube No. 6 (tube farthest from meter) receives its high voltage directly from the high-voltage supply while tubes 1 through 5 are supplied through S2. Pushing S2 disconnects the high voltage from tubes 1 through 5 and discharges the stray capacitance so that only tube No. 6 is operational. S2 must be kept depressed by the operator to deactivate tubes 1 through 5. When released, it is spring-returned to normal. If cost is important a unit with only a single GM tube can be

built. This slows down scanning time but cuts the cost by about \$50.

The high-voltage circuit in Fig. 2 is fairly simple. A UJT (unijunction transistor), Q9, is operated as a relaxation oscillator. The ramp voltage at Q9's emitter is capacitively coupled to the base of the normally off Q10. The result is a series of square-wave current pulses through the primary of transformer T1, a UTC 0-2. The frequency is approximately 2 kHz. Use of the UJT oscillator provides a very reliable means of self-starting, compared to the usual methods of feedback oscillators using a transformer tap.

The secondary circuit uses a standard voltage doubler and a GV3A 900-volt Corotron (Victoreen Instrument Company) shunt regulator. R34 is in series with the shunt regulator so

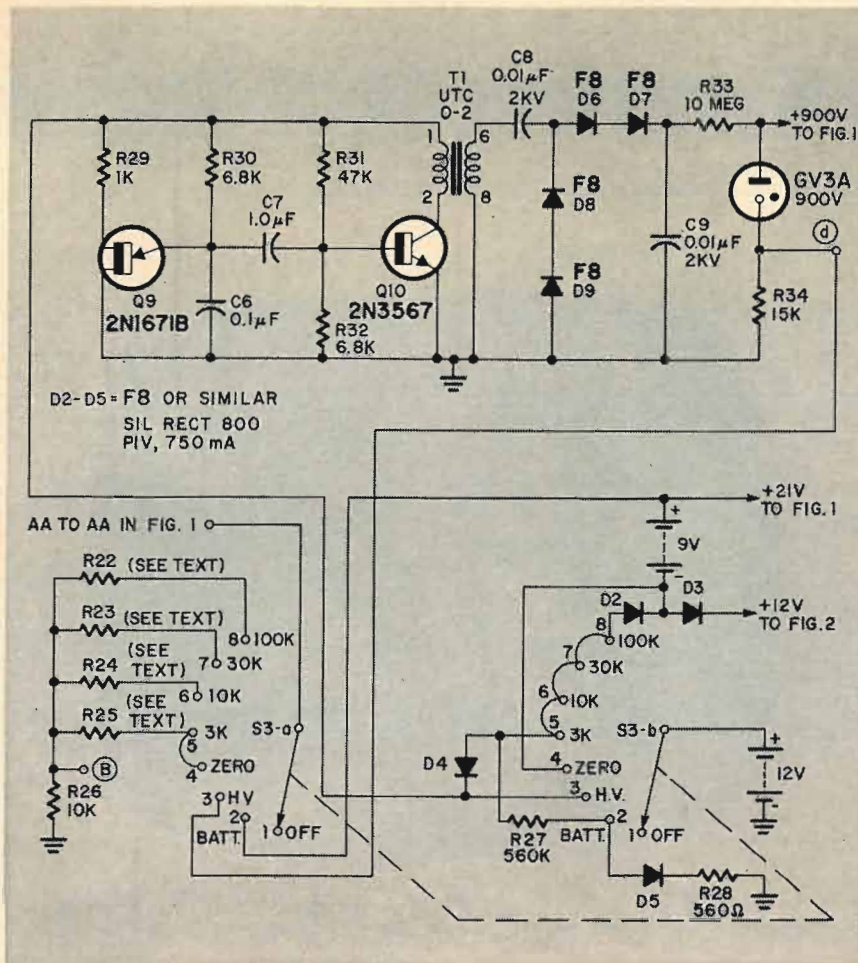
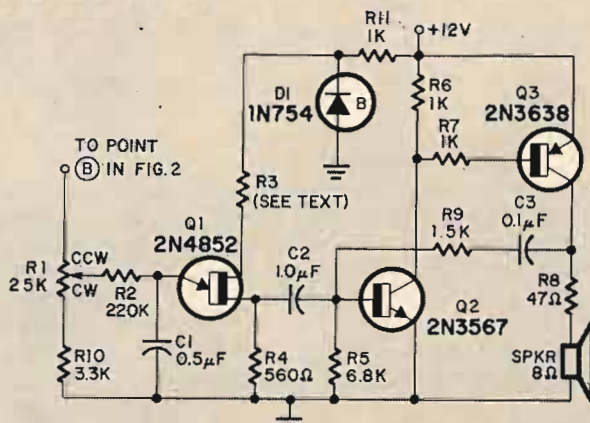

Fig. 2—High-voltage section supplies 6 GM tubes used by author. UJT oscillator Q9 provides 2-kHz current pulses on T1's primary. Voltage doubler uses a GV3A regulator.

Fig. 3—Audio circuit can be added to indicate X-ray level. Emitter voltage on Q1 controls frequency of multivibrator Q2-Q3.



when S3 is in position 3, the meter will indicate a part of GV3A current.

An audible signal can be produced for a preselected X-ray level as shown in Fig. 3. This is not a mandatory part of the circuit but is useful. Potentiometer R1 is connected to point B of Fig. 1 so the emitter voltage of UJT Q1 is related to X-ray exposure. R3's value is selected so the maximum setting of R1 just barely keeps Q1 from oscillating when the zero-sig-

nal voltage at point B is present. Any increase in voltage at point B increases emitter voltage at Q1 and cause oscillation. The frequency is a function of emitter supply voltage, which results in an increasing audio tone as X-ray exposure increases. Q2 and Q3 comprise a monostable multivibrator. In its normal state, both Q2 and Q3 are off. A positive pulse from Q1 coupled into the base of Q2 will turn Q2 and Q3 on. Feedback network R9 and C3 pro-

vides the positive feedback required for monostable multivibrator action and controls the "on" time. The speaker receives a pulse of energy for every pulse produced by Q1.

### Using the instrument

Start by turning the range switch to the battery check position. The meter should show a reading of 21 volts. Change the batteries if the reading is 18 volts or lower.

Turn next to the HV position. Any "on scale" reading indicates that the high-voltage supply is operating.

Now check the meter by placing the range switch on the zero position. Use the screwdriver adjust pot (R20) below the meter face.

Most readings will be made with the time-constant switch set to F. The longer time constant may be selected if desired. Depressing the button switch next to the time-constant selector switch reduces the time constant to its shortest value. This can substantially reduce the time required for a reading.

An audible signal is incorporated and may be used at the operator's discretion. The sound is turned off by turning the audio control completely clockwise. Other positions of the control determine the level or amount of X-ray exposure that the audio circuit will respond to. A radioactive check source emitting X-rays or gamma rays can be used to obtain any desired meter reading. The control can then be set so that an audible signal can just be obtained. A decrease in X-ray exposure below this value will produce no sound. Increasing exposure over this level will result in a sound of increasing frequency. The sound is not that obtained by producing a click or sound pulse for every Geiger-tube pulse. The time-constant selector does not affect the response time of the audio signal which always operates on the shortest time constant.

### Field tests and maintenance

A radioactive source emitting X-rays or gamma rays can be used to check the operation of the instrument. When the source is successively placed adjacent to the GM tubes, fairly consistent readings should be obtained. Differences in readings between tubes or between readings taken on both sides of the same tube may be caused by small variations in the short "source to tube" distance. These differences are minimal when the source is more

(continued on page 91)

# The Case of the Mysterious Glitch-Hausen

*Some unusual TV ailments can be catching*

By **JACK DARR**  
SERVICE EDITOR

CHARLEY SNARLED. I SNARLED BACK. Neither of us was in good humor at that moment. I'd been beating my brains out all morning on a G-E KC color TV chassis, and he'd been doing the same thing on a middle-aged Philco b-w.

I had colored "sparkles" on the right side of my picture. He had what looked like the worst case of Barkhausen oscillation I'd ever seen, though it didn't look just right. We stopped and went out for coffee, leaving the sets on.

In the coffee shop we moaned about our problems. "I'm danged if I can figure this thing out," I said. "I've got plenty of high voltage, and it looks for all the world like an arcing resistor in there. But this set hasn't got a filter resistor in the high-voltage lead! I can't see any corona, any arcevers, or nothin'. I've been sitting there an hour trying to hear corona with that little plastic tube. Nothing. It just sits here and sparkles at me!"

"Me, too," said Charley. "That blanketty-blank thing looks for all the world like Barkhausen, but I've changed horizontal output tubes three times, the damper and everything else I can think of. No corona on mine, either. It just sits there and makes bars at me!"

We went unwillingly back to the shop. There they sat, side by side, sparkling and streaking at us. I lit a cigarette and Charley moodily chomped on a second doughnut. We sat there glaring back at the sets.

"Well," I said, "don't just sit there, do something! I'm going to yank that thing out and look for a carbon track on the PC board around the boost connections."

I yanked the cheater cord from the G-E. Then I went straight up in the air, for there was a loud screech from behind me. Charley was pointing at his Philco. There was the prettiest picture you ever saw!

I plugged the G-E back in, and when it warmed up there they were again: big, fat black bars on the Philco. I ran to the tube shelf and grabbed a new 6JS6 horizontal output tube. After some confusion, the new tube was



*The set had what looked like the worst case of Barkhausen oscillation I'd seen.*

plugged in, and we watched with fingers crossed. The high voltage sizzled and there we were. No more bars on the Philco. I peeked over the top of the G-E. No more sparkles, either! Just a beautiful, clear picture.

I put the old 6JS6 back and waited. Bars again, and sparkles. Suddenly, I reached over to Charley's set and took the antenna clip off. Hmmm. No bars now! I put the new 6JS6 back, turned it on, and there we were. Two beautiful pix. We headed back for the coffee shop.

Ten minutes and several paper-napkin schematics later, we had puz-

zled it out. The horizontal output tube in my G-E had been causing a *form* of Barkhausen oscillation, and this had been so strong that it had been *coupled* into the antenna input of Charley's set. Being on the common shop antenna, this had been more than enough.

Ordinary Barkhausen oscillation shows up as black wiggly bars about an inch or two from the right side of the screen. In other words, just a little bit before the horizontal output tube reaches peak conduction. However, *this* thing must have been making an oddball oscillation just as the tube reached the peak, or perhaps even during the first split microsecond of actual "flyback." It must have been similar to what TV transmitter engineers call a "glitch"—a burst of very-high-frequency oscillations at the cycle peak (Fig. 1).

So, you might call what we'd had a very severe case of "Glitch-hausen oscillation!" Back at the shop, we tried it one more time. The G-E had a beautiful picture: no trace of sparkles or bars, etc. Since the set's owner had been complaining about "funny-looking color pictures" for some time, when it went home it had a brand-new 6JS6 in it.

**R-E**

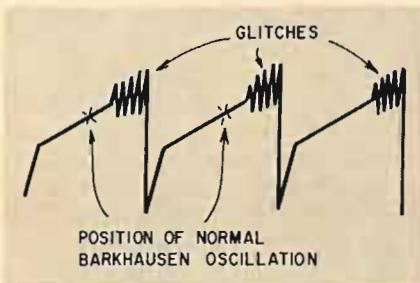
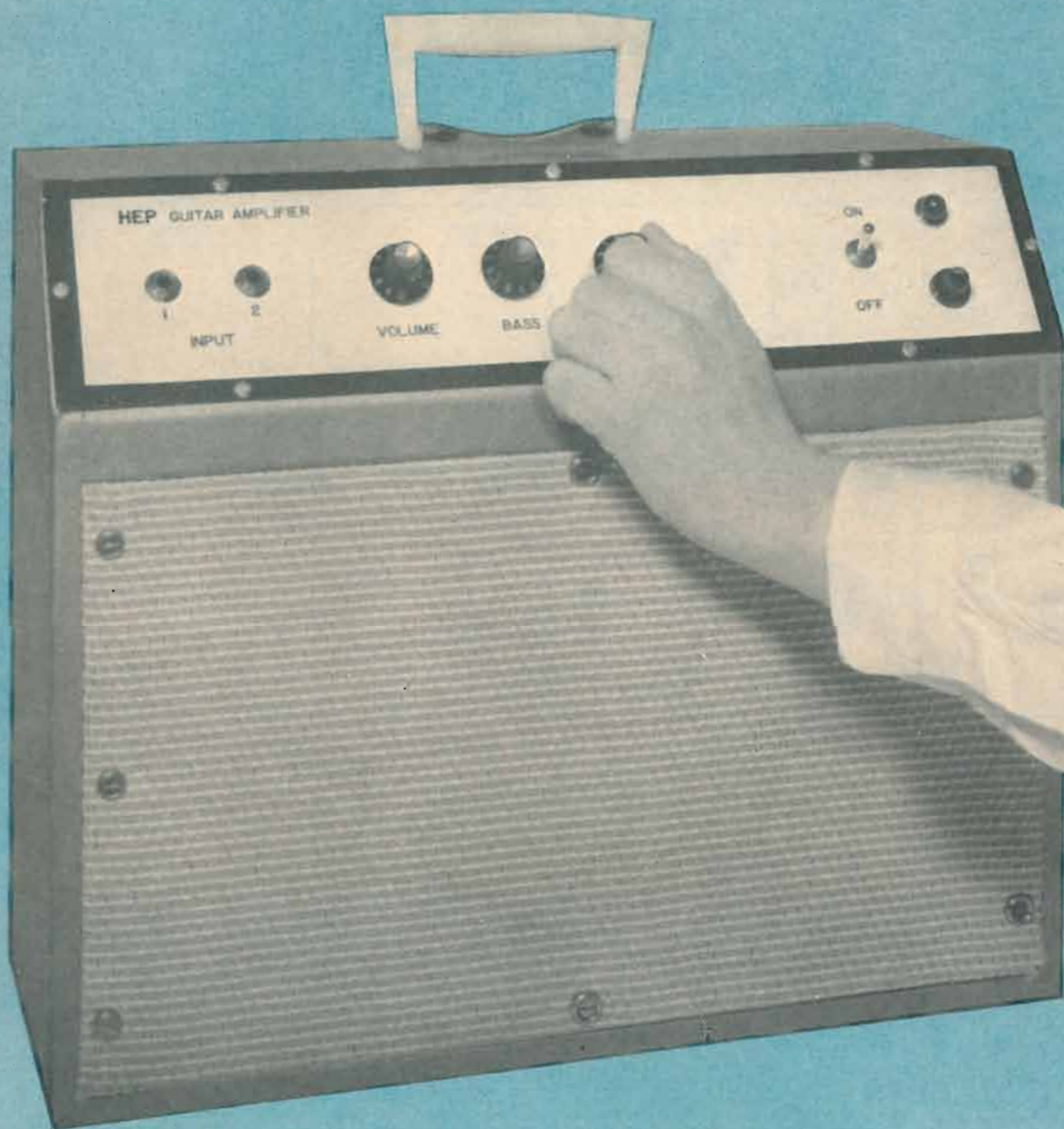

*Fig. 1—High-frequency oscillations or "glitches" apparently developed as the horizontal output tube reached a peak.*



For the musically inclined hobbyist—first in an eight-part series

# Go-Go Guitar Amplifier



IF YOU'RE AN ELECTRONICS BUFF AND YOU enjoy playing the guitar, here's a unit you can build that will make it possible for you to combine both hobbies. Although the amplifier isn't hi-fi, its gain and response characteristics do make it an excellent choice for both guitar or public address use. The amplifier has dual inputs and can deliver a con-

tinuous 10 watts of music power output. And if this isn't enough, a future issue will describe a compatible 50-watt booster amplifier.

A host of other electronic gadgets are also coming and they are all related to this unit. They include an input mixer, tremolo, bongos, reverb amplifier, fuzz box and a 12 Vdc to 115 Vac inverter. For more details about these other units see page 40.

Why the dual input? Because it adds  
*(text continued on page 40)*

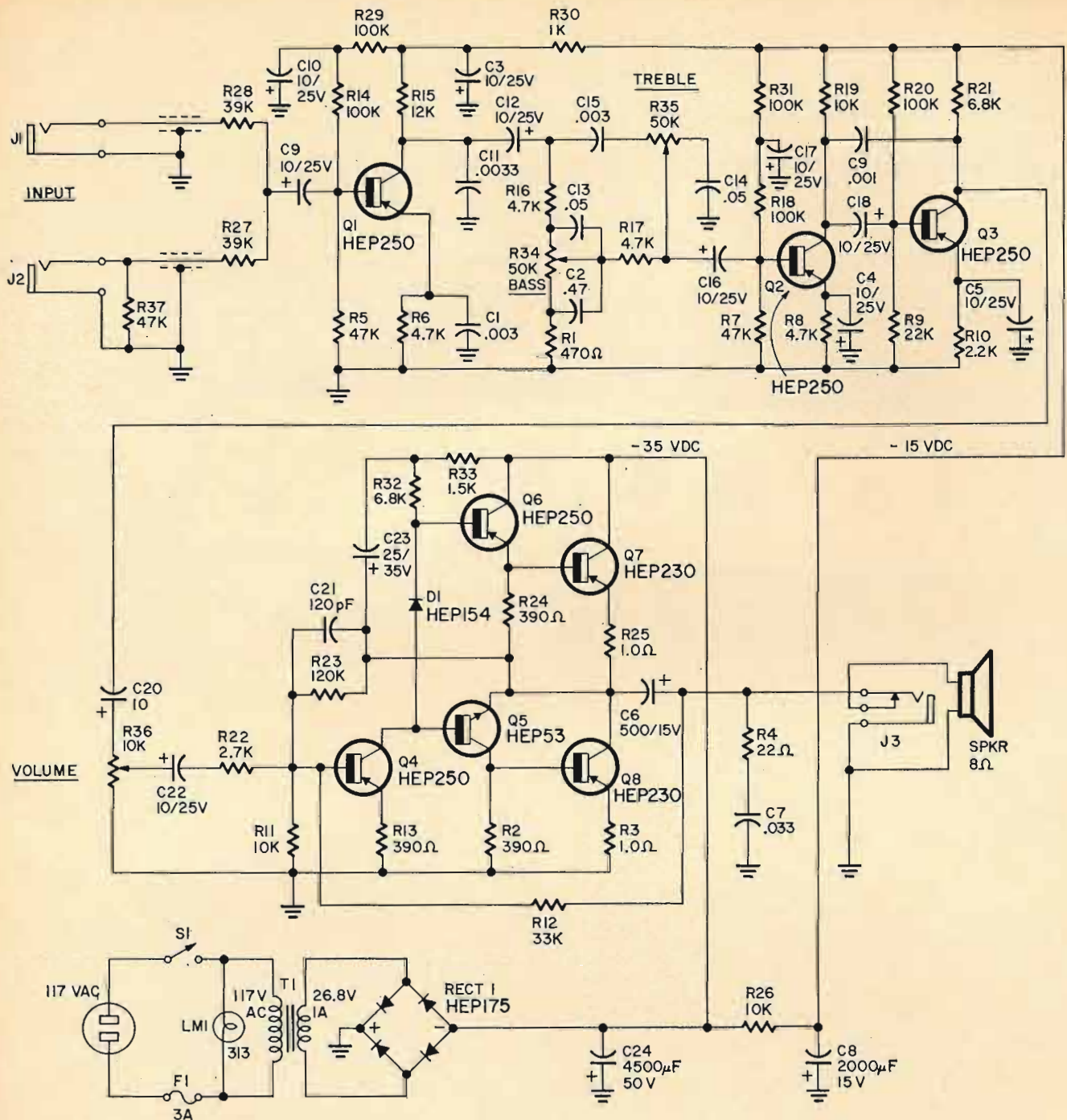

Fig. 1—Dual input to preamplifier section (top) adds versatility. The power amplifier develops up to 10 watts of music power.

#### ELECTRONICS PARTS LIST

Q1, Q2, Q3, Q4, Q6—HEP 250 (Motorola)  
 Q7, Q8—HEP 230 (Motorola)  
 Q7, Q8—HEP-230 (Motorola)  
 RECT 1—diode bridge assembly HEP 175 (Motorola)  
 D1—HEP 154 (Motorola)  
 T1—Filament transformer, Primary 117 Vac. Secondary 26.8 V, 1 A (Triad F40X or equiv.)  
 C1, C11, C15—.003  $\mu$ F, 600 V (Mallory SX230 or equiv.)  
 C2—.47  $\mu$ F, 100 V (Mallory PVC1047 or equiv.)  
 C6—500  $\mu$ F, 15 V electrolytic (Mallory TC1505 or equiv.)  
 C13, C14—.05  $\mu$ F, 100 V, disc ceramic  
 C3, C4, C5, C9, C10, C12, C16, C17, C18, C20, C22—10  $\mu$ F, 25 V, electrolytic (Mallory TC22 or equiv.)  
 C7—.033  $\mu$ F, 100 V (Mallory PVC1133 or equiv.)  
 C8—2000  $\mu$ F, 15 V, electrolytic (Mallory TC-1520 or equiv.)

C19—.001  $\mu$ F, 600 V, (Mallory SX210 or equiv.)  
 C21—120 pF, 600 V (Mallory SX312 or equiv.)  
 C23—25  $\mu$ F, 35 V, electrolytic (Mallory MTAA-5E35 or equiv.)  
 C24—4500  $\mu$ F, 50 V, electrolytic (Mallory CG-452U50D1 or equiv.)  
 R1—470 ohms,  $\frac{1}{2}$  W  
 R2, R13, R24—390 ohms,  $\frac{1}{2}$  W  
 R3, R25—1 ohm, 1 W  
 R4—22 ohms,  $\frac{1}{2}$  W  
 R5, R7, R37—47,000 ohms,  $\frac{1}{2}$  W  
 R6, R8, R16, R17—4,700 ohms,  $\frac{1}{2}$  W  
 R9—22,000 ohms,  $\frac{1}{2}$  W  
 R10—2,200 ohms,  $\frac{1}{2}$  W  
 R11, R19—10,000 ohms,  $\frac{1}{2}$  W  
 R14, R18, R20, R29, R31—100,000 ohms,  $\frac{1}{2}$  W  
 R15—12,000 ohms,  $\frac{1}{2}$  W  
 R21—6,800 ohms,  $\frac{1}{2}$  W  
 R22—2,700 ohms,  $\frac{1}{2}$  W  
 R23—120,000 ohms,  $\frac{1}{2}$  W  
 R26—10,000 ohms,  $\frac{1}{2}$  W  
 R27, R28—39,000 ohms,  $\frac{1}{2}$  W  
 R30—1000 ohms,  $\frac{1}{2}$  W

R33—1,500 ohms,  $\frac{1}{2}$  W  
 R34, R35—potentiometer, 50,000 ohms, 2 watts (IRC 11-123 or equiv.)  
 R36—potentiometer, 10,000 ohms (IRC 13-116)  
 S1—spst toggle  
 LM1—pilot lamp, No. 313  
 F1— $\frac{1}{4}$  A-fuse, type 3AG  
 J1—phone jack (switchcraft 11) or equiv.)  
 J2, J3—phone jack, N.C. (Switchcraft 12A or equiv.)  
 Heat sinks for Q7, Q8—HEP 500  
 Fuseholder  
 Pilot lamp holder (Dialco 81410-112-201)  
 Transistor sockets (6) (Elco 05-3304 or equiv.)  
 Transistor socket rings (6) (Elco 55-47202 or equiv.)  
 Power transistor sockets (2) (Motorola HEP 450 or equiv.)  
 AC line cord  
 SPKR—8 ohms (Utah MI-8JC or equiv.)  
 Knobs, grommets,  $5\frac{1}{8}$ " x  $3\text{-}13/16$ " x 18 gage aluminum chassis,  $8\text{-}7/8$ " x  $4\frac{1}{4}$ " x 18 gage aluminum control panel, terminal strips and misc. hardware.

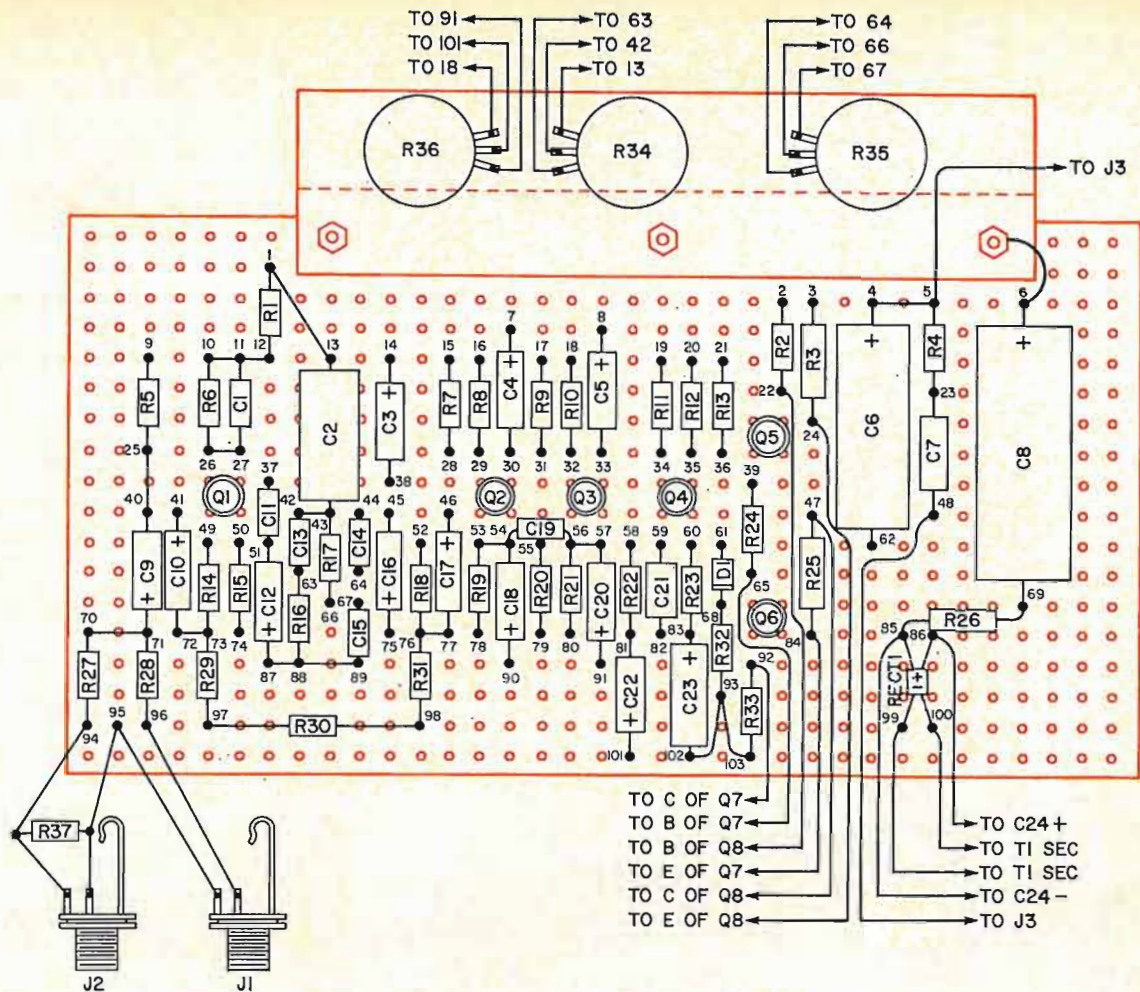
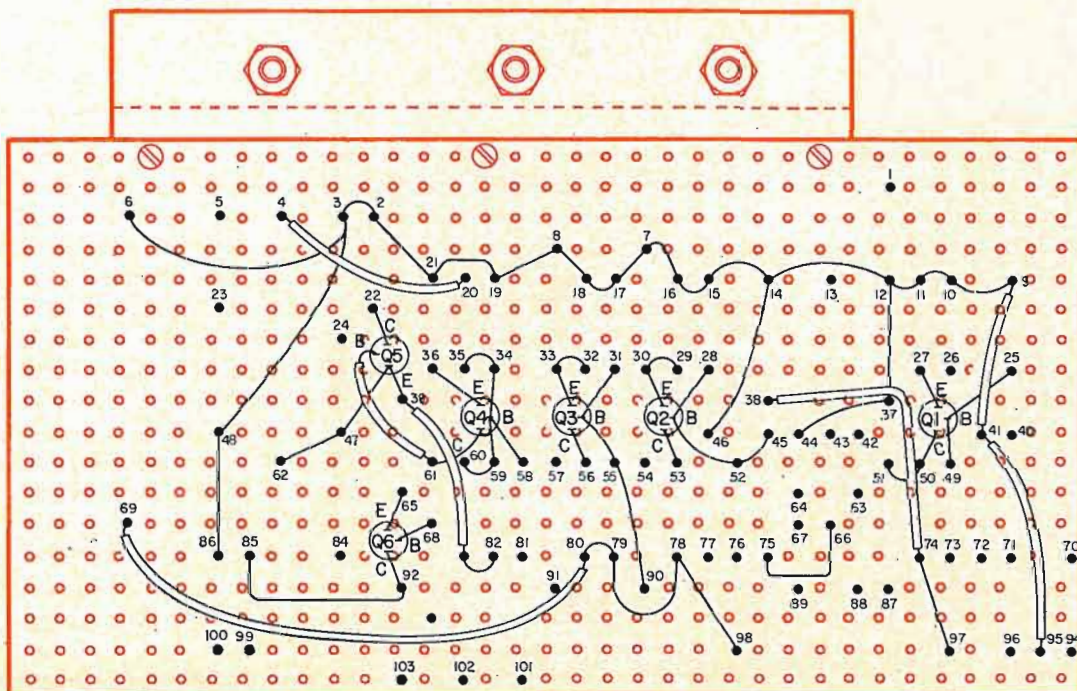
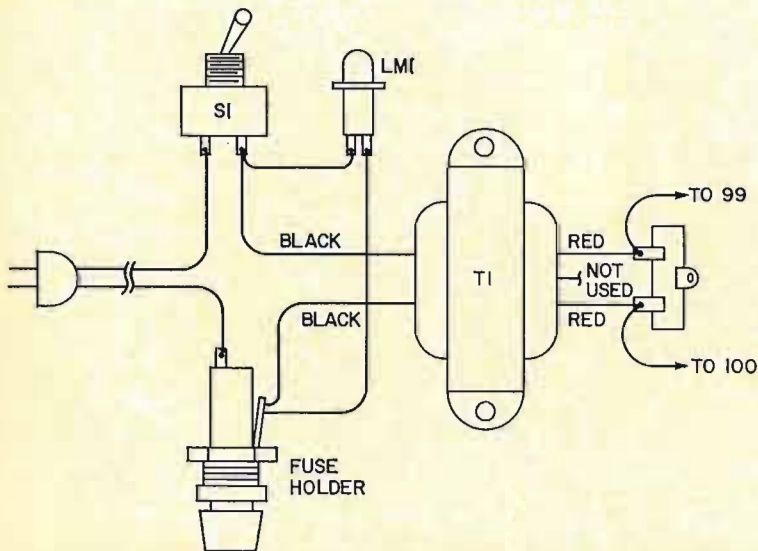
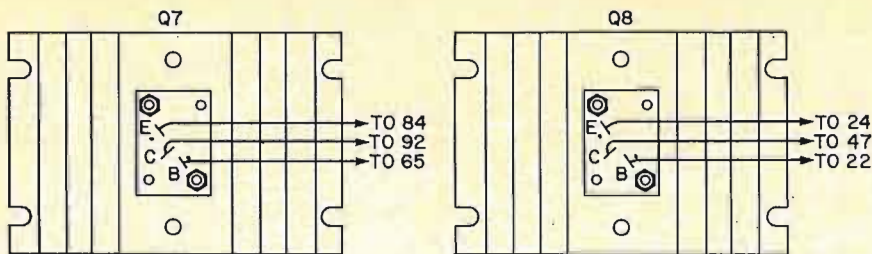

Fig. 2—Top view shows component layout. Where indicated, use hook-up-wire leads to external parts.

Fig. 3—Bottom view shows point-to-point wiring. Hole numbers correspond to numbers above.





*Drawing and photo show wiring and placement of components external to the wired circuit board.*

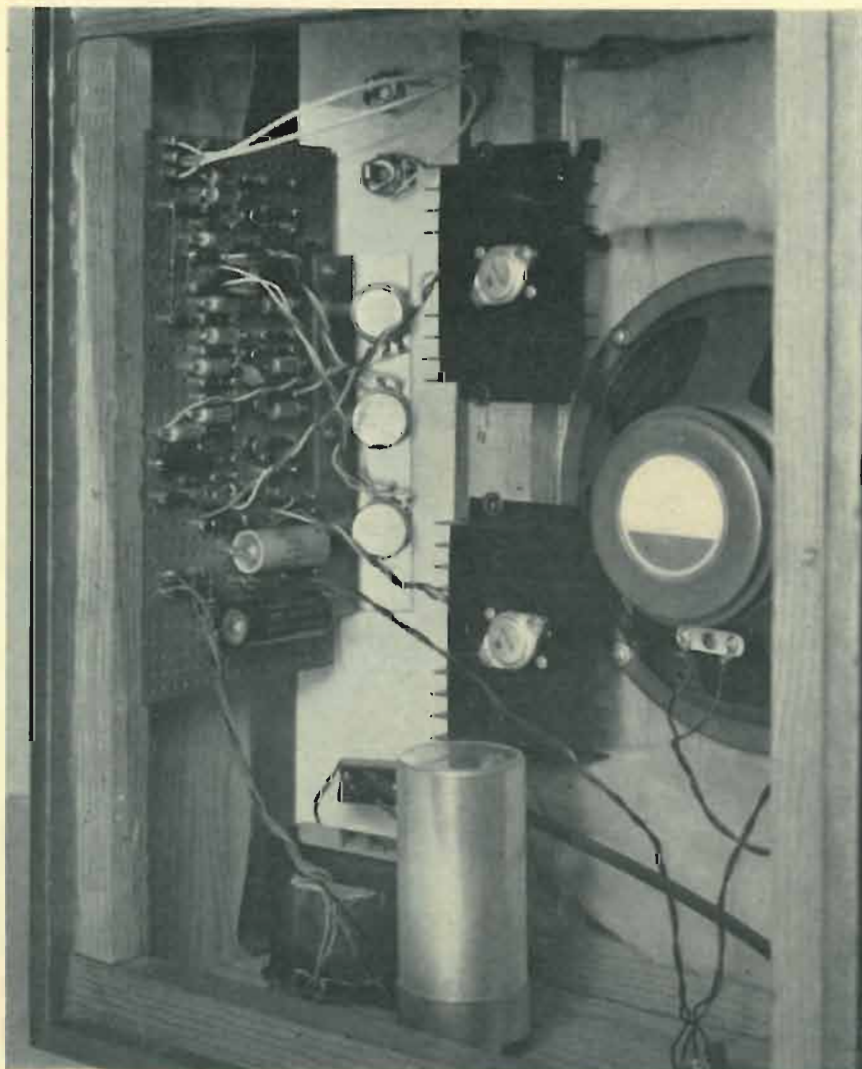

versatility. It makes it possible to place the guitar in front of a full recorded orchestra or, if you wish, combine your instrument with that of a friend. And the 10-watt output is ample for large group meetings or even a teen-age dance.

### Two parts to the circuit

The guitar amplifier actually breaks down into two units—a preamp and a power amplifier. These are both shown in Fig. 1. You will note that the preamp provides both voltage gain and tone control while the power amplifier develops about 10 watts of music power.

In the preamp, audio input signals are combined in a summing network consisting of resistors R27 and R28. This is then coupled to buffer amplifier Q1. The output from this transistor amplifier is applied to a tone compensation network that controls the frequency response of the preamp and in turn the amplifier.

When both the BASS and TREBLE controls are set to mid-range, the response curve of the amplifier is "flat". Varying the setting of BASS control R34 changes the amplitude of the low frequencies applied to

### ONLY THE BEGINNING

*Here you have the basic guitar amplifier. But there's more to come in this exclusive R-E series.*

#### In December

- **Dc to ac inverter** that makes the guitar amplifier a portable unit.

#### In Following Months

- **Reverb unit** to give your guitar amplifier that "big" sound.
- **Fuzz box** to produce those "in" fuzz effects used by today's hot recording groups.
- **Vibrato** to add a pulsating rhythm to your music sound.
- **Electronic mixer** to get those "special" hard to duplicate effects.
- **Booster amplifier** delivers 50 watts of audio power to handle even the larger party.
- **Electronic bongos** to round out your electronic music system.

transistor Q2. The high frequencies are controlled in a similar fashion. Rotating TREBLE control R35 affects the high-frequency response.

### The power amplifier

Two cascade, common-emitter amplifier stages (Q2 and Q3) follow the tone compensation circuit to increase the signal level to that required to drive the power amplifier. The power amplifier itself is a single-ended class-B circuit that has a low output impedance. This makes it possible to drive the speaker directly without any need for an output transformer.

The signal that appears at the wiper of VOLUME control R36 is coupled to complementary transistors Q5 and Q6 through amplifier transistor Q4. Since transistor Q5 inverts the signal and transistor Q6 does not, properly phased outputs are developed to drive power transistors Q7 and Q8. Positive and negative feedback are introduced by resistors R23 and R12, and capacitor C23, to compensate for the unsymmetrical output stages. This allows the positive signal peaks to approach the same amplitude as the negative signal peaks. Capacitor C21 was selected in test to produce optimum output response. Resistor R4 and capacitor C7 are incorporated to prevent phase shift at the upper frequency limits due to the rise in output impedance. Dc power for the power amplifier and preamp is developed by a brute-force bridge rectifier circuit that provides well-filtered -35 volts for the power amplifier and -15 V for the preamp.

The amplifier is fun to build and even more fun to use. The instructions and diagrams are complete and no additional data is needed. All parts are readily available from most large suppliers. Build this one fast so you can be ready for the other seven-add-ons that go with it.

**R-E**

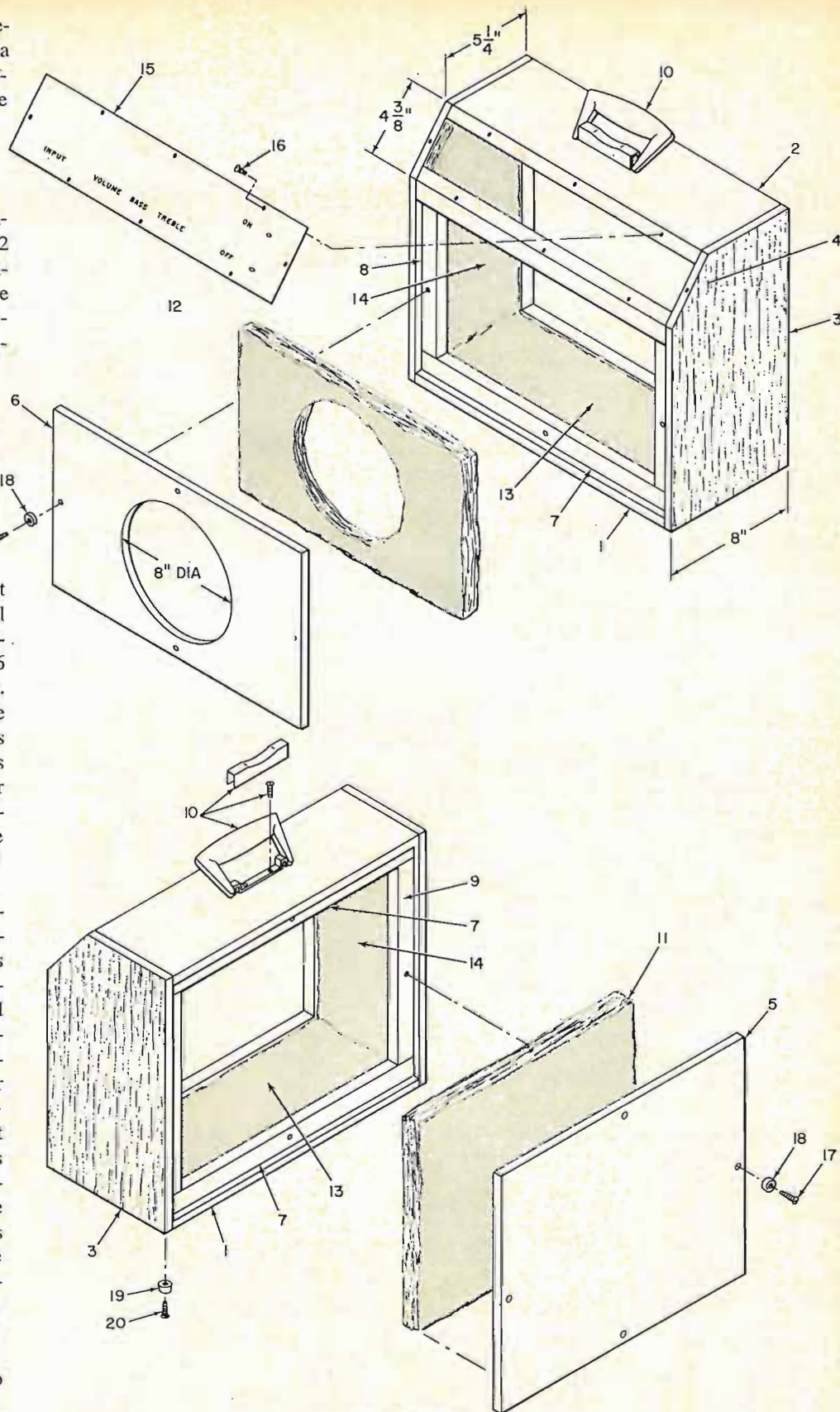

#### CABINET PARTS LIST

- |  |   |
|--|---|
| 1. BOTTOM 8 x 17 x 1/2" plywood              | 12. SPEAKER INSULATION 1" x 8-1/4 x 16 glass fiber      |
| 2. TOP 6 x 17 x 1/2" plywood                 | 13. BOTTOM INSULATION 1" x 5-1/4 x 17 glass fiber       |
| 3. END 8 x 15 x 1/2" plywood (2 required)    | 14. END INSULATION 1" x 5-1/4 x 12 (2 req.) glass fiber |
| 4. FRONT 2 x 17 x 1/2" plywood               | 15. CONTROL PLATE 4 1/8" x 18 16-gauge aluminum         |
| 5. BACK 14 x 17 x 1/2" plywood               | 16. PLATE MOUNTING WOOD SCREWS ROUND HEAD               |
| 6. SPEAKER COVER 9-3/4 x 17 x 1/2" plywood   | 17. WOOD SCREWS OVAL HEAD 1" (8 req.)                   |
| 7. CLEAT 3/4" x 1 x 17 (4 req.)              | 18. WASHERS (8 req.)                                    |
| 8. CLEAT 3/4" x 1 x 8-1/4 (2 req.)           | 19. RUBBER FEET (4 req.)                                |
| 9. CLEAT 3/4" x 1 x 12 (2 req.)              | 20. WOOD SCREWS, ROUND HEAD (4 req.)                    |
| 10. HANDLE ASSEMBLY                          |   |
| 11. BACK INSULATION 1" x 13 x 16 glass fiber |   |

## FOR YOUR CAR

# Aircraft Weather Receiver

*Easy AM tuner conversion brings in FAA weather reports*

By LAUREN A. COLBY

THROUGHOUT THE UNITED STATES, THE FEDERAL AVIATION Agency maintains a system of low-frequency broadcast stations transmitting recorded weather information in the 200-kHz to 400-kHz band. These stations transmit aviation weather forecasts and regular hourly observations of the actual weather conditions at selected cities within a radius of about 200 miles of the station. While intended for pilots, the information available from these FAA stations can be extremely interesting to anybody who wants to study weather patterns and the flow and movement of weather systems. A list of the stations now in operation and their transmitting frequencies is in the table.

I wanted to install a receiver for aviation weather in my car, so that I could listen to the broadcasts while commuting to work. However, the only available commercial units which would tune the 200-400-kHz band cost \$40 or more, were not designed for use with a vehicle-mounted antenna and were not readily adaptable to dash mounting. So I decided to build my own receiver. I modified a transistor AM broadcast tuner to produce a three-stage trf receiver, fixed-tuned to the 332-kHz weather broadcasts in my area.

My unit is sensitive enough to run off a short antenna, such as a regular broadcast-band auto antenna. It is fixed-tuned, so it comes on with a simple throw of a switch. Thus, mounting on my already cluttered dashboard is unnecessary. Instead, the unit is installed in a cigar box and simply rests on the back seat. It is completely independent of the car radio or the car wiring. And the total cost of the entire unit was around \$20.

To build your own aviation weather receiver, you need one of those little Japanese AM broadcast tuners, such as the one sold by Lafayette Radio for \$7.95, catalog No.



Parts for aviation receiver cost about \$20. Author used an AM tuner (right) and a modular 3-watt amplifier for his unit.

99 H 9040. You also need six 100-pF disc ceramic capacitors and a "universal"-type transistor i.f. transformer (Radio Shack No. 273-515). Finally, you need an audio system of some sort. Mine consists of a modular 3-watt amplifier, Lafayette Radio 99 H 9132, driving a 3-inch, 8-ohm speaker, hung from the coat hook in the car.

The circuit of the tuner is in Fig. 1. After gathering all the components, the first step is to "pad down" the 445-kHz i.f. transformers to the approximate frequency you wish to receive. To do so, connect 100-pF disc ceramic capacitors across the tuned windings of all the i.f. transformers (see Fig. 2). Solder the capacitors to the printed wiring on the bottom of the circuit board. If the frequency of the station you are trying to receive is very low, you may need 150-pF capacitors.

Next, disable the tuner's oscillator by disconnecting

### Transcribed, Continuous Weather Reports

State and City	Call	Freq (kHz)	State and City	Call	Freq (kHz)	State and City	Call	Freq (kHz)
ALA.: Birmingham	BH	224	MAINE: Bangor	BGR	239	OHIO: Cincinnati	LUK	335
ARIZ.: Phoenix	PHX	326	MAINE: Millinocket	MLT	344	OHIO: Cleveland	CLE	344
Tucson	TUS	338	MASS.: Boston	BOS	382	OKLA.: Oklahoma City	OKC	350
CALIF.: Blythe	BLH	251	MICH.: Detroit	DT	388	Tulsa	DW	245
Fresno	FAT	344	Houghton	CMX	227	OREGON: Pendleton	PDT	341
Los Angeles	LAX	332	S. Sainte Marie	SSM	400	Portland	PDX	332
Oakland	OAK	362	Traverse City	TVC	365	Redmond	RDM	368
Red Bluff	RL	338	Duluth	DL	379	PA.: Allentown	AB	400
ENGLEWOOD: Englewood	EWD	379	IN: Int'l Falls	INL	356	Pittsburgh	AGC	254
Grand Junction	GJT	396	MINN.: Minneapolis	MS	266	S. C.: Charleston	CA	239
Trinidad	TAD	329	MISS.: Jackson	JAN	260	Spartanburg	SPA	248
D.C.: Washington	DC	332	MO.: Kansas City	MC	359	S. D.: Rapid City	RAP	254
FLA.: Jacksonville	JAX	344	St. Louis	LM	—	TENN.: Knoxville	TYS	281
Miami	MF	365	Springfield	SGF	254	Memphis	TS	371
Pensacola	PNS	326	Billings	BIL	400	Nashville	BN	304
Tallahassee	TL	379	Bozeman	BZN	329	TEX.: Amarillo	AM	251
Tampa	AMP	388	Great Falls	GT	371	El Paso	EL	242
IDAHO: Atlanta	ATL	266	Missoula	MLS	320	Fort Worth	FT	365
Boise	BO	359	NEB.: North Platte	LBF	224	Galveston	GLS	206
ILL.: Idaho Falls	IDA	350	Omaha	OM	320	UTAH: Delta	DTA	212
IND.: Chicago	MDW	350	Albuquerque	ABQ	230	Ogden	OGD	263
KAN.: Indianapolis	IN	266	N. M.: Roswell	ROW	305	VT.: Burlington	BTV	323
Garden City	GCK	257	NEV.: Elmira	ELM	375	VA.: Roanoke	ROA	371
LA.: Wichita	IC	332	N. J.: Las Vegas	LAS	206	WASH.: Seattle	SEA	362
Grand Isle	GN1	236	N. C.: Newark	EWR	379	Spokane	GEG	365
New Orleans	MS	338	Raleigh	RDU	350	Walla Walla	ALW	356
Shreveport	SHV	230				WIS.: Milwaukee	GM	252
						WYO.: Casper	CPR	269

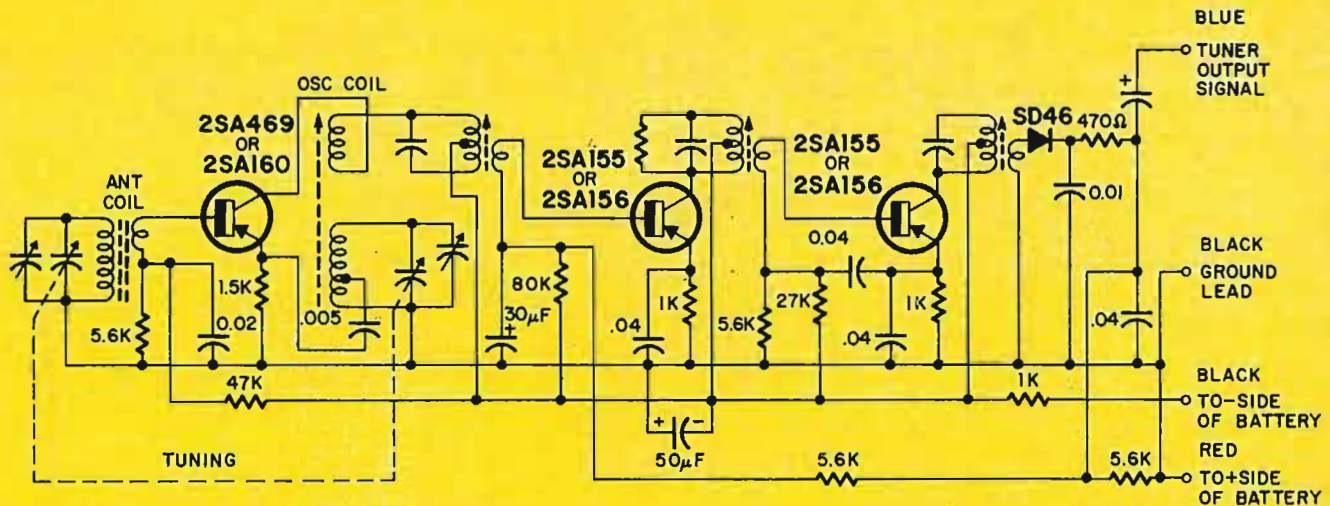

Fig. 1—Modifications to basic tuner circuit include "padding" of i.f. transformers, disabling the oscillator, and a new antenna coil.

and removing the 0.005- $\mu\text{F}$  capacitor which runs from the emitter of the mixer transistor to the tap on the oscillator coil. Then connect the tuner to a 9-volt source and to your audio system.

To prevent motorboating, use a separate battery to power the audio amplifier, and decouple the tuner from the amplifier by installing a 50,000-ohm resistor between the tuner output and the amplifier input.

Now connect a signal generator to the base of the "mixer" transistor. Using a modulated signal, tune the generator from about 300 kHz to 400 kHz, to determine the resonant frequency of the i.f. strip, now that you've padded it down. It should be about 360 kHz. Bring it down or up to the desired frequency by adjusting the slugs in the tops of the i.f. cans.

Remove the ferrite antenna coil and the tuning capacitor assembly. In their place, mount a miniature printed-circuit i.f. transformer. This transformer, which serves as the antenna transformer, is mounted by drilling 1/16" holes in the printed-circuit board, in a pattern corresponding to the lugs on the transformer. To accommodate the transformer, you will have to remove some of the unused printed circuitry on the bottom of the board. Cut the copper with

a knife or sharp-pointed tool, and pry it away from the board. If you break any connections which are still to be used when the receiver is completed, bridge the gaps with hookup wire.

Only the primary or tuned winding of the transformer is used. Pad it down with a 100-pF capacitor and connect it as shown in Fig. 2. Make the connections with light-weight stranded wire. (The lugs on printed-circuit components are very delicate, and the tension from regular No. 20 hookup wire will break them.) I used a short length of twisted-pair phonograph pickup wire to make the connection from the transformer to the transistor, soldering the connections at one end to the transformer lugs and at the other end to the terminals left by the removal of the original ferrite antenna coil.

Be sure to ground the transformer shield, preferably by locating the shield tabs in such a way that one of them passes through a section of grounded circuitry and then soldering it to ground.

Having installed the new antenna coil and the antenna capacitor, bring the signal generator output lead near the antenna lead and peak the antenna coil. Next connect a

(continued on page 97)

Fig. 2—Modified tuner is adjusted to selected weather frequency with i.f. coil slugs. Peak antenna coil after receiver is installed.

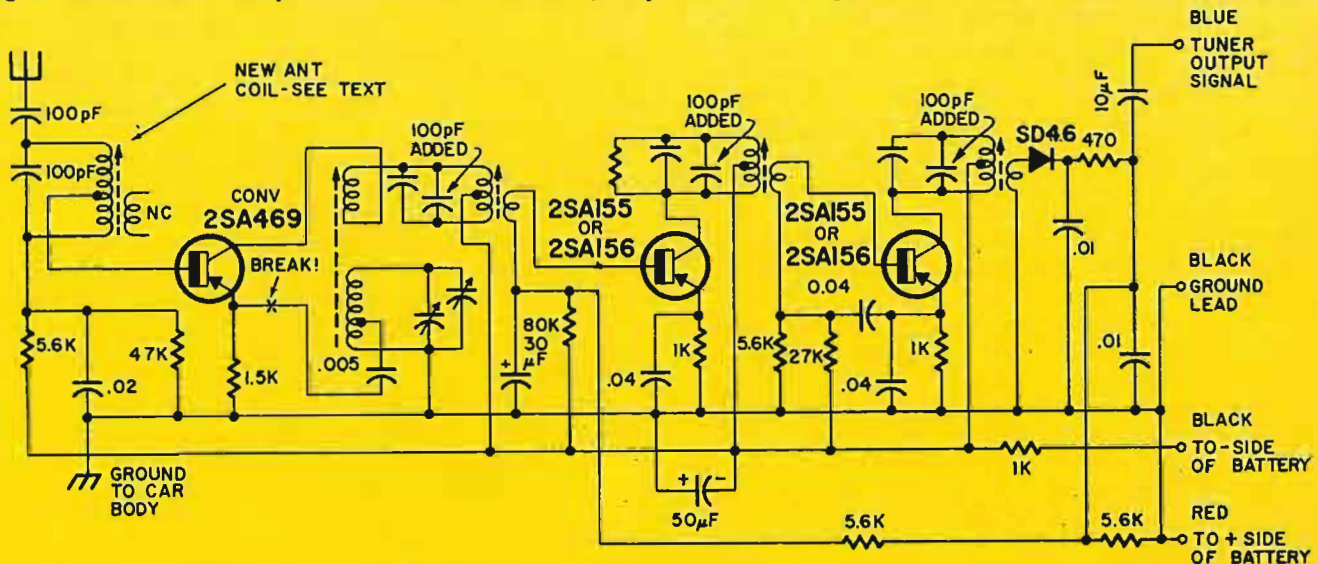

# Look What They're

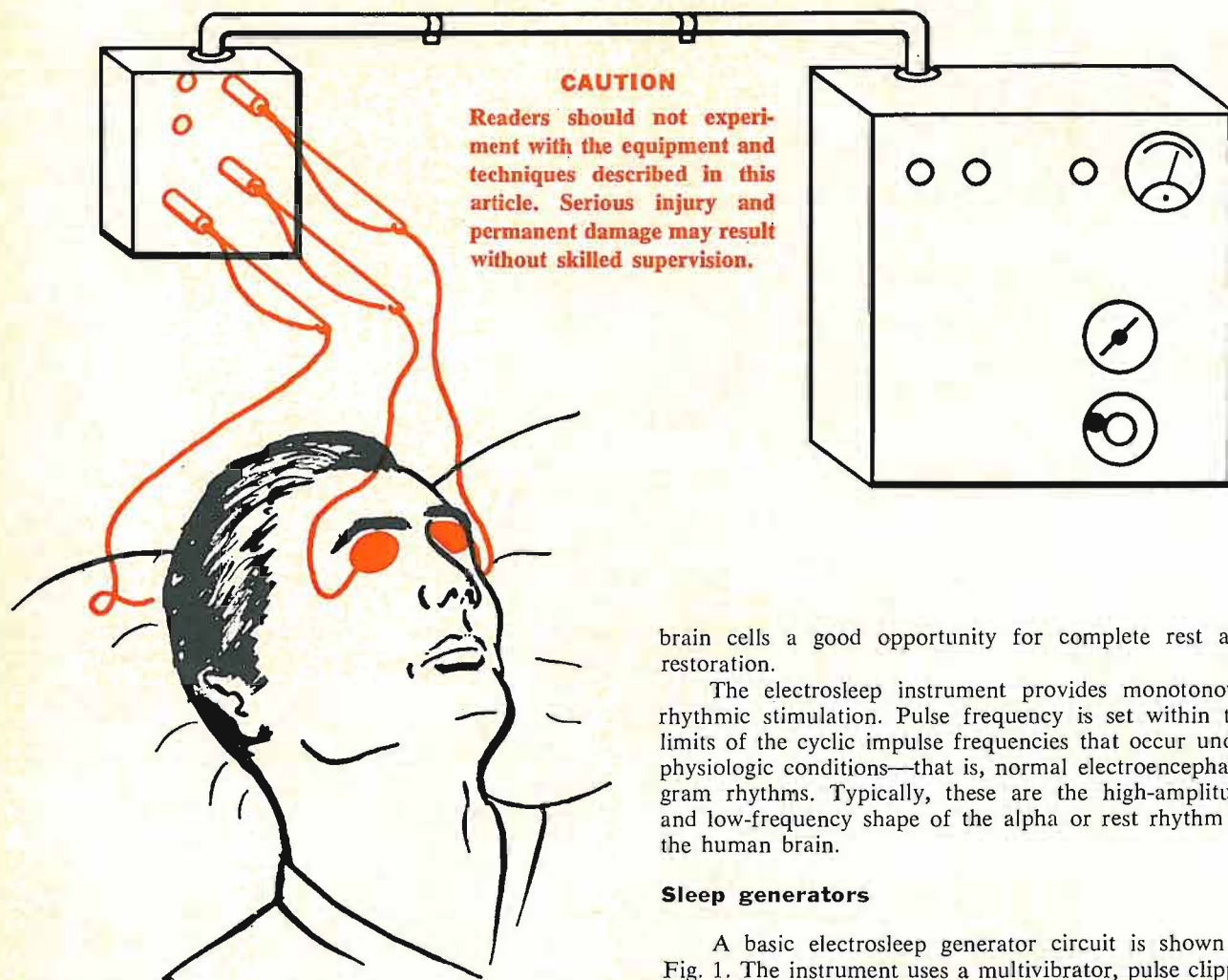

By L. GEORGE LAWRENCE

*When a low-voltage, pulsating current is passed through certain regions of the human head, sleep is induced. It takes special electronics and wave pulses to make it possible.*

"ELECTROSLEEP" IS AN OFFSPRING OF ELECTROANESTHESIA, first practiced by the French scientist S. Leduc in 1902. Leduc used a direct pulsating current to obtain narcosis first on a dog and later on himself.

Contemporary electro-sleep methods and equipment evolved in Russia, and Western buyers purchased early instruments through the trade outlet V/O Sojuzchimizexport, Moscow. Advanced versions of the sleep-inducing pulse generators were the Elektrodorm I and Elektrodorm II models used by Russian and European clinics.

Aside from providing restful, healthy sleep, electro-sleep has been used with good results in the treatment of schizophrenia, a disease many scientists believe results from overexhaustion of the nervous system. In these and similar situations, sleep therapy apparently affords the

brain cells a good opportunity for complete rest and restoration.

The electro-sleep instrument provides monotonous, rhythmic stimulation. Pulse frequency is set within the limits of the cyclic impulse frequencies that occur under physiologic conditions—that is, normal electroencephalogram rhythms. Typically, these are the high-amplitude and low-frequency shape of the alpha or rest rhythm of the human brain.

## Sleep generators

A basic electro-sleep generator circuit is shown in Fig. 1. The instrument uses a multivibrator, pulse clipper and cathode follower, with provisions for metering output. The absence of coupling capacitors enables a galvanic or direct-current component to be obtained at the patient electrodes. Switch S1 and potentiometer R1 determine multivibrator frequency. Pulse duration is adjusted with R2.

In these and similar electro-sleep generators, a rectangular waveform is produced that is not unlike the pattern of the alpha wave mentioned previously.

Current-induction electrodes are placed near the eyes. Typically, a good working impulse lasts from 0.2 msec to 0.3 msec. The *mean current* might have a magnitude ranging from  $6 \mu\text{A}$  to  $12 \mu\text{A}$  or from 1 mA to as much as 8 mA. Some scientists have used frequencies up to 34 Hz, 16 volts peak-to-peak at  $600 \mu\text{A}$ .

A typical experimental situation is shown in the drawing above. A mechanical timer governs the length of the generator's run. Initial treatments in a clinical situation usually last about 30 minutes. Later, time is increased to as much as 2 to 3 hours. After about 15 to 20 treatments have been given to an individual, the course may not be repeated for 2 or 3 months—this changes from case to case. Once the current has been turned off,



# Doing With Electrosleep

a person might "sleep on his own" for 3 to 4 hours or more.

Generally, the ability of the pulsating current to invoke a sleep-like inhibition of the nervous system depends on several factors:

The environment in which the current is applied.

Frequency of treatment repetition and duration of a session.

Characteristics of the current, including direction, frequency, duration, wave envelope, mean pulse strength, electrode placement and so on.

The technique works in the majority of cases, though not with every individual.

## Dream modulation?

Efforts to alter dreams and dream content by means of electrosleep-type electronics are being explored. Subliminal techniques applied in the past consisted of little more than a loudspeaker placed beneath the pillow to provide playback of prerecorded programs.

The fact that scientists observe voltage fluctuations in electroencephalograms (EEG) and find actively discharging neural units in the brain, indicates the brain or at least part of it is *not* at rest during sleep. Although many hypotheses have been formulated, biochemical and biophysical studies during sleep have failed (except for a few promising leads) to yield information about the nature and location of those fundamental processes that determine the basic role of sleep and dreaming.

A neon-type square-wave generator with simple provisions for impressing a speech pattern (or music) on patient electrodes is in Fig. 2. The wave trains, as derived from the square-wave system, are of much lower magnitude than those of electrosleep systems. However, since these trains affect the nervous system, it was hoped the subject's susceptibility to "cue" information (speech and music) could be increased! The idea certainly would be a bestseller on the commercial market—if safe and functional. **R-E**

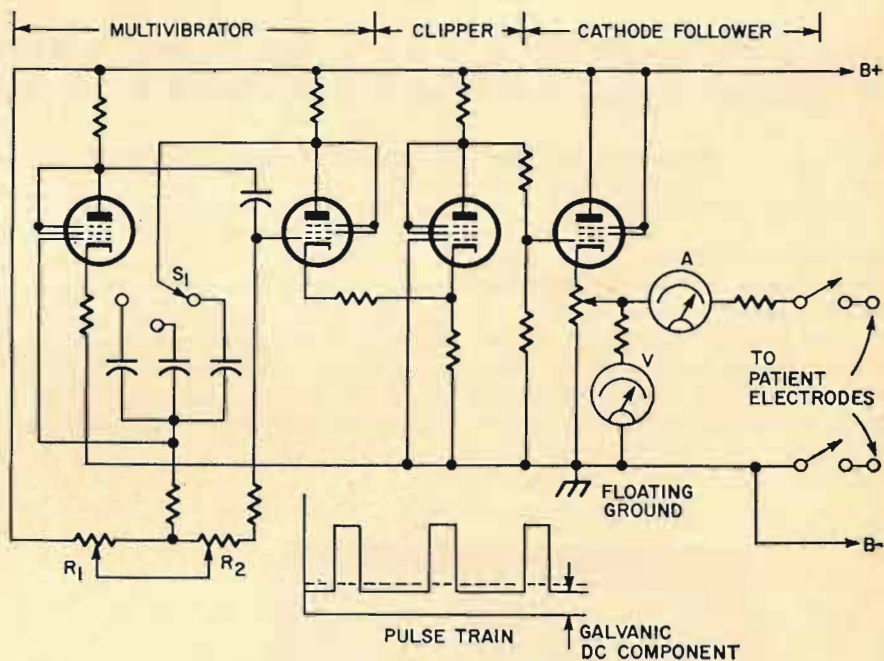
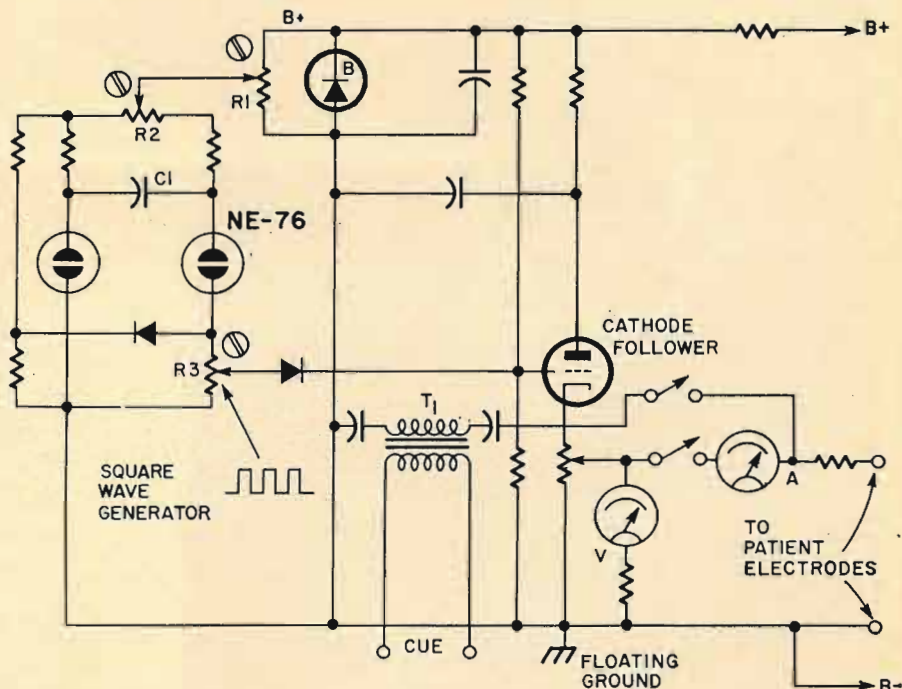

Fig. 1—Output of Russian-developed sleep inducer resembles brain's alpha rhythms.

Fig. 2—Pulse generator for experimental dream modulation has lower output than electrosleep unit. Cued information fed in at T1 may be in speech or music form.



$$\Delta F = \Delta B + \Delta C \text{ (OR } F = EC)$$

NOTE: R1 AND C1 DETERMINE FREQUENCY;  
R2 DETERMINES PULSE WIDTH;  
R3 DETERMINES HEIGHT OF OUTPUT AMPLITUDE;  
T1 TRANSFORMER FOR INSERTION OF PILOT TONE.

# PHOTOTACH FOR YOUR SHOP

*Non-contact device measures operating rpm of any rotating shaft*

By BRICE WARD

HOW WOULD YOU LIKE TO READ THE speed in rpm of any rotating shaft without making physical contact with it? Drill motors, lathes, drill presses, slot-car wheels, capstan drives, turntables and dc tape recorder drives are just a few possibilities. Best of all, how

would you like to do this without fiddling with dials or knobs?

This little hand-held tachometer measures rpm this way: Place a contrasting mark on the shaft, pulley, capstan or what have you, and make sure a steady illumination falls on it (from an *incandescent* lamp or flashlight). Aim the probe, press a push-

button switch and read the rpm directly from the calibrated meter.

Too simple you say? Well, some setups may require your ingenuity and a little juggling. I'd like to hear about any *different* uses of either the complete tachometer or any portion of the circuitry. I would also like to see installation ideas devised by readers for this skeleton system.

## How it works

The *sensing circuit* uses a cadmium selenide cell designed to respond quickly to changes in light level. Other cells could probably be used, but the Clairex unit (see parts list) will provide excellent response out to the limit of the rpm range and probably beyond this range.

Output from the photocell is coupled through capacitor C1 to Q1, used as an amplifier with a voltage gain of about 50 (Fig. 1). The amplified voltage pulse is coupled through C2 to the multivibrator (Q2-Q3).

Transistor Q1 and the photocell, then, form the sensing element circuit. Any device that can deliver a 1-volt or better, positive-going pulse to the multivibrator could be used to drive the meter circuit.

A *pulse standardizing circuit* utilizes a monostable multivibrator followed by a Zener diode. The monostable multivibrator, variously called a one-shot or univibrator, has only one stable state, determined by the feedback arrangement used. Here, the pulse width is determined by the variable time constant of C3-R7, and the pulse height is clamped to a 5.2-volt level by Zener diode D3.

Pulse counting is achieved with a simple half-wave rectifier. It applies the average power of the pulses to the meter, which smooths the pulses by acting as an integrator. A series of waveforms illustrate what occurs in the circuit. All waveforms are positive-going above and negative below the applied zero reference line.

The voltage at point A in Fig. 1 is negative-going with an amplitude of

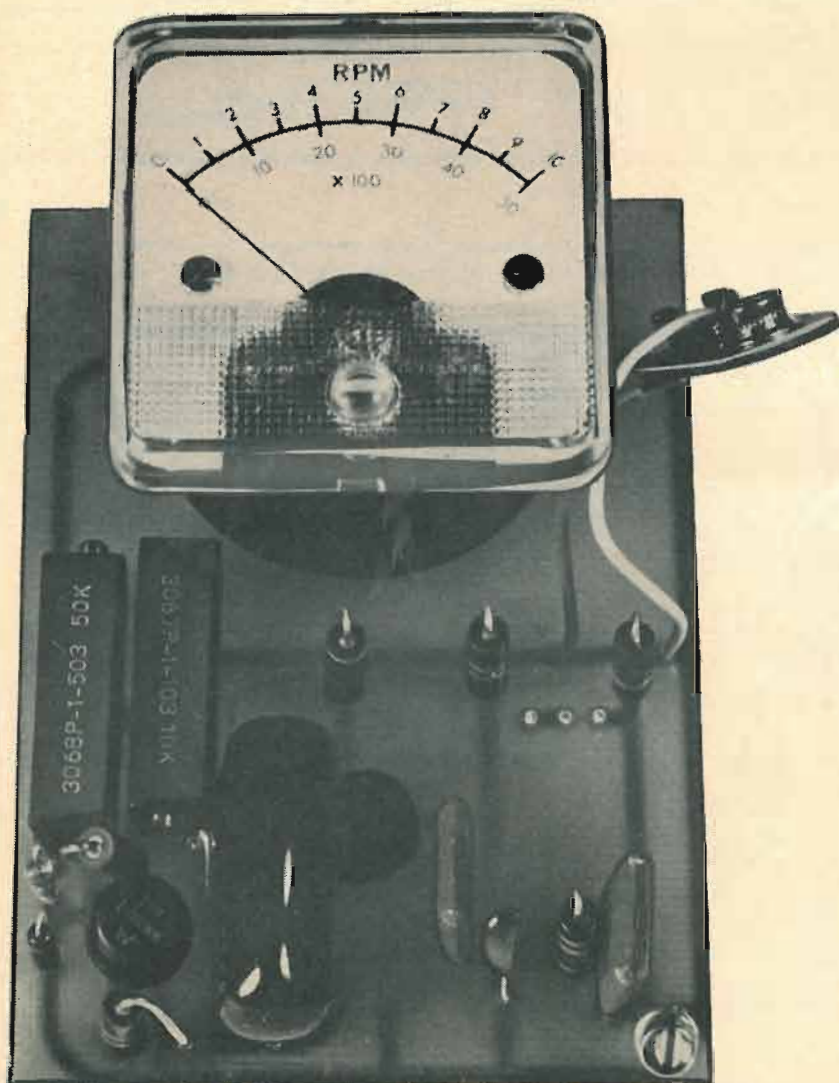

*Meter for the phototachometer is mounted directly on board.*

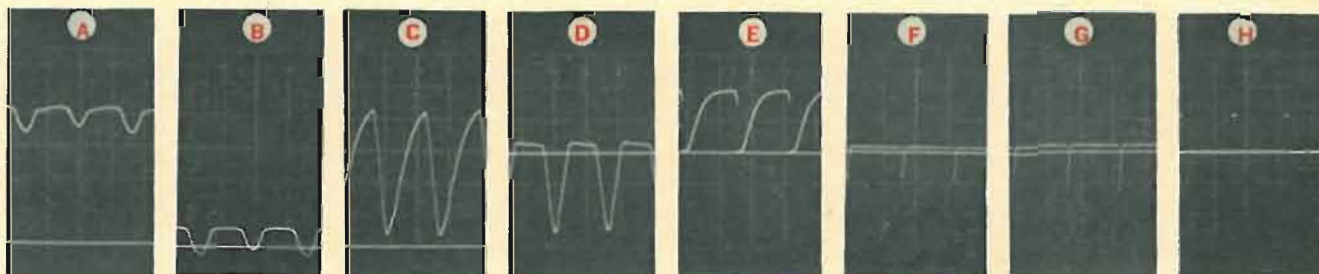
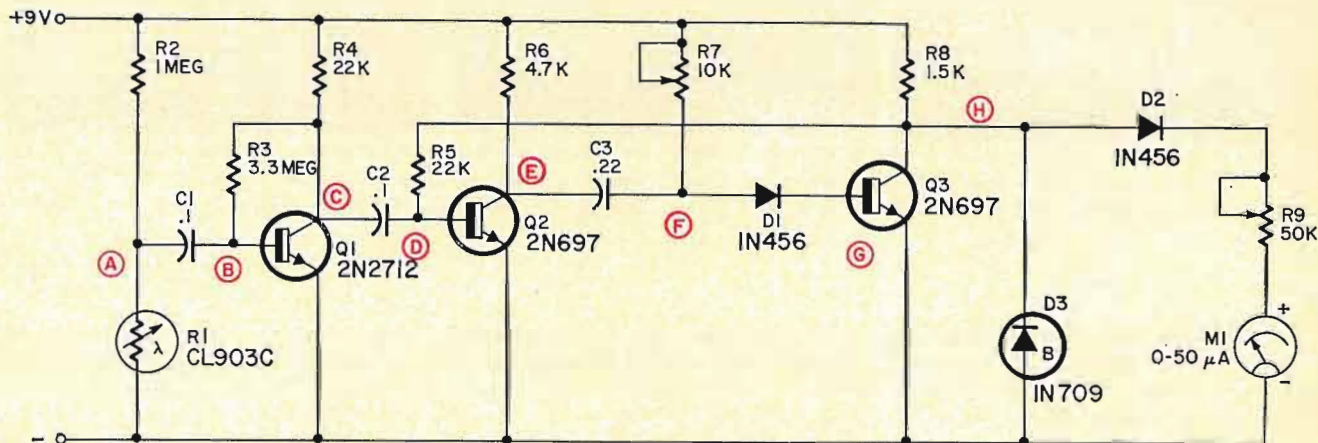

Fig. 1—Using a fluorescent lamp as a signal source, negative-going, 120-Hz input from R1 (A) is 0.8V (from 4.2 level). At B, dc level shifts; base-emitter drop is 0.6V. Pulse amplification is shown at C (2V/cm). As pulses go positive (above reference line) at D, multivibrator-transistor Q2 conducts. As conduction

begins in Q2 (E, top), regeneration drives it into full conduction (5V/cm). Negative pulse width at F is a function of the C3-R7 time constant. Q3's base-emitter current path (G) is through D1. Since D1 is cut off by the signal at F, Q3 is also off. Voltage at H rises to a level that is controlled by Zener diode D3.

about 0.8 volt starting from a 4.2-volt level. This 4.2-volt level will change with the light level on the photocell or the voltage applied to the circuit. (An 18-volt supply should give a 1.6-volt negative-going signal, permitting the probe to be moved back from the pulsing light source.)

Since a fluorescent lamp temporarily extinguishes on each half-cycle of 60-Hz line voltage, pulse frequency is 120 pulses per second, or (multiplying by 60) 7200 rpm. This gives a good source for examining circuit operation, and was used to calibrate the phototachometer.

This voltage pulse output of the cell is coupled by C1 to the base of Q1 (B), overcoming the positive bias on Q1 and cutting it off. The result is decreased current flow through R4 and a consequent reduction in the voltage drop across R4. Since R4 and Q1's collector-emitter resistance represent a voltage divider to ground (from the 9-volt source), if the voltage across R4 decreases, the voltage

across Q1's collector-emitter increases and the voltage on the collector of Q1 (C) increases with respect to ground.

#### Multivibrator operation

In the multivibrator, Q2 is normally cut off and Q3 is conducting. The collector-emitter current of Q3 is then determined by the resistance of R8. With a low Q3 collector voltage, less voltage is returned to the base of Q2 (D) than is required to cause forward base-emitter junction bias.

When the signal on the collector of Q1 swings positive, the voltage rises on the coupling capacitor C2. In trying to charge to this rising voltage, C2 draws current through Q2's base-emitter junction, causing Q2 to conduct and its collector voltage to drop (E).

Capacitor C3, which was charged to about 7.6 volts, begins to discharge through R7, and drives the anode of D1 (F) sharply negative, cutting the diode off. Since Q3's base-emitter current path (G) is through D1, Q3 is cut

off and the voltage at point H rises to a level controlled by D3. The 5.2-volt pulse developed serves to drive the metering circuit, and supplies regenerative bias to Q2.

As long as D1's anode remains negative with respect to its cathode, Q3 will remain cut off, and the length of time that the anode remains negative is determined by the time constant of C3-R7.

In short, the multivibrator has developed a pulse of a width determined by the C3-R7 time constant and a height determined by the Zener diode at its output. On completion of the C3 discharge, the voltage on the anode of D1 goes positive with respect to its cathode and begins to draw current through Q3's base-emitter junction. Next, the voltage drops on Q3's collector feed a negative-going voltage back to the base of Q2, causing Q2 to begin cutting off. The positive-going voltage developed on Q2's collector starts to charge C3, reinforcing the switching cycle by positive feedback.

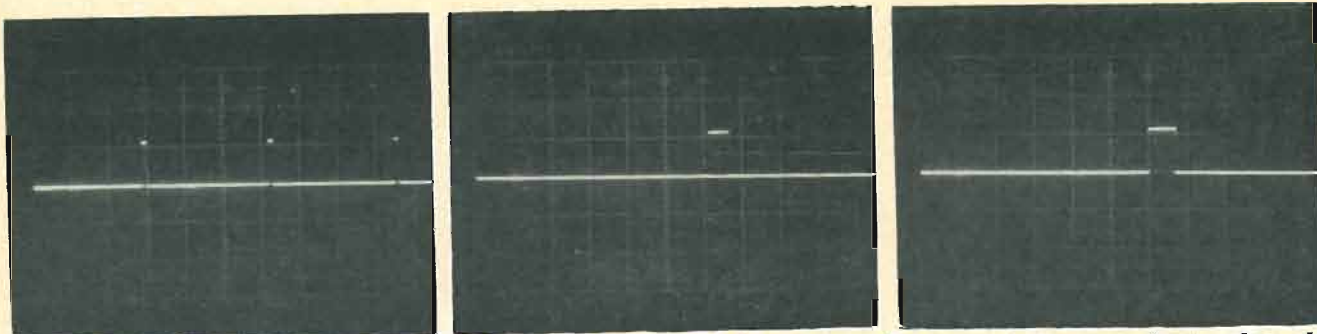

Fig. 2—Scope photo (left) shows pulses at point H with a 3600 rpm (60 Hz) input instead of the 7200 rpm calibrating input (120 Hz) shown in Fig. 1. Pulses appear every 3 cm instead of 1.5 cm, halving the current to the meter. Center photo obtained at point H indicates a pulse width of 0.56 msec. Adjusting R7 increases the pulse width to 0.7 msec (right).

Switching times for Q3 are extremely fast (probably in the nanosecond range), and the entire standard pulse is generated in about 0.56 msec.

Figure 1-h shows pulses generated at 7200 rpm, while Fig. 2 shows them generated at 3600 rpm. The 7200-rpm pulses appear 8.5 milliseconds apart. This means that roughly 14 more pulses could be generated between existing pulses, or a pulse rate equivalent of 100,000 rpm.

At this rate, due to the extra energy generated, the meter range would have to be increased to 500  $\mu$ A to read the total current.

As the system is set up, 10,000 rpm is the upper limit, and R9 is ad-

justed to give a full-scale reading on the meter.

### Construction

For ease of construction, the unit was built on a circuit board. Before installing R7, adjust it with an ohmmeter to about 3500 ohms or, if you prefer, use a 3600-ohm resistor. The photocell (R1) can either be installed on the board or connected with a two-conductor cable for remote location

*Printed circuit board used for the phototachometer is reproduced actual size. You can trace PC board interconnections or transfer the circuit photographically.*

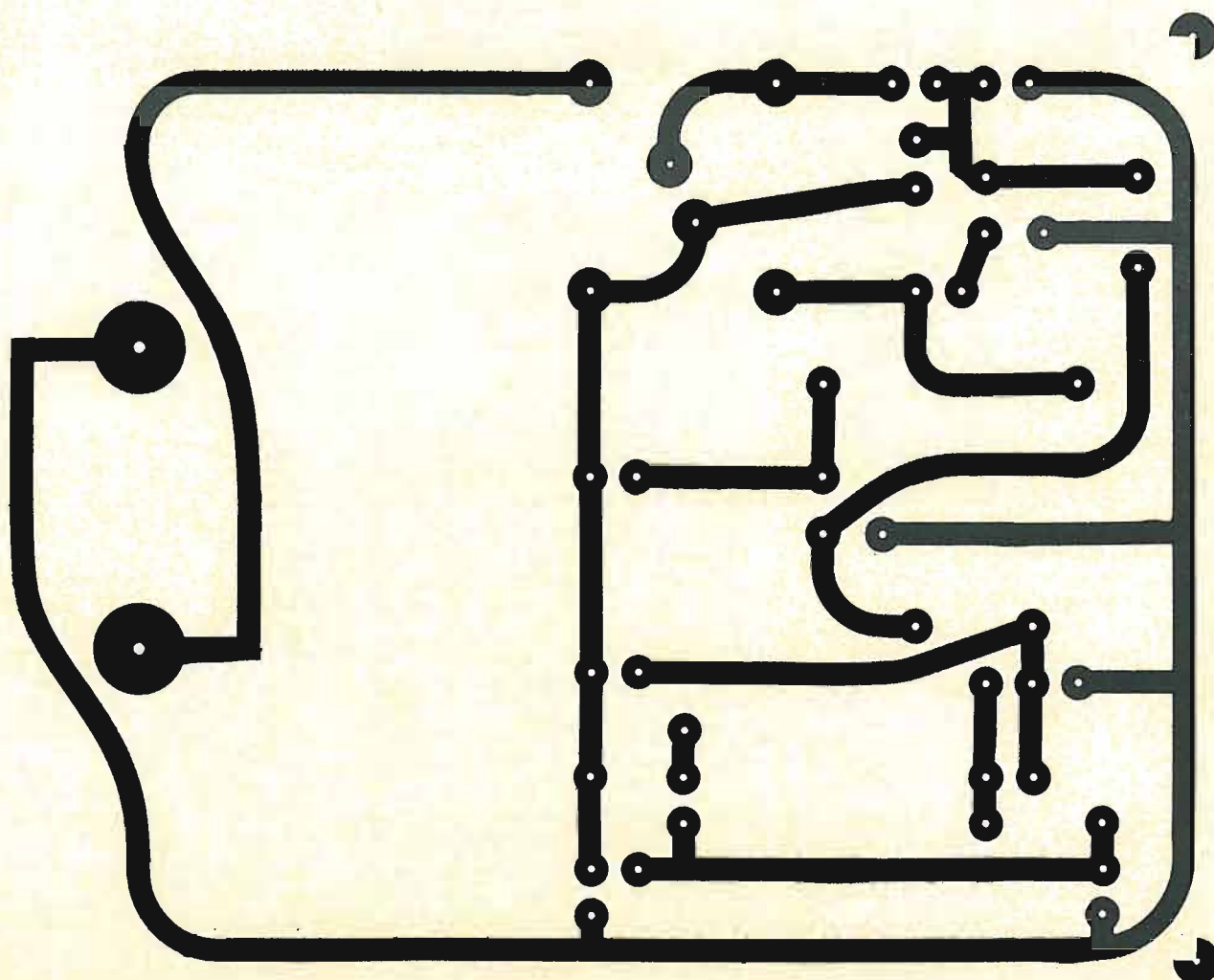

use. Connect the negative battery lead to point A (Fig. 3) and the positive lead to point B. Points C, D and E can be used to raise the voltage on the photocell.

To do this, remove R2 from its present location and install it from point C to point D. Install a second battery with the negative lead going to the old R2 connection (extension from point B) and the positive lead to point E. With this arrangement a pair of 9-volt batteries will apply 18 volts to the photoresistor (increasing its sensitivity), but the circuit still receives only 9 volts.

With 18 volts on it, the probe can be moved farther from the device being measured. Depending on the amount of light striking the rotating shaft, surrounding ambient light and other circumstances, a 9-volt probe will function about 6" from the shaft. With the extra battery, this distance could probably be increased to 12".

The meter is installed with the *plus (+)* terminal to point G and the *minus (-)* or unmarked terminal to point H.

If you're a "scratch" builder or experimenter, the transistors and other

circuit components are not critical. For example, any reasonably good npn silicon transistors should work in the circuit. Reversal of all polarity-sensitive elements and the battery should allow operation with pnp types of transistors.

The Zener diode is not critical either. If it's rated at less than the voltage on the collector of Q3, and clamps the pulse amplitude, this can be corrected by adjustment of R9. The metering diode should be germanium, but this diode and D1 would probably work with silicon devices.

The phototachometer can be used without a case, but since the meter movement supports the circuit board it could be mounted in a case. Make a cutout for the meter and allow the meter to support the circuit board inside the case.

A larger meter movement could be used by drilling holes spaced a little farther apart on the printed circuit board and again hanging the circuit board on the meter.

#### Adjusting your tach

If you use a graduated 50- $\mu$ A meter, every reading will have to be

multiplied by 200. (This is done quickly by adding two zero's and doubling the result.) As mentioned earlier, a fluorescent lamp will provide a 7200-rpm pulse source. Since we want to determine what the meter should read for 7200 rpm, we reverse the procedure: divide 7200 by 2 (3600) and remove two zero's (36) to obtain a setting point for our calibration.

Hold the light cell about 12 inches from the fluorescent light and move it in. The meter should jump to some intermediate value, and then double this value as the probe is moved a little closer. It appears to be characteristic of fluorescent lamps that the light pulse output is higher on one cycle than the other. Therefore, the first meter jump represents a reading of *every other pulse* from the lamp or 60 cycles per second (3600 pulses per minute).

At the point where the meter value doubles, adjust R9 for a reading of 36 on the meter, and the tachometer is calibrated. By proper adjustment of R9, the phototachometer should be capable of reading pulses out to the equivalent of 100,000 rpm. The photocell response time may become a limiting factor at or before this rate is reached.

#### Trying it out

First, in reading something like the propeller on a model airplane engine, remember that if the prop has two blades the indicated rpm will be twice the true rpm since the light is being chopped at twice the actual rpm. And if a disc has 30 segments the indicated rpm will be 30 times the actual.

This applies for any rotating device. Determine the number of full cycles for each revolution and divide the rpm reading by this figure to obtain true shaft rpm.

If you measure very high-speed devices, such as a model airplane engine, it might be necessary to reduce the overall pulse width by reducing either C3 or R7, and to reset R9 to indicate, say, 50,000 rpm full scale.

Other possibilities? Connect the photocell to the circuit board using a long cable. The very small probe can then be mounted at a remote location to monitor some shaft rpm not otherwise easily read.

The unit could be used as a fail-safe. The univibrator pulses could be applied to a rectifying system used to energize a relay. If monitoring shaft rotation, the relay would de-energize and sound an alarm when rotation stopped.

In short, the potential uses for the circuitry are restricted only by your imagination. **R-E**

#### PARTS LIST

- C1, C2—0.1  $\mu$ F, 75-V Mylar capacitor
- C3—0.22  $\mu$ F, 100-V EIMenco 1DP-3-224 or equal
- R1—Clairex CL903C fast-response photocell
- R2—1-megohm, 1/2-watt resistor
- R3—3.3-megohm, 1/2-watt resistor
- R4, R5—22,000-ohm, 1/2-watt resistor
- R6—47,000-ohm, 1/2-watt resistor

- R7—10,000-ohm, Bourns E-Z Trim No. 3067-1-103 potentiometer
- R8—1500-ohm, 1/2-watt resistor
- Q1—2N2712 transistor (G-E)
- Q2, Q3—2N697 transistor
- CR1, CR2—1N456 germanium diode
- CR3—1N709 silicon zener diode
- M1—50  $\mu$ A, 1 9/16" square dc meter (Lafayette Radio 99 H 5049 or equiv)
- MISC—Circuit board, battery clip, 9-V battery

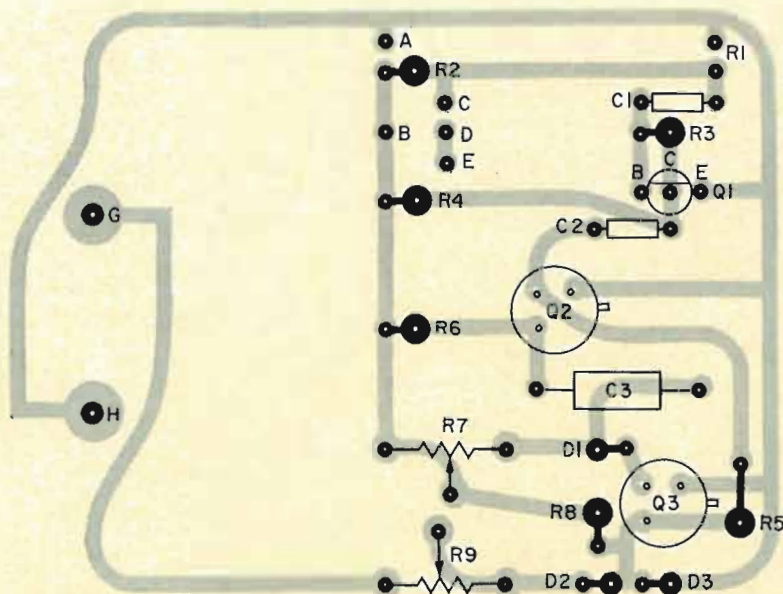
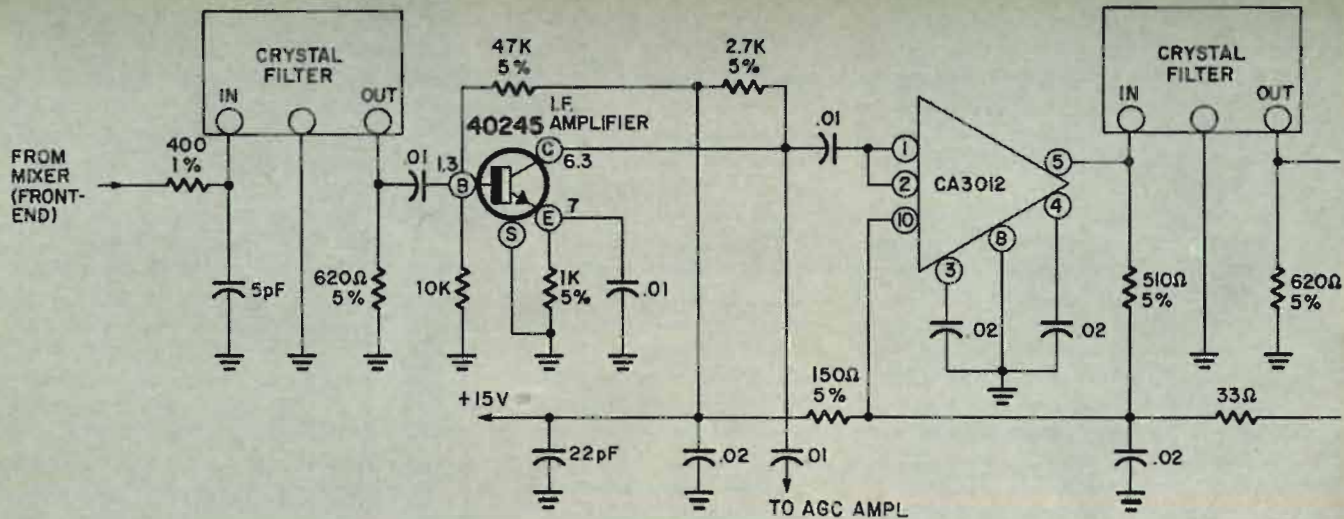

Fig. 3—Component placement on the PC board. Text explains letters A-H.



# What's New in FM Tuners

*IC's and crystal filters in the Heathkit AR-15 and AJ-15—Zero-gain front end in the Marantz 18*

By **PETER E. SUTHEIM**

RAPID ADVANCES IN SEMICONDUCTOR DEVICES HAVE WORKED THEIR way into the FM tuner. Amplifier circuits were easily conquered by the semiconductor, but FM tuners took longer. The requirements are much more stringent than in an audio amplifier. And the need for extremes in frequency response, sensitivity, and signal-to-noise ratio are still rather demanding. However, as you saw last month, FET front ends and ceramic filters have gone a long way toward making FM tuners a new conquest of the semiconductor. Fact of the matter is that the specs on some of the new semiconductor tuners far exceed those attained with vacuum tubes in top-of-the-line tuners of a few years ago.

But now let's look into some more special features and interesting circuitry. IC's are also starting to appear in modern tuners. A good example of IC use is the Heathkit AJ-15 tuner. (The same circuit is also used as the FM tuner section of the Heathkit AR-15 receiver). Here, conventional transistors are used as input and output stages of the i.f. strip (figure above) to provide linear amplification where it is needed. But all the limiter stages are included in two integrated circuits (IC's) and crystal filters are used in place of conventional i.f. transformers.

Want to see what's inside those two IC's? Take a look at the schematic diagram shown below. It is the diagram of

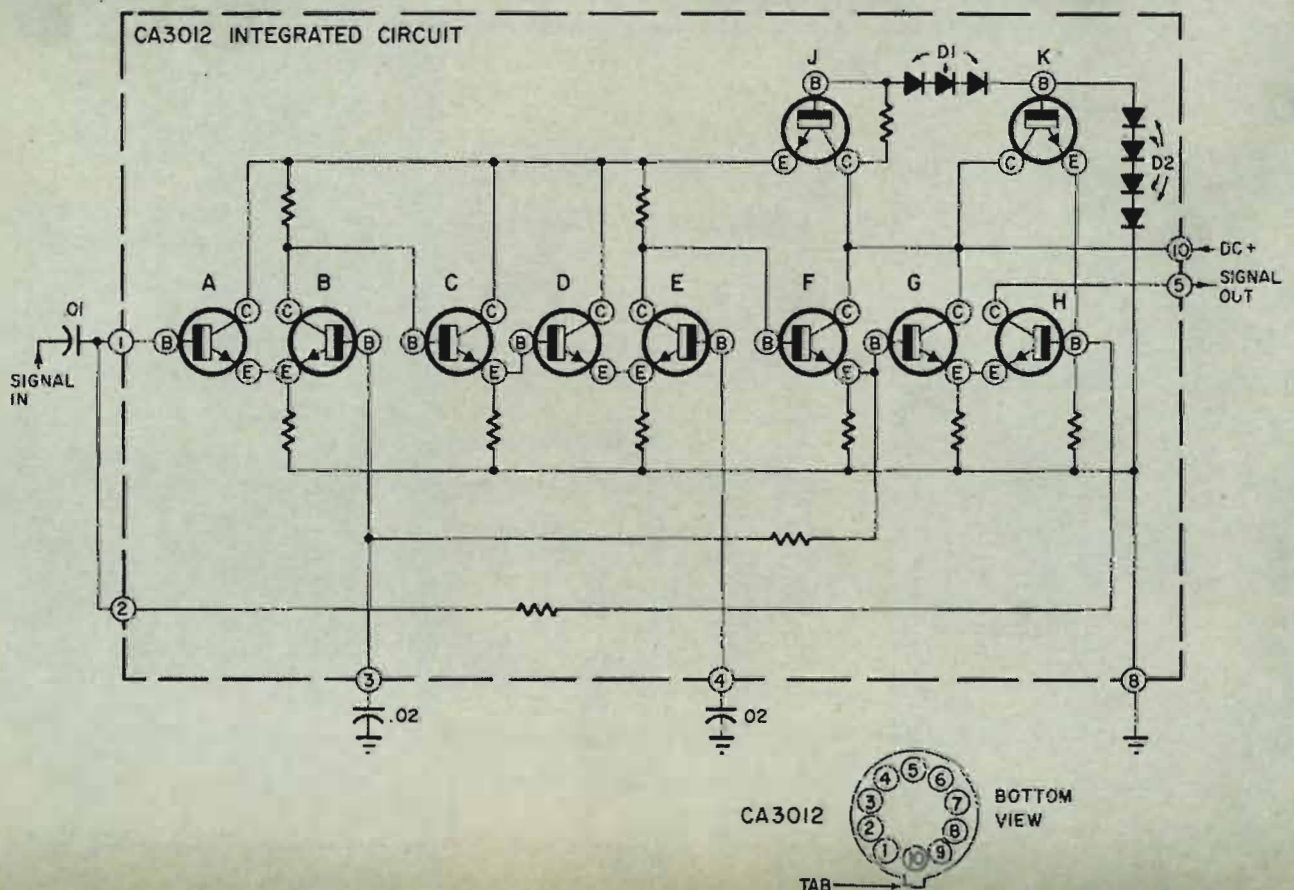

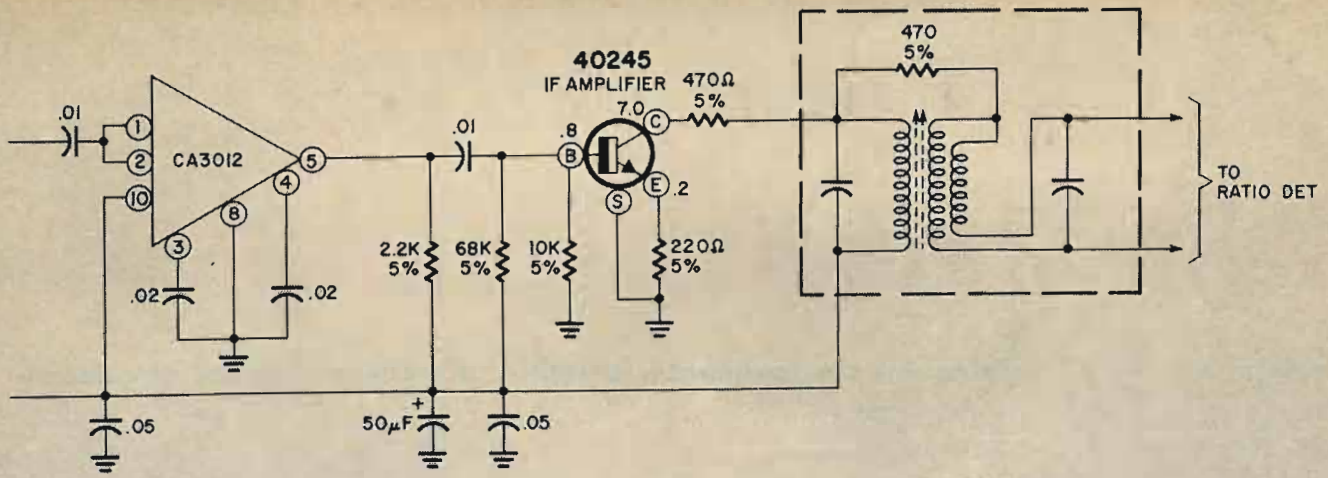

the CA3012 IC. It contains 10 transistors, 7 diodes and 11 resistors. In effect, each of these IC's contains three cascaded emitter-coupled amplifiers which symmetrically clip the 10.7 MHz i.f. signal to provide hard limiting. Much of the pioneering in the use of IC's in FM tuners was done by the H. H. Scott Company.

The specially designed quartz crystal filters replace conventional i.f. tuner circuits and eliminate the need for i.f. alignment, excepts of course for the detector coil. These crystal filters provide a steep-skirted, flat-topped bandpass with very linear phase characteristics at all signal levels.

### Zero gain front end

Stereo tuner front-ends have seen several interesting circuits. But one of the more remarkable circuits to be found in today's FM tuners is in the Marantz 18. Unlike the conventional front-end, their circuit provides absolutely zero gain. In fact, it doesn't have any transistors, tubes, or other active devices except for the transistor in the local oscillator circuit (see figure below). With their special design, Marantz claims a sen-

sitivity of  $2.5 \mu\text{Y}$  for 30 dB quieting. This is not spectacular but is still excellent. What is at least as important, the receiver shines at the other end of the dynamic range scale—its spurious response rejection is a remarkable 100 dB. For all practical purposes this means there is no possibility of cross modulation.

### A \$1050 FM tuner

Another most unusual FM tuner is the CM Laboratories model 804. It introduces digital readout tubes to replace the conventional FM dial. Tuning is said to be positive, to the exact center of the channel. Drift, misalignment and mistuning are eliminated. The new technique pinpoints the frequency since the tuner can be tuned only to the 100 discrete channels designated by the FCC for FM broadcasting. It does this with a crystal frequency synthesizer which produces 100 separate and stable crystal-controlled frequencies. An FET front-end, linear ramp detector and stable L-C, filters instead of i.f. transformers round out the circuits. But at the \$1050 price, it's certainly not the tuner for everyone.

R-E

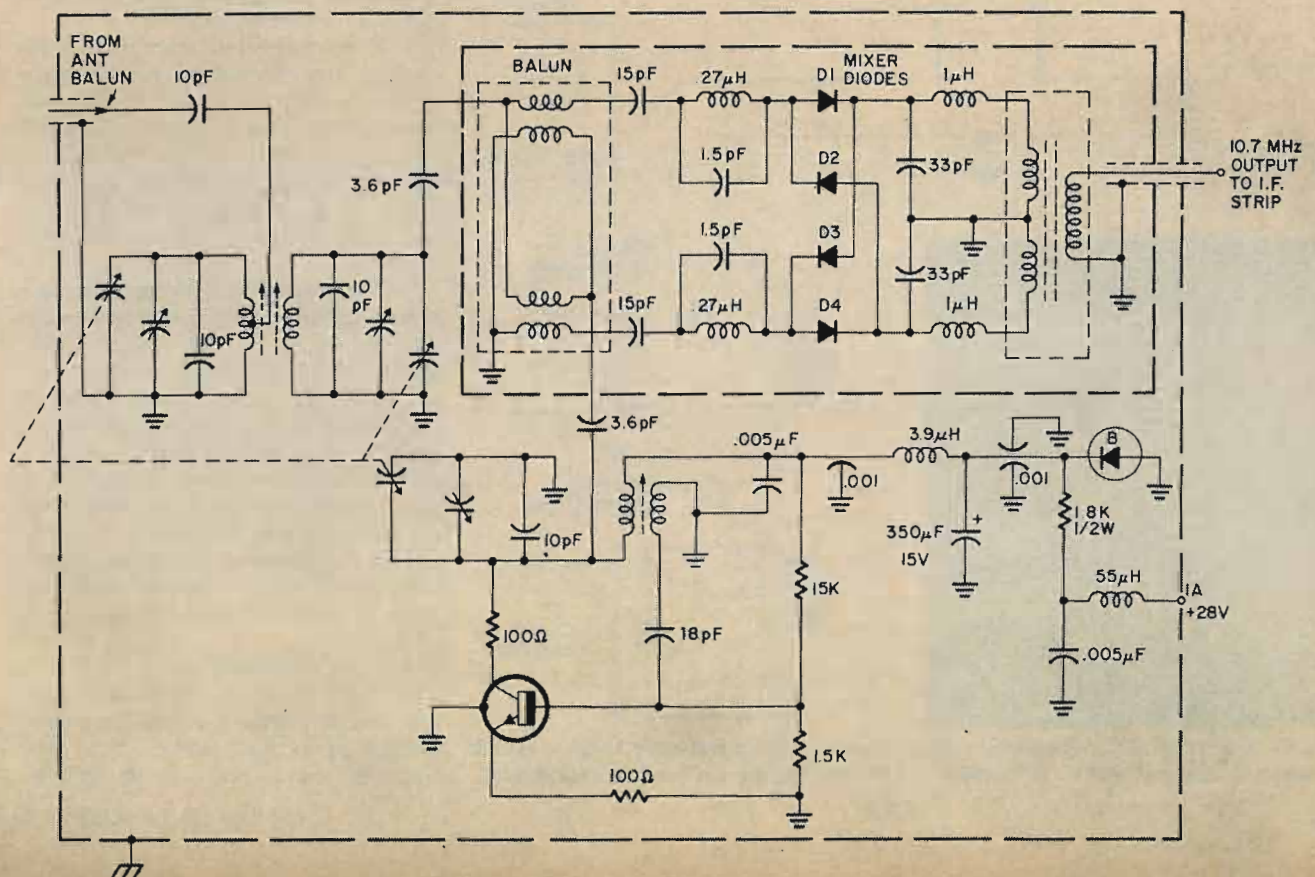

# Solid-State Rectifier Repairs

Expert tips help you pinpoint semiconductor troubles in modern rectifier circuits

By **MATTHEW MANDL**

CONTRIBUTING EDITOR

SILICON RECTIFIERS OUTLAST TUBE types, are smaller, can handle high currents and need no filament or heater voltages. Consequently they are making the tube rectifier obsolete. A silicon rectifier, mounted in an octal-base housing, is even available for direct replacement of an old standby, the 5U4-G.

Generally, silicon rectifiers have replaced selenium types in power supplies, although some seleniums are still used in new equipment (focus rectifi-

ers in some color sets, auto battery chargers, etc.).

The simplicity of solid-state rectifiers, however, can be misleading. They are not trouble-free, and when defects appear an understanding of their characteristics is necessary to make proper tests and replacement. Common failures include opens, shorts, arcing and intermittent operation.

## Rectifier testing

Silicon rectifiers can be checked easily with a vom or vtmv. On the R $\times$ 1K scale, an ohmmeter should

show virtually infinite resistance with reverse polarity, and approximately 500 to 1500 ohms with forward polarity. An infinite resistance reading in both directions shows an open unit, while a low resistance reading in both directions shows a shorted or otherwise defective unit.

Seleniums present more of a problem since they don't have infinitely high resistance in the reverse direction. Even on the R $\times$ 1-megohm scale, readings are misleading. Also, seleniums may continue to rectify, though their internal resistance builds up. Consequently, a higher voltage drop occurs across the rectifier, and output voltage declines.

Thus, it's best to read the output voltage of selenium rectifiers while they are in the circuit and compare it with the specified value. Also check to see that the power supply load is not excessive, because this would also cause a voltage decline.

If you suspect an open or shorted rectifier, you can test it with the setup shown in Fig. 1. A 12-volt filament transformer is used, plus a resistor of about 500 ohms. If the rectifier is shorted, a sine wave appears on the scope. If the rectifier is all right, a half-wave pattern similar to Fig. 2 will appear.

The polarity of the rectifier terminals applied to the tester will make no difference. In one position the pattern of Fig. 2 will be inverted, but still indicates proper rectification. If the rectifier is open, some capacitance leakage may still produce a pattern on the screen, but it would again be a sine wave, indicating a defective unit. (It is a good idea to check new seleniums in this manner—sometimes "new" ones may have deteriorated if they've been in stock for some time.)

## Tips on replacement

Don't replace a silicon or selenium rectifier with one having lower voltage or current ratings. You can, however, use a higher-rated replace-

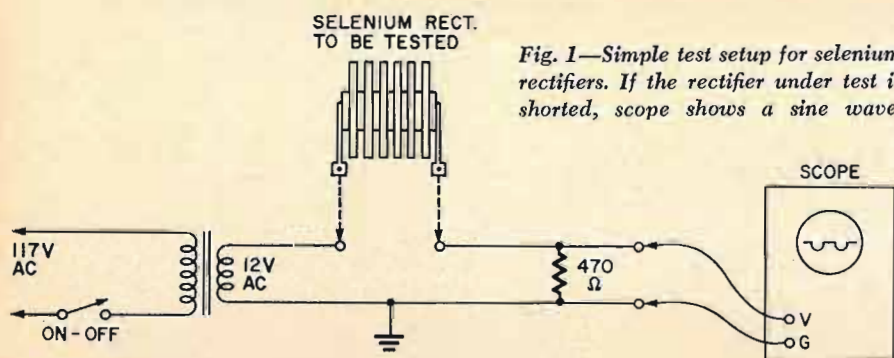

Fig. 1—Simple test setup for selenium rectifiers. If the rectifier under test is shorted, scope shows a sine wave.

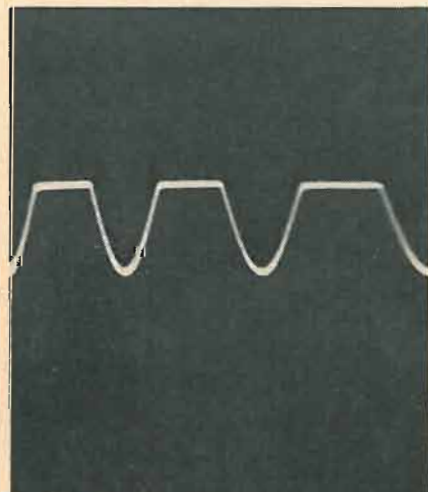

Fig. 2—Half-wave pattern indicates rectification. It may be positive or negative.

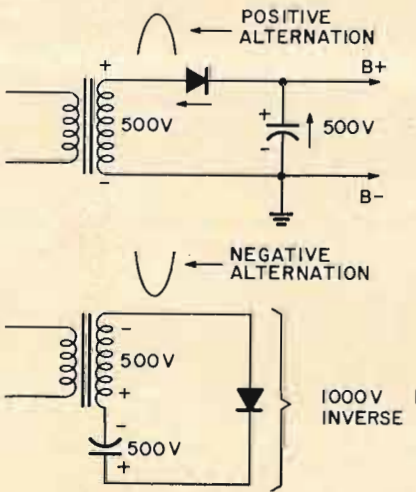

Fig. 3-a—Basic half-wave rectifier circuit b—Development of peak inverse voltage.



ment if the larger unit doesn't take up too much room. Make sure the peak inverse voltage rating is the same (or higher) in the new unit, or the replacement will not last long.

Peak inverse voltage development is shown in Fig. 3. A basic half-wave rectifier circuit is shown at (a). When a positive half-cycle of ac appears across the secondary, electrons flow in the direction shown by the arrows, and the rectifier conducts. The capacitor is then charged to the peak voltage across the secondary. During the negative alternation (b) the charged capacitor can be considered in series with the transformer-secondary voltage source. The rectifier doesn't conduct, but at the peak of the negative alternation the combined voltages (secondary plus charged capacitor) apply 1000 volts to the rectifier (peak inverse or peak reverse voltage). If the rectifier doesn't have a high enough rating, it will be quickly damaged.

If you read 500 volts across an ac source, the meter reads the effective rms value and not the peak. The peak is 1.41 times the rms value. Thus, for Fig. 3, if the 500V represents an rms value, the actual peak voltage across the rectifier will be  $500 \times 1.41 \times 2 = 1410V$ .

### Typical circuitry

Three basic types of power supplies are found in modern TV receivers. One is the half-wave type shown in Fig. 3, where only half cycles are rectified. It requires more filtering for smooth dc output, but needs no transformer center tap.

A second method is full-wave rectification. Two rectifiers are needed with a center-tapped transformer. To avoid the center tap, four rectifiers can be used in the bridge arrangement we'll discuss later. A third method is to use a voltage-doubling system for obtaining a higher potential than that available from a given secondary.

Half-wave systems are not always as simple as Fig. 3. A typical example is the low-voltage supply used in the RCA KCS-158 receiver shown in Fig. 4. Here, L1 and L2 do not form a transformer; instead these are separate filter chokes that minimize noise pickup from the line, and reduce interference fed into the line from the receiver. Capacitor C1 is a low-pass shunt, also for noise signals.

The power transformer is an autotransformer and tap 1 is a voltage stepup terminal for supplying the B+ supply system with a potential higher than line voltage. Tap 2 supplies full voltage to the series heaters. Tap 3 supplies the heater string with a lower-

than-normal voltage to keep it warm and provide an "instant-on" picture when the set is turned on. (The master switch must be in the on position for this operation.)

The half-wave silicon rectifier feeds a filter network consisting of a series choke and two filter capacitors. The circuit breaker protects the system from power supply shorts, while the fuse opens for higher-current faults contributed by the filament string.

"Instant-on" troubles call for a check of the double-pole switch and connections to transformer tap 3. An open circuit breaker calls for testing for shorted filter capacitors or excessive current drain from the circuitry the power supply feeds.

Capacitor C4 is across the rectifier for protection against current surges and transients caused by on-off switching. In most applications using silicon rectifiers, these capacitors are connected across the input or output of the rectifier.

Because of their small size, silicon rectifiers are easily damaged by voltage surges and heat. Heat is dissipated by using metal mounting flanges (or direct mounting on metal chassis). Because perfect flat-surface contact be-

tween the rectifier and the heat sink is difficult to obtain, silicone grease is used to fill the air gaps and help make a good thermal contact.

Thus, when such rectifiers are replaced, coat the heat sink and flange of the rectifier with silicone grease to avoid heat damage. Also, do not replace a rectifier without the accompanying shunting surge capacitor.

A typical voltage-doubler power supply is shown in Fig. 5. When a positive alternation appears across the secondary, rectifier D1 conducts and charges C1 to the peak voltage. With a negative ac alternation across the secondary, D2 conducts and charges C2 to the peak voltage. Because D1 and D2 are in series, a doubled voltage is available across the two. Capacitor C3 shunts both C1 and C2, and hence stores the full double-voltage charge.

If output voltage is low from this supply and the rectifiers check out okay, look for defective charging capacitors. If either C1 or C2 can't hold a full charge, output voltage declines. The rate of discharge from C3 affects output voltage and regulation (ability to hold output voltage with current changes). If a partial short or other excessive current drain exists in the receiver circuitry fed by the power

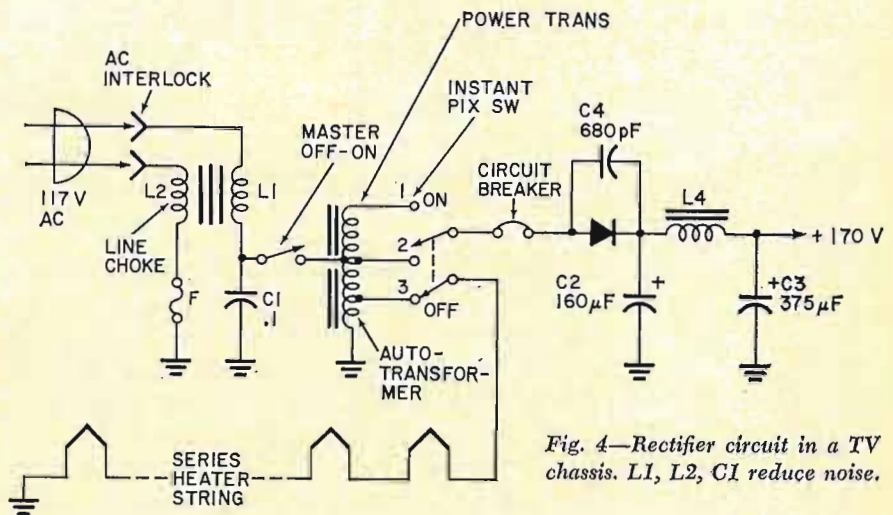

Fig. 4—Rectifier circuit in a TV chassis. L1, L2, C1 reduce noise.

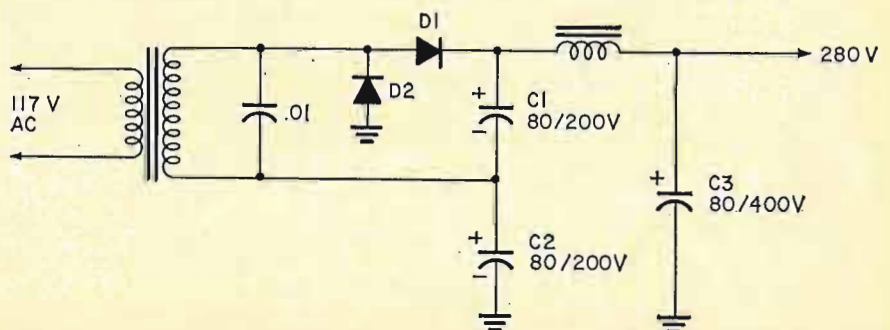

Fig. 5—A voltage-doubler power supply. During positive cycle, D1 conducts and charges C1; on negative cycle, D2 charges C2. Double voltage charge is shunted by C3.



Better than  
9 out of 10  
CIE men win  
their "ticket"  
the very first  
time they try  
(NATIONAL AVERAGE  
IS ONLY 1 OUT OF 3)

## Cleveland Institute of Electronics

# WARRANTY

### of success in obtaining a Government FCC License

The Cleveland Institute of Electronics hereby warrants that upon completion of the Electronics Technology, Broadcast Engineering, or First-Class FCC License course, you will be able to pass the FCC examination for a First-Class Commercial Radio Telephone License (with Radar Endorsement); OR upon completion of the Electronic Communications course you will be able to pass the FCC examination for a Second Class Commercial Radio Telephone License; AND in the event that you are unable to pass the FCC test for the course you select, on the very first try, you will receive a FULL REFUND of all tuition payments. This warranty is valid for the entire period of the completion time allowed for the course selected.

*G. O. Allen*  
Dr. G. O. Allen  
President

# You can earn more money if you get an FCC License

...and here's our famous CIE warranty that you will get your license if you study with us at home

**N**OT SATISFIED with your present income? The most practical thing you can do about it is "bone up" on your electronics, pass the FCC exam, and get your Government license.

The demand for licensed men is enormous. Ten years ago there were about 100,000 licensed communications stations, including those for police and fire departments, airlines, the merchant marine, pipelines, telephone companies, taxicabs, railroads, trucking firms, delivery services, and so on.

Today there are over a million such stations on the air, and the number is growing constantly. And according to Federal law, no one is permitted to operate or service such equipment without a Commercial FCC License or without being under the direct supervision of a licensed operator.

This has resulted in a gold mine of new business for licensed service technicians. A typical mobile radio service contract pays an average of about \$100 a month. It's possible for one trained technician to maintain eight to ten such mobile systems. Some men cover as many as fifteen systems, each with perhaps a dozen units.

## Coming Impact of UHF

This demand for licensed operators and service technicians will be boosted again in the next 5 years by the mushrooming of UHF television. To the 500 or so VHF television stations now in operation, several times that many UHF stations may be added by the licensing of UHF channels and the sale of 10 million all-channel sets per year.

## Opportunities in Plants

And there are other exciting opportunities in aerospace industries, electronics manufacturers, telephone companies, and plants operated by electronic automation. Inside industrial plants like these, it's the licensed technician who is always considered first for promotion and in-plant training programs. The reason is simple. Passing the Federal government's FCC exam and getting your license is widely accepted proof that you know the fundamentals of electronics.

So why doesn't everybody who "tinkers" with electronic components get an FCC License and start cleaning up?

The answer: it's not that simple. The government's licensing exam is tough. In fact, an average of two out of every three men who take the FCC exam fail.

## 2 NEW CIE CAREER COURSES

**1. BROADCAST (Radio and TV) ENGINEERING**... now includes Video Systems, Monitors, FM Stereo Multiplex, Color Transmitter Operation and CATV.

**2. ELECTRONICS ENGINEERING**... covers steady-state and transient network theory, solid state physics and circuitry, pulse techniques, computer logic and mathematics through calculus. A college-level course for men already working in Electronics.

There is one way, however, of being pretty certain that you will pass the FCC exam. And that is to take one of the FCC home study courses offered by the Cleveland Institute of Electronics.

CIE courses are so effective that better than 9 out of every 10 CIE-trained graduates who take the exam pass it. That's why we can afford to back our courses with the iron-clad Warranty shown on the facing page: you get your FCC License or your money back.

There's a reason for this remarkable record. From the beginning, CIE has specialized in electronics courses designed for home study. We have developed techniques that make learning at home easy, even if you've had trouble studying before.

## In a Class by Yourself

Your CIE instructor gives his undivided personal attention to the lessons and questions you send in. It's like being the only student in his "class." He not only grades your work, he analyzes it. Even your correct answers can reveal misunderstandings he will help you clear up. And he mails back his corrections and comments the same day he receives your assignment, so you can read his notations while everything is still fresh in your mind.

## It Really Works

Our files are crammed with success stories of men whose CIE training has gained them their FCC "tickets" and admission to a higher income bracket.

Mark Newland of Santa Maria, Calif., boosted his earnings by \$120 a month after getting his FCC License. He says: "Of 11 different correspondence courses I've taken, CIE's was the best prepared, most interesting, and easiest to understand."

Once he could show his FCC License, CIE graduate Calvin Smith of Salinas, California, landed the mobile phone job he'd been after for over a year.

## Mail Card for Two Free Books

Want to know more? The postpaid reply card bound-in here will bring you free copies of our school catalog describing opportunities in electronics, our teaching methods, and our courses, together with our special booklet, "How to Get a Commercial FCC License." If card has been removed, just mail the coupon at right.

**THESE CIE MEN PASSED THE FCC LICENSE EXAM... NOW THEY HAVE GOOD JOBS**

**Matt Stuczynski,  
Senior Transmitter  
Operator, Radio  
Station WBOE**



"I give Cleveland Institute credit for my First Class Commercial FCC License. Even though I had only six weeks of high school algebra, CIE's AUTO-PROGRAMMED® lessons make electronics theory and fundamentals easy. I now have a good job in studio operation, transmitting, proof of performance, equipment servicing. Believe me, CIE lives up to its promises."

**Chuck Hawkins,  
Chief Radio  
Technician, Division  
12, Ohio Dept.  
of Highways**



"My CIE Course enabled me to pass both the 2nd and 1st Class License Exams on my first attempt... I had no prior electronics training either. I'm now in charge of Division Communications. We service 119 mobile units and six base stations. It's an interesting, challenging and rewarding job. And incidentally, I got it through CIE's Job Placement Service."

**ENROLL UNDER NEW G.I. BILL:** All CIE courses are available under the new G.I. Bill. If you served on active duty since January 31, 1955, OR are in service now, check box on reply card for G.I. Bill information.

**Cleveland Institute of Electronics**  
1776 E. 17th St., Cleveland, O. 44114

Please send me without cost or obligation:

Your 40-page book "How To Succeed in Electronics" describing the job opportunities in Electronics today, and how your courses can prepare me for them.

Your book on "How To Get A Commercial FCC License."

I am especially interested in:

- |  |  |
|--|--|
| <input type="checkbox"/> Electronics Technology  | <input type="checkbox"/> Electronic Communications |
| <input type="checkbox"/> Broadcast Engineering   | <input type="checkbox"/> Industrial Electronics    |
| <input type="checkbox"/> First Class FCC License | <input type="checkbox"/> Electronics Engineering   |

Name \_\_\_\_\_ (PLEASE PRINT)

Address \_\_\_\_\_

City \_\_\_\_\_

State \_\_\_\_\_ Zip \_\_\_\_\_ Age \_\_\_\_\_

Check here for G.I. Bill information

RE-54

**CIE** Cleveland Institute of Electronics  
1776 East 17th Street, Cleveland, Ohio 44114

Circle 20 on reader's service card

supply, the output voltage will drop. If all parts in the supply check out, look for overloading caused in the receiver portion.

A full-wave supply with center-tapped transformer is shown in Fig. 6. Here, each rectifier conducts alternately and thus each half-cycle is rectified for smoother dc output. Since this supplies a transistorized receiver, high-value filter capacitors are used to obtain minimum ripple voltage.

If one rectifier opens, ripple will increase and output voltage will drop. Open filter capacitors will also contribute to ripple, as will a current-drain overload from the supply. In this receiver the uhf-tuner section has no voltage applied except when the vhf tuner is set to the uhf position.

Thus, if uhf reception is lost, check the switch operation and also look for a shorted capacitor (300  $\mu$ F) that bypasses the 11.5-volt output. The

0.001- $\mu$ F noise-filter capacitor shunting the ac line input was omitted from earlier models of this receiver, and should be included when it is found missing during servicing.

Note the switching for battery operation. If trouble occurs during battery operation, check the 12-volt battery under load and also check for proper switch operation.

A typical bridge rectifier system is shown in Fig. 7. Rectifiers D2 and D3 conduct when the upper terminal of the transformer secondary is positive. D1 and D4 conduct when it is negative. Note the high voltage value of the surge (transient) capacitors shunting the secondary. Make sure replacements have as high (or higher) rating to withstand voltage peaks. Similarly, make sure replacement rectifiers are matched to the others and have sufficient peak inverse voltage ratings.

### Focus rectifiers

In color receivers, the 5-kV focus voltage is taken off a tap on the horizontal output transformer, and rectified by either a tube or a solid-state rectifier. For the latter, selenium sections are stacked in sufficient number to handle the high voltage involved, and the circuit uses a filter-resistor network, plus a voltage-variable component such as a variable resistor or a slug-tuned inductor. A typical circuit is shown in Fig. 8.

Because of the high voltage, the selenium stack may arc and cause intermittent focus as well as streaks across the picture-tube screen. If this occurs, blow or brush out any dust accumulation on the stack, and also measure the voltage to make sure it isn't excessive. If the trouble still persists, replacement of the rectifier will be necessary.

A strong odor indicates the unit is defective and sections are shorting out and overheating. Avoid prolonged breathing of this odor, because selenium can produce poisonous fumes. (Selenium itself is poisonous and for this reason the rectifier plates are painted or coated with a thin protective covering to avoid absorption by the skin during handling.)

If poor focus can't be corrected by the focus adjustment, check for an open filter series capacitor (130 pF, 6 kV, in Fig. 8). Also check for an open series (4.7-megohm) resistor, and check for voltage at the pin of the picture-tube socket. If no open circuits or component defects exist, check the rectifier.

### Convergence rectifiers

In addition to power supply and high-voltage rectifiers, rectification is

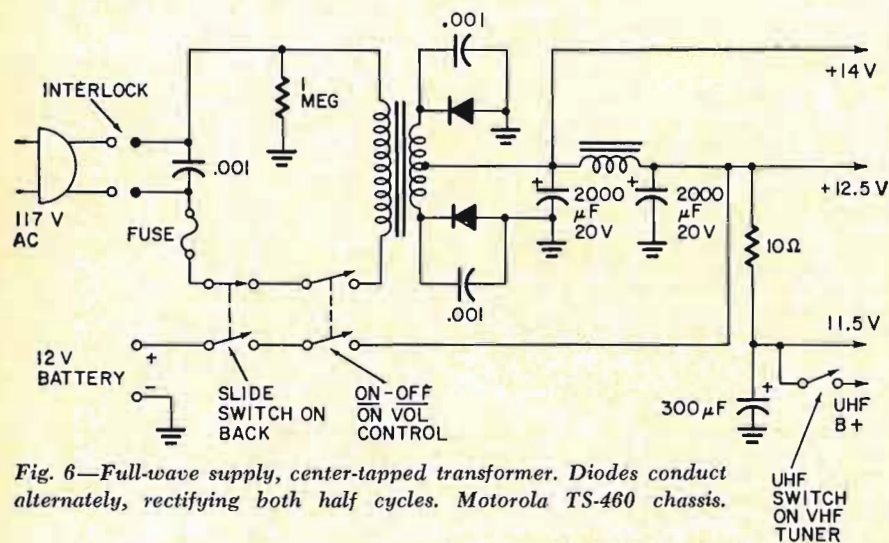

Fig. 6—Full-wave supply, center-tapped transformer. Diodes conduct alternately, rectifying both half cycles. Motorola TS-460 chassis.

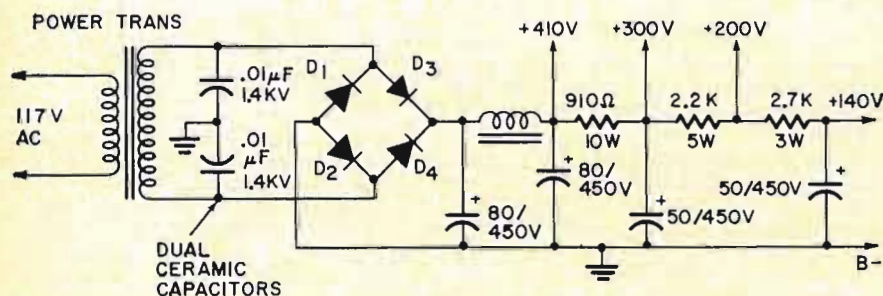

Fig. 7—Typical bridge rectifier circuit. Diodes D2 and D3 conduct when the top of the transformer secondary is positive, D1 and D4 conduct when it has negative polarity.

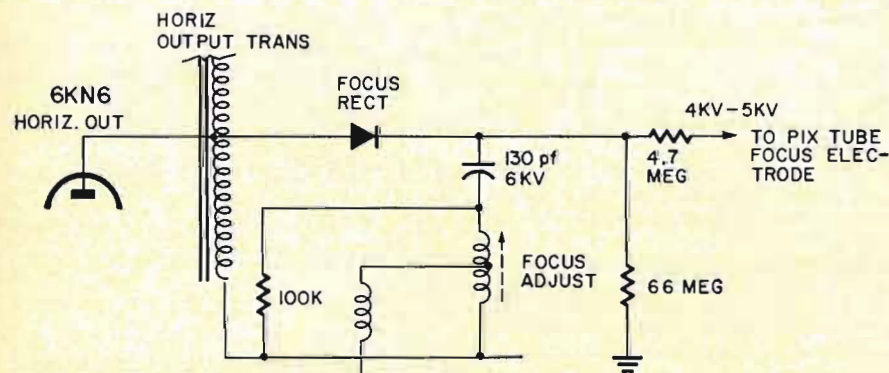

Fig. 8—Focus voltage in color receivers is obtained from a tap on the horizontal output transformer. Rectifier is combined with filter and a voltage-variable component.

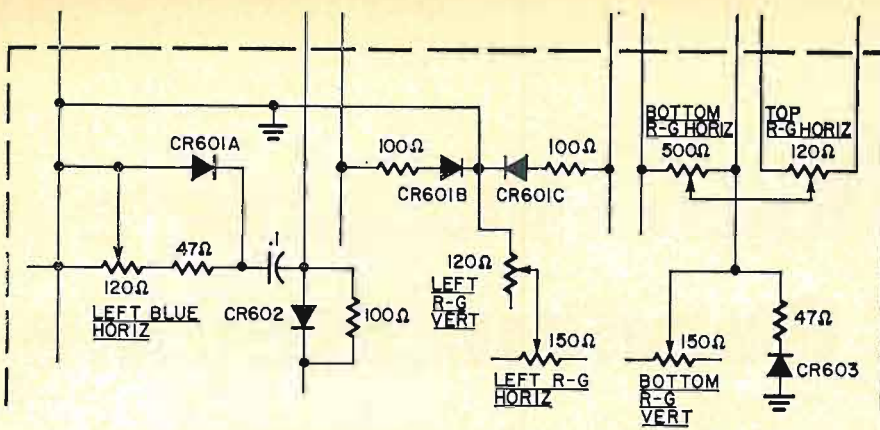

Fig. 9—Convergence circuitry in color receivers also makes use of rectifiers. Defective or intermittent diodes here can cause colors around sharp-contrast scenes.

also used in the convergence circuitry of color receivers. Typical is the circuitry shown in Fig. 9, which is a partial schematic of the Admiral G-13 color convergence board. Note that five solid-state rectifiers are used for the various convergence areas of the screen.

If convergence adjustments fail to produce results, rectifiers should be checked. If one is defective, associated circuit components should also be tested for defects that might have contributed to rectifier failure. Defective or intermittent rectifiers in the convergence circuitry can cause unstable convergence and the appearance of false colors surrounding sharp contrast changes in the televised scenes.

In one receiver an intermittent CR603 (Fig. 9) caused narrow red bands to appear around sharply defined objects in the picture. In another receiver a defective CR601A produced

hue distortion on the screen that could not be corrected by adjustment of the convergence controls.

When one or more rectifiers in the convergence board must be replaced, a dot generator should be used to check convergence before closing the back of the set. This will insure convergence hasn't been even slightly affected by a new unit, or that other component troubles aren't contributing to poor convergence.

Don't expect perfect convergence, particularly at extreme tube edges, because new convergence rectifiers can't compensate for the many variables affecting convergence. If most of the screen area is converged, however, an excellent color picture will be obtained. Excellent (though not perfect) convergence is shown in Fig. 10, where only the dots along the borders are slightly off the true circle representation from the generator. **R-E**

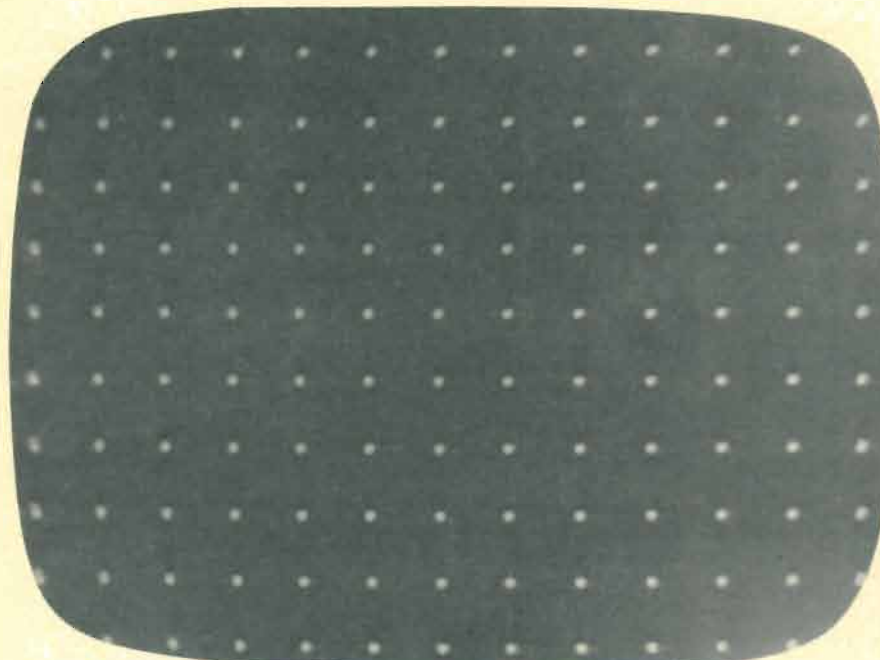
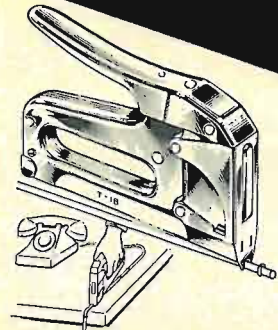

Fig. 10—When convergence diodes are replaced, recheck convergence with dot generator. Photo shows good convergence, even though edge dots are not circular.

# ARROW

## Automatic STAPLE GUN TACKERS

Specially designed for **SAFE — FAST — SECURE** WIRE & CABLE FASTENING



**No. T-18**  
For wires up to 3/16" in dia.  
Uses round crown staples in 3/8" leg only.

BELL, TELEPHONE, THERMOSTAT, INTERCOM, BURGLAR ALARM and other low voltage wiring.

**No. T-25**  
For wires up to 1/4" in dia.  
Uses round crown staples in 9/32", 3/8", 7/16", and 9/16" leg.



Fastens same wires as No. T-18  
Also used for RADIANT HEATING CABLE

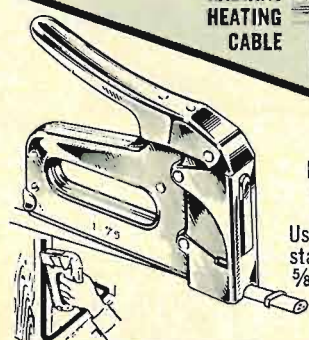

**No. T-75**  
For wires and cables up to 1/2" in dia.  
Uses tack-pointed staples in 9/16", 5/8" and 7/8" leg.

SHEATHED CABLE, RADIANT HEATING CABLE, WIRE CONDUIT, COPPER TUBING, DRIVE RINGS, ETC.

- All-steel, chrome finish.
- Jam-proof mechanism for trouble-free operation

**SAFE!** Driving blade automatically halts staple at right depth of penetration! Can't cut or injure wires and cables.

**FAST!** Powerful single stroke action shoots staples in 1/1000 of a second! Saves 70% in time, effort and efficiency!

**HOLDS!** Staple points diverge to imbed firmly in wood. Rosin-coated for tremendous holding power!

Write for catalog and information.

**ARROW FASTENER COMPANY INC.**  
Saddle Brook, New Jersey 07863

**"Pioneers and Pacesetters For Almost A Half Century"**

# Build a \$10 Experimenter's IC Decimal Readout Module

By RALPH GENTER

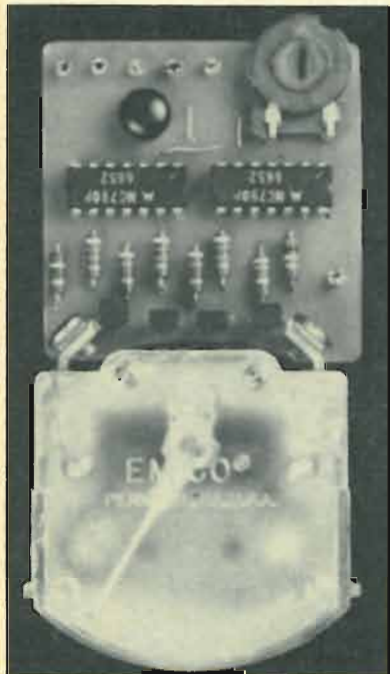

PC module is small (1"x2"x4") and mounts all readout components: decade counter, decoder/driver, and modified panel meter.

THE ASSIGNMENT WAS PLAIN ENOUGH. GET RADIO-ELECTRONICS readers a versatile decimal counting module. Give them a basic block that counts from zero through 9 and indicates it. Make it resettable and cascadable, so any number of units can be placed side by side to obtain any desired accuracy.

Now readers would have the modular heart with which they could build their own electronic counters, digital voltmeters, frequency counters, electronic stopwatches, photographic shutter testers, electronic piano tuners, ballistic velocity meters, adding machines, computers, dragstrip speed measurers . . . and heaven knows what else. Besides, there might be quite a bit to be gained simply by studying such a module, as its operating and service principles would be identical with much of the digital industrial electronic equipment in use today.

The trouble began when we started pinning down the specs on such a unit. It had to be small—not over 1" x 2" x 4", and a one-piece unit. It had to be near foolproof. It had to use integrated circuits—no neon bulbs, diodes, capacitors or critical pulse circuits allowed. It should be snappy, running anywhere from pushbutton speeds on up to 10 MHz. Less than 0.5 W per module of supply power would be nice. And, of course, it must be legible and easy to read, and must read out in plain numbers. Finally, if anyone was going to build one, it would have to cost less than \$10 per decade—experimenter's single-quantity cost.

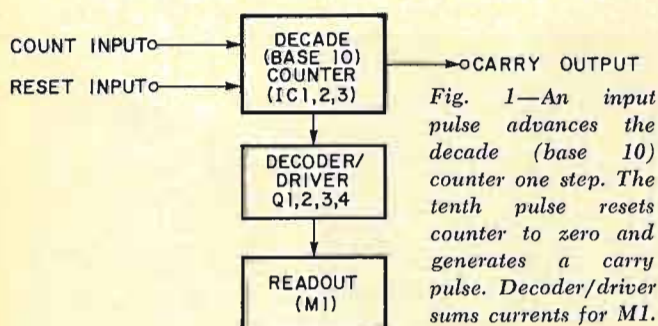

Fig. 1—An input pulse advances the decade (base 10) counter one step. The tenth pulse resets counter to zero and generates a carry pulse. Decoder/driver sums currents for M1.

## \$10 per decade?

This was the stickler. Off to the catalogs. Let's see—Nixie tubes \$8 each . . . DTL integrated decade counters \$10 each . . . decoders \$16 each. . . The IC boys are coming along just fine, but that's almost \$35 per decade, and we're not through yet. No wonder the cheapest digital instruments start at \$300 and work their way up—and up. (\$600 is par for a good electronic frequency

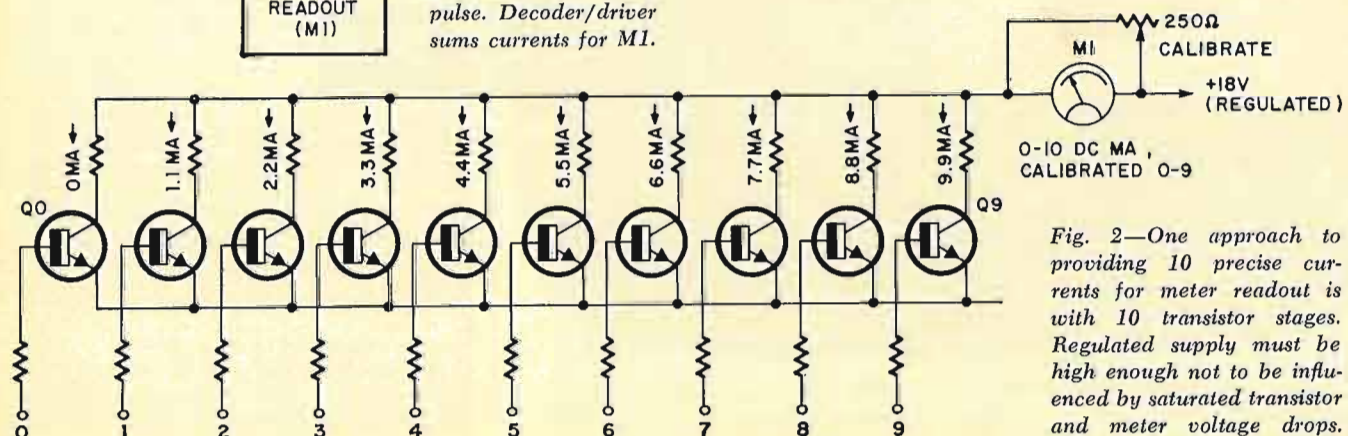

Fig. 2—One approach to providing 10 precise currents for meter readout is with 10 transistor stages. Regulated supply must be high enough not to be influenced by saturated transistor and meter voltage drops.

meter. But hang on—we're going to show you the same thing for around \$60!). No, Nixies are out. So is DTL. Even the old Decatron counters top out above \$20, and they can't touch the speed we need. Besides, that bounding orange dot is hard to follow and harder yet to read. So we start from scratch and find a "new" way.

This is easy enough. Let's draw the problem out in Fig. 1. We need three parts: an electronic decade or base-10 counter, a decoder and a readout. The counter has to work like a 10-position resettable stepper, only at a speed anywhere from dc to 10 MHz. Each individual input pulse has to advance the counter one, and only one, count. When the count gets up to 9, the next input pulse has to reset the counter to zero, and produce a CARRY pulse to hit the next decade over. We also have to be able to reset the counter to the zero state anytime we like. This gets our instrument reading 0000 at the start.

We obviously have to have a readout. This is something that brightly and unambiguously indicates the state the counter is in. We suspect that a *binary* counter that is tricked into thinking it is a decimal counter is a good route to follow. Somehow, we must *decode* the counter to find out what state it is really in. The decoded output is an electrical signal that lights up or moves the readout to indicate the proper count. So that's it—we'll need a counter, a decoder and a readout.

#### The readout

We already voted against Nixie tubes for their price. Ten light bulbs would be nice, but that's at least \$4 worth of driver transistors and \$2 worth of lamps, jewels and panel work. This leaves little for the counter and nothing for the decoding.

How about a meter? For years, Hewlett Packard used ordinary milliammeters to indicate the least significant states on several of their larger industrial counters. The meters had special scales and the current through the meter was arranged so that the pointer could be only in one of 10 positions—but they were 3", \$12 meters.

So, let's update this proved technique. Back to the catalog—Emico's Model 13 horizontal panel meters. All plastic, ¾" wide and less than \$3 each, if we do not pick the most sensitive ones. Let's take a 0-10 dc milliammeter and have a special *vertical* 0-9 scale put on it with boxes for each number—no scale markings. Overlap the boxes to gain legibility. Now, put a bright pointer on the whole thing. We have a readout for \$2 or so that's as good as any vertical in-line readout going. And, yes, you can get them yourselves in single quantities—see the parts list.

Now, all we have to do is provide 10 discrete currents for the meter to indicate. These currents have to be pretty close—well under 5% if there is to be no question which number the meter is pointing to. We could start with 10 transistor switches, 10 resistors and a regulated power supply, perhaps as in Fig. 2. We'll use an 18-volt supply, high enough that the saturated transistor drops and the drop across the meter will not bother us. Now, we make each resistor provide a suitable current, say 1.1 mA, 2.2 mA, 3.3 mA, and so on.

To go one step better, we provide a little *more* current for each step than we really need and shunt some of the extra current *around* the meter with a calibration pot that lets us get number and pointer positions exactly aligned.

Base current to any transistor provides the proper current to allow the meter to indicate which transistor is receiving current, and our readout is complete. Of course, transistor Q<sub>0</sub> really isn't doing anything, so we can leave it out entirely.

How about some of the other transistors? Can we

# Weller®

**makes first class  
soldering the easiest  
part of any job**



**The  
original Dual Heat  
Soldering Guns**

Preferred by technicians for their fast heating copper tips, exclusive trigger-controlled dual heat, and high soldering efficiency. Available in 3 watt-age sizes, each with spotlight.

100/140-watt Model 8200, 145/210-watt Model D-440, and 240/325-watt Model D-550. Also in complete kits:

**Dependable MARKSMAN Irons  
in a size for every job**



Ideal for deep chassis work and continuous-duty soldering, Marksman irons outperform others of comparable size and weight. All five feature long-reach stainless steel barrels and replaceable tips.

- 25-watt, 1¾-oz. Model SP-23 with ⅛" tip (In kit with extra tips, soldering aid, solder—Model SP-23K)
- 40-watt, 2-oz. Model SP-40 with ¼" tip
- 80-watt, 4-oz. Model SP-80 with ⅜" tip
- 120-watt, 10-oz. Model SP-120 with ½" tip
- 175-watt, 16-oz. Model SP-175 with ⅝" tip

**25-watt Technician's Iron  
for intricate circuit work**



Industrial rated pencil iron weighs only 1¾ ounces, yet delivers tip temperatures to 860°F. Cool, impact-resistant handle. All parts readily replaceable. Model W-PS with ⅛-inch tapered tip.

Also available: A new Battery Operated Iron for use with 12 volt battery or 12-24 volt AC/DC source. Complete with 12 ft. cord and battery clips. Model TCP-12.

Complete Weller Line at your Electronic Parts Distributor.

**WELLER ELECTRIC CORPORATION, Easton, Pa.**

WORLD LEADER IN SOLDERING TOOLS  
Circle 25 on reader's service card

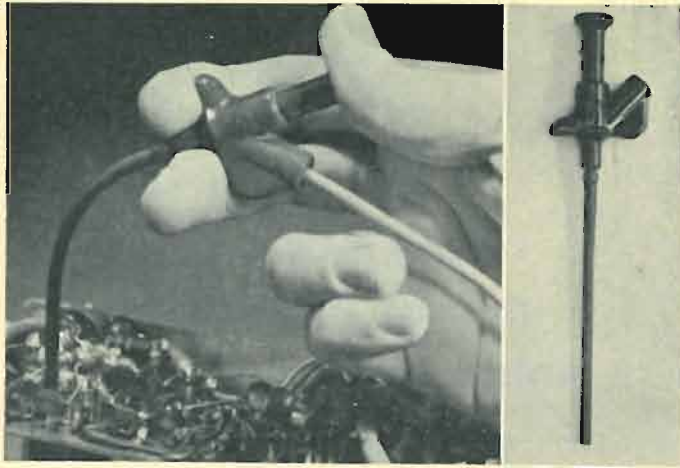

## Clever Kleps 30

Push the plunger. A spring-steel forked tongue spreads out. Like this  Hang it onto a wire or terminal, let go the plunger, and Kleps 30 holds tight. Bend it, pull it, let it carry dc, sine waves, pulses to 5,000 volts peak. Not a chance of a short. The other end takes a banana plug or a bare wire test lead. Slip on a bit of shield braid to make a shielded probe. What more could you want in a test probe?



Available through your local distributor, or write to:

**RYE INDUSTRIES INC.**  
130 Spencer Place, Mamaroneck, N.Y. 10543  
Circle 23 on reader's service card

**\$147**

# FREE

## GIANT 1969 RADIO-TV ELECTRONICS CATALOG

228 GIANT VALUE-  
PACKED PAGES

YOUR BUYING GUIDE FOR . . .  
TV's, Radios, Recorders, Phonos,  
Amateur and CB equipment, elec-  
tronic parts, tubes and test equip-  
ment . . . plus featuring B-A's  
famous bargain packed section!



WRITE FOR YOUR FREE CATALOG TODAY!

BURSTEIN-APPLEBEE CO., DEPT. REW  
3199 MERCIER ST., KANSAS CITY, MO. 64111

Name \_\_\_\_\_  
Address \_\_\_\_\_  
City \_\_\_\_\_  
State \_\_\_\_\_ Zip Code \_\_\_\_\_

Circle 24 on reader's service card

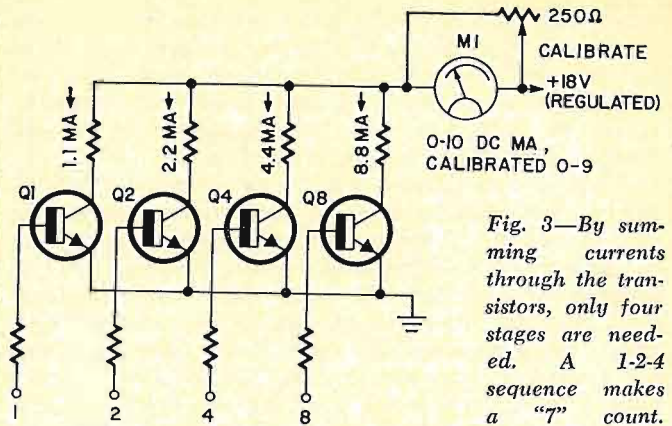

Fig. 3—By summing currents through the transistors, only four stages are needed. A 1-2-4 sequence makes a "7" count.

get rid of a few more? Suppose we *sum* the currents going through the meter, and allow more than one transistor to be on at any one time. If we can get the combinations to line up with the outputs of the base-10 counter, the meter will still give the right answer.

An obvious (but not the best) choice is to use only four transistors and *weight* the currents produced by each transistor in a 1-2-4-8 sequence. To get a 7, we turn on transistors 1, 2 and 4, but *not* 8, giving us  $1.1 + 2.2 + 4.4 + 0 = 7.7$  mA, or count "7" on our readout. This is detailed in Fig. 3. Note that we save 6 transistors and 12 resistors over the original decoder/driver circuit.

Now we are getting somewhere. Let's refine this decoder/driver slightly, and then we can turn our attention to the counter. The weighting resistors really should be 1% units since most of our positional accuracy is going to be needed for the meter tolerance itself. Also it turns out a 1-2-2'-4 weighting is better than a 1-2-4-8 since it saves us a jumper or two on the circuit board and eliminates an awkward step between counts 7 and 8. We have two transistors weighted "2." Either the 2 or the 2' transistor can provide 2.2 mA of meter drive. Together they can provide 4.4 mA. We still can get any number on the readout from 0 through 9. Our final decoder/driver circuit is shown in Fig. 4.

Let's turn to the waveforms we'll need at the bases of our driver transistors. One possible combination that is both weighted 1-2-2'-4 and is easy to get out of a counter is in Fig. 5. This is the one we'll use.

Notice that the 2 output comes up on count 2 and stays there for counts 2 through 9, while the 2' output is used only on counts 4, 5, 8 and 9. The 1 output is used only on the odd counts (1, 3, 5, 7 and 9) and, finally, the 4 output is used only on counts 6 through 9. Taken together, everything adds up to get the right current for the right count.

Our \$10 budget still has around \$5.80 left after we

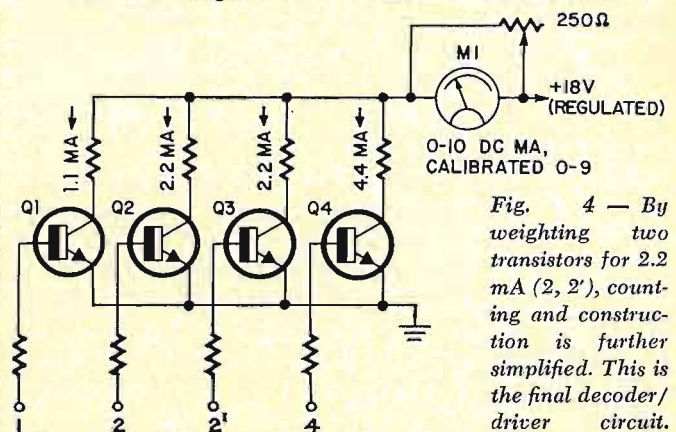

Fig. 4—By weighting two transistors for 2.2 mA (2, 2'), counting and construction is further simplified. This is the final decoder/driver circuit.



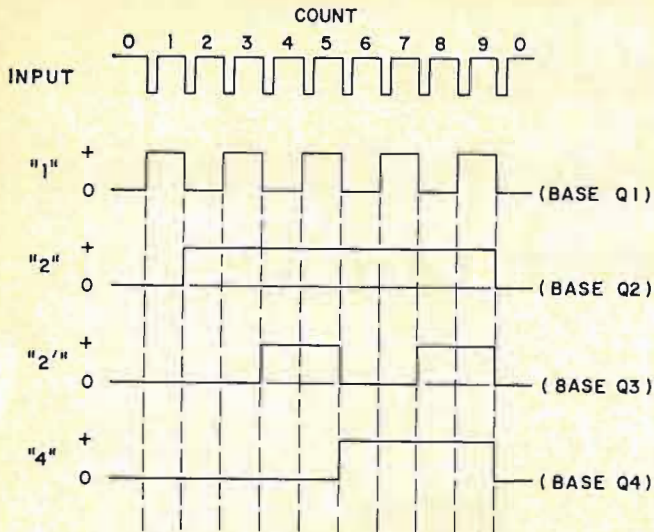

Fig. 5—Waveforms needed on driver bases for correct count.

take out the meter and decoder/driver circuitry. Take out one more dollar for a circuit board, and that leaves \$4.80 for a 1-2-2'-4 coded decimal counter. This is easy—we use RTL microcircuits. Two dual flip-flops and a dual gate, and we're home free. Now, all we have to do is figure out how to hook up the counter.

Suppose we take four JK flip-flops and connect them as shown in Fig. 6. This gives us a four-stage binary divider that takes two dual IC's to count to 16. The trick is to somehow convince this type of circuit that it is really a base-10 counter and make it forget the other six states it once knew. We might first note that this connection

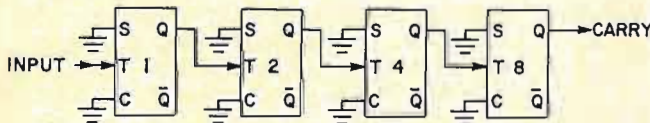

Fig. 6—Four JK flip-flops form a binary divider for a 16 counter.

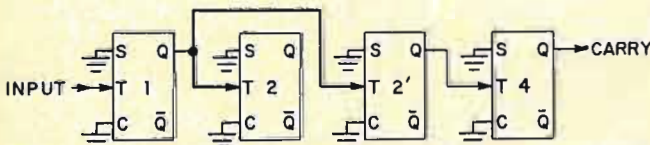

Fig. 7—Connection provides 1-2-2'-4 circuit, but only 8 count.

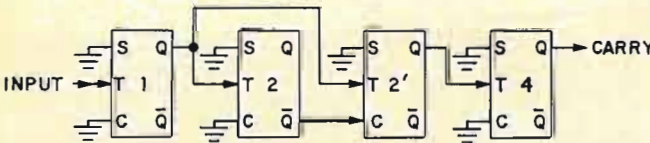

Fig. 8—Hookup inhibits 2' circuit and corrects 2 and 2' count.

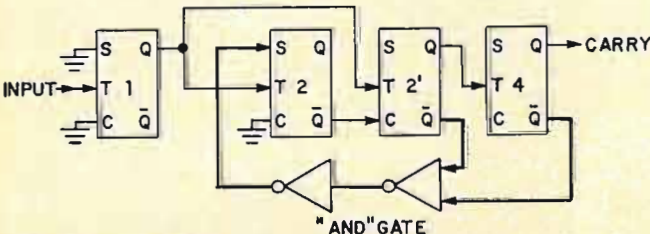

Fig. 9—AND gate inhibits 2 counter for all counts but zero.

# ARE YOU A WINNER?

## DEALER APPRECIATION CERTIFICATE

Serial Number:

**RAYTHEON**

Receiving Tubes You Can Trust

This certificate has no cash value, but the radio/television service dealer in possession of this certificate may be a winner in Raytheon's 1968 Dealer Appreciation Program which ends September 30, 1968.

# YOU ARE

—if you have a Raytheon Dealer Appreciation Certificate bearing any one of these 104 numbers:

1680	10050	12390	15092	18079
2070	10053	12574	15145	18168
4637	10129	12780	15151	18200
8100	10134	12863	15245	18210
8181	10580	12919	15455	18247
8226	10791	12994	15510	18309
8237	10810	13075	15905	18377
8290	10845	13209	15955	19025
8389	10930	13286	16000	19229
8555	10997	13526	17005	19233
8600	11035	13978	17073	19327
8723	11091	14007	17199	19423
8939	11111	14019	17211	29229
8981	11215	14101	17329	30897
9009	11380	14123	17362	33261
9048	11577	14179	17440	33397
9333	11607	14749	17600	35785
9650	11776	14797	17619	36900
9899	11888	15000	17706	37877
9958	12009	15037	18007	38088
9961	12127	15065	18030	

**New! Ask your distributor about Raytheon's Stanley tools for box tops promotion!**

Just take your prize-winning certificate to your Raytheon distributor. He'll make all arrangements to get your prize—whether a color TV set, golf clubs, savings bond, or one of many others—promptly to you.

Lucky you! You're always a winner with reliable Raytheon receiving tubes. Raytheon Company, Receiving Tube Operation, Fourth Avenue, Burlington, Massachusetts 01803.

**Remember to ask "What else needs fixing?"**

**RAYTHEON**

Circle 26 on reader's service card

# Two more examples of how RCA Institutes provides up-to-the-minute Home Training in all phases of electronics:

## NEW CATV LESSONS

The demand is heavy for technicians in the booming field of CATV (Community Antenna Television Systems).

CATV was initially used to make it possible for large numbers of television receiver users to get good reception in remote areas through the use of a common antenna. It now brings to more people more programs than are available from local stations. It also improves reception where multipath signal transmission exists.

RCA Institutes includes two comprehensive lessons, covering the practical phases of CATV systems and servicing in Television Servicing and Communications courses and programs at no additional total tuition cost. Get in on the ground floor of this rewarding and expanding field. Send for full information today!

Prepare yourself for a career in the expanding field of CATV.

## NEW COLOR TV KIT

To make courses even more practical and to better prepare you for a more rewarding future, RCA Institutes now includes an exciting Color TV Kit in both the beginner's program and the advanced course in color TV servicing. The cost of the kit is included in the tuition—nothing extra to pay. You also get five construction/experiment manuals plus a comprehensive service manual.

You'll receive all the materials and components to perform over 50 information-packed experiments. When you finish you'll have constructed an 18" (measured diagonally) high quality, color TV set, complete with rich cabinet in wood grain design.

Get all the details on RCA Institutes' valuable new Color TV Kit!

SEND THE ATTACHED CARD TODAY!

This is the high quality color TV set you'll construct, complete with rich cabinet in wood grain design.



# Learn electronics at home faster, easier, almost automatically—with RCA AUTOTEXT

Are you just a beginner with an interest in the exciting field of electronics? Or, are you already earning a living in electronics and want to brush-up or expand your knowledge in a more rewarding field of electronics? In either case, AUTOTEXT, RCA Institutes' own method of Home Training will help you learn electronics more quickly and with less effort, even if you've had trouble with conventional learning methods in the past.

## THOUSANDS OF WELL PAID JOBS ARE OPEN NOW TO MEN SKILLED IN ELECTRONICS!

Thousands of well paid jobs in electronics go unfilled every year because not enough men have taken the opportunity to train themselves for these openings. RCA Institutes has done something positive to help men with an aptitude and interest in electronics to qualify for these jobs.

## HOME STUDY CAN TRAIN YOU FOR REWARDING CAREER OPPORTUNITIES

To help fill the "manpower gap" in the electronics field, RCA Institutes has developed a broad scope of Home Training courses, all designed to lead to a well paying career in electronics in the least possible time. You also have the opportunity to enroll in an RCA "Career Program" exclusively created to train you quickly for the job you want! Each "Career Program" starts with the amazing AUTOTEXT Programmed Instruction Method. And, all along the way, your program is supervised by RCA Institutes experts who become personally involved in your training and help you over any "rough spots" that may develop.

## VARIETY OF KITS ARE YOURS TO KEEP

To give practical application to your studies, a variety of valuable RCA Institutes engineered kits are included in your program. Each kit is complete in itself, and yours to keep at no extra cost. You get the new Programmed Electronics Breadboard for limitless experiments, including building a working signal generator, multimeter, and a fully transistorized superheterodyne AM receiver.

## ONLY FROM RCA INSTITUTES— TRANSISTORIZED TV KIT— VALUABLE OSCILLOSCOPE

All students receive a valuable oscilloscope. Those enrolled in the Television program receive the all-new transistorized TV Kit. Both at no extra cost and only from RCA Institutes.

## CHOOSE THE "CAREER PROGRAM" THAT APPEALS MOST TO YOU

Start today on the electronics career of your choice. Pick the one that suits you best and mark it off on the attached card.

- Television Servicing
- Telecommunications
- FCC License Preparation
- Automation Electronics
- Automatic Controls
- Digital Techniques
- Industrial Electronics
- Nuclear Instrumentation
- Solid State Electronics
- Electronics Drafting

## ADVANCED TRAINING

For those already working in electronics, RCA Institutes offers advanced courses. You can start on a higher level without wasting time on work you already know.

## 2 CONVENIENT PAYMENT PLANS

RCA Institutes offers a unique tuition plan that lets you progress at your own pace. You only pay for lessons as you order them. You don't sign a contract obligating you to continue the course.

There's no large down-payment to lose if you decide not to continue.

However, if you desire, RCA Institutes also offers a convenient monthly payment plan.

## CLASSROOM TRAINING ALSO AVAILABLE

If you prefer, you can attend classes at RCA Institutes Resident School, one of the largest of its kind in New York City. Coeducational classroom and laboratory training, day and evening sessions, start four times a year. Simply check "Classroom Training" on the attached card for full information.

## JOB PLACEMENT SERVICE, TOO!

Companies like IBM, Bell Telephone Labs, GE, RCA, Xerox, Honeywell, Grumman, Westinghouse, and major Radio and TV Networks have regularly employed graduates through RCA Institutes' own placement service.

**SEND ATTACHED POSTAGE PAID CARD TODAY. FREE DESCRIPTIVE BOOK YOURS WITHOUT OBLIGATION. NO SALESMAN WILL CALL.**

All RCA Institutes courses and programs are approved for veterans under the new G.I. Bill.

Accredited Member  
National Home Study Council

IF REPLY CARD IS DETACHED—SEND THIS COUPON TODAY

RCA INSTITUTES, Inc., Dept. REQ-N8  
320 West 31st Street, N.Y., N.Y. 10001

Please rush me FREE illustrated catalog. I understand that I am under no obligation, and that no salesman will call.

Name \_\_\_\_\_ Age \_\_\_\_\_  
(please print)

Address \_\_\_\_\_

City \_\_\_\_\_

State \_\_\_\_\_ Zip \_\_\_\_\_

# RCA

would be a 1-2-4-8 type of deal, so we might rearrange the flip-flops in a 1-2-2'-4 circuit like Fig. 7. Right now, this circuit can count only to 8 and the 2 and 2' flip-flops are apparently doing the exact same thing.

Now comes the black magic. By lifting some of the grounds on the inputs of the 2 and 2' flip-flops and by replacing these grounds with signals that change from count to count, we can *inhibit* the operation of these two flip-flops. Look at the timing diagram. We want to inhibit the 2' flip-flop only when the 2 flip-flop is up, so we add a wire jumper as shown in Fig. 8. That's half the problem. Next, we want to inhibit the 2' counter *except* for count 0.

We note that *both* the 2' and 4 flip-flops are up simultaneously on counts 8 and 9 and thus will still be up while awaiting the next count 0. We can add an AND gate to allow this signal to inhibit the 2 counter for every count except count 0, just as shown in Fig. 9. Now, we simply combine both circuits, and out comes our complete 1-2-2'-4 counter in Fig. 10.

You'll find the complete schematic in Fig. 11. IC1 and IC2 are the counter. As these IC's also have a preset

Fig. 11—Complete schematic of the counter module. IC1 and IC2 are the two dual JK flip-flops and IC3 is the AND gate. Collector resistors on Q1-Q4 determine weighted current to the meter. Count pulses must have falltime less than 100 nsec.

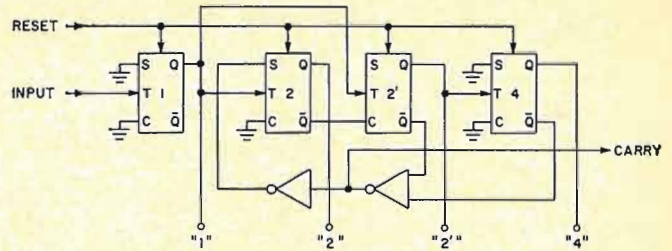
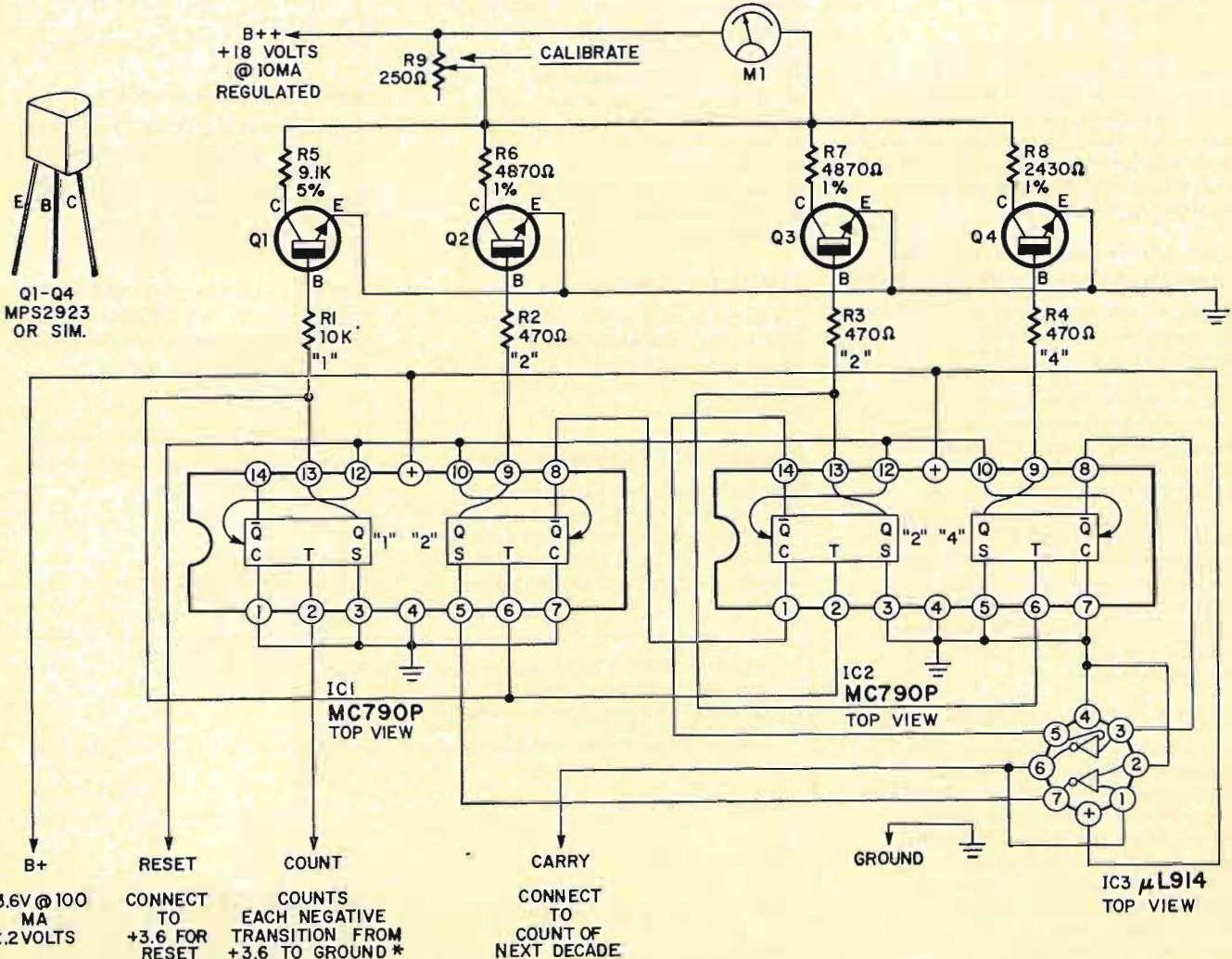

Fig. 10—AND gate and flip flops form complete counter.

#### PARTS LIST

IC1, IC2—MC790P dual JK flip-flop (Motorola)  
 IC3— $\mu$ L914 dual two-input gate (Fairchild)  
 Q1, Q2, Q3, Q4—MPS2923 or similar npn silicon transistor (Motorola)  
 Note: Data sheets and distributor lists are available from the following respective sources:  
 Motorola Semiconductor  
 Box 955  
 Phoenix, Ariz. 85001  
 Fairchild Semiconductor  
 313 Fairchild Drive  
 Mountain View, Calif. 94041  
 R1—10,000-ohm, 1/4-watt carbon resistor  
 R2, R3, R4—470-ohm, 1/4-watt carbon resistor  
 R5—9,100-ohm, 5%, 1/4-watt carbon resistor

R6, R7—4870-ohm, 1/4-watt, 1% resistor  
 R8—2430-ohm, 1/4-watt, 1% resistor  
 R9—potentiometer, 250 ohms, CTS No. U201-251 or similar  
 M1—0-10 dc vertical milliammeter  
 Circuit board—1.15/16" x 1.15/16" x 1/16" single-sided PC board  
 MISC: PC terminals (6); wire jumpers (3); No. 6 spade bolts and No. 6 nuts (2); solder.  
 Note: The following are available from Southwest Technical Products Inc., 217 West Rhapsody, San Antonio, Tex. 78216. Etched and drilled PC-1 \$1.00; meter M1 with special scale \$2.25; complete kit of all parts \$10.00; postpaid in US.



\*COUNT NEGATIVE TRANSITION MUST FALL FASTER THAN 100  $\mu$ SEC.

# ALLIED New 1969 CATALOG & BUYING GUIDE FREE

536  
PAGES

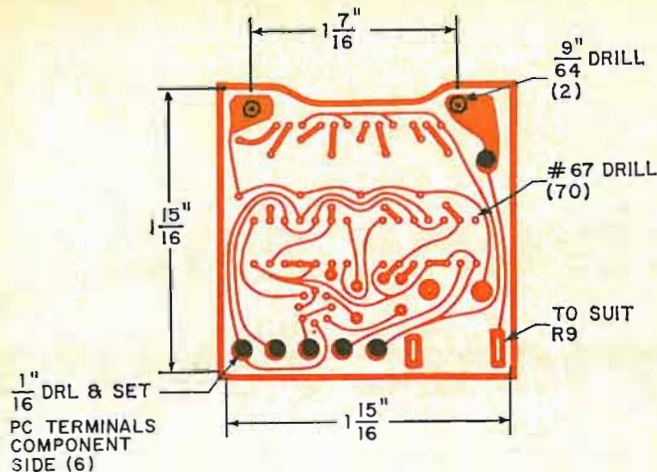

Fig. 12—This 1 15/16"-square PC board will mount on meter.

input, we bring out a common lead that gives you the RESET terminal that automatically resets the counter to 0. IC3 is the AND gate. Transistors Q1 through Q4 drive the meter through weighted precision resistors R5 through R8. R1 had to be a bit bigger than the other base-driving resistors to eliminate a loading problem on IC1.

Two power supplies are required, a regulated 18 volts at 10 mA and a ripple-free +3.6 volts at 100 mA for the IC's. Your COUNT signal should normally be positive, say from +1.5 to +4 volts, and abruptly drop to zero whenever a count is desired. This signal MUST come down only once per count and MUST come down faster than 100-nsec fall time. If you want to count anything but good square waves, you'll have to "process" your input signals in some simple circuitry we'll talk about later. You'll also find that pushbuttons and mechanical contacts will have to be made bounceless. Once again, this is easily accomplished in a simple circuit.

The CARRY output of any decimal counting module will directly drive the COUNT input of the next module down the line, and you simply cascade as many counting units together as you wish. Four is typical, and allows measurement from 0.1% to 0.01% accuracy.

The RESET input is normally left grounded. To reset the counter, simply apply +1.5 to +4 volts of dc to this input.

The integrated circuits used are guaranteed to operate at an 8-MHz rate, but all the modules we have tested go well beyond 10 MHz. You'll find the meter movement's inertia automatically blanks any high-speed counting, eliminating the need for the strobe or storage circuitry often used in fancier industrial designs.

### Construction

Your decimal counting module can be built onto a 1 15/16" square printed-circuit board that mounts directly on the meter terminals. You can buy this circuit board ready to go, but if you prefer, you can lay out, drill and etch your own circuit card, simply by following the layout guide in Fig. 12. Three wire jumpers are needed as shown. The

(continued on page 94)

### COMING

Next month, we'll talk about power supplies, input conditioning, time bases and other things that will show you how to build many practical digital readout instruments at a very low cost using these decimal readouts.

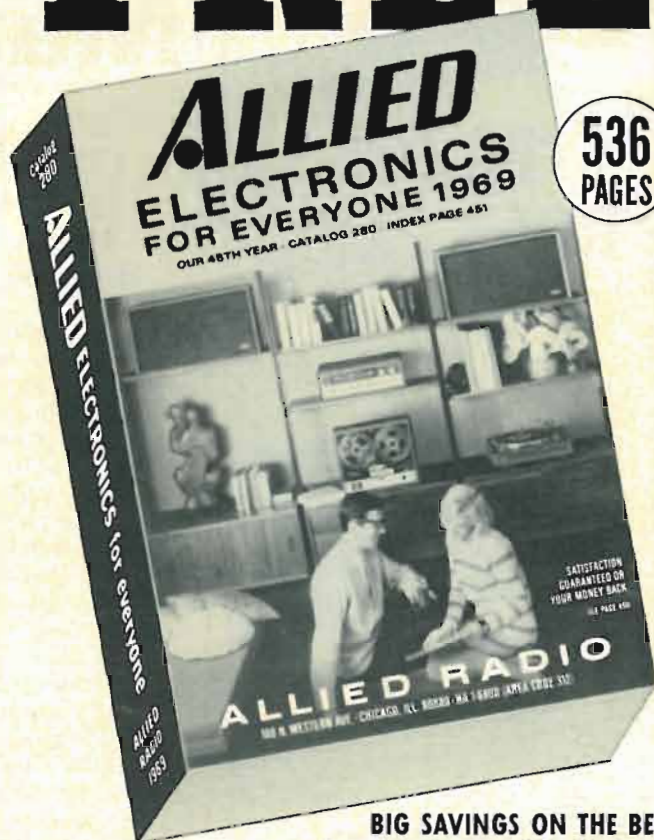

### BIG SAVINGS ON THE BEST IN ELECTRONICS FOR EVERYONE

Here it is! The world's most famous catalog of electronic equipment featuring hundreds of new and exclusive items and special Allied values.

536 pages—including a complete Electronic and Hobby Kits Catalog—picturing, describing, and pricing thousands of items. The most complete inventory ever assembled of Hi-Fi, Radios, Tape Recorders, CB, Electronic Equipment, Parts and Tools . . . all at money-saving low prices.

**NO MONEY DOWN • UP TO 2 YEARS TO PAY!**

- Stereo Hi-Fi
- Electronic & Hobby Kits
- Tape Recorders & Tape
- CB 2-Way Radios
- Walkie-Talkies
- FM-AM & AM Radios
- Shortwave Receivers
- Portable TV
- Phonographs
- Amateur Equipment
- Intercoms & PA
- Automotive Electronics
- Test Instruments
- TV Antennas & Tubes
- Power Tools, Hardware
- Tubes, Transistors
- Parts, Batteries, Books



**WRITE  
FOR YOUR  
COPY TODAY!**

ALLIED RADIO, Dept. 046  
P.O. Box 4398, Chicago, Illinois 60680  
PLEASE PRINT

NAME \_\_\_\_\_  
First Middle Last

ADDRESS \_\_\_\_\_

CITY \_\_\_\_\_

STATE \_\_\_\_\_ ZIP \_\_\_\_\_

Circle 27 on reader's service card



**THEIR  
BULK PACK.**



**OURS!**

**(E.V.)** Pick up this handful of best-selling needles from your Electro-Voice distributor, and you get a handsome display carton free.

And if you want more, ask about our permanent phono needle/cartridge merchandiser, wall banners, literature, and the best cross-reference catalog in the industry.

We don't just make the most complete line of needles and cartridges, we also help you sell... help you profit. Insist on Electro-Voice. From the parts distributor with more than parts to offer!

**ELECTRO-VOICE, INC.**, Dept. 1187E  
613 Cecil Street, Buchanan, Michigan 49107



# Electrons and Magnetic Fields

*An expert describes an easy-to-follow substitute for the left- and right-hand rules*

By James G. Holbrook\*

BASIC ELECTRICITY AND MAGNETISM theory often seems dull and dry. We're impatient to hurry on to things more practical and interesting, and consequently we often continue to learn electronics while still uncertain about elementary principles.

I've selected a few short problems which are useful to detect any uncertainty you may have about electronic motions in magnetic fields. Several of these questions have made research engineers and physicists reconsider basic theory.

Fig. 1-a shows the arbitrary but standard definition of the direction of magnetic flux lines as being from the North to the South pole of a magnet. Fig. 1-b thus implies there is a North pole somewhere above the page, with the crosses indicating flux directed into the page.

Stop! Before reading further, examine the two problems in Fig. 2. Part

\*Research Fellow,  
University of Southampton, England

DEFINITION OF FLUX LINE  
IS DEFINED TO BE FROM NORTH TO SOUTH POLE

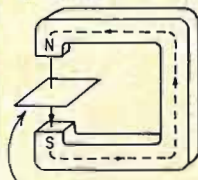

SHEET OF PAPER  
NORMAL TO FLUX LINE



TOP VIEW OF SHEET,  
CROSSES INDICATE  
FLUX LINES  
DOWNWARD

**a** **b**  
Fig. 1-a—Magnetic flux lines are arbitrarily defined as being from North to South poles of a magnet; (b) crosses represent field directed from above into page.

(a) is a Faraday disk generator, showing a conducting disk rotating clockwise on its axis, and with a uniform magnetic field into the page. The disk is of nonmagnetic material, and thus the field is uniform through, as well as around, the disk edges. Brushes touch the center and outer rim of the disk, and motion of the conducting disk in the field causes a voltage to appear at the terminals.

The problem is which terminal is positive and which is negative. Make a definite choice and don't change; there are of course only two possibilities. Use any method.

Next, look at part (b) which shows the face of a cathode-ray tube with the beam normally striking the exact center of the screen. However, with two magnets around the neck will the beam be deflected to position a, b, c or d? Again make a definite choice.

If you were uncertain about your answers, you will probably find the following new concepts interesting.

First, make a clean break with the traditional left- or right-hand rules, just as many have done with the idea of an external current from positive to negative. Second, consider a new Electron Orbit Rule:

*When an unrestrained electron moves in a plane normal to a magnetic field, it will circle clockwise when the field is directed away from the observer.*

This new rule is illustrated in Fig. 3. Part (a) shows the field directed away from the observer, and the electron, upon entering normal to the field, begins to circle clockwise. Part (b) shows a symbol which may be used to remember the rule: One flux line into the page, and the orbit or path of one electron. The following applications show how this concept is applied. This

Solder pre-coated rivets.  
Desolder. Soften, mold, weld,  
form plastics. Dry paint finishes.  
Speed plastic and epoxy curing.  
Shrink tubing.



**OUR FLAMELESS  
HEAT GUN DOES  
IT ALL WITH  
FAST, SAFE,  
CONTROLLED HEAT  
UP TO 1000° F.**

See your Electronic Parts  
Distributor or write for  
Free Catalog Dept. 75

## MASTER APPLIANCE CORPORATION

RACINE, WISCONSIN 53403

Circle 29 on reader's service card

**MORE POWER!  
MORE GAS MILEAGE!  
INSTANT START!**

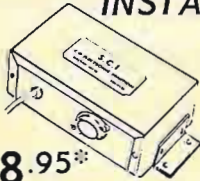

—all through  
SCI electronic  
ignition

**\$28.95\***

SCI MODEL CD-101 provides 32,000 volts evenly from ignition turn-on to full power. Gas combustion is at peak efficiency always due to uniformity of spark. Voltage is constant no matter how cold your battery. Plugs and points usually last 3 times longer. You'll feel the difference both in the performance of your car and the savings in your pocket. The SCI electronic ignition is complete, contains eight high reliability semi-conductors and is hand-wired on a rugged fibreglass circuit board. Simple installation. Guaranteed for ninety days.  
(For negative ground vehicles only.)

**SCI** P.O. BOX 27  
BOSTON, MASS. 02131

Enclosed is \$28.95\* (plus 75¢ shipping and mailing cost) for one SCI MODEL CD-101 electronic ignition.

NAME .....  
ADDRESS .....  
CITY ..... STATE ..... ZIP .....

Circle 30 on reader's service card

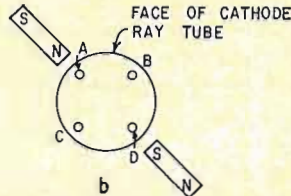
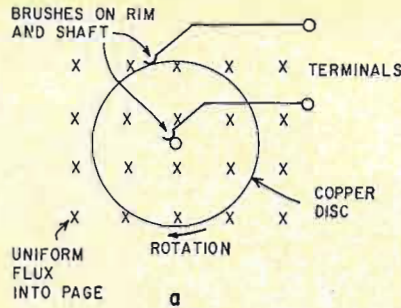

Fig. 2-a—What is polarity of terminals touching rim and shaft of Faraday disk generator rotating in uniform magnetic field? b—With magnets fixed as shown, will light spot deflect to a, b, c or d?

is called the "Electron Orbit Method."

In Fig. 4 an enlarged view of a conductor is shown at rest in a magnetic field. Connecting wires to an external battery will cause a current of electrons to move from the negative terminal into the region of the field. But the Electron Orbit Rule says the electron must circle clockwise, thus it strikes the inside of the wire-to-air boundary (shown by the dotted line), and exerts a force to the right of the wire.

This particular electron is now at rest. It immediately begins to move again, however, because of the attraction from the positive end of the battery. As soon as it gets up speed, it

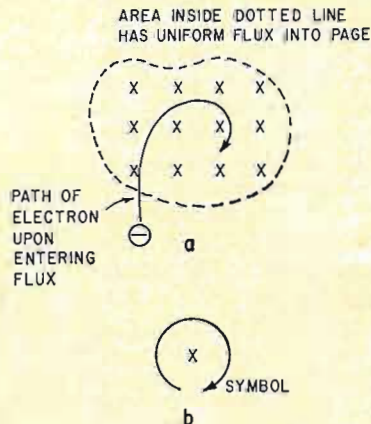

Fig. 3-a—Electron circles clockwise when entering field directed away from observer. b—Electron Orbit Rule symbol.

# Hickok



**123R GARDMATIC TUBE TESTER**—Automatic tube testing using card-programmed switch, eliminates errors. A fast, automatic tube tester which includes tests for saturation and cut-off in addition to mutual conductance.  
**\$655.00**



**580A TUBE TESTER**—Entirely new. Can be set up to any test condition, including handbook parameters. Also includes built-in roll chart. Features ultra-sensitive grid condition test with sensitivity to 0.05µa.  
**\$585.00**



**539C TUBE TESTER**—Laboratory and industrial instrument. Provides both handbook condition tests and tests "tailored" to specific individual conditions. Roll chart data.  
**\$545.00**



**752A TUBE TESTER**—Communications and industrial maintenance instrument. Includes tests for 4-digit industrial tube types, VR tubes, and low power thyatrons. Best buy for general purpose industrial maintenance. Roll chart data.  
**\$385.00**



**6000A TUBE TESTER**—Service technician's high-speed, portable tester. Tests all popular entertainment types, also transistors and diodes. Time-saving leakage and short indicators. Replaceable socket plate for obsolescence protection. Roll chart data.  
**\$259.50**

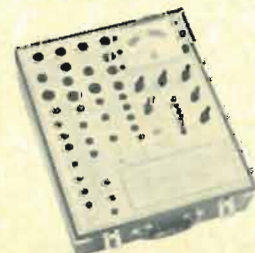

**799 MULTI-SOCKET TUBE TESTER**—Ideal for television service and repair. Provides true mutual conductance tests with no paralleled elements. Solid state sensing circuit provides 50 megohm leakage tests, 0.1µa gas and grid emission tests. Replaceable panel plate for future tube additions.  
**\$199.95**

## IMPROVED PERFORMANCE!

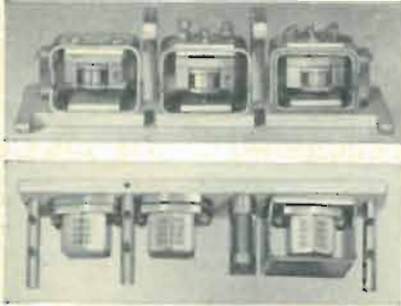

# NORTRONICS ANNOUNCES THE 9000 SERIES TAPE HEADS FOR PROFESSIONAL and STUDIO EQUIPMENT

### UNEXCELLED PERFORMANCE IN AMPEX, SCULLY AND OTHER PROFESSIONAL RECORDERS

- Extremely smooth response from 20 Hz to 20 KHz.
- Extra wide pole faces for minimum low frequency contour effects.
- Hi-Q, low loss core structures.
- Extra deep deposited quartz gaps for sharp, clean edge definition.
- Full gap depth for maximum wear life.
- All metal hyperbolic face for reduced oxide loading and intimate tape contact.
- Gap Colinearity—Precise Gap Alignment For Both Azimuth and Phase on Multi-Track Heads, either 4-Channel or 8-Channel.

### MORE CONVENIENT THAN FACTORY REPLACEMENT

- Available locally, from your distributor.
- Replace heads in the field, minimum down time. Plug-in simplicity. No need for a spare nest.
- Wide choice of Record, Play, and Erase Heads, for 1/4 inch, 1/2 inch, and 1 inch tape, in a variety of track styles.
- Full details in Nortronics Bulletin 7295A, available free on request.

**Nortronics**  
COMPANY, INC.

8101 Tenth Avenue North  
Minneapolis, Minnesota 55427  
Phone: (612) 545-0401

Circle 32 on reader's service card

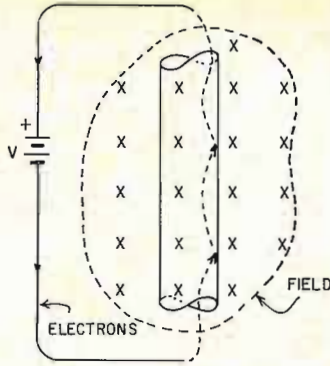

Fig. 4—Motor action is illustrated by electrons striking right hand boundary of conductor, forcing wire toward the right.

again circles clockwise in accordance with the rule, striking the wall. This boundary is very real, as the electron is free to move inside the wire, but strikes a solid wall at the boundary and cannot get through unless the wire is heated to emission temperature, as in a cathode.

You might wonder how a small electron could exert much force upon striking the inside boundary. But remember there are  $6.28 \times 10^{18}$  electrons passing a given point on the wall each second for each ampere of current, and the combined effect is to move the wire.

A wire is shown at rest in Fig. 5-a. No connections are made to the ends. This wire is uncharged, and therefore its free electrons are uniformly distributed up and down the wire. One free electron is shown at the center. We again have a field into the page.

If this wire is physically pulled to the right (not rotated), the electron, being inside the wire, is pulled along with it to the right. But the Electron Orbit Rule says the electron moves clockwise. Hence the electron in the wire follows the clockwise dotted line as the wire moves to position (b). Of course all the free electrons behave in the same way, and the bottom of the wire becomes highly negative. The wire must be kept in motion, or the electrons will merely uniformly redistribute themselves.

The problem in Fig. 2 should now be simple. In part (a) choose any electron at rest in the disk, then start rotating the disk. This first starts the electron in a line normal to the radius. But once moving, it must, by our rule, circle clockwise (toward the axis) and thus the center of the disk, or the lower terminal, is negative.

In part (b), the field is directed downward to the right, and when viewed from alongside the South pole

ENJOY THE "MUSIC ONLY" FM PROGRAMS

# M. A. D.

MUSIC ASSOCIATED'S DETECTOR  
NO COMMERCIALS—NO INTERRUPTIONS

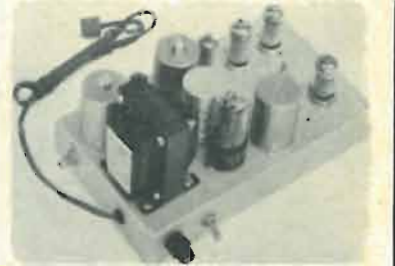

It's easy! Just plug Music Associated's Sub Carrier Detector into multiplex jack of your FM tuner or easily wire into discriminator. Tune through your FM dial and hear programs of continuous commercial-free music you are now missing. The Detector, self-powered and with electronic mute for quieting between selections permits reception of popular background music programs no longer sent by wire but transmitted as hidden programs on the FM broadcast band from coast to coast. Use with any FM tuner. Size: 5 1/2" x 9". Shipping weight approx. 7 lbs.

KIT **\$49.50**

(with pre-tuned coils, no alignment necessary)

WIRED **\$75.00** (Covers extra \$4.95 ea.)

Current list of FM Broadcast stations with SCA authorization \$1.00

**MUSIC ASSOCIATED**

65 Glenwood Road, Upper Montclair, N. J.  
Phone: (201)-744-3387 07043

Circle 33 on reader's service card

Because you've got to SEE it to BELIEVE it  
..... we will send you a FREE sample!

*instant lettering*®



**DATAMARK**

— the easy new way to label your projects!

Just rub over the pre-printed words or symbols with a ballpoint pen and they transfer to any surface—looks like finest printing! Label control panels, meter dials, letter on anything!

LOOK FOR *instant lettering*®

**DATAMARK** SETS only \$1.25 each  
— at leading electronic distributors

DATAMARK SETS AVAILABLE FOR:

- Amateur Radio, CB
- Audio, Hi-Fi, TV
- Experimenter Home Intercom
- Industrial Test Equipment
- Switch & Dial Markings
- Alphabets & Numerals in 1/8", 1/4" and 1/2"

— each set has black, white, and gold

SEND FOR FREE SAMPLE RE-118

**THE DATA CORPORATION**

35 HIGHLAND AVENUE • PASSAIC, N. J. 07055

Circle 34 on reader's service card



# Important E & E Books

## The VHF Amateur



by Robert M. Brown, K2ZSQ/W9HBF. A completely updated handbook packed with data on vital vhf subjects not available elsewhere. The author formerly published the famous VHF Magazine whose back issues are much in demand.

This new handbook incorporates the finest vhf material from the former publication, plus new data of great interest to both old and new vhf men. 160 pages.

Order EE-65060, only \$4.50

## Amateur Radio Incentive Licensing Study Guide



by Robert M. Brown, K2ZSQ/W9HBF, and Tom Kneitel, K2AES. Fully explains the new incentive licensing which affects both newcomers and old-timers. Covers all the new FCC

Regulations and band allocations. Includes multiple-choice questions and answers (as close to actual FCC exams as possible) covering the new Advanced-Class, and the modified requirements for the Extra-Class exams. Also includes sample exams for Novice, Technician, Conditional, and General-Class licensing. 160 pages. Order EE-050, only \$2.75

## Commercial Radiotelephone License Q&A Study Guide

by Woodrow Smith and Robert Welborn. An invaluable aid in preparing for the exams for the various grades of radiotelephone license or permit. Questions cover the first four elements of the radiotelephone license exam. Answers are comprehensive and detailed and relevant to the pertinent subjects of the exam. 272 pages. Order EE-031, only \$6.95

## Single Sideband: Theory & Practice

by Harry D. Hooton, W6TYH. The one-source reference guide to ssb. Covers the origin and principles of ssb, derivation of ssb signals, carrier suppression techniques, sideband selection, ssb equipment, tests and measurements. Order EE-350, only \$6.95

17TH EDITION OF THE FAMOUS

## Radio Handbook

Tells how to design, build, and operate the latest types of amateur transmitters, receivers, transceivers, and amplifiers. Provides extensive, simplified theory on practically every phase of radio. Broadest coverage; all original data, up-to-date, complete. 848 pages. Order EE-167, only \$12.95



Order from your electronic parts distributor or send coupon below.

### EDITORS and ENGINEERS

P.O. Box 68003, New Augusta, Ind. 46268, Dept. REE-118

Send me the following books:

- EE-65060     EE-031     EE-350  
 EE-050     EE-167

Name \_\_\_\_\_

Address \_\_\_\_\_

City \_\_\_\_\_ State \_\_\_\_\_ Zip \_\_\_\_\_

Circle 35 on reader's service card

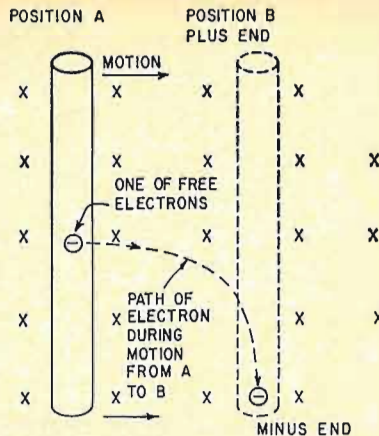

Fig. 5—Generator action is shown as wire is pulled from position (a) to position (b) and electrons move to lower end of wire.

of the upper magnet goes through the glass away from us. The electrons are then rushing into the field from our left and circle clockwise, striking the screen at "c."

With a little practice you can easily re-orient fields and electron orbits to any position. Try applying the new rule to a one-turn loop passing through a field. Remember, it really makes no difference whether the field moves toward the electron or the electron moves toward the field.

The technique will show what sort of potential difference appears on opposite sides of a wire in a field as current passes (the Hall effect in physics), and polarities of voltage induced in transformer secondaries, etc. New applications and even new ideas in electronics will occur as you become familiar with the interaction of electrons and magnetic fields. R-E



"After you two have your fun would you do something about this filling that receives radio broadcasts?"

NOVEMBER 1968

73

## There's no substitute for SUCCESS...



JAMES WONG—Research Engineer  
Heald Engineering College Graduate

## or IN-CLASS INSTRUCTION!

In electronics, it's the training that makes the difference. Employers require well-trained men and the first thing checked is where you gained your knowledge.

HEALD GRADUATES have many job offers with starting salaries often in excess of \$10,000 per year. AND advancement is rapid.

GET STARTED NOW. Be a  
 DRAFTSMAN—12 months  
 TECHNICIAN—15 months  
 ENGINEER (B.S. Deg.)—30 months  
 ARCHITECT (B.S. Deg.)—36 months

YOU are eligible for HEALD ENGINEERING COLLEGE if you have a high school education or the equivalent.

Increased income starts with success—success starts with your move to Heald. Send now for FREE brochures with more information on Heald in San Francisco and your future in Engineering.

FREE LIFETIME PLACEMENT SERVICE  
 VETERAN APPROVED



WRITE TODAY FOR DETAILS

## HEALD Engineering College

1215 Van Ness Ave., San Francisco, California 94109

Please send me information about:

- ARCHITECTURE   
 ENGINEERING: Civil  Electrical   
                   Electronic  Mechanical   
 TECHNOLOGY: Electronic Engineering  
                   Technician (FCC)   
                   Radio-Television Technician (FCC)   
 DRAFTING: Mechanical  Electrical   
                   Structural

I am interested in Day  Evening  courses  
 Also send an application.

NAME \_\_\_\_\_ AGE \_\_\_\_\_

ADDRESS \_\_\_\_\_

CITY \_\_\_\_\_

STATE \_\_\_\_\_

ZIP \_\_\_\_\_ PHONE \_\_\_\_\_

Circle 36 on reader's service card

## RADIO-ELECTRONICS READERS SERVICE

Here's how you can get manufacturers' literature fast:

1. Tear out the post card on the facing page. Clearly print or type your name and address. **Include zip code!**
2. Circle the number on the card that corresponds to the number appearing at the bottom of the **New Products, New Literature** or **Equipment Report** in which you are interested.  
For literature on products **advertised** in this issue, circle the number on the card that corresponds to the number appearing at the bottom of the advertisement in which you are interested. Use the convenient index below to locate quickly a particular advertisement.
3. Mail the card to us (no postage required in U.S.A.)

ALLIED RADIO CORPORATION (Pg. 69) Circle 27  
 ARCTURUS ELECTRONICS CORPORATION (Pg. 100) Circle 133  
 ARROW FASTENER COMPANY, INC. (Pg. 59) Circle 22

B & K (Division of Dynascan Corporation) (Pg. 7) Circle 11  
 BROOKS RADIO & TV CORPORATION (Pgs. 92-93) Circle 126  
 BSR (USA) LIMITED (Pg. 81) Circle 112  
 BURSTEIN-APPLEBEE COMPANY (Pg. 62) Circle 24

CARRINGELLA ELECTRONICS, INC. (Pg. 90) Circle 119  
 CASTLE TV TUNER SERVICE, INC. (Cover III) Circle 142  
 CLEVELAND INSTITUTE OF ELECTRONICS (Pgs. 54-57) Circle 21  
 CLEVELAND INSTITUTE OF ELECTRONICS (Slide Rule) (Pg. 88) Circle 114  
 COLETRONICS (Pg. 92) Circle 123  
 CORNELL ELECTRONICS COMPANY (Pg. 102) Circle 138

DATAK CORPORATION, THE (Pg. 72) Circle 34  
 DELTA PRODUCTS INC. (Pg. 78) Circle 107  
 DELTA PRODUCTS INC. (Pg. 90) Circle 118

EDITORS AND ENGINEERS, LTD. (Division of Howard W. Sams & Company, Inc.) (Pg. 73) Circle 35  
 EDLIE ELECTRONICS, INC. (Pg. 92) Circle 124  
 EDMUND SCIENTIFIC COMPANY (Pg. 101) Circle 135  
 EICO ELECTRONIC INSTRUMENT COMPANY, INC. (Cover II) Circle 7  
 ELECTRONIC CHEMICAL CORPORATION (Pg. 99) Circle 132

FAIR RADIO SALES (Pg. 103) Circle 139

GAVIN INSTRUMENTS, INC. (Subsidiary of Advance Ross Corporation) (Pg. 98) Circle 130  
 GC ELECTRONICS COMPANY (Pg. 16) Circle 14

HEALD ENGINEERING COLLEGE (Pg. 73) Circle 36

HEATH COMPANY (Pgs. 82-87) Circle 113  
 HICKOK ELECTRICAL INSTRUMENT COMPANY (Pg. 71) Circle 31

INTERNATIONAL CRYSTAL MANUFACTURING COMPANY (Pg. 104) Circle 141  
 INTERNATIONAL RESISTANCE CORPORATION (Pg. 24) Circle 17

KENZAC COMPANY (Pg. 100) Circle 134

LECTROTECH, INC. (Pg. 94) Circle 127  
 LORAL DISTRIBUTOR PRODUCTS (Division of Loral Corporation) (Pg. 5) Circle 9

MASTER APPLIANCE CORPORATION (Pg. 71) Circle 29  
 MOSLEY ELECTRONICS, INC. (Pg. 97) Circle 128  
 MUSIC ASSOCIATED, INC. (Pg. 72) Circle 33

NORTRONICS COMPANY, INC. (Pg. 72) Circle 32

OAKTRON (Pg. 88) Circle 115  
 OLSON ELECTRONICS, INC. (Pg. 93) Circle 125

PACE COMMUNICATIONS (Pg. 17) Circle 15  
 PERMA-POWER COMPANY (Pg. 77) Circle 106  
 POLY PAKS (Pg. 103) Circle 140

QUAM-NICHOLS COMPANY (Pg. 6) Circle 10  
 QUIETROLE COMPANY (Pg. 90) Circle 120

RAYTHEON (Pg. 63) Circle 26  
 RCA ELECTRONIC COMPONENTS (Test Equipment) (Pgs. 14-15) Circle 8  
 RYE INDUSTRIES, INC. (Pg. 62) Circle 23

SAMS & COMPANY, INC. HOWARD W. (Pg. 26) Circle 19

SCHOBER ORGAN CORPORATION, INC. (Pg. 80) Circle 111

SCI ELECTRONIC IGNITION (Pg. 71) Circle 30  
 SCOTT, INC., H. H. (Pg. 91) Circle 100

SENCORE (Pg. 27) Circle 20  
 SOLID STATE SALES (Pg. 101) Circle 136

SONY CORPORATION OF AMERICA (Pg. 89) Circle 117  
 SUPEREX ELECTRONICS (Pg. 91) Circle 122

SYLVANIA ANTENNAS (Subsidiary of General Telephone & Electronics) (Pgs. 22-23) Circle 16

VACO PRODUCTS COMPANY (Pg. 79) Circle 110

WARREN ELECTRONIC COMPONENTS (Pg. 102) Circle 137  
 WELLER ELECTRIC COMPANY (Pg. 61) Circle 25

ZENITH (Pg. 12) Circle 12

# NEW PRODUCTS

More information on new products is available free from the manufacturers of items identified by a Reader's Service number. Turn to the Reader's Service Card facing page 74 and circle the numbers of the new products on which you would like further information. Detach and mail the postage-paid card.

**RHYTHM INSTRUMENT, Model X-81**, delivers 9 rhythm patterns of 7 rhythm instruments. Plays through guitar, hi-fi, amplifier and speaker. Automatically selects instruments to match



rhythm. Two patterns can be mixed to create a new one. Has foot switch, push-button rhythm selector, tempo and volume controls. \$199.99.—Olson Electronics Inc.

Circle 46 on reader's service card

**AUDIO LEVEL CONTROLLER, Model M62**, is a transistorized variable-input-level controlling device especially designed to keep its electrical output constant. Power supplied by a self-contained 9V battery or by an auxiliary dc power



supply. Input impedance: from 100,000 to 500 ohms; output impedance: 500 to 10 ohms. Frequency response: flat 20 to 20 kHz  $\pm 2$  db; signal-to-noise ratio: with respect to 10-microbar input, 60 db; distortion: any input and distance selector position: 3% maximum. \$90 with 1-year guarantee.—Shure Brothers Inc.

Circle 47 on reader's service card

**TRANSISTOR ANALYZER, Model 3490-A, Type 2**, portable, solid-state. Continuous instrument monitoring, overload interlocked switching circuits and



test collector current ranges from 100  $\mu$ A to 30 A. Three independent power supplies and 4½-in. meters. Two test

sockets at panel top for in-line type and types where leads are grouped in a circle or square on the bottom. \$441.—The Triplett Electrical Instrument Co.

Circle 48 on reader's service card

**MULTIBAND RECEIVER, Model A-2515**, solid-state, tunes amateur bands from 80 to 100 meters; aircraft, marine

and other short wave broadcasts and the standard AM broadcast band. Bands covered: 150-400 kHz, 550-1600 kHz, 1.6-4.8 MHz, 4.8-14.5 MHz and 10.5-30



## two new deals from Perma-Power

CHOOSE EITHER—OR BOTH—AND SAVE!



### FREE WINDPROOF CIGARETTE LIGHTER

When you buy 12 VU-BRITES  
Model C-401 only  
Standard Base, Parallel Wiring  
at the special price of

**\$9<sup>95</sup>**

World's Leading Single-Purpose Britener



### FREE SET OF FOUR DRINK 'N SNACK TRAYS

When you buy 5 TU-BRITES  
Model C-212 only  
110° Button Base, Series or Parallel  
at the special price of

**\$10<sup>95</sup>**

If the base is right, the boost is right!

Our two biggest sellers—the Briteners you need most often—are now at your distributors in these special bargain packages with free gift inside.

Perma-Power Briteners brighten up your customer relations as they brighten up those faded CRT's.

Limited time offer.  
Stock up now on  
both Britener types  
while supplies last.

**Perma-Power** COMPANY

Division of Chamberlain Manufacturing Corporation  
5740 North Tripp Avenue • Chicago, Illinois 60646  
Phone: (312) 539-7171

# Delta Launches the COMPUTACH®\*



The  
Great  
One!

\*An exclusive computer-tachometer for precise RPM measurement in easy-to-build Kit form!



ONLY  
**\$29.95**  
ppd.

Delta, pioneers in CD ignition who produced the fabulous MARK TEN®, now offer a precise computer-tachometer which obsolesces any type tachometer on the market today! You achieve unbelievable accuracy in RPM readings due to the advanced, solid-state electronic matched components used in the computer, coupled with the finest precision meter in the world. Works on all 2, 3, 4, and 6 cylinder 2 cycle and with 4-6-8 cylinder—4 cycle 12 volt engines.

- ▲ 0-8000 RPM range
- ▲ Perfect linearity — zero parallax
- ▲ Adjustable set pointer
- ▲ Wide angle needle sweep
- ▲ Translucent illuminated dial
- ▲ Chrome plated die-cast housing
- ▲ All-angle ball & socket mounting
- ▲ Use it with ANY ignition system
- ▲ Meter: 3 1/8" dia. X 3 3/8" deep
- ▲ Calibration kit included, no test eqpt. needed.

Orders shipped promptly.  
Satisfaction guaranteed.



**DELTA PRODUCTS, INC.** DP 0-2

Send check today!

P.O. Box 1147 RE / Grand Junction, Colo. 81501

Enclosed is \$ \_\_\_\_\_  Ship ppd.  Ship C.O.D.

Please send:

**COMPUTACH® Kits @ \$29.95 ppd**

**Sold in Kit Form ONLY!**

Name \_\_\_\_\_

Address \_\_\_\_\_

City/State \_\_\_\_\_ Zip \_\_\_\_\_

Circle 107 on reader's service card

MHz. Push-pull audio stage with thermistor for low distortion and a headphone jack for private listening. Powered by 117 Vac or 12 Vdc. \$99.95.—Allied Radio Corp.

Circle 49 on reader's service card

"BALL" MICROPHONE. Three models, all with switches, weigh 3 3/8 oz and measure 6" high and 1 13/16" in diameter (at top of microphone). DM70-150-B—impedance: 50K; sensitivity: -58 dB re 1 volt per dyne/cm<sup>2</sup> at 1 kHz; response:



50 to 15,000 Hz. DM70-250-B—impedance: 10K; sensitivity: -66 dB re 1 volt per dyne/cm<sup>2</sup> at 1 Hz; response: 50 to 16,000 Hz. DM70-550-B—impedance: 200 ohms; sensitivity: -59 dB re 1 μW per 10 dynes/cm<sup>2</sup>; response: 40 to 18,000 Hz. All made of lightweight, easy-to-handle die-cast metal and finished in nonreflecting brushed chrome. Ball of the mike is designed to control voice popping and wind noise.—Sonotone Corp.

Circle 50 on reader's service card

FIELD-EFFECT TVM, FE149, provides 8 dc voltage ranges to 1500V. A 0.5V low scale with 0.25V either side assures measurements to less than 0.1V for transistor bias measurements. Eight ac ranges are provided to 1500V rms and 4500V peak to peak. Operates on ac power, on



its self-contained rechargeable batteries or on ac with the batteries plugged in. Pushing one button in the top row to select function and one button in the bottom row for range to make any circuit test. Nonbreakable, scuff-resistant vinyl-clad steel case. \$149.00.—Sencore Inc.

Circle 51 on reader's service card

DRIVE SOCKET SET, No. 30317. A 17-piece set of 1/2" drive sockets, handles and accessories plastic-sealed in a 17" long steel case. Also included are 13 thin-wall sockets, 7/16" through 1 1/4", a 5" extension and a 17" flex handle. All com-

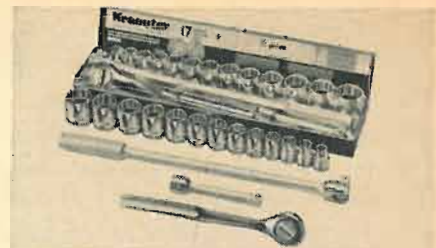

ponents are double-nickel chrome-plated against corrosion, and fully guaranteed. \$39.98.—Krauter Tools, Subsidiary of Dresser Industries, Inc.

Circle 52 on reader's service card

SCREWDRIVER, Model 1253-B, made with 3" spring-steel blades hollow ground to 0.012" thickness and a shockproof, unbreakable Tenite II handle. Will hold, start and drive screws as tiny as No. 0-80 and similar sizes. Useful to craftsmen

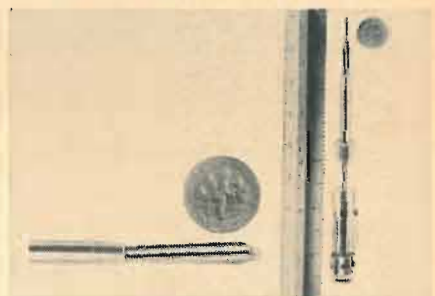

involved in repair or manufacture of sensitive timekeeping or miniaturized precision electronic equipments and instruments. \$1.50. Fourteen other sizes are available, ranging from midget to small, medium and heavy-duty, with blade lengths from 2" to 14".—Kedman Co.

Circle 53 on reader's service card

ISOLATION TRANSFORMER, P-6411. Reduces shock hazard by isolating equipment from the power line, is rated 117V to 117V at 15VA. Measuring 2" x 3 1/4" x



1 1/2", it is particular useful to equipment manufacturers, experimenters and hobbyists. Less than \$6.—Controls Div. of Essex Wire Corp.

Circle 54 on reader's service card

CB TRANSCEIVER, Cobra 98, has built-in SWR bridge and 3-scale meter. Includes dual transistor power supply for 117 Vac and 12 Vdc. Double-conversion reception and 23 channel 100% modulated transmission. Comes



with a coil-cord ceramic mike. Measures 5½" x 13¼" x 8½" and weighs 16 lbs. \$239.95.—**B&K Communications Div.**

Circle 55 on reader's service card

**AUTOMATIC TURNTABLE, SL95.** Two motors. Induction section imparts instant start and driving torque. Synchronous section is governed by 60-cycle electric current. Light-weight, balanced tone arm eliminates vibration. Record platform rises at the push of a



button for auto play and lowers for manual play. Built-in calibrated stylus pressure gauge, adjustable sliding counterweight isolated in rubber, anti-skating control and a snap-in cartridge clip. \$129.50.—**Garrard Div. of British Industries Co.**

Circle 56 on reader's service card



**CB TRANSCEIVER, Model CWT-50,** 5-watt, switchable, crystal-controlled 6-channel operation, with crystals supplied for Channel 9, uses three IC's. Antenna with power-boost loading coil; die-cast metal enclosure with separate mike and speaker. Optional ac power supply. Measures 10½" x 2¼" x 2¼" and weighs 2½ lbs. Comes with ear-phone, hand and shoulder straps.—**Courier Communications Inc.**

Circle 57 on reader's service card

**IN-CIRCUIT TRANSISTOR CHECKER Model IT-18** measures  $\beta$  in or out of circuit in 2 ranges from 2 to 1000; tests diodes in or out of circuit for forward and reverse current to indicate opens or shorts; measures transistors out of circuit

for  $I_{ceo}$  and  $I_{cho}$  leakage; provides identification of pnp or npn devices and anode or cathode of unmarked diodes. Also includes a 4½" 200- $\mu$ A meter and a 10-turn calibrate control. Power is sup-



plied by a D-cell. \$24.95 with attached 3' test leads and a polypropylene case with cover.—**Heath Co.**

Circle 58 on reader's service card

**ROLLS RADIO, No. P685,** is made of heavyweight hand cast metal antiqued in silver. Houses standard transistor radio. Ornamental 1933 Rolls replica, unit is battery powered. \$29.95.—**Monogram Mail Order Sales.**

Circle 59 on reader's service card

**UHER TAPE RECORDER, Royal Deluxe Model 10,000,** includes 4 speeds; built-in Dia Pilot for sound/slide synchronization; sound-on-sound; sound-with-

# It's time to retire the tired!

Servicemen that are tired of dropping screws in hard to reach places... tired of straining in awkward positions. The new patented Vaco Screw Launcher eliminates screw holding problems... holds, starts, and drives with precision and power. It's easy to operate. Just push on the gripping sleeve and the special double-blade wedges firmly into the screw slot. Now, you can quickly mount the screw single-handedly with less effort, less time, less cost. There are eight different sizes and lengths for all types of jobs. Plus, Vaco makes a Screw Launcher for Phillips head or cross-slot screws. All quality-built and carrying Vaco's unconditional guarantee. See these efficient hard-working Screw Launchers at your local Vaco jobber or distributor. Retire yourself from those tiring chores.

**VACO**® Products Company  
510 N. Dearborn Street  
Chicago, Illinois 60610

Circle 110 on reader's service card

# Build New Schober Music Kits

## DYNABEAT RHYTHM

If you want rhythm Schober's got it—10 real trap sounds in a small carrying case. Add bass drum, snare drum, cymbals, and 7 other great rhythm effects to your combo, piano, or organ playing, each at the touch of a button the instant you want it—or have a ball playing traps along with records and radio! The Schober Portable Dynabeat connects to any guitar, hi-fi, or p.a. amplifier, makes you an instant drummer. Kit \$139.50, all built \$169.50. Special Dynabeat for all Schober Organs (not other brands) synchronizes the sounds you want with manuals and pedals. \$150 for the kit.

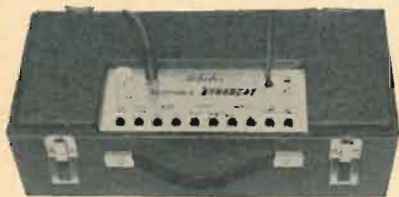

## TUNESMITH MELODY INSTRUMENT

The Schober Tunesmith makes the one-finger artist an instrumental soloist. Produces one note at a time on the 2½-octave keyboard while you control tone color (6 voices), vibrato, pitch, volume, as you play. Carry the melody for a combo or play with piano or organ accompaniment—along with records and radio. Easily portable (13 lbs.), connects to any amplifier. Easy to build kit \$149.50; assembled, ready to plug in and play \$189.50.



Send right now for the full-color Schober catalog, with all details on Dynabeat and Tunesmith as well as Schober's five kit organ models and unique reverberation system. No charge, no obligation. If you like music, you owe yourself a Schober instrument!

THE *Schober* ORGAN CORP., Dept. RE-60  
43 West 61st Street, New York, N.Y. 10023

- Please send me a Schober Organ Catalog.
- Enclosed is 50 cents for 7-inch LP demonstration record of DYNABEAT and Portable TUNESMITH.

NAME \_\_\_\_\_

ADDRESS \_\_\_\_\_

CITY \_\_\_\_\_ STATE \_\_\_\_\_ ZIP \_\_\_\_\_

Circle 111 on reader's service card

sound; echo effect. Also, it features 4-track head-assembly modules, interchangeable in minutes; hysteresis-synchronous motor, output power rating of 10 watts per channel rms. Tape slippage is relatively impossible and it is transported at a speed constancy of



0.025% (wow and flutter specification at 7½ ips). Walnut carrying case with plastic lid. Unit operates in any position; frequency response 20–20,000 Hz  $\pm 2$  dB at 7½ ips.—Martel Electronics

Circle 60 on reader's service card

**AUDIO-VIDEO TAPE RECORDER, Model 1000** combines a 4-track stereo and a video tape recorder, utilizing ¼" magnetic recording tape. Maximum reel size 7". Remote-control pushbutton selection for AUDIO or VTR operation. For VTR operation: tape speed, 11¼" ips; recording



time, 37 minutes; video input, 1.4 V p-p (sync negative) 75 ohms. For AUDIO operation: tape speed, 7½ and 3¾ ips; frequency response, 30 to 18,000 Hz  $\pm 3$  dB at 3¾ ips; distortion, within 1.5% at 1kHz 0 VU; S/N ratio, better than 50 dB. Under \$1000. Accessories, TV monitor and camera available.—Califone-Roberts Div. of Rheem Mfg. Co.

Circle 61 on reader's service card

**ELECTRONIC THERMOTESTER, Thermi**, measures temperature of any component from  $-60$  to  $400^{\circ}\text{F}$  ( $-50$  to  $200^{\circ}\text{C}$ ). Sensitive unit at probe tip reacts instantly upon physical contact, reads out electronically in conjunction with a multimeter or ohmmeter. Simple conversion scale translates values from ohms to degrees. Comes with banana pins and phone tip adapters. \$12.50.—Mura Corp.

Circle 62 on reader's service card

**PA AMPLIFIER, Model UT-35**, has one microphone input, as well as a phono and auxiliary input. Power output is 35 watts on 120 Vac and 32 watts on 14.7



Vdc. Both outputs at less than 10% distortion. Output impedances are 4, 8, 16 ohms, plus 25 and 70 volt line. Measures 7" x 16" x 11" and weighs 25 lbs. \$200.00—Bell P/A Products Corp.

Circle 63 on reader's service card

**RADIO KIT LINE** consists of two kits; Model No. 2001 Comancho transistor radio retails for \$19.95 and Model No. 2002 Scallon table radio retails for \$21.95. Both are designed to teach children and adults important electronic



knowledge and skills and to be built by individuals ages 12 and older. Included with each kit are all necessary parts and fittings and an instructional manual which is very easy to follow.—Graymark Enterprises Inc.

Circle 64 on reader's service card

**VIDEO TAPE RECORDER, Model 6402**, with full-field, slant-track, two-head frequency-modulated recording system. Uses ½-in. magnetic tape at 9½



ips tape speed for maximum 50 or 60 minute recording or playback time on either 7 or 8¼-in. reels. Audio re-record is possible without disturbing the video portion. Measures 18½ x 10½ x 17½-in., weighs 59 lbs. \$1200.—Craig Products Div. of Craig Corp.

Circle 65 on reader's service card

**SUPER 600 TUBE CADDY** is a case of over 3300 cubic inches in volume to hold countless tubes, tools, soldering guns, meters and accessories. Heavy 16-gauge steel runners protect the bottom, bottom edges and bottom corners from damage. Special construction allows the upper foldout sections and covers to rest on the

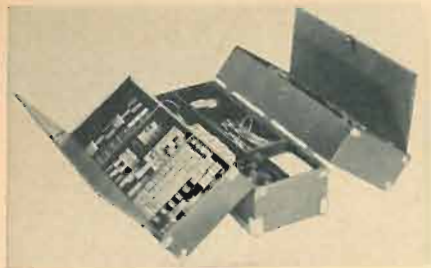

floor when open, giving instant access to all compartments. To go with its rugged construction is a gray vinyl finish.—Argos Products Co.

Circle 66 on reader's service card

**AUDIO CONNECTOR ADAPTERS**, two models; Part Nos. 389 and 430. The former accepts two 3-pin audio connectors to interconnect two pieces of equip-

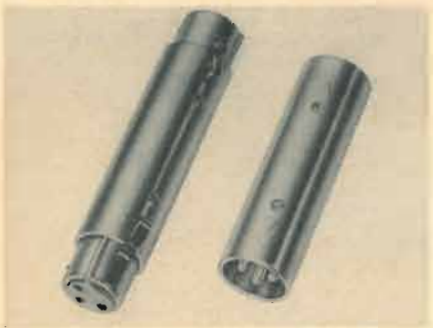

ment or two cables having male output connectors. The latter connects equipment or cables having two 3-pin female audio connector inputs.—Switchcraft Inc.

Circle 67 on reader's service card

**FIBER OPTIC PENLIGHT**, *Speck-O-Lite*, Part No. SL-11 consists of one standard penlight with light-guide adapter; two "AA" batteries; and one foot of fiber-optic light guide, which may be cut to desired length. Unit can be carried in the pocket. Useful for hard-to-see product inspection, repairs and troubleshooting. \$3.29.—Kurz-Kasch, Inc.

Circle 68 on reader's service card

**SOCKET NUTDRIVER SET**, Model No. 30999, has five ¼-in. drive sockets (¼ thru ½-in.) in a hollow spinner han-

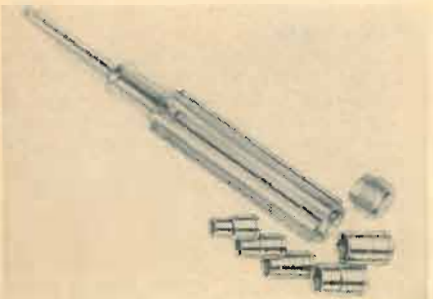

dle. Sockets have extra-thin walls, are nickel chrome-plated against rust and corrosion.—Krauter Tools

Circle 69 on reader's service card

## NEW LITERATURE

All booklets, catalogs, charts, data sheets and other literature listed here with a Reader's Service number are free for the asking. Turn to the Reader's Service Card facing page 74 and circle the numbers of the items you want. Then detach and mail the card. No postage required!

**1969 ELECTRONICS CATALOG No. 280**, 536-page illustrated buyer's guide covering the latest range of TV sets and components, 2-way CB radio equipment, hi-fi systems, ham gear, tools, hardware, and electronic kits.—Allied Radio

Circle 70 on reader's service card

**1969 ELECTRONICS CATALOG, No. 690**, 512 pages, fully illustrated with 57 pages in 4 color. Features hi-fi equipment, latest citizens band 2-way radios, test equipment, ham gear, optics, tools, books, musical instruments, and complete listings of all major lines of electronic parts.—Lafayette Radio Electronics

Circle 71 on reader's service card

**MACHINED ALUMINUM KNOBS**, Catalog K-688, 6 pages. Details six new series of knobs including standard, miniature, skirted, deluxe and various knurled types. Anodizing process for colors of natural aluminum, ebony, or soft gold.—Alco Electronic Products, Inc.

Circle 72 on reader's service card

**ANTENNAS**. Two catalogs: No. 402-ILL, 6 pages, describes briefly a series of outdoor antennas. Models included are for uhf/vhf/FM, vhf/FM, uhf and FM. Uhf converters and accessories are also outlined. No. 404-SL, 4 pages, features a Monitor series of six indoor antennas for uhf-vhf-FM and vhf-FM plus accessories.—Gavin Instruments, Inc.

Circle 73 on reader's service card

**ANTENNA EQUIPMENT**, Catalog No. SYS-68, 16 pages, covers broadband and single channel antennas; broadband and single channel head end amplifiers, active and passive accessories; filters and traps; tapoffs, matching transformers and wallplates; preamplifiers, amplified couplers, connectors and cable.—JFD Electronics Co.

Circle 74 on reader's service card

**ANTENNA ROTOR**. 4-page catalog describes how *Dyna-Rotor* combines solid-state circuitry and a spline drive for greater efficiency. Cutaway diagrams show how unit works.—Jerrold Electronics Corp.

Circle 75 on reader's service card

**CAPACITOR CATALOG, 68/69** *Component Selector* devotes 119 pages to help user select proper stock items designed to meet his requirements. The capacitor reference data provide detailed background regarding capacitor, standardization and rating selection. It also includes application charts, type selector charts and standard-rating selector tables.—Cornell-Dubilier Electronics

Circle 76 on reader's service card

**ELECTRICAL COMPONENTS**. Tabloid type 8-page catalog lists components such as tunnel diodes, integrated circuits, integrated amplifiers and many semiconductors. Fiber-optic devices, meters, switches and other components are also included.—Poly-Paks Inc.

R-E

Circle 77 on reader's service card

## Be an expert on how to select the best automatic turntable.

A true hi-fidelity automatic turntable is a precision built mechanism with many many parts, each of which has a very special function to perform. Very often, to save money in manufacturing, some companies either compromise on the quality of these parts, or leave certain of them out. The turntable will still operate of course but forget about getting maximum high-fidelity. How can you tell when a turntable has everything? Use our BSR McDonald 600 as an example of perfection. It has all of these essential features that a professional quality automatic turntable must have to insure peak performance.

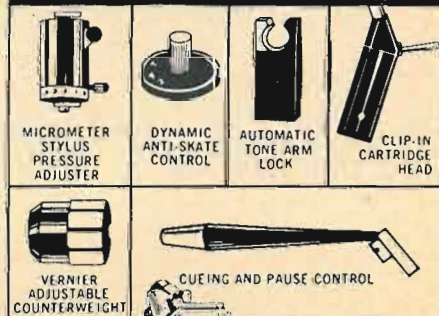

Please send FREE detailed literature on all BSR McDonald automatic turntables.

Name \_\_\_\_\_

Address \_\_\_\_\_

City \_\_\_\_\_ State \_\_\_\_\_ Zip \_\_\_\_\_



**McDONALD**

PRECISION CRAFTED IN GREAT BRITAIN  
BSR (USA) LTD., BLAUVELT, N.Y. 10913

Circle 112 on reader's service card

# There's A "Just Right" Heathkit®



**NEW kit AD-27**  
**\$169<sup>95</sup>**



**NEW kit AD-17**  
**\$109<sup>95</sup>**



**NEW kit AS-18**  
**\$32<sup>95</sup>**



**kit AR-15**      **Wired ARW-15**  
**\$339<sup>95\*</sup>**      **\$525<sup>00\*</sup>**



**NEW kit AJ-15**  
**\$189<sup>95\*</sup>**



**NEW kit AA-15**  
**\$169<sup>95\*</sup>**

## NEW HEATHKIT AD-27 FM Stereo Component-Compact

This new Heathkit AD-27 stereo compact has features not found in other units costing twice as much for one very simple reason. It wasn't engineered to meet the usual level of compact performance. Instead, Heath took one of its standard stereo/hi-fi receivers, the AR-14, and re-arranged it physically to fit a compact configuration. The result is performance that is truly high fidelity without compromise. It features 31 transistor, 10 diode circuitry with 15 watts per channel dynamic music power (enough to let you choose most any speaker system you prefer), full-range tone controls, less than 1% distortion, and 12 to 60,000 Hz response. The pre-assembled FM stereo tuner section with 4-stage IF offers 5  $\mu$ V sensitivity, excellent selectivity, AFC, and the smoothest inertia tuning. The BSR McDonald "500" turntable offers features usually found only in more expensive units . . . like low mass tubular aluminum tone arm, anti-skate control, cueing and pause control, plus a Shure magnetic cartridge with diamond stylus. It's all housed in a smart oiled walnut cabinet with sliding tambour door that disappears inside the cabinet. For value and performance choose the AD-27, the new leader in stereo compacts. Shpg. wt. 41 lbs.

## NEW HEATHKIT AD-17 Budget-Priced Component-Compact

Heath engineers took the stereo amplifier from the AD-27 above, matched it with the top rated BSR McDonald 400 Automatic Turntable and put both of these able performers in an attractive walnut cabinet. The result is the high performance, low cost AD-17. The all solid-state circuit delivers 15 watts music power per channel — more than enough to drive any reasonably efficient system. Wide response of 12 Hz to 60 kHz  $\pm$  1 dB and harmonic & IM distortion both less than 1% at full output are your guarantee of clean, full range sound. Stereo headphone jack, filtered tape outputs and Tuner & Auxiliary inputs too. The BSR McDonald 400 Automatic Turntable features a cueing and pause control, adjustable stylus pressure, variable anti-skate control and manual or automatic operation on all four speeds. Comes complete with a famous Shure magnetic cartridge. The Heathkit manual makes it easy to build . . . the sound makes it a pleasure to own. Order yours now. 27 lbs.

## NEW HEATHKIT AS-18 Miniature Acoustic Suspension System

The new AS-18 features famous high quality Electro-Voice® speakers — 6" woofer and a 2½" tweeter. The wide frequency response of 60 Hz to 20 kHz and the clear, natural sound of these miniature systems will really amaze you. They're the ideal performance mates to the Component Compacts above and are especially suited for apartments, mobile homes, offices, etc. — anywhere that you need superior stereo sound from a small space. Handles up to 25 watts program material and has a high frequency balance control so you can adjust the sound to your liking. Order 2 for superb stereo now. 16 lbs.

## HEATHKIT AR-15 Deluxe Stereo Receiver

The World's Most Sophisticated, Most Praised Stereo Receiver. And here are just a few of the reasons why leading audio critics and testing organizations, as well as thousands of owners rate the AR-15 as THE stereo receiver. The all solid-state circuit with 69 transistors, 43 diodes and two integrated circuits has many new design concepts to deliver superior performance. The amplifier section has 150 watts of music power . . . 75 watts per channel. Harmonic and IM distortion are both less than 0.5%. The special design FET FM tuner boasts sensitivity of 1.8  $\mu$ V, selectivity of 70 dB and harmonic & IM distortion both less than 0.5%. The Crystal Filters provide an ideally shaped bandpass and are a Heath first in the high fidelity industry. You'll hear stations you didn't even know existed in your area, and the Noise-Operated Squelch, Adjustable Phase Control, Stereo-Only Switch, Stereo Threshold Control and FM Stereo Noise Filter Switch will let you hear them in the clearest, most natural way. Other features include two front panel stereo headphone jacks, positive circuit protection, loudness switch, speaker switch, front panel input level controls, recessed outputs, two external FM antenna connectors and one for AM, Tone Flat control, electronically filtered power supply and "Black Magic" panel lighting. Seven circuit boards and three wiring harnesses simplify assembly and you can mount your completed AR-15 in a wall, your own cabinet or the Heath assembled walnut cabinet. For the ultimate in a stereo receiver, order your AR-15 now. 34 lbs. \*Optional walnut cabinet AE-16, \$24.95.

## HEATHKIT AJ-15 Deluxe Stereo Tuner

For the man who already owns a fine stereo amplifier, Heath now offers the superb FM stereo tuner section of the AR-15 receiver as a separate unit. The new AJ-15 FM Stereo Tuner has the exclusive FET FM tuner for remarkable sensitivity, exclusive Crystal Filters in the IF strip for perfect response curve and no alignment; Integrated Circuits in the IF for high gain, best limiting; Noise-Operated Squelch; Stereo-Threshold Switch; Stereo-Only Switch; Adjustable Multiplex Phase, two Tuning Meters; two Stereo Phone jacks; "Black Magic" panel lighting. 18 lbs. \*Walnut cabinet AE-18, \$19.95.

## HEATHKIT AA-15 Deluxe Stereo Amplifier

For the man who already owns a fine stereo tuner, Heath now offers the famous amplifier section of the AR-15 receiver separately. The new AA-15 Stereo Amplifier has the same superb features: 150 watts Music Power; Ultra-Low Harmonic & IM Distortion (less than 0.5% at full output); Ultra-Wide Frequency Response ( $\pm$  1 dB, 8 to 40,000 Hz at 1 watt); Front Panel Input Level Controls; Transformerless Amplifier; Capacitor Coupled Outputs; All-Silicon Transistor Circuit; Positive Circuit Protection. 26 lbs. \*Walnut cabinet AE-18, \$19.95.



# Gift For Everyone On Your List

## Heathkit MI-18 Solid-State Tachometer

The Professional Tach. That's the new Heathkit MI-18. In Design: breaker point, "tach" lead or unique inductive pickup connection; use it with any spark-type engine and any ignition system, 2 cycle 1-6 cyl. engines or 4 cycle, 2-8 cyl. engines . . . all electronics are in the tach itself. In Performance: 0-6000 & 0-9000 RPM ranges . . . 250° edge-lighted dial . . . temperature-compensated, ±4% accuracy from 0° —120° . . . adjustable red line pointer . . . 10.5 to 17.5 VDC operation. In Styling: stainless steel hardware, splash-proof black & chrome case and scratch-proof glass face for use in rugged conditions. The MI-18-1 mounts in your dash — requires only a 3¼" hole & 2¼" depth. The MI-18-2 comes with mounting case & hardware. Put a Professional Tach in your car, boat, dune-buggy, or bike now — the Heathkit MI-18! Shpg. wt. 3 lbs.

NEW kit MI-18-1

\$29<sup>95</sup> Panel Mount

NEW kit MI-18-2

\$32<sup>95</sup> With Case



## Heathkit GR-17 Solid-State AM-FM Portable Radio

Here's performance the others can't match. The new Heathkit GR-17 portable has a 12 transistor, 7 diode circuit with the same front end as used in Heathkit hi-fi tuners. AM or FM at the flick of a switch and what reception! Big ½" ferrite rod antenna, three tuned transformers and amplified AGC pull in more AM stations. The FM section features a collapsible 34" whip antenna, three IF stages and 5 uV sensitivity for reception over greater distances than you would expect from a portable. The 4" x 6" speaker and an audio output of 350 mW provides clean sound and the GR-17 will keep you entertained for up to 300 hours on a single set of batteries. For the greatest sound everywhere, get your GR-17 today. 5 lbs.

NEW kit GR-17

\$43<sup>95</sup>



## NEW HEATHKIT HW-100 SSB-CW 5-Band Receiver

The new Heathkit HW-100 has all the features and performance of the competition at a money saving kit price. And here's what it delivers: the receiver portion has sensitivity of less than 0.5 uV for a 10 dB S+N/N ratio for SSB. Crystal filter selectivity is 2.1 kHz at 6 dB down, 7 kHz at 60 dB down. Image & IF rejection are better than 50 dB. The transmitter has a 180 watt input on either USB or LSB and 170 watts on CW. It operates PTT or VOX on SSB and break-in CW work is provided by operating VOX from a keyed tone, using grid-block keying. Outstanding frequency stability — less than 100 Hz per hour drift after 30 minute warmup . . . less than 100 Hz variation under a 10% line voltage variation. The HW-100 is a really loaded rig — solid-state (FET) VFO . . . 80-10 meter coverage . . . patented Harmonic Drive™ dial mechanism . . . built-in 100 kHz calibrator . . . TALC and much more. Put this hot rig in your shack — order your HW-100 today. 22 lbs.

NEW kit HW-100

\$240<sup>00</sup>



## HEATHKIT GR-104A Solid-State Portable B&W TV

The perfect portable . . . that's the GR-104. Small and light enough to carry from room to room . . . rugged enough to take it . . . and the picture is the sharpest, most realistic you've ever seen, thanks to Heathkit total engineering. 74 sq. in. viewing area . . . all solid-state circuit for extra reliability and performance . . . covers all VHF and UHF channels, 2-83 . . . 2-speed UHF tuning . . . "memory" VHF fine tuning . . . 3-stage IF for maximum gain with controlled bandwidth . . . gated AGC for steady, jitter-free pictures . . . transformer regulated power supply . . . circuit breaker protection . . . one-piece swing out chassis for easy assembly and servicing . . . runs on house current or battery power with the optional GRA-104-1 rechargeable battery pack. 27 lbs.

kit GR-104A

\$119<sup>95</sup>



GRA-104-1, 9 lbs. . . . . \$39.95

## HEATHKIT GD-325C Low Cost Solid-State Organ

This money-saving kit form of the popular Thomas "Artiste" Organ can have you playing songs after just 50 hours of interesting, enjoyable assembly, thanks to the clear, easy-to-follow Heathkit manual and exclusive Thomas Color-Glo teaching method. Features 10 true organ voices . . . variable repeat percussion . . . 13 note heel and toe bass pedals . . . 2 overhanging 37 note keyboards, range C2 thru C5 each . . . 75 watt peak music power amplifier . . . 12" full response speaker . . . Vibrato . . . manual balance control . . . and the solid-state plug-in tone generators — the heart of the organ, are guaranteed for 5 years. Assembled walnut-finish cabinet included. Discover the fun and enjoyment of live music in your home . . . order your Heathkit/Thomas organ today. 172 lbs.

kit GD-325C

\$439<sup>95</sup>

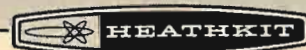

HEATH COMPANY, Dept. 20-11  
Benton Harbor, Michigan 49022  
In Canada, Daystrom Ltd.

Enclosed is \$ \_\_\_\_\_, plus shipping.

Please send model (s) \_\_\_\_\_

Please send FREE Heathkit Catalog.

Please send Credit Application.

Name \_\_\_\_\_

Address \_\_\_\_\_

City \_\_\_\_\_

State \_\_\_\_\_

Zip \_\_\_\_\_

Prices & specifications subject to change without notice.

CL-345



NEW

FREE 1969 CATALOG!

Now with more kits, more color. Fully describes these along with over 300 kits for stereo/hi-fi, color TV, electronic organs, electric guitar & amplifier, amateur radio, marine, educational, CB, home & hobby. Mail coupon or write Heath Company, Benton Harbor, Michigan 49022.

# Make This Christmas



Kit IM-18  
\$28<sup>50</sup>  
Wired IMW-18  
\$47<sup>95</sup>

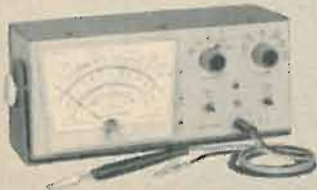

kit IM-28  
\$36<sup>50</sup>  
Wired IMW-28  
\$56<sup>95</sup>



Kit IM-38  
\$39<sup>50</sup>  
Wired IMW-38  
\$54<sup>95</sup>



kit IM-17  
\$21<sup>95</sup>



kit IT-18  
\$24<sup>95</sup>



kit IP-18  
\$19<sup>95</sup>



kit IG-57  
\$135<sup>00</sup>  
wired IGW-57  
\$199<sup>00</sup>



kit IO-18  
\$84<sup>95</sup>  
wired IOW-18  
\$139<sup>95</sup>

## NEW HEATHKIT IM-18 VTVM

The new IM-18 is a direct decendent of the world's most popular VTVM — the Heathkit IM-11, and continues the features that made the IM-11 famous . . . 7 AC and 7 DC voltage ranges that measure from 0-1500 volts full scale . . . 7 ohms ranges for resistance measurements from 0.1 ohm to 1000 megohms . . . single probe convenience that ends tangled leads & enables you to change from AC to DC/Ohms measurements with a flip of the switch on the probe . . . the light circuit loading of 11 megohm input impedance . . .  $\pm 1$  dB 25 Hz to 1 MHz response . . . precision 1% resistors . . . DC polarity reversing position on the function switch . . . measurement capability for RMS and Peak-To-Peak AC voltages and dB . . . precision  $4\frac{1}{2}$ " 200  $\mu$ A meter for extra sensitivity. In addition, the new IM-18 includes wiring options for 120V. or 240 VAC operation and a three-wire line cord for added safety. 5 lbs.

## NEW HEATHKIT IM-28 "Service Bench" VTVM

The new Heathkit IM-28 bears the proud tradition of the IM-13, and it has the same performance specifications as the new IM-18 above — an unbeatable combination! But it also has a number of features that put it in a class by itself, like a large 6" meter with easy-to-read markings . . . extra 1.5 and 5 volt AC ranges for additional accuracy . . . a secure gimbal mounting that allows you to put the IM-28 above, below or in front of your most convenient mounting surface . . . "Set and Forget" calibration — all calibration controls are screwdriver adjustable from the front panel to eliminate disassembly . . . smooth ten-turn vernier control of Zero and Ohms Adjust for greater accuracy and easier setting . . . dual primary transformer for 120/240 VAC operation . . . safe 3-wire line cord as well. The new look of Heathkit instrument styling is evident too — handsome beige & brown color scheme, and new knobs that are easy to turn and fast to read. 7 lbs.

## NEW HEATHKIT IM-38 Laboratory AC VTVM

For all around general service work, audio design and trouble-shooting or laboratory analysis, you couldn't find a better value than the new Heathkit IM-38 AC VTVM. Here's why — 10 voltage ranges measure from 0.01 to 300 volts RMS full scale . . . an extended frequency response of 10 Hz to 500 kHz at  $\pm 1$  dB . . . 10 megohm input on all ranges for higher accuracy and minimal circuit loading . . . wide dB range: -12 to +2 on the meter and ten switch-selected ranges from -40 to +50 in 10 dB steps . . . VU-type ballistic meter damping . . . amplifier filament voltage transformer winding that's balanced to ground for low AC noise . . . 120/240 AC wiring options and new Heathkit styling in sharp beige & brown with an easy-to-grasp, easy-to-read knob. Heathkit engineering has made assembly easy and performance tops. 5 lbs.

## HEATHKIT IM-17 Solid-State Volt-Ohm Meter

Another very popular volt-ohmmeter from Heathkit engineering and it's easy to see why — all solid-state circuitry . . . high impedance FET input, 11 megohms on DC, 1 megohm on AC . . . 4 AC voltage ranges . . . 4 DC voltage ranges . . . 4 ohm ranges . . .  $4\frac{1}{2}$ " 200  $\mu$ A meter . . . 3 built-in test leads . . . DC polarity reversing switch . . . zero-adjust & ohms-adjust controls . . . continuous 12-position function switch. And that's not all — the IM-17 is battery powered for complete portability and comes in a rugged polypropylene case with built-in handle. Simple circuit board assembly. 4 lbs.

## HEATHKIT IT-18 In-Circuit Transistor Tester

In-Circuit transistor testers don't have to be expensive, and the IT-18 is proof of that . . . tests DC Beta 2-1000, in or out-of-circuit . . . leakage  $I_{cbo}$  and  $I_{ceo}$  current 0-5000  $\mu$ A out-of-circuit . . . identifies NPN or PNP devices . . . tests diodes in or out-of-circuit for opens & shorts . . . identifies unknown diode leads . . . matches PNP & NPN transistors. The IT-18 is completely portable — runs on just one "D" cell. Easy to use too . . . rugged polypropylene case, attached 3' test leads, big  $4\frac{1}{2}$ " 200  $\mu$ A meter, all front panel controls, 10-turn calibrate control. 4 lbs.

## HEATHKIT IP-18 1-15 VDC Power Supply

If you work with transistors, this is the power supply for you. All solid-state circuitry provides 1-15 VDC at up to 500 mA continuous. Features adjustable current limiting, voltage regulation, floating output for either + or - ground, AC or DC programming, circuit board construction, and small, compact size. 110 or 220 VAC. 5 lbs.

## HEATHKIT IG-57 Solid-State Post Marker/Sweep Generator

The new IG-57 plus a 'scope is all you need . . . no external sweep generator required. Switch selection of any of 15 crystal-controlled marker frequencies (you can view up to six different frequencies on one 'scope trace). Select the sweep range and you are ready to instantly see the results of any changes you make. Four markers for setting color bandpass, one for TV sound, eight at IF frequencies between 39.75 & 47.25 MHz plus picture and sound carrier markers for channels 4 & 10. Three sweep oscillators produce the 5 most-used ranges . . . color bandpass, FM IF, color & B&W IF and VHF channels 4 & 10. Save hundreds of dollars and put full alignment facilities in your shop too — order your IG-57 now. 14 lbs. Kit IG-14, same as IG-57 w/o the sweep, 11 lbs. \$99.95.

## HEATHKIT IO-18 Wide-Band 5" 'Scope

The New Heathkit IO-18 is destined to be the world's most popular 'scope, just as its predecessor, the IO-12 was. Features 5 MHz bandwidth, the famous Heath patented sweep circuit — 10 Hz to 500 kHz in 5 ranges, two extra sweep positions which can be preset to often-used rates, frequency compensated vertical attenuation, built-in P-P calibration reference, Z-axis input, retrace blanking, wiring options for 120 or 240 VAC operation and new Heathkit styling in beige and brown. 24 lbs.

# A Heathkit® Holiday

**Wish Your Family Merry Christmas This Year  
With A New Heathkit Color TV... A Better  
Buy Than Ever With New Lower Prices**

**NEW Deluxe Color TV With Automatic  
Fine-Tuning—Model GR-681** kit GR-681  
\$499<sup>95</sup> (less cabinet)

The new Heathkit GR-681 is the most advanced color TV on the market. A strong claim, but easy to prove. Compare the "681" against every other TV — there isn't one available for any price that has all these features. Automatic Fine Tuning on all 83 channels . . . just push a button and the factory assembled solid-state circuit takes over to automatically tune the best color picture in the industry. Push another front-panel button and the VHF channel selector rotates until you reach the desired station, automatically. Built-in cable-type remote control that allows you to turn the "681" on and off and change VHF channels without moving from your chair. Or add the optional GRA-681-6 Wireless Remote Control described below. A bridge-type low voltage power supply for superior regulation; high & low AC taps are provided to insure that the picture transmitted exactly fits the "681" screen. Automatic degaussing, 2-speed transistor UHF tuner, hi-fi sound output, two VHF antenna inputs . . . plus the built-in self-servicing aids that are standard on all Heathkit color TV's but can't be bought on any other set for any price . . . plus all the features of the famous "295" below. Compare the "681" against the others . . . and be convinced.

**GRA-295-4**, Mediterranean cabinet shown . . . . . \$119.50  
Other cabinets from \$62.95

**Deluxe "295" Color TV...Model GR-295** now only  
\$449<sup>95</sup>

(less cabinet)

Big, Bold, Beautiful . . . and packed with features. Top quality American brand color tube with 295 sq. in. viewing area . . . new improved phosphors and low voltage supply with boosted B+ for brighter, livelier color . . . automatic degaussing . . . exclusive Heath Magna-Shield . . . Automatic Color Control & Automatic Gain Control for color purity, and flutter-free pictures under all conditions . . . preassembled IF strip with 3 stages instead of the usual two . . . deluxe VHF tuner with "memory" fine tuning . . . three-way installation — wall, custom or any of the beautiful Heath factory assembled cabinets. Add to that the unique Heathkit self-servicing features like the built-in dot generator and full color photos in the comprehensive manual that let you set-up, converge and maintain the best color picture at all times, and can save you up to \$200 over the life of your set in service calls. For the best color picture around, order your "295" now.

**GRA-295-1**, Walnut cabinet shown . . . . . \$62.95  
Other cabinets from \$99.95

**Deluxe "227" Color TV...Model GR-227** now only  
\$399<sup>95</sup>

(less cabinet)

Has same high performance features and built-in servicing facilities as the GR-295, except for 227 sq. inch viewing area. The vertical swing-out chassis makes for fast, easy servicing and installation. The dynamic convergence control board can be placed so that it is easily accessible anytime you wish to "touch-up" the picture.

**GRA-227-1**, Walnut cabinet shown . . . . . \$59.95  
Mediterranean style also available at \$99.50

**Deluxe "180" Color TV...Model GR-180** now only  
\$349<sup>95</sup>

(less cabinet)

Same high performance features and exclusive self-servicing facilities as the GR-295 except for 180 sq. inch viewing area. Feature for feature the Heathkit "180" is your best buy in deluxe color TV viewing . . . tubes alone list for over \$245. For extra savings, extra beauty and convenience, add the table model cabinet and mobile cart.

**GRS-180-5**, table model cabinet and cart . . . . . \$39.95  
Other cabinets from \$24.95

## Now, Wireless Remote Control For Heathkit Color TV's

Control your Heathkit Color TV from your easy chair, turn it on and off, change VHF channels, volume, color and tint, all by sonic remote control. No cables cluttering the room . . . the handheld transmitter is all electronic, powered by a small 9 v. battery, housed in a small, smartly styled beige plastic case. The receiver contains an integrated circuit and a meter for adjustment ease. Installation is easy even in older Heathkit color TV's thanks to circuit board wiring harness construction. For greater TV enjoyment, order yours now.

**kit GRA-681-6**, 7 lbs., for Heathkit GR-681 Color TV's . . . . . \$59.95  
**kit GRA-295-6**, 9 lbs., for Heathkit GR-295 & GR-25 TV's . . . . . \$69.95  
**kit GRA-227-6**, 9 lbs., for Heathkit GR-227 & GR-180 TV's . . . . . \$69.95

**Now There Are 4 Heathkit Color TV's . . .  
All With 2-Year Picture Tube Warranty**



kit GR-681



kit GR-295



kit GR-227



kit GR-180



**New Wireless  
TV Remote Control**  
For GR-295, GR-227  
& GR-180

\$69<sup>95</sup>

**New Wireless  
TV Remote Control**  
For GR-681

\$59<sup>95</sup>

# LOOK! A NEW ELECTRONICS SLIDE RULE with complete instruction program



Here's a great *new* way to solve electronic problems accurately, easily . . . a useful tool for technicians, engineers, students, radio-TV servicemen and hobbyists. The Cleveland Institute Electronics Slide Rule is the only rule designed *specifically* for the exacting requirements of electronics computation. It comes complete with an illustrated Instruction Course. You get four AUTO-PROGRAMMED lessons . . . each with a short quiz you can send in for grading and consultation by CIE's expert instructors.

all kinds of reactance, resonance, inductance, AC and DC circuitry problems in seconds . . . become a whiz at conventional computations too!

This all-metal 10" rule is made to our rigid specs by Pickett, Inc. . . . comes complete with top grain leather carrying case *and* Instruction Course. A \$50 value for less than \$25. Send coupon for FREE illustrated booklet *and* FREE heavy vinyl Pocket Electronics Data Guide. Cleveland Institute of Electronics, 1776 E. 17th St., Dept. RE-158, Cleveland, Ohio 44114.

See for yourself. Learn how to whip through

**GET BOTH FREE!**

**ELECTRONICS**

**SLIDE RULE**

**Send coupon today →**

**Cleveland Institute of Electronics**

1776 E. 17th St., Dept. RE-158, Cleveland, Ohio 44114

Send FREE Electronics Slide Rule Booklet. Special Bonus: Mail promptly and get FREE Pocket Electronics Data Guide too!

NAME \_\_\_\_\_ (Please Print)

ADDRESS \_\_\_\_\_ COUNTY \_\_\_\_\_

CITY \_\_\_\_\_ STATE \_\_\_\_\_ ZIP \_\_\_\_\_

**A leader in Electronics Training... since 1934**

Circle 114 on reader's service card

# ADD EXTRA PROFIT WITH OAKTRON SPEAKERS

- 1 PVS-800, unique, patented speaker-baffle combination that can be used inside or out. Out performs most 2-speaker units.
- 2 STEREO-SPEAKER KIT for cars, trailers, boats, or planes. Easy to install, 6 different models. Skin-packed ready to move.
- 3 REAR SEAT SPEAKER KIT. 20 models each includes all accessories. Skin-packed for easier merchandising.
- 4 REPLACEMENT SPEAKERS, highest quality, skin-packed, over 100 models to choose from.



AND A COMPLETE LINE OF ASSOCIATED ITEMS

Write or phone for complete information from this major manufacturer of quality speakers.

**OAKTRON** **ALMA**

930 30th St., Monroe, Wisconsin 53566

Circle 115 on reader's service card

## EQUIPMENT REPORT

### B&K 465 CRT Tester

For manufacturer's literature, circle No. 116 on Reader Service Card.

THE B&K 465 CRT TESTER IS ANOTHER addition to the long line of popular test instruments from this company. It will test any black-and-white or color picture tube, and is much more "obsolescence-proof" than the older crt testers.

A big factor in this is the use of a five-step heater voltage switch, with a variable resistance in series. This allows setting the heater to any voltage between zero and 13 Vac. Actual voltage on the heater is read on the meter. So, the "full-load" voltage can be read at all times.



The control grid (G1) voltage can be varied from 0 to 100 volts, and the G2 or screen-grid voltage from 0 to 300 volts. This permits checking tubes for proper cutoff with actual operating conditions duplicated as closely as possible. The variable G2 voltage also lets you check low-G2 tubes without danger of damaging them.

A three-step rejuvenator, familiar to B&K users as the Dynamic Intensifier, is used for rejuvenation of weak crt's, including individual guns of color tubes. The voltage applied is controlled and timed to avoid unnecessary "overshooting."

A neon-lamp indicator on the panel shows shorts between heater and cathode, G1 and G2. A REMOVE-SHORTS position on the selector switch,

used with the rejuvenator voltage, will burn out most of the "particle" type of shorts in crt's. The heater voltage is not applied to the tube during this operation, lessening the danger of damage.

A three-position slide switch selects each gun of color tubes. Tests may be made for shorts, cutoff and emission. For the important gun-balance test, the reading of each gun can be compared to the rest by flipping this switch back and forth.

If a color tube's guns will read within the "best gun output not more than 1.5 times that of the worst" formula, the tube is good. In weak tubes, the low gun can often be rejuvenated to bring its emission up to that of the good ones.

Color tubes can also be checked for "warmup drift" in screen color. This is done by letting the tube cool off completely, then repeating the mission test, logging the meter reading of each gun after 2 minutes, then after 4 minutes.

The panel meter has a two-position sensitivity switch. This is used in testing certain special crt's to get adequate meter deflection. Most tubes will read in the "normal" position.

The standard 12-pin socket is used on the cable to the tester. Adapters plug into this to match all presently used crt bases, including round and rectangular color tubes, and even the very small bases used on some miniature crt's.

During the bench testing of this instrument, we successfully blew a short out of an old crt, and rejuvenated several others, including an aged color tube that had a sickly green look due to gun unbalance. All in all, a well-built and useful piece of test equipment.—*Jack Darr* **R-E**

### Live Cheaper Electronically

As the cost of living soars, electronic items provide a major exception to the trend. In its latest consumer price index, the Department of Labor found that the average prices of all cost-of-living items in June 1968 had risen 20.9% above the prices prevailing in 1957-59. However, portable and console TV set prices declined 19.8%, and portable and table radio prices dropped 22.8% in the same period.

The cost of repairs has gone up, but not nearly so much as the average of other consumer expenses. **R-E**

# NO COMPETITORS

Nobody else but **EMC** designs in so much value



- Compact, light-weight portability. Use it on the bench or in the field.
- Full-view meter gives direct, clear-cut quality indications.
- Three heavy-duty controls for quick set-up of all tests. Check a fistful of tubes in the time it often takes to test one.
- 12 slide switches for individual selection of tube pins provides versatility in testing, prevents obsolescence.
- Full complement of sturdy sockets accepts compactron (12-pin), nuvistor, novar, 10-pin, 9-pin, octal, loctal, and miniature tubes.
- Precise programming. Only one socket per tube-base configuration prevents accidental plug-in.

THE MODEL 213 saves you time, energy, money ■ Checks for shorts, leakage, intermittents, and quality ■ Tests all tube types including magic eye, regulator, and hi-fi tubes ■ Checks each section of multi-purpose tubes separately ■ Gives long, trouble-free life through heavy-duty components, including permanently etched panel ■ Keeps you up to date with FREE, periodic listings on new tubes as they come out ■ Your best dollar value in a tube tester. Available in high-impact bakelite case with strap; \$31.40 wired; \$20.40 in kit form. Wood carrying case (illustrated) slightly higher.

# EMC

**ELECTRONIC MEASUREMENTS CORPORATION**  
625 Broadway, New York 12, New York  
Expbrt: Pan-Mar Corp., 1270 B'way, N. Y. 1, N. Y.

**EMC, 625 Broadway, New York 12, N. Y.**  
Rush me FREE catalog describing all EMC value-loaded test instruments and name of local distributor.

NAME \_\_\_\_\_

ADDRESS \_\_\_\_\_

CITY \_\_\_\_\_ ZONE \_\_\_\_\_ STATE \_\_\_\_\_

RE-11

## The Sony Side of the Street

(it's any place they're showing the new 6060 receiver)

A superb performer on FM stereo, FM and AM broadcasts, records and tapes. It will brighten up the music in your life.

The 6060 has all the power (110 watts IHF into 8 ohms) to drive any speaker system. The sensitive (1.8uV) FM tuner picks up even the weakest stations. Yet, it is insensitive to interference. Controls are abundant and easy to use: zero-center tuning meter, headphone jack, switches for tape monitoring, muting, speaker selection, etc.

At \$399.50 (suggested list) the 6060 outshines receivers costing up to \$500. Sony Corporation of America, 47-47 Van Dam Street, Long Island City, N.Y. 11101

The TRUE electronic solution to a major problem of engine operation!

## DELTA'S FABULOUS MARK TEN®



Only \$44.95 ppd.  
In easy-to-build Deltakit®  
Only \$29.95 ppd.

### CAPACITIVE DISCHARGE IGNITION SYSTEM

You've read about The Mark Ten in *Mechanix Illustrated*, *Popular Mechanics*, *Electronics* and other publications!

Now discover for yourself the dramatic improvement in performance of your car, camper, jeep, truck, boat—any vehicle! Delta's remarkable electronic achievement saves on gas, promotes better acceleration, gives your car that zip you've always wanted. Find out why even Detroit has finally come around. In four years of proven reliability, Delta's Mark Ten has set new records of ignition benefits. No re-wiring! Works on literally any type of gasoline engine.

Why settle for less when you can buy the original DELTA Mark Ten, never excelled and so unique that a U.S. Patent has been granted.

#### READY FOR THESE BENEFITS?

- ▲ Dramatic Increase in Performance and in Fast Acceleration
- ▲ Promotes more Complete Combustion
- ▲ Points and Plugs last 3 to 10 Times Longer
- ▲ Up to 20% Mileage Increase (saves gas)

LITERATURE SENT BY RETURN MAIL  
BETTER YET—ORDER TODAY!



**DELTA PRODUCTS, INC.** DP 7-17

P.O. Box 1147 RE • Grand Junction, Colo. 81501

Enclosed is \$ \_\_\_\_\_  Ship ppd.  Ship C.O.D.

Please send:

- Mark Tens (Deltakit®) @ \$29.95
- (12 VOLT POSITIVE OR NEGATIVE GROUND ONLY)
- Mark Tens (Assembled) @ \$44.95
- 6 Volt: Negative Ground only.
- 12 Volt: Specify  Positive Ground  Negative Ground

Car Year: \_\_\_\_\_ Make \_\_\_\_\_

Name \_\_\_\_\_

Address \_\_\_\_\_

City/State \_\_\_\_\_ Zip \_\_\_\_\_

Circle 118 on reader's service card

#### SERVICE CLINIC

(continued from page 27)

could never get convergence until I discovered this!

Here's another thing to check. Be sure that your red adjustments have the proper range, so that the tilt and amplitude controls will cause the lines to curve or straighten as they should. Compare the range of the red adjustments with that of the green adjustments, for example. If they don't move the red as far as they ought to, check the tilt and amplitude controls for possible open circuits, broken wiring, etc.

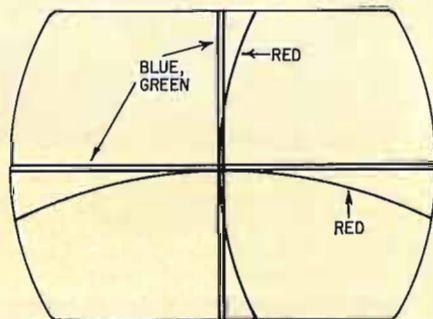

One more: go back and run purity again. Watch out for edge purity: the yoke adjustment. Then, put your dot or crosshatch pattern back on, and move the deflection yoke *very slightly* back and forth, watching your edge convergence. At the same time, check the positioning of your convergence yoke. If this accidentally gets knocked too far forward, it'll cause this same symptom. Also, move the convergence yoke very slightly back and forth (watching your convergence at the edges), and very slightly around the tube neck. It takes only a fraction of an inch of displacement on this yoke to really upset things, and the first sign is usually very poor edge convergence.

Finally, you don't have to pay too much attention to the absolute *straightness* of the lines, as long as they do converge. It's pretty difficult to tell when a line is absolutely straight on the hemispherical faceplate of a color tube, anyhow. (And I'd rather have a slightly curved white line than a straight rainbow!)

#### Modify kit VTVM?

*I'm interested in a kit vtvm. Could I modify it to get a 0.5-volt range?—S. K., Union City, N.J.*

*Not recommended! The best way would be to buy one that has a 0.5-volt range! Modifying kits, especially vtvm's, leads to trouble (calibration, mostly). If you get a kit, build it the way the man says in the book. That way, if it doesn't work, you can get it fixed.* R-E

90

RADIO-ELECTRONICS

## NEW! SOLID STATE KITS

FOR ANY  
TAPE RECORDER



### Automatic Recording-Level Control

Low-noise distortionless compressor — preamp easily installs in mike line. Easy-to-build kit with complete instructions.

MODEL ACP-1 KIT . . . \$18.50

### Voice / Sound Actuated Controller

Voice operate any tape recorder, ham and CB transmitter. Ideal for intrusion alarms. Built-in relay switches up to 1 amp. Easy-to-build kit with complete instructions.

MODEL VOX-1 KIT . . . \$18.50

### Other Kits

Audio Amplifiers ■ Power Supplies  
Test Equipment ■ Treasure Locators  
and many others

FREE Data sheets with circuit description, diagram and specifications for all kits.



CARINGELLA ELECTRONICS, Inc.  
P.O. Box 327 ■ Upland, California 91786  
Phone 714-985-1540

Circle 119 on reader's service card

## QUIETROLE

The Original Control  
and  
Switch Lubri-Cleaner

The oldest, most reliable and efficient product obtainable for positive lubrication and cleaning of TV Tuners, Controls and Switches. Harmless to plastics and metals. Zero effects on resistance and capacity. Non-inflammable—non-conductive—non-corrosive.

The Choice of Better  
Servicemen, Everywhere.

For Color and  
Black and White

Available in Aerosol or Bottle

Product of



**QUIETROLE**  
COMPANY

Spartanburg, South Carolina

Circle 120 on reader's service card

## SPOT TV X-RAYS

(continued from page 35)

than a few inches away, as when measuring the field external to a television set.

If improper operation is indicated by the source check or a large change in the zero setting, remove the screen on top of the instrument. If the trouble is that a high reading is obtained, the switches should be opened and closed on the GM tube boards successively until the one producing the malfunction is located. Usually the trouble will be dirt or excessive moisture on the GM tube mounting.

If the malfunction is indicated by a down scale reading or the above procedure has not corrected the condition, turn off all but one switch on the GM mounting boards. Set the range switch to ZERO. Set zero with the control below meter face. Turn switch off and another one on. Set zero with the 100K potentiometer (R14) on the mounting board. Turn this switch off and proceed with the next board, setting zero with the 100K potentiometer. When all units have been set to zero, turn all 6 switches on and, if required, set meter zero with the control below the meter face.

During initial adjustments and calibration in the laboratory, the front-panel zero control is adjusted to produce a potential of between 2.6 and 2.8 volts at point C with all sensors switched off.

It is possible that the instrument will respond to light (especially ultraviolet) or strong electromagnetic fields. Light sensitivity is almost invariably caused by a defective light seal at the base of a GM tube. Recoating the glass seal with a light-tight coat of insulating material, such as a black silicone rubber, will eliminate this type of sensitivity.

If operation without the perforated aluminum cover is required, or if an abnormally strong electromagnetic field is expected, connect integrating capacitor C4 between the base of Q4 and ground on each of the GM tube circuit boards, and add a 0.1- $\mu$ F capacitor between Q7's gate and ground. This does not affect calibration or the time constant.

The instrument described in this article was developed and used by the National Center for Radiological Health to measure X-radiation from about 1200 color TV receivers surveyed in the Washington, D. C., area. RADIO-ELECTRONICS would like to express its appreciation to the NCRH for making this information available so that we could pass it on to our readers. R-E

## Scott's new LR-88 receiver takes the



## out of kit building

Ladies and children needn't leave the room when you build Scott's new LR-88 AM/FM stereo receiver kit. Full-color, full-size assembly drawings guide you through every stage . . . wires are color-coded, pre-cut, pre-stripped . . . and critical sections are completely wired and tested at the factory.

In about 30 goof-proof hours, you'll have completed one great receiver. The LR-88 includes FET front end, Integrated Circuit IF strip, and all the goodies that would cost you over a hundred dollars more if Scott did all the assembling.

Performance? Just check the specs below . . . and write to Scott for your copy of the detailed LR-88 story.

**LR-88 Control Features:** Dual Bass and Treble; Loudness; Balance; Volume compensation; Tape monitor; Mono/stereo control; Noise filter; Interstation muting; Dual speaker switches; Stereo microphone inputs; Front panel headphone output; Input selector; Signal strength meter; Zero-center meter; Stereo threshold control; Remote speaker mono/stereo control; Tuning control; Stereo indicator light. **LR-88 Specifications:** Music-Power rating (IHF), 100 Watts @ 4 Ohms; Usable sensitivity, 2.0  $\mu$ V; Harmonic distortion, 0.6%; Frequency response, 15-25,000 Hz  $\pm$  1.5 dB; Cross modulation rejection, 80 dB; Selectivity, 45 dB; Capture ratio, 2.5 dB; Signal/noise ratio, 65 dB; Price \$334.95 (Recommended Audiophile Net)

## You'll swear by it



## SCOTT®

H. H. Scott, Inc.,  
Dept. 000-00, Maynard, Mass. 01754  
Walnut case optional

© 1968, H. H. Scott, Inc.

Circle 100 on reader's service card

## Have you an ear for music?



Write for Superex specification brochure and reprint of ST-PRO-B review.

Complete with woofers, tweeters, and crossover networks built into each earphone. The experts say "they're something special" and they "deserve to be heard." Once you've heard them you'll agree. Ask your dealer for a demonstration. Approx. \$50

SUPEREX ELECTRONICS CORP. • 1 RADFORD PLACE, YONKERS, N.Y. 10701

Circle 122 on reader's service card

# TUBE TESTER OWNERS

WE HAVE THE LATEST TUBE DATA AND ADAPTERS FOR →

Don't let your tube tester become obsolete

- EICO
- HEATH
- JACKSON
- KNIGHT
- MERCURY
- NRI-CONAR
- PRECISION
- SYLVANIA

CLIP AND MAIL COUPON TODAY

• COLETRONICS SERVICE INC.  
• 1744 Rockaway Ave.,  
• Hewlett, N.Y. 11557

• Please send me information on  
• Model No. \_\_\_\_\_ and Make \_\_\_\_\_

• Name \_\_\_\_\_

• Address \_\_\_\_\_

• City \_\_\_\_\_ State \_\_\_\_\_ Zone \_\_\_\_\_

Circle 123 on reader's service card

## WANT TO SAVE MONEY?

WRITE TODAY FOR

### EDLIE'S

#### FAMOUS MONEY SAVING CATALOGUE

This month's specials:

8" P.M. HI-FI SPEAKER with Whizzer cone. 30 watts 30-20,000 cps full range speaker 8 ohms impedance. \$4.95

12" P.M. HI-FI SPEAKER with Whizzer cone. 50 watts, 30-20,000 cps full range speaker, 8 ohms \$7.50

STUD RECTIFIER. 12 Amps, 150 P.I.V. 28¢ ea., 6 for \$1.55

BRAND NEW 2N307 TRANSISTORS, PNP type, 10 watts TungSol brand. 29¢ ea., 6 for \$1.60

VHF POLICE & FIRE CONVERTER MODULE. Turns your regular AM radio into a receiver to hear Police and Fire Bands. Tunes 30-50 MHz. \$4.95

HIGH GAIN STEREO PRE-AMP, used in conjunction with a car tape recorder. 8 transistors, works off 12V D.C. 2A. Well regulated. Price includes schematic diagram and hook-up instructions. \$2.95

#### TRY OUR FAMOUS PARTS KITS

All one price - only \$1.00 each

- 100 assorted radio knobs
  - 12 assorted crystals (transmitting)
  - 60 assorted disc condensers
  - 5 assorted relays
  - 150 assorted resistors (cut leads but long enough to work with)
  - 100 assorted 1/2W resistors
  - 80 assorted 1W resistors
  - Grab Bag Special—5 lbs. of exciting and exotic electronics parts
  - 5 assorted transformers (some worth \$10, \$12)
- Order Any 5 Kits And Get The 6th FREE!

Terms: send check, money order or cash with order. Include extra for postage. Minimum order, \$2.00.

All prices F.O.B. shipping point.

CATALOGUE FREE! Just Write To:

EDLIE ELECTRONICS, INC.

2700 Hempstead Turnpike Levittown, N.Y. 11756

Circle 124 on reader's service card

## NEW IC's

### PRESSURE-SENSITIVE TRANSISTORS

Pitran PT-2 and PT-3 piezotransistors are silicon npn planar transistors that have their emitter-base junctions mechanically coupled to a diaphragm in the top of a TO-46 can. Pressure applied to the diaphragm causes a reversible change in transistor characteristics and a linear change in output voltage.

Applications include FM oscillators, differential pressure transducers,

PITRAN PT-2 OR PT-3

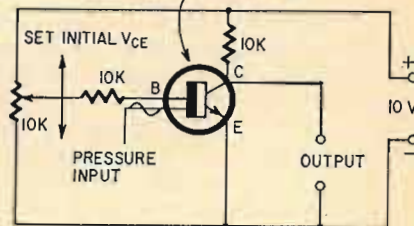

accelerometers, flow gauges, blast gauges and weighing scales. A 3 1/2" differential water pressure or 1/4-gram point force produces 1 volt output. A circuit for linear dc output is shown.

Calibration curves for sensitivity,

# OUTSTANDING VALUES FROM BROOKS

\$1.00 BUYS MORE than PRE-WAR

★★★★

THE PRICES SPEAK FOR THEMSELVES!

FREE \$1 BUY WITH EVERY 10 YOU ORDER

Only applies to "\$1" Buys

FREE GIFT WITH EVERY ORDER

- |  |   |   |  |
|--|---|---|--|
| <input type="checkbox"/> 100-ASST 1/4 WATT RESISTORS stand. choice ohmages, some in 5% \$1 | <input type="checkbox"/> TRANSISTOR RADIO asst type good, bad, broken, as-is, potluck \$1.50  | <input type="checkbox"/> UNIVERSAL MICROPHONE regular/remote/single & dual plug \$3   | <input type="checkbox"/> 8"-ECONOMY "OXFORD SPEAKER" Top quality... 2.15 \$1.69  |
| <input type="checkbox"/> 100-ASST 1/2 WATT RESISTORS stand. choice ohmages, some in 5% \$1 | <input type="checkbox"/> TAPE RECORDER - assorted types good, bad, broken, as-is, potluck \$4 | <input type="checkbox"/> 10 - STANDARD TRANSISTORS NPN & PNP 2N404, 2N414, etc. \$1   | <input type="checkbox"/> 12" OXFORD SPEAKER. Top Quality... Large Magnet... \$4  |
| <input type="checkbox"/> 70 - ASST 1 WATT RESISTORS stand. choice ohmages, some in 5% \$1  | <input type="checkbox"/> 100 - ASST. TUBULAR CONDENSERS .001 to .47 to 600v \$1               | <input type="checkbox"/> 50 - ASST. DISC CERAMIC CONDENSERS popular numbers \$1       | <input type="checkbox"/> UNIVERSAL 4" PM SPEAKER Alnico 5 magnet, quality tone \$79¢   |
| <input type="checkbox"/> 35 - ASST 2 WATT RESISTORS stand. choice ohmages, some in 5% \$1  | <input type="checkbox"/> 50 - TUBE CARTONS (colored) assorted sizes for Popular Tubes \$1     | <input type="checkbox"/> 100 - ASST. MICA CONDENSERS some in 5% \$1                   | <input type="checkbox"/> 100-RESISTORS 1/2W your choice 10, 22, 39, 120, 220, 680Ω 1.5k, 2k, 3.6k, 3.9k, 4.7kΩ, 6.8k, 8.2k, 33k, 220k, 2.2 meg.Ω \$1 |
| <input type="checkbox"/> 50 - PRECISION RESISTORS asst. list-price \$50 less 98% \$1       | <input type="checkbox"/> 3 - TOP BRAND 35W4 TUBES \$1   | <input type="checkbox"/> 2 - POWER TRANSISTORS Replace 2N155, 2N176, 2N301, etc. \$1  | <input type="checkbox"/> 200 - IRC, 22 meg, 1/3W... only \$1   |
| <input type="checkbox"/> 20 - ASSORTED WIREBOUND RESISTORS, 5, 10, 20 watt \$1             | <input type="checkbox"/> 50 - ASSORTED TRANSISTORS big factory scoop-sold as-is \$1           | <input type="checkbox"/> HYTRON POWER TRANSISTOR H.V. replaces DS501, 2N173, etc. \$1 | <input type="checkbox"/> 5 - PNP TRANSISTORS general purpose, TO-5 case \$1  |
| <input type="checkbox"/> 100-MIXED DEAL "JACKPOT" Condensers, Resistors, Surprises \$1     | <input type="checkbox"/> 20 - ASST. DIODE CRYSTALS fine assortment, popular types \$1         | <input type="checkbox"/> 70-BRASS FAHNESTOCK CLIPS popular type & size \$1            | <input type="checkbox"/> 5 - NPN TRANSISTORS general purpose, TO-5 case \$1  |
| <input type="checkbox"/> 4 - TOGGLE SWITCHES SPST, SPDT, DPST, DPDT \$1                    | <input type="checkbox"/> 20 - ASST. VOLUME CONTROLS All desirable good types \$1              | <input type="checkbox"/> 10 - SPEAKER PLUG SETS deluxe type, 2 conductor \$1          | <input type="checkbox"/> 10 - G.E. SAPPHIRE NEEDLES 4G, VR-11, etc. (\$25.00 value) \$1  |
| <input type="checkbox"/> 10-ASSORTED SLIDE SWITCHES SPST, SPDT, DPDT, etc. \$1             | <input type="checkbox"/> 100 - RADIO & TV SOCKETS Asst. - too numerous to mention \$1         | <input type="checkbox"/> 10 SETS - DELUXE PLUGS & JACKS asst. for many purposes \$1   | <input type="checkbox"/> 10 - STANDARD TRANSISTORS NPN & PNP 2N404, 2N414, etc. \$1  |
| <input type="checkbox"/> 20 - EXPERIMENTER'S COIL "JACKPOT" assorted for 101 uses \$1      | <input type="checkbox"/> JUMBO POWER TRANSFORMER if you don't mind the weight \$1             | <input type="checkbox"/> 10 - SETS PHONO PLUGS & PIN JACKS RCA type \$1               | <input type="checkbox"/> 10-ASSORTED DIODE CRYSTALS 1N34, 1N48, 1N60, 1N64, etc. \$1   |
| <input type="checkbox"/> 7 - TV ELECTROLYTIC CONDENSERS desirable types \$1                | <input type="checkbox"/> MOTOROLA PWR TRANSFORM 110v, CT 150/150v, 6.3v \$1                   | <input type="checkbox"/> 10 - SURE-GRIP ALLIGATOR CLIPS 2" plated \$1                 | <input type="checkbox"/> HEARING AID AMPLIFIER incl. 3 Tubes, Mike, etc. (as is) \$2   |
| <input type="checkbox"/> 15 - ASST. ROTARY SWITCHES all popular types \$20 value \$1       | <input type="checkbox"/> 10 - TRANSFORMERS assorted Audio Outputs, Chokes, I, F, 's, etc. \$1 | <input type="checkbox"/> 50 - ASSORTED PRINTED CIRCUIT SOCKETS best types \$1         | <input type="checkbox"/> 5 - 6' ELECTRIC LINE CORDS with plug standard brands \$1  |
| <input type="checkbox"/> CRYSTAL LAPEL MICROPHONE high impedance, 200-6000 cps \$59        | <input type="checkbox"/> 5 POUNDS ELECTRONIC PARTS Fine asst. too numerous to mention \$1     | <input type="checkbox"/> 100 - STRIPS ASSORTED SPAGHETTI handy sizes \$1              | <input type="checkbox"/> 4 - TV CHEATER CORDS with both plugs \$1  |
|  | <input type="checkbox"/> 7 - TV ELECTROLYTIC CONDENSERS desirable types \$1                   |   | <input type="checkbox"/> 32' - TEST PROD WIRE deluxe quality, red or black \$1   |
|  |   |   | <input type="checkbox"/> 150' - BUSS WIRE #20 tinned for hookups, special circuits, etc. \$1   |

IMMEDIATE DELIVERY... Scientific light packing for safe delivery at minimum cost. HANDY WAY TO ORDER: Pencil mark or write amounts wanted in each box, place letter F in box for Free \$1 BUY. Enclose with check or money order, add extra for shipping. Tearsheets will be returned as packing slips in your order, plus lists of new offers.

Name .....  
Address .....  
.....  
Cost of goods .....  
Shipping estimated .....  
TOTAL

Please specify refund on shipping overpayment desired:  CHECK  POSTAGE STAMPS  MERCHANDISE (our choice) with advantage to customer

**BROOKS RADIO & TV CORP., 487 Columbus Ave., New York, N. Y. 10024**

212-874 5600  
TELEPHONE



# SEMICONDUCTORS

temperature coefficient and over-all performance are supplied with each unit. The PT-2 and PT-3 cost \$75 and \$125, respectively, in lots of 1 to 99. The units are made by Stow Laboratories, Stow, Mass. 01775.

## VOLTAGE-REFERENCE AMPLIFIER

The DRAE 11.7B is a series of composite circuits designed as combination voltage references and error amplifiers for use in regulated power supplies. Each reference amplifier consists of an npn silicon transistor and a silicon voltage regulator diode having equal but opposite temperature coefficients. Temperature differential between elements is held to a minimum to permit reliable operation over a wide range of temperatures.

The basic type number (DRAE 11.7B) of this 11.7-volt reference amplifier is followed by the suffix 10, 25, 50 or 100, indicating the temperature coefficient in parts per million. Case outline, base diagram and schematic of this series are shown. Further information is available from Dickson Electronics Corp., PO Box 1390, Scottsdale, Ariz. 85252. R-E

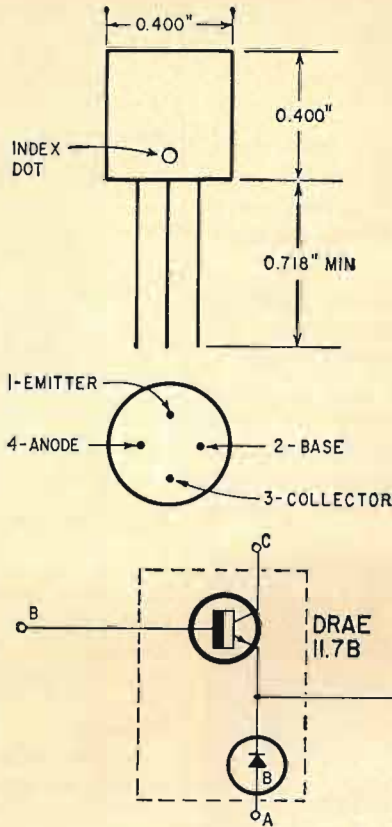



**FREE**

Fill in coupon for a **FREE** One Year Subscription to **OLSON ELECTRONICS'** Fantastic Value Packed Catalog—Unheard of **LOW, LOW PRICES** on Brand Name Speakers, Changers, Tubes, Tools, Stereo Amps, Tuners, CB, Hi-Fi's, and thousands of other Electronic Values. Credit plan available.

NAME \_\_\_\_\_  
 ADDRESS \_\_\_\_\_  
 CITY \_\_\_\_\_ STATE \_\_\_\_\_  
 GIVE ZIP CODE \_\_\_\_\_

If you have a friend interested in electronics send his name and address for a **FREE** subscription also.

**OLSON ELECTRONICS**  
 990 S. Forge Street Akron, Ohio 44308

Circle 125 on reader's service card

**CANADIANS: Ordering is easy . . . we do the paperwork . . . try a small order**

### MYLAR RECORDING TAPE

2 1/2" - 225' . . . \$ .15	7" - 2400' . . . . . \$1.59
3" - 225' . . . . . 17	7" - 3600' . . . . . 2.78
3" - 300' . . . . . 24	CASSETTE 60 minutes 1.00
3 1/4" - 600' . . . . . 49	CASSETTE 90 minutes 1.86
5" - 600' . . . . . 52	CASSETTE 120 minutes 2.49
5" - 900' . . . . . 67	
5" - 1200' . . . . . 86	2 1/2" TAPE REEL . . . . . 04
5" - 1800' . . . . . 1.29	3" TAPE REEL . . . . . 05
7" - 1200' . . . . . 69	3 1/4" TAPE REEL . . . . . 06
7" - 1800' . . . . . 99	5" TAPE REEL . . . . . 12
	7" TAPE REEL . . . . . 14

### HIGHWAVE AM-FM PORTABLE RADIO



Elegance in Ebony & Chrome  
 14 Transistors—A Powerhouse of Quality Reception with AFC Operates on 4 "C" Cells  
 22" Telescoping FM Antenna & Personal listening attachment  
 Money refund — if not better than any Known Brand selling for even twice the price  
 8"X5 1/4"X2 1/4"—4 lbs  
**COMPLETE . . . \$19.50**



**IBM COMPUTER SECTIONS**  
 8 assorted Units we sell for \$1 are loaded with over 150 valuable parts.  
 Incl. — Transistors, Condensers, Resistors, Heat Sinks, Diodes, Etc.  
**8 for \$1**  
**100 for \$10**

- RECORDING TAPE SPLICER \$1.49 handy, accurate, compact . . . . .
- 300 - ASSORTED HEX NUTS \$1 2/56, 4/40, 5/40, 6/32, 8/32 . . . . .
- 250 - ASST. SOLDERING LUGS \$1 best types and sizes . . . . .
- 250 - ASST. WOOD SCREWS \$1 finest popular selection . . . . .
- 250 - ASST. SELF TAPPING SCREWS #6, #8, etc. . . . .
- 150 - ASST. 6/32 CREWS and 150 6/32 HEX NUTS . . . . .
- 150 - ASST. 8/32 SCREWS and 150-8/32 HEX NUTS . . . . .
- 150 - ASST. 2/56 SCREWS and 150-2/56 HEX NUTS . . . . .
- 150 - ASST. 4/40 SCREWS and 150-4/40 HEX NUTS . . . . .
- 150 - ASST. 5/40 SCREWS and 150-5/40 HEX NUTS . . . . .
- 500 - ASSORTED RIVETS \$1 most useful selected sizes . . . . .
- 500 - ASSORTED WASHERS \$1 most useful selected sizes . . . . .
- 100 - ASST. RUBBER BUMPERS \$1 for cabinet bottoms & other uses . . . . .
- 100 - ASSORTED RUBBER GROM-METS best sizes . . . . .

**RCA 110° FLYBACK TRANSFORMER**



We scooped the Market Latest type — standard for all 110° TV's  
 RCA's design of large Coil produces 15KV— Assuring adequate width Incl. Schematic Diagram application for any TV  
 List price \$13.90  
 Your price . . . \$3  
 10% off in lots of 3

- 110° TV DEFLECTION YOKE \$3 for all types TV's incl schematic . . . . .
- "COMBINATION SPECIAL" RCA 110° FLYBACK plus 110° DEFLECTION YOKE \$5
- 90° FLYBACK TRANSFORMER \$2 for all type TV's incl schematic . . . . .
- 90° TV DEFLECTION YOKE \$2 for all type TV's incl schematic . . . . .
- 70° FLYBACK TRANSFORMER \$2 for all type TV's incl schematic . . . . .
- 70° TV DEFLECTION YOKE \$2 for all type TV's incl schematic . . . . .
- 20 - ASSORTED TV COILS \$1 I.P. video, sound, radio, etc. . . . .
- 100' - TV TWIN LEAD-IN WIRE \$1 300 ohm, deluxe lead-in, clear . . . . .

- 50 - ASST. TERMINAL STRIPS \$1 all types, 1-lug to 6-lug . . . . .
- 25 - INSTRUMENT POINTER KNOBS selected popular types . . . . .
- 3 - CO-AX CONNECTORS \$1 50-239 . . . . .
- 2 - CO-AX CONNECTORS \$1 PL-259 . . . . .
- BONANZA "JACKPOT" not gold, not oil, but a wealth of Electronic Items—Money-Back-guarantee . . . . .
- 2-G.E. PIECES OF EQUIPMENT \$1 stacked with over 200 useful parts . . . . .
- 15 - G.E. #NE-2 TUBES \$1 Neon Glow Lamp for 101 uses . . . . .
- 20 - ASST. PILOT LIGHTS \$1 #44, 46, 47, 51, etc. . . . .
- 50 - ASSORTED #3AG FUSES \$1 popular ampere ratings . . . . .
- WIRE "JACKPOT" good variety \$1 . . . . .
- 4 - 50' HANKS HOOK-UP WIRE \$1 assorted colors . . . . .
- 100' - SPOOL SPEAKER WIRE \$1 2 cond, mini zip, clear, 101 uses . . . . .
- \$15.00 TELEVISION PARTS \$1 "JACKPOT" best buy ever . . . . .
- 40 - ASSORTED TV KNOBS \$1 all standard types, \$20 value . . . . .

- 1 - LB SPOOL ROSIN-CORE \$1 SOLDER 40/60 top quality . . . . .
- 100 - ASST. RADIO KNOBS \$1 all selected popular types . . . . .
- 50 - TUBULAR CONDENSERS \$1 asst. .001 to .17—400v to 1000v . . . . .
- 3-ELECTROLYTIC CONDENSERS \$1 most popular number 50/30—150v . . . . .
- 5 - I.F. COIL TRANSFORMERS \$1 sub-min for Transistor Radios . . . . .
- 5 - AUDIO OUTPUT TRANS-FORM Sub-min for Trans Radios . . . . .
- 32' - TEST PROD WIRE \$1 deluxe quality, red or black . . . . .
- CLEAN UP THE KITCHEN "JACK-POT" Big Deal \$1 only one to a customer . . . . .
- TV TUNERS asst. all new standard makes, including Tubes \$3 . . . . .
- TV TUNERS VHF/UHF all new standard makes, including Tubes \$4 . . . . .
- 5 - PNP TRANSISTORS \$1 general purpose, TO-5 case . . . . .
- 5 - NPN TRANSISTORS \$1 general purpose, TO-5 case . . . . .
- 50 - ASSORTED MYLAR CONDENSERS popular selected types . . . . .
- 3 - TOP BRAND SILICON RECTIFIERS 1 amp, 1000 PIV \$1 . . . . .
- 10 - ASSORTED TUBES \$1 Radio, Television and Industrial . . . . .
- 25' - MICROPHONE CABLE \$1 deluxe, 2 conductor, shielded . . . . .

# Why is a Vectorscope essential for Color TV servicing?

- 1 Check and align demodulators to any angle . . . 90°, 105°, 115° . . . accurately and quickly. No guesswork. New color sets no longer demodulate at 90°. Only with a Vectorscope can these odd angles be determined for those hard-to-get skin tones.
- 2 Check and align bandpass-amplifier circuits. Eliminate weak color and smeared color with proper alignment. No other equipment required. Only a V7 Vectorscope does this.
- 3 Pinpoint troubles to a specific color circuit. Each stage in a TV set contributes a definite characteristic to the vector pattern. An improper vector pattern localizes the trouble to the particular circuit affecting either vector amplitude, vector angle or vector shape. Only a V7 Vectorscope does this.



## EXCLUSIVE FEATURES:

**Color Vectorscope:** Until now, available only in \$1500 testers designed for broadcast use. Accurately measures color demodulation to check R-Y and B-Y, for color phase and amplitude. A must for total color and those hard-to-get skin tones. **Self-Calibrating.** Adjust timing circuit without external test equipment. **Dial-A-Line.** Adjust horizontal line to any width from 1-4 lines. **Solid State Reliability** in timer and signal circuits. **Plus:** All Crosshatch, Dots, Vertical only, Horizontal only and Keyed Rainbow Patterns. RF at channels 3, 4 or 5. Video Output (Pos. and Neg. adjustable) for signal injection trouble-shooting. **Red-Blue-Green Gun Killer.** All transistor and timer circuits are voltage-regulated to operate under wide line voltage ranges. Lightweight, compact—only 8¼x7½x12½". **NET 189.50**

**ONE YEAR WARRANTY**

**V6-B** New, improved complete color bar generator with all the features of the V7 except the Vectorscope. Only **99.50**

For the full story, see your distributor or write for literature.

Dept. RE-11

**LECTROTECH, INC.**

1221 W. Devon Ave., Chicago, Ill. 60626

Circle 127 on reader's service card

## BUILD A \$10 READOUT MODULE

(continued from page 69)

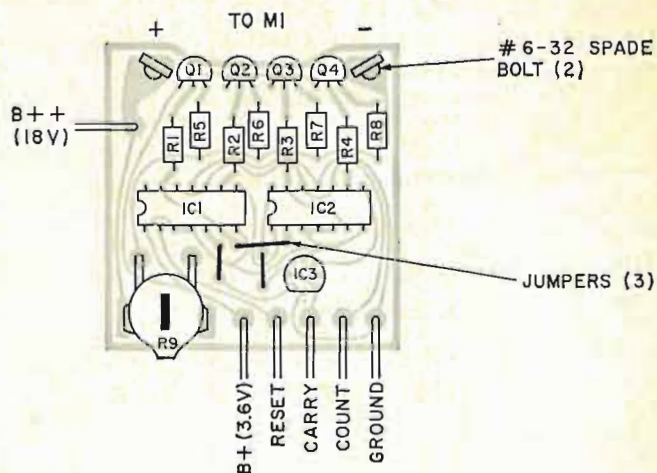

Fig. 13—Component placement and input connections.

component layout is in Fig. 13. IC1 and IC2 go in with their code notch in the direction shown, while the flat side identifies IC3. Two No. 6 spade bolts secure the circuit card to the meter, giving you a rugged, one-piece assembly.

## Testing

You can test your unit with two D-cells and a 22½ V battery, connected as in Fig. 14. Build up the bounceless pushbutton circuit shown for the input. To calibrate the unit (temporarily, of course, since you'll later be switching to a regulated meter supply), RESET the counter and run the count up to 9. Now adjust R9 to set the pointer precisely to 9. Your counter is complete, and you should be all set to build any of a number of digital instruments at a tiny fraction of their normal cost. **R-E**

Fig. 14—Test setup for the module uses battery supply for 22.5V and 3.6V. Input (temporary) uses pushbutton circuit.

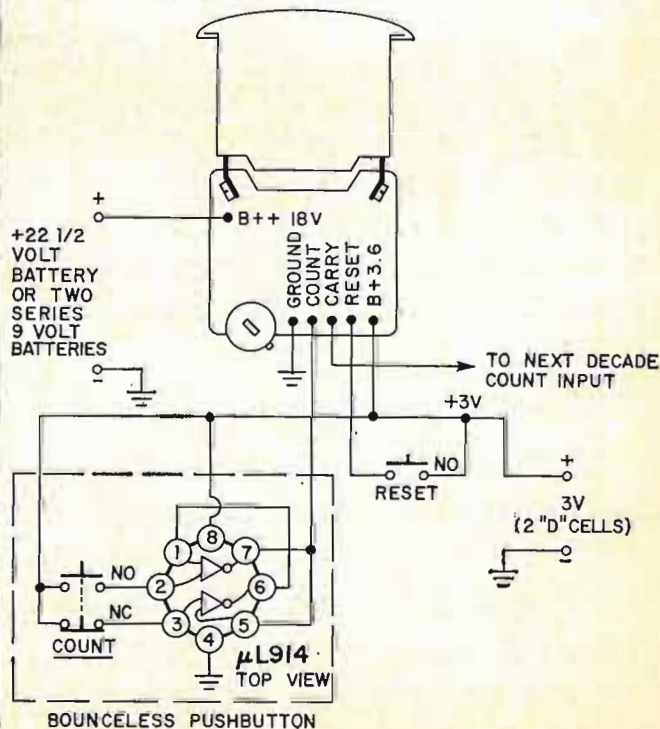

# COMING NEXT MONTH

## SPECIAL SECTION ON CAREERS IN ELECTRONICS

Three major features and a career "round-up" let you know what's happening:

- *What an electronic tester should know.*
- *Computer programming: how to talk with a computer*
- *Growing opportunities in electronic organ servicing*
- *Starting a career in electronics*

### BUILD DIGITAL INSTRUMENTS

Use the \$10 Experimenter's IC readout module described in November to build a digital voltmeter, frequency counter and more fascinating devices

### AUTOMATIC STEREO SLIDE SHOW

Here's how to sync your tape recorder with a slide projector. Inaudible signals trigger the slides; lets you program stereo music.

### ABC's OF TRANSISTORS

Here's the first of a six-part series to help you learn how transistors work and how to fix solid-state circuits. Each article complete in itself.

### PLUS THESE FEATURES:

- *Build a stereo headphone amplifier*
- *How to fix solid-state TV circuits*
- *Build a dc-to-ac inverter*

## December Radio-Electronics

### AIRCRAFT WEATHER RECEIVER

(continued from page 43)

long antenna, preferably 50' or longer, to the unit. If you have aligned everything with reasonable accuracy on the signal generator, you should hear the desired weather signals. Complete the alignment by peaking all the coils, using the signal itself.

You are now ready to install the unit in the car. The antenna used should be as long as possible. However, the unit will work well on a 48" broadcast-band auto antenna. While an arrangement could probably be worked out to switch the regular car radio antenna from the AM radio to the weather tuner, such arrangements tend to be cumbersome and inconvenient. I mounted a separate 48" auto antenna on the rear fender and fished the lead in through the trunk to the tuner. This works fine.

Note that whatever type of antenna you use, the unit must be grounded to the car body, either through the shield on the antenna lead or by running a length of wire from the unit to a screw or other metal part that contacts the body.

Enclose the tuner, audio system and batteries in a box or cabinet of your choice, with a switch to turn things off and on. (You'll need a double-pole switch to handle the separate power sources for the tuner and amplifier.)

One more note: When you install the unit in the car, readjust the slug in the antenna coil for maximum signal. The adjustment of this slug will vary with different lengths of antennas. It *must* be "peaked" whenever a different antenna is used, or sensitivity will be seriously degraded. **R.E.**

## NEW COAX WALL TAPS

For UHF/VHF  
Color/B&W TV



Designed for ease of installation... Mosley provides the new MC Series of solderless Wall Taps to meet all your 75 ohm coax lead-in requirements - from the single lead-in outlet to the more complex multi-unit distribution system.



Write Dept. 158A for FREE detailed brochure.

**Mosley Electronics, Inc.** 4610 N. Lindbergh Blvd.,  
Bridgeton Missouri 63042

Circle 128 on reader's service card

## VARIABLE TRANSFORMER—NEW—\$14.95 ea.



NEW 10 amp. Regular \$43.00

- (a) Adjust-A-Volt type 8159, brand new, for panel mount (less enclosed housing & dial). Adjustable 0-140 volts Input 120 V. .... \$14.95 ea.
- (b) Same as above with enclosure & dial for bench use \$19.95 ea.
- (c) Ganged type of 3 with enclosure and dial for 220 V. 3 phase service or parallel for 30 amp. 110 V. service \$39.50 ea.

## SURPLUS SATELLITE BATTERIES—97¢ ea.

6 amp/hr.  
(Govtmt. Cost \$11.40 ea.)



These Government surplus storage battery cells are nickel-cadmium sintered plate type used in satellites and missiles due to characteristics not possessed by any other battery, i.e.: Lifetime service, constant voltage during discharge, extreme temperature ranges, discharges in any position, compact, high discharge rates, no corrosive fumes, not harmed by storage, overcharging and freezing. Cells are 1.25 V. each. Combine these cells in series to required voltage for replacement of any battery-operated equipment (within discharge limits—150 amps on this cell), using dry or storage batteries where portability, dependability, constant voltage, high current drains, and ruggedness are requisites. Size 4 1/4" H. x 2 5/8" W. x 1 1/16" T. Wt. per cell 1/2 lb.

- Used, as received from Govtmt. .... \$ .97 ea.
  - Used, checked for cracks & electrolyte restored .. \$1.49 ea.
  - Brand new cells ..... \$2.95 ea.
- Include postage with order.

We have other cells of greater Amp. Hr. capacities for motor starting, etc. in stock. Send for free list.

**GUARANTEE:** All checked & new cells are guaranteed or your money back.

## RECEIVER-TRANSMITTER RT-11A/APN-12



160-230 Mc. with vernier tuning of osc. Turret 8 channel tuner motor driven with nice gear head type motor. With following tubes: 2C26A, 5R4GY, 2X2, 8-6AC7, 2-6SL7GT, 2-6AK5, 9002, 6E5, and 6H6. (tubes alone worth more than our price). Also has small squirrel cage blower and other parts. Used. Ship. wt. approx. 60 lbs. Size 11 3/4" x 12 1/4" x 12". Used ..... \$7.95

Send for free pamphlet

**ESSE RADIO CO.**

368 S. Meridian St. Indianapolis, Ind. 46225  
Dept. RE4

# NOTEWORTHY CIRCUIT

## A NOVEL SQUELCH CIRCUIT

The performance of most squelch circuits is unsatisfactory when the sensitivity controls are adjusted to open the squelch at low signal levels. Noise and random signals break through frequently enough to be distracting. Many circuits cause distortion when the desired incoming signal is just strong enough to open the squelch. This squelch circuit is simpler than, and outperforms, any other circuits I have tried.

When no signal is coming in, the first i.f. amplifier screen current is high, producing a large drop across the SQUELCH CONTROL. The screen voltage is therefore too low to fire the neon lamp. This means that the photoconductive cell (enclosed in a light-tight box with the NE2) will have such a high resistance that any audio signal reaching the first af amplifier grid will be negligible.

As soon as a signal of sufficient

strength—determined by the SQUELCH CONTROL setting—is received, avc action causes the i.f. amplifier screen voltage to rise and fire the neon lamp. The photocell resistance drops sharply and full audio voltage reaches the af amplifier grid. Because the photocell is a bilateral device, there is no possibility of distortion being produced by rectification.

Action is as fast as the avc time constant will allow. There is no noticeable audio leakthrough in the off condition. I used a Sylvania CAK 8100 CdS photocell with resistance below 5000 ohms at 2 foot-candles and a minimum dark resistance of 200,000 ohms. Other similar cells can be used.

Be sure that the photocell is fully shielded from stray light. Potting the NE2 and photocell in an opaque epoxy works nicely. Keep the lamp-photocell module out of 60-Hz fields or install shielding.—James K. Cockrell **R-E**

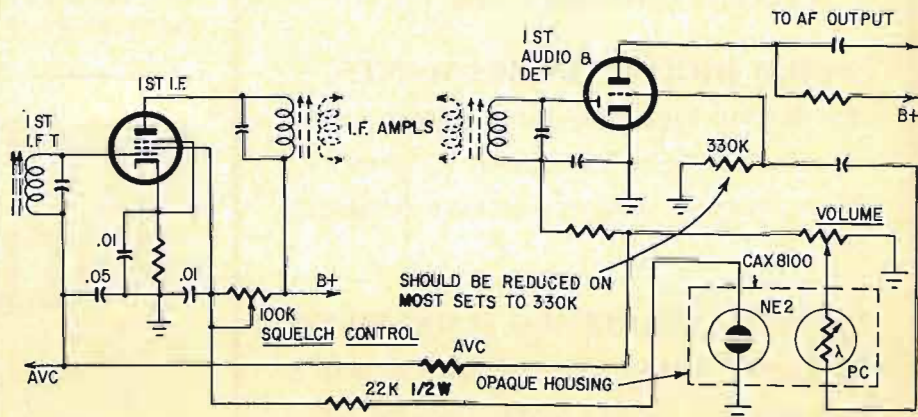

## The First Really New INDOOR ANTENNAS!

Now, at last, your customers have a reason to get rid of their tired old droopy rabbit ears. The Gavin series of monitor antennas not only look better, they work better too.

### Check these quality features:

- TOWER DESIGN GETS UP WHERE THE SIGNAL IS FOR EXTRA POWER.
- GUARANTEED TO GIVE YOUR CUSTOMERS BETTER RECEPTION OR MONEY REFUNDED.
- ROTATING SCANNER—You can aim for best pictures without turning base. No danger of scratching furniture.
- HIGH IMPACT PLASTIC CASE WITH DEEP FELT PAD.
- UHF/VHF FUNCTION SWITCH AND PHASING SWITCH.

For more details, contact your GAVIN representative today, or call:



**GAVIN INSTRUMENTS, INC.**  
Subsidiary of ADVANCE ROSS CORP.  
Somerville, New Jersey 08876, U.S.A.  
Telephone: (201) 356-3500

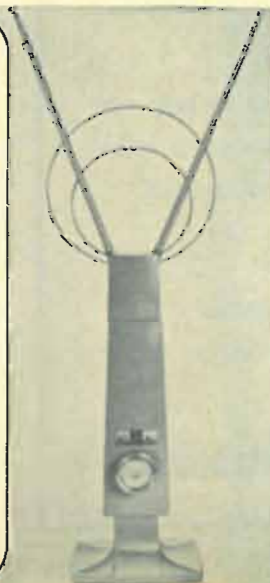

## HELP WANTED

Have you developed a time-saving tool, gadget or procedure to use at your workbench, a new and interesting circuit or circuit application or a solution to a servicing problem? If so, write it up and send it to us.

RADIO-ELECTRONICS pays \$5.00 for acceptable *Technote* and *Try This One* items. We pay an additional \$4.00 for diagrams or sketches and \$7.00 for usable photographs. *Noteworthy Circuits* bring \$10.00 each with an additional \$7.00 for photographs.

# NEW BOOKS

**INTEGRATED CIRCUITS, FUNDAMENTALS & PROJECTS**, by Rufus P. Turner, Ph.D. *Allied Radio Corp., Chicago, Ill. 60680. 5½" x 8½", 96 pp. Paperback, \$7.75*

A basic introduction to IC's for hobbyists and experimenters. First two chapters cover IC construction, circuit use and construction-project tips. Remaining six chapters are complete IC construction projects that include three amplifiers, a crystal oscillator, signal tracer and voltmeter.

**MODERN ELECTRONIC TROUBLESHOOTING**, by the editors, *Electronic Technician/Dealer. Tab Books, Blue Ridge Summit, Pa. 17214. 256 pp. Hardbound, \$7.95; Paper, \$4.95*

Content is divided into five sections. First four cover solid state circuits (radio, TV, hi fi and communication gear), color TV circuits, FM stereo and hi fi, and two-way radio equipment. Final section covers test equipment. Text stresses common troubles and practical repair procedures.

**VOLTAGE AND POWER AMPLIFIERS**, by Robert E. Sentz. *Holt, Rinehart & Winston, Inc., 383 Madison Ave., New York, N.Y. 10017. 6" x 9", 282 pp. Paperback, \$3.95*

This is one volume of an electronics technology series for junior colleges. Emphasis is on solid state, but vacuum-tube circuits are covered. Treatment is extensively mathematical.

**HI-FI LOUDSPEAKERS AND ENCLOSURES**, 2nd edition, by Abraham Cohen. *Hayden Book Co., Inc., 116 W. 14 St., New York, N.Y. 10011. 5¾" x 8¼", 438 pp. Cloth, \$7.98; paperback, \$5.95*

Updated edition covers innovations in loudspeaker design since 1965, including three-element stereo and all-in-one enclosures. Also, an added chapter details terms used in acoustic measurements and their derivation. A comprehensive work covering speaker and enclosure design that includes basic construction details for 27 enclosures.

**TRANSISTOR SUBSTITUTION HANDBOOK**, 8th edition. *Howard W. Sams & Co., Inc., 4300 W. 62 St., Indianapolis, Ind., 46206. 5½" x 8½", 144 pp. Softcover, \$1.95*

This edition has 1000 new substitutions. Includes basing diagrams and polarity indications for US and foreign home-entertainment, industrial and military transistors. All types are in a single numerical alphabetical listing.

**VHF-FM MARINE RADIO**, by Leo G. Sands and G. Geoffrey Tellet. *Chilton Book Co., 401 Walnut St., Philadelphia, Pa. 19106. 5¾" x 8", 330 pp. Hardbound, \$7.95; paper, \$6.50*

Information on the selection and operation of equipment, licensing pro-

cedures, FCC rules and regulations. About one half of the book contains detailed lists of public and limited coast stations, marine and telephone service channels, and radio common-carrier stations.

**MODERN TV CIRCUIT & WAVEFORM ANALYSIS**, by Stan Prentiss. *Tab Books, Blue Ridge Summit, Pa. 17214. 256 pp. Hardbound, \$7.95; paper, \$4.95*

Stresses use of triggered scope to trace TV circuit problems. Some 100 scope waveforms are included showing malfunctions in major TV circuits. Final chapter discusses solid-state troubleshooting techniques.

**RCA SOLID-STATE HOBBY CIRCUITS MANUAL**. *RCA Electronic Components, Harrison, N.J. 07029. 8¾" x 5¾", 224 pp. Paperback, \$1.75*

Early sections describe semiconductor theory and operation, basic circuits, tips on construction, testing and troubleshooting. Also has complete construction information for 35 projects for radio hams, motorists, photographers, home owners, etc. **R-E**

# SCHOOL DIRECTORY

## GET INTO ELECTRONICS

V.T.I. training leads to success as technicians, field engineers, specialists in communications, guided missiles, computers, radar and automation. Basic & advanced courses in theory & laboratory. Electronic Engineering Technology & Electronic Technology curricula both available. Associate degree in 29 mos. B.S. also obtainable. G.I. approved. Graduates in all branches of electronics with major companies. Start Feb., Sept. Dorms, campus. High school graduate or equivalent. Catalog.

**VALPARAISO TECHNICAL INSTITUTE**  
Dept. C, Valparaiso, Indiana 46389



## A New Way To Study At Home ENGINEERING MATHEMATICS

Get all the math you need for electronic engineering from I.I.S.I. Two great new courses for the man who wants to get ahead. (taught by college professors). Study at home as fast as you want. No classes to hold you back. No contract to sign. Every lesson comes with A MONEY BACK GUARANTEE. Get the information today—Free!

**THE INDIANA HOME STUDY INSTITUTE**  
Dept. R P.O. Box 1189 Panama City, Fla. 32401

## distinguished graduates

hold important engineering and business administration posts throughout U.S. Professionally-oriented college with outstanding placement record. Four-quarter year permits degree in three years. Fine faculty. Modern labs. Small classes. 300-acre campus. Accredited. Approved for vets. Modest costs. Enter Jan., March, June, Sept. For Catalog, write Adm. Director.

**TRI-STATE COLLEGE**  
24118 College Avenue, Angola, Indiana 46703

### U.S. GOV'T ELECTRONIC SURPLUS

- Nationally Known-World Famous SURPLUS CENTER offers finest, most expensive, Government Surplus electronic units and components at a fraction of their original acquisition cost.

ORDER DIRECT FROM AD or WRITE FOR CATALOGS

#### STANDARD DIAL TELEPHONE

- (ITEM #715) - Standard, commercial telephone same as used throughout U.S.A. Attractive polished black, like new condition. Use as extension phone in private systems or connect several phones together for local intercom system. Full instructions are furnished. Wt. 9 lbs. Original Cost \$24.50. **F.O.B. \$7.50**

#### STEP-BY-STEP AUTOMATIC SWITCH

- (ITEM #738) - Amazing "up-and-around" electro-magnetic telephone switch. Dial any bank pair from 1 to 100. Make your own telephone system. Can also be used to remotely control up to 100 circuits over a single pair of wires.
- One of our FOUR STAR bargains. Comes complete with dial, one dial and one line bank. Size, 3" x 7" x 12". Wt. 16 lbs. Cost Gov't Over \$75.00. Complete: Switch, cover..... **F.O.B. \$9.95**

#### TYPICAL BUYS FROM OUR 1968 CATALOGS

- \$ 350.00 - Geared 2-hp Battery Golf Car Motor ..... **\$26.95**
- \$ 15.00 - Westinghouse DC Ammeter, 0 to 300 ..... **\$ 7.11**
- \$ 40.00 - Vacuum/Pressure Pump, 12-VDC ..... **\$11.95**
- - - 80-MW Walkie-Talkies, Per Pair ..... **\$19.60**
- - - Deluxe, Multi-Range, AC/DC Tester ..... **\$ 8.98**

#### SPECIAL SALE

##### Correspondence Course In ELECTRICAL ENGINEERING

Sells For \$10.79 Outside U.S.A. **\$8.79** Postpaid in U.S.A.

- (ITEM #A181) - Wonderful chance to obtain technical training at Amazing Low Cost! Lincoln Engineering School has suspended its Correspondence Courses because of increased operating costs. We offer a limited number of the school's complete Electrical Engineering Course but without the examination paper grading service. The course consists of 14 lesson unit books. Each book has the regular exams, and in a separate section, "Standard Answers" to each exam question.
- Course is well written, easy to understand, profusely illustrated. Reader's Digest size, easy to carry and study in spare time. Many Lincoln Engineering School students holding excellent jobs as a result of L.E.S. training. Course contains latest information on transistors, silicon diodes, etc. Additional book on how to build and operate a "Home Laboratory and Experimental Bench" furnished with each course.

Send 25¢ Coin Or Stamps For Catalogs  
All Items FOB Lincoln Money Back Guarantee

### SURPLUS CENTER

DEPT. RE-118 LINCOLN, NEBR. 68501

**More and More Servicemen Say: 'We've tried cheaper substitutes... now WE'RE BACK TO DEPENDABLE, RELIABLE "NO NOISE"'**

World's No. 1 TRUSTED NAME BRAND

- VOLUME CONTROL & CONTACT RESTORER
- TUNER-TONIC with PERMA-FILM
- EC-44 FOR ELECTRICAL CONTACTS
- TAPE-RECO HEAD CLEANER
- FRIGID-AIR CIRCUIT COOLER

All Guaranteed Non-Flammable, No Carbon Tet, Non-Toxic, Non-Drift Tuner Cleaner And Guaranteed Not To Affect Plastics.

The Only Brand Perfect For Color TV and Black & White

FREE extender assembly for pinpoint application supplied with ALL NO-NOISE PRODUCTS.

**Electronic Chemical Corp.**  
813 Communipaw Ave. / Jersey City, N. J. 07304

# MARKET CENTER

## GENERAL

**TREASURE HUNTERS! PROSPECTORS!** Relco's new instruments detect buried gold, silver, coins. Kits, assembled models. Transistorized. Weighs 3 pounds. \$19.95 up. Free catalog. RELCO-A25, Box 10839, Houston, Texas 77018

## AC POWER FROM YOUR CAR OR BOAT BATTERY

Standard home electricity (60 cycle, 117 volts) for small appliances, record players, tape recorders, tools, etc.

Inverters from 25 to 600 watts, priced as low as \$15.95.

See your Electronics Parts Dealer, or write



**terado CORPORATION**  
1053 Raymond Ave., St. Paul, Minn. 55108

## "ARCTURUS" SALE

- Tube cartons 6AU6 etc. size. \$2.15 per 100. 6SN7 etc. size. \$2.55 per 100. 5U4GB size. \$2.95 per 100. 5U4G size. .03¢ each.

- 7" 90° TV bench test picture tube with adapter. No ion trap needed. Cat. #78P7. \$7.99.

- Silicon rectifier, octal-based replacement for 5U4, 5V3, 5AS4, 5AW4, 5T4, 5V4, 5Z4. With diagram. Cat. #Rect 1. 99¢ each.

- 5 transistor circuit boards containing up to 6 transistors, plus diodes, resistors, capacitors, etc. Cat. #TB10, 99¢.

- Kit of 30 tested germanium diodes. Cat. #100, 99¢.

- RCA-110° flyback transformer, latest type. Includes schematic diagram applicable to any TV. Cat. #BR-1, \$2.99.

- Color yokes. 70° for all round color CRT's. Cat. #XRC70, \$12.95. 90° for all rectangular 19 to 25" color CRT's. Cat. #XRC90, \$12.95.

- Transistorized U.H.F. tuners used in 1965 to 1967 TV sets made by Admiral, RCA, Motorola, etc. Removable gearing may vary from one make to another. Need only 12 volts d.c. to function. No filament voltage needed. Easy replacement units. Cat. #U.H.F.567. \$4.95.

- U.H.F. Tuner-original units as used in TV sets such as RCA, Admiral, etc. covering channels 14 through 82, as part #94D178-2. Complete with tube. Drive gearing is removable. Can be used in most sets. Cat. #U.H.F. 3—\$4.95.

- F.M. tuner-Hi/Fi amplifier tuning unit. Tuners from 88 to 108 mc. Contains two 10.7 Mc. I.F. transformers, one 10.7 sound discriminator, R.F. oscillator and mixer stages and 12DT8 tube. I.F.'s are standard "K" type. Circuit diagram for building F.M. radio is included. Also plan for building F.M. tuner. Sam's photofact #620 shows 2 applications. 1 for radio, 1 for Hi-Fidelity tuner and amplifier. Cat. #FM-20. \$4.95.

Send for our free catalog listing thousands of similar best buys in tubes, parts, kits, transistors, rectifiers, etc. Orders under \$5.00—\$1.00 handling charge. Include 4% of dollar value of order for postage. Canadian postage \$1.00 extra.

**ARCTURUS ELECTRONICS CORP.**

502-22nd St., Union City, N.J. 07087 Dept. MRE  
Phone: 201-UN 4-5568

BACK DATE MAGAZINES! Send needs—MID-TOWN, Box 934-RE, Maywood, N.J. 07607.

**FIND BURIED TREASURE!**  
10-DAY MONEY BACK GUARANTEE  
**TREASURE PROBE**  
\$18.88 ppd  
ALL TRANSISTORIZED

3 ft. portable detector finds buried metal objects, Signals location with loud audible sound. Detects gold, silver, metallic ore and nuggets of all kinds. Find lost coins, jewelry, indian artifacts, civil war souvenirs. Treasureprobe guaranteed to equal detectors selling to \$150 or your money back. Absolutely complete, sensitive earphone, 9v battery, nothing else to buy

**TO ORDER:** Send check, cash or money order, \$5.00 deposit for COD in N.J. add 57¢ tax. TREASUREPROBE Dept. RBF P.O. Box 228, Toms River, N.J. 08753

## LIKE MUSIC WITHOUT COMMERCIALS?

The SCA-2B Sub-Carrier Adapter makes it possible for you to enjoy the background music transmitted on a 67KHz sub-carrier on many FM stations. (These programs cannot be heard on a FM set without an adapter) In the US there are approximately 400 FM stations authorized by the FCC to transmit the 67KHz programs. If you are within 50 miles of a city of 100,000 or more, it is probable that you are within the satisfactory reception range of one or more of these stations. If in doubt write for a list of such stations in your area.

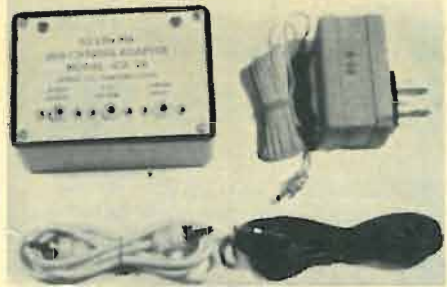

Patent Pending  
Sub-Carrier Adapter, Model SCA-2B with two 36" shielded cables. Price \$39.95.  
117 Volt AC Operated Power Supply, PS-9, Price \$4.95.

**SCA-2B FEATURES**  
SIZE: 4" x 2 7/8" x 1 1/8". • Simple plug-in connections to your FM tuner/amplifier. (If your FM tuner does not have a multiplex output jack, we supply hook-up information). • No installation adjustments • All silicon transistors • Operates from our PS-9 Power Supply or 6 to 12 volts D.C. One Year Factory Guarantee

For Custom Installations: Completely Wired SCA-2 PC card (size: 2 1/2" x 3" x 3/8") with installation instructions for \$34.95. Also available SCA-2 installed in AC operated Panasonic 7-Transistor AM-FM Radio Model R-E6137 \$59.95.

Write for Dealer Quantity Discounts.  
Commercial use of these units is not advised, unless the consent of the originating station is obtained.

Send order to KENZAC Co.  
P.O. Box 66251, Houston, Texas 77006

# ADVERTISING INDEX

RADIO-ELECTRONICS does not assume responsibility for any errors which may appear in the index below.

Allied Radio Corporation .....	69
Arcturus Electronics Corporation .....	100
Arrow Fastener Company, Inc. ....	59
B & K (Division of Dynascan Corporation) ..	7, 27
Brooks Radio and TV Corporation .....	92-93
BSR (USA) Limited .....	81
Burstein-Applebee Company .....	62
Capitol Radio Engineering Institute, The ..	18-21
Caringella Electronics, Inc. ....	90
Castle TV Tuner Service, Inc. ....	Cover 111
<b>CLASSIFIED</b> .....	100-103
Cleveland Institute of Electronics .....	54-57, 88
Coletronics .....	92
Cornell Electronics Company .....	102
Datak Corporation, The .....	72
Delta Products Inc. ....	78, 90
Editors and Engineers, Ltd. (Division of How-	
ard W. Sams & Company, Inc.) .....	73
Edlie Electronics, Inc. ....	92
Edmund Scientific Company .....	101
EICO Electronic Instrument Company, Inc.	
.....	Cover 111
Electronic Chemical Corporation .....	99
Electronic Measurement Corporation (EMC) ..	89
Electro-Voice Inc. ....	70
Esse Radio Company .....	98
Fair Radio Sales .....	103
Gavin Instruments, Inc. (Subsidiary of	
Advance Ross Corporation) .....	98
GC Electronics .....	16
Grantham School of Electronics .....	1
Heald Engineering College .....	73
Heath Company .....	82-87
Hickok Electrical Instrument Company .....	71
International Crystal Manufacturing Company	
.....	104
International Resistance Corporation .....	24
Kenzac .....	100
Lafayette Radio Electronics .....	95-96
Lectrotech, Inc. ....	94
Loral Distributor Products (Division of Loral	
Corporation) .....	5
MAS Master Appliance Corporation .....	71
Mosley Electronics, Inc. ....	97
Music Associated .....	72
National Radio Institute .....	8-11
National Technical Schools .....	28-31
Nortronics Company, Inc. ....	72
Oaktron .....	88
Olson Electronics, Inc. ....	93
Pace Communications .....	17
Perma-Power Company .....	77
Poly Paks .....	103
Quam-Nichols Company .....	6
Quietrole Company .....	90
Raytheon .....	68
RCA Electronic Components	
Test Equipment .....	14-15
Tubes .....	Cover IV
RCA Institutes .....	64-67
RCA Parts & Accessories .....	25
Rye Industries, Inc. ....	62
Sams & Company, Inc. Howard W. ....	26
Schober Organ Corporation, Inc. ....	80
SCI Electronic Ignition .....	71
Scott, Inc. H. H. ....	91
Senore .....	13
Solid State Sales .....	101
Sony Corporation of America .....	89
Superec Electronics .....	91
Surplus Center .....	99
Sylvania (Subsidiary of General Telephone	
and Electronics) .....	22-23
Vaco Products Company .....	79
Warren Electronic Components .....	102
Weller Electric Company .....	63
Zenith .....	12
<b>MARKET CENTER</b> .....	100-103
Communication Devices	
McGee Radio Company	
Sydnam Electronic Specialties	
Terado Corporation	
Treasureprobe	
United Radio Company	
Wel-Dex Manufacturing Company	
<b>SCHOOL DIRECTORY</b> .....	99
Indiana Home Study	
Tri-State College	
Valparaiso Technical Institute	

Circle 133 on reader's service card

Circle 134 on reader's service card



## SILICON RECTIFIER SALE

IMMEDIATE DELIVERY  
FULLY GTD NEWEST TYPE  
AMERICAN MADE FULLY TESTED



### 1 AMP TOP HAT AND EPOXIES

PIV	SALE	PIV	SALE	PIV	SALE
50	.05	800	.18	1800	.80
100	.07	1000	.27	2000	1.20
200	.08	1200	.40	3000	1.40
400	.10	1400	.52	4000	1.85
600	.14	1600	.67		

### "SILICON POWER DIODE STUD MOUNT"

PIV	3A	6A	12A	50A	100A	160A
50	.06	.16	.20	.50	.85	2.25
100	.07	.21	.25	.73	1.05	2.65
200	.09	.29	.38	1.23	1.60	3.50
400	.15	.39	.49	1.45	2.50	4.25
600	.19	.53	.73	1.75	3.75	6.50
800	.29	.74	.95	2.20		
1000	.38	.85	1.10	2.60		

**SPECIALS!** Stud Rect. 25 AMP-500 PIV—  
\$1.05 Ea. or 10 for \$9.00 Special

Fil. Trans. 117V at 6.3V C.T. 10 AMP Special \$1.25  
Sangamo Type DCM 10000 MFD 25 VDC \$.85 Ea.

Heat Sink 2 LBS 500 AMP  
Value \$7.00 your cost \$1.40

Westinghouse 160 AMP, 500 PIV SILICON HI-POWER  
STUD RECTIFIER IN1666.  
Limited quantity. \$5.10 ea. 10 for \$45.00

100 Different Precision Resistors  
1/2—1—2 Watt 1/2%—1% TOL \$1.25

Asst transistor Kit. P.N.P.—N.P.N.  
All popular types. Unchecked  
100 for \$2.95 500 for \$9.95

Computer Grade Condenser 15,500 MFD  
12 VDC American Mfg .75 ea.

**NEW DIODE KIT ALL POPULAR TYPES**  
IN34, IN34A, IN48, IN60, IN64 etc. 100 for \$ 4.00  
BEST QUALITY 500 for \$15.00

Money back guarantee. \$2.00 min. order. Include  
additional \$ for postage. Send check or money  
order. C.O.D. orders 25% down.

Warren Electronic Components  
230 Mercer St., N. Y., N. Y. 10012 • 212 OR 3-2620

Circle 137 on reader's service card

# MARKET CENTER

Discharge IGNITION, PHOTOFLASH. Free catalog parts, kits. TRANSPARK, Carlisle, Mass. 01741

## AUDIO — HI-FI

WRITE for highest discounts on components, recorders, tapes, from franchised distributors. Send for FREE monthly specials. CARSTON, 1686-R Second Ave. N.Y.C. 10028

HI-FI COMPONENTS, Tape Recorders, at guaranteed "WE will not be undersold" prices. 15-day moneyback guarantee. Two-year warranty. NO Catalog. Quotations Free. HI-FIDELITY CENTER, 239R East 149th St., N.Y., N.Y. 10451

SPEAKER REPAIR. Hi-Fi, guitar, organ speakers reconded good as new at fraction of new speaker price. For details and Reconding Center in your area write WALDOM ELECTRONICS, INC. 9155-4, Dept. RE. 4625 W. 53rd St., Chicago, Ill. 60632

OLD RADIO PROGRAMS on tape. Jack Armstrong, Gangbusters, hundreds more. Sample: 2-hr. \$6.00, 4-hr. \$9.00. Catalog \$1.25 or free with sample. NOSTALGIA, Dept-RE, 9875 SW 212 St., Miami, Fla.



**CUT DOWN ON MOBIL IGNITION NOISE. DON'T BE FOOLED BY IMITATIONS! Get the ORIGINAL**

### SYDMUR SOLID STATE "CD" IGNITION SYSTEM!

High Quality Components used throughout. Fiberglass Printed Circuit Board. Untitized Construction. Simplified Kit Assembly.

Construction Article in Nov. 1966 Popular Electronics Thousands of satisfied customers.

Write for Free Literature TODAY.

COMPAC Assembled . . . \$34.75\*

COMPAC KIT . . . . . 24.95\*

\*Add 75c for mailing and handling

N.Y. State Residents add Sales Tax.

**SYDMUR ELECTRONICS SPECIALTIES**

1268 E. 12th St. Brooklyn, N.Y. 11230

(Also Available in Canada)

ONE YEAR GUARANTEE!  
**TUBES!**

**33¢**  
PER TUBE

100 OR MORE TUBES  
**30¢** ea.

**Special!**  
With Every \$10 Order  
**25¢** PER TUBE

Your Choice Of These Sizes  
6AG5 6B6 6SN7  
6W4 6J6 6SA

6D6	OZ4	6AU4	6X4
6DA4	1B3	6AU5	6X8
6DE6	1H5	6AU6	7B6
6DQ6	1J3/1K3	6AV6	7C5
6EA7	1L4	6AW8	7N7
6EM5	1T4	6AX4	7Y4
6F6	1U4	6BA6	10DE7
6FQ7	1X2	6BC5	12AE6
6GH8	3B26	6BG6	12AT7
6H6	3DG4	6BJ6	12AU7
6J5	5U4	6BL7	12AX7
6K6	5U8	6BN4	12BA6
6L6	5V4	6BN6	12BE6
654	5Y3	6BN8	12BH7
65A7	6A6	6BQ6	12C5
65H7	6A8	6BQ7	12SN7
65J7	6AB4	6BZ6	12W6
65K7	6AC7	6C4	25L6
65L7	6AF4	6C6	25Z6
65N7	6AG5	6CB6	35W4
65Q7	6AK5	6CD6	84/6Z4
6U7	6AL5	6CG7	5687
6U8	6AN8	6CG8	6350
6V6	6AQ5	6CM7	6463
6W4	6AT6	6CZ5	7044
6W6	6AT8		

Tubes are New or Used and So Marked. Lab Tested, Ind. Boxed, Branded & Code Dated



DEPT RE-11 4217 UNIVERSITY  
SAN DIEGO, CALIFORNIA 92105

Circle 138 on reader's service card

Prestige & Success as an  
**ELECTRONICS EXPERT!**



**HOME STUDY COURSES**  
TV SERVICING \$3.50  
RADIO SERVICING \$3.00  
**BOTH COURSES \$6.00**

**2 STATION INTERCOM**  
**12<sup>95</sup>**  
A.C. 110 VOLT TRANSISTORIZED INTERCOM!

ONE YEAR GUARANTEE!  
**DUMONT TUBES!**



Brand New Except Glass!

TUBE TYPE	DUD DEP.	TUBE PRICE
19XP4	3.00	21.95
21AMP4	1.00	14.95
21CBP4	1.00	14.95
21CEP4	3.00	18.95
23FP4	5.00	24.95
21FJP22	20.00	79.95
23EGP22	35.00	119.95
25AP22	27.50	99.95
23AHP4	5.00	24.95
24AEP4	1.00	22.95

Please remit full tube price plus dud deposit with order. Dud deposit will be returned immediately upon postpaid return of dud. No C.O.D.'s on picture tubes. All duds returned for refund must be under full vacuum.

**FREE! CORNELL'S NEW CATALOG! WRITE FOR YOUR COPY TODAY!**

### RED & BLACK TUBE CARTONS

High Gloss, Clay Coated, Built in Diag. Partitions

SIZE	TUBE SIZE	10 CARTONS	100 CARTONS
MIN.	6AU6	.29	2.59
GT.	6SN7	.39	3.49
LG. GT	5U4G8	.59	5.29
G.	5U4G	.89	7.99

NO SUBSTITUTIONS WITHOUT YOUR PERMISSION!  
YOUR ORDER FREE IF NOT SHIPPED WITHIN 24 HRS.

Terms: Orders over \$5.00: Add 3c per tube shipping. Prepay in full and avoid C.O.D. charges. Send \$3.00 deposit on C.O.D. orders. Orders under \$5.00: Add 3c per tube plus 50c handling. Canadian and Foreign Orders: add approx. postage. No C.O.D. orders. Combine varied orders to bring order over \$5.00.



RENT 4-track open reel tapes—all major labels—3,000 different—free brochure. STEREO-PARTI, 55 St. James Drive, Santa Rosa, Ca. 95401

COMPUTER PROGRAMMING—the big opportunity career. New recognized correspondence course. No maths needed. FREE brochure. CANADIAN INSTITUTE OF SCIENCE AND TECHNOLOGY, 263 T, Adelaide St. W., Toronto.

## EDUCATION/ INSTRUCTION

FCC First Class License in six weeks—nation's highest success rate—approved for Veterans Training. Write ELKINS INSTITUTE, 2603E Inwood Road, Dallas, Texas 75235

HOME STUDY COURSES in Logic Design, Pulse and Digital Circuits, Digital Computer Design, and Feedback Systems. Send for free catalog. EDUCATION FOR CAREER ADVANCEMENT, P.O. Box 31, Mineola, New York 11501. (licensed as a correspondence school by the New York State Education Department.)

Accredited Canadian ELECTRONICS TRAINING, day, night, home study courses. Free booklet. RADIO COLLEGE OF CANADA, 461 King St. West, Toronto 2B, Ontario, Canada.

## SERVICEMEN • EXPERIMENTERS!

IF YOU WISH TO PURCHASE  
BRAND NEW TUBES

RECEIVING—SPECIAL PURPOSE BC TUBES AT OUTSTANDING MONEY SAVING VALUES.

WE HAVE THE MOST UP TO DATE TUBES LISTED PLUS THE HARD TO GET TYPES. DON'T CONFUSE OUR TUBES WHICH ARE NEW WITH THE PULLOUTS AND REJECTS.

SEND FOR OUR CATALOG.

UNITED RADIO COMPANY  
ESTAB. 1920

56 FERRY ST., NEWARK, N.J. 07105

## INVENTIONS & PATENTS

MANUFACTURERS NEED NEW ITEMS! B. F. Goodrich, Black & Decker, South Bend Tackle and other million dollar corporations have authorized us to locate new products. For details regarding development, sale, licensing of your patented/unpatented invention, write: THE RAYMOND LEE ORGANIZATION, 230-U Park Avenue, New York City 10017

INVENTIONS WANTED. Patented; Unpatented. GLOBAL MARKETING, 2420-AE 77th Ave., Oakland, Calif. 94605



WRITE NOW FOR FREE 1969 CATALOG

McGEE RADIO COMPANY

1001 BARGAINS IN SPEAKERS—PARTS  
TUBES—HIGH FIDELITY COMPONENTS  
RECORD CHANGERS—TAPE RECORDERS—KITS  
EVERYTHING IN ELECTRONICS.

1901 McGee St., Kansas City RE, Missouri 64108



## HEAVY DUTY WELDER

Does work of \$85.00 welder

yet costs only **1895**

POST PAID

Fit ordinary 110V outlet  
3 welding heats

Weld, braze, solder or cut most anything made of metal. No experience needed. Follow simple instructions. Uses standard 1/4" rods to weld iron, steel, brass, bronze, aluminum, other metals. 3 welding heats . . . not just one as with other low priced models. New HEAVY DUTY circuit gives higher heat . . . 4 times the heat needed to melt toughest iron. More welding power than ever before. Comes complete with welder's mask, \$2.00 pack of rods, flux, carbons, automatic arc striker, etc. NOTHING ELSE TO BUY. Approved for homes, garages, shops, factories. 10 day MONEY BACK trial. Guaranteed against burnouts. Send \$2.00 and pay \$16.95 plus small C.O.D. when delivered, or send \$18.95 cash, c.k., M.O. for postpaid shipment. WEL-DEX MFG. CO., Dept. W-38, Box 10776, Houston, Texas 77018

## FAIRCHILD \*\* BRAND NEW! "FLAT PAK" RTL

INTEGRATED CIRCUITS		Sole
<input type="checkbox"/>	900 Buffer	\$1.49
<input type="checkbox"/>	903-903* 3 Input Gate	\$1.69
<input type="checkbox"/>	904-904* Half Adder	\$1.69
<input type="checkbox"/>	914-914* Dual 2 Input Gate	\$1.49
<input type="checkbox"/>	923 JK Flip Flop	\$1.69
<input type="checkbox"/>	923-923* JK Flip Flop	\$1.98
<input type="checkbox"/>	927 Quad Inverter	\$1.69

\*First time anywhere two identical IC's in one package, example 923-923 contains two separate JK flip-flops in one package. 914's and 923.30 Basic IC Projects Licensed. 1/4" x 1/4"

## LINEAR AMPLIFIERS with circuits & data

<input type="checkbox"/>	702C WIDE BAND DC	\$3.98
<input type="checkbox"/>	703H RF-IF-FM	\$1.49
<input type="checkbox"/>	709C HI-GAIN OPERATIONAL	\$3.98
<input type="checkbox"/>	710C HI-SPEED DIFF. COMP.	\$3.98
<input type="checkbox"/>	711G DUAL COMPARATOR	\$4.98

## FAIRCHILD IN-LINE INTEGRATED CIRCUITS

<input type="checkbox"/>	952 DUAL 2 INPUT INVERTER GATE	\$1.00
<input type="checkbox"/>	953 2-2-3 INPUT AND GATE	\$1.00
<input type="checkbox"/>	954 DUAL 4 INPUT AND GATE	\$1.00
<input type="checkbox"/>	955 8 INPUT AND GATE W/2 INPUTS	\$1.00
<input type="checkbox"/>	956 DUAL INPUT BUFFER	\$1.00

100's of other IC's including: Flip-Flops, Registers, Adders, etc. Write for listing.

## Buy 10 PAKS & CHOOSE 1 FREE

<input type="checkbox"/>	\$25 SURPRISE PAK: transistors, rect, diodes, etc. . .	\$1
<input type="checkbox"/>	6 ONE AMP 800 PIV RECTIFIERS, silicon top hat . . .	\$1
<input type="checkbox"/>	2-CLAIREX PHOTO ELECTRIC CELL, . . . Hobby must	\$1
<input type="checkbox"/>	50 GERMANIUM GLASS DIODES, 1N34, 1N48 no test	\$1
<input type="checkbox"/>	40 TOP HAT SILICON RECTIFIERS, no test/asst values	\$1
<input type="checkbox"/>	25 EPXY RECTIFIERS, silicon asst, no test . . .	\$1
<input type="checkbox"/>	40 PRECISION RESISTORS, 1/2-2W, 1% asst values	\$1
<input type="checkbox"/>	30 TRANSISTORS, rf, if, audio, osc, no test . . .	\$1
<input type="checkbox"/>	60 TUBULAR CONDENSERS, to .5mf to 1KV, asst . . .	\$1
<input type="checkbox"/>	50 DISC CONDENSERS, to .05mf npo, temp coef, asst	\$1
<input type="checkbox"/>	10 TUBE SOCKETS, receptacles, plugs, audio, etc. . .	\$1
<input type="checkbox"/>	30 POWER RESISTORS, to 25 watts, to 24K ohms . . .	\$1
<input type="checkbox"/>	3 2N3568 NPN TRANSISTORS, 200mc, 200V, 200hfe, \$1	\$1
<input type="checkbox"/>	3 2N3563 TRANSISTORS, npn, 600mc, 100hfe, epoxy \$1	\$1
<input type="checkbox"/>	10 VOLUME CONTROLS, to 1 meg, switch too! . . .	\$1
<input type="checkbox"/>	10 ELECTROLYTICS, to 100mf, tubulars too, asst . . .	\$1
<input type="checkbox"/>	50 RADIO & TV KNOBS, asst colors & styles . . .	\$1
<input type="checkbox"/>	10 TRANS'OR ELECTROLYTICS, to 100mf, asst values	\$1
<input type="checkbox"/>	50 COILS AND CHOKES, if, rf, ant, osc, peaking, etc	\$1
<input type="checkbox"/>	65 HALF WATERS, to 1 meg, 5% popular values too	\$1
<input type="checkbox"/>	60 HI-QUALITY RESISTORS, 1/2, 1, 2W asst values . . .	\$1
<input type="checkbox"/>	10 RCA PHONO PLUGS & JACK SETS, tuners, etc. . .	\$1
<input type="checkbox"/>	4 INTEGRATED CIRCUITS, gates, etc. no test . . .	\$1
<input type="checkbox"/>	2-PC INFRA-RED DETECTOR & FILTER SET science proj	\$1
<input type="checkbox"/>	2 FIELD EFFECT TRANSISTORS, n channel, hobby . . .	\$1
<input type="checkbox"/>	50 TERMINAL STRIPS, 1 to 8 lug types . . .	\$1
<input type="checkbox"/>	3 PHOTO ELECTRIC CELLS, hi. imp., schematic . . .	\$1
<input type="checkbox"/>	3 TRANS'OR AMPLIFIER, WIRED, 3x2x3/4" schematic \$1	\$1
<input type="checkbox"/>	10 PRINTED CIRCUIT BOARDS, copper clad, 100 uses	\$1
<input type="checkbox"/>	10 TRANSISTOR SOCKETS, for pnp & npn types . . .	\$1
<input type="checkbox"/>	10 PANEL SWITCHES, toggle, slide, in/ro, rotary . . .	\$1
<input type="checkbox"/>	4 TRANSISTOR TRANSFORMERS, asst, worth \$25 . . .	\$1
<input type="checkbox"/>	5 RAYTHEON CK-722 TRANSISTORS, npn, most pop	\$1
<input type="checkbox"/>	5 G.E. 2N107 TRANSISTORS, npn, audio ects . . .	\$1
<input type="checkbox"/>	6 "IBM" COMPUTER BOARDS, many trans, diodes, \$1	\$1
<input type="checkbox"/>	40 "MICRO" CONDENSERS, for transistor circuitry \$1	\$1
<input type="checkbox"/>	3 1/4W. EPOXY TRANSISTORS, npn, silicon, B-5000, \$1	\$1
<input type="checkbox"/>	15 3 to 12 AMP STUD RECTIFIERS, up to 600 PIV . . .	\$1

Terms: add postage. Rated: net 30, cod's 25%  
Phone Orders: Wakefield, Mass. (617) 245-3829  
Retail: 211 Albion, St., Wakefield, Mass.

GIANT 'XMAS' CATALOG ON: Parts, Rectifiers, 10¢  
 Transistors, SCRs, I.C.'s; Equipment, Etc.

**POLY PAKS** P.O. BOX 942 R  
Lynnfield, Mass. 01940

CLASSIFIED COMMERCIAL RATE (for firms or individuals offering commercial products or services). 70¢ per word . . . minimum 10 words.

NON-COMMERCIAL RATE (for individuals who want to buy or sell personal items) 30¢ per word . . . no minimum.

Payment must accompany all ads except those placed by accredited advertising agencies. 10% discount on 12 consecutive insertions, if paid in advance. Misleading or objectionable ads not accepted. Copy for January issue must reach us before November 11.

## INSTANT TUNING CROWNE CONVERTERS

Xtal stabilized for converting from AM or FM to AM input to Auto Radio, output tuneable (bandspread 1.0 mhz) by Auto Radio • 24-hr MARINE WEATHER FORECASTING ON 162.55mhz (radio dial at 1350) Marine V.H.F. or Marine Low Band (2.0 to 3.0 mhz) etc! C.B.! • Special this issue, LOW at \$19.95; plus tax where applicable (attach this ad to order). Others for AIRCRAFT: SHERIFF: FIRE: POLICE DOCTORS ANSWERING. Also FM COMMERCIAL TO AUTO RADIO etc. etc.

• COMING SOON:—FRONT-END PLUG-IN SQUELCH DEVICE WITH up to 70db quieting against man-made and radiated noise OPERATES WITH ANY MOBILE EQUIP.

## COMMUNICATION DEVICES CO.

Box 248, CALABASAS, CALIF 91302 (213) 888-8000  
Dealers and reps wanted all areas



# FREE Catalog of The WORLD'S FINEST GOV'T SURPLUS ELECTRONIC BARGAINS

Now BIGGER and BETTER Than Ever!

MAIL THIS COUPON NOW!

NAME: \_\_\_\_\_  
ADDRESS: \_\_\_\_\_  
CITY: \_\_\_\_\_ STATE: \_\_\_\_\_ ZIP NO.: \_\_\_\_\_

FAIR RADIO SALES • Box 1105 • Lima, Ohio 45802

Circle 139 on reader's service card

Circle 140 on reader's service card

**NEW  
FROM  
INTERNATIONAL**



# FM-2400 FREQUENCY METER

- For Mobile Or Base Station Use
- Tests Predetermined Frequencies 25 - 470 MHz
- Portable . . . Use It Anywhere

The FM-2400 is designed for testing and adjustment of mobile and base station transmitters and receivers at predetermined frequencies between 25 and 470 MHz. The FM-2400 provides an accurate standard frequency signal to which the transmitter can be compared. This same signal is applied to the associated receiver(s), thereby assuring an accurate frequency adjustment on all parts of the communications system.

Up to 24 crystals may be inserted into the meter for the selection of the frequencies required for testing of the system transmitters and receivers. The frequencies can be those of the radio frequency channels of operation,

and/or of the intermediate frequencies of the receiver between 100 KHz and 100 MHz. Self contained unit. Battery operated.

FM-2400 (meter only).....	\$395.00
RF Crystals with temperature run.....	\$23.50 ea.
IF Crystals 200 - 2,000 KHz .....	See Catalog*
2,001 - 13,000 KHz.....	See Catalog*

\*WRITE FOR FREE CATALOG



**CRYSTAL MFG. CO., INC.**

10 NO. LEE • OKLA. CITY, OKLA. 73102

Circle 141 on reader's service card

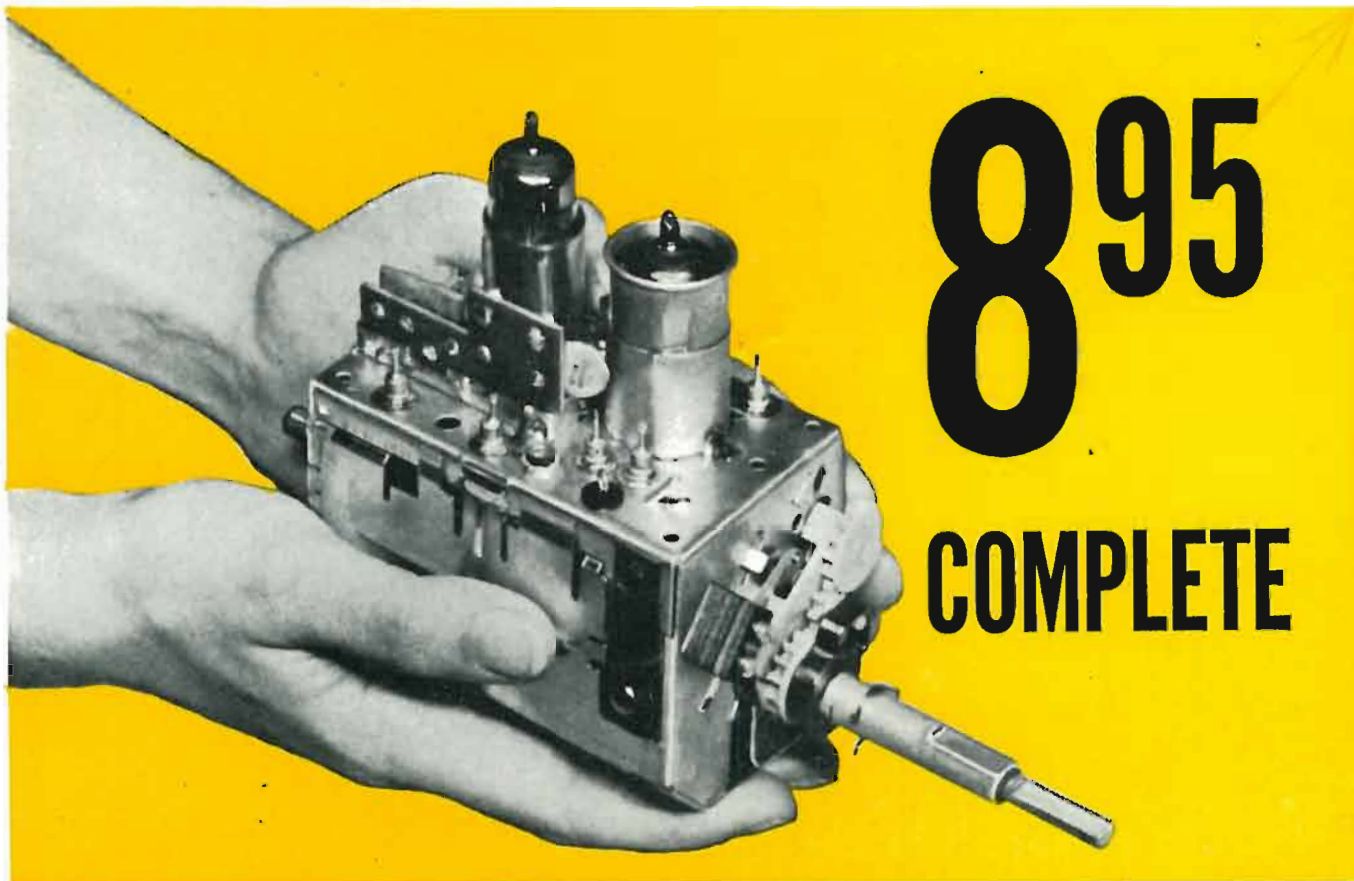

# 8<sup>95</sup> COMPLETE

Castle, the pioneer of television tuner overhauling, offers the following services to solve ALL your television tuner problems.

● **OVERHAUL SERVICE** — All makes and models.

- VHF or UHF tuner \$9.95
- UHF-VHF combination (one piece chassis) \$9.95
- TRANSISTOR tuner \$9.95
- COLOR tuner \$9.95  
(Guaranteed color alignment . . . no additional charge)

Overhaul includes parts, except tubes and transistors.

Simply send us the defective tuner complete; include tubes, shield cover and any damaged parts with model number and complaint. Your tuner will be expertly overhauled and returned promptly, performance restored, aligned to original standards and warranted for 90 days.

UV combination tuner must be single chassis type; dismantle tandem UHF and VHF tuners and send in the defective unit only.

And remember—for over a decade Castle has been the leader in this specialized field . . . your assurance of the best in TV tuner overhauling.

● **CUSTOM REPLACEMENTS**

Exact replacements are available for tuners that our inspection reveals are unfit for overhaul. As low as \$12.95 exchange. (Replacements are new or rebuilt.)

● **UNIVERSAL REPLACEMENTS**

Prefer to do it yourself?

Castle universal replacement tuners are available with the following specifications.

STOCK No.	HEATERS	SHAFT		I.F. OUTPUT		PRICE
		Min.*	Max.*	Snd.	Pic.	
CR6P	Parallel 6.3v	1¾"	3"	41.25	45.75	8.95
CR7S	Series 600mA	1¾"	3"	41.25	45.75	9.50
CR9S	Series 450mA	1¾"	3"	41.25	45.75	9.50
CR6XL	Parallel 6.3v	2½"	12"	41.25	45.75	10.45
CR7XL	Series 600mA	2½"	12"	41.25	45.75	11.00
CR9XL	Series 450mA	2½"	12"	41.25	45.75	11.00

\*Selector shaft length measured from tuner front apron to extreme tip of shaft.

These Castle replacement tuners are all equipped with memory fine tuning, UHF position with plug input for UHF tuner, rear shaft extension and switch for remote control motor drive . . . they come complete with hardware and component kit to adapt for use in thousands of popular TV receivers.

Order universal replacements out of Main Plant (Chicago) only.



## CASTLE TV TUNER SERVICE, INC.

MAIN PLANT: 5715 N. Western Ave., Chicago, Illinois 60645  
EAST: 41-96 Vernon Blvd., Long Island City, N.Y. 11101

Circle 142 on reader's service card

# Come and get it!

Technical Series RC-26

## **RCA** Receiving Tube Manual

**\$175**

Suggested  
Price

The RC-26 is the biggest and best receiving tube manual in the industry! Newly revised and updated, it now has 656 pages of vital data... information on the complete RCA line of home-entertainment receiving tubes, color and black-and-white picture tubes, voltage-regulator tubes and voltage-reference tubes... expanded Circuits Section featuring several circuits that illustrate the various stages of a complete color-television receiver... extremely handy Applications Guide... Technical Data section with comprehensive data and curves for all active RCA receiving tubes.

See your RCA Distributor today for your copy of the RC-26. It's the best yet.

Be sure to ask your customers "WHAT ELSE NEEDS FIXING"?

RCA Electronic Components,  
Harrison, N. J. 07029

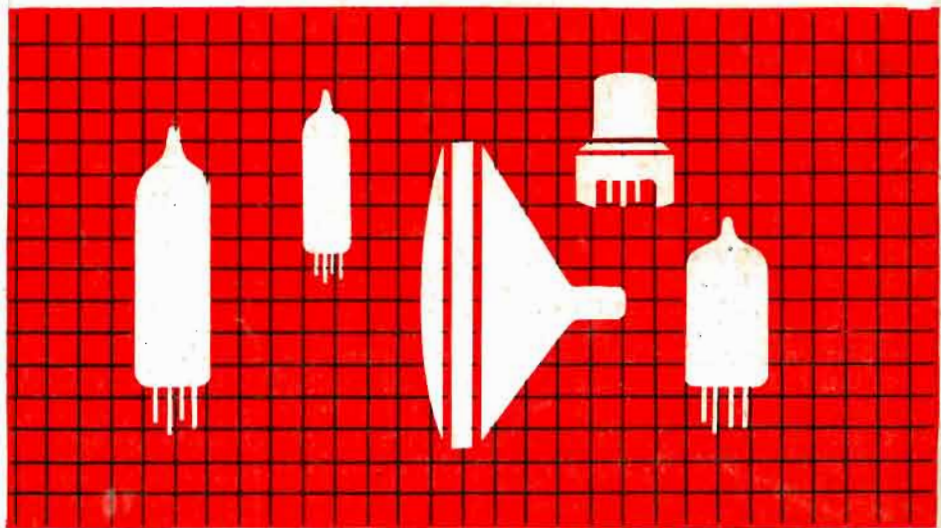

**RCA**