

Microelectronics —
Thin-Film Approach

Build a Three-Tube
20-Watt Amplifier

Citizens Band Equipment
How To Service It

Radio-Electronics

NOV. 50c

IND

TELEVISION • SERVICING • HIGH FIDELITY

A
GERNSBACK
PUBLICATION

HUGO GERNSBACK, Editor-in-chief

Electronic Engine Analyzers

Expandable-Modular Concept and
Easy-to-Service Features in...

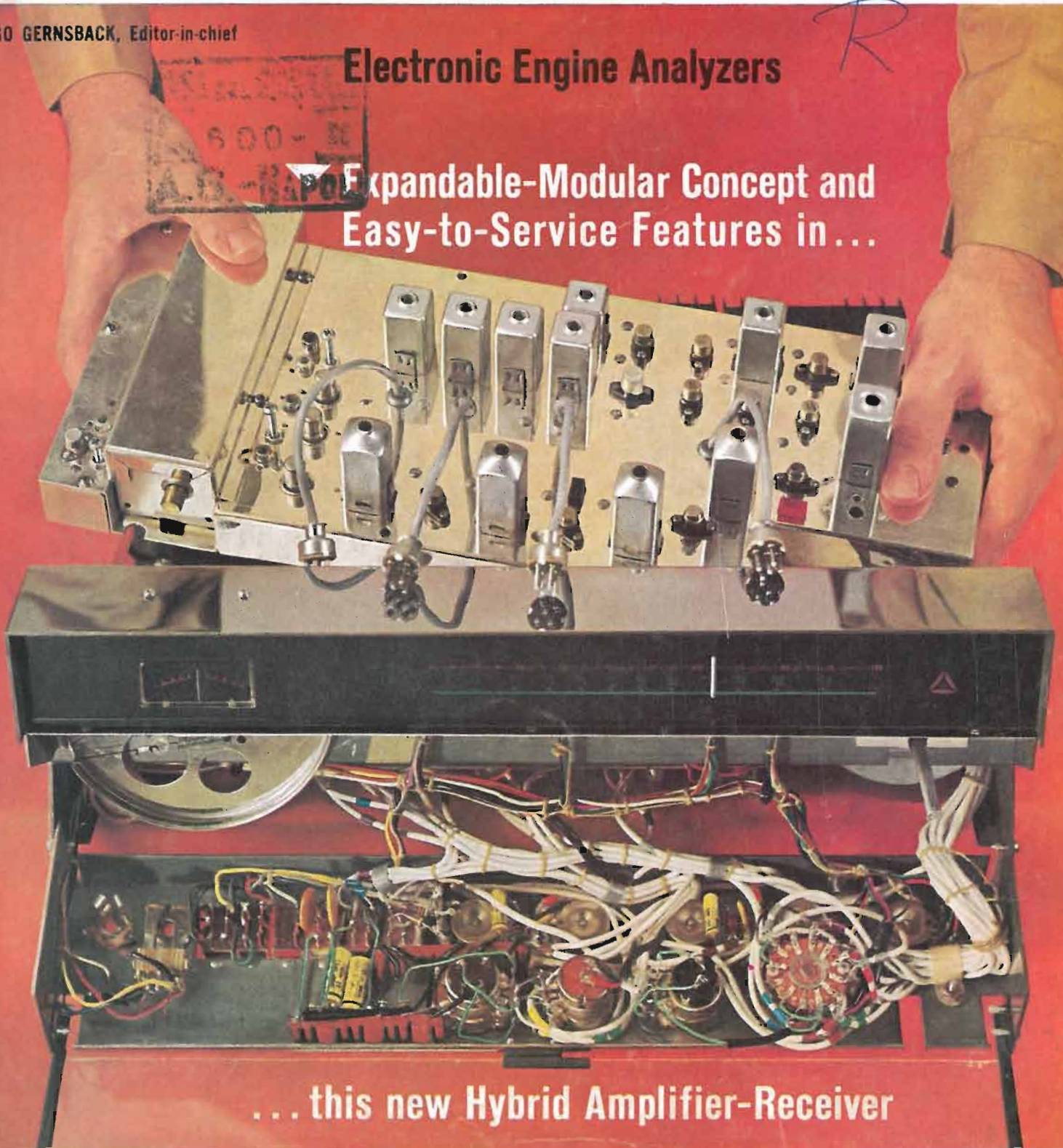

... this new Hybrid Amplifier-Receiver

are you replacing
top quality tubes
with identical
top quality tubes
?

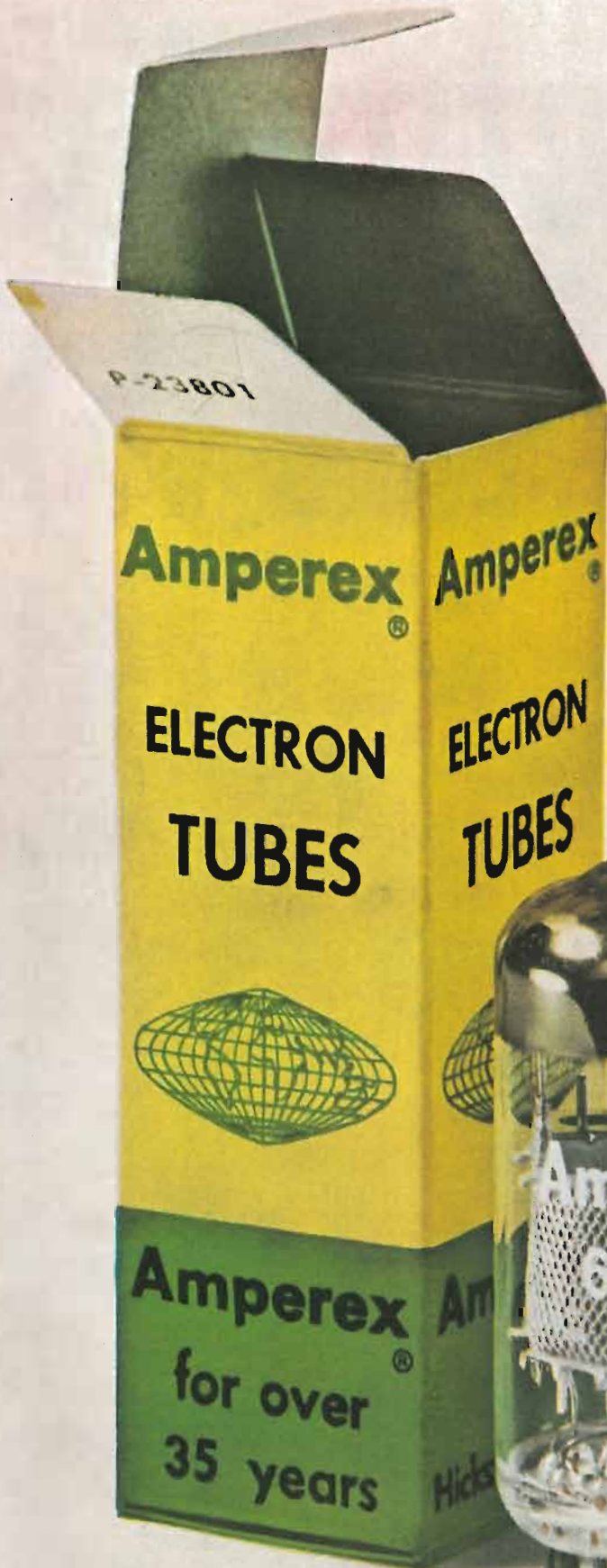

Now you can carry the identical tubes that you find designed into most of the quality TV sets you service. Chances are, you were not aware that these TV sets were designed around special Frame Grid tubes originated by Amperex and that even more tube types originated by Amperex are being designed into the sets you'll be handling in the future. Amperex frame grid tubes provide 55% higher gain-bandwidth, increase TV set reliability by simplifying circuits and speed up your servicing because their extraordinary uniformity virtually eliminates need for re-alignment when you replace tubes.

Tubes introduced by Amperex, currently used by major TV set makers include:

Frame Grid				Others	
2GK5	4GK5	6GK5	6EH7	6AL3	9A8
2ER5	4EH7	6ES8	6EJ7	6BL8	15CW5
3GK5	4EJ7	6ER5	6HG8	6BQ5	16AQ3
3EH7	4ES8	6FY5	7HG8	12AX7	27GB5

For optimum satisfaction for your customers and a better profit operation for yourself, make room in your caddy now for these matchless-quality tubes. Next time you visit your distributor, look for the green-and-yellow boxes and enjoy confidence in your work such as you never have before. Amperex Electronic Corporation, Hicksville, L. I., New York.

THE SAME ENGINEERING, SAME PLANT THAT
PRODUCES AMERICA'S GREATEST SATELLITE-
TRACKING AND TELEMETRY STATIONS, HAS CREATED

the revolutionary new

PARALOG

TV/FM ANTENNA



... Unparalleled performance because it has **ALL 5**:

- HIGHEST GAIN
- SHARPEST DIRECTIVITY
- EXTREMELY LOW VSWR
- BEST FRONT-TO-BACK RATIO
- RUGGED CONSTRUCTION

HERE IT IS—the space-age TV/FM antenna from the only manufacturer with actual experience in making space-probing antennas!

All new, the PARALOG is the first home antenna that really comes through with log-periodic

design plus a unique parasitic-element system for maximum all-channel gain and pinpoint directivity. Exclusive Cylolac insulating mounts assure constant impedance, eliminate troublesome cross-feed design. Extremely rugged construction.



There are fourteen PARALOG antenna models, listing from \$19.95, including four electronic PARALOGs with Super Powermate preamplifier, and three special FM stereo models. See your Jerrold-TACO distributor now, or write Jerrold Electronics, Philadelphia 32, Pa.

Radio-Electronics

NOVEMBER 1963 VOL. XXXIV NO. 11

Over 55 Years of Electronic Publishing

EDITORIAL

- 27 Electronic Robots.....Hugo Gernsback

AUDIO-HIGH FIDELITY-STEREO

- 28 20 Watts Stereo... 3 Tubes!.....Peter E. Sutheim
Construction project—backed up by lab specifications
- 36 Bell Imperial 1000 (Cover Feature)
Hybrid FM Stereo Receiver
- 44 Going Multiplex with an Adapter.....Herman Burstein
Systematic steps to good FM stereo
- 64 Stereo Alarm for MPX Adapters.....Ben Johnson

ELECTRONICS

- 32 Working with Electronic Engine Analyzers.....Arthur S. Kramer
They track down ignition system faults fast
- 38 Microelectronics—the Thin Film Approach.....C. D. Simmons
How many flip-flops can be placed on a pinhead?
- 41 Servicing Sound Movie Projectors.....Jack Darr
Part II: Clutch mechanisms, threading, safety precautions

GENERAL

- 40 Do You Know the Law?
(Answers are on page 57)
- 49 What's New?
- 55 What's Your EQ?
- 56 New Techniques Make Fantastic Vacuum

RADIO

- 46 Servicing CB Transceivers.....Jim Kyle, KEG-3382
You can do almost everything without a license
- 60 Transmitter Fits In a Tooth.....B. R. D. Gillings
It's used in dental research

TELEVISION

- 30 Tuner Input Impedance.....Robert G. Middleton
- 43 Diagnosis and the Frozen Brain.....John Fitzgibbon
What happens when you stop thinking
- 66 Tough Fight, Ma, but I WON.....Frank A. Salerno
TV servicing is a real picnic
- 50 Service Clinic.....Jack Darr

TEST INSTRUMENTS

- 31 The Pattern Depends on the Probe.....Arthur Cunningham
- 48 Minimizing Vtvm Pointer Shift.....R. M. Centerville
- 74 Generator-Tracer and 200,000 Ohms/Volt Multi tester
Equipment Reports: Olson KB-141/Rf/Af and Triplet 630-NS
- 80 Transistors and Your Ohmmeter.....Gene Madison
Used with caution, your vom makes a handy checker

THE DEPARTMENTS

- | | | | |
|-------------------|-------------------------------|-------------------------|------------------|
| 55 Correction | 107 New Patents | 6 News Briefs | 96 Technotes |
| 18 Correspondence | 87 New Products | 101 Noteworthy Circuits | 104 Try This One |
| 111 New Books | 98 New Semiconductors & Tubes | 83 Technicians' News | 103 50 Years Ago |
| 94 New Literature | | | |



Member,
Institute of High Fidelity
Radio-Electronics
is indexed in
Applied Science
& Technology Index
(Formerly
Industrial Arts Index).

HUGO GERNSBACK, editor-in-chief and publisher. M. HARVEY GERNSBACK, editor. Fred Shunaman, managing editor. Robert F. Scott, W2PWG, technical editor. Peter E. Sutheim, associate editor. Jack Darr, service editor. I. Queen, editorial associate. Frank T. Baker, director advertising sales. John J. Lamson, eastern sales manager. Wm. Lyon McLaughlin, technical illustration director.

GERNSBACK PUBLICATIONS, INC., Editorial, Advertising Offices, 154 W. 14 St., N.Y. 10011. AL 5-7755. Board Chairman Hugo Gernsback, President M. Harvey Gernsback, Secy. G. Aliquo

A NEW WORLD OF OPPORTUNITY AWAITS YOU WITH N.T.S. ALL-PHASE HOME TRAINING IN ELECTRONICS



You can install and maintain electronic circuitry in missiles and rockets ... specialize in micro-waves, radar and sonar.



You can succeed in TV-Radio Communications ... prepare for F.C.C. License, service advanced satellites for industry and defense.



You can service and repair the electronic "brains" of industry — computers, data processing, and other automation equipment.



You can become a highly-paid TV-Radio Technician, an electronics field engineer, or succeed in your own sales & service business.

The N.T.S. Master Course enables you to do more, earn more in ELECTRONICS • TELEVISION • RADIO Yet N.T.S. Training costs no more than other courses far less complete

There's a good reason why N.T.S. Master-Training opens a wide new world of opportunity for you in Electronics, Television, Radio.

Everything you learn, from start to finish, can be applied directly to all phases of the Electronics Industry.

As a result, the N.T.S.-Trained Technician can move ahead faster, in any direction — from TV-Servicing to Radio Communications to Space-Missile Electronics and Automation for industry and defense. You can go wherever pay is highest and opportunity unlimited.

Electronic circuitry, for example, is one of science's miracles that is basic to the entire field of Electronics. It is used in satellites, computers and space capsules as well as in today's television sets and high fidelity equipment. N.T.S. shows you how to service and repair electronic circuitry for all electronic applications.

You work on many practical job projects. You build a short-wave, long-wave superhet receiver, plus a large-screen television set from the ground up. N.T.S. training kits contain all the parts you need ... at no extra cost. (See box at right.) You also receive a professional Multitester to use during training and on the job.

ONE LOW TUITION. You need training related to all phases of Electronics. Industry demands it. Only N.T.S. provides it ... in ONE Master Course at ONE low tuition.

RESIDENT TRAINING AT LOS ANGELES

If you wish to take your Electronics-TV-Radio training in our famous Resident School in Los Angeles — the oldest and largest school of its kind in the world — write for special Resident School catalog and information, or check coupon.



NATIONAL TECHNICAL SCHOOLS

WORLD-WIDE TRAINING SINCE 1905

4000 So. Figueroa St., Los Angeles 37, Calif.

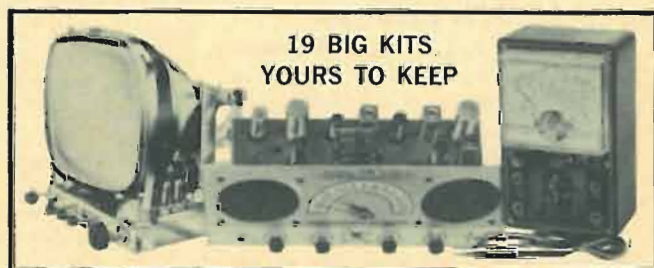

19 BIG KITS
YOURS TO KEEP



MAIL COUPON NOW FOR FREE BOOK AND ACTUAL LESSON!

NO OBLIGATION.
NO SALESMAN WILL CALL.

NATIONAL TECHNICAL SCHOOLS

WORLD-WIDE TRAINING SINCE 1905

**National Technical Schools, Dept. RG-113
4000 S. Figueroa St., Los Angeles 37, Calif.**

Please Rush FREE Electronics-TV-Radio "Opportunity" Book and Actual Lesson. No Salesman Will Call.

Name _____ Age _____

Address _____

City _____ Zone _____ State _____

Check if interested ONLY in Resident Training at L.A.

High school home study courses also offered. Check for free catalog.

NEWS BRIEFS

New Device Makes Speech From Written Characters

Reversing the old idea of a talking-into typewriter, Melpar, Inc. has just demonstrated a working model of a system for generating speech from written patterns. The device is called EVA (electronic vocal analog) and is adapted from a somewhat similar device developed at the Royal Institute of Technology in Sweden.

One of the advantages of such a device is that it can be used on a much narrower band than an ordinary phone channel. The experimental model requires a bandwidth only about 1/30 that of a normal voice communications band. The chief use of the present model, however, is to study human speech. Learning how speech is put together could be very valuable in developing other instruments along the lines of EVA, phonetic typewriters and other speech-electronic devices.

Illegal CB Operator Faces Several Charges

Warren J. Currence of Elkins, W. Va., was arrested last August for alleged operation of an unlicensed citizens radio station. He was held under \$1,000 bond for appearance before the grand jury, and three CB transmitters were seized.

Currence had earlier been charged with using obscenity on the air, and his citizens radio license was revoked. This was the result of complaints "by hundreds of Citizens Band licensees" in central West Virginia.

If found guilty of transmitting obscenity over the citizens band, Currence is subject to a maximum penalty of \$10,000 fine or not more than two years imprisonment, or both. And, if convicted of transmitting after his license had been revoked, he faces a like fine or imprisonment not exceeding one year, or both.

Transistors in Ascendant At New York Hi-Fi Show

Transistors in almost every form and in nearly every kind of circuit were the hit of the 1963 High Fidelity Music Show, held September 11-15 in New York City.

Ampex's complete home-entertainment system has: an AM-FM stereo tuner; a record changer; a stereo control-center-and-pre-amp; a 4-track tape record-play-back machine; a built-in stereo speaker system; color television; video tape recorder good for 90 minutes of TV recording; a vidicon camera that can be used with the recorder or with the TV set directly; two microphones for stereo recording; and a timer to preset the video recorder to take down a program without attention, or to record one while another is being watched.

Total ac-line current drain is 12 amperes! An Ampex engineer is part of the deal for as long as it takes to supervise installation.



The show, billed by the Institute of High Fidelity, its sponsors, as "the largest to be staged by the industry", was attended by more than 25,000 persons.

Emphasis was placed this year on decorative aspects of hi-fi. Several exhibitors' rooms were sumptuously furnished to show how well a stereo system could fade into the woodwork, and there was a gallery of photographs of installations from around the country.

But among the displays of 83 manufacturers all over the world, transistor equipment was probably the most prominent. For the first time, several major manufacturers (Sherwood, Scott, Fisher and Pilot among them) exhibited all-transistor equipment.

The prize for the most expensive single piece of home entertainment equipment must surely go to Ampex for its "Signature V", a \$30,000 colossus in a 9-foot long walnut cabinet which, besides the usual AM-FM stereo tuner, changer and tape re-

recorder, contains a color television set, a video tape recorder and a self-contained TV camera. (See photo above.)

Other highlights included comparisons of live and recorded music, some of it composed especially for the show.

New TV Sees The Invisible

A detection system for the invisible fire of liquid hydrogen has been announced by General Dynamics/Astronautics. Liquid hydrogen, which supplies nearly 40% more power than conventional propellants, used to be considered too dangerous

Advertising Representatives: South — J. Sidney Crane & Associates, 22 8th St. N. E., Atlanta, Ga., Tel. TRinity 2-6720. Florida: Neff Associates, 15 Castle Harbor Isle, Fort Lauderdale, Fla., Tel. LOgan 6-5656. West—Husted-Coughlin, Inc., 1830 W. 8th St., Los Angeles, Calif., Tel. 389-3132. 444 Market St., San Francisco, Calif., Tel. GARfield 1-0151. **United Kingdom** — Publishing & Distributing Co., Ltd., Milre House, 177 Regent St., London W.1, England.

Subscription Service: Address form 3579 and correspondence to Radio-Electronics, Subscriber Service, 154 West 14th St., New York, N. Y. 10011. When requesting a change of address please furnish an address label from a recent issue. Allow one month for change of address.

MEN 17-55

HERE'S YOUR BIG CHANCE. If you can follow clear basic instructions, leave the rest to DeVry Tech.

Have You missed this Newer World of Job Opportunities?

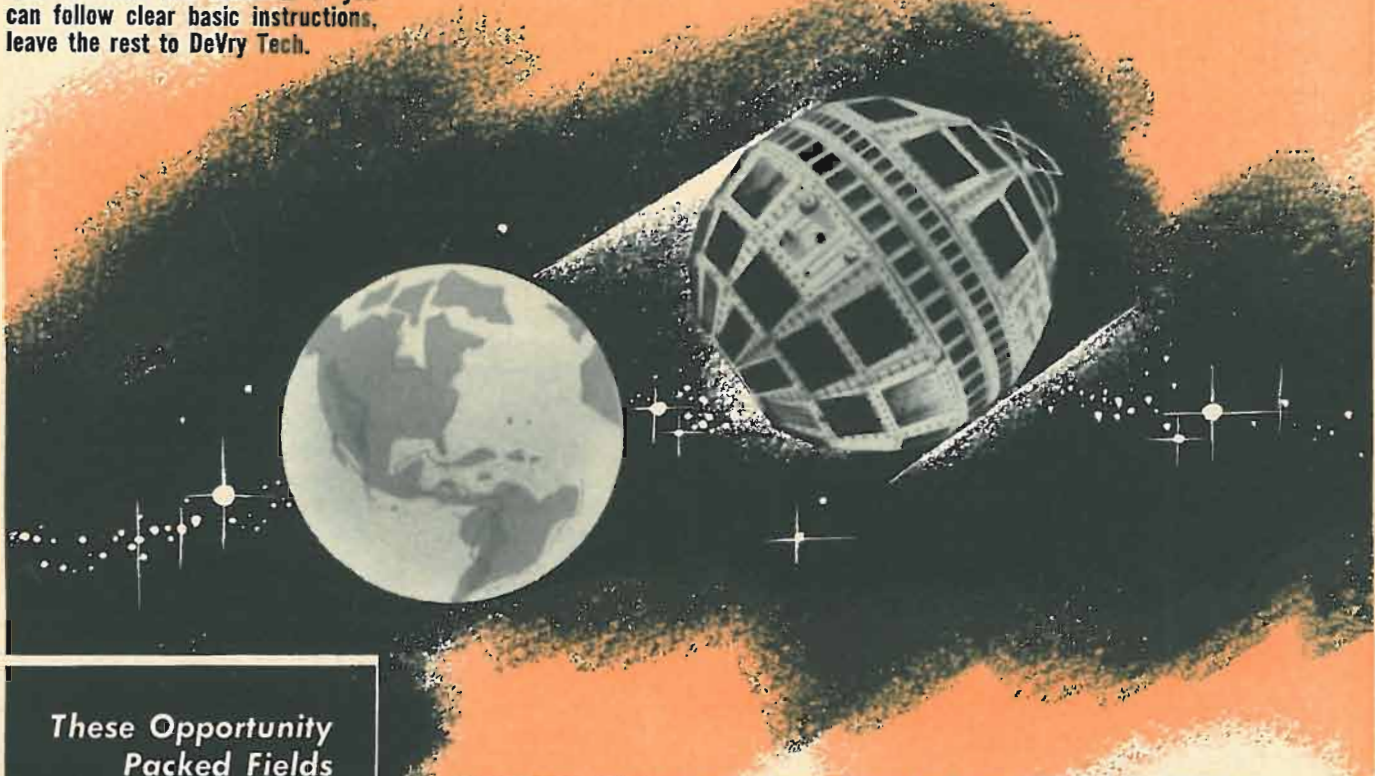

These Opportunity Packed Fields Need Skilled Men

- Space & Missile Electronics
- Television & Radio Microwaves
- Automation Electronics Radar
- Communications Computers
- Broadcasting Industrial Electronics

DeVry Electronics Training Could Make Your Future "The Story of Your Life"

Electronics is a newer world of opportunity, challenge, and excitement to the man who wants to get somewhere and be somebody.

Why not send for facts which cost you nothing? Find out how this 32 year old training organization can help you prepare at home or in one of its big modernly equipped centers, in day or evening classes for a career which could prove to be the opportunity of a lifetime.

Here's more BIG NEWS. In order to enter our practical HOME STUDY DIVISION, a high school diploma is not necessary. No previous technical experience is required. Let the man who is eager to go places equal this opportunity if he can! When trained, you get the benefit of DeVry's Employment Service to help you get started or to advance in the field. Send for full facts NOW. We are sure you will be glad you did.

FREE!

2 Booklets
Mail Coupon Today



DeVRY TECHNICAL INSTITUTE
4141 Belmont Ave., Chicago 41, Ill., Dept. RE 11-T

Please give me your two free booklets, "Pocket Guide to Real Earnings" and "Electronics in Space Travel"; also include details on how to prepare for a career in Electronics. I am interested in the following opportunity fields (check one or more):

- | | |
|--|---|
| <input type="checkbox"/> Space & Missile Electronics | <input type="checkbox"/> Communications |
| <input type="checkbox"/> Television and Radio | <input type="checkbox"/> Computers |
| <input type="checkbox"/> Microwaves | <input type="checkbox"/> Broadcasting |
| <input type="checkbox"/> Radar | <input type="checkbox"/> Industrial Electronics |
| <input type="checkbox"/> Automation Electronics | <input type="checkbox"/> Electronic Control |

Name _____ Age _____

Address _____ Apt. _____

City _____ Zone _____ State _____

Check here if you are under 16 years of age.
Canadian residents: Write DeVry Tech of Canada, Ltd.
970 Lawrence Avenue West, Toronto 19, Ontario

2085

Accredited Member of National Home Study Council



DeVry - - - Tops in Electronics
Chicago — Toronto

BE PARTICULAR!



When you want the best transformer, insist on the proven standard of quality in the industry—Triad. The familiar red and white Triad box assures you of the highest quality material and exacting design specifications. Whether you want utmost performance out of a T.V. or hi-fi set, greater reliability for an industrial application or better amateur radio operation, take a tip from leading military and aero-space components designers and specify Triad.

Your local distributor offers over 1,600 off-the-shelf models including: audio, chokes, filament, instrumentation, modulation, output and transistor transformers. For T.V. replacement, there are yokes, fly-backs, vertical and power transformers to fit nearly every make and model. Check with your distributor for our latest T.V. replacement or Industrial Catalog, or write.



TRIAD DISTRIBUTOR DIVISION
A DIVISION OF LITTON INDUSTRIES
305 North Briant Street, Huntington, Indiana

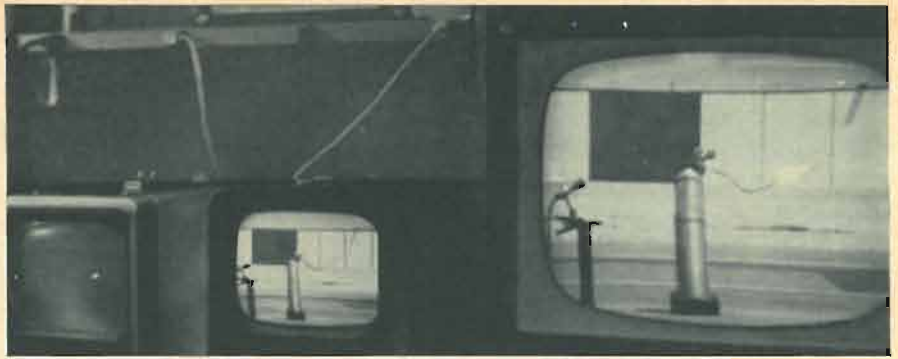

TV set at left is blank except for the small flame detected by the infrared camera. Middle picture is from standard TV camera which cannot see hydrogen flame. Two pictures are superimposed on monitor at right, which shows that a fire exists and pinpoints its location.

for rocket fuel, but it's now being used in the Centaur space vehicle, and other vehicles are being designed to use the high-energy fuel. The device that detects the invisible flame of burning hydrogen is another step toward increasing its usability.

The warning system uses a special lens which focuses infrared radiation on the vidicon tube of a TV camera. Beside the infrared camera is a standard camera, both covering the same field of view. The infrared picture, revealing the fire only, is superimposed over the scene viewed by the standard camera, displaying visually the location of the fire.

This system is expected to be used at hydrogen test facilities, around launching areas for hydrogen-fueled rockets and possibly as fire surveillance equipment aboard space vehicles.

Closed Circuit TV Adds Foreign Language Channel

TeleGuide, a closed-circuit TV system that operates in 41 hotels in

New York City, has added a foreign language service. From 7:30 am to 1 am daily, half-hour films describing the attractions of New York City to the tourists are presented in French, German, Italian, Japanese, Portuguese and Spanish. The program is on Channel 13, and is sponsored by Pan American Airways.

Magnet May Become Kitchen Tool

Green tomatoes, exposed to the south pole of a large magnet, ripen several days faster than nonmagnetized tomatoes, say Dr. A. A. Boe and Dr. K. Salunkhe of Utah State University.

Starting with green tomatoes, they exposed one group to the south pole of a magnet. These tomatoes were almost red in 11 days, while the nonmagnetized tomatoes were barely pink.

Magnetism's effect on organic substances is not a new idea. Louis Pasteur experimented with tartaric
(Continued on page 14)

Lunar Vehicle To Precede Astronauts



The odd-shaped vehicle is an exploration vehicle, designed by the Westinghouse Defense Center to make the arrival of astronauts on the moon safer, and to make the work more useful. It would arrive before the astronauts and roam the surface of the moon to locate landing sites for manned vehicles. Stereo television cameras would scan the moon's surface and transmit images back to earth. The little wheel ahead of the vehicle detects crevices, and is also designed to collect samples of the surface for analysis.

What Job Do You Want In Electronics?

Whatever it is, Cleveland Institute can help you get it!

Yes, whatever your goal is in Electronics, there's a Cleveland Institute program to help you reach it *quickly* and *economically*. Here's how: Each CIE program concentrates on electronics theory as applied to the solution of practical, everyday problems. Result . . . as a Cleveland Institute student you will not only learn electronics but *develop the ability to*

use it! This ability makes you eligible for any of the thousands of challenging, high-paying jobs in Electronics. Before you turn this page, select a program to suit your career objective. Then, mark your selection on the coupon below and mail it to us *today*. We will send you the complete details . . . without obligation . . . if you will act NOW!

Electronics Technology



A comprehensive program covering Automation, Communications, Computers, Industrial Controls, Television, Transistors, and preparation for a 1st Class FCC License.

First Class FCC License



If you want a 1st Class FCC ticket quickly, this streamlined program will do the trick and enable you to maintain and service all types of transmitting equipment.

Industrial Electronics & Automation



This exciting program includes many important subjects as Computers, Electronic Heating and Welding, Industrial Controls, Servomechanisms, and Solid State Devices.

Electronic Communications



Mobile Radio, Microwave, and 2nd Class FCC preparation are just a few of the topics covered in this "compact" program . . . Carrier Telephony too, if you so desire.

Broadcast Engineering



Here's an excellent studio engineering program which will get you a 1st Class FCC License and teach you all about Program Transmission and Broadcast Transmitters.

Mail Coupon TODAY For FREE Catalog

Cleveland Institute of Electronics

1776 E. 17th St., Dept. RE-85
Cleveland 14, Ohio

Please send FREE Career Information prepared to help me get ahead in Electronics, without further obligation.

How to Succeed in Electronics

CHECK AREA OF MOST INTEREST—

- | | |
|---|--|
| <input type="checkbox"/> Electronics Technology | <input type="checkbox"/> First Class FCC License |
| <input type="checkbox"/> Industrial Electronics | <input type="checkbox"/> Electronic Communications |
| <input type="checkbox"/> Broadcast Engineering | <input type="checkbox"/> _____
other |

Your present occupation _____

Name _____ Age _____
(please print)

Address _____

City _____ Zone _____ State _____

Approved for Veteran's Training under Korean GI Bill. RE-85

Cleveland Institute of Electronics

1776 E. 17th St., Dept. RE-85
Cleveland 14, Ohio



Accredited Member

The Revolution Is Growing

NEW LOG PERIODICS WILL FURTHER DEMOLISH EXISTING ANTENNA CONCEPTS.

One year ago, JFD introduced the LPV antenna based on the patented new log periodic formula of the Antenna Research Laboratories of the University of Illinois.

Television (and FM) reception hasn't been the same since.

This revolution that changed the course of antenna history is gathering greater momentum. Our Research and Development Antenna Laboratories in Champaign, Illinois has just released several entirely new Log-Periodic television and FM antenna designs for production.

The first of this exciting new generation of JFD Log-Periodics will bring to UHF, even more so, the same superb frequency-independent reception qualities that are working such wonders in VHF. The new UHF Log-Periodics will consist of two

antenna groups of three models each, and one UHF Indoor Log-Periodic. These dramatic new antennas will give you the flexibility you need in sensitivity and directivity to overcome the problems inherent in UHF signal behavior.

And if you're entering the rocketing FM stereo market, you can expect a solid boost from JFD in the form of new Log-Periodic antennas designed expressly for multiplex stereo.

Whether you are buying VHF, UHF, or FM antennas, we invite you to compare before you specify. Because after all is said and done about any antenna—at the moment of truth, the picture is the proof. Use, sell and install JFD Log-Periodics based on the formula discovered and patented by the Antenna Research Laboratories of the University of Illinois, and adapted for TV and FM by the JFD R & D Laboratories in Champaign, Illinois. See the difference it will make in your profits, performance and prestige.

JFD ELECTRONICS CORPORATION

Planning his future is one thing... providing for it is another

Can you do it without more education in electronics?

You don't want to accept second-best for yourself and those who depend on you. But you may have to unless you get more education. In electronics, you must learn more to earn more. And, because electronics keeps changing, you must keep learning. Stop—and you soon won't be worth what you're earning now.

Your job and family obligations may keep you from going to school. But you can continue your education in electronics beyond high school through a CREI Home Study Program in Electronic Engineering Technology.

CREI Programs cover all important areas of electronics including communications, servomechanisms, even nuclear engineering technology. They have just one purpose—to get you from where you are now to where you want to be in electronics. They do it by giving you the specialized knowledge of electronics that will make you worth more money to your employer.

You're eligible if you have a high school education and work in electronics. Our free book gives all the facts. Mail coupon or write: CREI, Dept. 1108-A, 3224 Sixteenth Street, N. W., Washington 10, D. C.

SEND FOR FREE BOOK

ELECTRONICS



The Capitol Radio Engineering Institute,
Dept. 1411-A, 3224 Sixteenth St., N. W.
Washington 10, D. C.

Please send me FREE book describing CREI Programs in Electronics and Nuclear Engineering Technology. I am employed in electronics and have a high school education.

Name _____ Age _____

Address _____

City _____ Zone _____ State _____

Employed by _____

Type of Present Work _____

Check: Home Study Residence School G. I. Bill

E-1

Accredited Member of the National Home Study Council

CREI
founded 1927



Pardon us while we change you into Santa Claus

Do your Christmas shopping early at your G-E Distributor's. He has lots of wonderful gifts that you can get with the purchase of General Electric tubes . . . gifts for your family, friends and favorite customers. And there're some you'll want for yourself . . . such as a tube caddy that

looks like fine luggage. You can also get Christmas cards designed only for service dealers . . . to mail to customers and friends.

See your General Electric Distributor and start packing your bag *today*. You're going to be a sensational Santa!

Start packing your bag!

These Kodak Flashfun camera outfits include everything that young photographers need: Hawkeye camera, film, clip-on neck strap, batteries, flash bulbs and instruction manual. They're yours when you buy G-E tubes.



Be good to yourself this Christmas. You can get these Armor Clad® tube caddies when you purchase G-E tubes. They look like fine pieces of luggage and the special vinyl coverings are longer lasting. They are reinforced with nickel plate at all stress points.



These Dick Tracy Power Jet Squad Guns by Mattel® will be a hit with any boys you know. They're automatic cap-firing guns that shoot a stream of water 35 feet... farther than any water guns ever made. Give one to any boy and then stand clear.



Little girls will go wild over these Mattel® Sister Belle talking dolls. They're 17" tall and have a rag body and plastic head. Each one says eleven different things that little girls like to hear... like "Let's play house," "Give me a kiss." No batteries needed.



These G-E electric carving knives will make a great gift for the lady of the house. They even slice through hot bread or hot meat with smooth precision. Get several from your G-E Tube distributor.

Get these Christmas cards... prepared especially for you. They're in color on heavy, high-gloss stock and show a cartoon of you adjusting a TV set to say "Happy Holidays." 50 cards and 50 envelopes to a box. Get yours now for early mailing.



ANOTHER ACCENT ON VALUE FROM G-E ELECTRONICS DISTRIBUTORS

Progress Is Our Most Important Product

GENERAL  ELECTRIC



NOW! CASTLE OFFERS YOU THE BIGGEST BARGAIN IN TV TUNER OVERHAULING!

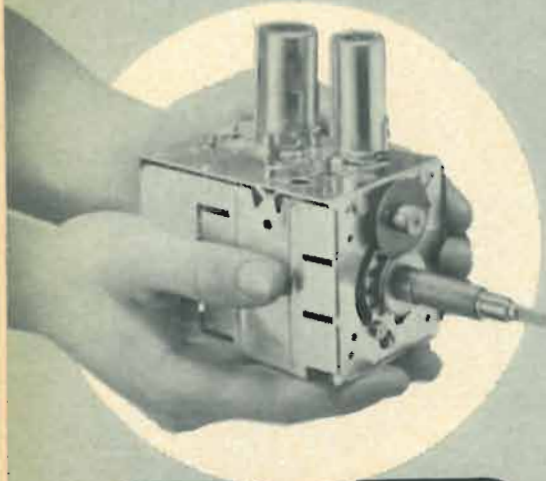

**ALL MAKES
ALL LABOR
AND PARTS
(EXCEPT TUBES)*
ONE PRICE**

9⁹⁵

ONE LOW PRICE INCLUDES ALL UHF,
VHF AND UV COMBINATION* TUNERS

In a decade of experience overhauling TV Tuners of ALL MAKES, Castle has developed new handling and overhauling techniques which give you . . .

Fast Service

A recent study at our Chicago Plant revealed that of all tuners accepted for overhauling, over 30% were completed and shipped within . . .
Seven Hours . . . all others within 24 Hours.

Simply send us your defective tuner complete; include tubes, shield cover and any damaged parts with model number and complaint. 90 Day Warranty.

Exact Replacements are available for tuners unfit for overhaul. As low as \$12.95 exchange. (Replacements are new or rebuilt.)

*UV combination tuner must be of one piece construction. Separate UHF and VHF tuners must be dismantled and the defective unit only sent in.

Pioneers in TV



Tuner Overhauling.

CASTLE

TV TUNER SERVICE, INC.

5715 N. Western Ave., Chicago 45, Illinois
653 Palisade Blvd., Cliffside Park, N. J.
Canada: 136 Main St., Toronto 13, Ontario

*Major Parts are additional in Canada

(Continued from page 8)

acid a century ago, concluding that the earth's magnetic field altered the arrangement of atoms in molecules.

Three years ago, magnetism was found to spur the growth of germinating seeds. This effect was named "magnetotropism." Its cause, Drs. Boe and Salunkhe suggest, is that a magnetic field quickens an enzyme system and thus respiration.

Dc Through GaAs Generates Microwaves

Microwaves can be generated by passing electric current through a block of gallium arsenide at room temperature, reports J. B. Gunn of IBM's Thomas J. Watson Research Center. The gallium arsenide maser has produced as much as 1/2 watt output at 1 gc, and oscillations have been produced from 0.5 to 6.5 gc.

Mr. Gunn discovered the effect while measuring the room-temperature resistivity of n-type gallium arsenide as a function of applied electric field. He found that resistivity increased abruptly at a field of about 2,000 volts/cm, and the current passing through the smaller samples began to oscillate coherently at high frequency.

The phenomenon depends to a great extent on the length of the specimen. Specimens longer than about .02 cm produce random oscillations, while the frequency of coherent oscillations in the shorter specimens is inversely proportional to their length.

Computer Makes Movies For Satellite Research

An ingenious way of visualizing the motions of an orbiting communications satellite has been worked out

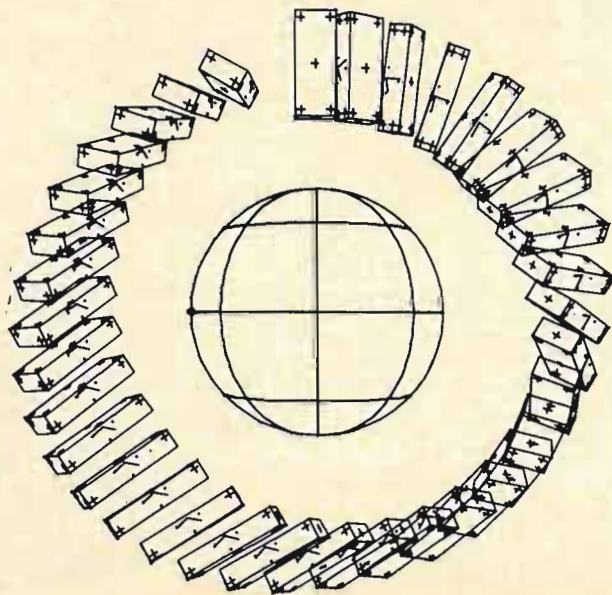

These closely-spaced drawings of a domino-shaped box, projected rapidly one after another, produce a moving picture showing how the box would orbit in space. The figure at center represents the earth.

by Bell Labs scientists, to help in studies of such satellites. An IBM 7090 is programmed to generate a tape containing the data necessary for describing positions and attitudes of the orbiting satellite. This tape is then fed to a General Dynamics/Electronics SC 4020 recorder, which converts the digital data into line drawings on the face of a special cathode ray tube. Images on the face of the tube are photographed by a motion picture camera. The film, when projected, depicts the motion of the satellite yawing and turning over, and showed how undesired motion can be prevented by positioning the gyro stops properly.

CALENDAR OF EVENTS

1963 National Electronics Conference, Oct. 28-30; McCormick Place, Chicago.

1963 (Canadian) High Fidelity Music Show, Oct. 30-Nov. 2; Park Plaza Hotel, Montreal.

9th Annual Conference on Magnetism and Magnetic Materials, Nov. 12-15; Chalfonte-Haddon Hall, Atlantic City, N.J.

International Exhibition of Measurement, Control, Regulation and Automation (MESUCORA), Nov. 14-21; Paris, France.

14th National Conference on Vehicular Communications, Dec. 5-6; Adolphus Hotel, Dallas, Tex.

39th Annual Convention, National Association of Educational Broadcasters (NAEB), Nov. 17-20; Milwaukee, Wis.

16th Annual Conference on Engineering in Medicine and Biology, Nov. 18-20; Lord Baltimore Hotel, Baltimore, Md.

Engineers Sometimes Slighted, Says NASA Spokesman

Scientists too often get credit for work done by engineers, said Dr. Hugh L. Dryden, NASA's Deputy Administrator, to the New Jersey Society of Professional Engineers.

"Engineers are only too rarely associated in the press with the great accomplishments of recent times," he said, referring to the atomic bomb, nuclear power plants and satellites,

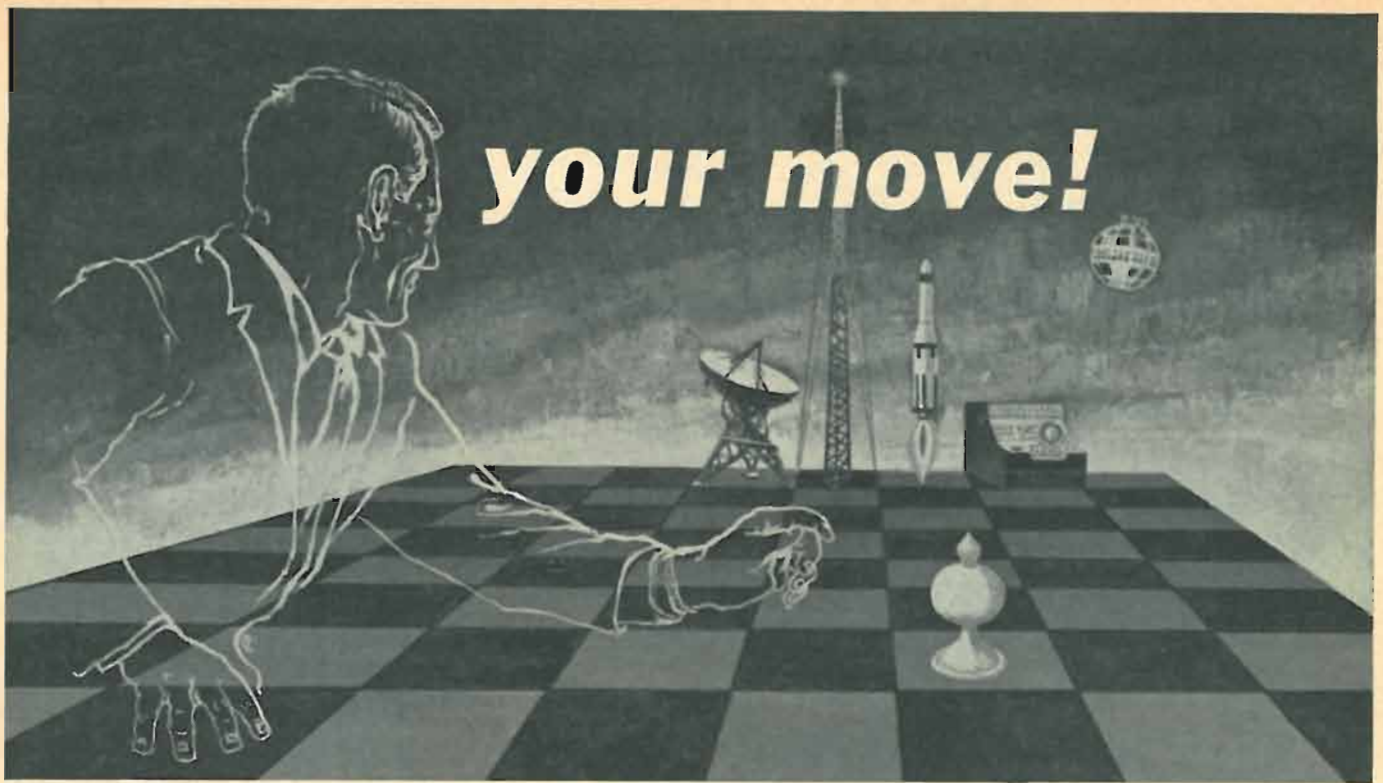

The move into electronics is your decision. **GRANTHAM SCHOOL OF ELECTRONICS** makes your move easier . . .

. . . easier by teaching you electronics in a logical, step-by-step manner, preparing you for employment as an electronics technician or engineer.

Grantham School of Electronics offers training *in the classroom, in the laboratory, and by correspondence*, as explained below.

WHAT Training is Offered

The entire Grantham electronics training program is divided into a series of *sections* or *levels*, as follows:

Section IA "begins at the beginning," with the assumption that the student has no previous knowledge of electronics. It prepares him to pass all F.C.C. examination required for a *first class* radiotelephone license.

Section IB is a laboratory training program which gives the student *practical experience* in the operation and maintenance of electronic equipment. Practical lab training is most valuable to the student who understands theoretical concepts upon which it is based. Therefore, Section IB is offered to Grantham students after they have completed Section IA.

Section II begins where Section IB ends, and trains the student in advanced electronics, usually while he is

employed as an electronics technician. Section II prepares the student to advance in both status and income.

WHERE and HOW Training is Offered

Grantham School of Electronics was founded in August of 1951, in Los Angeles, California. Since that time, new divisions of the School have been opened in several other locations. In addition to the Headquarters Office (located in Los Angeles), there are now *four teaching divisions*. Three of these (in Los Angeles, Seattle, and Washington, D.C.) offer resident classroom training, and the fourth (in Kansas City, Mo.) offers home study training and resident laboratory training.

Grantham teaches more electronics in less time, because the Grantham Method is engineered with the student in mind.

Write for Free Brochure

Your future depends on you. The move into electronics must be your decision. An important first-step in this direction may be to write for our 44-page brochure. It's free for the asking — it's *your move*.

Prepare for Employment and/or Advancement in Electronics
by training with



GRANTHAM SCHOOL OF ELECTRONICS



1505 N. Western Ave.
Los Angeles 27, Calif.
(Phone: HO 7-7727)

408 Marion Street
Seattle 4, Wash.
(Phone: MA 2-7227)

3123 Gillham Road
Kansas City 9, Mo.
(Phone: JE 1-6320)

821 - 19th Street, N.W.
Washington 5, D. C.
(Phone: ST 3-3614)

Accredited Member, National Home Study Council

(Mail in envelope or paste on postal card)

To: **National Headquarters Office
Grantham School of Electronics
1505 N. Western Ave., Hollywood 27, Calif.**

Gentlemen:

Please send me your free booklet describing electronic training. I understand that this does not obligate me in any way.

Name _____ Age _____

Address: _____

City _____ State _____

I am interested in: Home Study Classroom Training 34-S

The U-Boost can't clear up every UHF reception problem

but when it does—



wow!

There has never been a booster made, UHF or VHF, that does everything for everybody—in every reception area. Take the Blonder-Tongue U-Boost, for example. If you are already using an amplified UHF converter, or a “hot” new all-channel TV set . . . forget it. The U-Boost is not for you. But if you're the one out of three who is suffering with poor pictures, and you're using an ordinary converter or all-channel set, the U-Boost can make a substantial difference. It can melt away “snow”. It can make blacks blacker, whites brighter—give you sharper, more

sparkling pictures than you've ever seen on your tired old set.

Vital statistics on the U-Boost: • triples antenna signal voltage (gain 10 db) • just a turn of dial pinpoints desired UHF channel from 14 to 83 • amplifies signal before conversion for best signal-to-noise ratio • easy to install (AC receptacle, patented 300 ohm striplless twinlead terminals) • handsome styling to match the new Blonder-Tongue UHF converters. **BLONDER-TONGUE U-BOOST, only \$34.95** See your Blonder-Tongue distributor.

Blonder-Tongue makes a complete line of UHF products: the new UHF DART, log-periodic antenna; ULTRAVERTER UHF converters; U-BOOST and the ULTRABOOSTER, mast mounted preamplifier.

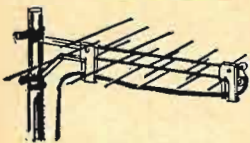

engineered and manufactured by
BLONDER-TONGUE
 9 Alling St., Newark, 2 N. J.

while “engineering has become the full and active partner of science in the exploration of this newest frontier. We must bring before the public the great engineers of our day,” he concluded, “as persons identified with creative works, and the contributions of these works to human welfare.”

Telcan Coming to US

Despite the skeptical response of many to *Telcan*, the prospective British video recorder, it may be introduced into this country shortly. Cinerama, Inc. has signed a contract under which it will assist in further development of the Telcan recorder in exchange for certain manufacturing and marketing rights in this and other countries.

A spokesman for Cinerama suggested that a prototype may be shown in the United States within the next six weeks and stated that the finished instrument might “be sold in every type of store now selling tape recorders and TV sets.” A price of “under \$200” was suggested.

Brief Briefs

A silicon-carbide injection laser that emits continuously at room temperature is reported by Tyco Laboratories of Waltham, Mass.

Zenith Sales Corp. reports a new 19-inch hospital TV that supplies AM and FM radio and recorded music from the hospital communications system, as well as regular TV entertainment.

By special agreement with the Laguna Indians of Central New Mexico, Burnell Co. will construct a \$1,000,000 research and development firm on the Laguna reservation near Albuquerque.

RCA has announced a new computer, the 3301, with a “scratch-pad” memory operating at 250 nanoseconds, about twice as fast as any previous computer.

G-E's new junction laser operates continuously at a power output of more than 1 watt—a tenfold improvement over the output of ruby and gas lasers.

Radars for pleasure boats are taking a high place in the marine electronics market. FCC licenses for radars installed on US yachts and commercial vessels in the first quarter of 1963 jumped 47% over the same period last year.

END

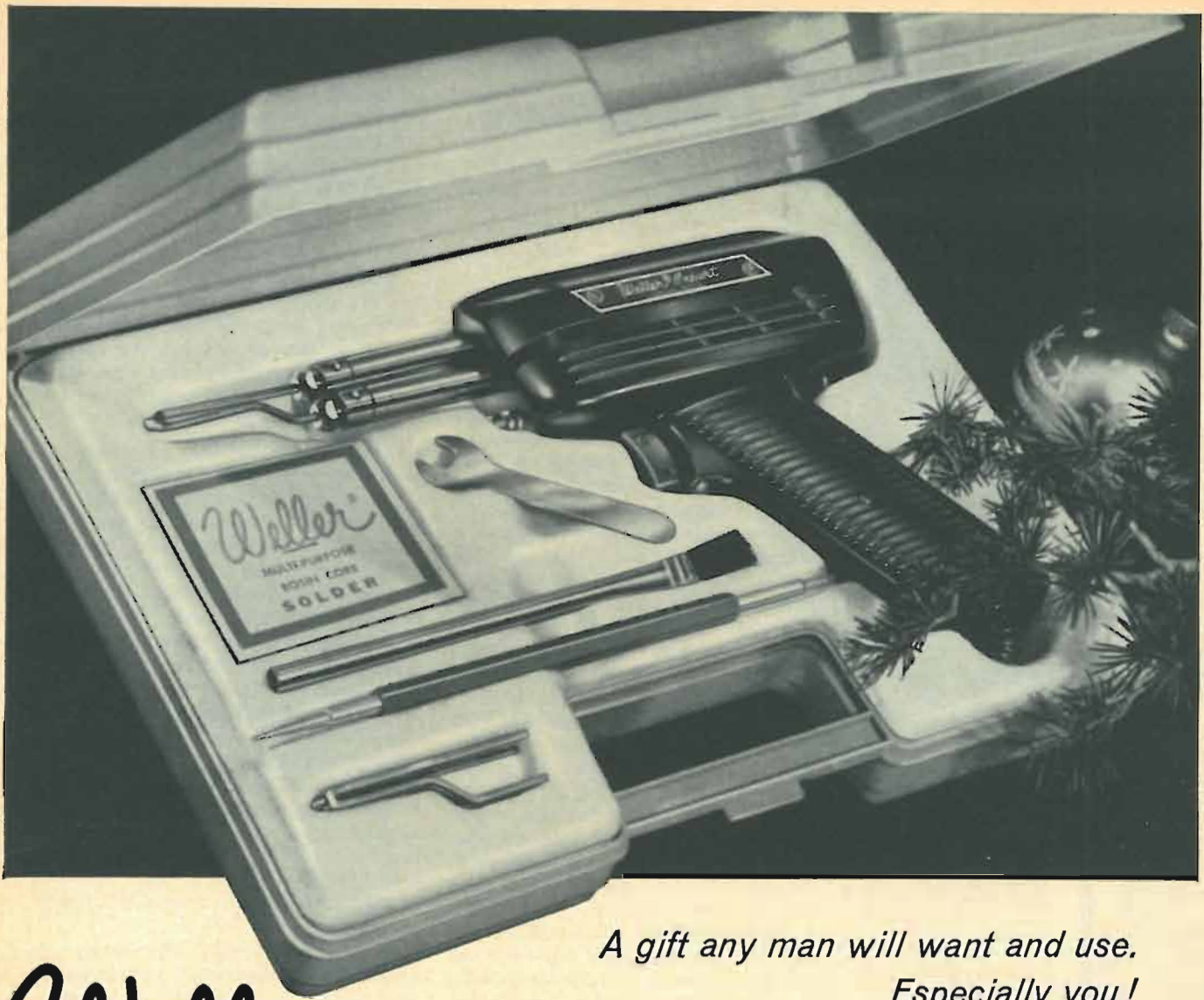

*A gift any man will want and use.
Especially you!*

Weller® Dual Heat Soldering Gun Kit

Everything that's needed for quick, easy soldering and scores of household repairs. Features the same Weller "Expert" Dual Heat Gun that's used by professional servicemen and homecrafters the world over. Pull the trigger—tip heats instantly and spotlight illuminates work. Two trigger positions give a choice of two soldering temperatures. You can switch instantly to high 140-watt or low

100-watt heat to suit the job. By using high heat only when necessary you prolong tip life. Tip is made of copper for superior heat transfer and premium plated for rigidity and long life. Included: 3 soldering tips, tip-changing wrench, flux brush, soldering aid, solder. And everything is in a colorful, break-proof plastic carrying case. Model 8200PK. **\$8⁹⁵**_{list}
Weller Electric Corp., Easton, Pa.

For hi-fi kit building



For electrical repairs



For mending metal



For many other jobs



new Allen hex screwdrivers

work faster, easier . . . reach where wrenches won't go



fixed handle SCREWDRIVERS
 11 hex sizes
 .050" to 1/2"
 Precision formed, alloy steel blades
 Shockproof, breakproof, amber plastic (UL) handles

detachable BLADES
 8 hex sizes
 1/8" to 3/16"
 Fit all "99" Series handles
 Available singly — as a set of six in free plastic pouch — or in roll kit with handle

WRITE FOR BULLETIN N763



XCELITE, INC., 10 BANK ST., ORCHARD PARK, N. Y.
 Canada: Charles W. Pointon, Ltd., Toronto, Ont.

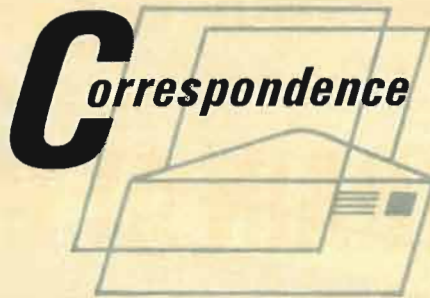

Long, Fat, Fragile Shoestring

Dear Editor:

Jack Darr's "Start Service on a Shoestring" (R-E, July, p. 46) does little more than *insult* service shop owners.

The statement "Fact is, I don't know of a better business for a young feller" is a direct contradiction of statistics. Service business failures are among the highest. Insufficient capital and poor record-keeping are two prime causes. Your neophyte is starting out in a complex repair business with both those strikes against him. There was no mention of bookkeeping. Or won't he need any?

"You can use a well stocked tube caddy in place of a tube tester . . ." With today's multiplicity of tube types that caddy would need wheels!

Shop rent not being itemized implies that your man is setting up shop at home. He'd better check zoning ordinances first. He'll have to pay business rates on phone and on power, unless he has a separately metered line installed to his shop. His fire insurance may become void. If he owns his home he should take out a contractor's liability policy. Our courts keep quite busy with lawsuits.

One small item—hardly worth mentioning?—"Fuse assortment in a plastic box." That should cost no more than \$25. Or will your man use the universal fuse — tinfoil? Perhaps 85% of TV troubles *are* caused by faulty tubes, but your man won't service many of these. Someone told the druggist how much money he could make selling tubes at an unrealistic markup, so he got into TV service with no investment beyond floor space.

The other 15% will surely test the "young feller's" mettle, with no spare parts and no schematics. He'll get to know his distributor quite well. At 10 cents a mile for all that driving.

"Rent, utilities, transportation and other stuff" are brushed aside as presenting "too many variables to even get a halfway useful answer . . ." The ex-Young Ham had better have such an answer or he'll quickly join a vast army of embittered part-timers.

The low-price competition of these moonlighters collecting no state sales tax, paying no county personal property tax and no Federal income tax has forced many men with 10 years' experi-

ence into other fields. The public is the loser. This constant turnover of men entering and leaving TV service serves no one except the electronics schools and test equipment manufacturers.

ELMER C. FISCHER

Fischer TV Service
 Independence, Ohio

Jack Darr Replies

[Yet our readers wouldn't have felt too complimented, either, if the Old Timer had suggested that only a fool would go into—or stay in—the service business. Anyway, we gave Jack Darr a copy of Mr. Fischer's letter, and below is his reply.—*Editor*]

I fully realize the difficulties of which Mr. Fischer speaks, having had personal experience in large cities and small towns in just such projects, and having aided and abetted quite a number of young men like the XYH in similar enterprises. As for his "direct contradiction of statistics," I can't help quoting the old saw about the three kinds of lies—"Lies, dam' lies and statistics!!" The "statistics" used in the article all came from personal experience.

On his contention about "insufficient capital and record-keeping," I agree. I gave the XYH fits about that, if not in the article, at least in person! As to the omission, I can only say that there is room in a short article like this for only a few things; we hope to have another, going farther into this subject, in a forthcoming issue.

The "well-stocked tube caddy" is again personal experience, and, as stated very plainly, intended merely as a starter. By the way, if you *test* a tube, and don't have one like it, isn't it just as far back to the shop? The fuse assortment I carry, which has covered all sets for several years, cost me something like \$7.50.

I would question Mr. Fischer's "statistics" once again on his *percentages* of "only a tube" jobs that are taken away by drug-store tube-testers. Around here, and in quite a few other towns I know of, it is exactly *reversed*, if not more than that! Frankly, before the DIY tube testers were born, we had the same percentage of do-it-yourselfers. Then, they came in to your shop, with all the tubes from their TV set in a paper sack, and said, "You advertised free tube testing—check these!"

Some 27 tubes later, you found a dead 5U4. As you reached up for a new one, he said, "Did you say 5U4? Let me write that down. I don't want to get the wrong one when I make out my order to Sears-Roebuck!" The drug-store has taken *that* business away from me, and I'm just about tickled to death! These are the people we'll always have with us, but once again, thank goodness, they are a very *small* percentage. (They also are

(Continued on page 24)



For Your Career in TV-Radio
Electronics-Automation
TRAIN AT HOME WITH
THE LEADER **nri**

9 WAYS to assure advancement or turn your hobby into a new career **TURN PAGE**

Perhaps you're working in Electronics now but feel the need for an FCC License or more math . . . perhaps you're a hobbyist trying to decide between a career in Automation and one in Communications . . . perhaps you're a beginner who left school early, but you're thinking about the career possibilities of building a spare-time or full-time business of your own servicing radio and television sets. Worker, hobbyist or beginner, whatever your desire, there is training for you among the nine specialized courses NRI offers. Read the descriptions of NRI training on the other side of this page, about successes of NRI graduates, about NRI training equipment included at no extra cost. Then, cut out and mail postage-free form for FREE NRI CATALOG.

CUT OUT AND MAIL TODAY

FIRST CLASS
PERMIT
NO. 20-R
(Sec. 34.9, P.L.&R.)
Washington, D. C.

BUSINESS REPLY MAIL

No Postage Stamp Necessary If Mailed In The United States

POSTAGE WILL BE PAID BY

nri

National Radio Institute
3939 Wisconsin Avenue
Washington 16, D. C.

Join the Thousands Who Trained for Success with NRI

CHOOSE YOUR CAREER

nri Thousands of NRI graduates throughout the U. S. and Canada are proof that it's practical to train at home. NRI graduates are in every kind of Electronics work. Here are five typical success stories. Catalog tells more about what NRI graduates do and earn. Mail the postage-free form.



"I HAD A PROMOTION BEFORE I FINISHED the Communications Course," reports Ronald L. Ritter, 113 Helms Dr., Eatontown, N. J., "as well as the satisfaction I could handle a job of responsibility." He works for the U. S. Army Electronic Laboratories, Ft. Monmouth. He received one of the highest grades in Army proficiency tests.

SPARE TIME EARNINGS OF \$3,800 in one year reported by Emerson A. Breda, 1620 Larkin Ave., San Jose 29, California. He has a Radio-TV Servicing shop as completely equipped as you would want for a full-time business. Says Mr. Breda, "The training I received from NRI is the backbone of my progress."



"THE FINEST JOB I EVER HAD" is what Thomas Bilak, Jr., RFD 2, Cayuga, N. Y., says of his position with the G. E. Advanced Electronics Center at Cornell University. He writes, "Thanks to NRI, I have a job which I enjoy and which also pays well."

HAS SERVICE BUSINESS OF HIS OWN. Don House, 3012 2nd Place, Lubbock, Texas, went into his own full-time business six months after finishing the NRI Radio-TV Servicing course. "It makes my family of six a good living," he states. "We repair any TV or Radio. I would not take anything for my training with NRI. I think it is the finest."



MARINE RADIO OPERATOR is the job of E. P. Searcy, Jr., 1916 Fern St., New Orleans, La. He works for Alcoa Steamship Company, has also worked as a TV transmitter engineer and holds FCC Radio-Telephone License. He says, "I can recommend NRI very highly."

Special Equipment Included

The NRI "train-by-doing" method, using special training equipment, is the time-proved way to assure advancement or turn your hobby into a new and profitable career in the fast-growing fields of TV-Radio, Electronics-Automation. Most NRI courses include special equipment *at no extra cost*. You build circuits and work experiments. Theory you study comes to life in an interesting, easy-to-grasp manner. NRI catalog pictures and describes equipment you get. Mail the form for more facts about NRI courses, job opportunities, trial plan. NRI TRAINING, Washington 16, D. C.



SEE OTHER SIDE

Cut Out and Mail—No Stamp Needed



NATIONAL RADIO INSTITUTE
3939 Wisconsin Avenue
Washington 16, D.C.

3 F

The Amazing Field of Electronics



Please send me your Electronics, Radio-TV catalog with complete information on 9 ways to train at home. (No cost or obligation. No salesman will call)

Name _____ Age _____
(Please Print)

Address _____

City _____ Zone _____ State _____

ACCREDITED MEMBER NATIONAL HOME STUDY COUNCIL

- 1 TELEVISION-RADIO SERVICING**
Learn to service black-and-white and color TV sets, AM-FM radios, stereo hi-fi, PA systems, etc. A profitable, interesting field for part-time or full-time business of your own.
- 2 INDUSTRIAL-MILITARY ELECTRONICS**
Learn Principles, Practices, Maintenance of Electronic equipment used today in business, industry, defense. Covers Electronic controls and measurement, computers, servos, telemetry, multiplexing, many other subjects.
- 3 COMPLETE COMMUNICATIONS**
A comprehensive training program for men seeking careers operating and maintaining transmitting equipment in Radio-TV Broadcasting or mobile, marine, aviation communications. Prepares you for FCC License.
- 4 FCC LICENSE**
Prepares you quickly for First Class License exams. Every communications station must have one or more FCC-licensed operators. Also valuable for Service Technicians. You train at home.
- 5 BASIC ELECTRONICS**
An abbreviated, 26-lesson course covering Automation-Electronics, Radio-Television language, components and principles. Ideal for salesmen, hobbyists and others who find it valuable to be familiar with the fundamentals of this fast-growing industry.
- 6 MATH FOR ELECTRONICS**
A short course package of carefully prepared texts that take you from basic arithmetic review through graphs and electronic formulas. Quick, complete and low in cost.
- 7 AVIATION COMMUNICATIONS**
For men who want careers working with and around planes. Covers direction finders, ranges, markers, loran, shoran, radar, landing systems, transmitters. Prepares you for FCC License exams.

- 8 MARINE COMMUNICATIONS**
Shipboard transmitting equipment, direction finders, depth indicators, radar are all covered in this course. You prepare for your First Class Radiotelephone License with Radar Endorsement.
- 9 MOBILE COMMUNICATIONS**
Training in installation and maintenance of mobile equipment and associated base stations like those used by fire and police departments, taxi companies, etc. Prepares you for your First Class FCC License exams.

CUT OUT AND MAIL FOR FREE CATALOG

EXPERIMENTER, SWL or RADIO AMATEUR

Select your receiver, transmitter, or VFO from easy-to-build International AOC kits.

Simple step-by-step instructions show you how to assemble factory prewired units. Designed for top performance at a low cost!

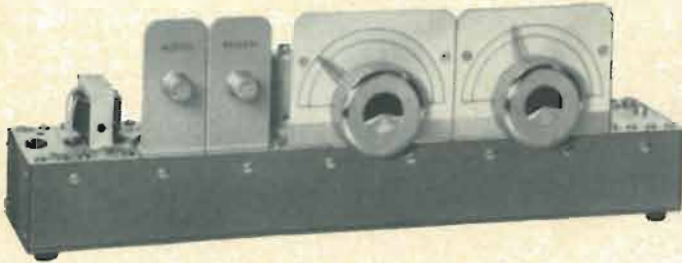

RECEIVER KITS

This new line of International receiver kits cover a wide range of amateur, citizens band and special frequencies. Designed for AM, CW, or SSB reception, this basic receiver using a superheterodyne circuit* with regenerative second detector may be expanded to a more elaborate receiver by the addition of other Add-On-Circuits. Sensitivity usable to below 10 microvolts for voice and 1 microvolt for code. Nuvistor rf amplifier, mixer, oscillator, I.F. transformer, detector/1st audio, and power audio amplifier. Tube lineup: 6DS4 nuvistor, 6BE6, 6U8, 6AQ5. Shipping weight: 15 lbs.



TRANSMITTER KIT

A compact package delivering a plate input of 50 watts for CW operation on 80 or 40 meters. 12BY7 crystal oscillator—6DQ6 power amplifier, Pi-network final. When used with AOR-44 receiver, transmitter operates from receiver power supply. Meter and TR switch.

AOT-50 transmitter kit less power supply and key, but with one 40 meter novice band crystal. Shipping weight: 5 lbs. **\$35.00**



Receiver kit includes 4" speaker and power supply.

Kit	Frequency	Price
AOR-40	Special	\$69.00
AOR-41	150 kc — 450 kc	62.50
AOR-42	2 mc — 6 mc	62.50
AOR-43	6 mc — 18 mc	62.50
AOR-44	80 meter/40 meter	62.50
AOR-45	15 meter/10 meter	62.50
AOR-46	6 meter	66.50
AOR-47	2 meter	66.50
AOR-48	Citizens 27 mc	62.50

*AOR-41 uses a tuned rf circuit with 6BA6

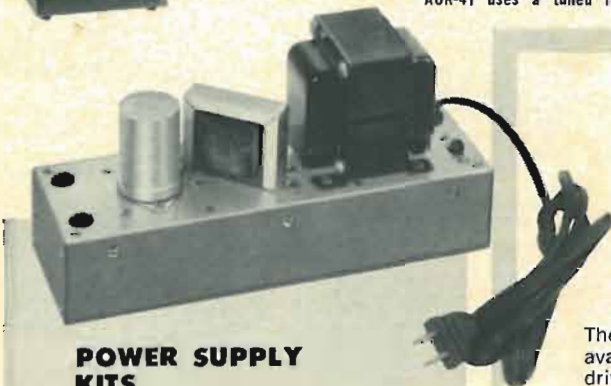

POWER SUPPLY KITS

AOP-100 350 volts, 150 ma intermittent or 100 ma continuous service, 6.3 volts @ 5 amps. Shipping weight: 8 lbs. **\$18.50**

AOP-200 650 volts, 250 ma intermittent or 200 ma continuous service, 6.3 volts @ 10 amps. Shipping weight: 10 lbs. **\$32.50**

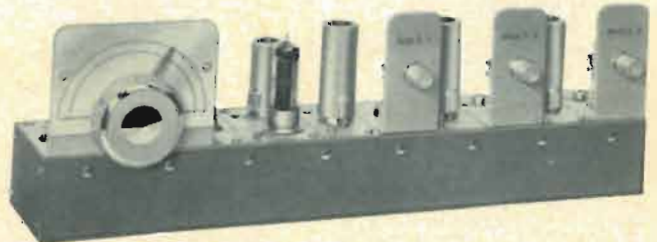

VFO KITS

The International AOF series of variable frequency oscillator kits is available in three versions. For example, the AOF-91 kit is a complete driver unit to be used with 6 meter and 2 meter transmitters. Approximately .5 watt of power is available on both bands. Tube lineup: 6BH6 oscillator, OB-2 voltage regulator, 12BY7 buffer-amplifier/multiplier. Shipping weight: 5 lbs.

Kit	Frequency	Price
AOF-89	VFO 8 mc — 9 mc and buffer	\$22.00
AOF-90	VFO 8 mc — 9 mc plus buffer multiplier and 6 meter output	29.00
AOF-91	VFO 8 mc — 9 mc plus buffer multiplier, 6 meter/2 meter output	36.00

INTERNATIONAL CRYSTAL MFG. CO., INC.
18 NORTH LEE, OKLAHOMA CITY, OKLAHOMA

Please ship _____

I enclose \$ _____ Send free catalog _____

Name _____ (print)

Address _____

City _____ Zone _____ State _____

Include sufficient remittance to cover postage. See shipping weight.

**INTERNATIONAL
CRYSTAL MFG. CO., INC.**

18 NORTH LEE • OKLAHOMA CITY, OKLAHOMA

TOP PERFORMANCE AT ROCK-BOTTOM COST

With money-saving RCA Electronic Instrument Kits



RCA WV-76A (K) HIGH SENSITIVITY AC VTVM KIT

Measures AC Voltages .0002-Volt to 500 Volts
Doubles as a Preamplifier

An exceptional two-way kit value! As a high sensitivity AC VTVM the new RCA WV-76A measures AC voltages from 10 mv to 100 v full-scale in nine overlapping ranges; special "low-cap" switch on probe extends upper range limit to 500 v. As a flat-response preamplifier, it provides a 38 db maximum gain on the 10 mv range.

- Flat frequency response ± 1 db from 10 cps to 1.5 Mc with probe on "direct"; and from 10 cps to 500 kc with probe switched to "low-cap."
- High input impedance for accurate measurements in circuits sensitive to loading.
- Easy-to-use, direct-reading decibel scales.
- Pre-assembled shielded probe and cable, all-metal case eliminate stray pickup.
- Large power-supply filter minimizes hum.
- Compact, lightweight, portable.

Kit price: only \$57.95* • Factory-wired and calibrated: \$79.95*



RCA WV-98C (K) SENIOR VOLTOHMYST® KIT

Special 0.5-volt DC range for transistor circuits. Measures AC voltages 0.2 to 4200 peak to peak—including complex waves—and 0.1 to 1500 rms; DC voltages 0.01 to 1500; Resistances 0.2 ohm to 1,000 megohms. Pre-assembled, AC/DC-OHMS probe. Big 6½" meter. AC, DC accuracy: $\pm 3\%$ FS.

Kit: \$57.95* Factory Wired: \$79.50*



RCA WV-77E (K) VOLTOHMYST® KIT

Separate 1.5-volt rms and 4-volt peak-to-peak scales for accurate low AC measurements. Measures AC and DC voltages to 1500 volts, resistances from 0.2 ohm to 1,000 megohms. Ultra-slim probes, long flexible leads.

Kit: \$29.95* Factory Wired: \$43.95*



RCA WV-38A (K) VOLT-OHM-MILLIAMMETER KIT

Accurately measures AC and DC volts, ohms, DC current, and decibels. Special 0.25-volt and 1.0-volt DC ranges. 5¼" meter in plastic case—no glass to crack or shatter. Jacks located below switches to keep leads out of the way. Spring clips on handle to hold leads.

Kit: \$29.95* Factory Wired: \$43.95*



RCA WO-33A (K) PORTABLE 'SCOPE KIT

For trouble-shooting B&W and color TV, radio, hi-fi, tape recorders. Exceptional gain and bandwidth (response to 5.5 Mc) for toughest jobs. Scaled graph screen and internal calibrating voltage source for direct reading of peak-to-peak voltage. Supplied with direct/low-cap shielded cable.

Kit: \$79.95* Factory Wired: \$129.95*

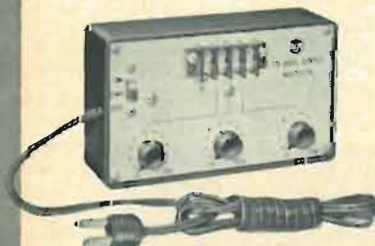

RCA WG-307B (K) TV BIAS SUPPLY KIT

Three separate DC output voltages each adjustable from 0 to 15 volts provide bias voltages for aligning RF, IF and other circuits of color and black-and-white TV receivers. Kit: \$11.95*

See them all at your Authorized RCA Electronic Instrument Distributor

For specifications and technical data on individual kits, write Commercial Engineering, Section K-39-W, RCA Electronic Components and Devices, Harrison, N. J.



RCA WE-93A (K) TRANSISTOR-RADIO DYNAMIC DEMONSTRATOR KIT

Working six-transistor radio on color-coded panel board for instructional and demonstration purposes. Removable components. Includes 304-page RCA transistor manual containing detailed data on 373 semiconductor devices, representative transistor circuits, basic theory. Kit: \$39.95*



RCA WE-95A (K) VOLT-OHM-MILLIAMMETER DYNAMIC DEMONSTRATOR KIT

A functional, accurate V-O-M laid out on panel board for instruction and demonstration. Each basic circuit separately color coded. Measures AC volts, DC volts, DC current and ohms. One of the most useful test instruments in electronics. Kit: \$37.95*

*User price (optional)



The Most Trusted Name in Electronics

Get this **BIG BONUS** with your purchase of a **PHOTOFACT® Library!**

FREE!

**this 4-drawer deluxe
FILE CABINET worth \$38.95
with your purchase of a
PHOTOFACT LIBRARY
consisting of 180 SETS**



**OFFER
AVAILABLE
ONLY UNTIL
MAY 15, 1964**

own the world's finest TV-radio service data

Now, more than ever, it pays to own a PHOTOFACT Library—the time-saving troubleshooting partner that helps you earn more daily. Now, you can start or complete your PHOTOFACT Library the special Easy-Buy way, and get absolutely FREE with your purchase, the deluxe 4-drawer File Cabinet, plus valuable extras described below!

OWN A PHOTOFACT LIBRARY THE EASY-BUY WAY:

- Only \$10 down
- 30 months to pay
- No interest or carrying charges
- Prepaid transportation
- Add-on privilege of a year's advance subscription to current Photofact on the same Easy-Buy contract
- Save 30¢ per Set—special \$1.95 price applies on Easy-Buy (instead of regular \$2.25 price)

PLUS: In addition to the deluxe File Cabinet, you get a complete Color TV Servicing Course, 2nd Class Radiotelephone License Course, Transistor Radio Servicing Course, and Test Equipment Guide!

4 Ways to Select Your PHOTOFACT Library

1. Complete your present PHOTOFACT Library
2. Order a PHOTOFACT "Starter" Library—180 Sets (Sets 301 to 480—coverage from 1955 to 1960—only \$11.33 per month).
3. Order by brand name and year—see the handy selection chart at your Distributor.
4. Order a complete PHOTOFACT Library—get FREE File Cabinets to accommodate the entire library, the Courses listed above, plus an 8-volume Set of "101 Ways" Test Instrument books worth \$18.50.

A PHOTOFACT LIBRARY PAYS ITS OWN WAY— ORDER TODAY AND GET THE FREE BONUS EXTRAS

See your Distributor for Easy-Buy Library details, or send coupon today! Ask also about a Standing Order Subscription to current PHOTOFACT—FREE File Cabinet also available!

**GET THE
DETAILS
NOW**

HOWARD W. SAMS & CO., INC.

Howard W. Sams & Co., Inc., Dept. 6-L3
4300 W. 62nd St., Indianapolis 6, Ind.

Send full information on Easy-Buy Plan



My Distributor is: _____

Shop Name _____

Attn _____

Address _____

City _____ Zone _____ State _____

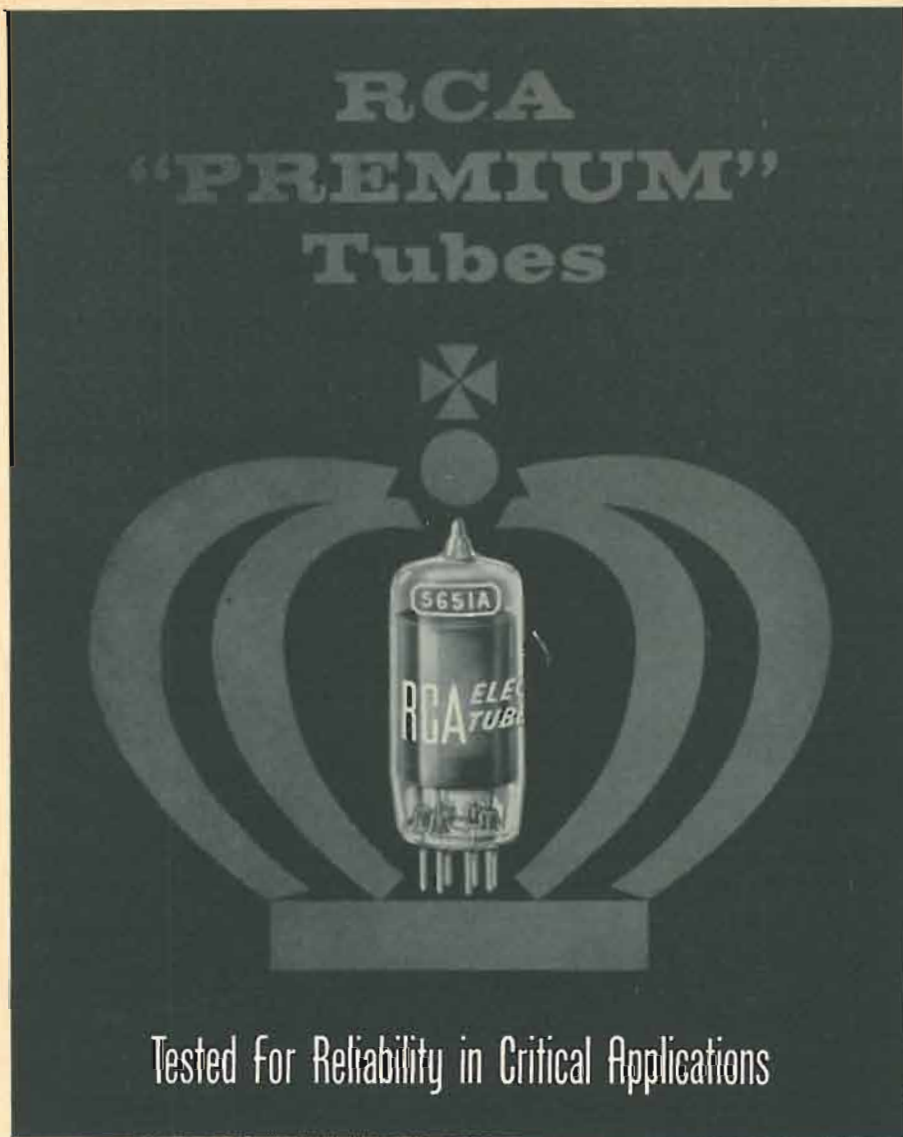

It's just good business...calling RCA "Premium" Tube into replacement action. They are designed to provide a high degree of responsibility in your critical, small-tube applications in military and industrial communications equipment.

RCA "Premium" Tubes withstand rigorous test conditions — proof of precise care in selection and inspection of materials, gauging of parts, and quality control. The RCA-5651A, for instance, features nickel-clad moly cathodes. This is a superior tube with regards to leakage. Another "Premium" type, RCA-5814A, comfortably meets required 1% failure rate per 1,000 hours on Air Force 2-Step Procurement Specifications.

When reliability counts, choose from more than 60 RCA "Premium" Tubes for amplifier, oscillator, rectifier, and voltage regulator service. Sold everywhere through RCA INDUSTRIAL TUBE DISTRIBUTORS.

RCA Electronic Components and Devices, Harrison, N. J.



The Most Trusted Name in Electronics

For name and address of your local distributor, call or write your nearest RCA Distributor Products Sales Office: NEW YORK, N. Y.: 36 W. 49th St., Murray Hill 9-7200; NEEDHAM HEIGHTS 94, MASS.: 80 "A" St., Hillcrest 4-8480; WASHINGTON 6, D. C.: 1725 "K" St., S. W., Federal 7-8500; ATLANTA, GA.: 134 Peachtree St., N. W., JACKSON 4-7703; CLEVELAND, OHIO: 1621 Euclid Ave., CHerry 1-3450; CHICAGO, ILL.: Merchandise Mart, 467-5900; DALLAS 7, TEXAS: 7901 Carpenter Freeway, MEIrose 1-3050; KANSAS CITY 14, MO.: 7711 State Line, EMerson 1-6462; LOS ANGELES 22, CAL.: 6801 E. Washington Blvd., RAymond 3-8361

continued from p. 18

the people who cause trouble by going to our distributors and buying parts wholesale!)

So, frankly, Mr. Fischer, I think you take entirely too dim a view of the whole situation! As I told the XYH, personally and in print, the result you get out of any endeavor of this kind depends entirely on how much of yourself you're willing to put into it; in other words, how hard you want to *WORK!* Also, if you're a poor businessman, you're going to fail, whether you're a grocer, TV technician or anything else! We're presuming that the XYH is smart enough to handle all of the other details, until proven otherwise.

Therefore, I still maintain that there is and always will be a place in our electronics industry for the individualist, *competent*, hard-working independent technician! This sounds just a little Pollyanna-ish, I know, but I still believe you'll find enough spirit left in our young men to let them make a success out of that old American dream of owning their own place!

JACK DARR

Honor Inventors

Dear Editor:

It greatly irks me and others in electronics to view the usual trash programs on TV, while those scientists and inventors who have made TV possible remain unhonored, impoverished and even driven to suicide from sheer ingratitude.

It certainly would be highly fitting if these men could occasionally be honored on a few programs. I believe that such programs could be made interesting enough to hold the average viewer's interest, thereby attracting enough sponsors to cover costs, profits and even an overdue donation for some meritorious inventors and widows, who are practically destitute.

DEXTER S. BARTLETT

Portland, Ore.

Not So Unusual, Maybe?

Dear Editor:

On page 92 of the July issue (Noteworthy Circuits) you call the power supply circuit "unusual." I patented this circuit more than 15 years ago (Patent No. 2,426,599). It has appeared in QST and various handbooks.

I admire your magazine very much and I think I've bought every issue!

E. E. COMSTOCK

Choctawhatchee Beach, Fla.

[Sorry—we didn't realize it was patented, Mr. Comstock. But the circuit is still "unusual" in that it is unfamiliar to most readers. While it may have been used in a few transmitters, a reader wouldn't know of it unless he had either built the transmitter or made a detailed study of its circuitry.—Editor] END

SERVICE TECHNICIANS, ENGINEERS, TEST LABS SAY . . . THE POPULAR MIGHTY MITE IS

"The Best Tube Checker they ever used."

Here it is . . .

THE MIGHTY MITE

Designed for the present and far into the future. Tests all of your present tubes plus the new RCA Nuvistors and Novars, GE Compactrons and Sylvania 10 pin tubes.



Finds 'em Fast!
Checks 'em All!

A complete tube tester that is smaller than a portable typewriter yet outperforms testers costing hundreds of dollars. A real money maker for the serviceman and a trusty companion for engineers, maintenance men and experimenters.

Even though the Mighty Mite weighs less than 8 pounds, new circuitry by Sencore enables you to use a meter to check grid leakage as high as 100 megohms and gas conditions that cause as little as one half microamp of grid current to flow. Then too, it checks for emission at operating levels and shorts or leakage up to 120,000 ohms between all elements. This analytical "stethoscope" approach finds troublesome tubes even when large mutual conductance testers fail. And it does all this by merely setting four controls labeled A, B, C, & D.

Check these plus Sencore features: New, stick-proof D'Arsonval Meter will not burn out even with a shorted tube • Meter glows in dark for easy reading behind TV set.

- New large Speedy Set-Up Tube Chart in cover, cuts set-up time
- Rugged, all-steel carrying case and easy grip handle
- Smallest complete tester made, less than one foot square.
- The Mighty Mite will test every standard radio and TV tube that you encounter, nearly 2000 in all, including foreign, five star, auto radio tubes (without damage) plus the new GE Compactrons, RCA Nuvistors and Novars and Sylvania 10 pin tubes.

Mighty Mite also has larger, easy-to-read type in the set-up booklet to insure faster testing. Why don't you join the thousands of servicemen, engineers, and technicians who now own a Mighty Mite tube tester? Tube substitution is becoming impossible and costly with nearly 2000 tubes in use today. Ask your authorized Sencore Distributor for the New Improved Mighty Mite. Size: 10¼" x 9¼" x 3½". Wt. 8 lbs.

MODEL TC114

Dealer Net **\$74.50**

Sencore Sam says . . .
"They all agree . . . the Mighty Mite
is the real answer for the man on the go."



SENCORE

ADDISON, ILLINOIS

put the best on your bench



EICO 667

dynamic conductance tube and transistor tester

The EICO 667 will earn money for you by catching the bad tubes an emission tester would miss. The 667 combines a mutual conductance test with a peak emission test to give a single reading of tube quality. Bad transistors can be spotted easily. Gain and leakage tests find the defective ones.

TESTS ALMOST EVERY DOMESTIC OR FOREIGN RECEIVING TUBE MADE. The EICO 667 checks 5 and 7-pin Nuvistors; 9-pin Novars; 12-pin Compactrons; 7, 9 and the new 10-pin miniatures; 5, 6, 7 and 8-pin subminiatures; octals and loctals. It will also check many low-power transmitting and special purpose tubes, voltage regulators, cold-cathode regulators, electron ray indicators, and ballast tubes. And by inserting pilot lamps into the special output in the center of the Novar socket you get an instant good-bad test of these lamps.

TESTS MADE UNDER ACTUAL TUBE OPERATING CONDITIONS. When one section of a multi-purpose tube is being tested, all sections are drawing their full rated current. Pentodes are tested as pentodes rather than combining all the elements for a simple emission check. Leakage between tube elements is read directly on a 4½" meter in ohms.

EICO 667 NEVER WILL BE OUTDATED. A new rollchart is prepared

periodically. Data on one or two tubes, can be added by unsnapping the windows over the chart.

TRANSISTORS CHECKED IN TWO STEPS. First for leakage, then for Beta or current amplification factor. Both are read directly off the meter dial, and both n-p-n and p-n-p transistors can be checked.

FEATURES OF THE 667. Multi-circuit lever switch sets up plate, screen and control grid voltages rapidly. 13 pushbutton switches insert alternate tube elements for rapid leakage testing. 200-ma 4½-inch D'Arsonval meter is sensitive enough to give accurate readings even for tubes with low cathode current. 20 heater voltages cover all tube types including 300-, 450- and 600-ma series string tubes. Line voltage variations are compensated for by a line-adjust potentiometer \$79.95 kit, \$129.95 wired.

Tests all Color, B & W CRT's—70, 90 and 110°!

EICO CRU universal crt test adapter—New CRT adapter for models 667 and 628 has 12-pin socket for 70° and early 90° deflection black and white tubes. Three additional back-to-back plug-socket adapters for 7- and 8-pin 90 and 110° and color CRT's. Adaptable to many other tube testers. Wired \$9.95



EICO 995
IN-CIRCUIT
CAPACITOR TESTER
Kit \$19.95.
Wired \$39.95.

EICO 222
VTVM including
exclusively Uni-Probe
Kit \$27.95.
Wired \$42.95.



ELECTRONIC INSTRUMENT CO., INC.
33000 Northern Blvd., L. I. C. 1, N.Y.

RE 11

Send free

- 28 page catalog
- Short Course for Novice License
- Send 36-page Stereo Hi-Fi Guide for which I enclose 25c for postage and handling.

Name _____

Address _____

City _____

Zone _____

State _____

ELECTRONIC ROBOTS

...Are Human-like Robots Possible in the Foreseeable Future?...

WE OFTEN receive letters and calls in person from well-meaning, often highly-intelligent persons who wish to get "complete" technical information on the so-called Robots. How soon will we have robots, *in human form*, that can act like humans, *think* like humans, and perform various human tasks, and that can replace humans in industry and commerce?

Before we answer, let us give a short history of *robotology*, if we can call it such, because in our technological age many pseudo-science fiction themes sound not only reasonable but eminently possible.

It was Karel Čapek, science fiction writer of Czechoslovakia, who in 1920 coined the word *Robot*, from the Slav term *robot*, "work." He wrote a play, R.U.R. ("Rossum's Universal Robots") about artificial mechanical men put into mass production. These were sold as soldiers and workers. The play then goes on to its inevitable conclusion when the robots revolt and destroy man. The word, usually mispronounced, has the accent on the first syllable: *ro-bot*.

R.U.R. was first produced in New York in 1922, and soon caught the world's attention. The term *robot* is now known all over the globe in almost every language, yet the idea of artificial perambulating men is very old, going back thousands of years, and including the Hebrew *Golem*, the *Frankenstein* monster and many others in early science fiction.

To modern man the idea of an electromechanical, or electronic, robot will not dawn—it sounds too plausible! Even good science fiction writers—usually non-scientific, non-technical—are caught in the robot illusion. There is not a single year during the past 25 that has not had its quota of robot short stories or books. These are *always* in human form; often they masquerade as real humans from other worlds.

Few of these pseudo-science fiction authors ever think through, or technically work out, the (at present) almost impossible task of constructing a true, thinking replica of a human. What about the power to motivate such a machine independently, without a cumbersome engine? How to electrify it without a separate power plant? Batteries, fuel cells? These are wholly impractical if the robot is to be less than 10 feet high and weigh less than a ton. Atomic energy? Completely unrealistic in the foreseeable future! Remember that a robot, to perform like a human, must have a reasonably independent power supply so that it can do every kind of labor: walk, run, climb, lift weights, etc. *This takes a good deal of energy*. Where does a human-sized robot get it? Well, at present it is not even on the horizon.

But even if that problem could be solved in 300 years, where is the brain that will make the robot think and act?

Alas, the foremost computer scientists laugh at the idea of thinking computerized robots! Listen to just a few of them:

Says Dr. Philip M. Morse, Professor of Physics and Director of the Computation Center of the Massachusetts Institute of Technology: "The present state of computer design

compares to the very early automobile design of 1913."

In the 1962 meeting of the Conference on *Self-Organizing Systems* in Chicago and New York, sponsored by the Office of Naval Research and the Armour Research Foundation, the talks centered on machines, devices and systems that could "learn" from experience and conduct themselves accordingly. The main obstacle, the speakers confessed, was lack of information on how the human nervous system operates during the thinking processes. This, in their opinion, points to the long paths that lie between us and true "thinking machines."

Says Dr. Marshall C. Yovits of the Office of Naval Research: "Some of the much-publicized systems, allegedly capable of learning or recognizing, must be taken with a grain of salt!" (Refer also to our editorial, "After the Computer, What?", in the June, 1963 issue of RADIO-ELECTRONICS.)

So much for the total impracticability of the robot in human form—at least for the foreseeable future.

Man is still the most complex, the best, the most efficient and the cheapest "robot" in existence!

Yet we do have excellent working robots all around us today, *if we can forget that they are never in human form*, but come in all shapes, sizes and weights, from a mere few ounces to hundreds of tons.

Every time you dial a number, you use a fairly intelligent robot. Every time you turn on a radio, a TV set, a washing machine, a dishwasher, start an automatic elevator, you use an intelligent, yet not thinking, robot.

Industry uses thousands of almost-thinking robots: Automatic typesetters, billing machines, typewriters that write automatically, auto-printing machines, automatic bowling pin reseters, near-automatic assembling machines that turn out radios and automobiles, and of course, the computers we have been discussing.

There are now hundreds of almost manless plants that work automatically, turning out and packing for shipment such articles as pins, screws or stampings of every kind. We have bottling plants, even automatic gasoline refining plants that take the raw product, crack the gasoline and deliver it ready for shipment, all without human hands.

It would take a large volume to list all the automated plants in use today. This is Čapek's R.U.R. *in reverse*. Today it isn't the robots that revolt and destroy man—it is man who is beginning to revolt against the robots and their automation.

What is desperately needed now is the renaissance of man in the automation age. It will take a great deal of ingenuity to devise means and ways to reintegrate man into the new electronic-robot age.

One solution would be free Government "conversion" classes in various parts of the country to retrain persons out of work because of automation. Such individuals would be taught various trades in which there is the best possibility of employment. Such an effort would certainly pay dividends to the country and reduce unemployment. —H.G.

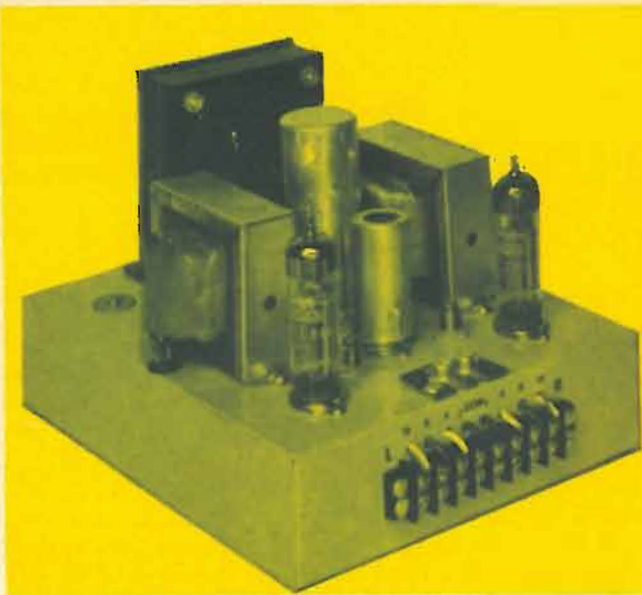

20 WATTS STEREO... 3 TUBES!

By **PETER E. SUTHEIM**
ASSOCIATE EDITOR

EARLY THIS YEAR, INTERNATIONAL TELEPHONE & Telegraph announced a remarkable new tube, made in Germany by Lorenz to be distributed here by ITT. Dubbed the ECLL800/6KH8 (!), it contains two audio power pentodes and a low- μ phase inverter triode—all in a single nine-pin miniature envelope! A look at the specification sheet for the new tube soon had me convinced that I could build a dual stereo amplifier with two ECLL800's and a single 12AX7. I

tried it, and Fig. 1 and the photos show what it looks like.

The circuit

The only unusual part of the amplifier is what surrounds the new tubes. Even there, the actual circuit is probably a good 30 years old. I would have preferred a different kind of phase inverter, but the fact that several elements are connected together inside the tube limits the ways it can be used. Despite

my misgivings, though, the circuit performs very well.

The input stage of each channel is half a 12AX7 with plate and cathode resistor values (R7, R8; R3, R4) selected for maximum gain. We'll need that gain for feedback later. To provide a point for applying negative feedback from the output transformer secondary, 120 ohms of cathode resistance (R5 and R6) is left unbypassed. This is such a small portion of the total cathode resistance that the gain of the stage (without overall feedback) is unaffected.

Since the grid of one of the power pentodes is common to the built-in phase inverter, the drive appears there, too, and then again on the phase inverter plate, delayed by 180°. Normally, this kind of phase inverter gives more gain on the inverted side than on the "straight-through" side, since there is one more stage in the inverted side. To compensate, most circuits of this kind split the grid resistor of the output tube

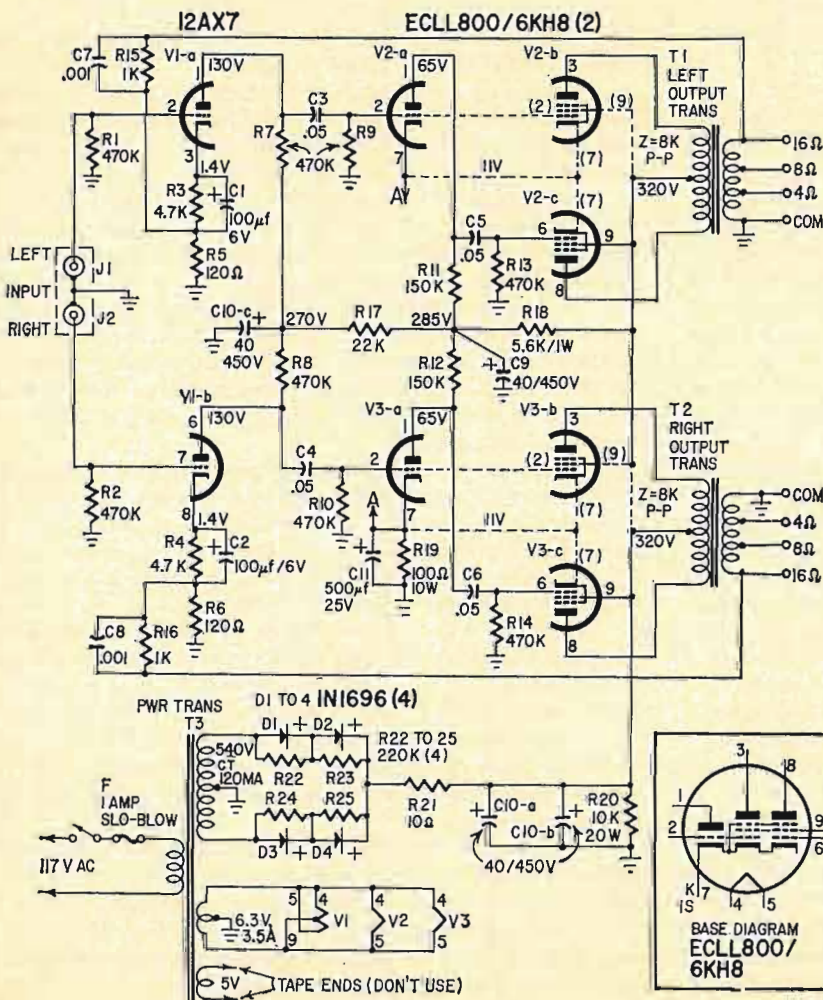

- R1, R2, R7, R8, R9, R10, R13, R14—470,000 ohms
- R3, R4—4,700 ohms
- R5, R6—120 ohms
- R11, R12—150,000 ohms
- R15, R16—1,000 ohms
- R17—22,000 ohms
- R18—5,600 ohms, 1 watt
- R19—100 ohms, 10 watts
- R20—10,000 ohms, 20 watts
- R21—10 ohms
- R22, R23, R24, R25—220,000 ohms
- All resistors 1/2-watt unless noted
- C1, C2—100 μ f, 6 v, electrolytic
- C3, C4, C5, C6—.05 μ f, 600 v, paper
- C7, C8—.001 μ f, 500 v, ceramic
- C9—40 μ f, 450 volts electrolytic
- C10—40-40-40 μ f, 450 volts electrolytic
- C11—500 μ f, 50 volts electrolytic
- V1—12AX7
- V2, V3—ECLL800/6KH8 (available from ITT distributors)
- T1, T2—output transformer, 8,000 ohms plate-to-plate. Sec. 4, 8 and 16 ohms. 18 watts (Allied Radio Catalog No. 62 G 058)
- T3—power transformer, 540 vct, 120 ma; 6.3 v, 3.5 amperes; 5-v winding not used (Allied Radio Catalog No. 61 G 466 or equivalent)
- F—fuse, 1 amp, slow blow
- D1, D2, D3, D4, diodes, 1N1696 or equivalent
- J1, J2—dual phono jack
- Chassis, 9 x 7 x 2 inches
- Fuse post, terminal strip, tie points, assorted hardware

Fig. 1—Circuit of the stereo amplifier. By replacing R1 and R2 with dual 1-megohm volume control, amplifier can be used as is with FM stereo tuner or high-output crystal or ceramic cartridge.

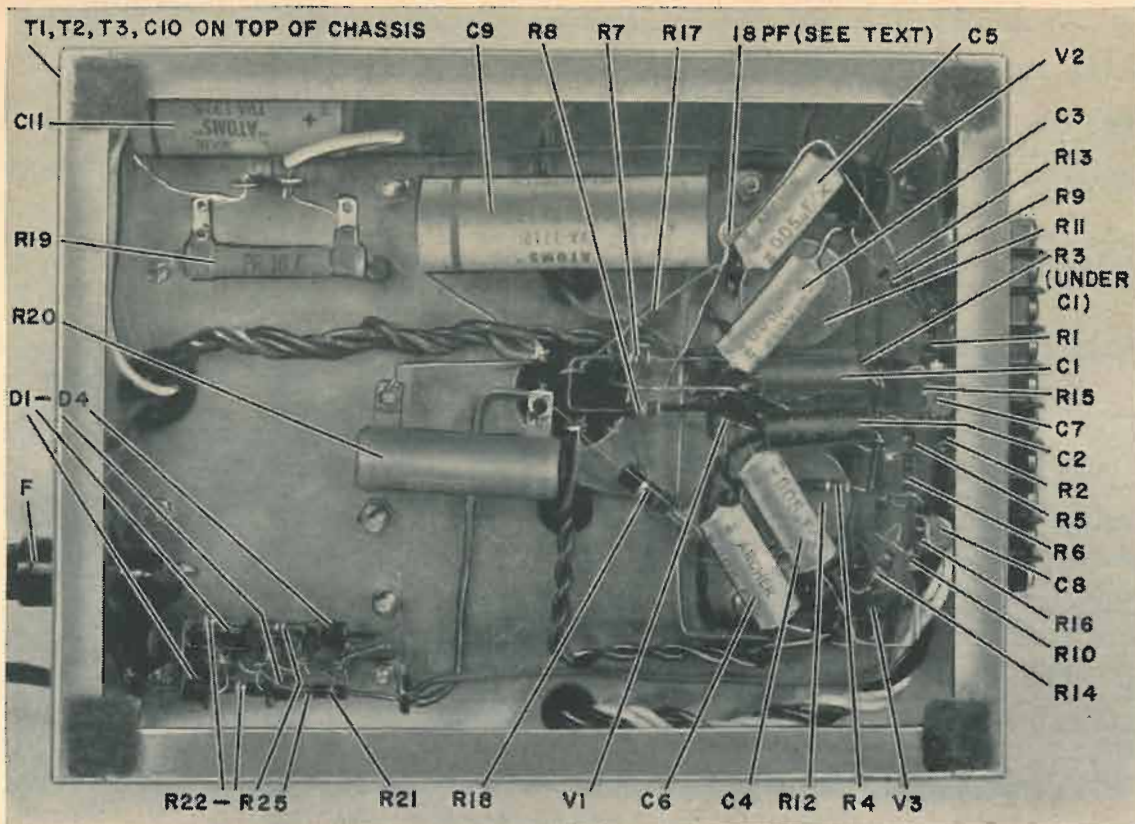

View underneath shows all components. Pads in corners protect finished surfaces.

(Fig. 2-a) feeding the inverter grid from the junction of the two resistors. The ratio of the resistors is chosen to attenuate the signal just enough to cancel the gain from the inverter stage. There lies this inverter's worst drawback: the amplitude balance of the two outputs depends on the gain of the inverter tube, which is bound to change with time, while the resistors' values stay pretty much the same.

In the ECLL800, the inverter triode has a transconductance of only 50 μ mhos! Its voltage gain is nearly unity. (Note, by the way, that since the cathodes of all three sections of the tube share a common pin, the inverter grid will have to be biased the same as the output stage. Interesting.)

Now, there is something lovely about unity gain. It won't go up or down very much during the life of the tube. And it has eliminated the nuisance voltage divider.

I wasn't aware of all this until after I had breadboarded a circuit and played with it a few hours. I had (ingeniously, I thought!) made the phase inverter plate load a 150,000-ohm pot instead of a fixed resistor, so that I could compensate for what seemed to be inherent unbalance.

So convinced was I of the need to adjust that, when the experimental circuit showed there was no need for it, I attributed it to a fluke, and went ahead and built two pots into the final version. They're still in, as you can see from the

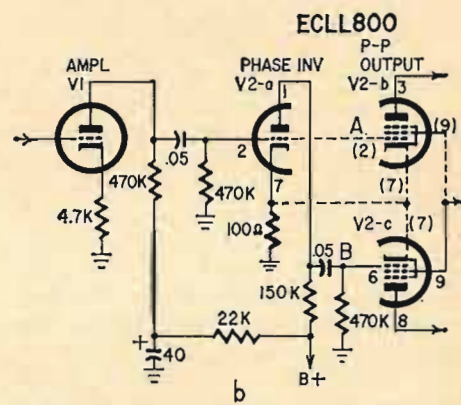
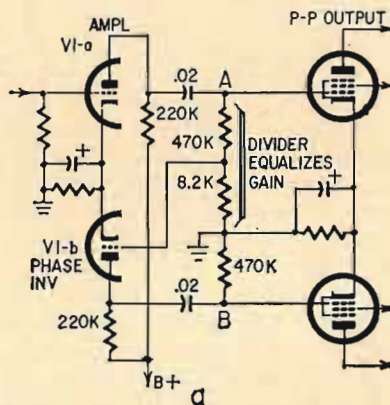

Fig. 2-a—Divider in upper output tube grid circuit, set to equalize drive voltages at A and B, does so for only one value of gain in VI-b. Fig. 2-b—Unity gain of V2-a (built into ECLL800) makes signal voltage at A and B the same, regardless of gain changes.

photos, but the center terminals are not used. They are now just expensive fixed resistors. I was too lazy to take them out.

About 24 db of negative feedback comes from the 16-ohm output taps back to the cathodes of the 12AX7 via R15 and R16. C7 and C8 counteract the transformers' tendency to make the feedback positive at superaudible frequencies.

The output transformers deserve a special word. Unprepossessing as they look, they have golden hearts. Beneath all that unlovely "gunk" sleeps a very well-made transformer—especially considering the price: \$5.35 from Allied Radio, Chicago. Though I made no

measurements on the transformers themselves, the amplifier's performance shows them up very well. There's lots of iron, built up out of thin laminations—signs of a good transformer. They are designed for 18 watts, and are loafing here at a maximum of 10.

The power supply is done in modern conventional: four G-E 1N1696 silicon rectifiers connected in series pairs as a full-wave rectifier. The 220,000-ohm resistors (R22-R25) equalize backward voltage drop to prevent any one diode from carrying the full strain. R21 is a surge-limiting resistor; it protects the electrolytics and the rectifiers from the initial heavy charging current. Plenty

SPECIFICATIONS

Measurements were made with constant 117-volt ac supply and 8-ohm resistive output load.

Power output (rms, per channel, at 1,000 cycles)	10 watts
Power bandwidth (rms 3-db power points, IHF standards)	35-20,000 cycles, at 1% harmonic distortion
Frequency response (at 1-watt output level)	10-40,000 cycles, +0, -0.1 db
IM distortion (equivalent rms sine-wave power per channel, using 60 and 7,000 cycles, mixed 4:1)	Less than 1.5% at 10 watts output (see curve)
IM distortion (same conditions, both channels into common load)	Less than 1.5% at 20 watts output (see curve)
Hum and noise (referred to full output)	-77 db
Crosstalk (level of signal in "unused" channel below full output in operating channel)	-57 db
Gain (input required for 10-watt output)	1.5 volts
Damping factor at 8-ohm output terminals	9.5
Stability test (.01- μ f capacitive load across 8-ohm terminal; amplifier driven to full output, 20 cycles to 20 kc)	No trace of parasitic oscillations

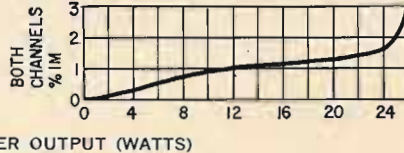
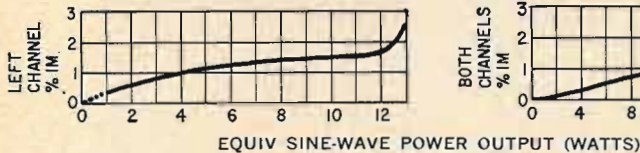

of filter capacitance (160 μ f total) means low hum, better low-frequency stability and better short-term supply regulation.

Biasing

In this final version, straight cathode bias is used, with a 500- μ f electrolytic bypass capacitor to improve regulation. I tried two other ways: a 12-volt 3.5-watt Zener diode (1N1594) between the output tube cathodes and ground, and a simple half-wave bias supply using as a source the 6-volt heater winding (one side grounded) and the unused 5-volt winding, connected in series. According to theory, the Zener bias system should offer pretty near the ultimate in bias regulation, since between its breakdown point and the point where it just gives up and melts, the voltage across it stays constant. Its dynamic impedance is about 1 ohm, so it needs no bypassing.

As it turned out, neither the Zener nor the fixed supply provided any improvement over good old cathode bias; so cathode bias—the cheapest way—was the method I used here. Feel free to experiment, but remember that Zener diodes are destroyed utterly and almost instantly once overloaded (at \$3.85 a shot, by the way—I know), while a cathode resistor can usually take it for a while.

Building it

No unusual construction techniques were used here—just the usual "good wiring practices" every construction ar-

ticle mentions. I recommend this layout, because it's logical, symmetrical and reasonably compact (everything fits neatly on a 9 x 7 x 2-inch chassis). If you use it, you should have no trouble with instability or hum. The only anti-hum precaution I took was to use balanced heater wiring (grounded center tap and twisted leads). The photo shows a central ground bus, but many things are grounded rather haphazardly at convenient points.

If you do have high-frequency oscillation, try first to get rid of it by moving the output transformer primary leads around, away from the grid resistors. If that doesn't help, try a low-value ceramic or mica capacitor from one of the ECLL800 output grids to cathode or ground. I had oscillation troubles in one channel only, and licked them with an 18-pf ceramic across R13. This does not affect high-frequency response but now there is no trace of oscillation or peaking in either channel.

The amount of feedback used here is about the maximum. Any more will lead to instability and raise the input voltage required for full output to such a high value that many preamps will run into distortion trying to drive the amplifier.

So, on the whole, this makes a very respectable amplifier for a modest stereo system. Total cost of the parts, new, will be something around \$40. Not bad, for an honest 10 watts per channel (more on a music power rating). Happy listening!

END

Tuner input impedance can cause trouble in color TV

By BOB MIDDLETON

MANY TROUBLES IN COLOR TV RECEPTION are caused by a mismatch between the tuner and the lead-in. The service technician will naturally look for trouble in the antenna itself, or in the lead-in, as these are the most common offenders. But it's handy to have an easy, convenient test of tuner input impedance. You can make such a test with a color bar generator.

The generator must be tunable over the channels you want to check. Feed the signal from the generator to the TV tuner first through an 8-foot delay line—just an 8-foot length of good-quality 300-ohm lead in. Now try to tune in a color-bar pattern on the set. If you can't get one, feed the bar generator directly into the set without a delay line. If you get a color pattern now, there is a serious mismatch.

If you do get a decent pattern with an 8-foot delay line, try again with a 10-foot line. There should be no change in color or brightness; if there is, you have a mismatch. If color falls out completely, the mismatch is very bad. Make a third run with a 13-foot line. The pattern should still be good.

This approach might seem a little playful, but it's based on solid theory. The idea is that a perfectly matched transmission line will transfer all its energy to the load without reflections, standing waves or consequent drop-outs.

To find the mismatch, look first for a broken lead between the set's input terminals and the tuner. Sometimes the lead is taped to a metal support. The support may have chafed through the insulation, grounding one side of the lead. Mismatch can also come from poor contacts to the tuner strip, or a defective strip.

Remember to suspend the delay line in free air during the test—don't coil it or kink it. If any two parts of the line are close to each other, a number of capacitance or inductance effects—or a queer combination of both—can take place, and tests can then easily become meaningless.

Some of you may feel that this is an unduly severe test because the generator output impedance is 75 ohms, and any reflection from the tuner is strongly re-reflected from the generator. Actually, this test closely simulates conditions with an antenna. Few antennas are really exactly 300 ohms all the way. If a color set passes the delay-line test, it will work with any impedance you are likely to come across.

END

THE PATTERN DEPENDS ON THE PROBE

By ARTHUR CUNNINGHAM

Ever complain, "My scope patterns never look like the ones in the service data?" The answer, almost always, is, "You're using the wrong probe with your scope!"

Here you'll see what happens (or doesn't happen) when you use the wrong probe, and how pretty everything looks when you use the right one. The table and diagrams will help you choose the proper probe.

These are traces of video information, made at video amplifier output. (a) What the scope shows with direct probe: a hopeless smear. (b) Through 50,000-ohm isolating probe, a little better—probe, cable, scope input capacitance have somewhat less effect. (c) Looks like what's in the book! Low-capacitance probe shunts higher frequencies very little. (d) Trace made through crystal probe.

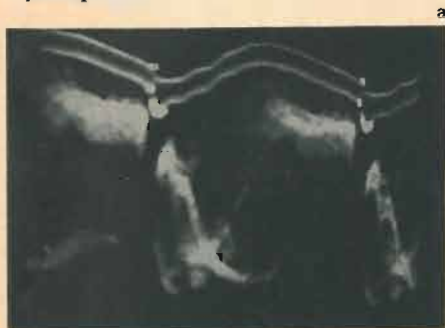

Photos (e) through (g) waveform on last video i.f. grid as "seen" through direct, resistor and low-cap probes. Almost nothing to see! Crystal probe (h) can give you needed information; it demodulates video carrier and removes video. Notice how direct probe (e) shorts out video signal by its low impedance. Only blanking interval is discernible.



PROBE	USED IN
Direct	Low-impedance circuits, low-frequency signals. Response depends greatly upon input impedance and capacitance of scope's vertical amplifier.
Resistive isolating	Low-frequency circuits which have "medium-high" impedance. Resistor used mostly to isolate input impedance of scope from circuit.
10:1 low-capacitance	High-impedance circuits, medium to low frequencies and, to some extent, on higher frequencies, such as horizontal oscillator and sound testing. Useful in video circuits after video detector.
Crystal	Rf signals, before detection. Absolutely necessary for signal-tracing in video and sound i.f. stages or tuner output.

Inside four probe types: Direct probe (a) is a piece of coax, with shield running almost to probe tip, and grounded to instrument at other end. The isolating probe (b) is very similar, except for about 50,000 ohms resistance in series with hot lead. (c) 10:1 low-capacitance probe, compensated with trimmer for greater bandwidth. (d) Crystal detector probe: 2 diodes in voltage-doubler rectifier, dc blocking capacitor and filter capacitor.

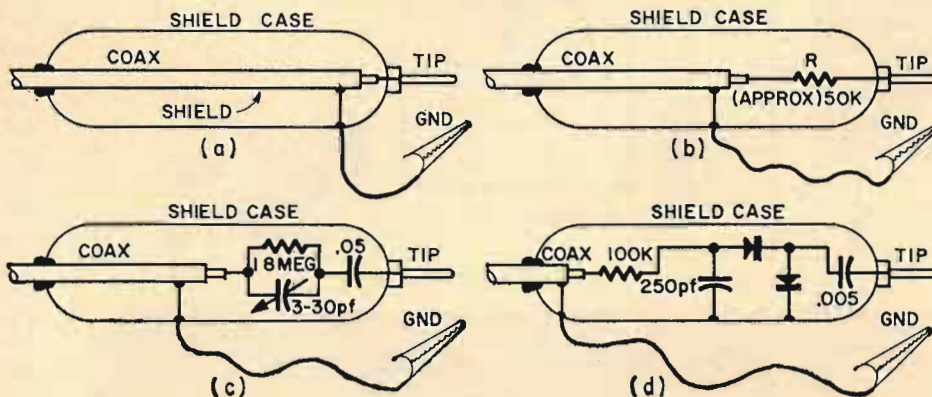

Working with ELECTRONIC ENGINE ANALYZERS

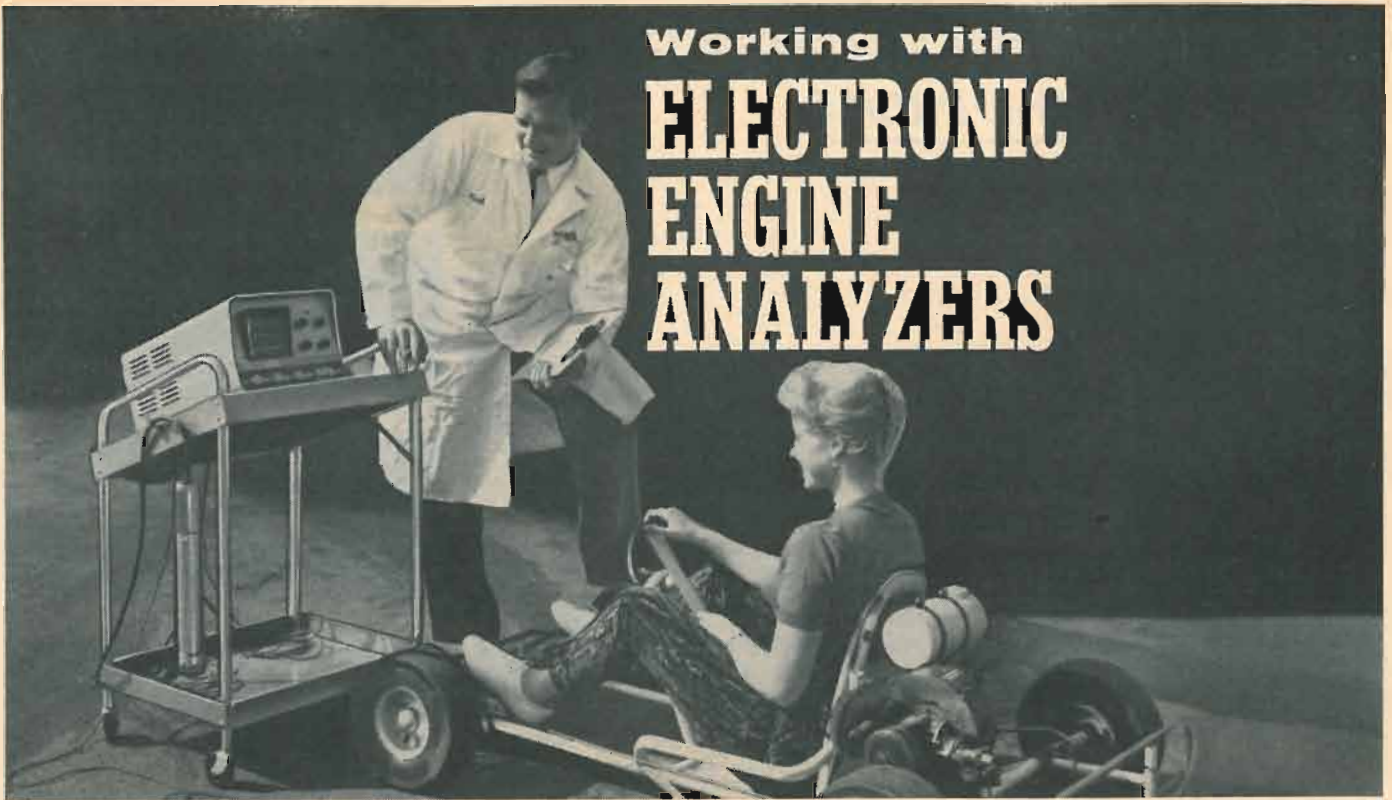

By ARTHUR S. KRAMER



Heathkit's 10-20 electronic ignition analyzer.

One of the earliest electronic engine analyzers was developed approximately 10 years ago at the Socony-Vacuum Research Laboratory in Paulsboro, N. J. Several Socony engineers, seeking a better way to observe the ignition process of gasoline engines, worked out a hookup using an oscilloscope. Since that time, many improvements and additions have been made, and today the electronic analyzer is generally accepted as the way to observe engine operation. Among the automotive service problems to which it has been applied are irregular distributor cam lobes, wobbly breaker plate, incorrect breaker-spring tension, low compression, insulation leakage, coil-tower corrosion, fouled and cracked plugs, pre-ignition, and many others.

Let's review the operation of a typical automotive ignition system. Referring to Fig. 1, when the breaker points are closed, current flows through the coil, setting up a magnetic field in the iron core. This field builds up relatively slowly, so the length of time the points remain closed (dwell time) is important.

As soon as the points open, current flow stops and the magnetic field collapses practically instantaneously, generating a voltage that tries to keep the current flowing. A voltage surge is induced into the secondary (which contains many more turns of wire). The net effect steps up the primary voltage to many thousands of volts, firing the spark-plug. (The actual voltage depends on compression, air/fuel ratio and spark-plug gap.) The distributor then moves to the next position, closing the breaker points by cam action and connecting the

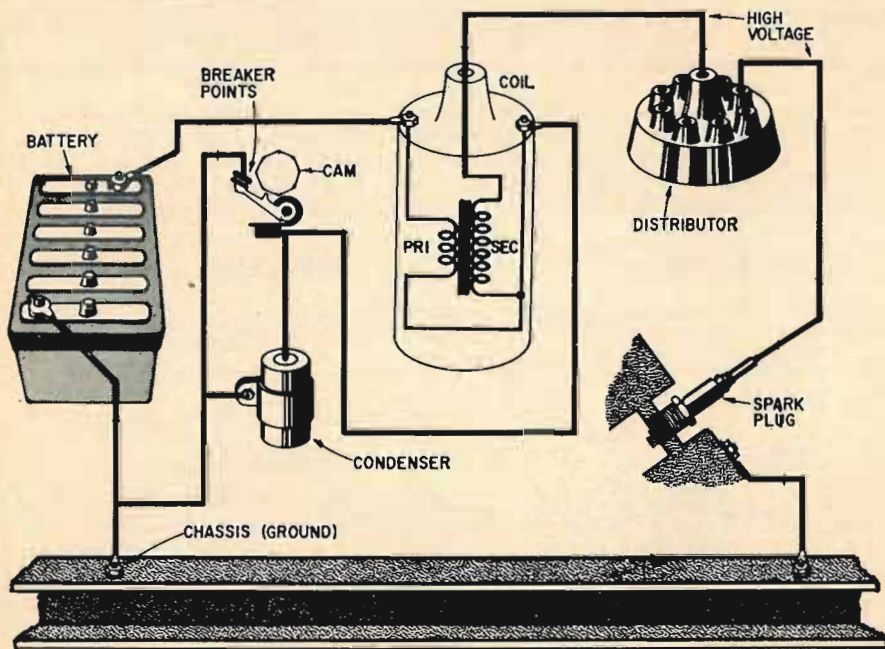

Fig. 1—Basic diagram of a typical ignition system.

next sparkplug to the secondary, and the process is repeated.

Advantages of engine analyzers

The electronic analyzer has given the mechanic a set of X-ray eyes so he can see what is occurring in the engine and thus end his blind guesswork groping.

All modern electronic engine analyzers are easy to use. About all that is necessary is to connect the power plug to an ac outlet, clip on two or three leads, make a few simple adjustments and begin observing engine performance.

The electronic analyzer saves so much time that many more jobs can be handled successfully in a work day than previously.

Kit type analyzers

One way to get an electronic analyzer at moderate cost is to purchase it in kit form and build it yourself.

The Heathkit electronic ignition analyzer kit model IO-20 is an example. Only four cables need to be attached, and there are only four controls to adjust. The instrument has six basic sections: the trigger circuit, sweep generator, horizontal deflection amplifier, vertical amplifier, power supply and CRT circuit.

How they work

The DuMont type 901 EnginScope is basically a cathode-ray scope with special circuitry built in to make engine tests. The instrument contains a CRT quite similar to the picture tube in a TV set, and the engine ignition voltage waveforms are displayed on its face. Special amplifiers deflect the electron beam horizontally and vertically. A "raster" presentation is featured in which each cylinder has its own ignition line, one above the other. Signals from the engine are picked up by cables running from the instrument and clamped onto various wires in the ignition system.

Battery current flows through the automobile coil while the points are closed. When the distributor cam forces the points open, the circuit is broken and the high-tension surge comes out of the coil tower and is delivered to the sparkplug where it jumps the gap.

In the oscillogram of Fig. 2, the plug firing is pictured as a straight line at the left edge of the waveform. After the plug fires, the unused energy in the coil diminishes. The scope pictures this diminishing power as a series of wiggles getting smaller and smaller.

When all the unused energy in the coil has dissipated, the wiggles stop and the ignition system is ready to start a new cycle. This is shown by a small group of wiggles which occur at the in-



Airplane engines can also be checked with the Sperry analyzer.



This DuMont ignition analyzer offers a timing light as a handy accessory.

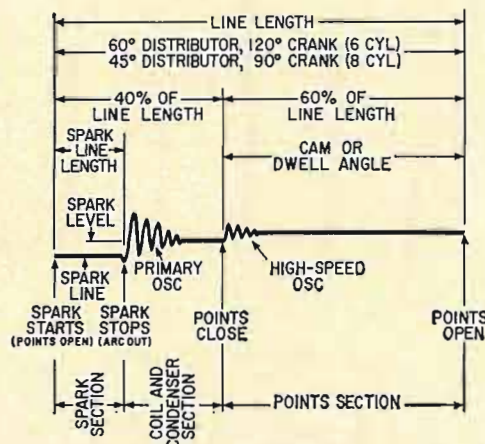

Fig. 2 — Single-cylinder display shows normal operation.

stant the points close. While the points are closed and the coil is building up the energy for the firing of the next sparkplug, the scope shows a straight line. The straight line ends when the points open. This is called the points-open signal. The period of dwell is measured by the distance between the points-close and points-open signals.

This represents a complete ignition cycle for one cylinder and is repeated

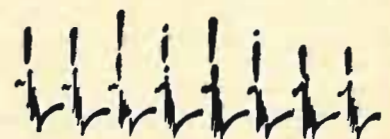

Fig. 3—Normal parade display shows all cylinders in a row.

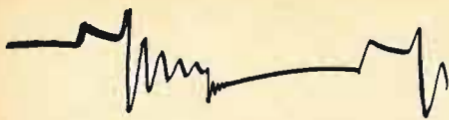

Fig. 4—The parade display can be expanded to show only one cylinder.

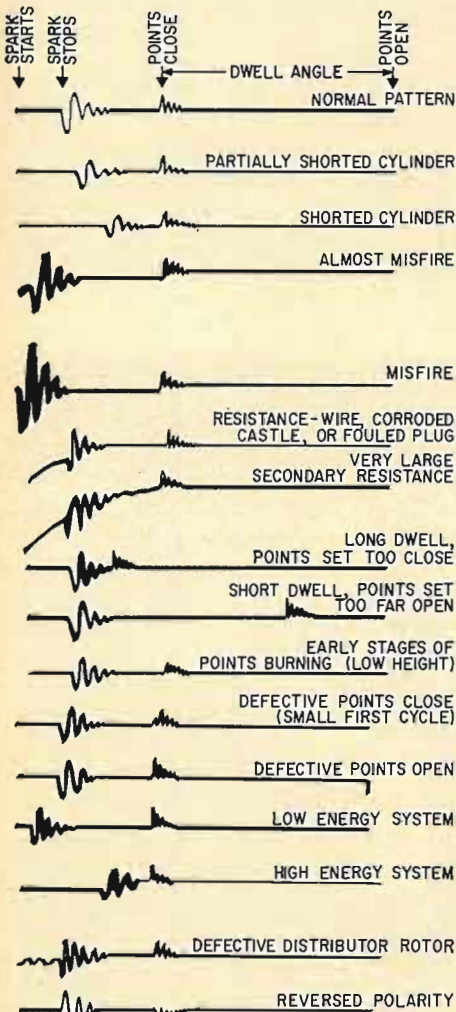

Fig. 5—Patterns seen on an engine analyzer screen. The defects shown here cover 90% of all ignition-system faults.

on the scope as a complete waveform for each cylinder as it fires. In the "raster" pattern, each cylinder is shown by its own spark line, as previously explained.

The Heyer Dyna-Vision analyzer includes a CRT, power supply and associated amplifiers. A "parade" pattern (Fig. 3) is obtained from this instrument. Here, signals from the various cylinders appear in a single line across the face of the tube. This pattern can be stretched out to permit close examination of the line from any individual cylinder.

Examining a single cylinder's section of the parade pattern (Fig. 4) shows that the pattern closely resembles that of one individual line in the raster pat-

tern, except that the high-frequency oscillations which follow "points close" appear below the line rather than above it. Other than this, the patterns are the same, and the explanation for the raster line also applies here.

The Sperry aircraft engine analyzer works in much the same way. Patterns are presented as a trace of light on the cathode-ray tube by a ray or beam of electrons that sweeps horizontally across the screen in step with engine rotation. As the beam is swept horizontally in sync with the engine, it is also deflected vertically by the changing voltage under observation, moving up and down as it crosses the screen, continuously plotting a dynamic graph of the voltage magnitude for every degree of crank angle over a selected portion of the engine cycle.

Engine analyzer applications

Fig. 5 is a rundown of common ignition problems. The normal pattern for a single cylinder appears at the top for reference and comparison. Obviously, all ailments manifest themselves as noticeable changes in the pattern. A little

study of Fig. 5 will enable the user to pinpoint trouble very quickly.

Much useful information can be obtained if the actual firing voltage of the plugs while operating in the car can be measured. Plug circuits in good condition will show similar patterns at approximately the same voltage. A nor-



DuMont type 901 EnginScope.

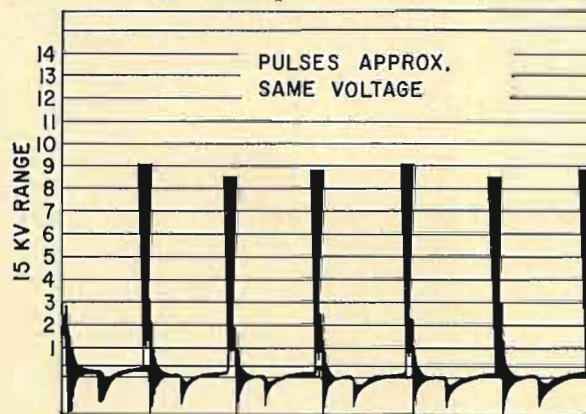

Fig. 6—Normal (a) and defective (b) parade patterns.

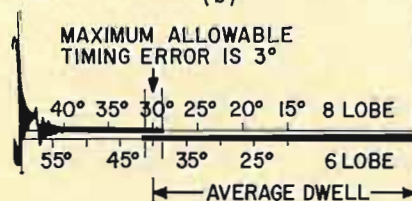
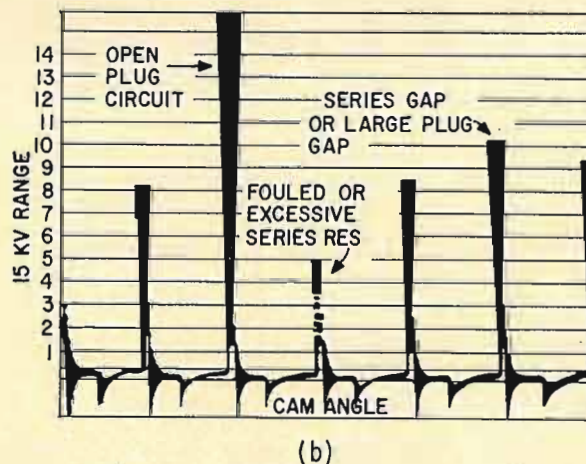

Fig. 7—Normal single-cylinder spark line.



The Heyer model 600 Dyna-Vision analyzer.

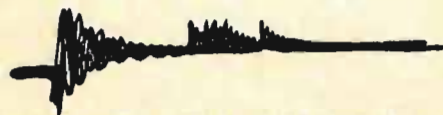

Fig. 8—This pattern reveals a bad distributor.

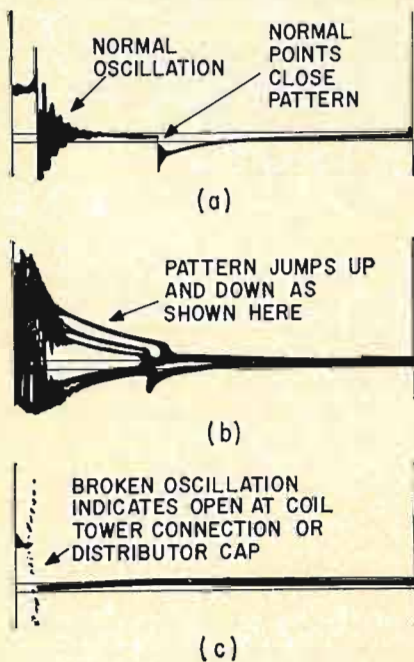
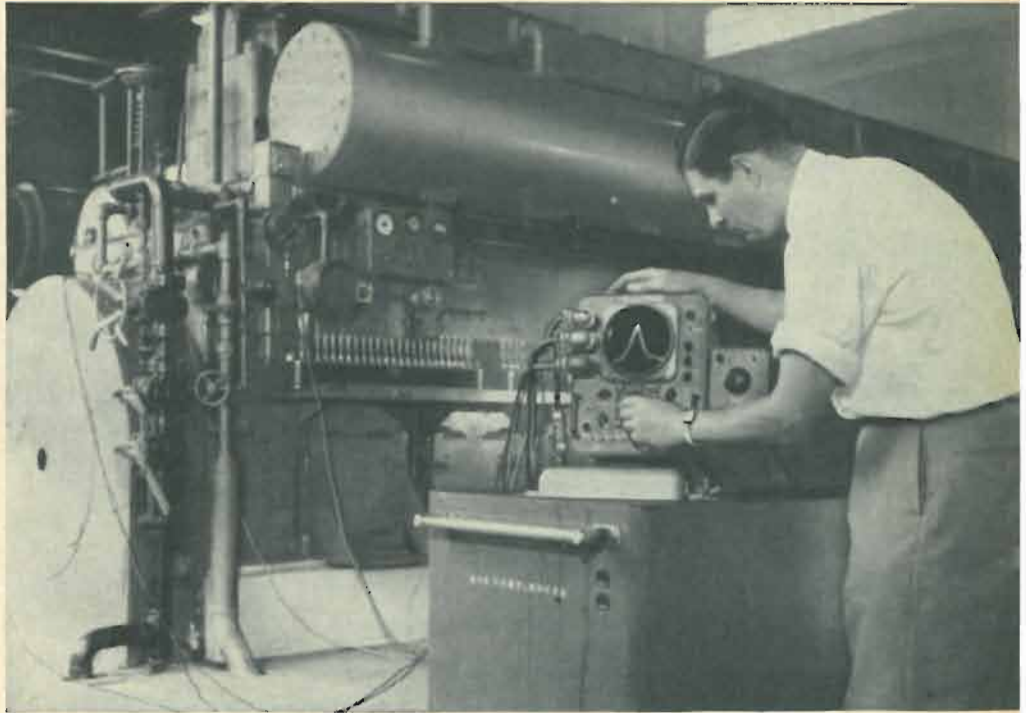

Fig. 9—Ignition problems. a—Normal secondary pattern. b—Open inside coil. c—Open in distributor coil lead.

mal parade pattern is depicted in Fig. 6-a. In contrast, the patterns obtained with several ailments are shown in Fig. 6-b. The differences between them are



Sperry industrial engine analyzer is checking natural gas engine.

so apparent that no great experience or skill is needed to spot them.

Distributor troubles are a common cause of irregular and erratic engine operation. A normal single-cylinder spark line is shown in Fig. 7, and the pattern of a car with a bad distributor in Fig. 8. This could be caused by worn distributor parts such as bearings or cam faces. About the only remedy is to rebuild or replace the distributor.

Coil and capacitor troubles can be easily diagnosed and pinpointed with an electronic analyzer too. In Fig. 9-a, a normal secondary pattern, note that the "oscillation" and "points close" parts of the picture are very clean and well-defined. Now examine Fig. 9-b, the pattern for an open inside the coil. Note that the pattern jumps about erratically and, in general, indicates a very bad situation in the ignition system. The pattern for an open in the distributor coil lead is shown in Fig. 9-c. Here, almost the entire secondary pattern has disappeared, indicating a serious fault in the ignition system. One pattern obtained with a faulty "condenser" in the system is depicted in Fig. 10. It is self-explanatory.

Nonelectrical troubles such as a hung-up valve, engine noise and pre-ignition can be diagnosed with the analyzer using the proper transducers to produce electrical signals to drive the scope. These patterns are shown in Fig. 11.

I wish to express my gratitude to the following companies who provided much useful information and all of the photographs used in this article: Heath Co., Div. of Daystrom; A. B. Du Mont Laboratories, Div. of Fairchild Camera and Instrument; Sperry Gyroscope Co., and Heyer Industries. END

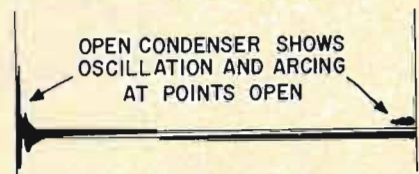

Fig. 10—Open ignition condenser causes this pattern.

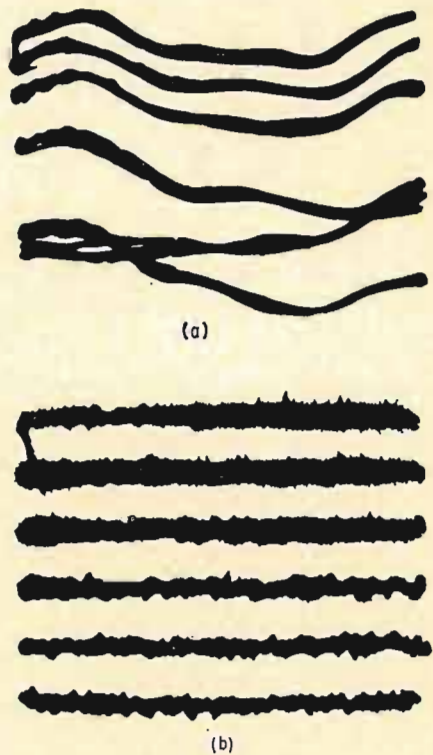

Fig. 11—Non-electrical problems. a—Exhaust manifold pressure with hung-up valve at 60 mph. b—Engine noise, normal condition.



EXPANDABILITY AND SERVICE CONVENIENCE FEATURED IN THE

BELL IMPERIAL 1000

F M S T E R E O R E C E I V E R

THE BELL IMPERIAL 1000 FM STEREO receiver is in the Cadillac class. Every detail shows thoughtful design and careful workmanship.

It is all-transistor except for the front end, which uses three nuvistors. The manufacturer claims that these provide greater freedom from cross-modulation than currently available transistor circuits, a point most engineers seem to agree on.

The receiver is designed with an "expandable hi-fi" modular concept. The amplifier-preamp can be purchased without the tuner, and the tuner added later by slipping its chassis into place, tightening four screws and making four plug-in connections (see photo).

The FM dial, tuning meter and all knobs are present even without the tuner, but the dial and meter are dark and inconspicuous until the tuner is plugged in. All that shows is the manu-

facturer's insignia, which glows red to show that the amplifier is on.

Sound is crisp and clean throughout. Stereo separation is excellent. Sensitivity is impressive, and approximately matches, in strictly numerical terms, the best of current FM tuners. I got fine stereo reception from three stations around New York City, even though all tests were conducted on the ground floor of a steel-frame apartment building, using only a 3-foot piece of wire connected to the 75-ohm (unbalanced) antenna input.

The 1000 has afc, but hardly seems to need it. Drift without afc, even from a cold start, was so small that I probably wouldn't have heard it in the sound if I hadn't seen it on the zero-center tuning meter.

With afc, tuning is a bit tricky. A little aggressive, in fact. A station on 96.3 mc and one on 97.1 could both be

made to appear at about 96.7 because of the way afc compensated for mistuning. Takes some getting used to.

The meter becomes a mono-stereo indicator when you flip a switch on the panel. (Circuit switching between mono and stereo is completely automatic.) The meter is an adequate stereo indicator, but a unit intended to sell for around \$500 could well incorporate some separate device to work full-time as a stereo indicator. While flipping a slide switch is no great strain, you have to remember to do it. If you want to look for a stereo station, you must switch to INDICATE and tune until you find a station that causes the meter pointer to swing well over to the right, into the region marked STEREO. Then you must return the switch to TUNE and tune in the station precisely, watching the meter now for a center-of-channel indication. There is no way of telling

Side view of the Imperial 1000 with the tuner removed. Note bright chrome metal work and sturdy military-like construction.

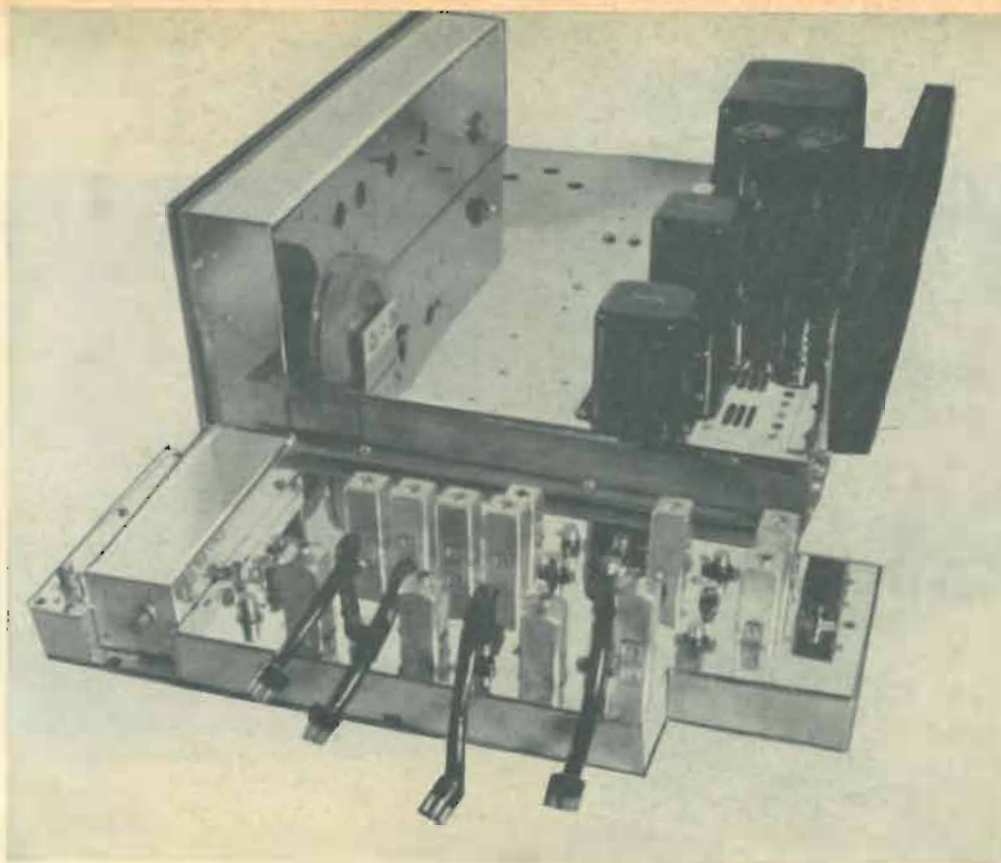

from a distance whether the receiver is in mono or stereo. Even if you leave the switch in its INDICATE position, you can't see the meter pointer from very far.

The heavy damping of the movement requires that you tune very slowly, allowing time for the pointer to swing unmistakably into STEREO. With rapid tuning, the meter merely fluctuates even on stereo stations.

The 1000 has variable muting to suppress interstation hiss—a fearsome noise on a receiver as sensitive as this. Like almost all muting circuits, this one suppresses weak stations along with the noise, and obliterates more and more stations as the control is turned clockwise until finally there is no sound at all. A kind of audio squelch.

The contour control is a kind of variable loudness compensation. According to instruction, this is how it's to be used: With the contour control fully off, turn the volume up until the room volume approximates the original sound level(!). Now reduce the level by turning the contour control to the level you want. This setting of a reference level by using the volume control helps avoid the difficulty of different levels from record to record that is such a nuisance with ordinary compensated controls. (With conventional loudness-compensated volume controls, the amount of loudness compensation depends completely on the actual physical setting of the control, not on the program level. If you start with perfect compensation for one disc, then play another recorded at a higher level, you will have to turn

down the volume—loudness—control to get the same volume as before, and thus get more compensation, even though you don't need it.)

But the Bell approach will help solve this problem if you go through the level-set procedure every time you or the station you're listening to changes records.

Another problem: most people grossly underestimate the actual loudness of even a solo voice or instrument—more so a large ensemble. And how many would *want* to bring the volume up to a level that approximates even for a moment the Boston Pops in a 12 x 18 living room? Still, used as designed, this system provides potentially more accurate loudness compensation than most other methods.

Tuning is deliciously smooth; there's a huge flywheel on the tuning shaft. All transformers are potted, and temperature rise is very low even after 3 hours of continuous operation. (No output transformers, by the way—just driver and power.)

The entire chassis is constructed of very heavy, mirror-finish chrome-plated steel. Dial lighting is sharp and uniform, but not so bright as to start you looking for dark glasses. All controls have that "solid feel" that betokens a well-built piece of machinery.

A feature that will appeal to both user and servicer is the hinged front panel that drops away to expose most of the front-panel wiring. There is extensive use of cabled wiring harness.

Speaker outputs are individually

fused to protect the output transistors in case the speaker terminals are shorted. The fuse will also blow if a speaker of impedance lower than the rated value is connected to the terminals (for example, a 4-ohm speaker to the "8-16-ohm" terminals). This is something that might be mentioned in the operating manual, to prevent needless agony on the part of the user!

Brief mention to one useful feature: a tape-monitor input and switch for simultaneous playback of tapes being recorded on a machine with separate record and play heads. Great for checking miking and quality as you record.

The Bell Imperial 1000 is well suited to serve as the heart of a top-quality home stereo system. **END**

SPECIFICATIONS

(All specifications are from the manufacturer)

Amplifier

Frequency response (at full power)—9–50,000 cycles, ± 1 db
 Power output (both channels)
 IHF music power—80 watts
 Continuous rms—50 watts
 IM distortion (full output, 60 & 6,000 cycles mixed 4:1)
 —less than 0.7%
 Harmonic distortion (full output)—less than 0.7%
 Noise (hi-level inputs)—80 db below full output
 Sensitivity (for full output)
 Ceramic input—150 mv
 Magnetic input—1.5 mv
 Aux input—0.5 v
 Tape monitor input—0.5 v
 Outputs
 8–16 ohm speaker (4 ohms at reduced power)
 Headphones (any impedance)
 Tape recorder

FM tuner

Sensitivity (IHF, 300-ohm input)—1.6 μ v
 Harmonic distortion (100% modulation, full limiting)—less than 0.5%
 Frequency response—20–15,000 cycles, ± 0.25 db
 Noise—65 db below rated output
 Capture ratio—2.5 db
 Stereo separation—30 db from 20–15,000 cycles
 Image rejection—greater than 65 db

MICROELECTRONICS

THE THIN FILM APPROACH

By C. D. SIMMONS*

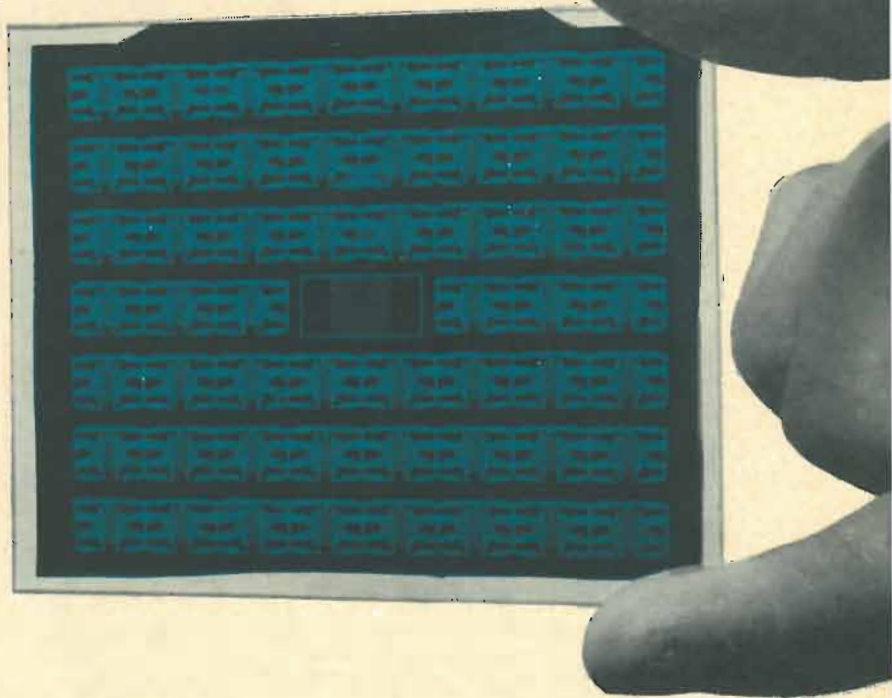

Above, multicircuit array of thin-film circuits; below, examples of finished hybrid circuits—forms of RTL (resistor-

transistor logic) flip-flops. In both cases, thin-film technique has been combined with discrete components.

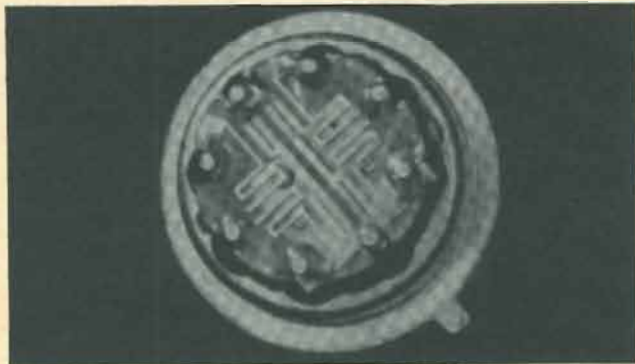

Circuits are getting tinier—
being made in one or two steps.... More information about this
fascinating frontier of modern electronics

MICROELECTRONICS (OR MICROCIRCUITRY) now describes *two* basic techniques for fabricating entire circuits—transistors, resistors and capacitors—in a single package no larger than a postage stamp. How is it done?

In one technique, metallic films are deposited on glass substrates, resulting in tiny circuit patterns on wafers the size of a contact lens. This gives us *thin-film* circuits. The second method produces *solid-state* semiconductor circuits by diffusing chemicals into pinhead-size silicon wafers in the same way that transistors are made.

A third approach now being tried in the laboratories is a combination of these two basic ones. Thin-film passive components are deposited on the surface of silicon chips that contain active devices such as transistors.

The thin-film approach is closest to old-time conventional circuitry. Thin-film circuit elements—separated from the integrated microcircuit and individually packaged—readily become conventional discrete components, such as the film resistor, for example.

*Manager, Microelectronics Div., Lansdale Div., Philco Corp.

Not only are the components of thin-film circuitry like conventional ones physically; circuit design is much the same. We can translate directly from conventional circuit design to microcircuitry with thin films.

But thin films have at least three striking advantages over conventional circuitry: miniaturization, performance and reliability. An entire thin-film circuit, such as a flip-flop, can be packaged in one TO-5 transistor case. Thin-film technique produces higher quality resistors and capacitors than can be made by semiconductor methods. (Thin-film

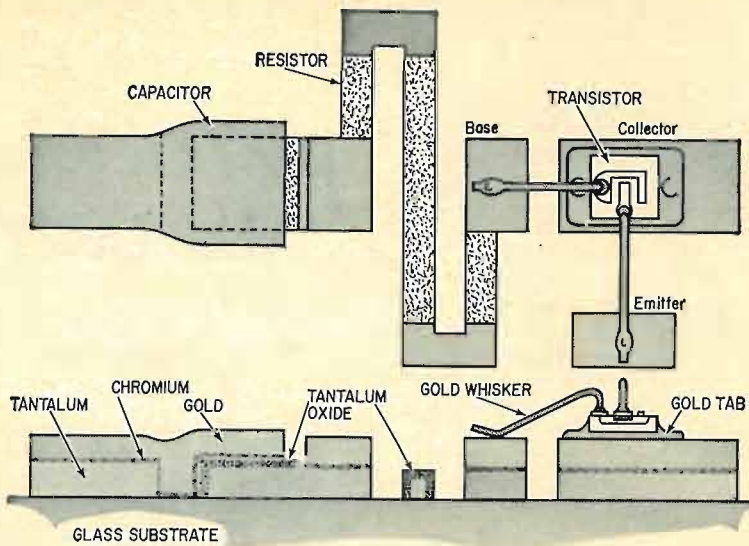

Fig. 1—Top and side views of a typical thin-film microcircuit. Tantalum pentoxide (Ta_2O_5) is a good insulator, used both as a dielectric and as a protective skin over resistor areas.

resistors have been made with tolerances as close as 0.4%.) Reliability becomes greater as deposited joints are substituted for soldered or welded connections. For example, a resistor in a thin-film circuit can be formed as an integral part of the circuit, rather than with joints between discrete components.

To introduce active elements to the thin-film circuit, semiconductors must be attached to the passive thin film. Active thin-film elements are being worked on in the laboratory, but have not yet been proved feasible.

Making thin-film microcircuits

Philco uses *sputtered* tantalum for fabricating resistors, capacitors and conductors in thin-film microcircuits.

Sputtering is a process based on an electric discharge between two plates in a gas (generally argon) at low pressure. Ionized gas atoms are accelerated to the tantalum cathode by a high-voltage field and knock off tantalum atoms. These diffuse to the glass substrate on the anode. Sputtering wastes little material, and the deposits adhere excellently. Uniform deposition is possible over large

areas (3% sheet resistivity variation over a $2\frac{1}{2} \times 3$ -inch substrate).

Gold is afterward deposited on the tantalum to increase the conductivity of the conductors and for connections to the package and active elements. A thin layer of chromium is placed between the tantalum and the gold. This chromium layer acts as a *glue* to bond the layers together. Capacitors are formed by *anodizing* the lower tantalum layer. This produces an oxide layer (Ta_2O_5) on top of the tantalum. This becomes the dielectric. The capacitor is completed by depositing a gold layer on top of the oxide. Resistor areas (bare tantalum) are also anodized to form an oxide layer which acts as a protective skin over the resistor. The active elements—silicon transistors and diodes—are added in the form of pre-tested chips. Simple photographic mask changes during the photoengraving make the fabrication process more flexible. Fig. 1 shows resistor-capacitor construction and an added active element (transistor).

In the Philco process, a vacuum chamber is used only to produce the thin films. The circuitry is etched externally with high-resolution photolithographic masking. This eliminates the problems of mechanical masking. The high-resolution photoengraving, plus the high heat-handling capability of refractory tantalum, permits high density microcircuitry (more circuitry per unit area). Photoengraving also makes it possible to design and lay out more intricate patterns rapidly at lower setup cost than mechanical masking. The masking steps proceed as follows: First, the substrate with its initial tantalum layer is photo-etched and the tantalum removed everywhere except where a resistor, capacitor or interconnection is to be formed. Then a second photo-mask is used to expose the remaining tantalum everywhere a resistor or capacitor is to be formed. This exposed tantalum is then chemically anodized to form an oxide layer. The chromium-gold multi-layer is placed over the entire substrate and a third set of photomasks used to remove the gold except where an interconnection, bonding point or capacitor is wanted.

Hybrid circuits

Many passive circuits may be produced in a multicircuit array, then cut apart to add the active elements and assembled into the package (either a multi-lead TO-5 transistor case or a 2-dimensional, 12-lead ceramic-to-metal package). The photos on the preceding page show a multicircuit array (RTL flip-flop) and assembled units. A seven-resistor precision ladder network is shown in Fig. 2.

The thin-film diode logic commutator for an aerospace application shown in Figs. 3 and 4 is an example of thin-film circuitry. The matrix consists of 96

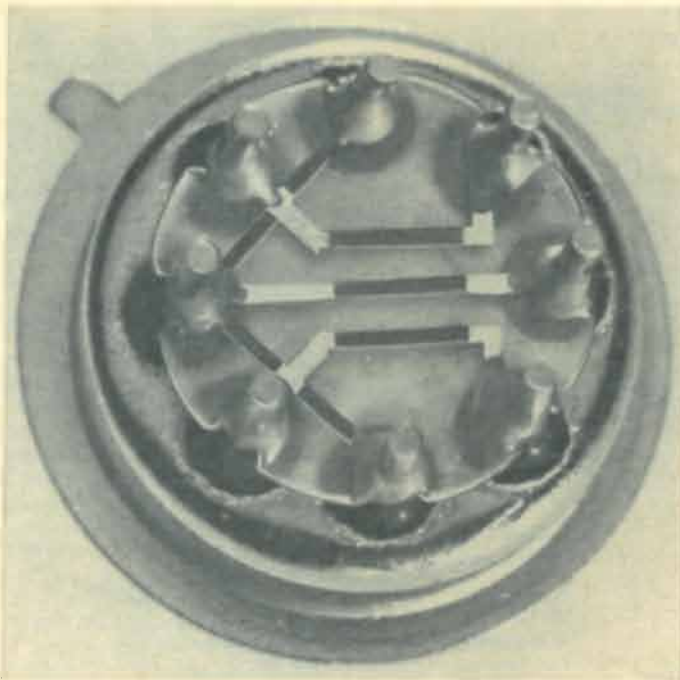

Fig. 2—A seven-resistor ladder network. Actual size of "header" is about $\frac{1}{4}$ inch. Resistors are adjusted to .04% of design value.

Do You Know the Law?

By TOM JASKI

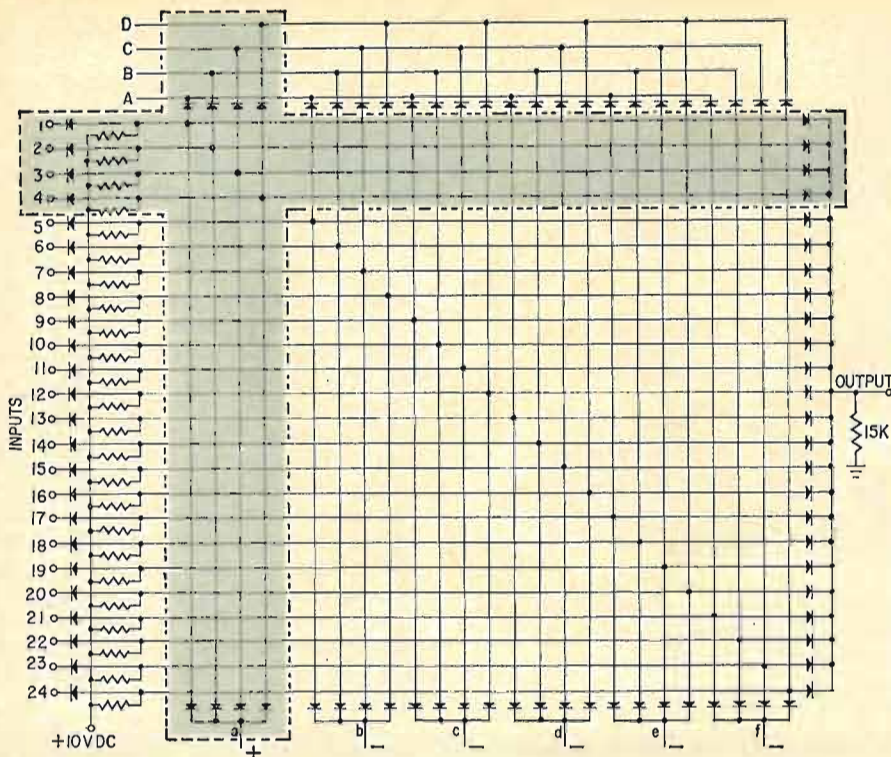

Fig. 3—Functional circuit of thin-film commutator whose operation is described in the text. A back bias of +10 volts is applied to A and a and a forward bias of -10 volts to all other elements to create a path from input 1 to output.

silicon diodes, 24 tantalum film resistors, and associated conductors and interconnections. The matrix is shown schematically in Fig. 3. The purpose of the finished commutator (Fig. 4) is to switch 24 different information points or input signals into a single output channel sequentially. The control diodes, biased by external control circuits, do the switching. (Input signal swing is limited to $\pm 10v$.) For example, if input 1 is to be monitored, the biasing arrangement would be:

1. Diode bank *a* receives a back-biasing potential (+10v), while diode banks *b* through *f* are forward biased (-10v). As a result, input signals 5 through 24 are shunted away out of system through control lines *b* through *f*.

2. Control diodes B, C and D are forward biased (-10v) while diode A is back biased (+10v). This results in input signals 2, 3 and 4 being shunted out of the system through B, C and D. Signal 1 then proceeds alone to the output monitor. END

Solid-state microcircuitry will be described in a later article.

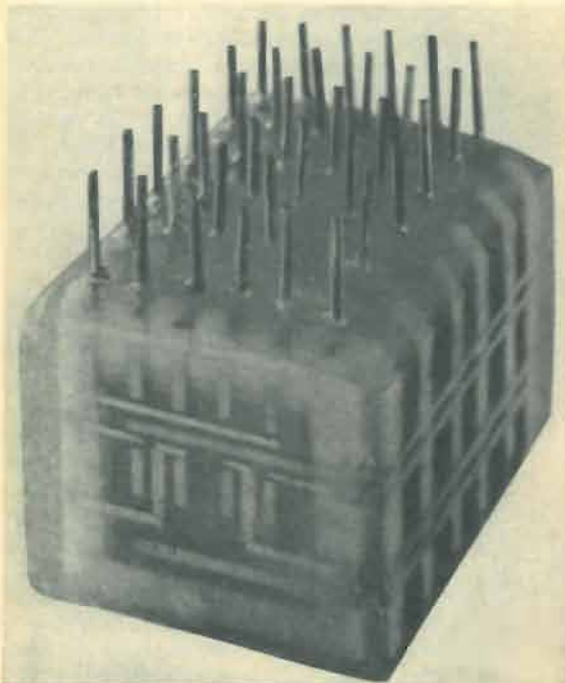

Fig. 4—The logic commutator of Fig. 3 ready for insertion in a circuit. It is encased in a potting compound, and its volume is approximately a cubic inch.

JUST about everyone who ever soldered two resistors together knows Ohm's Law. But in electronics we deal daily with many relationships expressed as laws and attributed to their discoverers, meaning they are considered to be laws of nature—incontrovertible truths about the world around us. Although some laws have been found inadequate, and some will no doubt be found to be actually wrong, the laws in this little quiz have so far stood the test of time. Here they are. Do you know the laws underlying the electronics you are using in your work?

1. Kirchhoff was a German physicist born in Königsberg in 1824. He is credited with what we call the two "Kirchhoff's laws" used in electronics. Do you know what they are?

2. When you have a current through a resistor and wish to express the losses in it, you know that this is represented by I^2R . But do you know whose law says it is?

3. Ever hear of Poynting and his law?

4. Do you know what Lenz' law is?

5. Neumann had something to say which concerns you every time you deal with an if transformer. Can you figure out what it is?

6. Again the man and the work he is most well-known for are not the law named after him. Wien, of Wien bridge fame also has a law, not dealing with bridges. Unless you know illumination, you probably don't know it. But Wien's law now also enters electronics via infrared advances.

7. Helmholtz is most widely known for his research and essays on human hearing. Yet Helmholtz' law had nothing to do with hearing, but dealt with charges instead. Know it?

8. Three physicians got together and named a law after all of them, Wiedeman-Franz-Lorentz law. If you know this one, you qualify as a science professor (or you're just lucky).

9. Let's not forget the great Faraday. His law is very important in electromagnetic phenomena, and shows how this great scientist was well ahead of his time.

It is no disgrace if you do not associate these effects with their laws. Most engineers know the effects, but have all but forgotten who discovered and expressed them in the form of a law. They are useful just the same.

(Answers are on page 57)

SERVICING SOUND MOVIE PROJECTORS



Part II—Clutch mechanisms, threading, safety precautions

By JACK DARR
SERVICE EDITOR

LAST MONTH WE FOUND OUT HOW DIFFERENT kinds of projectors work, and some of the mechanical problems they present. This month, we'll look at two more specific mechanisms, what they do and what can go wrong with them. Also, a little lesson in threading and running a machine.

The clutch

Most better-grade projectors are provided with a clutch to disengage the motor from the gear train. This clutch can be used for still-picture projection

By JACK DARR SERVICE EDITOR

of a single frame, etc. Some units have an automatic clutch, operated by a trip lever in the film path. If the film breaks or anything jams, the clutch is automatically released, stopping the machine. The projector in Fig. 1 has this arrangement; the trip lever is hidden behind the lens barrel, but the reset lever can be seen directly below the film gate, at the bottom. It is in its tripped position; to engage the clutch, raise it until it catches.

So, if you get a machine in for service with the complaint "The motor runs but nothing else will!" look at the clutch.

Safety shield

As we just said, these machines can be stopped to show only a single frame of the film, or "still." With a high-power projection lamp, stopping a frame of film in the beam of light will result in something like Fig. 2! Something must be done to reduce the intensity of the light. A perforated aluminum shield is automatically dropped in front of the lamp whenever the machine stops. This is inside the lamp housing, and fits in a slide. The top of the shield is bent, to form a "blade" in the stream of air blown through the lamp housing by the cooling fan. As long as the fan is running, the shield is blown up and out of the gate. When the air stream stops, the shield falls before the lamp. Enough light gets through the perforations to show still pictures, but the intensity is reduced to the point where it will not burn the film.

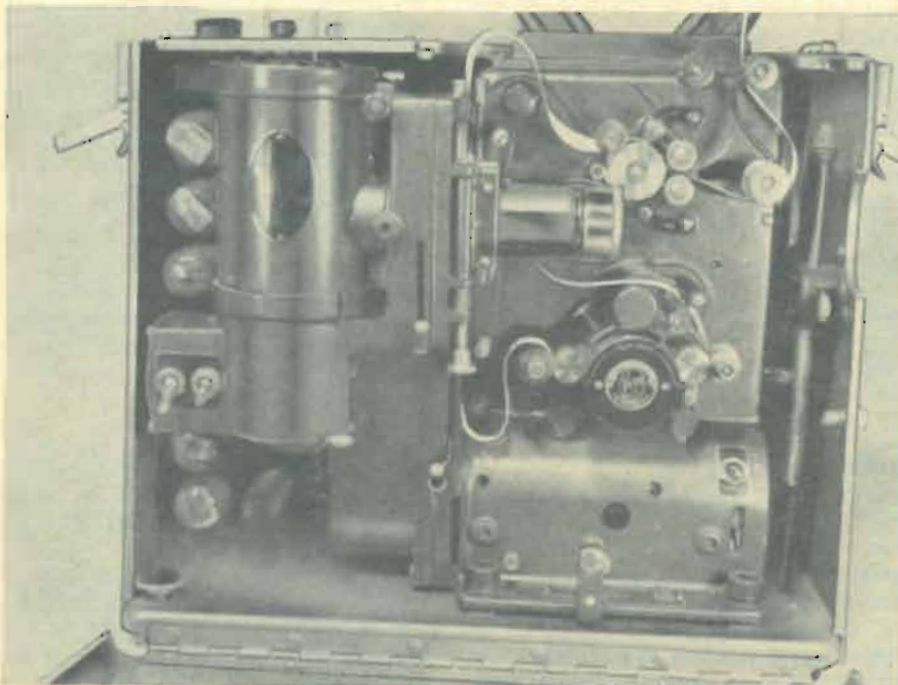

Fig. 1—Clutch on this projector is automatic. Reset lever is shown; trip is hidden behind lens barrel.

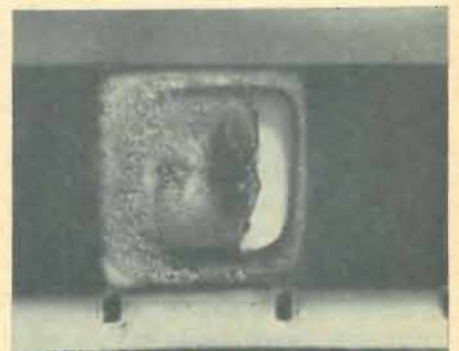

Fig. 2—This is what happens to film if it stops in the gate and the safety shield doesn't fall.

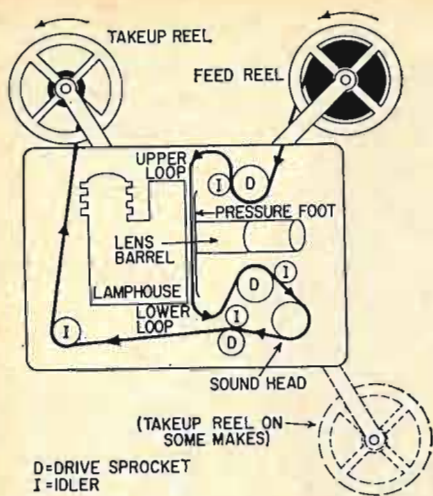

Fig. 3—This threading diagram applies to almost all machines. Some have take-up reel below feed reel, but film path is the same.

This can be checked easily by aiming the projector at the screen, without any film in it. Stop the motor and watch the screen. If you see the light dim quite noticeably, the shield is working as it should. If dust fouls the slides, sometimes the shield will not be free to "blow up", and the projected picture will be dim. You can check this by running the machine without film, and looking into the lens through dark glasses. If the shield is jammed, you'll see the perforations very plainly. Another method is to throw the machine out of focus, with the beam on the screen. At one point, you'll be able to see the image of the lamp filament, if the shield is out of the way. Usually, cleaning out the dust with a soft brush is enough to cure this trouble. Be careful, though, as the shield is made of very light aluminum, and can be damaged.

Threading up

Threading film through an unfamiliar projector can be difficult. Instructions can be found in the instruction book; if it is missing, you may have a hard time. Some machines, as noted, have guide lines, etc. to show the film path. As a general rule, though, you can thread up any "stranger" by following this sequence: Put the full reel (the feed reel) on the front of the machine. The empty takeup reel will be on the back. Start the film over the nearest idler roller, then trace out this sequence—drive sprocket, film gate, under the pressure foot—another drive sprocket—over sound reel—drive sprocket—idler—then to takeup reel. There will almost always be two drive sprockets, one on either side of the sound head, plus idlers to keep the film tight, and another drive sprocket above

Fig. 4—Lens barrel is removed to show lever that moves it and film gate forward to allow threading film through gate. Spring-loaded pressure foot normally holds film snugly against backplate.

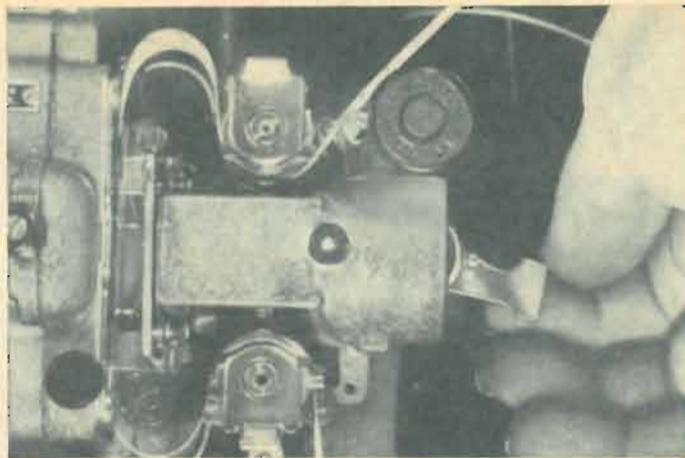
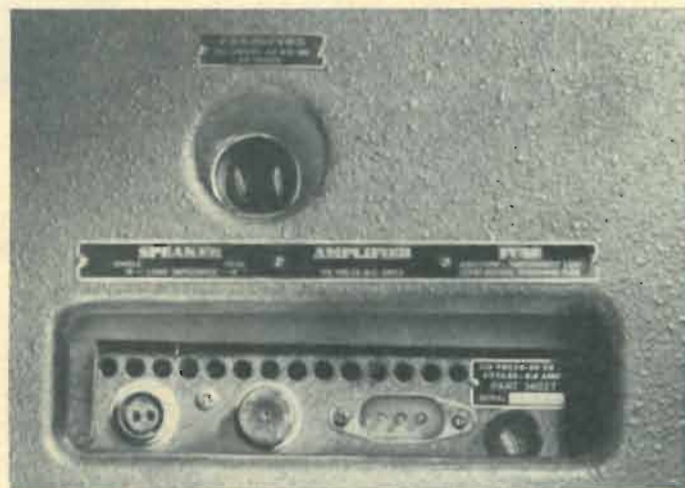

Fig. 5—Typical power and speaker connection panel. Note separate power connectors for projector motor and amplifier.



the film gate, or pressure foot. Fig. 3 shows the basic outline of this.

You'll have to open the film gate to slip the film under it. There are two ways of doing this in commercial machines. The lens-barrel, foot, etc., swing open on hinges, as in the machine of Fig. 1, or the lens barrel and foot slide forward, operated by a lever, as shown in Fig. 4. The lens barrel has been removed here to show where the lever is located, as it is hidden when the machine is operating. The gate is open in this picture.

When you close the film gate, be sure that the film is in the groove where it must run; you'll be able to see this clearly. If the pulldown teeth are retracted, you can slide the film slightly up and down to see if it is free.

Setting the loops

The most important parts of threading up are getting the film tight over the sound head, and getting the right amount of slack in the loops above and below the film gate. The proper amount of slack is sometimes indicated by ridges on the housing. Fig. 4 shows this, and film threaded with the correct loop.

Drive sprockets always have some sort of latch to keep the film in place.

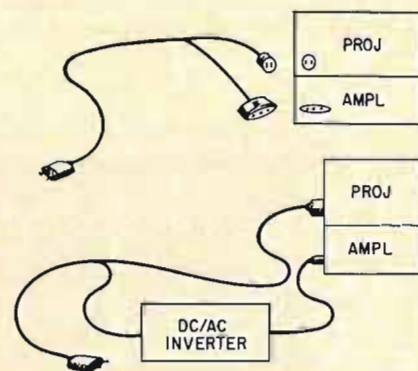

Fig. 6—Reason for separate connectors, shown in Fig. 5. On ac, both are paralleled; on dc, motor and lamp are powered directly, but amplifier power goes through dc/ac inverter.

Sometimes this is a spring-loaded tab, sometimes a spring-loaded idler roller on an arm. Both can be seen in several pictures here and in Part I.

After the machine is threaded up, turn the motor on and make a short test run. Keep your finger on the switch! If there is anything wrong, or if the film isn't threaded right, the powerful gearing can break the film instantly! The best clue here is to keep an eye on

the loops: if either loop pulls down tight, something is wrong. Turn the machine off immediately and find out what! (Incidentally, damaged film can cause this trouble, so be sure to check the film. Take a close look at the section of film running between the drive sprockets. Examine the bottom edges of the sprocket holes. You may find them torn and ragged instead of nice and even. This type of damage may have been caused by incorrect threading or by worn pull-down teeth. We'll go into this in the next article.)

Motors and power supply

Practically all the machines I know use "universal" motors, which will operate on either ac or dc, 117 volts. The larger machines use transformer-powered amplifiers, which must have ac. Fig. 5 shows the power-supply connection panel for a well known make. The line cord for this machine is a "Y", as seen in Fig. 6.

(This feature probably originated when these machines were built for use in Army training programs. Many times, the projectors had to be used on field generators, at 110 volts dc. For this kind of service, the amplifier power plug was pulled, and a dc/ac inverter inserted between the two, as shown. Failure to use the inverter accounted for many a power transformer replacement!)

Some projectors use ac/dc amplifiers; the machine seen in Fig. 1 has this circuit. These can be used without the inverters, of course; they use such tubes as 50L6, 35Z5, and so on.

Next month, we'll examine some of the electronics of sound projectors, and offer some service tips for both mechanical and electronic troubles.

TO BE CONTINUED

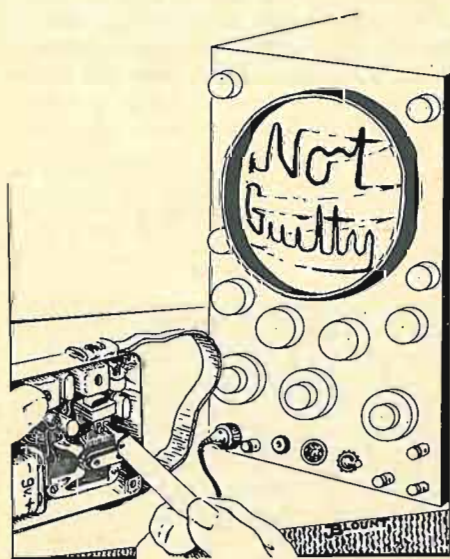

Diagnosis and the Frozen Brain

By JOHN FITZGIBBON

FIXED IDEAS CAN REALLY FOUL UP THE diagnostic process while you're repairing TV circuitry. Here's a good example.

I was fixing up an old Stewart-Warner 9126 for use in some experiments. The horizontal oscillator circuit was quite conventional: 6AL5 phase detector/afc and a 6SN7 cathode-coupled multivibrator with a ringing coil for the horizontal oscillator. How simple can you get? Everything nice and normal.

Horizontal hold acted peculiarly, though. This is the slug in the ringing coil, by the way. When I turned it clockwise, from an out-of-sync state, the picture wouldn't lock in but flipped rapidly out of sync the other way! Had to back up on it counterclockwise to get it to hold. Even then, I'd get a split picture with blanking bar in the center about every third time.

"Ah-ha!" said I. "This is afc trouble. Everyone knows that such conditions are always caused by afc. Especially since I've made the test that they tell you to: shorted the grid of the horizontal oscillator, removing the sync. Then, the oscillator made a single floating picture, pretty stable. This *proves* that the trouble is in the afc!" (Can you hear the ice beginning to form on my mental processes along about here?)

So, I investigated the afc circuits.

times "they" are usually conspicuous by their absence; they've gone out for coffee or something. So there I sat with my little soldering iron, all alone.

After a period of time which shall not be discussed, I tentatively decided that there just *might* be something else wrong, and I'd check the oscillator again. So, I unsoldered the coupling capacitors, grid resistors, grid bypass capacitors, etc., and found them all in fine shape, except for a minor leakage in the .05- μ f grid bypass capacitor. After I replaced this, I happily turned the set on. Same trouble. I picked up my face from where it had fallen and resumed testing.

Eventually I came to the 3,900-ohm plate resistor. "Everyone knows" that these resistors aren't too critical; in fact, I'd replaced and changed value on any number of them in the past, without affecting the oscillator performance. Oh, well, I'd checked everything else; might as well check this one. Hmmm. About 7,500 ohms instead of 3,900. Oh, well. Replace it. Turn set on. Works perfectly. Horizontal hold falls out the same on each side; nice smooth bars instead of squegging as it has been. Hmmm. Go out for coffee.

Return. Set still perking beautifully. Check hold. Fine. Oh, me. What did I

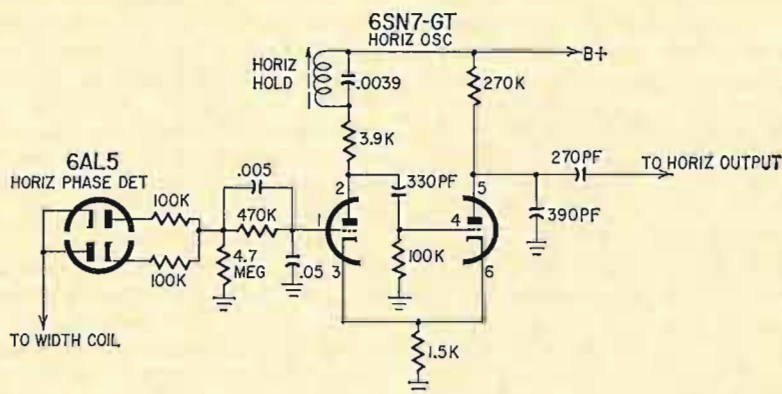

I measured resistors, checked capacitors, replaced tubes and carefully measured p-p amplitudes and waveforms on the sawtooth pulses. Only one thing was amiss: *there was nothing wrong with the afc!* Everything was perfectly normal!

Despite this evidence, the brain remained frozen solid. I had made a diagnosis, and by golly I was going to stick to it! There *had* to be some trouble in that afc! So, I repeated some of the tests, then measured the sync amplitude; why, I'll never know. (It was good, too, incidentally.) So, what do "they" say at a time like this? They don't. At such

do wrong? Answer immediately apparent: I froze up on the diagnosis! At first, my tests and conclusions were OK: the symptoms *did* point to the afc, because of the way the oscillator was acting with the afc shorted out. However, after the afc checked out good, I should have realized *immediately* that this was not causing the trouble, and that the oscillator circuit was the only thing left!

Moral: no matter what fixed ideas you have about a circuit, don't freeze on your first diagnosis. Always be willing to throw that away and make a new one to fit new evidence! END

GOING MULTIPLEX WITH AN ADAPTER

If your old mono tuner has what it takes, this may be the most sensible way

By HERMAN BURSTEIN

WITH MANY FM STATIONS NOW BROADCASTING multiplex programs, most audiophiles who haven't yet converted from mono to stereo FM have a strong urge to do so. They can either buy new multiplex tuners or add multiplex adapters to their present mono tuners. Where the mono tuner has been a dependable servant—with high sensitivity, sharp selectivity, drift-free tuning, low distortion and low noise—the owner is rightly inclined to purchase a multiplex adapter and save money.

If maximum performance is the objective, adding an adapter may not be simply a matter of bypassing the tuner's de-emphasis circuit and making cable connections. Satisfactory multiplex reception makes greater demands on the tuner than does mono, and your tuner must be in tip-top condition. Further, the tuner and the adapter must be properly mated for good performance and convenient operation. Here the audio technician can be very useful. How useful is illustrated by this case history, which is also a checklist of things to consider in converting to FM stereo.

The customer owned a Browning RV-10A tuner (about 11 years old and one of the finest of its day) and wanted a multiplex adapter that could be tucked

away in his equipment cabinet without the need for switching manually between mono and stereo. He chose the Pilot 200 adapter, which has automatic switching. The following steps were taken for maximum performance and operating convenience.

Checking tubes and other parts. A couple of tubes that failed to measure good were replaced. Electrolytics were checked, and all were good. Operating voltages shown on the schematic of the RV-10A were checked. All were correct.

Tuner alignment. The tuner was very carefully aligned. First, using a 10.7-mc signal frequency-modulated at 60 cycles, the i.f. transformers were touched up for a good "flat-top" response curve (Fig. 1), as viewed on scope. The curve should have symmetrical proportions, maximum amplitude consistent with a bandwidth of about 180 to 200 kc. Second, using the same signal, the discriminator transformer was aligned for an S-curve (Fig. 2) with excellent symmetry and linearity and maximum amplitude, as viewed on a scope. The discriminator alignment was touched up by using the test frequencies of an IM distortion analyzer to modulate the 10.7-mc signal, and adjusting the discriminator for minimum IM distortion measured at the tuner's output jack. Third, using signals of 105 and 90 mc, the rf, oscillator and mixer stages were aligned for maximum gain and for dial calibration. These alignments were then touched up by the IM distortion method.

Removing de-emphasis. FM stations are required to apply a 75- μ sec boost to the audio signal, meaning that response is up 3 db at 2,122 cycles and continues to rise at a rate approaching 6 db per octave. (Thus response is up 13.7 db at 10,000 cycles and 17 db at 15,000 cy-

cles.) For flat audio response, the FM tuner must provide 75- μ sec de-emphasis. However, the signal fed to the multiplex adapter must be free of such de-emphasis. Therefore, the de-emphasis network of the RV-10A (Fig. 3), consisting of a 75,000-ohm resistor and a .001- μ f capacitor was removed. Some mono tuners, anticipating stereo, have a multiplex jack connected before the de-emphasis network. Nevertheless, it is a good idea to remove this circuit when feeding a multiplex adapter.

Reducing shunt capacitance. To obtain as much stereo separation (distinction between left and right signals) as the multiplex adapter is capable of, the mono tuner must maintain response after the detector to 53,000 cycles. Therefore it is important to minimize shunt capacitance between the discriminator output and ground. As shown in Fig. 4, the discriminator output of the RV-10A originally ran to a selector switch (this tuner has three input jacks for high-level sources), from there to a volume control and finally via shielded cable to the output jack. This circuitous path introduced a fair amount of capacitance, which was eliminated by running an unshielded lead about 3 inches long directly from the discriminator to the output jack.

The multiplex adapter came with a short low-capacitance cable for connecting the tuner output to the adapter. A lead about half as long was substituted to reduce capacitance even more.

Remote stereo defeat. For two reasons, the customer wanted a remote control to enable him to defeat the stereo signal and hear the mono signal instead. First, he wanted a ready means of comparing mono and stereo signals. Second, sometimes the adapter is fooled by noise or strong harmonics of a mono broad-

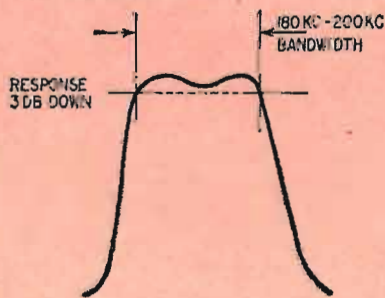

Fig. 1—Part of "what it takes" is sufficient i.f. and detector bandwidth. This curve shows how the response should look.

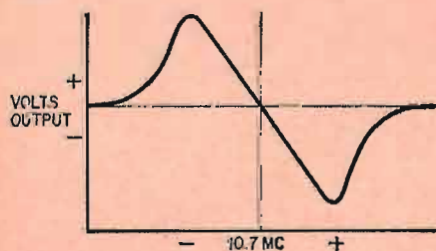

Fig. 2—Detector curve should look like this for minimum distortion.

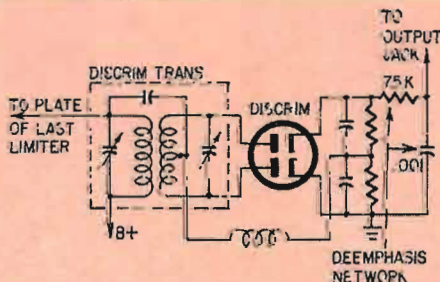

Fig. 3—Partial schematic of old Browning RV-10A's discriminator. For stereo, de-emphasis must go and so must most of stray capacitance.

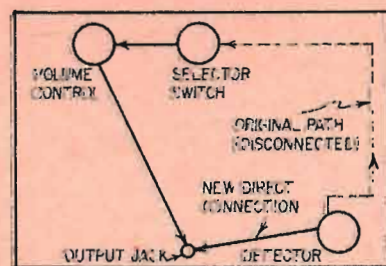

Fig. 4—Long, roundabout audio route in original layout would have meant poor stereo separation. Direct connection is always best.

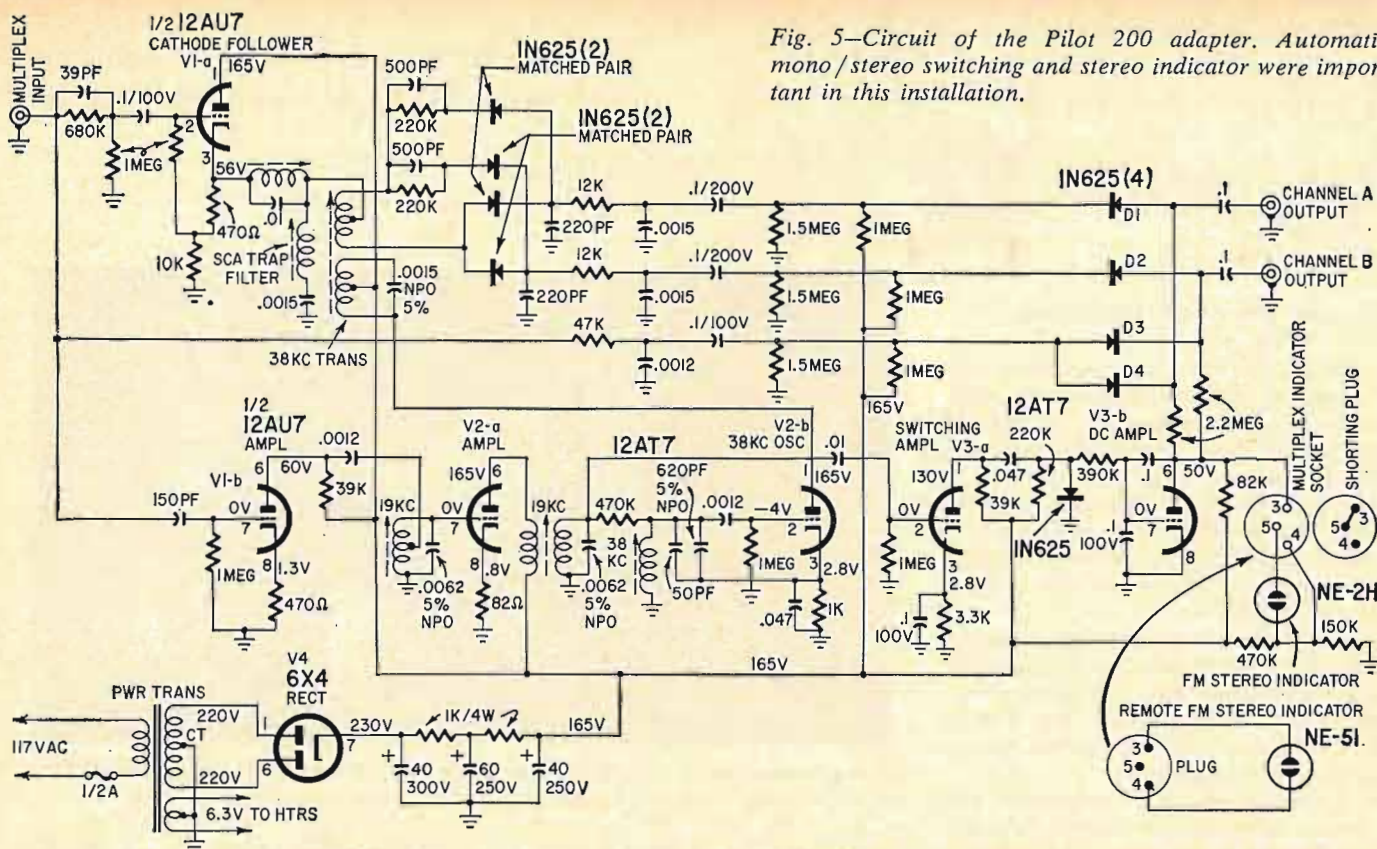

Fig. 5—Circuit of the Pilot 200 adapter. Automatic mono/stereo switching and stereo indicator were important in this installation.

cast into thinking it is receiving the 19,000-cycle pilot of a multiplex broadcast. The result is a rushing, roaring sound that closely resembles Niagara Falls. In theory, paralleling the left and right signals at the stereo preamp can reconstitute the mono signal and cancel the rushing-roaring noise. However, the customer wanted to be able to check theory against practice, and so a remote defeat switch was very easily installed as follows.

Fig. 5 shows the Pilot 200 circuit. It includes an electronic switch that, by changing the voltages across four silicon diodes (D1-D4), permits the stereo signals instead of the mono signal to reach the output jacks of the adapter. The switch is controlled by V3, which is activated by the 19,000-cycle pilot that accompanies a multiplex broadcast. To defeat a stereo signal, it was necessary only to run a lead from the grid of V3-b to the now-unused selector switch of the RV-10A and rewire the switch so that in its first position it would act as a short to ground. The lead from V3-b's grid was connected via a phone plug to one of the tuner's unused input jacks, which in turn was wired to the tuner's selector switch.

Stereo indicator. The voltage developed across V3-b's plate resistor when

a stereo signal is being received also serves to light an NE-51 lamp, which is at the end of several feet of extension wire. The RV-10A is located behind a wooden panel in the customer's equipment cabinet, and the indicator lamp was mounted behind the same panel. A hole was drilled in the panel and fitted with a "jewel" to let the lamp shine through.

Ac extension socket. The mono tuner should have a switched ac socket from which the multiplex adapter can draw power. Since the Browning RV-10A had no such socket, one was installed at the end of several inches of cord (Fig. 6). The adapter could have been plugged into the switched ac outlet of the customer's preamp, but this would have meant needless operation of the adapter when, say, the phonograph was being used but not the tuner.

Antenna. The customer had been getting clean, noise-free mono reception with a simple folded dipole made of TV ribbon stapled behind his equipment

cabinet. But multiplex signals are inherently much weaker than mono and there was noise on stereo programs (unless the stereo defeat was used). Also, there seemed to be increased distortion. We connected the tuner to the customer's TV antenna, and cleaned up both troubles. A dpdt switch was installed so that the owner could connect the antenna to either the tuner or the TV set. He plans soon to install a separate high-gain antenna specifically designed for FM.

The result is a satisfactory installation in performance and operating convenience. Program material sounds just as clean in stereo as in mono, noise is nearly as low, and stereo separation is excellent. The adapter is automatically turned on with the tuner, and automatically switches to stereo. The remote indicator shows when a stereo broadcast is being received. The customer can restore mono operation either through the stereo defeat switch located in the tuner or by paralleling the left and right channels in his preamplifier. END

Pilot's model 200 multiplex adapter — the one used in this conversion.

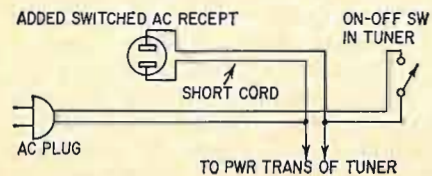
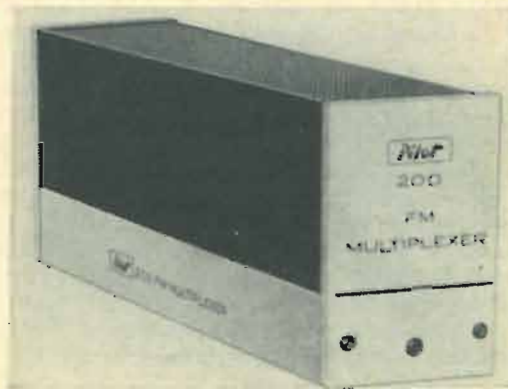

Fig. 6 — Added ac outlet turned adapter on and off right along with tuner.



You probably have most of the equipment already. What are you waiting for?

SERVICING **CB** TRANSCEIVERS

By **JIM KYLE, KEG-3382**

SOME 350,000 POTENTIAL CUSTOMERS in this nation (more in Canada and eight South American countries) are looking for skilled radio service for both receivers and low-power transmitters.

I'm referring, of course, to the users of Class-D Citizens Radio (General Radio Service, in Canada; Comunicaciones Personales in the Latin-American regions).

You've probably run into some of these potential customers—and possibly you turned their business down either because the circuits looked too strange to you, or you felt you had to have a license to do anything.

The circuits are a bit unusual, yes—but certainly none of them are as tricky as a Synchroguide or a color convergence job. And, contrary to popular belief, you can do almost anything to a CB unit without a license! The only adjustments or repairs for which a license is necessary are these:

1. Any adjustment of the transmitter oscillator circuit which can affect the frequency of the transmitted signal.
2. Any adjustment of the transmitter audio circuits which can cause modulation greater than 100%.
3. On-the-air tune-up of the transmitter final amplifier. However, an unlicensed person can tune up the unit if it is connected to a dummy load instead of to an antenna.

You can see from this that all receiver adjustments, and many transmitter repairs, require no license.

If you do much of this work, sooner or later you're going to have to have that Second-Class Radiotelephone ticket. A future RADIO-ELECTRONICS article will cover the adjustments for which you need a license, and how to get one.

What you're up against

Almost all CB units in service today are transceivers (combination transmitter-receivers). Transmitter and receiver share the same audio circuits and power supply.

Let's look at the transmitter first.

Most CB transmitters have either two or three stages. The first one, in all cases, is the oscillator. This is always crystal-controlled and usually uses one of the three circuits shown in Fig. 1.

The major difference between a CB rig's oscillator and any other crystal oscillator is the trimmer, C. Not all



Most CB transceiver trouble is caused by bad tubes or bad crystals. This Globe device doubles as power output meter and crystal checker.

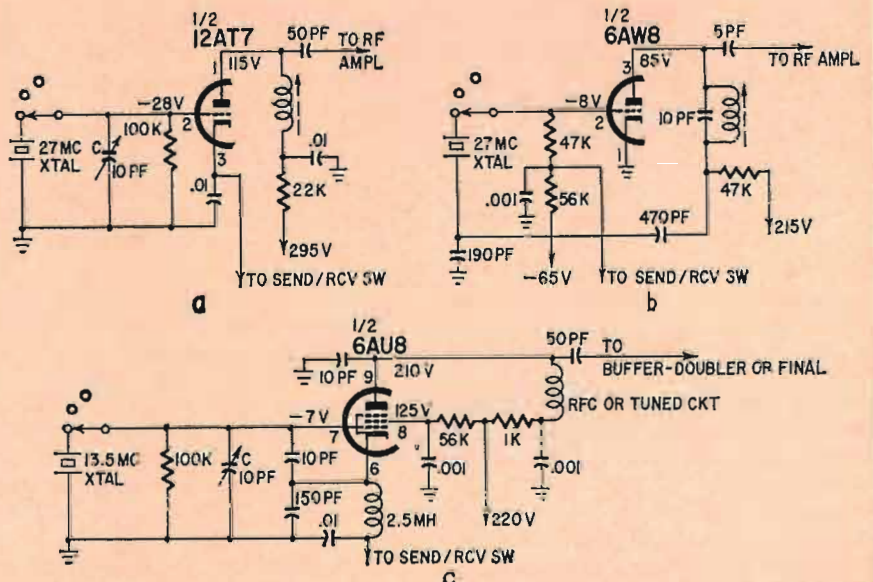

Fig. 1-a—Simplest of widely-used oscillator circuits is triode overtone oscillator. Plate voltage is much lower than supply. Uses 27-mc crystals. b—"Robert Doller" overtone circuit also uses 27-mc crystals. This circuit is from Lafayette HE-20. c—Colpitts circuit uses 13.5-mc crystals, doubling in plate or in separate buffer-doubler stage.

units include this trimmer, but most do. Its purpose is to adjust the crystal frequency to exact tolerance (FCC regulations allow only 1,300 cycles error in frequency). Unless you have a license and proper equipment to measure frequency, don't disturb that trimmer!

The oscillator may drive the final amplifier directly, or it may drive an intermediate buffer stage which in turn drives the final. The major difference between the buffer and the final is that the final is modulated. Fig. 2 shows a typical final amplifier circuit.

TV vertical output tubes, almost universally used for CB transmitters, have the dual advantages of being rugged and inexpensive. You probably already have all the popular ones in stock. (Occasionally, a set will pop up using an audio output tube instead—in the early days the 6AQ5 was popular, but the 6CX8 leads now.)

The receiver is almost identical with a standard ac-dc circuit with a few exceptions. Many CB units have crystal-controlled oscillators on the receiver as well as the transmitter. This makes tune-

up easier as well as operation! Almost all have some sort of automatic noise-limiter (anl) circuit. Most also have a squelch, but this belongs in the audio circuit. Many include S-meters.

Automatic noise limiters

The anl circuits are designed to block ignition noise pulses while allowing the desired audio to pass through. All of them are based on the idea of passing the audio signal through a biased diode, then having any strong noise pulse turn the diode off momentarily to block the audio path. Bias from the avc line is used for the diodes; this makes it "automatic" since the bias level is proportional to the strength of the incoming signal.

A typical anl circuit is shown in Fig. 3. However, this area is one in which much variation still exists and you'll see many circuits which look nothing at all like this one!

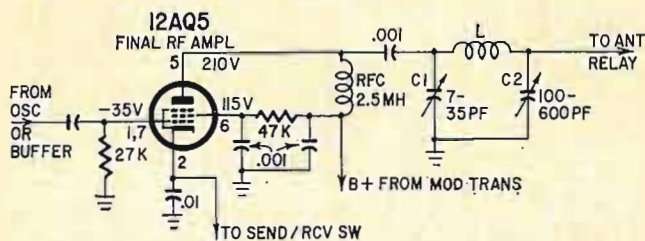

Fig. 2—Typical final amplifier (Sonar Model E). Tube could also be 6EM5 or pentode section of 6CX8.

In Fig. 3, half of the 12AL5 detects the incoming signal and develops a negative voltage across R20, R22 and R23. Avc is taken off through R21. The audio signal and a portion of the negative voltage are taken off from the junction of R22 and R23, and applied to the plate (pin 7) of the other half of the 12AL5.

The cathode of this half of the diode (the noise limiter) is connected through R24 to the avc line. With no signal applied, the plate is about half a volt more negative than the cathode. With enough signal to develop 10 volts avc, the plate will be about 5 volts more positive than the cathode and the diode will conduct. (Actually, it will conduct with any usable signal since the cathode gets full avc voltage while the plate gets only about half the avc voltage. Both are negative to ground but the cathode is more negative than the plate.)

However, the avc voltage supplied to the cathode is filtered by C25, and, if a fast noise pulse comes along, the cathode voltage will not change. The plate voltage, not being filtered, will go highly negative. This cuts off the diode, and no audio can get through. As soon as the noise pulse is past, the plate returns to normal and the audio once more passes through.

The S-meter is nothing more than a built-in vtvm measuring the voltage on the avc line. Often, to save parts, it uses an i.f. tube as its active element, comparing the screen voltage of this tube to a fixed value (frequently the cathode volt-

age of the audio output tube).

As the avc level rises with a stronger signal, the screen current to the i.f. tubes will be reduced and the resulting screen voltage will rise. A meter connected from the screen to a fixed positive voltage will read this rise in voltage.

S-meter circuits can be headaches—S-meter and hobbyist users of CB equipment love nothing better than comparing S-meter readings. Naturally, no two S-meters will read alike due to natural differences in tubes, design and circuit tolerances. About the only thing you can do for this problem is to check out the circuit, make sure it is working, and explain the facts of "tolerances" to the unhappy owner!

Getting down to business

Let's look at some concrete ways of making money out of CB — how to troubleshoot it.

These are the tools and test equipment you'll need:

1. A good signal generator, well shielded, preferably with calibrated microvolt attenuator. It must cover the range 26-28 mc, and should cover frequencies from 175 to 1,800 kc.
2. A power output meter. This may be combined with an swr bridge, as in the Cescro Transicheck, Seco Antenna Tester, and Globe Tenna-Meter.
3. 20,000-ohms-per-volt vom with standard and needle prods.
4. Vtvm of any standard type. No special probes.

Helpful but not absolutely necessary at the start is a tube tester (you probably have one anyhow). Also help-

ful at times but actually rarely needed is an oscilloscope.

As in all service work, the first step is to find out what symptoms the customer noticed.

If nothing at all works, the problem is probably in the power supply. Standard troubleshooting techniques apply to the ac portions of the power supplies; standard auto-radio techniques apply to the mobile-radio parts of it.

If the complaint is poor reception

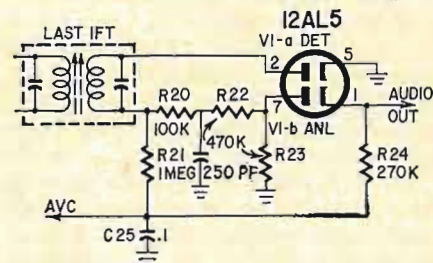

Fig. 3—Anl circuit of Globe CB-200; many others are similar series-limiters.

but transmitting performance is fine, realignment and receiver checkout are indicated. This also follows standard ac-dc practice, except that squelch controls, if present, should be turned wide open so you can hear what you are doing.

The complaint most likely to give you headaches at first is "poor transmission but the receiver works fine." This indicates troubles in the transmitter, of course. Here's how to check them out most rapidly.

Connect the dummy load and power meter to the antenna connector on the unit (Fig. 4), turn it on and let it warm up. Key the transmitter by pressing the microphone button and read output power. A reading anywhere between 2½ and 4 watts is normal for "full-power" jobs, with the average about 3 watts.

If the reading is low, connect the vtvm (set to read -dc volts) to the control grid of the final power amplifier tube and key the rig again. Normal read-



Here, power meter is inserted between transceiver and antenna, as shown in Fig. 4. If transmitter checks OK, trouble is narrowed down to receiver or audio.

ing here will vary, but should be about -20 volts.

If this reading also is low, take a reading at the control grid of the oscillator tube with the transmitter keyed on. This one should be between -5 and -10 volts with most sets.

If it's too low, substitute another transmitter crystal and see if it moves up. Frequently, a crystal will "age" and lose some of its activity. That same crystal, incidentally, may perform perfectly in another set!

If replacing the crystal does not bring output up, substitute another oscillator tube. Testing will show you nothing—substitution is the only reliable test for an rf oscillator.

If this, too, fails, measure the voltage at the plate of the oscillator in both receive and transmit. Transmit voltage should be lower than receive, and both

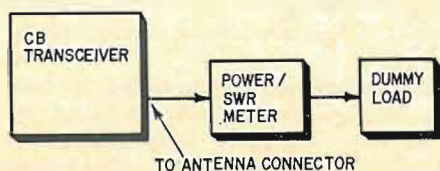

Fig. 4—Hookup for measuring CB transceiver output power. Heath "Cantenna" makes good dummy load (see June 1963 issue, p. 66), or use other non-inductive 50-ohm resistance. Avoid using light bulbs. Some power meters contain built-in dummy loads.

should be about 250 to 350 volts. (Some sets remove high voltage from transmitter tubes in "receive"; with these, proper reading in "receive" is zero volts.)

If oscillator plate voltage is less than 250, check the power supply (a few sets operate as low as 200 volts; with these, naturally, oscillator voltage will also be about 200). If there is more than about 10% difference between supply voltage and voltage at the plate, look for a defective component in the circuit.

If voltage at the final-stage grid is proper but output is still low, measure the voltage from plate to cathode of the final tube. It, too, should be around 300 (or within 10% of the supply voltage). Also measure the current by breaking the lead to the plate (Fig. 5) and inserting the vom, set to the 100-ma range. Multiply voltage and current to obtain input power in watts.

Normal input power is usually as close as possible to the legal limit of 5 watts. If your reading is less than 4 watts, retune the plate circuit to bring it up. The plate circuit usually has two variable capacitors (C1 and C2 in Fig. 2); tune C1 for minimum plate current, then C2 for maximum, alternating between them until you reach a 5-watt dc input. There is strong interaction between them, and each must usually be adjusted five or six times.

Keep the power output meter in the line when tuning the plate circuit. It's easy to load up to 5 watts input with the circuit misadjusted so that only 1 or 2 watts rf get out!

If you find it impossible to load to 5 watts, substitute another tube. If this doesn't help, trace the screen circuit for defective components.

Like everything else electronic, most CB troubles are caused by defective tubes. A close second is the aging crystal. Both, fortunately, are easy to check by substitution.

About service data: the best source of up-to-date service data on this equipment is the manufacturers themselves. The most recent count shows more than 100 manufacturers in the field, and only a few of them are represented in the data services. But you'll find almost all manufacturers eager to provide data on their equipment.

The specialized test equipment is easy to use. For example, on the Seco Antenna Tester, to measure output

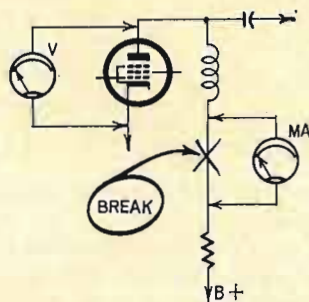

Fig. 5—Measuring dc input power. Break plate circuit and insert 0-50 millimeter or current range of vom. Measure voltage between plate and cathode, not plate and ground.

power, switch to FORWARD POWER position with the function switch, press the POWER \times 1 button, and key the transmitter!

Operation of other CB test equipment has been described in recent issues of RADIO ELECTRONICS. (See "CB repairs You Can Make Without A License," February, 1963, page 34, and "CB Servicing With A CB Set," September, 1963, page 34.)

In this space, we've barely been able to skim the surface of "non-license" CB servicing; not mentioned at all are such things as antenna installations, noise elimination in mobile installations, and a number of other things that may be covered in a later article.

For more extensive data on these, recommended books are *The Radio Amateur's Handbook* published yearly by the ARRL; *The CB Radio Mobile Handbook* published by Horizons Publications, Oklahoma City, and past issues of RADIO-ELECTRONICS. Much that applies to the hams' 10-meter band applies equally well to CB installations. END

Minimizing The Vtvm Pointer Shift

The zero setting of most service vtvm's shifts as the range selector is switched. Resetting the zero is a nuisance; not resetting it gives inaccurate measurements.

The shift is caused by "contact potential" grid current flowing through the high-resistance voltage divider (Fig. 1). Since only one grid circuit

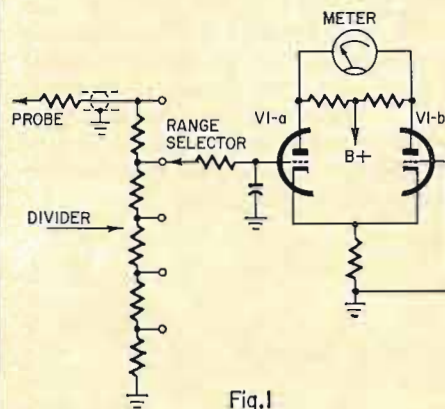

Fig. 1

contains this divider, while the other is grounded, changes in voltage drop unbalance the meter circuit as different resistances are switched in. The contact grid current through V1-b remains constant—that through V1-a varies as the range selector is switched to progressively lower voltages, thus switching more resistance into the grid circuit. In some vtvm's the V1-b grid goes to ground through a high-value resistor. Grid current is still constant, of course, though it may not differ from V1-a as much as with the grid grounded direct.

To insure equal drops on both sides, use a two-pole range selector and build an exact duplicate of the divider for the other side of the vtvm bridge (Fig. 2). Now the vtvm will stay bal-

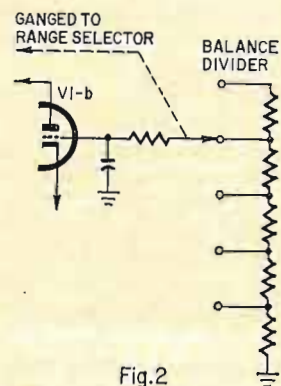
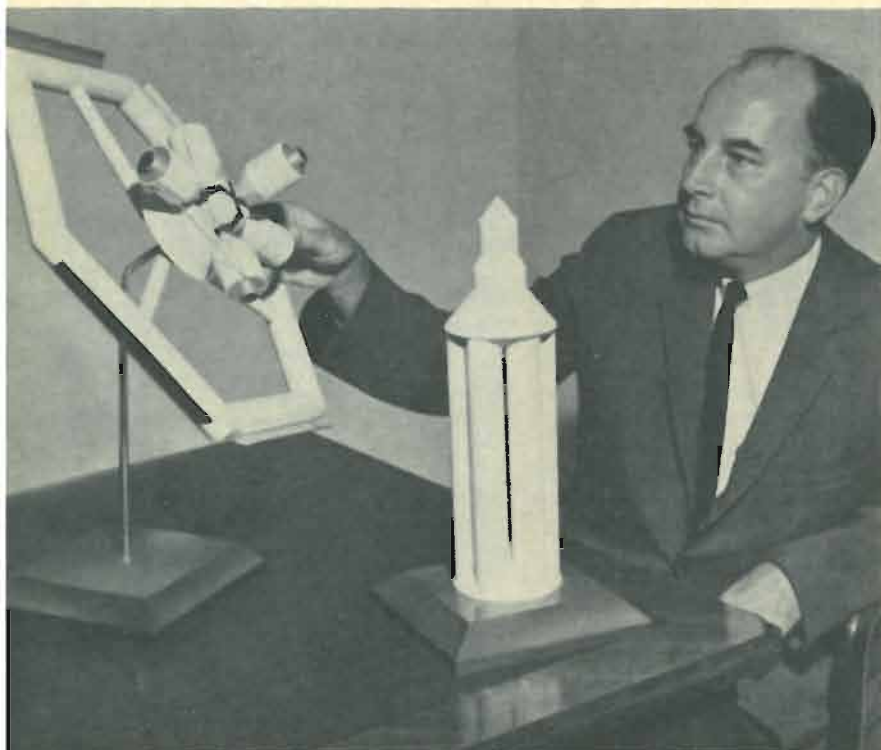

Fig. 2

anced at any setting of the selector, since each grid circuit always contains the same resistance.—R. M. Centerville

What's New



▲ **SPACE STATION DESIGN** won a \$400 prize from NASA Inventions and Contributions Board, and for its inventor, R. A. Berglund. The hexagonal model at left represents the station in space. The rocket-like object on the table is the same type of space station as it would appear when ready for launching.



▲ **SOLAR-POWERED BOAT** uses 40 solar cells to run its small motor, moving majestically through the water under radio control on sunny days. The sun ship was built by the Rev. Robert W. L. Mark of Hawley, Pa., known to **RADIO-ELECTRONICS** readers as author of articles on the old one-tube Twinplex circuit.

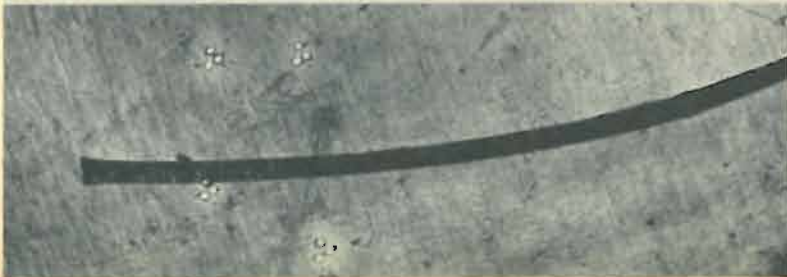

▲ **NEW LASER** is small enough to put in a coat pocket. About the size and shape of a frozen juice can, its signals can be detected 30 miles away. Raytheon developed the device and is testing it with the idea that it might be used by distressed boatmen and downed pilots to signal their position. It is shown above a small German power supply with which it was used, and which will fire it about 50 times before battery recharging is needed.

▲ **ELECTRON BEAMS DRILL HOLES** in .005-inch thick tungsten sheet. Only .0008 inch in diameter, these holes are drilled by the same electron beams that occasionally burn the screen of a TV tube. In short pulses of tremendous power, the beams can vaporize the most heat-resistant materials and produce almost incredibly small holes. A human hair is shown for comparison. The experimental device was developed by Westinghouse.

by Jack Darr
Service Editor

S Service clinic

This column is for your service problems—TV, radio, audio or general and industrial electronics. We answer all questions individually by mail, free of charge, and the more interesting ones will be printed here.
If you're really stuck, write us. We'll do our best to help you. Don't forget to enclose a stamped, self-addressed envelope. Write: Service Editor, Radio-Electronics, 154 West 14th Street, New York 11, N.Y.

A LOT OF OUR MAIL ASKS, "CAN I REPLACE THE — CRT IN AN OLD — WITH A (90°) (110°) — TUBE?" Fill in types and names yourself. Conversions such as this fall into three classes: easy, difficult and impossible. As a general recommendation, I'd say that you should never attempt a conversion job of this kind unless you're thoroughly familiar with the circuits and realize how much trouble it's going to be!

Easy conversions are those where the tubes have the same deflection angle—for instance, converting from a 17-inch 70° to a 21-inch 70° tube. Actually, we don't need much sweep to cover the added distance, for this will be surprisingly small—only about 2½ inches, horizontally.

If the set in question is one of those old "conservatively designed" jobs with ample power reserves, the job can be fairly simple. All we have to do is put the sweep circuits into first-class condition, and the extra deflection is easily obtained. However, if the set happens to be one of the "marginal" types, of the cheaper group, where every tube in the set is being driven to within an inch of its life (thus shortening said life tremendously!), you're probably going to have much trouble and woe! You know the type I mean; you've seen enough of them. The only answer to conversion questions for these sets is a firm "No!"

Conversion of these types would mean completely rebuilding the entire sweep circuit, and also the power supply! The cost of rebuilding such chassis would pay for a new color set, not only in new parts but in the time wasted. So, there's your first important factor: the size, age and type of the original chassis.

Second-stage conversions are those which have the necessary reserve power but will require part changes because of a change in the deflection angle of the new tube. For example, changing from a 70° to a 90° tube requires replacing the yoke in all cases. Also, we must watch the power supply carefully. Based on actual experiments, you'll need 50% more power in the vertical

sweep circuit to sweep the 90° tube, compared to the 70° tube. The horizontal circuit will need 25% more power. If the low-voltage power supply will bear up under this additional drain, we're in. We can get more power in the sweep circuits by changing tube types. For example, 6BQ6's can be replaced by the more powerful 6DQ6's, and 6F6's in the vertical output by 6V6's, and so on.

To find out about how much power we can draw from the power transformer itself, look up the recommended replacement in a transformer catalogue and note the current rating of the high-voltage secondary. This is the limiting factor in all conversions. If the original transformer had a current-supply capability of 200 ma, and calculations show that we'd need 250 ma for the new tubes, the only answer here is replacement of the power transformer.

Yokes can usually be changed with ease. Find out the inductance of the original yoke. For example, if the yoke had a 10-mh horizontal and 45-mh vertical inductance, get a catalogue and look up a 90° yoke which has approximately the same inductances. You'll have about a 10% tolerance here, especially if the chassis has both horizontal linearity and width adjustments. Many older sets did use these handy controls, and they are always helpful in making the final adjustments after the new tube has been installed.

Converting from very old sets to very new tubes isn't recommended. For example, I doubt if it would be possible, let alone practical, to convert from a 54° tube to a 115° type! The added sweep power requirements would make this prohibitive, except in cases where the technician "just wants to see if he can do it" and has an almost unlimited supply of nonworking cash type money!

Emerson oscillator coil

The oscillator coil in an old table-model Emerson radio is open. No model number left on chassis or cabinet, of course! Tube line up: 35Z5,

50L6, 12SQ7, etc. Can you tell me where I could find a replacement coil?
—J. M., Cranford, N. J.

I'm sorry to say that I can't pin this model down for you, since the number of Emerson radios with that tube lineup is almost without number! However, the chances are that it used a standard tickler-feedback oscillator circuit, since most of them did. See Fig. 1.

You can replace this coil with a

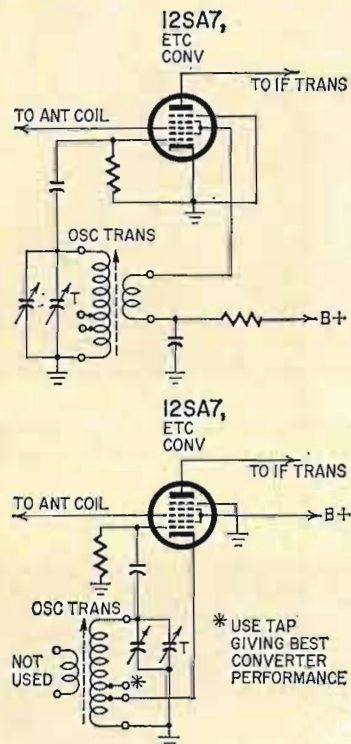

Fig. 1—Two common AM oscillator circuits. Use whichever appears in original circuit. "Universal" oscillator coils are tapped for either type.

Miller 71-OSC or any similar universal coil. This is tapped so that it can be used in almost any oscillator circuit, and has an adjustable core for tracking. (If it won't oscillate, reverse one of the windings—either one, but not both!)

Half inch more width

I've replaced the 12LP4 on an old Majestic TV with a 17BP4B, and it works fine. The only trouble now is I still need about ½ inch of width on each side. I've made some changes in the circuit: changed the screen resistor, and raised the B-plus voltage, etc. Any ideas?—J. G., Quincy, Mass.

You might try a few more tricks to get that last little bit of "stretch": add a small capacitor across the damper tube, about a 100–150 pf, 6 kv. Shunt the primary winding of the flyback

NEW TWIN-TRANSISTOR SUPER POWERMATE



BREAKS THE GAIN/OVERLOAD BARRIER

Servicemen and the public long wanted it, but were told they couldn't have it—a transistorized TV antenna preamplifier with the overload capacity to handle local signals without sacrificing the gain that brings in distant stations.

But Jerrold did what couldn't be done. With the new twin-transistor SUPER POWERMATE, you have, for the first time, a transistor preamplifier with the high gain and low noise figure that made the original Jerrold Powermate famous—plus an unprecedented overload capability for local-signal situations. SUPER POWERMATE offers a gain range from 15.5db with 700,000 μ v max. output at Channel 2, to 11.3db with 200,000 μ v max. output at Channel 13. There are no tubes or nuvistors to replace. And frequency response is fantastically flat—a boon to color TV.

Sell new SUPER POWERMATE, the all-channel antenna preamplifier with G/O—the industry's best Gain/Overload capability. List \$44.95. See your Jerrold distributor or write Jerrold Electronics, Philadelphia 32, Pa.

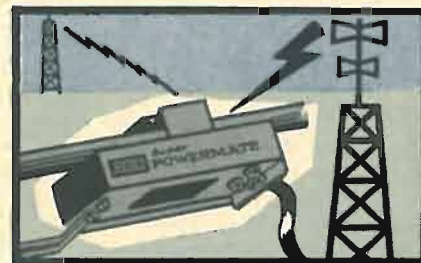

GAIN to reach far-distant stations, OVERLOAD capability to prevent local-signal interference.

SUPER POWERMATE **G/O**
HAS
GAIN / OVERLOAD

JERROLD
ELECTRONICS

A subsidiary of The Jerrold Corporation

(6BG6 plate tap to next tap) with about a 20-pf 5-kv capacitor.

One last resort might be to replace the yoke with a 70° type. The original yoke is a 53° type, and the extra bit of deflection might do it. I believe a Stancor DY-8 should do the trick: this is exactly the same inductance as your original yoke (8.5 mh horizontal, 55 mh vertical) but is a 70° type. There are several others by other makers with the same values. Try any of these.

Streaking and horizontal bend

In a RCA KCS-136 chassis, there is an awfully short-time-constant intermittent. It shows up as a streaking in the picture, usually followed by a horizontal bend, like an "agc bend." This clears itself in a few seconds, especially if you touch a test prod or scope lead anywhere in the circuit.—R. P. M., Fayetteville, Ark.

This is probably due to an intermittent bypass capacitor. Try replacing both the .001- and 0.22- μ f agc bypass capacitors on the video i.f. printed circuit board, as seen in Fig. 2. Although we haven't caught them doing it, they must be opening up to cause this kind of symptom.

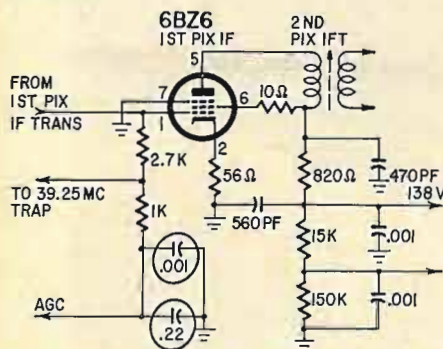

Fig. 2—Open agc bypass capacitors (circled) can cause streaking and bending of picture.

Narrowing in Zenith 24G26

The last question I asked was about a Zenith, and your answer proved very helpful. Now, how about another one? [Advertisement!—Editor.] This is a 24G26 chassis. Everything has been checked, the width control is at maximum, and the horizontal drive control also at maximum. Only then can I get the screen filled. The flyback is quite noisy and seems to be running warm, the insulation is peeling. If this isn't enough, after warm-up I get white flashes and streaks in the picture, bad horizontal stability. This is intermittent, too! Shows up after the set has been on for about 10 minutes. Sometimes the thing will run for 3 or 4 hours.—N. J., Long Island City, N. Y.

The symptoms you give are typical of those caused by one of the two 6BQ6 horizontal output tubes in this

series developing a bad case of grid emission or screen emission, or possibly some gas, or all three simultaneously. The slow shrinkage, and the flashing and streaking, together with the hot flyback, all point to this cause. By the way, you said that the tubes had been checked. I ran into a bad case of this same complaint the other day, and checked the tube just out of curiosity. It tested perfect: no gas, no emission, but in an "in-the-circuit" checker, it plainly showed screen emission! So, the best and most practical test here is replacement.

The heating of the flyback also points in the same direction. If you measure the plate current, you'll probably find it running around 250 ma for the two tubes; 220 ma should be the maximum. I'd also replace the 6W4 damper with a 6AU4, because of the much higher heater-cathode breakdown rating. Also, check the p-p voltage of the drive signal which should be at least 100 volts and could be 125 volts without hurting anything.

Silvertone swap: 17HP4 to 17BP4

Can I change the 17HP4 in my Silvertone TV set to a 17BP4? I know the 17HP4 is an electrostatic-focus tube, and the 17BP4 is magnetic-focus, but I've got a spare 17BP4, and it's my set!—A. R. E., Key West, Fla.

Yes, I think you can make this change, if you don't mind a little jiggery-pokery with the focus circuit in the set. The 17BP4 specifies an EIA No. 109 focus coil with a current of 100 ma for

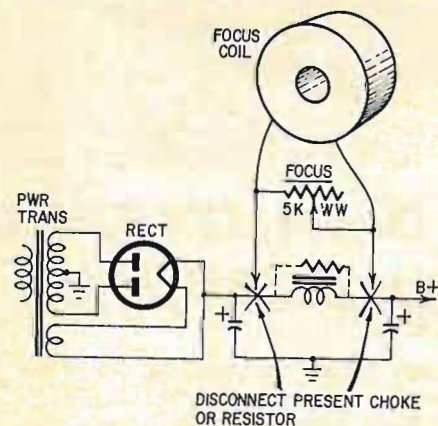

Fig. 3—To use magnetic-focus CRT instead of electrostatic tube, connect focus coil in place of filter choke or resistor. Pot across coil is focus control.

the -BP4. If the tube you have happens to be a -BP4A or -BP4B, total current will be 115 ma, slightly higher in aluminized types.

You might be able to dig up one of these focus coils from an old TV in the back room of somebody's shop. This is about the most popular focus coil, and was used on innumerable models. It

might even be worth while to try one of the magnetic-focus (PM) units, such as used on several old Philco's, etc., if you can find one. This should do the work. However, if it won't, get the focus coil, and connect it into your power supply circuit in place of the filter choke or resistor (See Fig. 3). You can shunt the coil with a heavy-duty wirewound potentiometer for focus control—about 5,000 ohms.

Microphone hum

I have a good make tape recorder, which works fine as long as I use the short mike cable which came with the unit. When I connect a longer mike cable, to use it in another room, I get a terrific hum. I'm using a crystal mike on the extension. I'd like to use about 50 feet of mike cable on this. Do you think I need a preamp?—W. F., Defiance, Ohio.

No, I think you need a better ground on the shield of that extension cable. Since the machine works OK with the original mike, this hum must be due to stray pickup from the longer cable. Almost invariably, this is due to a poor or even an open ground connection on the shield braid.

You can use microphone cable up to 100 feet without too much trouble. If you use the small-size high-capacitance type known as lapel-mike cable, you'll get a fairly heavy signal attenuation due to the added shunt capacitance across the input. So, I'd recommend using the larger standard cable, for less signal loss.

Fusible resistors

Are fusible resistors designed to blow at a specific current rating? If so, how is this determined? Why are they made in such funny values: 4.7, 5.6 and 7.5 ohms?—J. M., Webster Groves, O.

The fusible resistor serves as a combination fuse and surge resistor in most applications. It is a special type of wirewound resistor, made of resistance wire with a definite current-carrying capacity. In normal use, it actually runs at about 90% of its rating.

The wattage at which it blows is determined by the current through the resistance and the resistance used. To increase the blowout point, we'd use a smaller resistor: less wattage dissipated. The "funny values" are simply preferred numbers, used for most resistors.

Converting KCS-68E to 24-inch CRT

One of our customers wants us to convert his RCA 21T159-DE, using the KCS-68E chassis, to use a 24- or 27-inch picture tube. I would prefer a short 90° or 110° tube.—J. H. G., Arlington, Va.

I'm not too optimistic about your proposed conversion to either the 24- or

27-inch tube, especially in the 90°-110° range. It would be entirely impossible to convert your present chassis to sweep a 90° or 110° tube, especially the latter. You see, when you alter the sweep angle, you must furnish additional power to drive the beam that extra distance. This requires extra power from the sweep systems, not only from the horizontal sweep but from the oft-neglected vertical sweep as well! Just changing the yoke from the present 70° to a 90° would not be enough. If you changed only the yoke, you'd still have a 70° picture on the 90° tube!

This conversion would require replacement of the flyback, vertical output transformer, yoke and both output tubes. It would not be practical at all for a customer, although you might try it if it was your own set, just for the experience! It will be very educational and fun, but rather expensive.

Insufficient width in Zenith

What can I do to get more width in a Zenith 16C24 TV?—L. P., Brooklyn, N. Y.

The Zenith chassis you mention has a metal-sleeve type width control. This is a brass sleeve of very thin metal slid inside the yoke. There is a small grounding clip around it, to reduce the shock hazard if the yoke should short to it. To get more width, simply slide this sleeve back out of the yoke until the picture is correctly proportioned.

If this does not give you sufficient width, check the horizontal output tube, by replacement, and also the low-voltage rectifier. Check drive voltage on the grid of the 6DQ6 horizontal output tube: this should be at least 60 volts negative. You might also check the dual .0015- μ f coupling capacitor in the 6DQ6 grid circuit. It has given trouble in some sets. If it is leaky, replace it with two separate .0015- μ f ceramics, of at least 600-volt rating.

PC trouble, RCA KCS-94A chassis

I have a dandy intermittent on my bench! It's an RCA KCS-94A chassis. The trouble is apparently in the horizontal oscillator circuit. Anywhere around the output half of the 6CG7 horizontal oscillator, I got a 12-cycle waveform, with the sweep set for 15,750 cycles. Then, all of a sudden, the set took off and played perfectly. I've replaced several capacitors around there without result. When I put a heat lamp on the printed-circuit board, the set started to work and played for several hours! The conductors all check out with an ohmmeter. What do you think?—J. L., Niagara Falls, N. Y.

I'm afraid that you have a thermal intermittent in that horizontal oscillator

board, and that can be quite troublesome! Since you replaced most of the frequency-determining elements of the circuit, and the set refused to work until you heated the board with the heat lamp, it looks very much as if you have a thermal break in one of the conductors. A break, I might add, that is almost impossible to locate with an ohmmeter, and the chassis cold.

So, set it up, get it to cut out by cooling it off, etc., and then resolder all the connections around the horizontal oscillator circuit, being very careful to make good, clean joints. Use just a tiny dab of soldering paste on each, if you want to. One of the small-tip medium-heat irons is very handy for this.

The basic defect is obviously one which is affecting the frequency, I'd say, from the waveform. This will upset the time constant of the horizontal output, damper and yoke circuit, and keep the high voltage from developing. It must be some part (probably a capacitor) opening up due to an invisible break in the pc board, because the frequency goes up.

Silvertone with squeal and "fuzz"

I have a Silvertone 100-210 TV which has an unusual horizontal sweep trouble. The raster is fuzzy and streaky, almost completely blacked out at the left side, and brighter at the right. The flyback squeals, and there is no boost voltage. Waveshapes around the circuit look OK, but they are a little thick and fuzzy-looking.—W.E., Toledo, Ohio

Your horizontal oscillator is off frequency: this is the customary cause of this squeal. However, since you have other symptoms (no boost voltage, etc., and most especially those "fuzzy waveforms" around the horizontal stages), I'd check some filter capacitors first.

Open or weak electrolytics will cause feedback in the wrong places, and can cause off-frequency operation of the horizontal oscillator. C1, the 40- μ f input filter capacitor, has been known to cause this. Check it first. END

Correction

There is an error in the wiring of board 1 in Fig. 4 of the article "Build an Audio Sweep Generator" on page 28 of the September issue. R2 is incorrectly connected in the drawing.

Remove the connection between points 6 and 8 in the top row (counting from left). Connect R2 there instead. Close the gap between point 7 and the junction of C2 and R3. Pin 1 of V1 and one terminal each of C2, R3 and C3 are now common. The right-hand ends of RFC1 (left) and RFC2 (right) go to ground through R2.

We thank Frank J. Stein, of Santa Ana, Calif., for catching the wiring error.

WHAT'S YOUR



Three puzzlers for the student, theoretician and practical man. Simple? Double-check your answers before you say you've solved them. If you have an interesting or unusual puzzle (with an answer) send it to us. We will pay \$10 for each one accepted. We're especially interested in service stinkers or engineering stumbers on actual electronic equipment. We get so many letters we can't answer individual ones, but we'll print the more interesting solutions—ones the original authors never thought of.

Write EQ Editor, Radio-Electronics, 154 West 14th Street, New York 11, N. Y.—10011.

Answers to this month's puzzles are on page 68.

An Unusual Twist

A TV technician was working with an old set, when a camera-toting friend walked in. He quickly focused close up on the receiver's screen and got the picture below.

What caused this unusual twist?



What was the service technician doing to the receiver?—Allen F. Kinckiner

L-C-R Circuit

The diagram shows that the load across an ac generator is a 100-ohm

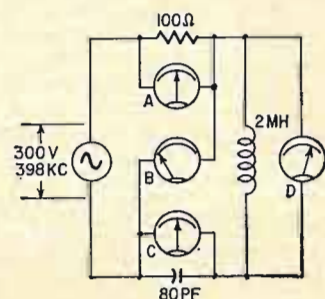

resistor, a 2-mh inductance and an 80-pf capacitor connected in series. The generator produces 300 volts at 398 kc, and the current flow through each element in the series circuit is 3 amperes. Voltmeters B, C and D are connected to measure the voltage drop across the reactive elements in the circuit. Voltmeter A measures the voltage drop across the 100-ohm resistor. Can you determine the reading on each voltmeter?—Kendall Collins

Bewildering Blinker

The circuit shown seems straightforward enough, but does something unusual. When the Variac is set at some critical potential around 100 volts, the

60-watt light bulb blinks at the rate of about one blink per second.

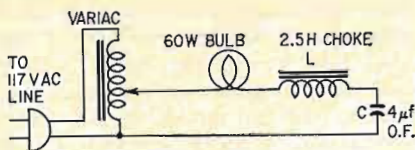

I defy you to tell me why! I had to muddle over it for quite some time to find a possible answer. Is something oscillating. If so, what? Try building it if you don't believe that it will work. All the parts are standard and are listed below.—George R. Wisner

1. Variac or other source of variable ac from 90 to 125 vac.
2. 60-watt light bulb of standard home type.
3. L, 2.5-henry choke (one from an old radio will do).
4. C, 4- μ f oil-filled capacitor (electrolytics won't work).

New Techniques Make Fantastic Vacuum

Thin films, only 10 atoms thick, are being grown by scientists at the Westinghouse Research Laboratories in research on the physical properties of thin films, which are becoming increasingly important in electronics.

The films are made from both metals and insulating materials, and are grown by depositing them from evaporated material inside a special ultra-high-vacuum chamber, which creates pressures less than one-thousandth of a billionth of atmospheric pressure at sea level. This corresponds to the pressure in outer space 300 miles from the earth.

To get the ultra-thin films an unusual device had to be constructed. It is a stainless steel chamber that looks something like a deep-sea diving bell. Before putting it into operation, it is baked out at a temperature of 750°F. Then the temperature is reduced by filling the space between the walls with liquid nitrogen to cool them to 320° below zero.



Senior technician Paul Raygor prepares for an experiment in the Westinghouse ultra-high vacuum chamber.



NEW SONY CITIZENS BAND TRANSCEIVER WITH SEPARATE HEADSET AND MICROPHONE

The new SONY CB-106 transceiver is unique in the Citizens Band field. With 10 transistors for extreme reliability and sensitivity, it includes a transceiver chassis and separate foam cushioned headset with adjustable microphone. Your hands are always completely free, since the set is keyed with a fingertip cable release. The chassis is out of the way, too, suspended in a shoulder case and belted around the waist. Battery operated and with a range of up to 6 miles, the CB-106 includes chassis, headset-microphone, microphone cable release, shoulder case, batteries.

\$199.95 per pair. \$99.95 each

SONY CORPORATION OF AMERICA
580 Fifth Avenue, New York 36, N.Y.
Regional Offices
Western: 500 West Florence Avenue, Inglewood, Calif.
Central: 4959 W. Belmont Ave. Chicago 41, Ill.

Gentlemen: RE 11
Please rush me full details on the new
SONY CB-106 Citizens Band transceiver.
Name _____
Address _____
City _____ Zone _____ State _____

SONY Corporation of America 580 5th Ave., N.Y. 36, N.Y.

After bake-out and nitrogen cooling, extremely low pressures are obtained from only short periods of vacuum pumping. The pressure of 1-billionth of a millimeter of mercury can be obtained within an hour, and a pressure 100 times lower in two hours.

RADIO-ELECTRONICS

DO YOU KNOW THE LAW?

ANSWERS

(Questions are on page 40)

1. In electronics we recognize two Kirchhoff laws. The first states that "the sum of currents flowing toward any junction is equal to the sum of currents flowing away from that junction." The second law goes like this: "The algebraic sum of voltages around any closed path in a circuit is zero."

★

2. The relationship between current, resistance and dissipated energy—the familiar I^2R expression—is known as Joule's law.

★

3. Poynting's law, relatively obscure to most of us, deals with effects of transfer of energy in electromagnetic fields and is important in micro-waves. It states that the transfer of energy can be expressed as the product of the values of the magnetic field and of the components of the electric field which are perpendicular to the magnetic field, and that the flow of energy at any point is perpendicular to both fields.

★

4. Lenz' law is important wherever alternating current flows, from 60 cycles to rf. So fundamental is it that it might almost be called the alternating-current counterpoise to Ohm's law. The law deals with the change in flux caused by the motion of one of two mutually coupled coils, and the direction of current in one of them, as follows: "If a constant current flows in a primary circuit (A) and if by motion of A or the secondary circuit (B), a current is induced in B, the direction of induced current will be such that, by its electromagnetic action on A, it tends to oppose the relative motion of the circuits." In other words, "Counter electromagnetic motive force." But if you don't like the way this was stated, blame J. Clerk Maxwell, the famous physicist, for that is how he expressed it. Why the ac counterpoise to Ohm's law? Simply that if a man knows Ohm's law, he knows dc; if he knows Lenz' law, he knows ac.

★

5. Neuman's law deals with mutual inductance (hence the reference to i.f. transformers) when no magnetic material is present. It states that M (mutual inductance) is a constant for a given relative physical position of the coils, and independent of the fact that the current flows in one or the other coil, and of frequency, current and phase. It is an "appendix" of the law of conservation of energy, which will be overthrown when we move through space at greater speed than light!

★

6. Wien's law, better known as Wien's displacement law, shows that the wavelength of maximum radiation intensity is inversely proportional to the absolute temperature of a black body, and that the intensity of radiation at this maximum wavelength varies as the fifth power of the absolute temperature. Infrared detection techniques, hinging on the facts known about "black bodies," are intimately concerned with Wien's displacement law.

★

7. Helmholtz' law describes the curve of increase of a current when a circuit with R and L is suddenly closed. Thus: $I = I_0(1 - e^{-tR/L})$, which is a familiar curve to most electronics workers. (It is also related to the discharge curve of a capacitor, but this was not stated by Helmholtz.)

★

8. Wiedeman, Franz and Lorentz, all physicists, have a law which states that the ratio of electrical conductivity and thermal conductivity at a certain temperature is independent of the

conductor material! Sounds hard to believe, but it is true.

★

9. Faraday, most famous of historical experimenters, stated in his law that if there is any closed linear path in space, and the magnetic flux in this path (surrounded by the path) varies in time, the emf induced in the path is equal to the negative rate of change of the flux in lines per second. This can only be expressed with calculus in formula form, so we will skip that part. But it is a fact that the importance of this discovery was not practically applied in radio for almost a century!

★

All of which just goes to show that there are many facts about nature and the world around us that we can use to good advantage in our daily work with electronics, without giving much thought to the great discoverers of science, who had powers of observation and deduction, and the ability to state them as "laws of nature."
END

look what happens when you
buy a
dozen
vu-brites...

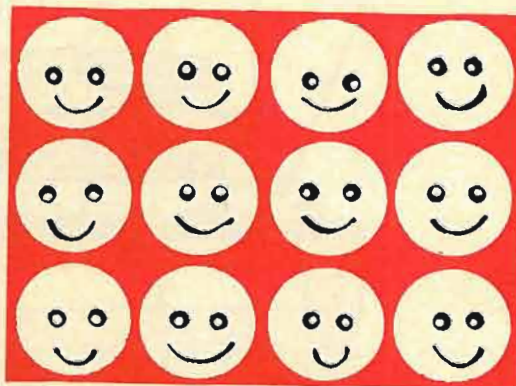

You get the greeting card assortment free...

a beautiful selection for birthdays, anniversaries, get well wishes, etc. Yours free with the purchase of 12 Vu-Brites.

You get twelve happy customers...

because 12 CRT's will be given an extra lease on life, 12 households will enjoy TV more, thanks to the brighter picture you (and Perma-Power's Vu-Brite) have provided.

what a deal!

For a limited time, Perma-Power is offering you this wonderful gift absolutely free with the purchase of 12 Vu-Brites at the regular price. Vu-Brites are the Briteners that really do a job—on parallel or series sets (Model C401 for parallel; Model C402 for series). They come colorfully packaged in individual boxes... and are priced at \$9.95 the dozen, net.

Perma-Power
COMPANY

5740 N. TRIPP AVENUE
CHICAGO, ILL. 60646

Hurry—this special gift offer will end when current stocks are gone.
Call your distributor today.

SOLID-STATE* STEREO

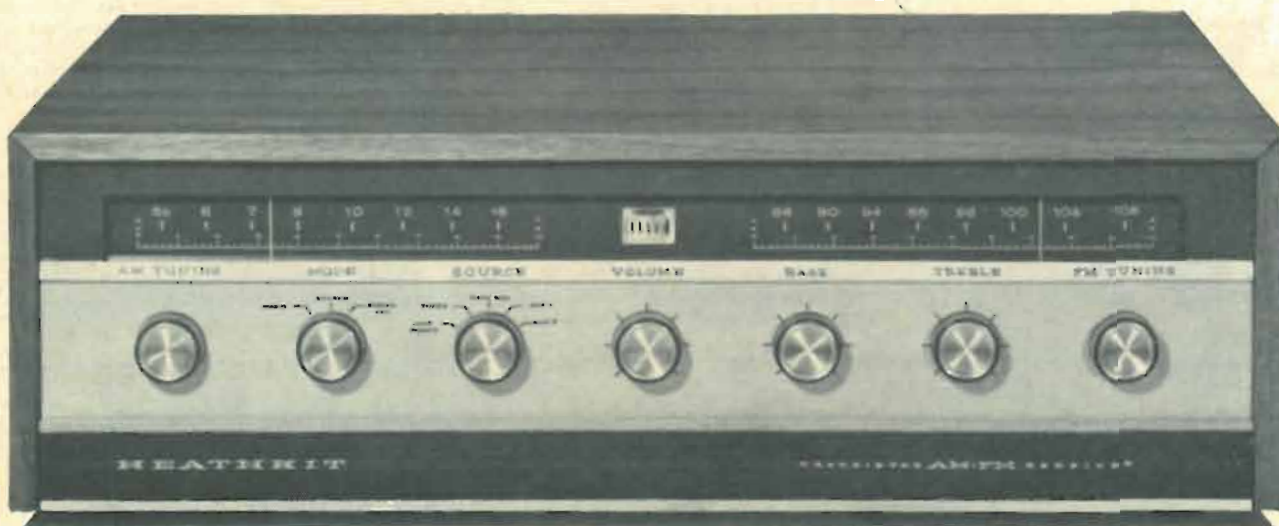

NEW! AR-13 STEREO RECEIVER...only \$195⁰⁰

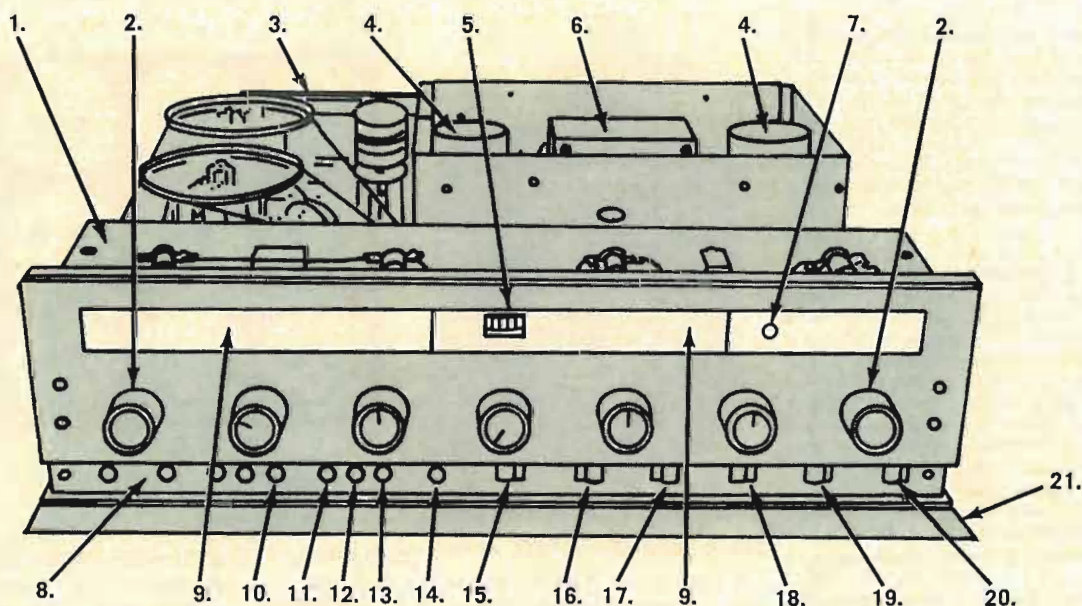

- | | |
|---|--|
| <ol style="list-style-type: none"> 1. Preassembled FM Front End 2. Individual AM and FM Tuning 3. AM Rod Antenna 4. Regulated & Electronic Filtered Power Supply 5. Tuning Meter 6. Transformer Operated Power Supply 7. Stereo Indicator Light 8. Input Level Controls 9. Illuminated Slide Rule Dials 10. Phase Adjust Control 11. Converter Balance Control | <ol style="list-style-type: none"> 12. Stereo Separation Control 13. FM Squelch Control 14. Level Balance Control 15. Phase Adjust Switch 16. AFC Switch 17. Local-Distance Switch 18. SCA Filter Switch 19. Noise Filter Switch 20. Speaker Phase Switch 21. Hinged Lower Front Panel
(conceals secondary controls) |
|---|--|

* 43 Transistor, 16 Diode Circuitry

LEADS IN TRANSISTOR STEREO

TUNER-AMPLIFIER

by Heathkit

FIRST IN KIT FORM!

ALL-TRANSISTOR AM-FM & FM STEREO TUNER PLUS
ALL-TRANSISTOR 40-WATT STEREO AMPLIFIER—ALL
IN ONE SMART WALNUT CABINET FOR JUST \$195.00

Now in time for Christmas giving, Christmas listening! Two 20-watt power amplifiers...two separate preamplifiers...plus wide-band AM, FM, and FM Stereo...all beautifully housed in this one, compact Heathkit All-Transistor Stereo Receiver. For Heathkit this means another first! For you it means experiencing the uncompromising realism of "transistor sound" in a handsomely styled receiver that *won't* overheat...just the coolest, fastest, most "hum-free" operation possible! Just the purest, most "solid sound" possible! This is the why of transistor stereo. This is why you should move up to the new AR-13 Receiver. And the traditional Heathkit economy makes this advanced performer easy to own...just \$195.00

All the electronics you need for a complete music system are "Heath-Engineered" into this handsome unit...just add two speakers and a phonograph or tape recorder! And there's plenty of advanced features to match the advanced performance of the AR-13. You'll like the way this unit *automatically* switches to stereo, thus eliminating any manual operation. In addition the automatic stereo indicator light silently signals when stereo is being received. For versatility there's three stereo inputs (mag. phono and two auxiliary) plus two filtered tape recorder outputs for direct "off-the-air" beat-

SPECIFICATIONS—Amplifier: Power output per channel (Heath Rating): 20 watts/8 ohm load, 13.5 watts/16 ohm load, 9 watts/4 ohm load. (IHF Music Power Output): 33 watts/8 ohm load, 18 watts/16 ohm load, 16 watts/4 ohm load @ 0.7% THD, 1 KC. **Power response:** ± 1 db from 15 cps to 30 KC @ rated output; ± 3 db from 10 cps to 60 KC @ rated output. **Harmonic distortion (at rated output):** Less than 1% @ 20 cps; less than 0.3% @ 1 KC; less than 1% @ 20 KC. **Intermodulation distortion (at rated output):** Less than 1%, 60 & 6,000 cps signal mixed 4:1. **Hum & noise:** Mag. phono, 50 db below rated output; Aux. inputs, 65 db below rated output. **Channel separation:** 40 db @ 20 KC, 60 db @ 1 KC, 40 db @ 20 cps. **Input sensitivity (for 20 watts output per channel, 8 ohm load):** Mag. phono, 6 MV; Aux. 1, .25 v; Aux. 2, .25 v. **Input impedance:** Mag phono, 35 K ohm; Aux. 1, 100 K ohm; Aux. 2, 100 K ohm. **Outputs:** 4, 8, & 16 ohm and low impedance tape recorder outputs. **Controls:** 5-position Selector; 3-position Mode: Dual Tandem Volume; Bass & Treble Controls; Balance

free stereo recording. Dual-tandem controls provide simultaneous adjustment of volume, bass, and treble of both channels. Balancing of both channels is accomplished by a separate control. The AM tuner features a high-gain RF stage and high-Q rod antenna.

Other quality features include a local-distance switch to prevent overloading in strong signal areas; a squelch control to eliminate between-station noise; AFC for drift-free reception; heavy die-cast flywheel for accurate, effortless tuning; pin-point tuning meter; and external antenna terminals for long-distance reception. For added convenience the secondary controls are "out-of-the-way" under the hinged lower front panel to prevent accidental system changes.

Building the AR-13 is quick and easy with the pre-assembled FM "front-end" and 3-stage AM-FM I.F. strip, plus circuit board construction. Styled in Heathkit's new low-silhouette design, the beautiful walnut cabinet accented with the extruded gold-anodized aluminum front panel makes the AR-13 a handsome addition to any home decor. This Christmas, move up to the better listening of "transistor sound" with the new AR-13 Stereo Receiver...another example of superb Heathkit quality at unmatched savings.
Kit AR-13, 30 lbs., no money dn., \$19 mo. \$195.00

Control: Phase Switch; Input Level Controls (all inputs except Aux. 2); Push-Pull ON/OFF Switch. **FM: Tuning range:** 88 mc to 108 mc. **IF frequency:** 10.7 mc. **Antenna:** 300 ohm balanced (internal for local reception). **Quieting sensitivity:** 2½ uv for 20 db of quieting, 3½ uv for 30 db of quieting. **Bandwidth:** 250 KC @ 6 db down (full quieting). **Image rejection:** 30 db. **IF rejection:** 70 db. **AM suppression:** 33 db. **Harmonic distortion:** Less than 1%. **Multiplex: bandpass:** $\pm 1/2$ db, 50 to 53,000 cps. **Channel separation:** 30 db, 50 to 2,000 cps; 25 db @ 10 KC. **19 KC suppression:** 50 db down, from output @ 1 KC. **38 KC suppression:** 45 db down, from output @ 1 KC. **SCA rejection:** 30 db. **AM: tuning range:** 535 to 1620 KC. **IF frequency:** 455 kc. **Sensitivity:** 1400 KC, 3.5 uv; 1000 KC, 5 uv; 500 KC, 10 uv—standard IRE dummy antenna. **Bandwidth:** 8 KC @ 6 db down. **Image rejection:** 30 db @ 600 KC. **IF rejection:** 45 db @ 600 KC. **Harmonic distortion:** Less than 1%. **Overall dimensions:** 17" L x 5½" H x 14¾" D.

HEATHKIT-1964



NEW! FREE 1964 HEATHKIT CATALOG. See the latest new products in Heathkit's wide, wonderful line. Over 250 do-it-yourself kits for stereo/hi-fi, marine, TV, electronic organs, amateur radio, test instruments, educational, and home and hobby items that will save you up to 50%. Send for your free copy today!



HEATH COMPANY Benton Harbor 20, Michigan 49023

- Enclosed is \$195.00, plus postage. Please send Model No. AR-13.
 Please send Free Copy of New 1964 Catalog.

Name _____

Address _____

City _____ State _____

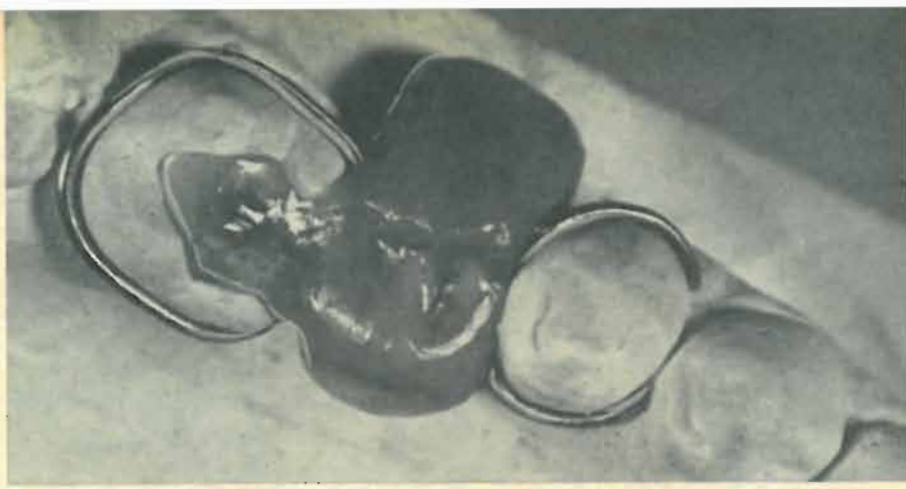

Transmitter Fits in a TOOTH!

Tiny FM transmitter uses 1 transistor

By B. R. D. GILLINGS*

WITH MINIATURE COMPONENTS PLUS A little care and patience in assembly, it is possible to make a tooth-sized radio transmitter that can broadcast signals 15 feet or more. The transmitters described here were developed for dental research, but with a little imagination similar devices could be used for a variety of routine biological applications.

Dentists have long been interested in how the teeth meet. Recent research has made it increasingly obvious that very little is known about it. When, for example, a filling or tooth is a little too high, no one can say whether the patient is likely to hit the high spot more often to wear the area away, or whether he will avoid closing his teeth on the spot because it irritates him.

One of the difficulties in investigating normal or abnormal occlusion (abnormal occlusion: irregularly arranged teeth which do not meet properly) is the upsetting effect of observation on the patient's behavior. Attaching wires or gages to various parts of his teeth or face is also likely to disturb him, consciously or unconsciously, and cause an abnormal reaction. This difficulty has, to a great extent, been solved by a tooth-sized radio transmitter.

In 1961, two scientists, Brewer and Hudson, working for the United States Air Force, got things started. They built a miniature radio transmitter (a simple 40-kc oscillator with three resistors, two capacitors, a transistor, a coil and a 1.4-volt mercury cell). (See Fig. 1). It was fitted into an upper artificial denture to determine how frequently the subject contacted his teeth while at rest and while eating. By an ingenious arrangement of triggering contacts, consisting of gold teeth, the two men were able to obtain counts for

the number of tooth contacts made in different positions of the jaws. Since the radio transmitter was completely enclosed in the denture, the measuring technique did not interfere with the subject's normal behavior when wearing a full denture.

Useful though this technique is, it does not solve the problems of subjects who have all, or nearly all, their own teeth. It is highly likely that occlusal contact patterns and responses in these subjects are entirely different from those of full denture wearers.

The transmitter used in the full denture was not small enough to be used in the mouths of people who had their own teeth. We did find many suitable subjects who had one or two teeth missing, especially molars, and there

was a possibility that a transmitter the size of one tooth could be fabricated to study these subjects.

R. H. Dilworth, who developed the pocket personal radiation monitor now in production for the Atomic Energy Commission, and W. Greatbatch, who developed the artificial Pacemaker for the heart, were consulted regarding suitable circuitry and sources of supply of components. Following their suggestions, we were able to construct our first radio transmitter. The circuit is shown in Fig. 2. It is a keyed oscillator that broadcasts an unmodulated signal at about 3 mc.

How it is built

Before the components are hooked up, all leads should be lightly tinned, so they can be soldered with one touch of the iron. (The small components are easily damaged by excess heat.) To conserve space, trim or sand off excess insulation on the capacitors, particularly around the leads (Fig. 3-a). Before making a soldered joint, the leads must be bent together and any wire not needed for a later step cut off. This not only reduces the bulk of the joint and the amount of heat needed to solder it, but also prevents movement should another joint have to be made at the same point. A phosphoric acid flux must be used when soldering to the stainless steel battery case. If the case gets hot, the battery will be ruined. A quick touch is all that is needed.

Once a joint is made, it is almost impossible to disassemble. Because the components are so easily damaged, particularly when bending the leads, the units should be tested each time a joint is made. The rejection rate through component failure during assembly is high, and you will probably ruin your first attempt sometime near the end.

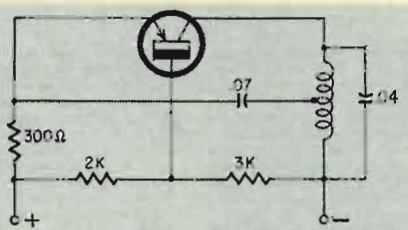

Fig. 1—Basic transmitter circuit.

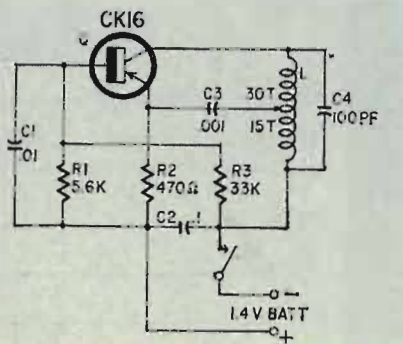

Fig. 2—Practical circuit with all values.

* Faculty of Dentistry, University of Sydney, Australia.

SOLID-STATE STEREO

BY HEATHKIT



NEW! Low-Cost All-Transistor, All Mode Stereo Tuner and Matching 40-Watt Stereo Amplifier

Cooler, faster operation . . . lower power consumption . . . longer life . . . and the clean, quick realism of "transistor sound." You'll enjoy all this and more with Heathkit's newest All-Transistor Stereo "Twins." Compact, low-silhouette styling magnificently fashioned in rich walnut cabinets neatly fits this handsome pair into a "proud place" in any hi-fi stereo system. Add to this extruded brushed gold-anodized aluminum front panels that serve practically to conceal secondary controls and decoratively to enhance over-all beauty. The AA-22 Amplifier provides 40 watts of continuous power at ± 1 db from 15 to 30,000 cps with no fading, no faltering . . . just pure solid-sound! The AJ-33 Tuner offers selection of AM, FM, or FM Stereo to please any listening preference. Check both unit's features and discover why Heathkit leads in Transistor Stereo. The price? A great value, you'll agree . . . \$99.95 each!

AA-22 40-watt Transistor Stereo Amplifier, 14 lbs. \$10 mo. \$99.95

AJ-33 Transistor AM-FM-FM Stereo Tuner, 14 lbs. \$10 mo. \$99.95

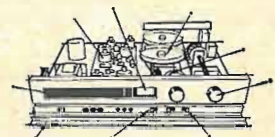
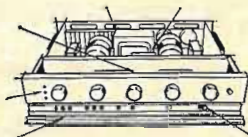

- 40 watts of power (20 per channel)
- 5 stereo inputs
- Speaker phase switch
- Miniature indicator light for each position on mode switch
- Transformerless output circuits
- Brushed gold-anodized aluminum front panel conceals secondary controls
- Walnut cabinetry

- Stereo phase control
- Automatic stereo indicator
- AFC and AGC
- Filtered stereo tape recorder outputs
- Built-in stereo demodulator
- Tuning meter
- Flywheel tuning
- Slide-rule dial
- Prealigned FM tuner and circuit board construction
- Brushed gold-anodized aluminum front panel conceals secondary controls
- Walnut cabinet



HEATH COMPANY Benton Harbor 20, Michigan 49023

Enclosed is \$_____, plus postage. Please send model No. _____

Please send Free Copy of New 1964 Catalog.

Name _____

Address _____

City _____ State _____

HEATHKIT-1964



NEW! FREE 1964 HEATHKIT CATALOG

See the latest new products in Heathkit's wide, wonderful line. Over 250 do-it-yourself kits for stereo/hi-fi, marine, TV, electronic organs, amateur radio, test instruments, educational, and home and hobby items that will save you up to 50%. Send for your free copy today!

Fig. 3—Six steps to a tooth-size transmitter.

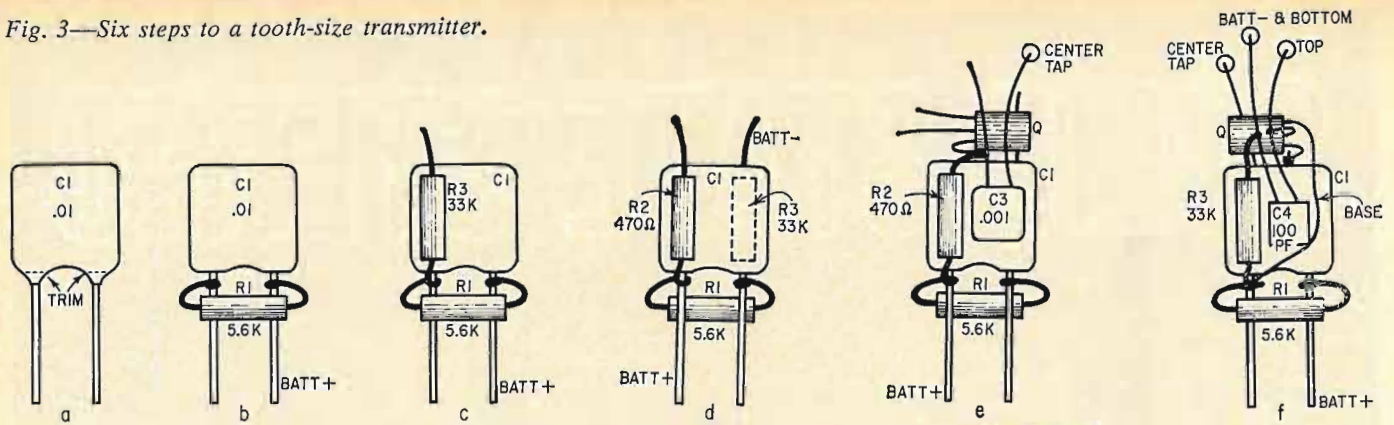

We have found that the best approach is to work from an assembly board. The components are wired together temporarily on the board, using a stock coil approximately the size of the coil, which will be wound as the last step around the finished unit. All leads are left uncut until it is decided whether they will be needed for a later step. The components are removed from the board as they are assembled, and the package is wired back on the board with the remaining components to test it after each connection is made.

We usually start with C1 and solder R1 across its two leads (Fig. 3-b). One of these leads is now the positive battery connection. The other goes to one end of R3 and the base of the transistor. R3 is now soldered in place alongside C1 (Fig. 3-c). Then R2 is soldered the same way on the other side of C1 (Fig. 3-d). Now C3 is soldered to the free end of R2 (Fig. 3-e) so it is lying flat on C1, but with the leads facing in the opposite direction. The free lead is left long, as it will connect to the center tap of coil L. The transistor (Q) is now positioned at the top end of C1 and its emitter lead soldered to the junction of R2 and C3. C4 is now positioned on the opposite side of C1, and one lead soldered to the free end of R3 (Fig. 3-f).

The lead from this joint is left long. It will be connected through the switch to the negative side of the battery and the bottom of the coil. The transistor's collector lead is now bent back and soldered to the free lead of C4. Bending the transistor wires calls for extreme care, as the unit is easily damaged, especially if the leads are rotated during bending. This lead is left long, as it will connect to the top of the coil.

The base lead of the transistor is now bent in a wide sweep across either C3 or C4, whichever is the more convenient, and soldered to the junction of C1, R1 and R3. The excess wire can now be clipped from this joint. C2, a 0.1- μ f capacitor, has not been included. However, it may be essential with some batteries to prevent oscillation.

The package is now wired, except for the coil and battery connections. At

RESISTORS

Three types are available, the Ohmite type being most readily available and reasonable in price.

1. Miniature metal film resistors (MMF, style b). 5,600 ohms, 33,000 ohms, (tinned copper axial leads). International Resistance Co., 401 N. Broad St., Philadelphia 8, Pa. (Very expensive, 1% tolerance.)

2. Stemag (by Arnold Ceramics). Miniature resistors, 47 ohms, 470 ohms, 5,600 ohms, 33,000 ohms, 470,000 ohms. Laboratory Electronic Supply, 1069-1071 Massachusetts Ave., Cambridge, Mass. (Reasonable price. Imported from Europe.)

3. Allen Bradley Ohmite, type T.R. miniature resistors. 47 ohms, 470 ohms, 5,600 ohms, 33,000 ohms, 470,000 ohms. Allied Radio, 100 N. Western Ave., Chicago 80, Ill. (Used in hearing aids.)

CAPACITORS

1. Ultraminature ceramic capacitors. 100 pf, 500 pf, .001 μ f, .01 μ f. Glenco Corp., 212 Durham Ave., Metuchen, N. J.

2. Sprague Tantalum Hearing Aid Capacitors. Axial Lead, 0.1 μ f, Sprague Electric Co., North Adams, Mass.

TRANSISTORS

Raytheon, type CK16-A or CK17-A. Allied Radio.

BATTERY

Hearing-aid mercury cell, type RM-312. Mallory Battery Co., 13000 Athens Ave., Cleveland 7, Ohio.

COIL

Hand-wound using Formvar-coated copper wire of fine gauge, according to frequency desired.

the transistor end we have three leads. One goes to the bottom of the coil and the negative side of the battery and the other two to the top and center tap of the coil. The lead at the other end goes to the positive side of the battery.

The inductor

A thin celluloid form is wrapped around the package, and the coil wound on it with Formvar-coated fine copper wire. Placing the electronic package inside the coil may affect its perform-

ance. It is helpful to have half a dozen or so coils already wound for test purposes. The coil may be layer- or scramble-wound, according to the purpose for which the unit will be used. Coil connections should be left long for testing, and be clipped short and soldered to the appropriate lead as the final step in assembly. All leads except the battery connections are next trimmed off. The coil is coated with dope and the package potted.

The battery and switch are connected last. We use a very simple switch, the poles of which consist of two gold bars insulated from each other. The switch is held in a plastic tooth filling or plastic tooth, depending on the space available, and wired into the negative lead. To operate the switch, a small gold pin is cemented in an opposing tooth, so when the jaws are in contact in the particular position we are investigating it shorts the two gold bars, completing the circuit.

Since battery life is not important in our application, we pot the battery in the package. For other purposes it might be wise to make the battery readily accessible.

The signal is received as a hissing noise. We use a marine-band portable radio 3 to 6 feet away. A more elaborate receiver could detect the signal 15 or more feet away. The signal is fairly directional and the strength of the received signal may vary as the head is turned. The packaged unit is susceptible to capacitance effects, caused by the movements of the lips and tongue. They can be minimized by placing the coil so its open ends point to cheek and tongue.

The transmitter compared to an ordinary paper match. At the right is the complete transmitter. At the left is the transmitter minus its coil.

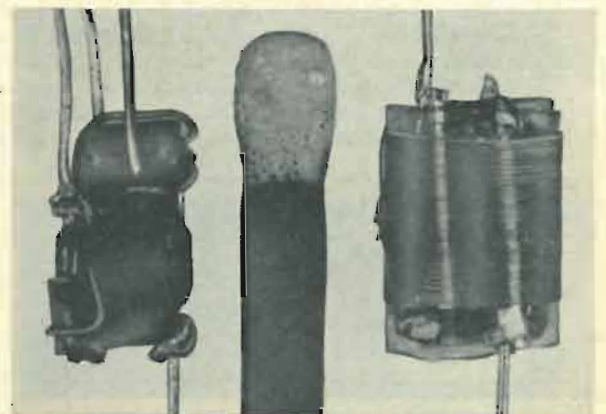

Introducing The FIRST In A New Series of Deluxe Heathkit SSB Amateur Radio Gear!

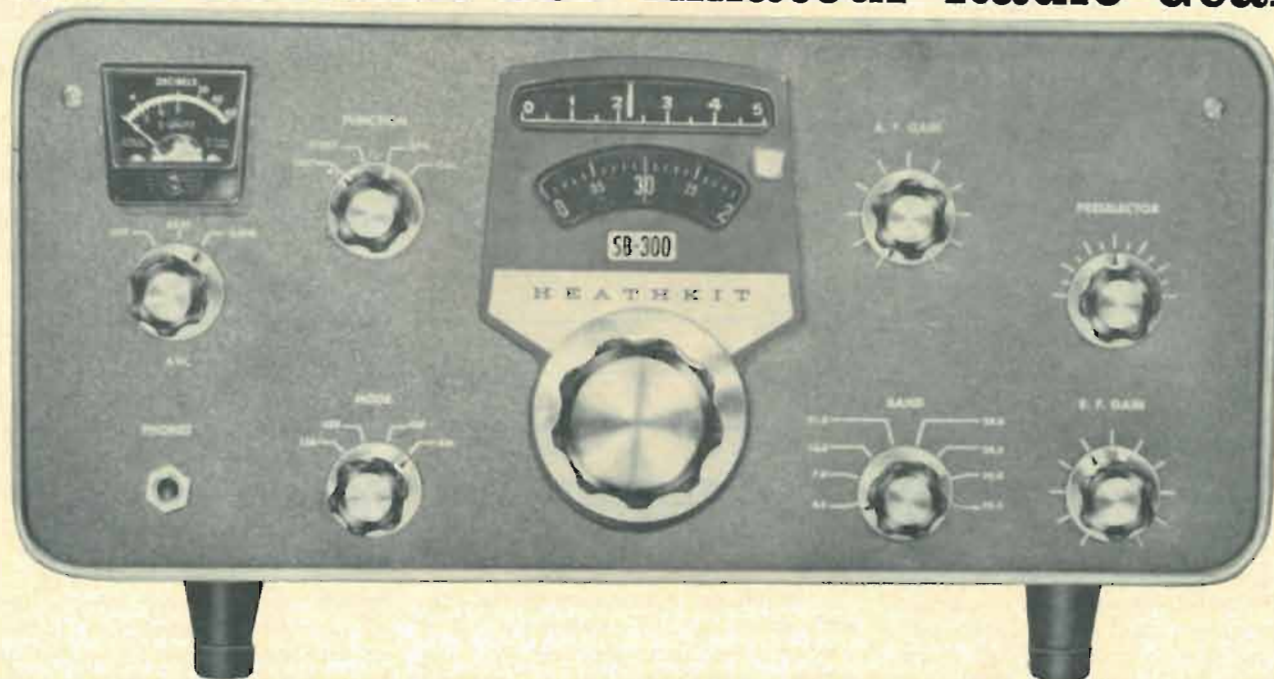

New SB-300 SSB Receiver With Quality Features & Performance Found Previously On Units Costing Twice as Much... Only \$264.95!

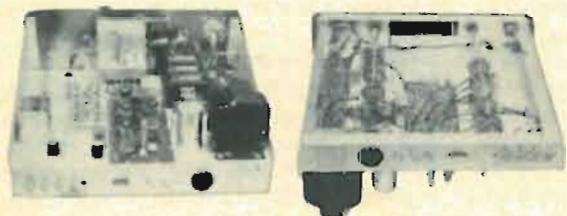

SPECIFICATIONS—Frequency range (megacycles): 3.5 to 4.0, 7.0 to 7.5, 14.0 to 14.5, 21.0 to 21.5, 28.0 to 28.5, 28.5 to 29.0, 29.0 to 29.5, 33.5 to 30. **Intermediate frequency:** 3.395 megacycles. **Frequency stability:** 100 cps after warmup. **Visual dial accuracy:** Within 200 cps on all bands. **Electrical dial accuracy:** Within 400 cps on all bands. **Backlash:** No more than 50 cps. **Sensitivity:** Less than 1 microvolt for 15 db signal plus noise-to-noise ratio for SSB operation. **Modes of operation:** Switch selected: LSB, USB, CW, AM. **Selectivity: SSB:** 2.1 kc at 6 db down, 5.0 kc at 60 db down (crystal filter supplied). **AM:** 3.75 kc at 6 db down, 10 kc at 60 db down (crystal filter available as accessory). **CW:** 400 cps at 6 db down, 2.5 kc at 60 db down (crystal filter available as accessory). **Spurious response:** Image and IF rejection better than 50 db. Internal spurious signals below equivalent antenna input of 1 microvolt. **Audio response: SSB:** 350 to 2450 cps nominal at 6 db. **AM:** 200 to 3500 cps nominal at 6 db. **CW:** 800 to 1200 cps nominal at 6 db. **Antenna input impedance:** 50 ohms nominal. **Muting:** Open external ground at Mute socket. **Crystal calibrator:** 100 kc crystal. **Front panel controls:** Main tuning dial: function switch; mode switch; AGC switch; band switch; AF gain control; RF gain control; preselector; phone jack. **Rear apron connections:** Accessory power plug; HF antenna; VHF #1 antenna; VHF #2 antenna; mute; spare; anti-trip; 500 ohm; 8 ohm speaker; line cord socket; heterodyne oscillator output; LMO output; BFO output; VHF converter switch. **Tube complement:** (1) 6BZ6 RF amplifier; (1) 6AU6 Heterodyne mixer; (1) 6AB4 Heterodyne oscillator; (1) 6AU6 LM osc.; (1) 6AU6 LMO mixer; (2) 6BA6 IF amplifier; (1) 6AU6 Crystal calibrator; (1) 6HF8 1st audio, audio output; (1) 6AS11 Product detector. BFO, amplifier. **Power supply:** Transformer operated with silicon diode rectifiers. **Power requirements:** 120 volts AC, 50/60 cps. 50 watts. **Dimensions:** 14 1/2" W x 6 3/4" H x 13 3/4" D.

- Professional styling & features at 60% savings!
- Complete coverage of 80 through 10 meter amateur bands with all crystals furnished, plus provision for VHF converters
- Prebuilt, calibrated linear master oscillator (LMO)
- 25 KC per tuning knob revolution offers bandspread equal to 10 feet per megacycle
- Built-in crystal calibrator
- 2.1 KC crystal bandpass filter
- Stability of 100 cps after initial warmup
- Wiring harness & two heavy-duty circuit boards for easy assembly

The SB-300 SSB Receiver is the first in an exciting new series of Heathkit SSB amateur gear designed to bring you the finest in communications facilities at great savings. Its professional styling, quality and features offer performance never before found in kit equipment.

Features include a crystal-controlled front-end for same rate tuning on all bands; prebuilt, Linear Master Oscillator (LMO) for linear tuning with 1 kc dial calibrations; built-in crystal calibrator; hermetically-sealed 2.1 kc crystal bandpass filter; smooth, non-backlash vernier dial drive mechanism; optional AM & CW filters; high frequency I.F.; AGC control; provision for transceive operation with matching transmitter available soon. This new deluxe Heathkit SSB series is the greatest value ever announced in the Amateur Radio Industry! Send for free specifications on the SB-300 today, or order now for early delivery!

Kit SB-300... 17 lbs... no money dn., \$25 mo. \$264.95
SBA-300-1 CW Crystal Filter (400 cps)... 1 lb. \$ 19.95
SBA-300-2 AM Crystal Filter (3.75 kc)... 1 lb. \$ 19.95

WATCH FOR ANNOUNCEMENT OF OTHER MODELS IN THIS DELUXE HEATHKIT HAM SB SERIES!



HEATH COMPANY, Benton Harbor 20, Michigan 49023

Please send FREE 1964 catalog. Enclosed is \$ _____, plus postage.
 Please send model _____

Name _____

Address _____

City _____ Zone _____ State _____

FREE CATALOG!

HEATHKIT 1964



Send for your free copy today! Fully describes over 250 exciting Heathkits at savings of 50% or more! Choose from the world's largest selection of quality ham gear... "Mobile"... "Fixed" and Accessories.

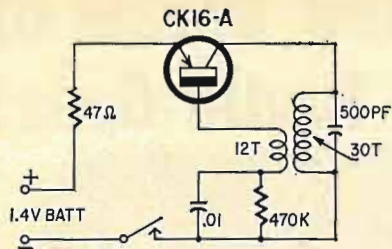

Fig. 4—Improved transmitter uses a blocking oscillator.

An improved circuit

The hiss produced when a contact is made is sometimes hard to distinguish from noise, particularly when the band is noisy, such as late at night. (On occasion we have found ourselves on the same band as WWV and the captains of Mississippi river boats.) To circumvent this problem we used the modified circuit in Fig. 4.

Self-blocking was introduced at an audio frequency so the signal could be more easily recognized. This approach produces a bonus in the form of a very broad band of transmission, in contrast to the narrow band of the continuous-wave oscillator circuit. Loss of reception because of signal drift is eliminated, although the audio frequency does vary a little with the temperature, the note rising when it increases. This circuit is much better for our purpose, since it not only solves the problem of drift caused by temperature variation or capacitance, but also makes the signal unmistakable. If anything, it is easier to construct and, happily, requires fewer components. The signal produced makes it simple to send Morse code by clenching the teeth—quite simple, but baffling to any unsuspecting radio receiver operator who happens to be nearby.

There are disadvantages in the design of this self-blocking oscillator too. The coil is extremely susceptible to loading—a serious problem, since the components are placed inside it. The range of transmission is also reduced considerably, sometimes to as little as 2 feet or so. If the unit will not self-block, the coil should be layer-wound and on a larger diameter (higher Q).

If range is not a consideration, the circuit should be most versatile, since the audio frequency can be altered within wide limits by varying the values of the resistors and capacitors in the circuit.

Applications

For the purpose for which it was designed, the tooth-sized radio transmitter has proved extremely useful. In one series of experiments, nightly recordings of occlusal contact patterns were recorded on tape. By playing the record back, it was possible to make a chart (at right above) showing the duration of tooth contacts at various times.

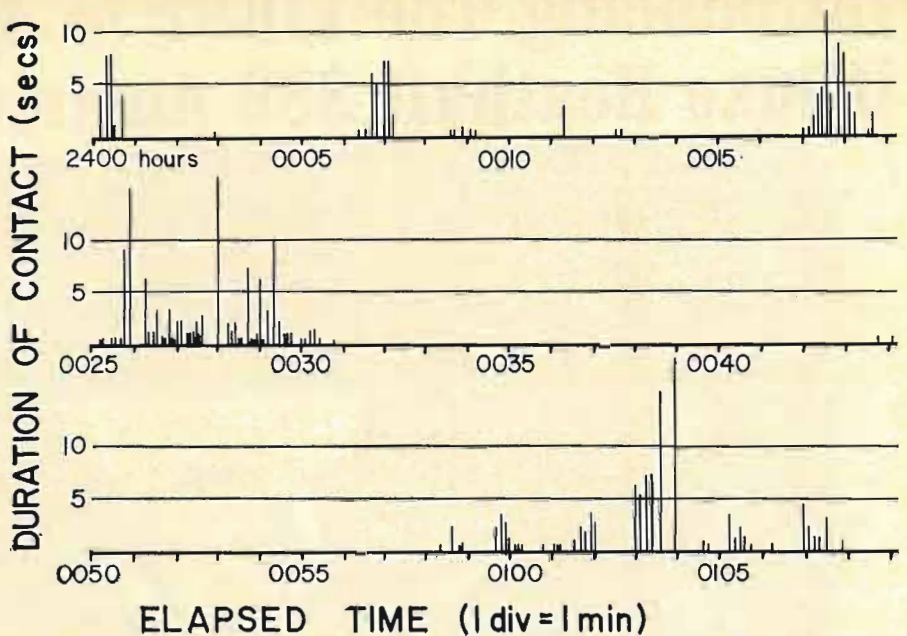

Contact patterns showing record of occlusion over period of hours.

Additional information on the subject's coughing and swallowing habits was recorded simultaneously by using a throat microphone and a 2-channel tape recorder. In this way it was possible to find out whether the tooth contacts were associated with periods of swallowing activity, wakefulness, coughing or snoring. Units have also been used to follow the behavior of the teeth and jaws while chewing various foods.

Other uses for such small units might be found. It is possible to measure large temperature variations with the units now, and they could be made even more efficient and sensitive by using thermistors. A low-impedance hearing-aid microphone inserted between the negative battery lead and the bottom of the coil turns the unit into an efficient

speech transmitter. A simple copper-zinc couple immersed in a dilute acid, or even saliva, provides enough power to operate the unit, which would solve battery problems in some applications. A little inspired fiddling with the basic circuit should make possible broadcasting speech, temperature, pressure, pH and conductivity. It's simply a matter of employing suitable transducers.

Available materials

It is unlikely that any research worker or experimenter would want to make a Chinese copy of this transmitter, so no parts list in the ordinary sense is given. But the materials, though available, are sometimes hard to locate, therefore the list under Fig. 3 may be helpful. END

Stereo Alarm for MPX Adapters

An audible indication of stereo multiplex transmissions can be obtained by simple modifications to the Knight KS-10, Lafayette KT-220 and similar multiplex adapters. This can be done by switching a capacitor across a portion of the 19-kc oscillator coil so the oscil-

lator loses sync by an audible frequency difference.

A .005- μ f capacitor connected from ground to the junction of C6 and the tap on the coil (see diagram) will produce a distinct note of about 1,000 cycles when a stereo transmission is tuned in. You may have to readjust the tuning slug to compensate for stray capacitance when the capacitor is switched out for listening.

The gain at 50 cycles can be increased about 4 db by disconnecting the 100,000-ohm resistors between the left and right output jacks and ground when they are not needed as grid returns or input loads for the following amplifiers. These resistors are R24 and R25 in the KS-10 and R23 and R25 in the KT-220. —Ben Johnson

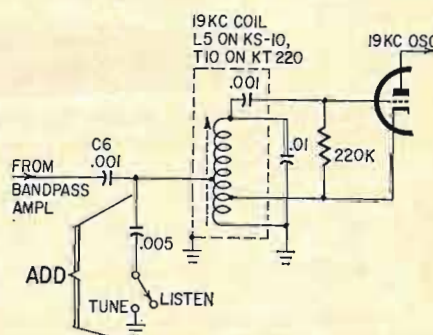

**NEW LOOK...
NEW SOUND...
NEW VALUE...
NEW HEATHKIT
SPEAKER
LINE**



**Need A High-Efficiency, High Fidelity Speaker
For A Particular Music System Job?**

... You'll Find It In Heath's Exclusive New Line!

Whether you want an advanced-engineered, professional-performing speaker for your custom music system, or need to replace a radio or TV speaker, you'll find it in this exciting new Heathkit line. Specially designed to meet Heath's exacting specifications, each speaker has been carefully crafted to perform a particular job. And regardless of which speaker you choose, each has a ceramic annular ring magnet for high efficiency and superior performance, plus polarized speaker terminals for proper phasing. All speakers except the least expensive in each size, have rugged, die-cast metal frames for life-long, trouble-free performance. In addition, each speaker is handsomely styled in a richly warm two-tone cinnamon and light tan motif, and carries a full one-year guarantee. Prices range from \$4.95 to \$49.95 . . . truly superb performance at unmatched savings! Send for your free Heathkit Catalog now, and select the proper Heathkit speaker to fulfill your needs!



8" Space-Saver Speaker, \$4.95



8" Dual-Cone Speaker, \$9.95



8" 2-Way Coaxial Speaker, \$14.95



12" Hi-Fi Speaker, \$9.95



12" 2-Way High Compliance Speaker, \$49.95



12" 3-Way High Compliance Speaker, \$39.95



12" 3-Way Coaxial Speaker, \$29.95



12" 2-Way Coaxial Speaker, \$19.95



HEATH COMPANY
Benton Harbor 20, Michigan 49023

Please send Free copy of new 1964 catalog.

Name _____

Address _____

City _____ State _____ Zip Code _____

HEATHKIT-1964



**NEW! FREE
1964 HEATHKIT CATALOG**

See the latest new products in Heathkit's wide, wonderful line. Over 250 do-it-yourself kits for stereo/hi-fi, marine, TV, electronic organ, amateur radio, test instruments, educational, home and hobby that will save you up to 50%. Send for your free copy today!



tough fight, Ma, but I WON!

By **FRANK A. SALERNO**

(Illustrated by the author)

IT ALL STARTED A MONTH AND A HALF ago with a call on an RCA KCS-40A with no video and no sound—just a white raster. I turned the set on and saw picture and sound both come on and within seconds slowly fade away. Without turning the set off, I started changing tubes one at a time, working from the video output stage right up forward. Nothing seemed to happen until I pulled out the 6J6 oscillator and stuck in a new one. The picture and sound pushed through. Satisfied, I picked up my bag and left.

Two weeks later I was back for the same complaint. I followed the same technique—changed the 12AU7 output tube first and worked my way up front. Again, the moment I changed the 6J6, the picture and sound boomed in. When the 6J6 just removed was reinstalled, the set worked perfectly.

I was sure we had local oscillator trouble so I took the set to the shop. An off-value resistor, perhaps, in the 6J6 plate load, I thought. So the first thing I did on the bench was make resistance measurements. All OK. I set the chassis up to operate and then began my long vigil. For one whole week I waited for that set to fade. I operated it hot, I operated it cold. I raised the line voltage, I lowered it. Nothing I could do induced the receiver to act up the way it did in the customer's home. Picture and sound stayed perfect.

I delivered the set and crossed my fingers. I might have saved myself the trouble because I was back again 2 days later. Same complaint. This time I merely touched the 6J6 to make picture and sound come through.

Discouraged but not yet defeated, I took the chassis back again. This time I loaned the customer a portable set that had been sitting around the shop, unclaimed, for the past twelve months. This way I planned to allow myself more time.

Sure enough, when I set up the chassis on the bench I found myself right back where I'd started. The set

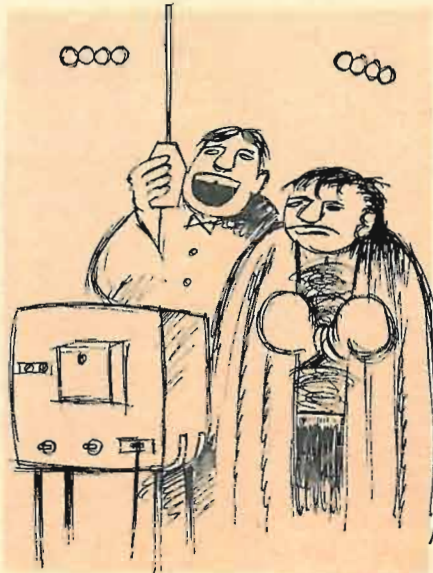

worked perfectly for days. I thought of replacing the entire tuner, but found these tuners were no longer available. So I was stuck with the repair whether I liked it or not.

Checking this receiver became my main preoccupation for the next 2 weeks. Every time I walked into the shop I'd turn the set on and wait for something to happen. But nothing ever did. I rapped it and tapped it and cooked it and covered it—everything short of kicking it—but she played on

and on. I ran it horizontally, ran it vertically. No use, I was licked.

It was on a rainy Thursday morning while I was searching my memory trying to remember what incidents in my life had directed me into television servicing when fate dealt me its cruellest blow. In came the portable-set owner asking me to deliver her set on Saturday.

I had reached my end and on Friday morning I decided to quit. I gave the receiver a couple more tries and called the customer on the phone to make an appointment to deliver it. Just before I dismantled the bench setup, I turned the switch on for one last try and, by the beard of Allah, the picture and sound quietly faded away!

I had already had the 6J6 plugged into a test socket so I immediately took voltage measurements. Much to my surprise the grid read 6 volts negative, indicating that the tube was oscillating. For the first time I began to suspect other trouble.

As I prepared for my next tests, the thing I dreaded most happened. Into the shop walked a little old lady with a radio tucked under her arm.

"Would you kindly check this for me? I wouldn't care to leave it, it's the only one I have. In these times one gets so to depend on a radio to get the latest

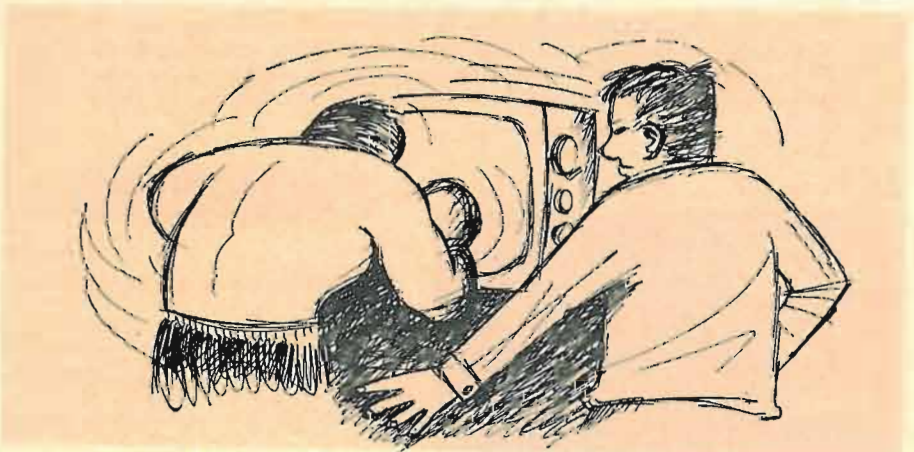



Who says you can't afford an organ this Christmas?

**This New Feature-Packed 1964 Model Of The HEATHKIT
2 Keyboard "Transistor" Organ Costs Just \$349.95 ...
AND YOU CAN BUILD IT!**

What a delightful surprise on Christmas morning! And there's endless hours of fun, relaxation, education and achievement ahead for the whole family with Heathkit's 1964 version of the famous Thomas Organ. You'll be saving big money too, by easily building it yourself! No experience necessary! And you're assured long, faithful performance with the full 5-year warranty on tone generators. Can't play a note? Learn quickly and easily with a complete 48-lesson self-teacher course on 4 LP records (GDA-232-2) that's valued at \$50 . . . it's yours for only \$19.95! Like to hear it perform? Send 50c to the address below, and ask for demonstration record GDA-232-5. Plan now to give your family the exciting dimension of live music with the 1964 Heathkit Electronic Organ this Christmas!

COMPARE THESE FEATURES WITH UNITS COSTING TWICE AS MUCH!

* **10 True Organ Voices**; Trombone, Reed, Flute, Oboe, Cornet, Violin, Saxophone, Horn, Viola, Diapason * **New! Variable Repeat Percussion**; produces effects of banjo, marimba, mandolin, balalaika, etc. * **Variable Bass Pedal Volume Control** * **Manual Balance Control**; adjusts volume of keyboards in any degree for solo work * **Variable Vibrato** * **Standard Expression Pedal**; adjusts volume from soft to full * **13-Note Heel & Toe Bass Pedals** * **Two Over-Hanging Keyboards**; each with 37 notes, range C thru C * **Beautiful Walnut Cabinet**; modern styling, hand-rubbed, hand-crafted * **20-Watt Peak-Power Amplifier & Speaker** * **Compact Size**; 34½" H x 39¾" W x 21½" D * **Transistorized**; for longer life, better tone, trouble-free operation.

Kit GD-232R, Organ, 160 lbs., no money dn., \$23 mo. \$349.95
GDA-232-1, Matching walnut bench, 16 lbs., no money dn., \$5 mo. \$24.95

Attention Heathkit Organ Owners! Add Variable Repeat Percussion to your Heathkit Organ with the easy-to-install kit.
GDA-232-4, 1 lb. only \$9.95



HEATH COMPANY, Benton Harbor 20, Michigan 49023

Name _____ (please print)

Address _____

City _____ Zone _____ State _____

HEATHKIT-1964



NEW! FREE 1964 HEATHKIT CATALOG
See all the latest products in Heathkit's exciting line. Over 250 do-it-yourself electronic kits in all . . . by far the world's largest line! There's something for every interest . . . stereo/hi-fi . . . marine . . . amateur radio . . . test and lab . . . television . . . home . . . and hobby. Send for your free copy today, and learn how you can save up to 50%.

Enclosed is \$349.95, plus postage, please send my Heathkit Electronic Organ, model no. GD-232R.

Enclosed is \$24.95, plus postage, please send matching walnut bench, model no. GDA-232-1.

Please send my free copy of the new 1964 catalog.

news what with so much happening all over the world and so much trouble here and there and . . . My, how fast you work."

Fast, indeed, but not fast enough, for as I stood there nervously fumbling with the radio the sound on the TV receiver behind me blasted through. "Of all the luck," I mumbled.

However, there was still a spark of hope. For the first time since I got entangled with the set, it suddenly became predictable. If I allowed the set to cool off a while and then turned it on again, the picture would fade away and let me have another go at it. But I had to work fast. If I hesitated too long, everything would bounce back.

Carefully, I edged on. Plate voltages OK. Screen voltages OK. Agc voltage—aha! Too high. About 50 negative. Back to the agc amplifier. Plate voltage too high. Grid voltage too low.

Each little disturbance would snap the picture back in place and each time it did I was afraid that I'd had it. But my luck was still holding out. Every time I let the set cool off a while and then turned it on again, it gave me another chance.

Finally, after 30 minutes of touch-and-go troubleshooting I came to a conclusion. I thought I had a bad 6SN7 agc rectifier tube, but I was afraid to even go near it for fear that one reckless mistake might snap the set back to normal and leave me in doubt for the rest of my electronic life. But I had no choice. All checks assured me that this tube was the troublemaker, so I got ready for the do-or-die finale. I turned the set on, waited for it to fade, and then, like the diamond cutter who raises his cleaver after weeks of fastidious planning, I raised my screwdriver and delivered the master stroke. I hit the tube, the picture shot in, the sound blasted through and I fainted. That was it!

END

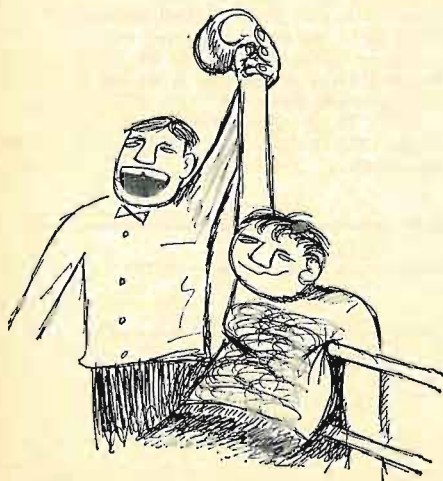

WHAT'S YOUR

EQ?

These are the answers.

Puzzles are on pages 55 and 56.

An Unusual Twist

A second photo taken by the photographer answers both questions. The technician was using a degaussing coil to demagnetize the monochrome metal picture tube. The unusual twist was due



to the flux of the degaussing coil affecting the beam deflection. It might be said that the unusual twist was due to a crazy-mixed-up deflection beam.

L-C-R Circuit

The voltage across a single reactive element in a series circuit carrying ac can have a greater effective value than that of the applied voltage. Since the current in each part of the circuit is 3 amps, the voltage drop across the inductance, and hence the reading of voltmeter D, can be calculated:

$$E = IX_L = 3 \times 5,000 = 15,000 \text{ volts.}$$

The voltage drop across the capacitance, and hence the reading of voltmeter C is:

$$E = IX_C = 3 \times 5,000 = 15,000 \text{ volts.}$$

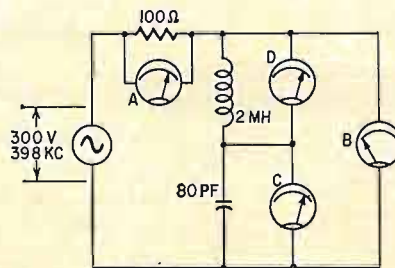

The inductive and capacitance voltage drops are equal in magnitude and

180° out of phase; so their vector sum is zero. This is shown by voltmeter B, which reads zero volts. The voltage drop across the resistor, and hence the reading of voltmeter A, is $E = IR = 3 \times 100 = 300$ volts.

Bewildering Blinker

This is what I think is happening. If you have a better solution, let's hear it! This circuit is merely a simple series-resonant device with the L and C combination resonant at about 50 cycles when zero current is flowing. When current flows through the circuit, the inductor's inductance decreases with increasing current due to saturation of its iron core.

Hence, at a critical current, determined by the Variac, the circuit moves its resonant point toward 60 cycles and the lamp grows brighter. But as the lamp becomes brighter its resistance increases, the L-C series circuit goes out of resonance, and the light dims. Upon dimming, the lamp's resistance decreases and starts the cycle again.

Without stretching one's imagination, it is plain to see that we have a negative-resistance oscillator constructed out of seemingly passive elements.

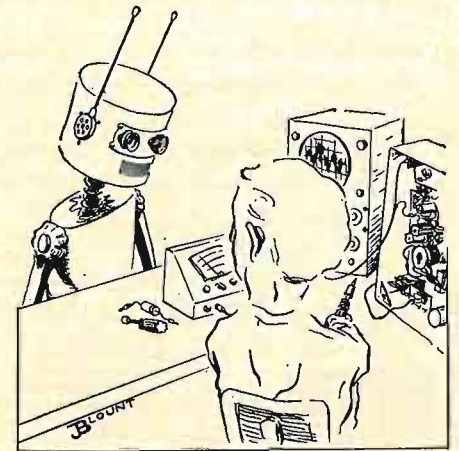

"Tom, I'm a little short. Could you loan me a fast-charge till pay day?"

catch up with world-wide developments in electrical & electronics engineering!

100,000

engineers & scientists on 6 continents will read the informative November issue of proceedings—will you?

November's special issue of **Proceedings of the IEEE** is the most important of 1963—it will spell out, in about 25 articles written by world-famous authorities, the electrical and electronics progress being made **outside** North America. URSI's 50th anniversary will also be reviewed.

100,000 engineers and scientists all over the world will read their subscription copy of November's **Proceedings** with intense interest. If you are not yet a subscriber, make sure you receive your copy of this fact-filled issue—fill out and mail the coupon today!

Here's a sampling of 5 much-needed articles—

Experimental research on behavior of passive repeaters for microwave radio links:

COLAVITO & D'AURIA, ITALY

Some observations on V.L.F. standard frequency transmissions

THOMPSON, ARCHER, HARVEY, AUSTRALIA

Space-charge limited solid state devices

G. T. WRIGHT, ENGLAND

Hall effect gyrators, isolators and circulators of high efficiency

GRUTZMANN, WEST GERMANY

Low noise non-reciprocal parametric amplifier with power matching at the input and output

MAURER AND LOCHERER, WEST GERMANY

Remember—November **Proceedings** will carry 20 more!

The Institute of Electrical & Electronics Engineers, Inc.
Box A, Lenox Hill Station
New York 21, N. Y.

Gentlemen:

Yes, I want to join the 100,000 world-wide electronics engineers and scientists who will be reading the November issue of **Proceedings**.

I am not an IEEE member.

I'm enclosing check money order for \$3.

Bill me later.

Please mail my copy of **Proceedings** to (please print)

Name

Street & No.

City State

I understand your offer is good for a limited time only, as the "World Achievement Issue" may soon be sold out.

Proceedings of the IEEE

The Institute of Electrical & Electronics Engineers, Inc.
Box A, Lenox Hill Station, New York 21, N. Y.

Boston • Fairfield, Conn. • Demarest, N.J. • Philadelphia • Bath, Ohio
• Chicago • Minneapolis • Los Angeles • San Francisco • Paris • Tokyo



Exclusive with **RCA** ...

AUTOTEXT®

the faster, easier way toward a career in electronics

Amazing home training method makes learning almost automatic

Exclusive with RCA. "AUTOTEXT" the revolutionary home training method introduced by RCA Institutes, Inc., is stirring the interest of thousands. Every day, "AUTOTEXT" is helping people like yourself join the thousands of other successful electronic students who are working toward profitable careers right now! This faster, easier way to learn electronics uses the latest scientific development in the field of home training—and "AUTOTEXT" is exclusive with RCA.

Tested throughout the country. This exciting new trend in education represents a significant advance in teaching electronics. People who have been interested in careers in electronics in the past, but have had difficulty with conventional home training methods, can now begin to master the fundamental principles of electronics almost automatically. Tested in schools throughout the country, checked out and proved with thousands of students, programmed instruction is helping people learn more quickly and with less effort.

Prove it to yourself now! If you have a natural inclination or interest in the exciting field of electronics, that's all you need. RCA "AUTOTEXT" will help you do the rest.

And the future is unlimited. Jobs are available for qualified technicians in Space Electronics, Communications, TV, Computer Programming, Automation, and many other electronic fields. The important thing is to get started now!

Complete course available. Right now, RCA Institutes offers you a complete Home Training Course ("Introduction to Electronics") using the "AUTOTEXT" method. You get a complete set of theory lessons, service practice lessons, experiment lessons, and all the kits you need. And most important, "AUTOTEXT" takes most of the effort out of learning the all-important groundwork of the electronics field.

FREE OFFER! We'll send you complete information on amazing new RCA "Autotext" along with a FREE SAMPLE of a lesson to prove to you how easy it is to learn this new way. Send the attached postage-paid card and check "Autotext".



Wide choice of Home Training courses in Electronics:

- Autotext
 - Introduction to Electronics
 - Introduction to Semiconductors
- TV Servicing
- Color TV
- Communications Electronics
- FCC License Preparation
- Mobile Communications
- Automation Electronics
- Electronic Fundamentals (also available in Spanish)
- Computer Programming
- Transistors
- Electronic Drafting
- Industrial Electronics
 - Automatic Controls
 - Industrial Applications
 - Nuclear Instrumentation
 - Digital Techniques

RCA Institutes Home Training Courses are complete step by step easy-to-understand units. You get prime quality equipment in the kits furnished to you, and all of it is top grade. It's yours to keep and use on the job.

Liberal Tuition Plan. RCA Institutes Home Training Courses are available under a liberal tuition plan that affords you the most economical possible method of home training. You pay for lessons only as you order them. If, for any reason, you should wish to interrupt your training, you can do so and you will not owe a cent until you resume the course. No long-term obligations!

Set Your Own Pace. RCA Institutes Home Training takes into consideration your own ability, finances and time. You learn at your own speed, in the most effective manner, with personalized instruction every step of the way. You get theory, experiment, and service practice beginning with the very first lesson. All lessons are profusely illustrated—a complete training package in every way.

CLASSROOM TRAINING

RCA Institutes Resident Schools in New York City, Los Angeles and RCA Technical Institute in Cherry Hill near Camden, N. J., offer classroom training that will prepare you to work in rewarding research and production positions in many fields of electronics. No previous technical training required for admission. You are eligible even if you haven't completed high school.

Free Placement Service. RCA Institutes Resident School graduates are now employed in important jobs at military installations, with important companies such as IBM, Bell Telephone Labs, General Electric, RCA, in radio and TV stations and in communications systems all over the country. Many other graduates have opened their own businesses. A recent New York Resident School class had 92% of the graduates who used the FREE Placement Service accepted by leading electronics companies, and had their jobs waiting for them on the day they graduated!

Coeducational Day and Evening Courses are available at Resident Schools. You can prepare for a career in electronics while continuing your normal, full-time or part-time employment. Regular classes start four times a year.

SEND POSTCARD FOR FREE ILLUSTRATED BOOK TODAY! SPECIFY "AUTOTEXT", HOME STUDY OR CLASSROOM TRAINING.

RCA INSTITUTES, INC. Dept. ZRE-N3

A Service of Radio Corporation of America,
350 West 4th St., New York 14, N. Y.
Pacific Electric Bldg., 610 S. Main St., Los Angeles 14, Calif.



The Most Trusted Name in Electronics



Olson KB-141 Rf/ Af Generator-Tracer

SMALL ENOUGH FOR THE KITCHEN-TABLE experimenter or for a service call, this combination instrument can provide frequencies between 250 kc and 120 mc (modulated or unmodulated) for alignment and signal injection. The audio modulating frequency can also be used for signal injection.

The accuracy of the Olson KB-141 depends mostly on the kit builder's ability to calibrate the instrument against a reliable signal. This is simplified for the frequencies between 250 kc and 1,600 kc. Any table radio can be used by tuning it to a station whose frequency is known. Lower frequencies can be calibrated by using their harmonics.

The zero-beat can give accuracies of better than .01% in a similar manner. The highest frequency band can be adjusted by squeezing or stretching the coil. You need calibrate only one frequency on each band. The signal tracer and audio generator need no calibration.

The audio generator is used to modulate the rf generator (see Fig. 1). There is no separate audio output jack, but the audio signal can be easily obtained. Just connect the rf/i.f. demodulator probe to the rf output jack and switch to MOD. This gives an audio signal output even though the demodulator circuit is connected backward as far as



The Olson KB-141 audio and rf signal generator and signal tracer comes with probes and cables.

normal signal flow is concerned.

When the demodulator probe is connected to the input of the audio pre-amp, it can be used to trace an rf or i.f. signal provided by the generator portion of the instrument.

Switch the probes from their respective jacks and the demodulator

COMING NEXT MONTH: RADIO-ELECTRONICS COLOR TV ISSUE

CITIZEN BAND STANDARDS BY SONAR

When performance is critical and reliability a necessity SONAR CAN BE DEPENDED UPON. CB standards of Sonar must and will always be above and beyond what is expected. Write for full particulars.



MODEL G Featuring the NEW Sonar noise silencer. Dual conversion - RF output meter - Signal strength meter - Crystal spotting switch - Illuminated panel - 8 channels crystal-controlled - Receiver tunes 23 channels - Class "B" modulation

Complete with 1 pair of crystals and microphone

\$22950



MODEL E FCC type accepted - 8 channels, crystal-controlled transmitter/receiver - Tunable receiver for 23 channels - Powerful transmitter 100% Class B modulated - Automatic noise limiter - Lightweight, compact.

Complete with 1 pair of crystals and microphone

\$17950

SONAR RADIO CORPORATION
73 Wortman Ave., Brooklyn 7, N.Y.

Please send me complete information on
 Model E Model G

NAME.....
ADDRESS.....
CITY.....STATE.....

Dept. 278

CASH FOR YOU-



Electric APPLIANCES

Learn at Home • \$3 to \$5 an Hour
Spare Time, Full Time • Be Your Own Boss

FREE BOOK tells about profitable business you can run—right at home. Repair Electric Appliances using simple tools. Pays \$3-\$5 an hour!

QUICK WAY TO GET STARTED

For less than 20¢ a day, our easy instruction—backed by 45 years of success in home-training—prepares you for top earnings. Earl Reid of Thompson, Ohio, says: "Made \$510 in one month spare time." At no extra charge you get Appliance Tester, too. Finds trouble-spots, checks your work.

CASH IN ON THIS BIG BOOM

400 MILLION Appliances are in American homes right now. People need them fixed. You make good money doing it. In your basement, garage, even your kitchen.

Get your **FREE** Book and **FREE** Sample Lesson! Mail coupon below, letter or postcard, now.

NATIONAL RADIO INSTITUTE, Appliance Div.
Dept. FMS, Washington 16, D. C.

Send Free Book, Free Appliance Repair Course Lesson. Am interested in:

Spare Time Earnings My Own Business
 Better Job

Name.....

Address.....

City.....Zone.....State.....

Accredited Member National Home Study Council

NEW!

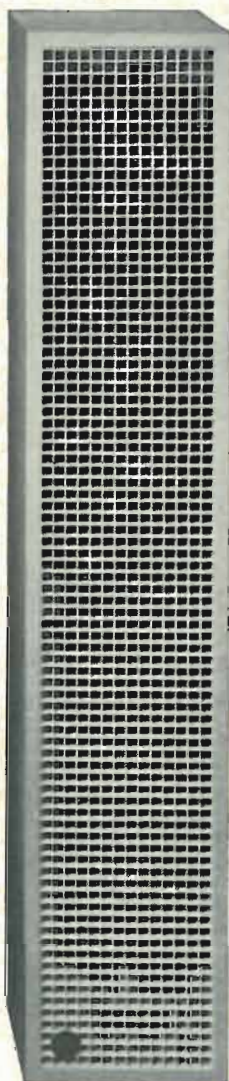

UCS-6

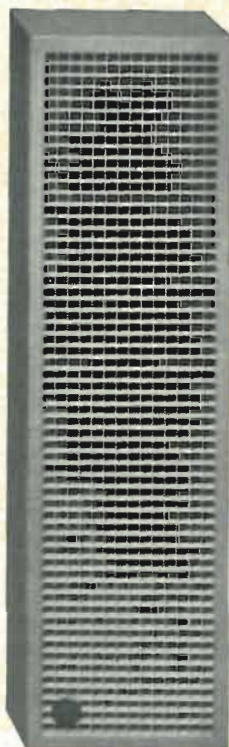

CS-4



CS-3



CSO-6

The Big Plus—Uniline Sound Columns

Performance is the big plus when you install University Uniline Sound Columns. Unlike conventional columns, Uniline employs specially-designed speakers with higher power handling capacity. "Acoustic-Tapering"—another University exclusive, prevents excessive high frequency beaming and assures a uniform sound volume within its fan or beam. The

result—higher intelligibility, optimum sound dispersion at all frequencies, greater listening comfort. All individuals hear the same sound! The table below shows complete specifications for all Uniline Sound Columns, including the new weatherproof model CSO-6 for outdoor installation. For complete PA Loudspeaker Catalog, write Desk J-11.

	UCS-6 Full Range Music and Speech	CS-4 Full Range Music and Speech	CS-3 Music and Speech	CSO-6 Full Range Music and Speech
speakers	6 extended range 8"	4 extended range 8"	8 special multi-design	6 extended range 8"
frequency range	55—17,000 cps	70—17,000 cps	150—10,000 cps	55—17,000 cps
power capacity	150 watts IPM*	80 watts IPM*	25 watts IPM*	150 watts IPM*
impedance	16 ohms	8 ohms	16 ohms	16 ohms
vertical angle	16°	22°	22°	30°
horizontal angle	120°	120°	120°	120°
dimensions	59¼" x 10⅞" x 9¼"	40¾" x 11" x 9¼"	48" x 7½" x 8¾"	60¼" x 11⅞" x 7¾"
shipping wt., lbs.	61	46	33	61

*Integrated program material.

UNIVERSITY LOUDSPEAKERS Division of Ling-Temco-Vought, Oklahoma City, Oklahoma

do
you
belong
to
a
service
technicians'
association?...
club?...
student
or
employee
group?...

YES?

Then you are
eligible to
take advantage of

RADIO-ELECTRONICS

special group subscription rates

WRITE to our friendly
representative

MR. G. ALIQUO

RADIO-ELECTRONICS

154 West 14th Street
New York 10011

He'll give you full details

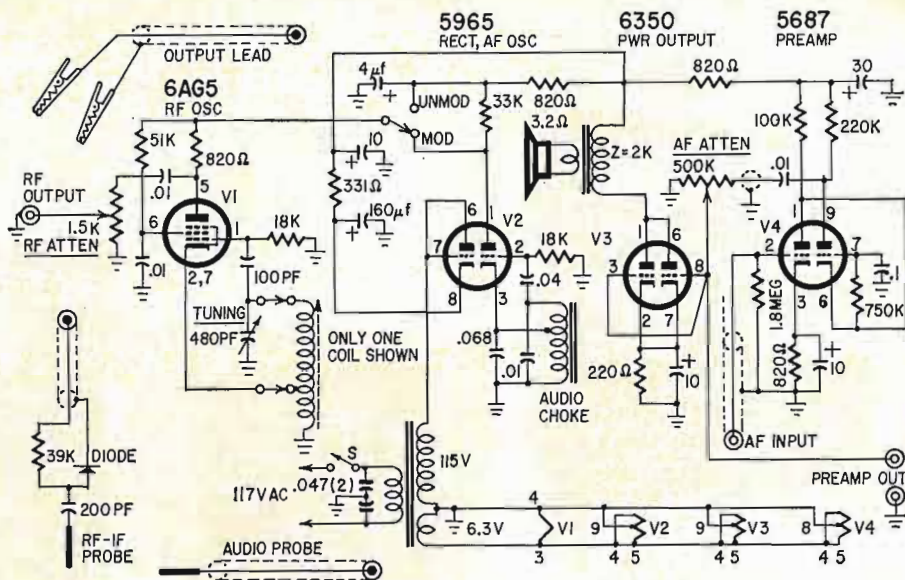
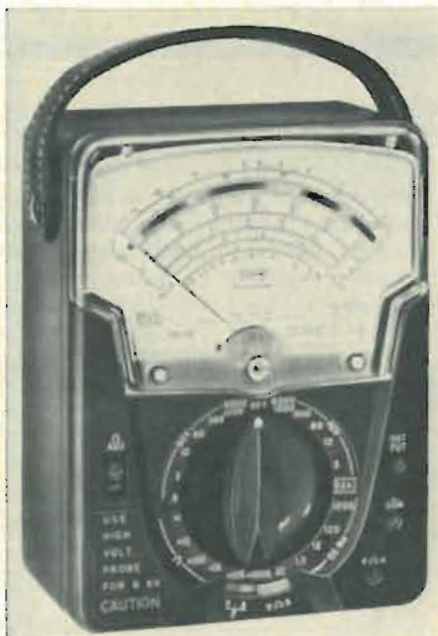

Fig. 1—Circuit of Olson's KB-141. It uses several premium tubes, one as cascade preamp.

probe will now provide an audio signal for injection into an amplifier, and the "direct" probe can be used to signal-trace. You will hear the audio signal from the speaker mounted in the top of the case.

Another jack allows the cascade preamplifier of the audio stage to be used as a separate preamplifier—to feed scopes, vtm's or other devices that need increased signal level.—Elmer C. Carlson

200,000 Ohms/Volt Multimeter (Triplet 630-NS)



Triplet's 630-NS 200,000 ohms-per-volt multimeter has taut-band movement.

FOR YEARS, TOP HONORS FOR THE MOST useful radio and industrial servicing instrument have been shared by the 11-

megohm vtm and the 20,000-ohms-per-volt multimeter. Now, both are being challenged to a winner-take-all battle for superiority by the new Triplet 630-NS multimeter, one of the latest additions to the famous line of Series 630 testers.

The 630-NS is a dual-sensitivity instrument measuring up to 3,000 volts dc at 200,000 ohms per volt and up to 6,000 volts at 100,000 ohms per volt. Ac voltages in the same ranges are measured at 20,000 and 10,000 ohms per volt, respectively. The basic full-scale dc voltage ranges are 0.6, 3, 12, 60, 300 and 1,200.

The instrument operates much the same as other vom's. Besides the usual controls, there is a two-position slide switch. One position is marked V-Ω-A and the other V-A 2. In the V-Ω-A position, the full-scale voltage or current is that indicated by the range selector and voltages are measured 100,000 ohms per volt. Throwing the slide switch to V-A/2 cuts the full-scale voltage or current range in half and increases the voltage sensitivity to 200,000 ohms per volt.

By selecting the proper range and

**FINEST
MONEY-MAKER
FOR
Professional
Servicemen**

Multiple-Socket Speed with Gm Accuracy

PLUS OBSOLESCENCE PROTECTION



TESTS
All TV and Radio Tubes
—Old and New

TESTS
Nuvistors and Novars

TESTS
European Hi-Fi Tubes,
Voltage Regulators, and
Most Industrial Types

TESTS
the New 10-Pin Tubes

TESTS
for True Dynamic
Mutual Conductance (Gm)

TESTS
the New 12-Pin
Compactrons

Model 700 DYNA-QUIK DYNAMIC MUTUAL CONDUCTANCE TUBE TESTER

See your B & K Distributor
or Write for Catalog AP21-E

TESTS BOTH OLD AND NEW TUBE TYPES—SELLS MORE TUBES PER CALL

All over the nation, thousands of professional servicemen rely on the "700". Once you use it, you'll be as enthusiastic as they are. *Everyday use has proved its speed . . . its accuracy . . . its efficiency.* This up-to-date, obsolescence-proof tube tester is designed for maximum use *today and tomorrow.* Provides multiple-socket section to quick-check most of the TV and radio tube types the *true dynamic mutual conductance way*—plus simplified switch section to check new tube types in Dyna-Quik emission circuit. Also includes provision for future new sockets.

Makes test under set-operating conditions. Checks each section of multi-section tubes separately. Checks for *all* shorts, grid emission, leakage and gas. Makes quick "life" test. Exclusive *adjustable* grid emission test provides *sensitivity to over 100 megohms.*

Makes complete tube test in seconds. Checks average set in a few minutes. Discovers weak tubes that need replacement. *Satisfies more customers. Sells more tubes. Saves call-backs. Insures your reputation.* Net, \$16995

Time-Saving, Money-Making Instruments Used by Professional Servicemen Everywhere



Model 960 Transistor
Radio Analyst



Model 360 V O Matic
Automatic VOM



Model 375 Dynamic
Automatic VTVM



Model 1076
Television Analyst



Model 445 CRT
Rejuvenator Tester

NEW TUBE INFORMATION SERVICE
Available every 3 months, on subscription,
for all B&K Dyna-Quik Tube Testers



B & K MANUFACTURING CO.
Division of DYNASCAN CORPORATION
1801 W. BELLE PLAINE AVE. • CHICAGO 13, ILL.
Canada: Atlas Radio Corp., 50 Wingold, Toronto 19, Ont.
Export: Empire Exporters, 233 Broadway, New York 7, U.S.A.

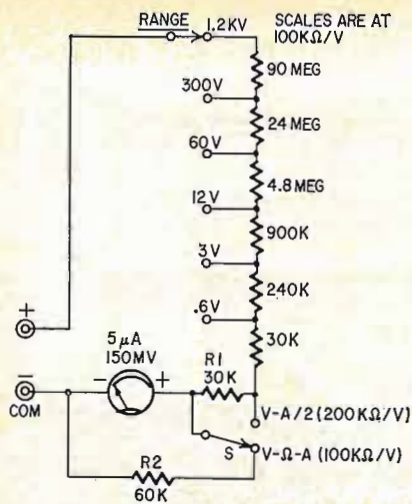

Fig. 2—Partial schematic of multiplier string in Triplet 630-NS. Switch *S* doubles sensitivity, halves range.

setting the slide switch, all current and voltage readings can be made on the upper half of the scale, where accuracy is greatest.

How sensitivity selector works

Let's see how the dual-sensitivity circuit works. Fig. 2 shows how the basic voltage measuring circuit works. The ranges shown on the range switch are full-scale values measured at 100,000 ohms per volt with the slide switch, *S*, in the V-Ω-A position. In this case, *R2* shunts the meter movement to reduce

the basic sensitivity to 100,000 ohms per volt and *R1* is a part of the multiplier string. Sliding the switch to the V-A/2 position increases sensitivity to 200,000 ohms per volt and reduces the lowest range to 0.3 full scale and the highest to 600 volts, by removing shunt *R2* and shorting out *R1*. The 30,000 ohms resistance of the meter replaces *R1* in the multiplier string.

The principal advantage of the 630-NS is its unusually low loading on high-impedance circuits. Let's take a look at the simple 22-megohm voltage divider in Fig. 3, such as you might find in keyed-agc circuits, and see how a meter's input resistance affects accuracy as we measure the voltage across *R2*.

First we will use an ordinary 20,000-ohms-per-volt meter on its 250-volt range. The meter's 5-megohm input re-

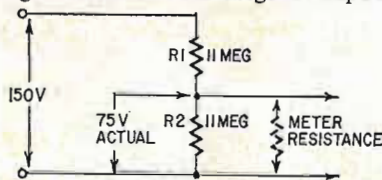

Fig. 3—High-resistance divider shows weakness of 20,000-ohm/volt meters and 11-megohm vtvm's. Triplet 630-NS loads it far less, reads nearer "true" voltage.

sistance shunts *R2* and reduces *R2*'s effective resistance to 3.437 megohms. Current through the string increases and

the voltage across *R2* and the meter drops to 35.4—less than half its actual value. With an 11-megohm vtvm, the effective value of *R2* is reduced to 5.5 megohms and the voltage drops to 49.5—still a considerable error.

Now, let's see what we can do with the dual-sensitivity 630-NS. Normally, we would set the range switch to 300 and the sensitivity selector to V-A/2 for 150 volts full scale at 200,000 ohms per volt. The meter's input resistance is 20 megohms, and the voltage across *R2* rises to 62.4. On the 600-volt range (1,200 divided by 2) the input resistance is 12 megohms and the voltage rises to 71.5. This is laboratorylike precision, considering the accuracy of the other instruments cited in this example.

Other advantages of the 630-NS with its 5- μ a, 150-mv movement can be seen by comparing its lower voltage and current ranges with the basic Triplet 630—one of the long-time standards in 20,000-ohms-per-volt instruments. For example, the first three voltage ranges on the 630 are 3, 12 and 60. On the new 630-NS, they are 0.6, 3 and 12 or 0.3, 1.5 and 6, depending on the sensitivity required or the magnitude of the voltage being measured.

Suppose that we want to measure the voltage between base and emitter in the circuit in Fig. 4. With the 630 or similar 20,000-ohms-per-volt instrument, our best bet would be to measure the

PRECISION/PACO

DELIVERING NOW...

voltages on the individual elements and hope that our old eyes are sharp enough to differentiate between 0.6 and 0.7 volts—two divisions well down on the scale.

With the 630-NS, we set it to 0.3 volt full scale and measure the voltage between base and emitter in one operation. Accuracy and readability are much greater because 0.1 volt now covers a third of the scale.

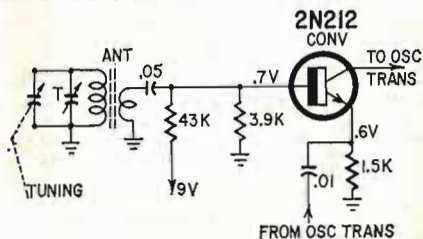

Fig. 4—Base-emitter bias of 0.1 volt is almost unreadable on conventional bench instruments; 0.6 and 0.7 volt, indistinguishable. On 630-NS's 0.3-volt range, there's no problem.

New movement

A not-so-obvious advantage is the ruggedness of the new meter movement. The old hairsprings, pivots and jeweled bearings have been eliminated. Bearings and pivots in portable instruments take quite a beating. Friction increases with age and accuracy is impaired.

In the new "suspension-band" meter the moving coil is suspended by a pair of platinum wires finer than a human hair. They support the coil as-

sembly, carry current to it and provide the torque to return the needle to zero. They work a bit like automobile torsion bars.

I cooked up all sorts of tests to compare the 630-NS with the vtvm and 20,000-ohms-per-volt meter so I could go on and on raving about the 630-NS and the new breed of multimeter that is sure to follow. It provides greater accuracy through lower circuit loading and a wider choice of ranges. Its mirror scale eliminates errors caused by parallax. I feel that the added versatility of the 630-NS is well worth the price differential—around \$40—between it and a comparable 20,000-ohms-per-volt instrument. It won't replace the vtvm on the bench, but it comes pretty close to it.

—Robert F. Scott

SPECIFICATIONS

- Dc volts—0—0.3—0.6—3—12—60—300—1200 at 100,000 ohms/volt
- 0—0.15—0.3—1.5—6—30—150—600 at 200,000 ohms/volt
- Ac volts—0—3—12—60—300—1200 at 10,000 ohms/volt
- 0—1.5—6—30—150—600 at 20,000 ohms/volt
- Db— -20 to +77 in 10 ranges
- Dc microamperes—0—5 at 300 mv; 0—60—600 at 150 mv; 0—120 at 300 mv.
- Dc milliamperes—0—6—60—600 at 150 mv; 0—1.2—12—120—1200 at 300 mv.
- Dc amperes—0—6 at 150 mv; 0—12 at 300 mv.
- Ohms—0—1K—10K—100K (4.4—44—440 at center scale)
- Megohms—0—1—10—100 (4400—44,000—440,000 ohms center scale)
- Output—Capacitor in series with ac volt ranges

ANTENNA FOR THE LATE-LATE SHOW?

SOME RESIDENTS OF AUSTIN, TEX., SEEM to be going to desperate extremes in trying to get good TV from San Antonio, about 70 miles away. Warren Smith, a television repairman in Austin, sent us this photo of one man's approach. The antenna—possibly patterned after sleep-like-a-log-periodic principles—is exactly what it looks like: a bedspring. A local technician states that investigations indicated that reception wasn't too good. Maybe a reflecting sheet would help?



The multi-helical array looks more like a search radar antenna than an ordinary gatherer of TV signals.

A NEW LINE OF TEST EQUIPMENT, HI-FI KITS & WIRED COMPONENTS

A new look! A new peak of quality!
A new high in the blending of price and performance!

Look at these typical examples of this great new line:

Test Equipment



Vacuum Tube Voltmeter
V-70K(Kit) \$31.95
V-70W(Factory Wired)
\$55.95



In-Circuit Capacitor Tester
C-25K(Kit) \$19.95
C-25W(Factory Wired)
\$32.95



5" Wide Band Oscilloscope
DC to 5MC--S-55(Kit) \$99.95
S-55W(Factory Wired)
\$155.95



RF Signal Generator
G-30K(Kit) \$32.95
G-30PCK(Semi-Kit) \$39.95
G-30W(Factory Wired) \$44.95

Integrated Kits & Wired Components



Integrated Stereo Preamplifier
SA-50(Kit) \$89.95
SA-50W(Factory Wired) \$149.95



Stereo Multiplex Tuner
ST-55MXK(Kit) \$109.95
ST-55PAMXX(Semi-Kit) \$139.95
ST-55MXW(Factory Wired) \$159.95

And they're all ready for delivery now!

Write today for our new fully illustrated brochure that includes specifications and prices on the entire new line!

PRECISION

Apparatus, Inc.

80-00 Cooper Ave. Glendale 27, N. Y.
212 TW 4-4290

TRANSISTORS AND YOUR OHMMETER

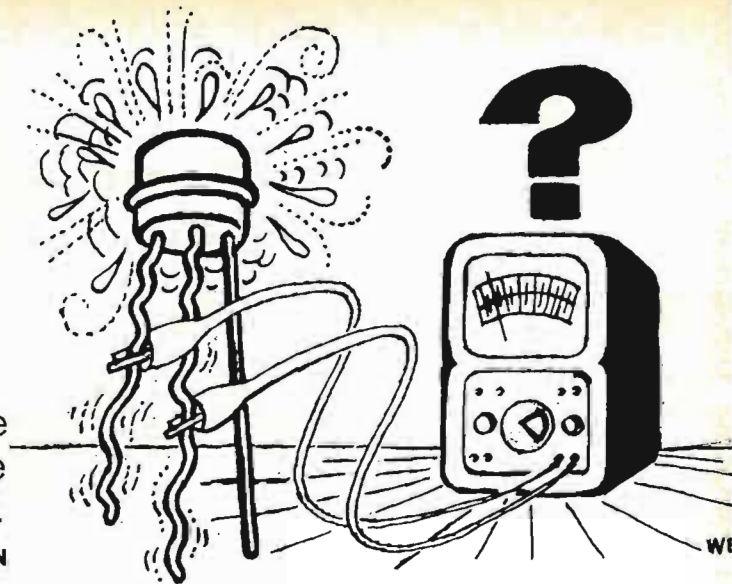

A transistor can expire quietly while you're checking to see if it's good. But with a little care, you can use your ohmmeter.

By GENE MADISON

YOU'VE HEARD THESE VAGUE WARNINGS of dire consequences if you check transistors with an ohmmeter. Since the vom is probably the most often used test instrument, it would be nice to know if we can use it safely for transistor checking.

The table will show you what astonishing amounts of current flow through a resistance being measured with a conventional vom. Voltages, too, can be high. Further, the red test lead is *not* always connected to the positive side of the internal battery. The table shows only three popular meters. If you have a different one, make up a chart like this for it. You may be surprised.

Generally, an ohmmeter range that produces not more than 1.5 volts open circuit and 1 ma short circuit is safe for any transistor made, no matter how you connect it to the meter. The aster-

isks in the table next to certain ranges show which are safe to use under almost any circumstances.

What can you find out?

Let's see what we can learn about a transistor with an ohmmeter's "safe" range. All the following checks should be made with at least two of the three transistor leads disconnected from the circuit, and power off. Which leads you disconnect doesn't matter. The polarities are given here for p-n-p transistors; for n-p-n just reverse the test leads. (Remember to find out what the polarity of your meter is.)

Small-signal germanium: Positive lead on emitter, negative on base. About 300 to 400 ohms. Move negative lead to collector. About 10,000 to 50,000 ohms. If either reading is near zero or near infinite, transistor is bad.

Germanium power: Emitter-to-base resistance can be as low as 30 to 50 ohms; emitter-to-collector, a few hundred ohms. These types can handle ohmmeter-type currents without damage, so short momentarily between base and collector to see if that causes a sharp drop in resistance between emitter and collector. It should.

Silicon: Emitter-to-base resistance will be between 1,000 and 2,000 ohms. Emitter-to-collector resistance may be so high that it has to be measured on next higher "safe" range.

These are simple "go-no-go" checks. But an ohmmeter can also distinguish p-n-p and n-p-n transistors and identify their leads. Here's how.

Using a "safe" range, try various connections until you find a lead that measures about the same resistance to each of the other two. This is the base. If the resistance is about 400 ohms, you have a germanium transistor; if it's about 1,500, you have silicon. If you connected the positive ohmmeter lead to the base to find this information, the transistor is an n-p-n; if negative, it's a p-n-p. Now connect the ohmmeter to the remaining two leads and note the resistance. Reverse the leads and read again. Whichever connection gives you the lower reading is the one you want now.

If you found that the transistor was a p-n-p, the positive meter lead is on the emitter and the negative one on the collector. For an n-p-n, just the reverse is true.

Another test

Though an ohmmeter will not replace a good transistor tester, it can help you determine the *relative* dc beta of several transistors of the same type. For n-p-n transistors, hook the positive meter lead to the emitter, the negative to the collector, and leave the base lead completely free. The lower the resistance, the higher the dc beta. You can match transistors this way, or pick out the best from a group. It is actually an indirect measurement of I_{ceo} , or collector-to-emitter leakage. END

VOLTAGES AND CURRENTS ON RESISTANCE RANGES OF THREE VOM'S

MAKE MODEL & RANGE	OPEN- CIRCUIT VOLTS	SHORT- CIRCUIT CURRENT	POLARITY
SIMPSON 260			
R × 1	1.5	100 ma	RED POS BLACK NEG
*R × 100	1.5	1 ma	
R × 10,000	7.5	60 μa	
TRIPLETT 630			
R × 1	1.5	320 ma	RED NEG BLACK POS
R × 10	1.5	32 ma	
*R × 100	1.5	3.25 ma	
*R × 1,000	1.5	325 μa	
R × 100,000	22.5	70 μa	
TRIPLETT 310			
R × 1	1.5	7.5 ma	RED NEG BLACK POS
*R × 10	1.5	750 μa	
*R × 100	1.5	75 μa	
R × 10,000	15.0	75 μa	

technicians' News

Dorst Elected NATESA President

Chicago — Larry Dorst, Flint & Dorst, Inc., Milwaukee, has been elected NATESA president. He succeeds Irv Toner, Toner Radio & TV, East Aurora, N. Y.

Also elected at the NATESA annual convention was Earl Steffes of Kansas City, Mo., as secretary general, succeeding Dorst.

Harold Q. Eales, Eales Television and Radio Service, Oklahoma City, was re-elected treasurer, and Frank J. Moch was renamed executive director.

Regional officers elected are: eastern region, Richard Ambrose, Norfolk, Va., vice-president, Tom Hudson, Lynchburg, Va., secretary; east central region, Lyle Green, Oak Park, Ill., vice-president, Andy Archie, Nashville, secretary; western region, Alan B. Pickel, Las Cruces, N. M., vice-president, H. Hewson, Tigard, Oregon, secretary; west central, Bill Childs, St. Joseph, Mo., vice-president, C. Thole, St. Paul, secretary.

Moch, Piette Speak at NATESA Annual Convention

The underpricing of TV service and the prospect of forming dealer-service co-ops were two prime topics at the annual convention of the National Alliance of Television and Electronic Service Associations in Chicago, August 22-25.

Will Piette, owner of Factory TV Service, Milwaukee, told fellow service dealers that "TV service is underpriced. The fear of gypping the customer . . . is already a conditioned reflex," he said. This, Piette pointed out, hurts the dealer. When he feels compelled to keep service charges down, one of the first things he cuts is advertising. Because that brings in fewer customers, "we have the beginning of the end," according to Piette.

NATESA's executive director Frank J. Moch urged service dealers to enter cooperative chains, selling not only service, but home entertainment electronics products as well. He suggested that service dealers "forego the costly mania for phony independence."

"We must sublimate our now over-

powering hobby attitudes, and we must accept our chosen competitors among us as worthy of our trust and respect," he said.

Moch called his plan "super service." Each man in such a co-op will do only what he is best qualified to do, and collectively the needs of the market will be satisfied. Local members of service organizations, he said, should band together for these ends. He recommended co-op advertising, buying and promotion.

With such an approach, Moch pointed out, many costs will be lower because of volume buying, reduced travel and advertising costs.

Wisconsin Service Bill Defeated

Madison, Wis.—A bill to license Wisconsin TV technicians by examination has been postponed indefinitely by a 51-37 vote in the state assembly. The measure also proposed advertising and promotion standards.

Service Dealers Briefed On California Repair Bill

Los Angeles — California officials met with TV service dealers and technicians here to explain how the new state law, aimed at preventing radio-TV repair abuses, will be administered.

The much-argued bill became law

one way or the other,
you gain the most with
antenna specialists'

NEW "Match-Maker" Vertical/Horizontal Beam Antenna

MR 77 (27 Mc)

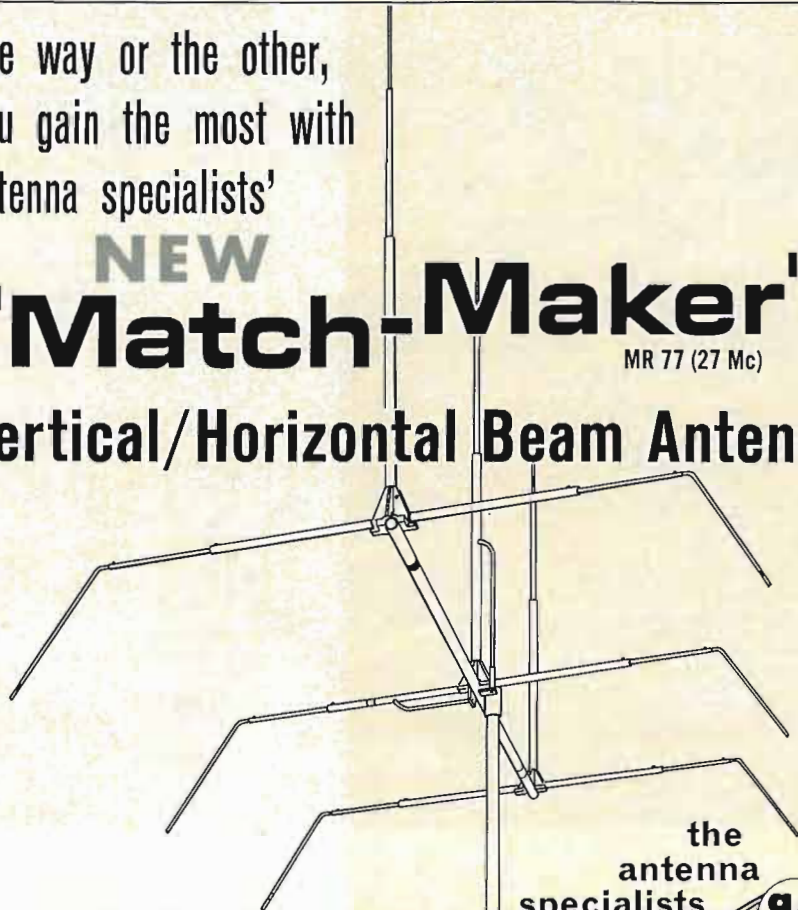

the
antenna
specialists
co.



Antenna Division,

12435 Euclid Ave., Cleveland 6, Ohio

Manufacturers of amateur, professional and CB base and mobile antennas. Custom design broadcast and professional installations.

Now you can instantly match up your base antenna to work mobile and vertical bases or horizontal base beams by simply switching from vertical to horizontal polarization through separate coax feeders. The dual-direction versatility of the "Match-Maker" will give you a powerful 7 db. vertical forward gain. Switch to the horizontal beam and you get a 6 db. forward gain. Either way, you get a 15 db. front to back ratio.

Everything about the "Match-Maker" is rugged. Sturdy, heat-treated aluminum boom and elements plus oversize clamps to hold elements firmly in place give it the structural strength to withstand 100 mph winds. Only 12½' high with a boom length of 10', it weighs an easy-to-handle 24 lbs. If you're interested in VSWR, it's 1.5:1 or less, either horizontally or vertically. 50 ohms, gamma matched. All components are color-coded for simple, fast, accurate assembly.



Holy smokes!
we almost forgot
the ZEUS!

The portable power generator with only one moving part. Alternator principle. 1000, 1250, 3000 watt models. Write for complete information.

WINEGARD COLORTRON

MODEL C-44 — \$64.95

World's most powerful TV antenna

Genuine Sunfast
GOLD ANODIZED Finish

Pat. Nos. U.S. 2,700,105; 2,955,289 • Canada 511,934

FIRST IN PERFORMANCE! FIRST IN CONSTRUCTION QUALITY! FIRST IN APPEARANCE!

Antennas come. Antennas go. But Winegard's *patented* Electro-Lens all channel yagi continues to be the standard of excellence. You can see its influence in the design of every high gain antenna made today.

Because Winegard COLORTRONS are recognized as the standard of excellence in TV antennas, you'll find them in every state of the union and 42 foreign countries. Four models satisfy every reception requirement.

WINEGARD COLORTRONS deliver today's finest color reception, give a new picture quality to black &

white. And COLORTRONS are rugged. High tensile aluminum tubing for rigidity and stability... insulators with triple moisture barrier... GOLD ANODIZED for complete corrosion-proofing. Winegard GOLD ANODIZING is the finest in the industry —not an inexpensive stain that fades out in a few weeks, but a bright GOLD that lasts for the life of the antenna.

Try a COLORTRON. Test it against any competitive make for performance, construction, appearance. If you're not 100% convinced, we'll take it back. Your satisfaction is guaranteed.

standard of excellence in the industry



FOR
COLOR
OR
BLACK
&
WHITE



COLORTRON TWIN NUVISTOR AMPLIFIER

Has highest input — up to 400,000 microvolts
Has highest output — up to 1,200,000 microvolts
Perfect partner to the COLORTRON ANTENNA!

Winegard's revolutionary new circuit, employing 2 nuvistors, enables the Colortron to overcome the service problems and limitations of other antenna amplifiers. Colortron will not oscillate, overload or cross modulate because it takes up to 400,000 microvolts of signal input. This is 10 times better than any transistor antenna amplifier made. Has highest out-

put, too—up to 1,200,000 microvolts.

Nothing on the amplifier is exposed to the elements—even the terminals are protected. Colortron comes complete with an all AC power supply with built-in 2 set coupler. Colortron model AP-220N 300 ohm input and output \$39.95 list. Model AP-275 300 ohm input 75 ohm output \$44.95 list.



WINEGARD RESEARCH, ENGINEERING AND MANUFACTURING ARE DEVOTED EXCLUSIVELY TO PRODUCTS FOR BETTER TV-FM RECEPTION



Colortron Antenna Model C-43
Gold Anodized — \$51.90



Colortron Antenna Model C-42
Gold Anodized — \$34.95

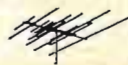

Colortron Antenna Model C-41
Gold Anodized — \$24.95



Stereotron Antenna Model SF-8
For long distance FM reception
\$23.65



2-Set Color Coupler
Model EC-230 —
transistorized 2-set coupler
boosts signals, couples
2 sets — \$17.95



Red Head Antenna amplifier
Model RD-300—most reliable
transistor TV-FM
antenna amplifier — \$29.95

PLUS 3 NEW TV-FM DISTRIBUTION AMPLIFIERS



Model A-215—15 DB gain
\$44.95



Model A-430—30 DB gain
\$84.95



Model A-845—45 DB gain
\$159.95

Nationally
advertised
month after
month



Winegard

ANTENNA SYSTEMS

3013-11 KIRKWOOD • BURLINGTON, IOWA

**"Messenger" CB Transceivers...rated
BEST in Nation by Electronic
Distributor Salesmen***



*New impartial survey by leading electronic magazine shows Johnson "Messenger" Transceivers rated "BEST"—BEST BY NEARLY 50% OVER SECOND CHOICE BRAND.

**4 feature-packed "Messengers" ... and
Selective Call System outperform everything!**

Compact, Hand-Held—100 milliwatt or 1½ watt "Personal Messengers". Rugged and reliable—11 transistors, 4 diodes! Twice the sensitivity and 40% more range than similar units with conventional circuitry—more output than similar units with same rated inputs!

Mobile or Base Stations—performance proved Viking "Messenger" and new "Messenger Two". Punches your signal across the miles—high efficiency design makes full use of maximum legal power. Excellent receiver sensitivity and selectivity. Automatic "squelch" control—5 or 10 channel crystal control—"Messenger Two" receiver also tunable on all channels!

Tone Alert—37 tone selective call system mutes speakers until one unit calls another—then automatically your stations receive audio note and indicator light flashes "On".



**NEW! 4-color
BROCHURE**—write
for your free copy!



Manufacturers of the world's most widely used personal communications transmitters.



E. F. JOHNSON CO

2502 10th Ave. S.W., Waseca, Minnesota

Please rush "Messenger" details to:

NAME _____

ADDRESS _____

CITY _____ STATE _____

**JOBS LOOK for
YOU in
ELECTRONICS**

**Learn FAST—EARN FAST with
MTI's Unique Exclusive
Training at Home.**

Whether it's a **BIG PAY JOB** you want or the chance to be **YOUR OWN BOSS**—your big opportunity today is **WAITING for YOU in ELECTRONICS!** MTI's unique **SELECT-A-SKILL** method quickly, easily qualifies you for the type of electronic work that's exactly right for **YOU**—**COMMUNICATIONS ELECTRONICS, INDUSTRIAL ELECTRONICS, or RADIO & TV SERVICING.** Previous experience proved unnecessary. Age no obstacle. Right at home you *learn by doing*, using your hands as well as your head—building electronic equipment, testing and experimenting with **SEVEN BIG MASTER ELECTRONIC KITS!** And you can earn while you learn!

Massey Technical Institute

Dept. 14-AS-02 Jacksonville 6, Florida

ACCREDITED Member, National Home Study Council

MAIL COUPON TODAY for **FREE BOOK** and MTI's unique **SELECT-A-SKILL Opportunity Finder** that can take the guesswork out of **YOUR FUTURE!**



SKILLS PAY BILLS

With millions unemployed—there is **NO PLACE** for men without special skills! Let **MTI** give you the training you **NEED** to insure your future!



MASSEY TECHNICAL INSTITUTE

Dept. 14-AS-02, Jacksonville 6, Florida

Name _____

Address _____

City _____ Zone _____ State _____

Please rush to me, without obligation your **FREE BOOK** "Pick Your New World of Opportunity in Electronics" PLUS your **SELECT-A-SKILL Opportunity Finder.**

in July. It requires all radio and TV repair firms to register with a state office, sets down certain advertising restrictions, makes a repair estimate binding on the repair firm (if one is made), and provides for itemized invoices.

Another new law, effective only in Los Angeles county, and also explained at the meeting, combats "setnapping"—holding a repaired set for "ransom" (charges in excess of an estimate), or attaching a lien to it.

Reaction to the law remains mixed and vociferous, even outside California. Howard Wolfson, Secretary of Associated Radio and TV Servicemen, Inc., Chicago, said in a letter to *Home Furnishings Daily* that the law is "another example of legislation designed to increase the burden of small service men, and pave the way for similar control in other fields."

Wolfson went on, "There isn't a repair job which can be estimated to the penny... service men will submit high estimates, thus losing business because of the opposition to those inflated guesses." He contended that technicians will be forced to install used parts to keep repair costs down and within the estimate.

New Virginia NATESA Chapter

Danville, Va.—A new technicians' association here known as **VEA-Danville** (Virginia Electronics Association) has become affiliated with **NATESA**. Jimmy Thomasson is president, T. R. Hughey vice-president and Lewis Adams, **NATESA** director.

NATESA reports that this is its eighth new affiliate in less than a year.

CSEA Elects Officers

Los Angeles—Emmett Mefford is the new president of the California State Electronics Association, a group of some 600 TV and electronic repairmen.

Mefford, formerly vice-president, fills the vacancy left by the death of Clair Lanam in July. Ralph Johonnot succeeds Mefford as vice-president. Johonnot was vice-president last year.

James Wakefield of Fresno is again **CSEA** executive secretary.

FTC Cites "Undisclosed" Used CRT Bulbs

The Federal Trade Commission acted recently to order tube manufacturers to stop misrepresenting CRT's using re-conditioned envelopes as "new."

One company, Westinghouse Electric Corp., offered in its defense extensive, uncontradicted proof that the used envelopes were processed just as scrupulously as new ones. But, said FTC examiner Joseph W. Kaufman, even if the used bulb were just as good as a new one, a customer would be entitled to a new one if he expected it.

He noted that, when tubes are sold without any disclosure to the contrary, they are assumed by the general public to be new.

Burglarproofing Notes

From *Electrical Merchandising Week*, these anti-burgling hints:

1. If you have an alarm system, be sure it is functioning and is not easily fooled. Write to the manufacturer for information on newer systems.
2. Check with local police to see if the "scheduled check" is still used in your town. If so, try to persuade them (with the help of other businessmen in your town) of the "surprise" advantages of the unscheduled check now used in many towns.
3. Install security bars and frames *inside* the windows. Anything outside is fair game for burglars.
4. If your building has a skylight, cover it (from inside) with a steel security frame or heavy wire mesh.
5. Find out from a locksmith the advantages of a "dead-lock" mechanism for your doors.
6. Put night lights around the building and on the roof. Lights inside, if your building has windows on the street, will make it harder for a burglar to work unnoticed. **END**

new Products



STEREO RECEIVER, Award TA7000X. FM stereo and AM tuners, dual preamplifiers, 70-watt stereo amplifier on single chassis. Stereo logic circuit switches FM tuner to stereo when station begins to broadcast stereo. FM tuner frequency response 10-35,000 cycles ± 1 db. Tuner has stereo

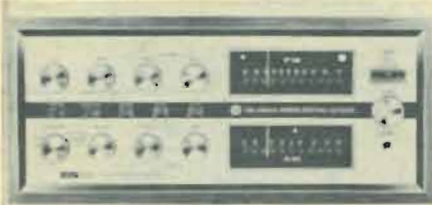

indicator light, stereo headphone reception, afc, tuning meter. FM multiplex section flat 15-15,000 cycles ± 1 db, less than 1% distortion. 30 db separation across entire audio band. Power amplifier section drives any speaker system; reproduces frequencies 12-70,000 cycles ± 1 db at 1 watt.—**Harman-Kardon, Inc.,** Ames Ct., Plainview, N.Y.

SPEAKER SYSTEM, model E-V Six. Compression vhf driver, diffraction horn. Four-way



electrical crossover, crossover frequencies at 250, 800, 3,500 cycles. 18-inch low-frequency driver.—**Electro-Voice, Inc.,** Buchanan, Mich.

FM STEREO TUNER, model S-3000 V. D'Arsonval zero-center meter shows precise center between band limits, tunes Class-A stations without interference. Sensitivity 1.8 μ v for -30 db noise



and distortion. 2.4 db capture effect. Stereo indicator light, 8-inch professionally calibrated expanded dial scale.—**Sherwood Electronic Labs, Inc.,** 4300 N. California Ave., Chicago 18, Ill.

STEREO TAPE RECORDER, model 330. Sound-on-sound recording; multiple sound-on-



sound with channel transfer switch; multiple stereo headset outputs; input and outputs for custom installation without modification; two VU meters; internal monitoring; output for third head

monitoring. Transistorized preamp booster to allow direct monitoring of recorded tape signal during recording, available as accessory. Recording speeds 7½, 3¾ ips; 15 ips accessory kit available. Four monaural tracks record 8 hours at 3¾ ips. Wow and flutter 0.20% at 7½ ips. Two stereo speakers, 2 high-impedance mike inputs, 2 high-impedance, high-level phono-radio inputs; 2 high-impedance preamp outputs, 2 external-speaker jacks.—**Roberts Electronics, Inc.,** 5978 Bowcroft St., Los Angeles 16, Calif.

STEREO COMPACT, model 88. Hyperbolic contour heads (erase, record, playback) of laminated, metal face construction, require no pressure pads. Silicon planar transistors in critical low-noise stages. Independent playback preamp cir-



cuitry. Comparison switch for monitoring off tape or program source. Delivers 2-volt output to music system. Record-playback response 30-18,000 cycles at 7.5 ips. Sound-on-sound recording for multiple recording effects, built-in filter for FM multiplex recording. Separate record-playback volume controls, record indicator light, professional VU meters, digital counter, head shift control, 2-speed selector switch, automatic tape shutoff. Available models RMQ, quarter-track record, play; ERQ, half-track record, quarter-track play.—**Viking of Minneapolis, Inc.,** 9600 Aldrich Ave. S., Minneapolis, Minn. 55420.

TRANSISTORIZED PA AMPLIFIERS, models 3000, 6000. Tunable anti-feedback. Three mike channels for separate or simultaneous use, for high- and low-impedance mikes. Two inputs allow use of unit with tuner, tape recorder, auxiliary equipment. Controls for master gain, individual mike gain, auxiliary fader-type gain, tunable anti-feedback, bass and treble, rumble filter, scratch filter. Power output 30 watts rms, 42 watts peak;



60 watts rms, 84 watts peak. Response 20-20,000 cycles ± 2 db. Harmonic distortion less than 2%. Output impedances 4, 8, 16, 500 ohms; 25, 50, 70.7 volts. 117 vac, 50-60 cycles. Automatic overload protection.—**B & K Mfg. Co., Div. Dynascan Corp.,** 1801 W. Belle Plaine Ave., Chicago 13, Ill.

ALL-TRANSISTOR STEREO AMPLIFIER, model LA-200. Complete stereo preamp and dual-channel stereo amplifier. No output or driver



transformers. Music power 44 watts. Frequency response ± 1 db, 20-20,000 cycles. Harmonic distortion 1%. Hum and noise: Tuner, -74 db; magnetic phono, -54 db. Tone controls ± 10 db. Inputs: Tape head, magnetic phono, ceramic phono, tuner. Auxiliary outputs: Tape recorder, 4-16 ohms speaker impedance.—**Lafayette Radio Electronics Corp.,** 111 Jericho Turnpike, Syosset, N. Y.

36-WATT STEREO AMPLIFIER, model 2036, Classic Series. 36 watts IHF music, 28 watts continuous power, total. IM distortion (each channel) 2% at 14 watts. Harmonic distortion (each channel) 0.6% at 10 watts. IHF power bandwidth at rated continuous power, 1% harmonic distortion: 30 cycles-20 kc. Frequency response ± 1 db 15 cycles-40 kc. Speaker output 8-16 ohms.

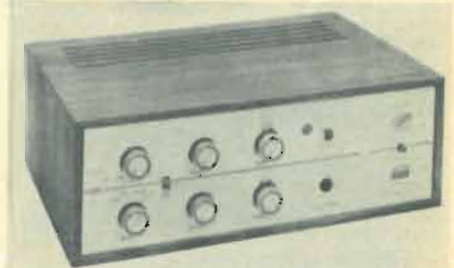

Inputs: magnetic phono, adapted ceramic phono, tuner, tape auxiliary. Sensitivity 2.3 mv phono, 250 mv others. Noise 65 db down on phono, 80 db down on others.—**EICO Electronic Instrument Co., Inc.,** 33-00 Northern Blvd., Long Island City 1, N. Y.

STEREORECORDERS, Model 777 S-4 records 4-track stereo, 4-track monophonic, plays back 2- and 4-track stereo and mono. Model 777 S-2 records 2-track stereo, 2-track mono; plays back



2- and 4-track stereo, plus mono. Both Sony models all-transistorized, have 3 separate heads, 3 motors, all-solenoid activated mechanism, work vertically or horizontally. Speeds 7½, 3¾ ips. Stereo mixing of mike and line, sound-on-sound recording, remote control for all models, monitoring of source or tape.—**Superscope Inc.,** 8150 Vineland Ave., Sun Valley, Calif.

PORTABLE TAPE RECORDER, Sony model 801-A. Shown in September, 1963 issue, incorrectly stated as available from Sony Corp. Unit distributed solely by **Superscope Inc.,** 8150 Vineland Ave., Sun Valley, Calif.

PERSONAL HEADSET RECEIVERS, Model 100. Moving-coil drivers with plastic diaphragms in acoustic chambers for direct coupling between



NEW SAMS BOOKS

SPECIAL PREPUBLICATION PRICE!
NEWLY REVISED EDITION

Modern Dictionary of Electronics

SAVE \$1.00 Completely new, up-to-date edition of this popular reference work now includes more than 12,500 terms and words used in all phases of electronics. Clearly defines every term; encompasses many new areas of electronics. Over 375 illustrations. Handsomely bound in a durable hard cover with rich gold stamping. 448 pages; 6 x 9". Order DIC-2. *Special Prepublication Price Through November 30, only* \$5.95
(Price thereafter will be \$6.95)

Test Equipment Maintenance Handbook

by Robert G. Middleton. A practical new guide by "the master" of test equipment. Describes the general care and maintenance of test instruments, specific maintenance checks, equipment modifications, and trouble diagnosis. Arranged by types of instruments, with step-by-step illustrated "how to" procedures for each. 160 pages; 5½ x 8½". Order CTE-1, only \$2.95

TV Service Training Manual

by Edward F. Rice. An outstanding practical course in TV servicing; concentrates on actual circuit troubleshooting from tuner to picture tube. Utilizes special "programmed charts" which lead you through an "if, and, or" process to guide you quickly to the faulty stage. An excellent student training manual and practicing technician's handbook. 224 pages; 5½ x 8½". Order TSR-1, only \$3.95

Electrical Control Circuits and Wiring

by S. Garstang & J. D. Fuchs. Entirely new and practical approach to electrical control circuit wiring, with particular attention to NEMA standards and practices. Starts with simple power circuits and expands into the more complicated plant and factory wiring used in industry today. 256 pages; 5½ x 8½". Order ECW-1, only \$4.95

Transistor Ignition Systems Handbook

by Brice Ward. Transistor ignition systems are revolutionizing the auto industry. This new book clearly explains the principles of these highly efficient systems—how they work, how to install them, how to tune them up. Describes typical systems now in use; provides complete data on installation. 128 pages; 5½ x 8½". Order IGS-1, only \$2.50

Practical Projects in Radio Electronics

by Sam Marshall & Irving Tepper. Through a series of easy-to-construct projects, this book provides the beginner with a sound background for understanding radio electronics theory and practice. Includes step-by-step experiments resulting in construction of a complete superhet radio receiver. Develops full, practical knowledge of power supplies, amplifiers, and other circuit fundamentals. 320 pages; 5½ x 8½". Order RSM-1, only \$4.95

Business Radio Handbook

by Leo G. Sands. Completely covers UHF mobile communications setups in the new Business Radio class—an invaluable guide for owners, operators and technicians. Fully describes all basic systems, including mobile-to-mobile, base-to-mobile, simplex, duplex, remote and other control systems. Includes complete information on channels and licensing requirements for every type of service. 160 pages; 5½ x 8½". Order BR5-1, only \$3.95

Electronic Engineers & Technicians Reference Hdbk.

A one-source reference on electronic theory and applications. Provides complete data on network solutions, circuit design data, Delta-to-Wye and Wye-to-Delta transformations, maximum power transfer, frequency selection and rejection in resonant circuits, and complete examples of typical problems and solutions using Maxwell's loop equations, Thevenin's Theorem, Norton's Theorem, Kirchhoff's Laws, etc. Includes tables of symbols, abbreviations, mathematical constants, solenoid designs, etc. 192 pages; 5½ x 8½"; hardbound. \$4.95
Order ERH-1, only.....

HOWARD W. SAMS & CO., INC.

Order from your Sams Distributor today, or mail to Howard W. Sams & Co., Inc., Dept. L-23, 4300 W. 62nd Street, Indianapolis 6, Ind.

Send me the following books:

DIC-2 TSR-1 IGS-1 BRS-1
 CTE-1 ECW-1 RSM-1 ERH-1

\$ _____ enclosed. Send FREE Booklist

Name _____

Address _____

City _____ Zone _____ State _____

My Distributor is _____

IN CANADA: A. C. Simmonds & Sons, Ltd., Toronto 7

reproduced sound and ear. Polyvinyl chloride ear seals. Frequency range 10-16,000 cycles. Response ±3 db, 20-10,000 cycles. Distortion 0.2% at 100 phon level over useful range. Sensitivity (per phone) 200 µbar/volt at 1 kc. Max. power input 1 watt per phone. Nominal impedance 8 ohms.—David Clark, Inc., 250 Park Ave., Worcester, Mass.

PA SYSTEM, *Diplomat*. Powered by 10 flash-light batteries. Attache case contains all-transistor 25-watt amplifier, 6 x 9 speaker, dynamic omnidirectional mike with lavalier cord and 10 feet of



cable, 40 feet additional cable to permit separation of loudspeaker and amplifier. Two inputs, two outputs for use with additional loudspeakers.—Ampli-Vox Div., Perma-Power Co., 5740 N. Tripp Ave., Chicago 46, Ill.

PRE-RECORDED TEST TAPE, *Series 111*. Cellulose-acetate base, plastic magnetic tape. Gives step-by-step instructions on checking tape recorders for volume control, sound level, frequency



response, fidelity and balance, timing, tape quality, splicing and editing, etc. Available in reel diameters 3-14 inches.—Burgess Battery Co., Magnetic Tape Div., Freeport, Ill.

HANDI-TESTER, *model 108*. D'Arsonval meter movement. Rated accuracy of 800-microamp movement 2%. Ac or dc ranges: volts 0-15-150-300.



Amps 0-15. Watts 0-1,500. Resistance 0-2,000 ohms; neon leakage test 0-5 megohms. Wt. 1¼ lbs., complete with test leads, instruction manual. Available kit or wired.—Electronic Measurements Corp., 625 Broadway, New York 12, N. Y.

MAGNETIC TAPE VIEWER, *No. 600*. Makes visible the data recorded on tape. May be



used to check recorder head alignment, track placement, pulse definition, interblock spacing, dropout areas.—3M Co., 2501 Hudson Rd., St. Paul, 19, Minn.

INTEGRATED CIRCUIT TESTER, *Model 659A*. Tests all leading types semiconductor integrated circuits. Makes 36 tests on devices with up



to 14 terminals. Plug-in circuit boards for bias, limits, timing and sorting. Test times vary 30 milliseconds to 5 seconds. Makes 2-point connections to each device terminal. Program boards available from manufacturer, or may be designed and constructed with instructions furnished.—Texas Instruments, Inc., 3609 Buffalo Speedway, Houston, Tex.

NARROW BAND ANALYZER, *model 2107*. For analysis and linear measurements. Audio-frequency analyzer, constant percentage-bandwidth

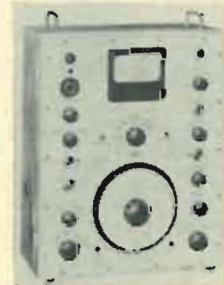

type, for analysis and linear measurements. Six selectable filter bandwidths, 6-29% of center frequency, continuously tunable 20-20,000 cycles. Measures rms, absolute average, instantaneous peak values of input signal. Rms readout gives data for all types of signals, including sinusoidal, periodic, random. Facilities for wide choice of input transducers or signals.—B & K Instruments, 3044 W. 106 St., Cleveland 11, Ohio.

ALL-TRANSISTOR UHF CONVERTER, *model VUC-4W*. For use with manufacturer's

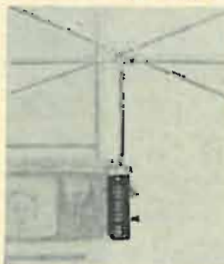

Micro-TV model 5-303W or 8-inch model 8-301W. Available with carrying case and antenna. 13 oz. Power automatically supplied from TV set.—Sony Corp. of America, 580 5th Ave., New York, N. Y.

TWO-IN-ONE CB BEAM ANTENNA, *model MR-77 Match-Maker*. Works vertically and horizontally. Vertical forward gain 7 db, horizontal



forward gain 6 db. Front-to-back ratio 15 db. Separate coaxial feeders for vertical and horizontal polarization. Boom and elements of heat-treated aluminum. Oversize clamps hold elements in place to withstand 100 mph winds. 12½ feet high, boom length 10 feet, 24 lbs. Vswr 1.5:1, 50 ohms gamma matched.—Antenna Specialists Co., 12435 Euclid Ave., Cleveland, Ohio.

CB ANTENNAS. Ground plane *model CBGP-1* (illus) for base station installations. 360° pattern, 1-inch diameter radiating element, double U-bolt mounting device. *Model CBY3*, 3-element antenna, vertical or horizontal mounting. Up to 8 db gain. ½-inch elements, 1-inch boom; rein-

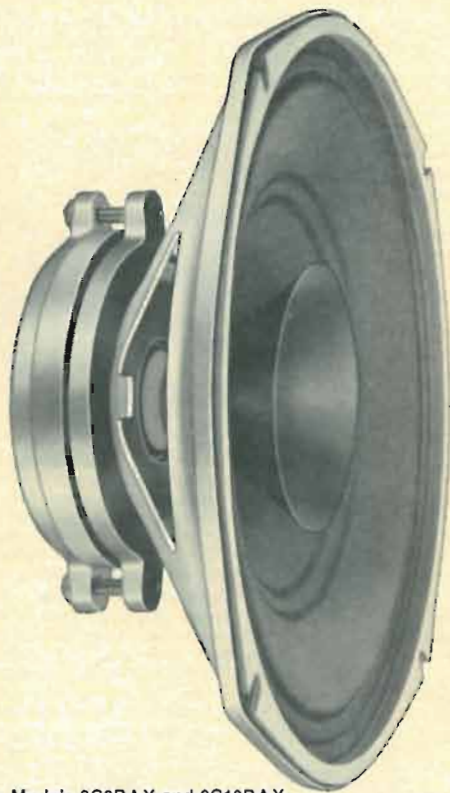

A Models 8C6PAX and 8C10PAX.
Model 12C10PAX similar, but
with round basket.

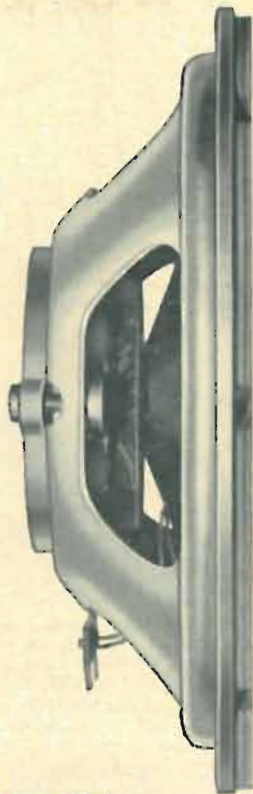

B Model 8C6PAS.
Very shallow construction.

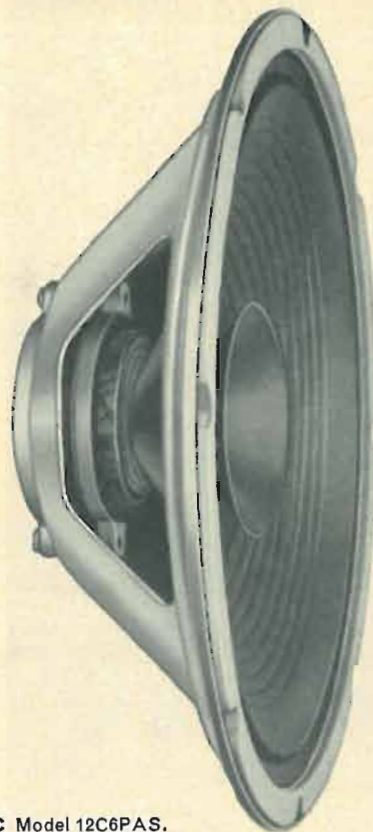

C Model 12C6PAS.
Shallow 12" extended range
speaker with dual cone.

For your background music installations

5 new Quam speakers

Over the hubbub of other sounds, background music has to be audible without being obtrusive. Ordinary public address speakers, designed for capturing the primary attention of the audience, are *not* the answer. These new Quam Speakers—especially designed to handle background music—are.

Quam offers you five background music speakers,

three eight-inch models and two twelve-inch. All have ceramic magnets; four of these new units are extended range units with dual cones; two of the new speakers offer very shallow construction. (Complete specifications are given in the new Quam Catalog 63 . . . now available on request.) They meet the traditional Quam standards of utmost quality and performance satisfaction.

Remember Quam—for forty years the Quality Line for all your speaker needs.

QUAM

**QUAM-
NICHOLS
COMPANY**

234 E. MARQUETTE ROAD
CHICAGO 37, ILLINOIS



Increase your earning power
 equip yourself
 to handle
**Nuclear Applications
 of Electronics**

CREI can help you
 move into this new field

Industrial use of nuclear energy is creating new careers, *right in your own field of electronics*. Men are needed to design, build, operate and maintain electronic instrumentation for practical application of nuclear energy. You can earn more money—with your present employer or with another company—if you supplement your electronics experience with specialized knowledge of the nuclear field.

OUR FREE BOOK tells you how you can do it—in your spare time—through CREI's unique Home Study Program in Nuclear Engineering Technology. For your copy, mail coupon or write:

CREI, Dept. 1411-AI
 3224 Sixteenth St., N.W.
 Washington 10, D. C.

FREE BOOK



CREI ATOMICS
 A Division of the Capitol Radio
 Engineering Institute, Dept.
 1411-AI, 3224 Sixteenth St.,
 N. W., Washington 10, D. C.

Please send me FREE BOOK describing the CREI Home Study Program in Nuclear Engineering Technology. I have a technical background and a high school education.

Name _____ Age _____
 Address _____
 City _____ Zone _____ State _____



forced U-bolt assembly accepts masts to 1½ inch.
 —Antennex Co., Div. Clear Beam Antenna Corp.,
 PO Box 471, Canoga Park, Calif.

COLOR COUPLER, model BC-230. Transistorized, two-set TV coupler designed to overcome splitter loss. Permits operation of two TV sets or TV and FM set simultaneously from single an-



tenna and down-lead, without loss of signal. Minimum gain +7 db; isolation between coupler outputs 15 db. For both color and black-and-white.—Winegard Co., Burlington, Iowa.

COUPLER ATTACHMENT, Miracle Mount. Mast-mounted unit for multi-set TV couplers eliminates hazards of rooftop installation. Snap-on

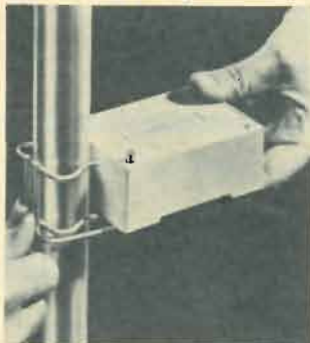

unit withstands strong winds.—Blonder-Tongue
 Labs, Inc., 9 Alling St., Newark 2, N.J.

AMPLIFIED COUPLER, model TA-66. Indoor Super-Powermate. Two-transistor unit amplifies and feeds TV signals to up to 4 TV sets from single antenna. Gain: low band, 7.5 db, output



180,000 μ v at each of 4 output terminals; high band, 5.6 db, output 100,000 μ v at each outlet. Noise figures 4.2 db low band, 8.3 db high band. Isolated power supply.—Distributor Sales Div., Jerrold Electronics Corp., 15th & Lehigh Ave., Philadelphia 32, Pa.

FM RECEIVER, Duo-Band. For monitoring business, police, fire, taxi and other mobile phone



frequencies. Receives 30–50 mc and 152–174 mc bands. Dual-conversion superhet circuit, squelch, tuned rf stage, crystal-controlled second oscillator. Temperature compensated.—Ufica Communications Corp., 2917 W. Irving Park Rd., Chicago 25, Ill.

CB TRANSCEIVER, Poly-Comm N. 8 CB channels, Nuvistor front end, ultrasensitive noise limiter and squelch. Ultra high-gain rf stage dual conversion receiver. Operates to 10 miles mobile-to-mobile, to 15 miles base-to-mobile. Selectivity:



6 db bandwidth, 8 kc \pm 2 kc; 60 db bandwidth 20 kc \pm 5 kc. Audio output 4.5 watts into 4-inch PM weatherproof speaker; distortion less than 15%, 250–3,000 cycles at 1-watt output. Hum and noise 40 db down from 1 watt output. Frequency response \pm 6 db, 250–3,000 cycles.—Polytronics Labs, Inc., 88 Clinton Rd., West Caldwell, N. J.

TWO-WAY RADIOTELEPHONE, Escort. Operates on CB service channels. Class D license required. Transistorized dual power supply 12 vdc, 115 vac. Heavy-duty, rust- and corrosion-proof aluminum chassis and cabinet. 8 channels plus accessory crystal socket for use on any channel. 8 illuminated channel markers move with channel



selector switch and indicate operating channel. Squelch circuit, pre-set noise limiter, universal mounting bracket.—Pearce-Simpson, Inc., 2295 N.W. 14 St., Miami 35, Fla.

PHOTOCONDUCTOR KIT. Includes 3 photoconductors, ac-dc relay, resistor, mounting bracket. 52-page circuits booklet explains in detail



how to assemble counting devices, photoflash slaves, model railroad crossing guards, game room target shoots, many other devices.—Sylvania Electric Products, Inc., 730 3rd Ave., New York 17.

SSB RECEIVER KIT, model SB-300. Complete coverage of 80–10 meter bands. Linear tuning with 1-kc dial calibrations. 2.1-kc crystal lattice filter; stability 100 cycles after warm-up; pre-built linear master oscillator, wiring harness, circuit board; provision for vhf converters, single



SPECIAL INTRODUCTORY OFFER

SELECT ANY
3 ELECTRONICS BOOKS \$2

CERTIFIED VALUE UP TO \$17.45

with membership in the Gernsback Technician's Book Club

NO-RISK GUARANTEE — if not satisfied return the books and cancel membership.

WHY THIS SPECTACULAR OFFER?

Gernsback Library is making this offer to persuade more members to join the helpful Technicians Book Club. As striking as this offer is—it is only an introduction to the many advantages club members receive. The club gives you the chance to acquire at bargain prices—books by top technical writers on how to master fundamentals, learn new techniques that will help you get and stay ahead in electronics.

Here's the technical book buy of the year—not a collection of old or outdated volumes—but new books taken from the top of the Gernsback list of best sellers. Priced up to \$5.95 each—total value \$17.45.

WHAT THE CLUB OFFERS YOU

- Selection of the best modern electronics books by first-rank authors.

- Tremendous savings on each book—Club prices range from \$3.25 up for books regularly priced at \$4.60 and more.
- Opportunity to buy books not always available in your community.
- Attractive volumes—carefully printed—handsomely cloth bound.
- Budget-coddling payments. You agree to accept as few as four additional books a year. You pay for the books only after you receive them—and then only at the special club price—discounts up to 27%.

Highlights from books you will be able to select in coming months

- What you need to know about modern TV.
- All about transistors.
- Math for the electronic technician.
- Getting more out of the oscilloscope.

HOW TO JOIN

- Mail the coupon below and start membership with any 3 of the books listed below. SEND NO MONEY. We'll bill you \$2—plus a few cents handling and mailing. If you're not satisfied with the books send them back and membership is cancelled.
- You will automatically receive a copy of each club selection as soon as it is announced. You examine the book in your home and pay for it only if you decide to keep it. If you like it, send your remittance. If not, return the book. Keep only the books you want—pay only for those you keep.
- You agree to accept only 4 additional books in the next 12 months. You may cancel anytime after that.
- Mail in the coupon below to Technicians Book Club, Dept. 113-B, 154 West 14 St., New York 11, N.Y. SEND NO MONEY NOW (unless you wish).

Choose the 3 books you want below for only \$2.00

SERVICING RECORD CHANGERS, By Harry Mileaf—Makes servicing changers easy. Complete text plus line drawings explain intricate mechanisms clearly. Reg. price \$4.60.

BASIC RADIO COURSE (revised ed.), By John T. Frye—The original sold out through eight printings! Everything—Ohm's law, capacitance, tubes, transistors and how they work in a receiver—practical servicing techniques—discussed in a lighthearted style that makes what's being taught stick. Reg. price \$5.75.

UNDERSTANDING HI-FI CIRCUITS, By Norman H. Crowhurst—Analyzes the hi-fi system so you can move into audio and hi-fi servicing. Covers inverter, driver and output stages, feedback, damping, matching, crossovers—and much more. Reg. price \$5.00.

PRACTICAL AUTO RADIO SERVICE, By Jack Greenfield—Covers transistor, hybrid FM and AM models. Compares auto with home radio servicing. Covers removal, installation, troubleshooting, power supplies, interference, suppression, tuner theory, etc. Reg. price \$4.60.

INDUSTRIAL ELECTRONICS MADE EASY, By Tom Jaski—Operation and maintenance of industrial equipment, dielectric, induction and microwave heating processes and applications. Control systems actuated by photo-electric, infrared, pressure, and other transducers. Reg. price \$5.95.

TV—IT'S A CINCH! By E. Aisberg—A delightful explanation of TV principles written lightheartedly in dramatic dialogue. Practical approach to TV theory. Reg. price \$4.60.

HIGH-FIDELITY CIRCUIT DESIGN, by Norman H. Crowhurst and George Fletcher Cooper—Plan and build amplifiers—on paper—then construct the amplifier best suited to your needs. Reg. price \$5.95.

BASIC TV COURSE, By George Kravitz—A book on TV as it is today. Even transistorized portables are discussed. A thorough practical discussion of circuit operation, sync methods, sweep systems, tuners, amplifiers, variations in power supplies. Presentation of technical detail in easy-to-follow writing style. Reg. price \$5.75.

TV AND RADIO TUBE TROUBLES, By Sol Heller—Trace any tube trouble to the source in minutes with this new sure-fire symptom analysis technique. Save servicing time. Reg. price \$4.60.

HOW TO GET THE MOST OUT OF YOUR VOM, By Tom Jaski—Get more mileage out of this versatile instrument. How to choose, build, work with and extend the use of the VOM. Reg. price \$4.60.

ONLY 3 BOOKS TO A MEMBER PLEASE

TECHNICIAN'S BOOK CLUB

Gernsback Library Dept. 113-B

154 West 14th Street, New York 11, N.Y.

Enroll me as a member of the G/L Technician's Book Club. Start my membership with the 3 books I've checked for only \$2.00 (plus a few cents postage). Thereafter send a new selection every two months on the "no risk-approval" plan. I understand that my only obligation is to purchase just 4 additional books within the next 12 months, and that I may cancel anytime thereafter. I also understand that I may cancel immediately, simply by returning these first 3 books within 10 days. (This offer good in U.S.A. and Canada only.)

NAME _____

ADDRESS _____

CITY _____ ZONE _____ STATE _____



BENJAMIN MIRACORD

shown with new

INTEGRATED COVER/BASE Model CB-1

Attractive as it is protective, the new Integrated Cover/Base keeps your Miracord dust-free at all times—at rest and during play. Consists of clear plexiglass cover hinged to handsome, oiled walnut base. Cover need not be removed or kept open while in use, even when playing records automatically with long spindle. Yet, slip-hinge design permits removal of cover, where desired. Measures 18 $\frac{3}{8}$ " wide x 14 $\frac{3}{4}$ " deep x 9" high with cover closed. Complete Cover/Base price is \$19.95. Miracord prices, less base and cartridge: Model 10 (4-pole induction), \$89.50; Model 10H (hysteresis), \$99.50. See them at your hi-fi dealer. For literature, write to:

BENJAMIN ELECTRONIC SOUND CORP. 80 SWALM STREET WESTBURY, N. Y.
U.S. distributor for Miracord turntables, Elac cartridges and Truvox tape recorders.

switch control of power and antenna leads; accessory crystal filters for CW and AM operation; audio feedback.—**Heath Co.**, Benton Harbor, Mich.

REPLACEMENT FLYBACKS for use with Zenith TV sets. No's HO-362-367 (6 units) replace 20 part numbers for applications in 77 chassis and



624 models.—**Stancor Electronics, Inc.**, 3501 W. Addison St., Chicago, Ill. 60618.

MONOLITHIC CEROD CAPACITORS. Cylindrical ceramics with layer-built capacitor elements, fully molded in thermosetting resin. Types 262C and 263C comparable to $\frac{1}{4}$ - and $\frac{1}{2}$ -watt composition resistors, respectively. Type 262C, capacitances to .01 μ f available to capacitance



tolerances $\pm 10\%$; type 263C, upper capacitance range to .033 μ f, capacitance tolerance $\pm 10\%$. Capacitors rated to 100 vdc, temperatures to 85°C, may be operated to 125°C at 50 volts.—**Sprague Electric Co.**, Marshall St., North Adams, Mass.

MICA CAPACITOR PACKAGES, Type RE. Resin-encapsulated custom single- or multiple-silvered mica capacitors, interconnected in series, parallel or series-parallel. Designed in many combinations of ratings, operating characteristics, sizes, form factors, terminals, mountings. Operating tem-

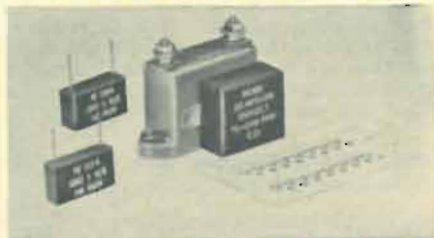

perature range -55°C to $+150^{\circ}\text{C}$.—**Cornell-Dubilier Electronics Div., Federal Pacific Electric Co.**, 50 Paris St., Newark 1, N. J.

ALLEN HEX SCREWDRIVERS. Fixed-handled drivers available in 11 sizes, .050- $\frac{1}{4}$ in. 4-inch

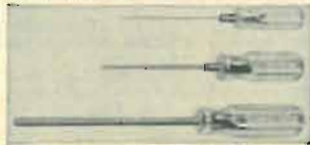

blades on smaller sizes, 6-inch blades on larger. Detachable Allen hex blades in 8 sizes, $\frac{1}{16}$ - $\frac{3}{16}$ inch. Singly or in plastic pouch.—**Xcellite Inc.**, Orchard Park, N. Y.

ELECTRONIC WIRE MARKERS, B-400. Up

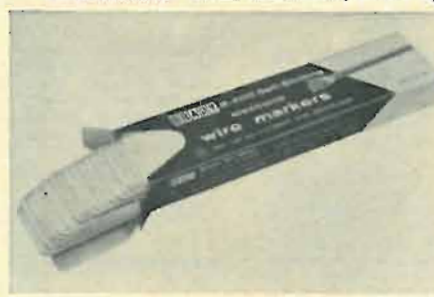

All specifications from manufacturers' data

to 3,750 individual markers in $\frac{3}{4}$ x 2 x 9-inch Combination Pacs. Adhere to any wire or insulation including nylon, plastic, silicone, rubber, glass or nylon braid, Teflon. Withstand 30 days immersion in No. 10 oil at 65°C, resist temperature to 150°C indefinitely, to 200°C with slight change in background color. 3.5 mills thick.—**W. H. Brady Co.**, Dept. 403, 726 W. Glendale Ave., Milwaukee 9, Wis.

SOLDERING GUN ATTACHMENT. Cleans printed circuit terminals. Attaches to soldering gun in less than 5 minutes. Hollow, tubular tip of



gun heats terminal, suction bulb sucks solder into stainless steel tube.—**Oneida Electronic Mfg. Co.**, Meadville, Pa.

WIRE STRIPPER with assortment of solder-

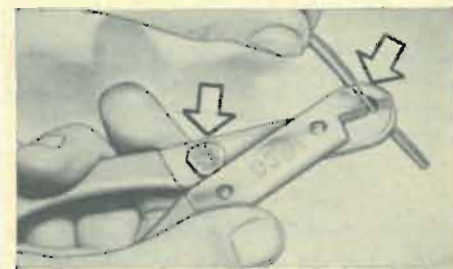

less terminals. Calibrated dial allows instant adjustment of blades to 8 different settings for cutting and stripping 24- to 12-gauge wire. Plastic-covered handles spring-loaded to stay open when not in use.—**Vaco Products Co.**, 317 E. Ontario St., Chicago 11, Ill.

THERMAL WIRE STRIPPER, No. 80P. Tips mounted on small tweezer-type handle. Attachment allows hand-held or bench-mounted operation.

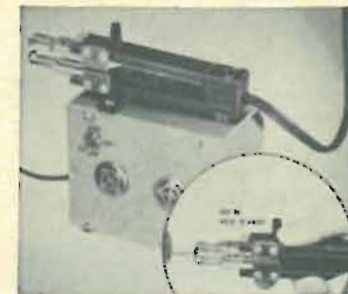

Three-position heat switch on control box provides heat for high or low-temperature insulations.—**Hunter Tools**, 9851 Alburto Ave., Santa Fe Springs, Calif.

ANTI-WICKING TWEEZERS, N type. Prevent solder on stranded cable from creeping up under insulation. Made of beryllium copper to precise wire sizes. Nine models fit wire gages



16-32. Short tip hole.—**Hexacon Electric Co.**, 186 W. Clay Ave., Roselle Park, N. J.

SILICONIZED SPRAY PAINTS. Resistant to heat, weathering, corrosive atmospheres. In 15-oz. spray cans; black, white, aluminum, grey, gold.—**Injectoral Co.**, 6 Bay 50th St., Brooklyn 14, N. Y. END

See the new
**RADIO-ELECTRONICS
MARKET CENTER**
on Page 113

WHY bother with makeshift twist-prong capacitor replacements?

When you substitute capacitor sizes and ratings, you leave yourself wide open for criticism of your work . . . you risk your reputation . . . you stand to lose customers. It just doesn't pay to use makeshifts when it's so easy to get the exact replacement from your Sprague distributor!

Get the right SIZE,
right RATING every time
with improved



SPRAGUE TWIST-LOK[®] CAPACITORS!

Over 1,690 different capacitors to choose from!

The industry's most complete selection of twist-prong capacitors, bar none. Greater reliability, too. Exclusive Sprague cover design provides a leak-proof seal which permits capacitors to withstand higher ripple currents.

GET YOUR COPY of Sprague's comprehensive Electrolytic Capacitor Replacement Manual K-106 from your Sprague Distributor, or write Sprague Products Co., 81 Marshall St., North Adams, Massachusetts.



WORLD'S LARGEST MANUFACTURER OF CAPACITORS

To kit builders who go



through THICK and THIN



to get the best...



SEND FOR THE THIN!

You don't judge a book by its cover. Nor by the number of pages. If you're looking for weight, don't bother with the Conar catalog. But if you're looking for quality electronic kits backed by a *no-loopholes guarantee*, you'll want our careful selection of do-it-yourself and assembled units. There's something for everyone: TV set kits to transistor radios, VTVM's to scopes, tube testers to tools. For years of pleasurable performance, for pride in assembly, mail coupon. Discover why Conar, a division of the National Radio Institute, is the fastest growing entry in the kit and equipment business.

CONAR

MAIL NOW!

MC3C

CONAR

3939 Wisconsin Ave., Washington 16, D.C.

Please send me your catalog.

Name _____

Address _____

City _____ Zone _____ State _____

booklets
New Literature
catalogs charts

CB RADIOS shown in 4-page leaflet. Photos and specs on Commaire models ED-276 and PT-27 (CB radio with AM receiver).—Vocaline Co. of America, Inc., 100 Coulter St., Old Saybrook, Conn.

SHORT GLOSSARY OF EMI TERMS, 12-page booklet, lists common EMI (Electro-Magnetic Interference) terms.—Ace Engineering & Machine Co., Inc., 60 Tomlinson Rd., Huntingdon Valley, Pa.

MICROLIMIT OPTICAL DIAMETER GAGE described in 4-page Bulletin No. 14-203-B. Photos, operation data, full specs.—Weston Instruments & Electronics Div., Daystrom, Inc., 614 Frelinghuysen Ave., Newark 14, N. J.

PAPER-OIL CAPACITORS described in 24-page Bulletin 2423. Includes manufacturer's types 40-71 and MIL-C-62 equivalents. Engineering data shown in graphs and charts.—Sangamo Electric Co., Springfield, Ill.

HI-FI CATALOG. 16-page booklet describes Thorens and Ortofon turntables, tone arms and cartridges, plus Cecil E. Watts cleaning accessories. Photos, full specs.—Elpa Marketing Industries, Inc., New Hyde Park, N. Y.

CIRCUIT RESISTOR ELEMENTS, shown in Barretter Product Bulletin. 2-page sheet gives description, application data, filament resistance/current chart. Line drawings show configurations.—Tung-Sol Electric Inc., 1 Summer Ave., Newark 4, N. J.

TAPE TIMING CHART. Gives playing time of tapes, footages for reels 2 1/4 to 14 inches, speeds 1 1/2 to 15 ips for full, dual and quarter-track recorders. Includes odd lengths, European-type reel lengths.—Saxitone Tape Sales, 1776 Columbia Rd., N.W., Washington, D.C.

RELAY LISTINGS in 12-page revised Catalog 100. Data on 50 standard relays in 550 contact arrangements and coil voltages. Four-page insert describes mercury-wetted contact relays.—Potter & Brumfield, Div. AMF, Princeton, Ind.

CONVERSION FACTORS. 8 1/2 x 11-inch reference table lists conversions for a large number of quantities, ranging from atmospheres to watt-hours, printed on light card, suitable for wall hanging.—Precision Equipment Co., 4409G Ravenswood Ave., Chicago 40, Ill.

REPLACEMENT TRANSFORMERS listed in 22-page Catalog TV-63/64. Prices, application data, specs and dimensions for 735 transformers, yokes, flybacks, filter chokes. 18 new listings.—Triad Distributor Div., 305 N. Briant St., Huntington, Ind.

ZENER DIODES listed in 4-page technical bulletin, outlining JEDEC types. List of part numbers, Zener voltages, Zener test currents, impedances, maximum temperature coefficients and case types. Graphs on temperature derating and Zener impedance, schematics on available case types.—Solitron Devices, Inc., 500 Livingston St., Norwood, N. J.

SCREEN ROOM FILTERS detailed in 2-page Data Sheet NPJ-127. Specification chart, installation notes, line drawings, photo. Aluminum-cased electrolytics described in Data Sheet NPJ-124.—Aerovox Corp., Distributor Div., New Bedford, Mass.

FERRITE DEVICES. 28-page booklet discusses magnetism, ferrites, isolator theory, design and application, rotators, circulators and other microwave ferrite devices.—Sylvania Electric Products, Inc., 1100 Main St., Buffalo 9, N. Y.

SOLDERLESS TERMINALS, connectors hardware, tube sockets, terminal strips offered in illustrated, 12-page Catalog No. PMR-3. Full specs, many line drawings and photos.—Waldon Electronics, Inc., 4625 W. 53 St., Chicago 32, Ill

INDICATOR LIGHTS, LAMP HOLDERS LENSES shown in 16-page Catalog 6302. Illustrations, tabulated technical data, diagrams.—Drake Mfg. Co., 4626 N. Olcott Ave., Chicago 31, Ill.

DC GROWTH IN INDUSTRY, 16-page information bulletin explains in simple language the advantages of dc, describes manufacturer's dc recorders. Liberally illustrated.—Amprobe Instrument Corp., Dept. REG-8, 630 Merrick Rd., Lynbrook, N. Y.

LC TUNERS, INDUCTORS shown in Catalog TI-73. Technical, electrical, physical data or 142 standard models LC tuners, fixed and variable inductors, tank circuits. Many photos, charts, graphs.—JFD Electronics Corp., 15th Ave. at 62 St., Brooklyn 19, N. Y.

1964 PARTS CATALOG, No. 640. 422 pages show stereo and hi-fi components, CB and ham gear, test instruments, PA equipment, radio and TV parts. Many items in kit form. Fully illustrated.—Lafayette Radio Electronics Corp., 111 Jericho Turnpike, Syosset, N. Y.

ELECTRONIC PRODUCTS offered in 445-page, illustrated Catalog 230. Items include amateur gear, electronic components, audio equipment, shortwave sets, test instruments, many others. Photos, full specs.—Allied Radio Corp., 100 N. Western Ave., Chicago 80, Ill.

MINIATURIZED MICA CAPACITORS detailed in 2-page Bulletin 528; ceramic trimmers in Bulletin 527.—Erie Resistor Corp., 644 W. 12 St., Erie, Pa.

COAXIAL CABLE, 160 types, listed in 8-page catalog. Data on Mil-Spec cables, community antenna TV cable, twinline and other special-purpose cables.—ITT Distributor Products Div., PO Box 99, Lodi, N. J.

SPEAKER SYSTEMS described in illustrated foldup leaflets. Brochure MT shows bookshelf size, 5-speaker Model TF-4. Brochure MX shows miniature Model X-11.—Jensen Mfg. Co., 6601 S. Laramie Ave., Chicago 38, Ill.

ELECTRONIC COMPONENTS. 16-page Catalog No. 63 lists jacks, plugs, switches, audio connectors, mike connectors, audio accessories, molded cable assemblies. Descriptions, line drawings.—Switchcraft, Inc., 5555 N. Elston Ave., Chicago 30, Ill.

LET'S TAKE THE GUESSWORK OUT OF ALTERNATORS. 8-page report gives functional comparison of alternator system vs. ordinary dc generator. Tells how to choose alternator system for any vehicle, discusses charging-system symptoms.—The Leece-Neville Co., 1374 E. 51 St., Cleveland 3, Ohio.

UNDIRECTIONAL DYNAMIC MIKE, dual impedance model 545S Unidyne III, described in 3-page technical bulletin. Complete data on applications, installation, connections, operation, acoustic considerations, full specs. Schematic diagrams, graphs show response and directional patterns.—Shure Bros., Inc., 222 Hartrey Ave., Evanston, Ill.

MAGNETIC LATCHING MICROMINIATURE RELAYS, Bulletin GEA-7241A. Describes all-welded relays magnetically latched for short power pulse operation. Electrical and mechanical characteristics. Diagrams show dimensions and mounting.—General Electric Co., Schenectady 5, N. Y. END

Any or all of these catalogs, bulletins, or periodicals are available to you on request direct to the manufacturers, whose addresses are listed at the end of each item. Use your letterhead - do not use postcards. To facilitate identification, mention the issue and page of RADIO-ELECTRONICS on which the item appears.

UNLESS OTHERWISE STATED, ALL ITEMS ARE GRATIS. ALL LITERATURE OFFERS ARE VOID AFTER SIX MONTHS.

NEW FROM
gersnback
LIBRARY

LEARN
ELECTRONICS
BY BUILDING

By
John Schroeder

\$3.85
No. 112



Teaches you to build as you read. Start with basic theory; finish by constructing amplifiers and receivers. An easy, practical approach for beginners of all ages.

BOOKS PURCHASED FOR PROFESSIONAL PURPOSES ARE TAX DEDUCTIBLE

Buy now from your electronic parts distributor or mail in the coupon below.

GERNSBACK LIBRARY, INC. 13C
154 West 14th Street, New York 11, N.Y.
Enclosed is \$_____ Please send me _____

Learn Electronics by Building @ \$3.85

Name.....
Street.....
City.....State.....

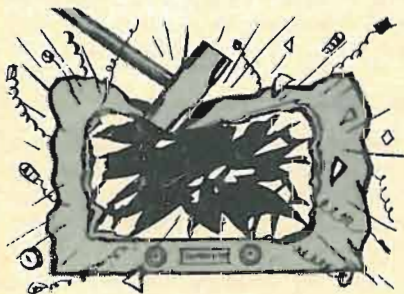

STOP!

WRECKING YOUR TV...

Inrush surge currents at 'Turn-On' destroy more TUBES, RECTIFIERS, and CAPACITORS than all other causes. . . .

EFFECTIVE, AUTOMATIC REDUCTION of the punishing inrush currents is immediately provided by the . . .

WUERTH SURGISTOR®



117 V.
AC-DC

Watts Range	Wuerth No.	Workman No.	G-C No.	List Price
100-275	4100-2	SR-1	25-894R	1.95
250-400	8050-1	SR-2	25-898R	2.95
300-500	8050-5	SR-3	3.30

Use SURGISTORS with your TV, Hi-Fi, Film Projector, or any device requiring inrush surge current protection. SEE your distributor or dealer TODAY. Or, send order direct to us for prompt action.

WUERTH PRODUCTS CORP.

1931 Moffett St. Hollywood, Florida

DEC. 50
Radio-Electronics

TELEVISION · SERVICING · HIGH FIDELITY

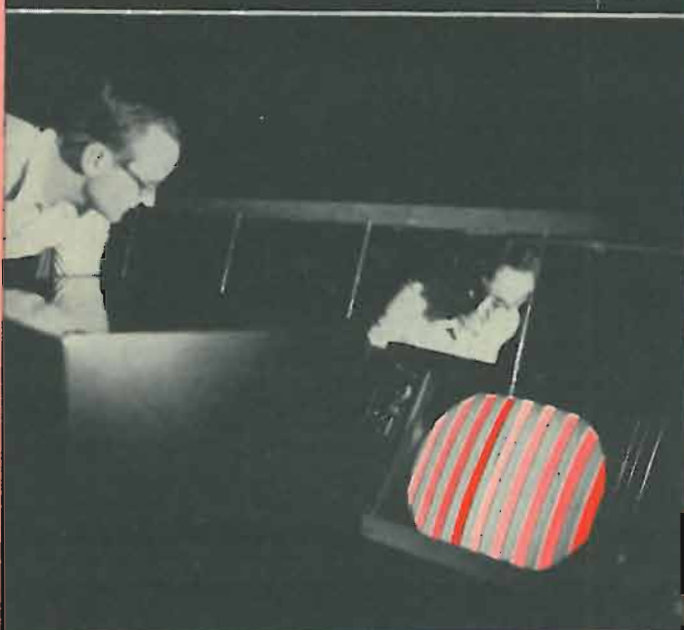

COMING NEXT MONTH
Radio-Electronics
COLOR TV ISSUE

Radio-Electronics Color TV Issue will be the definitive study on the subject. It will provide the most complete coverage of color television ever assembled in one magazine—written by an outstanding array of technical writers and contributors.

Here are just some of the features which will be in the issue:

- **Installing the Color Picture Tube**
A profusely illustrated, step-by-step article for the technician.
- **Color TV Roundup, 1964**
All about the new color TV receivers, complete with features on their circuitry.
- **Newest Color TV Set — the RCA CTC-15**
A behind-the-scenes look at the latest color chassis.
- **The Color Television Era**
Analysis of past and present trends in color TV, with some shrewd guesses as to the future. For the dealer, service technician and set owner.
- **In addition —** pages on color test equipment, new tubes for color, antennas and boosters, and color TV servicing.

DECEMBER ISSUE (on sale November 19)

BECOME A RADIO TECHNICIAN

for only \$26.95

BUILD YOUR RADIO

CIRCUITS AT HOME

with the New Progressive
RADIO "EDU-KIT"®

Reg. U.S.
Pat. Off.

All Guaranteed to Work!

PRACTICAL only
HOME RADIO COURSE \$26.95



TRAINING ELECTRONICS
TECHNICIANS SINCE 1946

NOW INCLUDES

- ★ 12 RECEIVERS
- ★ 3 TRANSMITTERS
- ★ S.Q. WAVE GENERATOR
- ★ AMPLIFIER
- ★ SIGNAL TRACER
- ★ SIGNAL INJECTOR
- ★ CODE OSCILLATOR

- ★ No Knowledge of Radio Necessary
- ★ No Additional Parts or Tools needed
- ★ Excellent Background for TV
- ★ School Inquiries Invited
- ★ Attractively Gift Packed

FREE EXTRAS

- SET OF TOOLS • RADIO & ELECTRONICS TESTER • ELECTRIC SOLDERING IRON • TESTER INSTRUCTION MANUAL • MEMBERSHIP IN RADIO-TV CLUB: CONSULTATION SERVICE • HI-FI GUIDE
- QUIZZES • TV BOOK • FCC AMATEUR LICENSE TRAINING
- RADIO BOOK • PRINTED CIRCUITRY • PLIERS-CUTTERS
- ALIGNMENT TOOL • WRENCH SET • CERTIFICATE OF MERIT
- VALUABLE DISCOUNT CARD

WHAT THE "EDU-KIT" OFFERS YOU

The "Edu-Kit" offers you an outstanding PRACTICAL HOME RADIO COURSE at a rock-bottom price. Our kit is designed to train Radio & Electronics Technicians, making use of the most modern methods of home training. You will learn radio theory, construction, servicing, basic Hi-Fi and TV repairs, code, FCC amateur license requirements.

You will learn how to identify radio symbols, how to read and interpret schematics, how to mount and lay out radio parts, how to wire and solder, how to operate electronic equipment, how to build radios. Today it is no longer necessary to spend hundreds of dollars for a radio course. You will receive a basic education in radio, worth many times the small price you pay, only \$35.95 complete.

THE KIT FOR EVERYONE

The Progressive Radio "Edu-Kit" was specifically prepared for any person who has a desire to learn Radio. The "Edu-Kit" has been used successfully by young and old in all parts of the world, by many Radio Schools and Clubs in this country and abroad. It is used for training and rehabilitation of Armed Forces Personnel and Veterans throughout the world.

The Progressive Radio "Edu-Kit" requires no instructor. All instructions are included. Every step is carefully explained. You cannot make a mistake.

PROGRESSIVE TEACHING METHOD

The Progressive Radio "Edu-Kit" is the foremost educational radio kit in the world, and is universally accepted as the standard in the field of electronics training. The "Edu-Kit" uses the modern educational principle of "Learn by Doing." Therefore, you will construct radio circuits, perform jobs and conduct experiments to illustrate the principles which you learn.

You begin by examining the various radio parts included in the "Edu-Kit." You then learn the function, theory and wiring of these parts. Then you build a simple radio. With this first set, you will enjoy listening to regular broadcast stations, learn theory, practice testing and troubleshooting. Then you build a more advanced radio, learn more advanced theory and techniques. Gradually, in a progressive manner, you will find yourself constructing increasingly more advanced multi-tube radio circuits and doing work like a professional Radio Technician.

Included in the "Edu-Kit" course are 25 Receiver, Transmitter, Code Oscillator, Signal Tracer, Signal Injector, Square Wave Generator and Amplifier circuits. These are genuine radio circuits, constructed by means of professional wiring and soldering on metal chassis, plus the new method of radio construction known as "Printed Circuitry." These circuits operate on your regular AC or DC house current. In addition you construct battery-operated transistor circuits.

In order to provide a thorough, well-integrated and easily-learned radio course, the "Edu-Kit" includes practical work as well as theory; troubleshooting in addition to construction; training for all, whether your purpose in learning radio be for hobby, business or job; progressively-arranged material, ranging from simple circuits to well-advanced topics in Hi-Fi and TV. Your studies will be further aided by Quiz materials and our well-known FREE Consultation Service.

THE "EDU-KIT" IS COMPLETE

You will receive all parts and instructions necessary to build 25 different radio and electronics circuits, each guaranteed to operate. Our Kits contain tubes, tube sockets, variable, electrolytic, mica, ceramic and paper dielectric condensers, resistors, diodes, transistors, tie strips, coils, hardware, tubing, punched metal chassis, Instruction Manuals, hookup wire, solder, selenium rectifiers, volume controls, switches, knobs, etc.

In addition, you receive Printed Circuit materials, including Printed Circuit chassis, special tube sockets, hardware and instructions. You also receive a useful set of tools, a professional electric soldering iron, and a self-powered Dynamic Radio & Electronics Tester. The "Edu-Kit" also includes Code Instructions and the Progressive Code Oscillator, in addition to the F.C.C.-type Questions and Answers for Radio Amateur License training. You will also receive lessons for servicing with the Progressive Signal Tracer and the Progressive Signal Injector, and a High Fidelity Guide and Quiz Book. Everything is yours to keep.

J. Statistis, of 25 Poplar Pl., Waterbury, Conn., writes: "I have repaired several sets for my friends, and made money. The 'Edu-Kit' paid for itself. I was ready to spend \$240 for a course, but I found your ad and sent for your Kit."

UNCONDITIONAL MONEY-BACK GUARANTEE

The Progressive Radio "Edu-Kit" has been sold to many thousands of individuals, schools and organizations, public and private, throughout the world. It is recognized internationally as the ideal radio course.

By popular demand the Progressive Radio "Edu-Kit" is now available in Spanish as well as English.

It is understood and agreed that should the Progressive Radio "Edu-Kit" be returned to Progressive "Edu-Kits" Inc., for any reason whatever, the purchase price will be refunded in full, without quibble or question, and without delay.

The high recognition which Progressive "Edu-Kits" Inc. has earned through its many years of service to the public is due to its unconditional insistence upon the maintenance of perfect engineering, the highest instructional standards, and 100% adherence to its Unconditional Money-Back Guarantee. As a result, we do not have a single dissatisfied customer throughout the entire world.

ORDER FROM AD—RECEIVE FREE BONUS RESISTOR AND CONDENSER KITS WORTH \$7.00

- Send "Edu-Kit" Postpaid. I enclose full payment of \$26.95.
- Send "Edu-Kit" C.O.D. I will pay \$26.95 plus postage.
- Send me FREE additional information describing "Edu-Kit."

Name.....
Address.....

Progressive "EDU-KITS" Inc. 1186 Broadway, Dept. 214G
Hewlett, N. Y.



60-cycle Trouble in 25-cycle Sets (Sylvania 533003S)

In Canada many 25-cycle TV sets operate on 60-cycle lines, usually with few filtering problems. Filters designed to remove 25- and 50-cycle ripple do even better on 60 and 120.

But on this one chassis, failure of a particular part can produce some peculiar sights. A fixed double bend shows up in the picture on transmissions locked to the local power

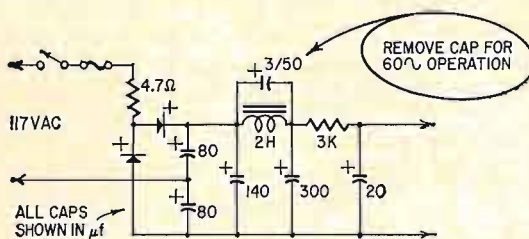

frequency, and a moving weave on telecasts not tied down to the power frequency. On weak signals, the picture jitters and rolls, and a vertical bar hangs in the middle of the screen.

This is caused by a partial short in the 3-μF 50-volt electrolytic across the filter choke. At 25 cycles, this resonates with the choke, presenting a high impedance to ripple. At 60 cycles, it can be more of a nuisance than a help if it fails. Removing it cures the complaint.—D. K. Vanderwater

RCA Color: 800, 900 Series

Frequent failure of the 6DQ5 horizontal output tube in these sets can be caused by an intermittent where the 6CG7 horizontal oscillator PC board connects to chassis ground. Oscillator heater failure removes drive to the 6DQ5, causing excessive dissipation.

If the 6CG7 heater is lit, try wiggling the tube to find the intermittent. The best cure is to resolder all four ground lugs on the horizontal oscillator board.—Arthur R. Richman

Clock Radio Knobs

If you own a clock radio or are often called upon to repair them, you know how easily the clock control knobs can get lost. A quick professional-looking replacement can be made by cutting a 3/4-inch length of 1/4- to 3/8-inch diameter plastic rod and drilling a hole the same diameter as the

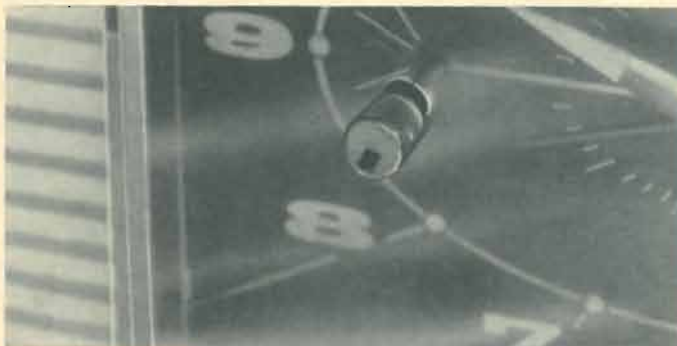

control shaft to a depth of 1/2 inch down the center of the new knob. For slotted shafts, cut a small rectangle from a tin can. It should be 1/4 inch long and slightly wider than the diameter of the hole. Heat it with your soldering gun and, using needle-nose pliers, force it into the hole of the new knob. Finally, no matter what type of shaft, fill the hole with cement and press the knob onto the shaft. A dot of red fingernail polish serves as a pointer.—Ronald S. Newbower

Squirrel Behind the Bars

The customer telephoned, reporting two black lines on his television screen. He also declared that the sound was mixed with a frying noise which drowned out the announcer's voice.

The technician put in several unrewarding minutes checking the set without locating an offending component. Not to be discouraged, he fired up the portable TV set reserved for such baffling occasions. The lead-in was secured and lo—the same black lines appeared on the portable screen. A check on some neighbors' sets firmly established the existence of a strong 120-cycle radiation along the street.

The technician mounted his truck and turned on the car radio. The noise drowned out all but the local broadcast station. After a false start in the wrong direction the point of highest noise intensity was located at a hydroelectric distribution pole a half block from the customer's home.

Inspection revealed that a squirrel had climbed across an insulator bearing a primary line. The squirrel's tail was lying on the cross arm of the pole which was freshly water-soaked by overnight rains. The final repair of the neighborhood problem was in sight. The power company was called and the squirrel borne to his last resting place. TV reception returned to normal.—D. K. Vanderwater

No Sound in Ac-Dc Five-Tuber

The trouble was no output on a five-tube ac-dc radio. A slight hum at the speaker was detectable. Tubes were OK. Signal substitution at the grid (pin 5) of the 50C5 output tube revealed normal output. After investigation, I noticed the coupling capacitor from the first audio was connected to pin 2 of the 50C5, and the 50C5 grid resistor was connected

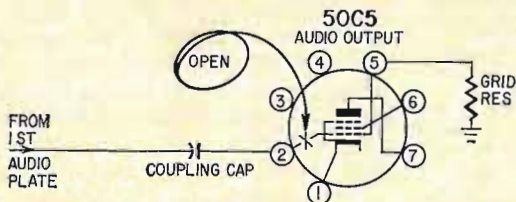

to pin 5. Playing a hunch, I removed the tube and found no continuity between pins 2 and 5. The cause of the trouble was obvious. The connection in the tube itself was open. A piece of wire from 2 to 5 on the socket cured the trouble for all time.—Sidney Claire

Snow on the Beach

A set in the lobby of a Miami beachfront hotel showed a lot of snow. A new 6BZ7 rf amplifier didn't help. I decided to inspect the antenna.

It was a V (conical), well installed. Connections and lead-in were good. No sign of trouble.

Returned to the lobby, checked tubes and connections again. All OK. Tried an indoor antenna—no better.

On a moment's inspiration I put the ohmmeter leads across the lead-in: only about 100,000 ohms, where it should have been infinity!

Back up the ladder to the antenna. The wooden cross-braces on the antenna V's were damp with salt spray—shorting out most of the signal.

A new and different antenna corrected the trouble. And I made a mental note not to use that kind near the ocean again.—H. R. Holtz

YOU CAN DO THIS WITH EUPHONICS' REVOLUTIONARY NEW 'SOFT-TOUCH' CARTRIDGE



The new U-11R Soft Touch Cartridge and Mounting brings new safety to records and stylus. When tone arm is accidentally hit, depressed or dropped, stylus lifts clear of record surface.

Here's how the Soft Touch protects

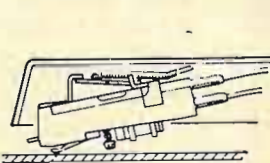

Normal tracking pressure
Needle in playing position

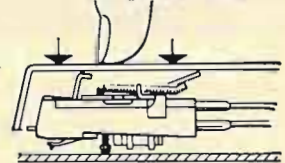

Abnormal pressure lifts
needle free and clear

For all Stereo-Monaural Replacement Featuring Euphonics' Exclusive Orbit-Action

The ideal replacement for most custom and package installations. The new Soft Touch U-11R offers smooth, wide range response (20 to 20,000 cps). High compliance: 8x10⁻⁶ cm/dyne permits tracking force as light as 1.5 grams. High capacity—1100 mmf per channel for extended bass response. Output, .4v at 5 cm/sec. PZT ceramic elements eliminate magnetic hum pickup and are not affected by heat or moisture. Easiest of all cartridges to install.

U-11R-.0007 Hi-Polish Diamond Styli, .003 Synthetic Sapphire
U-10R-.0007 and .003 Synthetic Sapphire

OTHER EUPHONICS ORBIT-ACTION CARTRIDGES

U-8—Replaces all Stereo—Most Monaural Phono cartridges.
U-8 .0007 and .003 Synthetic Sapphires
U-9 .0007 Diamond and .003 Synthetic Sapphire.

U-88 HOT HEAD

Ceramic replacement for Crystal Cartridges
U-88 .0007 and .003 Synthetic Sapphires
U-98 .0007 Diamond and .003 Synthetic Sapphire

See your Distributor or write . . .

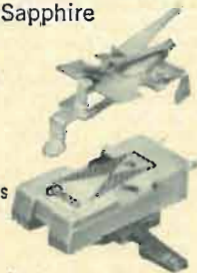

U-11R
Easy
Snap-in
Installation

Euphonics CORPORATION
ALL PRODUCTS AMERICAN MADE

Guaynabo,
Puerto Rico,
U.S.A.

the most noise-free recordings you have ever heard

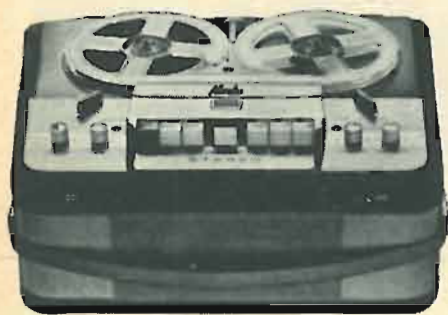

will be made on the new all-transistorized Norelco Continental '401' Stereo Tape Recorder, the only recorder using the newly developed AC107 transistors in its two preamplifiers. The AC107 is the only transistor specifically designed for magnetic tape head preamplifiers utilizing specially purified germanium to achieve the extraordinary low noise figure of 3 db, measured over the entire audio band (rather than the usual single frequency). This noise figure remains stable over large collector-emitter voltage swings and despite large variations in source resistance.

Hear the new transistorized Norelco Continental '401' • 4-track stereo/mono record and playback • 4 speeds: 7½, 3¾, 1½ and the new 4th speed of ¾ ips which provides 32 hours of recording on a single 7" reel • fully self-contained with dynamic stereo microphone, two speakers (one in the removable cover for stereo separation), dual preamps and dual recording and playback amplifiers • self-contained PA system • mixing facilities • can also play through external hi-fi system • multiply facilities.

Specifications: Frequency response: 60-16,000 cps at 7½ ips. Head gap: 0.00012". Signal-to-noise ratio: better than -48 db. Wow and flutter: less than 0.14% at 7½ ips. Recording level indicator: one-meter type. Program indicator: built-in, 4-digit adjustable. Inputs: for stereo microphone (1 two-channel); for phono, radio or tuner (2). Foot pedal facilities (1). Outputs: for external speakers (2), for external amplifiers (1 two-channel); headphone (1). Recording standby. Transistor complement: AC 107 (4), OC75 (6), OC74 (2), OC44 (2), 2N1314 (2), OC79 (1). Line voltage: 117 volts AC at 60 cycles. Power consumption: 65 watts. Dimensions: 18½" x 15" x 10". Weight: 38 lbs. Accessories: Monitoring headset and dual microphone adapter.

For a pleasant demonstration, visit your favorite hi-fi dealer or camera shop. Write for Brochure F-6, North American Philips Company, Inc., High Fidelity Products Division, 230 Duffy Avenue, Hicksville, Long Island, New York.

Norelco®

New Semiconductors and Tubes

6GQ7, 19GQ7

Hum control and high permeance are the primary features of these two new 9-pin miniature triple diodes. They were designed for AM-FM receivers, where triple diodes are used to simplify

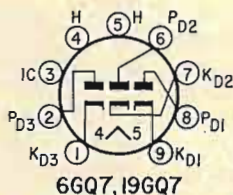

switching designs and reduce manufacturing costs.

The diode sections are similar electrically to those of the 6AL5. Each section is completely independent, except for the heater.

The 19GQ7 is the 150-ma series-string version of the 6GQ7. Both tubes are made by Raytheon.

Silicon bridge rectifiers

The drawing shows the physical and electrical configuration of a new series of miniature encapsulated silicon full-wave bridge rectifiers, designed to replace the four separate diodes usually

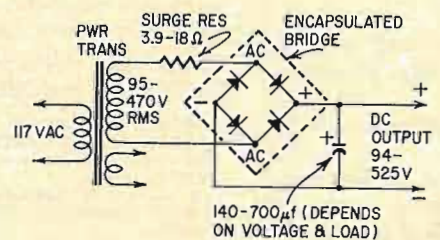
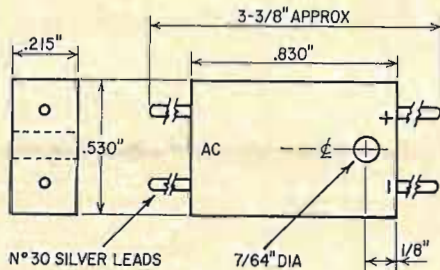

used. A number of high-fidelity amplifiers are now using bridge rectifiers, and should one or more of the diodes fail, it may be more economical to replace the entire bridge with one of these.

There are eight versions, for rms ac input voltages from 95 to 470 volts, and corresponding dc outputs (into ca-

pacitive filters) of 94 to 525 volts. Maximum capacitive-load output current is 1.3 amps, or 1.8 into a resistive load. The bridges will operate up to 140°C.

Maximum forward voltage drop at 25°C and peak current is only 1.2 volts per rectifying element—or 2.4 volts total. The devices are made by International Rectifier Corporation.

2N2654, 2N2671, 2N2672

The appearance on the market of these three transistors demonstrates just how routine the use of transistors for higher-frequency amplification has become. The 2N2654 is a germanium PADT high-gain vhf transistor designed especially for "mass-produced, high performance FM radios" (quoted from the manufacturer's release).

Cutoff frequency is 250 mc, and power gain at 100 mc is 18.8 db. Best

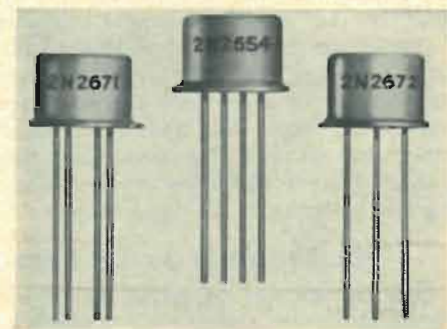

of all is the price: \$0.85 in 1000-up quantities, and about \$1.30 singly.

Another recent device is the 2N2671 (from Amperex, as are the other two in this item), which is "an economy, low-noise FM transistor" with a 14-db power gain at 100 mc and an 8-db noise figure. Amperex claims that it will work at as low as 3 volts. It goes for only \$0.50 in quantities of 1,000 or more.

Less spectacular (and cheaper, too) is the 2N2672, a "universal AM-short wave transistor", for rf and i.f. stages in receivers for standard AM broadcast and short waves to 6 mc. Like the others, one of its most attractive features is its low feedback capacitance: 1.5 pf for this one. High current gain, too—about 150. It is priced at \$0.40 in 1,000-up quantities.

Tiny light sensor

This is a very-miniature photoresistive (or photoconductive, if you like) light sensing device, ¼ inch in diameter and less than ¼ inch high. Texas Instruments, manufacturer of the device, claims it to be the smallest of its kind commercially available.

The sensor, called the LSX 600, is designed to be fitted directly into a ¼-inch hole in a printed circuit board. Two simple soldering operations connect it.

Suggested applications include character recognition, tape and card reading

RAD-TEL'S

QUALITY

BRAND NEW TUBE SALE!

AT LOW, LOW PRICES--COMPARE

UP TO
SAVE 75% OFF*



*Manufacturers Suggested List Price

ONE YEAR GUARANTEE

RAD-TEL WILL REPLACE ANY TUBE THAT DOES NOT GIVE EFFICIENT PERFORMANCE FOR 1 YEAR FROM DATE OF PURCHASE.

ONE DAY SERVICE OVER 500 TYPES IN STOCK

ORDER TYPES NOT LISTED

• **FREE!** Send For New Tube & Parts Catalog •
Send For Trouble Shooting Guide

TUBE SUBSTITUTION BOOK



\$1.25
No. 193

- Over 11,000 direct tube substitutes
- Only all-inclusive directory of electron tube equivalents:
 - For USA electron tubes
 - Substitutes for foreign tubes
 - Picture tubes, newer models
 - Picture tubes, older models
 - transistor replacements
 - Army-Navy, V.T. substitutes

Easy to work on set while panel is off.



CHEATER CORD
6 ft., No. 154..... **29¢ ea.** Lots of 3—25¢ ea.



RAD-TEL TUBE CO.

TV, RADIO AND HI-FI

DEPT. RE 55 CHAMBERS STREET, NEWARK, NEW JERSEY 07105

TERMS: 25% deposit must accompany all orders, balance C.O.D. Orders under \$5: add \$1 handling charge plus postage. Orders over \$5: plus postage. Approx. 8 tubes per 1 lb. Subject to prior sale. No C.O.D.'s outside continental U.S.A.

EACH TUBE ATTRACTIVELY BOXED & BRANDED RAD-TEL

Qty.	Type	Price	Qty.	Type	Price	Qty.	Type	Price	Qty.	Type	Price
—	0Z4	.79	—	6AU8	.87	—	6K6	.63	—	12CU5	.58
—	1AX2	.62	—	6AV6	.41	—	6S4	.52	—	12CU6	1.06
—	1B3	.79	—	6AW8	.90	—	6SA7GT	.99	—	12CX6	.54
—	1DN5	.55	—	6AX4	.66	—	6SH7	1.02	—	12D4	.69
—	1G3	.79	—	6AX5	.74	—	6SJ7	.88	—	12DE8	.83
—	1J3	.79	—	6BA6	.50	—	6SK7GT	.95	—	12DL8	.88
—	1K3	.79	—	6BC5	.61	—	6SL7GT	.84	—	12DQ6	1.04
—	1R5	.77	—	6BC8	1.04	—	6SN7	.65	—	12DS7	.84
—	1S5	.75	—	6BE6	.55	—	6SQ7GT	.94	—	12DT5	.76
—	1T4	.72	—	6BF5	.90	—	6T4	.99	—	12DT7	.79
—	1U5	.65	—	6BF6	.44	—	6T8	.85	—	12DT8	.78
—	1X2B	.82	—	6BG6	1.70	—	6U8	.83	—	12DW8	.89
—	2AF4	.96	—	6BH8	.98	—	6V6GT	.54	—	12DZ6	.62
—	3AL5	.46	—	6BJ6	.65	—	6W4	.61	—	12ED5	.62
—	3AU6	.54	—	6BJ7	.79	—	6W6	.71	—	12EG6	.62
—	3AV6	.42	—	6BK7	.85	—	6X4	.41	—	12EK6	.62
—	3BC5	.63	—	6BL7	1.09	—	6X8	.80	—	12EL6	.50
—	3BN6	.75	—	6BN6	.74	—	7A8	.68	—	12EZ6	.57
—	3BU8	.78	—	6BQ6	1.12	—	7AU7	.65	—	12F8	.66
—	3BY6	.58	—	6BQ7	1.00	—	7EY6	.75	—	12FA6	.79
—	3BZ6	.56	—	6BU8	.70	—	7Y4	.69	—	12FM6	.50
—	3CB6	.56	—	6BX7	1.11	—	8AU8	.90	—	12FR8	.97
—	3CS6	.58	—	6BZ6	.55	—	8AW8	.93	—	12FX8	.90
—	3DG4	.85	—	6BZ7	1.03	—	8BQ5	.60	—	12GC6	1.06
—	3DK6	.60	—	6C4	.45	—	8CG7	.63	—	12J8	.84
—	3DT6	.54	—	6CB6	.55	—	8CM7	.70	—	12K5	.75
—	3GK5	.99	—	6C06	1.51	—	8CN7	.97	—	12L6	.73
—	3Q4	.63	—	6CG7	.61	—	8CS7	.74	—	12SF7	.69
—	3S4	.75	—	6CG8	.80	—	8EB8	.94	—	12SK7GT	.95
—	3V4	.53	—	6CL8	.79	—	8FG7	.56	—	12SL7	.80
—	4BQ7	1.01	—	6CM7	.69	—	9CL8	.79	—	12SN7	.67
—	4CS6	.61	—	6CN7	.70	—	11CY7	.75	—	12SQ7GT	.91
—	4DT6	.55	—	6CQ8	.92	—	12A4	.60	—	12U7	.62
—	4GM6	.60	—	6CR6	.60	—	12AB5	.60	—	12V6	.63
—	5AM8	.79	—	6CS6	.57	—	12AC6	.55	—	12W6	.71
—	5AN8	.90	—	6CS7	.69	—	12AD6	.57	—	12X4	.47
—	5AQ5	.54	—	6CU5	.58	—	12AE6	.50	—	17AX4	.67
—	5AT8	.83	—	6CU6	1.08	—	12AE7	.94	—	17DQ6	1.06
—	5BK7	.86	—	6CY5	.70	—	12AF3	.73	—	18FW6	.49
—	5BQ7	1.01	—	6CY7	.71	—	12AF6	.67	—	18FX6	.53
—	5BR8	.83	—	6DA4	.68	—	12AJ6	.62	—	18FY6	.50
—	5CG8	.81	—	6DE6	.61	—	12AL5	.47	—	19AU4	.87
—	5CL8	.76	—	6DG6	.62	—	12AL8	.95	—	19B6G	1.39
—	5CQ8	.84	—	6DJ8	1.21	—	12AQ5	.60	—	19EA8	.79
—	5EA8	.80	—	6DK6	.59	—	12AT6	.50	—	19T8	.85
—	5EU8	.80	—	6DN6	1.55	—	12AT7	.76	—	21EX6	1.49
—	5J6	.72	—	6DQ6	1.10	—	12AU6	.51	—	25AX4	.70
—	5T8	.86	—	6DT5	.81	—	12AU7	.61	—	25C5	.53
—	5U4	.60	—	6DT6	.53	—	12AV6	.41	—	25CA5	.59
—	5U8	.84	—	6DT8	.94	—	12AV7	.82	—	25CD6	1.52
—	5V6	.56	—	6EA8	.79	—	12AX4	.67	—	25CU6	1.11
—	5X8	.82	—	6EB5	.73	—	12AX7	.63	—	25DN6	1.42
—	5Y3	.46	—	6EB8	.94	—	12AY7	1.44	—	25EH5	.55
—	6AB4	.46	—	6EM5	.77	—	12AZ7	.86	—	25L6	.57
—	6AC7	.96	—	6EM7	.82	—	12B4	.68	—	25W4	.68
—	6AF4	1.01	—	6EU8	.79	—	12BD6	.50	—	32ET5	.55
—	6AG5	.70	—	6EV5	.75	—	12BE6	.53	—	35C5	.51
—	6AH4	.81	—	6EW6	.57	—	12BF6	.60	—	35L6	.60
—	6AH6	1.10	—	6EY6	.75	—	12BH7	.77	—	35W4	.42
—	6AK5	.95	—	6FG7	.69	—	12BK5	1.00	—	35Z5	.60
—	6AL5	.47	—	6FV8	.79	—	12BL6	.56	—	36AM3	.36
—	6AM8	.78	—	6GH8	.80	—	12BQ6	1.16	—	50B5	.69
—	6AQ5	.53	—	6GK5	.61	—	12BR7	.74	—	50C5	.53
—	6AS5	.60	—	6GK6	.79	—	12BV7	.76	—	50EH5	.55
—	6AT6	.49	—	6GN8	.94	—	12BY7	.77	—	50L6	.61
—	6AT8	.86	—	6HG	.58	—	12BZ7	.86	—	70L7	.97
—	6AU4	.85	—	6J5GT	.51	—	12CN5	.56	—	117Z3	.85
—	6AU6	.52	—	6J6	.71	—	12CR6	.67	—	807	.75

RAD-TEL TUBE CO. NOT AFFILIATED WITH ANY OTHER MAIL ORDER TUBE COMPANY

—	5Y3	.46	—	6EB8	.94	—	12AY7	1.44	—	25EH5	.55
—	6AB4	.46	—	6EM5	.77	—	12AZ7	.86	—	25L6	.57
—	6AC7	.96	—	6EM7	.82	—	12B4	.68	—	25W4	.68
—	6AF4	1.01	—	6EU8	.79	—	12BD6	.50	—	32ET5	.55
—	6AG5	.70	—	6EV5	.75	—	12BE6	.53	—	35C5	.51
—	6AH4	.81	—	6EW6	.57	—	12BF6	.60	—	35L6	.60
—	6AH6	1.10	—	6EY6	.75	—	12BH7	.77	—	35W4	.42
—	6AK5	.95	—	6FG7	.69	—	12BK5	1.00	—	35Z5	.60
—	6AL5	.47	—	6FV8	.79	—	12BL6	.56	—	36AM3	.36
—	6AM8	.78	—	6GH8	.80	—	12BQ6	1.16	—	50B5	.69
—	6AQ5	.53	—	6GK5	.61	—	12BR7	.74	—	50C5	.53
—	6AS5	.60	—	6GK6	.79	—	12BV7	.76	—	50EH5	.55
—	6AT6	.49	—	6GN8	.94	—	12BY7	.77	—	50L6	.61
—	6AT8	.86	—	6HG	.58	—	12BZ7	.86	—	70L7	.97
—	6AU4	.85	—	6J5GT	.51	—	12CN5	.56	—	117Z3	.85
—	6AU6	.52	—	6J6	.71	—	12CR6	.67	—	807	.75

Fast, Dependable service — Selling direct by mail for over 16 years —

RAD-TEL Tube Co.
Dept. RE
55 Chambers Street
Newark, New Jersey 07105

Total Tubes \$ _____
Total Part(s) \$ _____
Postage \$ _____
Grand Total \$ _____

ENCLOSED IS \$ _____ Please rush order.

SEND: TUBE SUBSTITUTION BOOK, No. 193 @ 1.25 EACH
Cheater Cord 29c ea. Lots of 3 - 25c ea. #154

Orders under \$5.00 - Add \$1.00 handling charge - plus postage.

FREE! Send FREE Tube and Parts Catalog
 Send FREE Trouble Shooting Guide

NAME _____

ADDRESS _____

CITY _____ ZONE _____ STATE _____

TRANS-IT TRANSISTORIZED AUTO IGNITION

FOR ONLY **\$10.77** DEALER NET

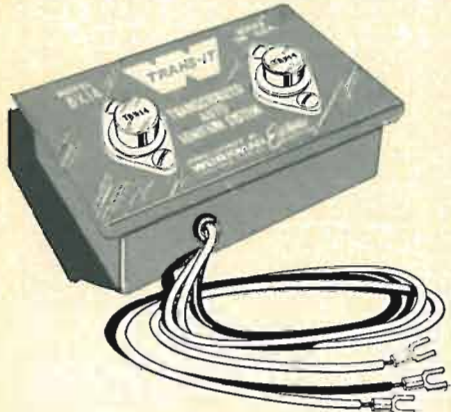

Maintains high voltage as RPM increases. Car idles smoother at low speeds. Uses existing car coil. Saves gas, points and sparkplugs. For 6 and 12 volt cars with negative ground.

ASK YOUR ELECTRONIC PARTS DISTRIBUTOR FOR

W MODEL NO. **BX14**
(MODEL BX14A FOR 6 VOLT CARS)

Manufactured by
WORKMAN Electronic
SARASOTA, FLORIDA PRODUCTS, INC.



and velocity indicators. Dark current is typically 10 μ a at 100°C, light current about 1 ma. Power dissipation is 50 mw.

The photo shows a fascinated moth inspecting the sensor. TI wants you to notice the size of the sensor compared to the size of the moth's eye. Perhaps he is considering a replacement?

Integrated reference amplifiers

Some gentlemen at General Electric have come up with what seems like a fine idea: they have combined a voltage reference device with a dc amplifier.

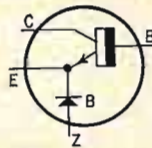

Specifically, they have put in one TO-5 package a Zener diode junction and a transistor—semiconductor analogues of the gaseous voltage-reference tube and (usually pentode) amplifier in so many tube regulated power supplies.

Some of the advantages of the marriage are lower cost than the two separate units, both in initial manufac-



ture and in production later, fewer connections, better temperature match, less space.

The device is used to control a series or shunt regulating element in regulated current or voltage supplies. END

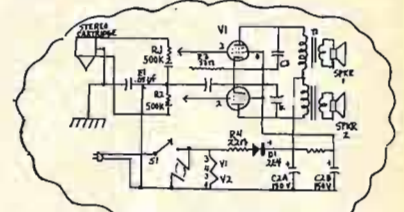

GIGANTIC - COLOSSAL - STUPENDOUS &

\$200 HEARING AID \$2 \$100 TV COILS \$1 \$40 WESTINGHOUSE TV TUNER \$1 \$50 PRECISION RESISTORS \$1 **FREE GIFT—10% DISCOUNT** on ORDERS of \$10 or over (on DOLLAR BUYS only). Our **TREMENDOUS BUYING POWER** makes these **AMAZING BUYS** possible!

- | | | | |
|---|--|--|--|
| <input type="checkbox"/> 1—5" PM SPEAKER
Alnico #5 magnet \$1 | <input type="checkbox"/> 3—3" RECORDER TAPES
quality acetate, 150 feet \$1 | <input type="checkbox"/> 10—6' ELECTRIC LINE CORDS
with plug \$1 | <input type="checkbox"/> 100 — ASSORTED 1/2 WATT \$1
RESISTORS some in 5% \$1 |
| <input type="checkbox"/> 1—4" PM SPEAKER
Alnico #5 magnet \$1 | <input type="checkbox"/> 10—3" RECORDER TAPE REELS \$1 | <input type="checkbox"/> 4 — 50' SPOOLS HOOK-UP
WIRE 4 different colors \$1 | <input type="checkbox"/> 70 — ASSORTED 1 WATT \$1
RESISTORS some in 5% \$1 |
| <input type="checkbox"/> 3 — SPEAKER CABINETS for
2 1/2" to 3" speaker, all purpose \$1 | <input type="checkbox"/> 10 — SURE-GRIP ALLIGATOR
CLIPS 2" plated \$1 | <input type="checkbox"/> 50 — STRIPS ASSORTED SPA-
GHETTI handy sizes \$1 | <input type="checkbox"/> 35 — ASSORTED 2 WATT \$1
RESISTORS some in 5% \$1 |
| <input type="checkbox"/> 1—3" PM SPEAKER
for above cabinet or others .. \$1 | <input type="checkbox"/> 10 — SETS PHONO PLUGS &
PIN JACKS RCA type \$1 | <input type="checkbox"/> 100 — ASSORTED RUBBER
GROMMETS best sizes \$1 | <input type="checkbox"/> 50—ASST. MICA CONDENS-
ERS some in 5% \$1 |
| <input type="checkbox"/> 4—AUDIO OUTPUT TRANS-
FORMERS 50L6 type \$1 | <input type="checkbox"/> 20—ASST. PILOT LIGHTS
#44, 46, 47, 51, etc. \$1 | <input type="checkbox"/> 50' — INSULATED SHIELDED
WIRE #20 braided metal jacket \$1 | <input type="checkbox"/> 50 — ASST. DISC. CERAMIC \$1
CONDENSERS popular numbers |
| <input type="checkbox"/> 3—AUDIO OUTPUT TRANS-
FORMERS 6K6 or 6V6 type .. \$1 | <input type="checkbox"/> 20 — PILOT LIGHT SOCKETS \$1
bayonet type, wired | <input type="checkbox"/> 32'—TEST PROD WIRE
deluxe quality, red or black .. \$1 | <input type="checkbox"/> 10—DIODE CRYSTALS 1N34 \$1 |
| <input type="checkbox"/> CHAPT ZU DI MITZIA "JACKPOT" — DOUBLE YOUR MONEY BACK
IF NOT COMPLETELY SATISFIED..... \$1 | <input type="checkbox"/> 50 — ASSORTED TERMINAL
STRIPS 1, 2, 3, 4 lugs \$1 | <input type="checkbox"/> 50'—HI-VOLTAGE WIRE
for TV, special circuits, etc. .. \$1 | <input type="checkbox"/> 10—ASST. DIODE CRYSTALS \$1
5-1N60 and 5-1N84 |
| <input type="checkbox"/> 3—1/2 MEG VOLUME CON-
TROLS with switch, 3" shaft .. \$1 | <input type="checkbox"/> 100' — FINEST NYLON DIAL
CORD best size, .028 gauge .. \$1 | <input type="checkbox"/> 100' — TWIN TV LEAD-IN
WIRE 300 ohm, heavy duty .. \$1 | <input type="checkbox"/> 2—SILICON RECTIFIERS
750ma, 400 PIV \$1 |
| <input type="checkbox"/> 5—ASST. 4 WATT WIRE-
WOUND CONTROLS \$1 | <input type="checkbox"/> 50—RADIO & TV SOCKETS \$1
all type 7 pin, 8 pin, 9 pin .. | <input type="checkbox"/> 50' — FLAT 4-CONDUCTOR
WIRE many purposes \$1 | <input type="checkbox"/> 3—SILICON RECTIFIERS
Top Hat 500ma-400 PIV \$1 |
| <input type="checkbox"/> 10 — ASSORTED VOLUME
CONTROLS less switch \$1 | <input type="checkbox"/> 25—ASSORTED PRINTED CIR-
CUIT SOCKETS best types .. \$1 | <input type="checkbox"/> 5 — TV HI-VOLT ANODE
LEADS 20" length \$1 | <input type="checkbox"/> 50—ASSORTED TV PEAKING \$1
COILS all popular types |
| <input type="checkbox"/> 5—ASSORTED VOLUME CON-
TROLS with switch \$1 | <input type="checkbox"/> 50—3AG FUSES 5-AMP \$1 | <input type="checkbox"/> 10—TV PICTURE TUBE SOCK-
ETS wired with 20" leads \$1 | <input type="checkbox"/> 10—ASST. TV ION TRAPS \$1
for all type TV Receivers ... |
| <input type="checkbox"/> 4—TOGGLE SWITCHES
SPST, SPDT, DPST, DPDT ... \$1 | <input type="checkbox"/> 50—3AG FUSES 8-AMP \$1 | <input type="checkbox"/> 5—TV CHEATER CORDS \$1
with both plugs | <input type="checkbox"/> 50 — ASST. CERAMIC CON-
DENSERS some in 5% |
| <input type="checkbox"/> 10 — ASSORTED SLIDE \$1
SWITCHES SPST, DPDT, etc. .. | <input type="checkbox"/> \$17.50 WEBSTER #SC2-D DIAMOND STEREO CARTRIDGE \$1 | <input type="checkbox"/> 200' — BUSS WIRE #20
for hookups, special circuits,
etc. \$1 | <input type="checkbox"/> 1—INDOOR TV ANTENNA \$1
hi-gain, 3 section, tiltproof ... |
| <input type="checkbox"/> 4 — I.F. COIL TRANSFORM-
ERS 456kc, most popular type \$1 | <input type="checkbox"/> 250—ASST. WOOD SCREWS \$1
finest popular selection | <input type="checkbox"/> 250—ASST. SOLDERING LUGS \$1
best types and sizes | <input type="checkbox"/> STANDARD TUNER UHF STRIPS \$1
26K, 34K, 46K, 51K each |
| <input type="checkbox"/> 3 — I.F. COIL TRANSFORM-
ERS 262kc, for Auto Radios .. \$1 | <input type="checkbox"/> 250—ASST. SELF TAPPING
SCREWS #6, #8, etc. \$1 | <input type="checkbox"/> 3—CONNECTORS #PL-259 \$1 | <input type="checkbox"/> 6—TRANS. RADIO BATTERIES \$1
9 volt, same as Eveready #216 |
| <input type="checkbox"/> 3 — I.F. COIL TRANSFORM-
ERS 10.7mc for FM \$1 | <input type="checkbox"/> 150—ASST. 6/32 SCREWS
and 150 6/32 HEX NUTS \$1 | <input type="checkbox"/> 3—CONNECTORS #50-239 \$1 | <input type="checkbox"/> 1—TUNGSO 6DQ6 TUBE \$1 |
| <input type="checkbox"/> 5—OVAL LOOP ANTENNAS \$1
assorted popular sizes | <input type="checkbox"/> 150—ASST. 8/32 SCREWS
and 150—8/32 HEX NUTS .. \$1 | <input type="checkbox"/> 150—6/32 HEX NUTS
and 150—8/32 HEX NUTS .. \$1 | <input type="checkbox"/> 10—SYLVANIA 2C4 \$1 |
| | | | <input type="checkbox"/> 1 — STANDARD 1AX2 TUBE \$1
and 1 STANDARD 35W4 TUBE |

BROOKS RADIO & TV CORP., 84 Vesey St., Dept. A, New York 7, N. Y. TELEPHONE
CORtlandt 7-2359

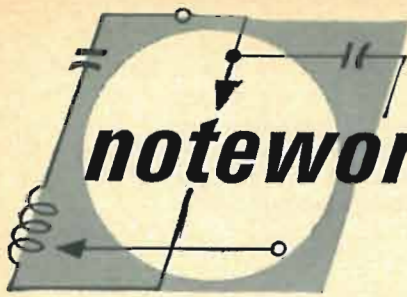

noteworthy Circuits

Industrial Tone Alarm

Here is an inexpensive, easily built, oscillator-audio amplifier that packs a hefty wallop and is rugged enough for industrial use. It lends itself well to a host of applications where a triggered tone alarm is required to attract atten-

tion. For example, in areas such as go-no-go gaging or nondestructive testing, a pair of contacts on the actuated relay, connected across jack J, will complete the speaker circuit, producing a loud tone.

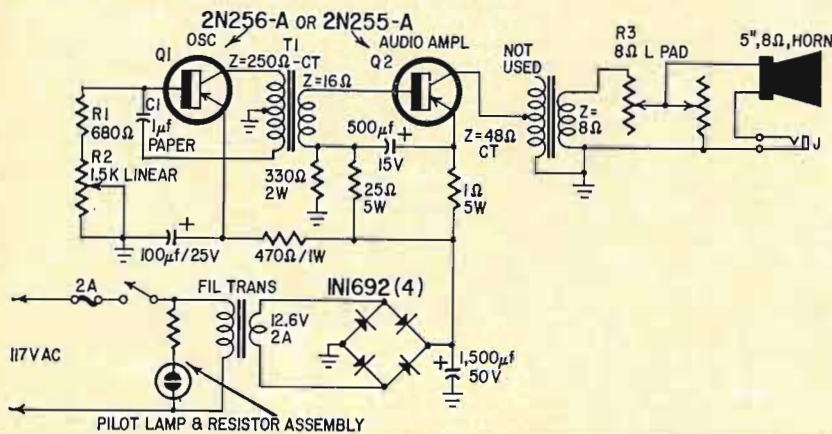

R3 is an L-pad speaker volume control and also provides a load across T2's secondary when the speaker is disconnected. The unit runs continuously but sounds an alarm only when a pair of external contacts connects in the speaker. An alternative to speaker switching would be switching transistor Q2 in and out. Keying the oscillator produces a slight chirp. Other methods of switching will occur to you.

The alarm is constructed on a 5 x 6 x 1-inch utility box with chassis.

AWE-INSPIRING! NO.... WE DON'T MEAN THE GRAND CANYON.... WE MEAN THE AMAZING BARGAINS THAT FOLLOW!

IMMEDIATE DELIVERY... SCIENTIFIC LIGHT PACKING for safe delivery at minimum cost. HANDY WAY TO ORDER — Pencil mark items & enclose with check or money order, add extra for shipping, excess refunded with advantage to customer. Tearsheet returned with order, as your packing slip.

- | | | | |
|---|--|--|--|
| <ul style="list-style-type: none"> <input type="checkbox"/> EMERGENCY AUTO LAMP \$1
Red dome blinker, incl Battery saves lives on highway stops... <input type="checkbox"/> 1-SQ. YARD GRILLE CLOTH \$1
most popular brown & gold design <input type="checkbox"/> 500'-CHOICE HOOKUP WIRE \$1
asst colors cut in handy lengths some stripped and tinned.... <input type="checkbox"/> 100'-STANDARD ZIP CORD \$1
2 conductor ±18 white or brown <input type="checkbox"/> 100'-MINIATURE ZIP CORD \$1
2 conductor, serves 101 uses <input type="checkbox"/> 50-GOODALL CONDENSERS \$1
molded 1-200v (test 800v)... <input type="checkbox"/> 20-ASST. DIODE CRYSTALS \$1
fine assortment. Latest types... <input type="checkbox"/> 15-ASST. ROTARY SWITCHES \$1
all popular types \$20 value... <input type="checkbox"/> 100-ASSORTED FUSES \$1
SAG and other popular uses... <input type="checkbox"/> 1000-ASSORTED HARDWARE KIT \$1
SCREWS, NUTS, WASHERS, RIVETS, ETC. IN 2 HANDY LUCITE CASES... <input type="checkbox"/> 3-ASST. SIZES RADIO CHASSIS PANS drilled & plated... <input type="checkbox"/> 3-VARIABLE CONDENSERS \$1
asst. popular super-het types... <input type="checkbox"/> 15-RADIO OSCILLATOR COILS \$1
standard 456kc..... <input type="checkbox"/> 100-ASST RUBBER & FELT FEET FOR CABINETS \$1
best sizes <input type="checkbox"/> 8-ASST. LUCITE CASES \$1
hinged cover, handy for parts <input type="checkbox"/> 20-INSTRUMENT POINTER KNOBS \$1
popular screw type... <input type="checkbox"/> 20-ELECTRIC LINE CORDS \$1
approved 2 1/2' with plug.... <input type="checkbox"/> 10-I.F. COIL TRANSFORMERS \$1
456 kc, latest 3/4"x3/4"..... | <ul style="list-style-type: none"> <input type="checkbox"/> \$15.00 TELEVISION PARTS \$1
"JACKPOT" best buy ever... <input type="checkbox"/> 1-LB SPOOL ROSIN-CORE SOLDER \$1
40/60..... <input type="checkbox"/> 20-ASSORTED GRID CAPS \$1
for 1B3, 1X2, 6BG6, 6BQ6, etc. <input type="checkbox"/> 20-ASSORTED TV KNOBS \$1
ESCUTCHEONS etc. \$20 value <input type="checkbox"/> 90° TV DEFLECTION YOKE \$1
wired network, schematic diag. <input type="checkbox"/> 90° FLYBACK TRANSFORMER \$1
universal type for many uses... <input type="checkbox"/> 70° TV DEFLECTION YOKE \$1
wired network, long leads.... <input type="checkbox"/> 50-ASSORTED TV COILS \$1
I.F. video, sound, ratio, etc.... <input type="checkbox"/> 20-ASS'TED WIREWOUND RESISTORS \$1
5, 10 watt..... <input type="checkbox"/> 50-PRECISION RESISTORS \$1
asst. list price \$50 less 98% <input type="checkbox"/> 300-CERAMIC CONDENSERS \$1
Erie, tubular, 300 mmf-300v <input type="checkbox"/> 200-TUBULAR CONDENSERS \$1
100-.002 and 100-.004..... <input type="checkbox"/> 8-ASTRON ELECTROLYTIC CONDENSERS \$1
8mf-450v..... <input type="checkbox"/> 5-C D ELECTROLYTIC CONDENSERS \$1
30/20-350v, 10-250v <input type="checkbox"/> 15-STANDARD ELECTROLYTIC CONDENSERS \$1
2mf-450v... <input type="checkbox"/> 15-STANDARD ELECTROLYTIC CONDENSERS \$1
400mf-25v... <input type="checkbox"/> 3-ELECTROLYTIC CONDENSERS \$1
50/30-150v..... | <ul style="list-style-type: none"> <input type="checkbox"/> 50-RCA PHONO PLUGS \$1
Standard for phonos, male.... <input type="checkbox"/> 1-6" x 9" OVAL PM SPEAKER \$1
(one to a customer)..... <input type="checkbox"/> 10-SYLVANIA 1U4 TUBES \$1
brand new Jan. individual cartons also serves as 1T4..... <input type="checkbox"/> 3-TOP BRAND 35W4 TUBES \$1 <input type="checkbox"/> 50-ASSORTED TUBES \$1
Radio, Television and Industrial <input type="checkbox"/> 100-ASST. TUBULAR CONDENSERS \$1
.001 to .47 to 800v <input type="checkbox"/> 50-ASST MOLDED CONDENSERS \$1
short leads..... <input type="checkbox"/> 20-GOODALL TUBULAR CONDENSERS \$1
.047-600v.... <input type="checkbox"/> 5-ASST. SELENIUM RECTIFIERS \$1
65ma, 100ma, 300ma, etc. <input type="checkbox"/> 10-ASST. RADIO ELECTROLYTIC CONDENSERS \$1 <input type="checkbox"/> 5-ASST. TV ELECTROLYTIC CONDENSERS \$1 <input type="checkbox"/> 300-ASST. 1/2 W RESISTORS \$1
AB, 1RC, short leads, excellent <input type="checkbox"/> STANDARD TV TUNER \$4
41 mc with tubes (as is).... <input type="checkbox"/> 20-OHMITE 3K-TOW WIREWOUND RESISTORS \$1 <input type="checkbox"/> 50-RESISTORS 16K 2W 10% \$1 <input type="checkbox"/> 50-RESISTORS 24K 2W 5% \$1 | <h3>MARKET SCOOP COLUMN</h3> <ul style="list-style-type: none"> <input type="checkbox"/> STANDARD UHF INPUTUNER \$1
(less cabinet & 6AF4 tube) as is <input type="checkbox"/> G. E. SINE WAVE GENERATOR \$1
sold as is, less tubes..... <input type="checkbox"/> G. E. EQUIPMENT SECTION \$1
with sockets, condensers, etc. <input type="checkbox"/> 2-\$3 TELEX EARPIECES \$1
also useful as microphone.... <input type="checkbox"/> 4-IBM COMPUTER SECTIONS \$1
loaded with valuable parts... <input type="checkbox"/> 4-IBM 25L6 TUBES \$1 <input type="checkbox"/> 1 ROSKO PORTABLE RADIO \$1
some complete—including Cabinet, Speaker, 4 Tubes (as is, pot'luek) <input type="checkbox"/> RCA PHONO CARTRIDGE \$1
#34710, list price \$15.00... <input type="checkbox"/> \$20-SHURE M-7D DIAMOND NEEDLE exact replacement... \$3 <input type="checkbox"/> \$25 TELEPHONE AMPLIFIER \$4
PICKUP (needs slight adjustment) <input type="checkbox"/> 20-GE #NE-2 TUBES \$1
Neon Glow Lamp for 101 uses <input type="checkbox"/> 50-G.E. FLASHLIGHT BULBS \$1
#PR-9, 2.7 volts..... <input type="checkbox"/> BATTERY CHARGER 9-VOLT \$1
incl trans chargeable battery... <input type="checkbox"/> 30-BALL POINT PENS \$1
retractable, assorted colors... <input type="checkbox"/> TOP BRAND 15" PM SPEAKER \$7
full range, 10 oz. ceramic.... <input type="checkbox"/> COMMODORE 5-TUBE RADIO \$5
AC-DC, complete ready to play <input type="checkbox"/> 6-TV ALIGNMENT TOOLS \$1 |
|---|--|--|--|

BROOKS RADIO & TV CORP., 84 Vesey St., Dept. A, New York 7, N. Y. TELEPHONE ORlandat 7-2359

The cabinet top is a satisfactory heat sink. The transistors are mounted with a Cinch-Jones Type 2W-1 or equivalent Workman or Motorola anodized wafer. Coat the wafer on both sides with silicone grease for improved heat transfer from the transistors to the chassis.

The power supply is a full-wave bridge giving 12 volts dc.—D. R. Ripani

Reverberation in a Car Radio

Add the Motorola Vibrasonic unit to a car radio and you have reverberation. At the heart of the two-transistor reverberation system is an input and an output transducer separated by a delay line made of two precision-wound springs. The input transducer receives the audio signal from the radio output and converts it into a mechanical rotary motion. This motion is transmitted via the springs, which introduce a specific delay, to the output transducer that converts the rotary motion back into an electronic signal. This delayed signal is then amplified and fed to the car's rear-seat speaker.

The diagram (right) shows the circuit. Audio from the auto radio is fed the Vibrasonic input through coupling transformer T. R1 protects the input transducer against overloads at high signal levels. R2 is the Vibrasonic level and rear seat speaker fader, con-

trolling the input to the system.

When R2 is at the center of its rotation, the audio signal is grounded. If the control is turned clockwise from this center position, the audio signal is fed to the delay line. Counterclockwise rotation feeds the audio through R3 and the output transducer to the amplifier, bypassing the delay circuit.—Warren Roy

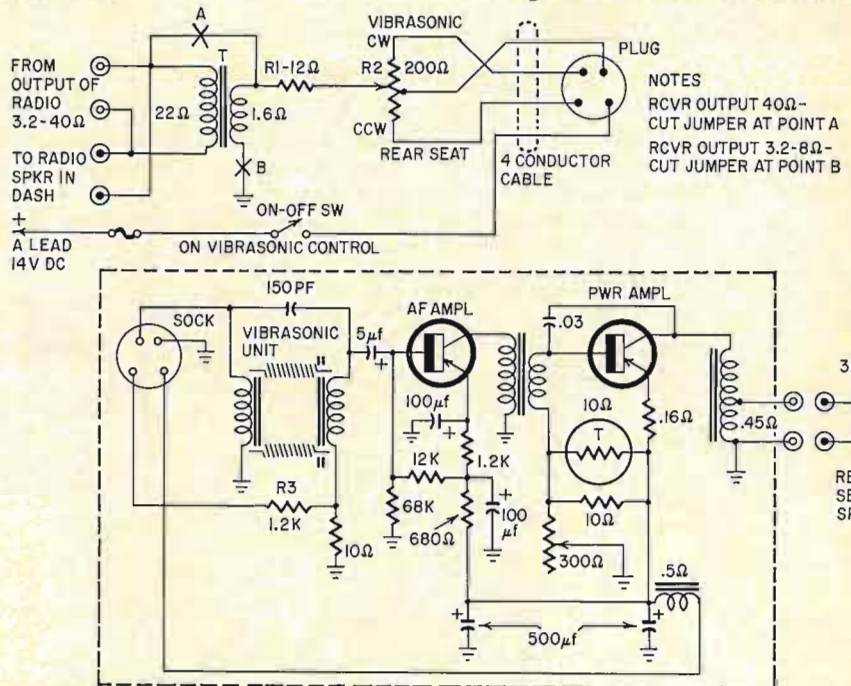

Heathkit Multiplex Adapter

Would you like to modify your Heathkit AC-11 FM multiplex adapter so the pilot carrier does not beat with the tape recorder's bias oscillator when recording a stereo broadcast? It's easy. You simply install a 19-kc filter in the adapter's output circuits.

Fig. 1 shows the cathode-follower

HOTTEST VALUE EVER OFFERED!

\$200 HEARING AID (as shown)—Your Price . . . \$2

We scoured the Market on 15000 of these HEARING AIDS from one of the Leading Manufacturers (name withheld) who switched to the Transistor Type. Each HEARING AID INSTRUMENT is a Complete AUDIO AMPLIFIER and includes—a CRYSTAL MICROPHONE, 3 SUB-MINIATURE TUBES and a Superb Beige Phenolic CABINET.

Indeed a TOP ITEM for the Experimenter—can be modified and converted to: RADIOS—INTERCOMS—TRANSMITTERS—SECRET LISTENING DEVICES—MICROPHONE for Tape Recorders—PRE-AMP & MICROPHONE COMBINATION for Public Address Systems—ETC.

5" x 2½" x 1"—Shipping Weight 1 lb.

Complete as illustrated—Including a detailed Informative SCHEMATIC DIAGRAM (less Earphone and Battery, etc.) **\$2**

SONOTONE EARPIECE for above.. \$3.95
SET OF BATTERIES for above..... 1.65
CONNECTING PLUGS for above.. 1.60

SONOTONE — EARPIECE, BATTERIES, ETC. comprise all accessories to complete above Unit (add \$2 if you want the HEARING AID) \$6.98

- | | | | |
|--|---|--|--|
| <input type="checkbox"/> WEBSTER #PT-1 MONAURAL CARTRIDGE in factory carton... \$1 | <input type="checkbox"/> 4-PNP TRANSISTORS general purpose, TO-5 case ... \$1 | <input type="checkbox"/> 1000—BLACK NICKEL SCREWS #6/40, ½" long, fillistor head \$1 | <input type="checkbox"/> WESTINGHOUSE TV TUNER 41mc, brand new (less tubes) \$1 |
| <input type="checkbox"/> WEBSTER #MC-3 MONAURAL CARTRIDGE in factory carton... \$1 | <input type="checkbox"/> 4-NPN TRANSISTORS general purpose, TO-5 case ... \$1 | <input type="checkbox"/> 50—100K ½ WATT RESIS-TORS 10% ... \$1 | <input type="checkbox"/> 10 — ASSORTED STANDARD TUNER VHF STRIPS ... \$1 |
| <input type="checkbox"/> WEBSTER #SC-3 STEREO CARTRIDGE in factory carton... \$1 | <input type="checkbox"/> POWER TRANSISTOR #DS-501 \$1 | <input type="checkbox"/> 50—470K ½ WATT RESIS-TORS 10% ... \$1 | <input type="checkbox"/> TV VERTICAL OUTPUT TRANS-FORMER 10 to 1 ratio ... \$1 |
| <input type="checkbox"/> 3 — \$2.50 SAPPHIRE NEEDLES guaranteed 5000 playings ... \$1 | <input type="checkbox"/> 3—STANDARD 12AT6 TUBES \$1 | <input type="checkbox"/> 30—MICAMOLD ASST TUBU-LAR COND. molded steatite .. \$1 | <input type="checkbox"/> 2—RATIO DETECTOR COILS 4.5mc or 10.7mc ... \$1 |
| <input type="checkbox"/> \$15 RADIO PARTS "JACKPOT" CHASSIS PAN, CONDENSERS, VARIABLE CONTROLS, RESISTORS, MISC. PARTS ... \$1 | <input type="checkbox"/> 3—AUDIO OUTPUT TRANS-FORMERS 3Q4 3Q5, 3S4 ... \$1 | <input type="checkbox"/> 5—½ MEG VOLUME CON-TROLS less switch ... \$1 | <input type="checkbox"/> 2TV SOUND I. F. COILS 4.5 mc or 21.25 mc ... \$1 |
| <input type="checkbox"/> 2—SAPPHIRE STYLUS NEEDLES for all type pickups ... \$1 | <input type="checkbox"/> 3—PUSHPULL AUDIO OUTPUT TRANSFORMERS 50L6 ... \$1 | <input type="checkbox"/> 10—DUAL CONTROLS 350-1 meg, long shaft, 101 uses \$1 | <input type="checkbox"/> 2—SOUND DISCRIMINATOR COILS 4.5mc or 10.7mc ... \$1 |
| <input type="checkbox"/> RONETTE DUAL SAPPHIRE CARTRIDGE flipover type ... \$1 | <input type="checkbox"/> 3½" TWEETER SPEAKER deluxe type for HI-FI ... \$1 | <input type="checkbox"/> 5 — WIREWOUND CONTROLS 2500 ohms, 4 watt ... \$1 | <input type="checkbox"/> 2—SYLVANIA EPOXY SILLI-CON RECTIFIERS 750ma-400 piv \$1 |
| <input type="checkbox"/> 5—SYLVANIA 6AK4 TUBES ... \$1 | <input type="checkbox"/> \$9 TRIM HEADPHONES 8Ω \$2 | <input type="checkbox"/> 5 — 50K VOLUME CONTROLS long shaft ... \$1 | <input type="checkbox"/> 2—SELENIUM RECTIFIERS 1-65ma and 1-450ma ... \$1 |
| <input type="checkbox"/> 5—MOTOROLA 12BL6 TUBES \$1 | <input type="checkbox"/> STANDARD 41mc TV TUNER Complete with Tubes, schematic for installation, long shaft ... \$9 | <input type="checkbox"/> 50—ASST. RADIO KNOBS all selected popular types ... \$1 | <input type="checkbox"/> 25—ASSORTED MICA TRIM-MER CONDENSERS ... \$1 |
| <input type="checkbox"/> 3—LOOPSTICK ANTENNAS hi-gain, ferrite, adjustable ... \$1 | | | <input type="checkbox"/> 6 — NICHROME HEATING COILS 1000 watts ... \$1 |

BROOKS RADIO & TV CORP., 84 Vesey St., Dept. A, New York 7, N.Y. TELEPHONE Cortlandt 7-2359

DELUXE STEEL CABINET

Solves the problem of keeping parts orderly. Joy of using it—See-thru Lucite drawers—and capacity make it worth its weight in gold. #18HB 18 Drawers.



2 ADJUSTABLE PLUS PLASTIC BOXES
1¼" x 8¾" x 5⅞"
ALL 3 FOR \$4.99
9" x 10" x 6"
Wt. 7 lbs.



PORTABLE PHONE JACK & PLUG SET
Complete SET incl. 50' extension wire & instructions ... **\$3.98**

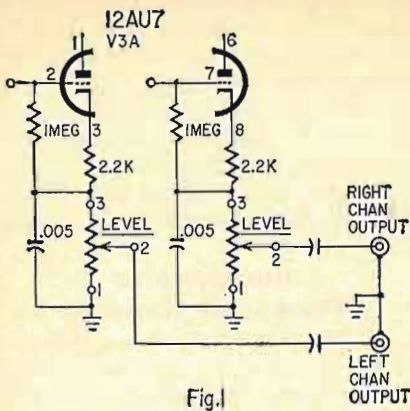

Fig. 1

output stages in the AC-11. Fig. 2 shows one of the output stages with the 19-kc filter added.

Order two Heathkit No. 45-48 19-kc coils. Connect a coil and 200-pf

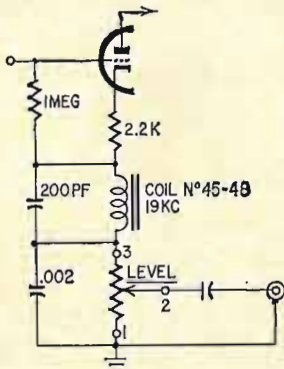

Fig. 2

capacitor in parallel between the bottom end of each 2,200-ohm cathode bias resistor and lug 3 on the output level control as in Fig. 2. Replace the .005- μ f capacitors across the level controls with .002- μ f ceramics.

Caution: Mount the coils horizontally so they won't pick up hum from the power transformer. Insulate all leads and keep them as short as possible.—
P. D. Ross END

50 Years Ago In Gernsback Publications

HUGO GERNSBACK, Founder

Modern Electrics	1908
Wireless Association of America	1908
Electrical Experimenter	1913
Radio News	1919
Science & Invention	1920
Practical Electrics	1921
Television	1927
Radio-Craft	1929
Short-Wave Craft	1930
Television News	1931

Some larger libraries still have copies of Modern Electrics and the Electrical Experimenter on file for interested readers.

In November, 1913, *Electrical Experimenter*

Experimental Radiophone Arc Set, by H. Winfield Secor.

Coharer Receiving Sets, by Henry Scott.

New French Wireless Apparatus, by H. Gernsback.

Great Lakes Wireless.

How to Make an Interference Preventer, by Eugene Dynner.

Coharer Receiving Set.

FREE

NEW 1964 GIANT CATALOG

BURSTEIN-APPLEBEE CO. Dept. RE,
1012-14 McGee St., Kansas City 6, Mo.

Rush me the FREE 1964 B-A Catalog.

NAME _____

ADDRESS _____

CITY _____ STATE _____

RUSH COUPON TODAY

FOR 37 YEARS THE
OUTSTANDING
**MONEY
SAVING**

BUYING GUIDE FOR:

- Stereo & Hi-Fi Systems and Components
- Tape Recorders
- Electronic Parts, Tubes, Books
- Phonos & Records
- Ham Gear
- Test Instruments and Kits
- Cameras and Film
- Public Address
- Citizens Band
- Transistor & FM-AM Radios.

MERCURY TV TUNER SERVICE

890-2 River Ave., Bronx 51, N.Y.

"Largest in the East"

VHF-UHF TUNERS

1 Year Warranty
Price Includes All Parts Except Tubes

ALL MAKES ONE PRICE!

\$9.50

When Shipping Tuner: Include Tubes, Shields and Damaged Parts.
Give Model Number and State Complaint

PACK WELL AND INSURE
24 HOURS ON POPULAR TYPES

try **This one**



Coupler for Phono Pin Plugs

Two cords with phono pin plugs can be quickly and easily joined together with this shielded adapter.

You will need a 1-inch length of brass, copper or iron pipe (inside diameter at least 1/4-inch), and an outside diameter of about 3/8-inch. (I used a 1-inch length of threaded brass nipple, known to electricians as "1/8 pipe nipple" and sold at most electrical supply counters.) You will also need two single-hole-mounting phono pin jacks (imported units sell for as little as 8¢ each).

Assemble the coupler as shown in the photo.

Top: Cut a 1 1/8-inch length of flexible insulated wire and solder one end to the center lug of the left-hand jack.

Then solder the jack securely into the end of the brass tube. Solder the other end of the wire to the center lug of the right-hand jack and solder the jack into the remaining end of the tube. The soldering is not difficult—simply run a little solder all around the ends of the tube where the jacks join the tube.

Center: The coupler ready for use.

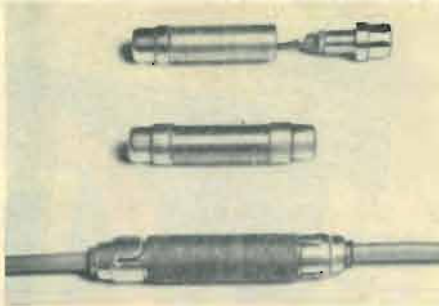

Bottom: The coupler barrel is wrapped with tape to improve its appearance. Two cords with phono plugs are shown plugged into the coupler.—*Art Trauffer*

Jumper for Series-String Sets

When you troubleshoot, say, a video i.f. in a series-heater set by bypassing the stage with a capacitor, you have to remove the tube. This of course kills the heaters.

To get around this dilemma, find a defective 7-pin miniature tube with a

good heater, and cut off all but the heater pins (3 and 4). Replace the pulled tube with this dummy to complete the heater circuit.

Be sure that the heater rating of the dummy is the same as that of the tube you're replacing. In fact, why not accumulate a set of dummies for this kind of troubleshooting?—*E. L. Deschambault*

Inexpensive Photocell Housing

The transparent plastic bubble in which experimenter type International Rectifier Corp. photocells are sold makes an excellent dome enclosure for uncased cells such as the B2M selenium unit and thin-wafer silicon cells. This bubble is almost hemispherical, 2 inches in diameter and 1/2 inch high. It has a flat 1/8-inch lip around its base.

Using a razor blade, carefully re-



move the bubble from the card to which it is glued. Then mount your cell on a 2-inch diameter disc of thin plastic. (Wafer cells may be cemented to the disc; the B2M requires a short 6-32

ZIP stands for the Post Office Department's new Zoning Improvement Plan. When renewing your RADIO-ELECTRONICS subscription, or sending us a change of address, please let us know what your ZIP Code is. We'll add it to your address mailing plate . . . and you'll get speedier delivery service from the Post Office. By the way, when writing to us, address: RADIO-ELECTRONICS, 154 West 14th St., New York, N. Y. 10011.

ELECTRONICS

Engineering-Technicians

Bachelor of Science Degree, 30 Months
Save Two Years' Time

- Radio-Television Plus Color Technician (12 Months)
- Electronics Engineering Technology (15 Months)
- Electronics Engineering (B.S. Degree)
 - Electrical Engineering (B.S. Degree)
 - Mechanical Engineering (B.S. Degree)
 - Civil Engineering (B.S. Degree)
 - Architecture (B.S. Degree) (36 Months)

Approved for Veterans
DAY AND EVENING CLASSES

Write for Catalog and Registration Application.
New Term Starting Soon.

Your Name

Address

City

State

The Nation's increased demand for Engineers,

Electronic Technicians, Radio TV Technicians is at an all time high. Heald Graduates are in demand for Preferred High Paying Salaries. Train now for a lucrative satisfying lifetime career.

HEALD'S

ENGINEERING COLLEGE
Est. 1863—100 Years
Van Ness at Post, RE
San Francisco, Calif.

Pay-TV Accepted in Hartford

Hartford, Conn.—Local residents have apparently accepted subscription TV as another entertainment medium, according to *Home Furnishings Daily*.

For more than 2,000 homes in the Greater Hartford area such programs are regular fare, and they pay about \$6 a month to watch them.

Hartford launched pay-TV over uhf channel 18 late last year after FCC authorization to conduct a 3-year experiment to test pay-TV's feasibility.

New installations of the Zenith decoders are being made at the rate of about 75 per week, and station operators are reported as "very pleased." Installation costs \$10, and after the first 3 months (which are rent-free) a weekly rental of 75¢ goes into effect.

Beyond that, clients pay only for what they watch. Rates vary from 25¢ to \$3 per program, with the average about \$1 to \$1.50. The station offers 30 hours free and 30 hours pay TV a week. Credit is given toward rental charges, based on the number of pay programs watched. Programs now consist chiefly of new movies and live sports events.

Service technicians and TV dealers in Hartford appear to be reacting favorably to the new service, HFD reported.

RADIO-ELECTRONICS

ANYONE can build a professional FM stereo tuner with a new Scott Kit



Scott's Chief Kit Engineer, Gaylord Russell, watches while one of 100 novices builds a pre-production sample of a new Stereo Tuner Kit. The unique alignment procedure uses the indicator on the tuner itself, permitting laboratory-accurate results and pinpoint alignment. Even at the hands of a novice, every tuner kit will meet or exceed published specifications.

Scott's exciting new kit building techniques make it possible for anyone to build a high-quality FM Stereo Tuner. Special alignment procedures make it possible to obtain high sensitivity without the need for expensive test equipment. A major innovation is the full-color instruction book, showing each part and wire in exact size and color. Two tuner kits are available. The LT-110, at \$164.95 features sensitivity of 2.2 microvolts, pre-wired multiplex section and famous Sonic Monitor. The economical LT-111 at \$119.95, with sensitivity of 3.5 μ v, uses new compactron tubes for ease of assembly. There are 5 additional kits available from Scott. Prices start at \$99.95. Prices slightly higher West of Rockies.

H. H. SCOTT INC.
111 Powdermill Road
Maynard, Mass. Dept. 570-11

Rush me your authoritative free Stereo Component Guide as soon as it comes off the press.

Name _____
Address _____
City _____ Zone _____ State _____



H. H. Scott, Inc., 111 Powdermill Rd., Maynard, Mass. Export: Morhan Exporting Corp., 458 Broadway, N.Y.C. Canada: Atlas Radio Corp., 50 Wingold Ave., Toronto

screw passed through its bracket hole and a hole drilled in the disc.) Two $\frac{3}{4}$ -inch 6-32 screws passed through the disc serve as terminals, to which the cell pigtailed are connected internally, and also as mounting screws. Fiber washers will insulate them if the assembled unit is mounted on a metal panel. Finally, fasten the bubble to the disc with a thin layer of cement or glue applied to the lip of the bubble. This construction is shown in the photograph.

Several small cells may be enclosed in one dome and wired together to form a solar battery.—Rufus P. Turner

Rotating Rat-tail Is Reamer

For reaming out small holes in chassis and more particularly for speedily shaping an odd-sized or irregular hole in metal components, few tools will work as fast or as well as a 2-inch piece broken off a fine-toothed rat-tail file chucked in an electric drill.—Henry Josephs, Sr.

Solder Antenna Hardware

Many antenna components are held together with aluminum studs riveted in and threaded on the ends to hold the terminal nuts and washers for the lead-in.

After such antennas have been in service for a while, exposure to the weather causes the studs or nuts to

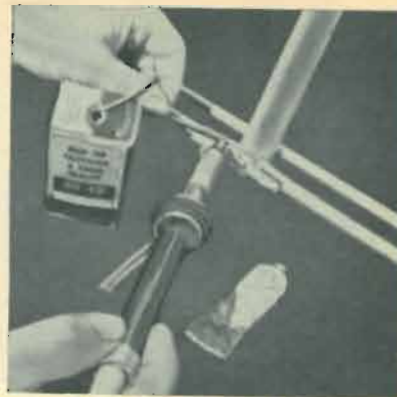

loosen. Then, when you try to get the terminal nuts off, or tighten them, the entire stud turns and makes the job hard.

To prevent this, before we ever use the antenna component, we tin the aluminum of the stud and the adjacent areas, and solder it fast. (Using Al-Met flux and multicore solder, a soldering iron puts solder on aluminum just as easily as if it were copper.)

That way the stud stays fixed throughout the life of the antenna.—Harry J. Miller.

Bench Tape Recorder for Case Histories

A small tape recorder kept within easy reach on the service bench is great for making "mental notes" while serv-

HIGH SCHOOL "GRADS"

You don't need college to have a fascinating job, a bright future, big pay and advancement.



Those who don't know the facts say that only the college trained men get the good jobs in industry. Wrong! But it is true that the average high-school graduate gets only the poorest kind of job—unless he has additional training in a specialized field.

For these men the biggest and fastest growing field open today is Electronics—all branches. Jobs are looking for men. You can train in as short a time as 85 weeks in the Electronic Labs of Coyne in Chicago, the Electronics Center of the Country. Most of your tuition can be paid after you graduate.

Like the great universities, Coyne School is an educational institution not for profit. A Coyne diploma gives you high standing with employers. Coyne graduates hold top jobs in Electronics all over the world.

See how little it costs to get the training you need. Don't put it off. Make your own decision. Send us your name, address now—this coupon or a postcard will do. No salesman will bother you at your home. All information is FREE.

Coyne Electrical School, Chicago 7, Ill., Dept. 83-N

Coyne Electrical School, Dept. 83-N
1501 W. Congress Pkwy., Chicago 7, Ill.

Please send Free Book "Your Opportunities in Electronics." I am under no obligation—no salesman will call at my home.

Name _____ Phone _____
Address _____ Age _____
City _____ RR No. or Zone _____ State _____



INSIST ON
"No Noise"

- VOLUME CONTROL and Contact Restorer
- TUNER-TONIC for ALL tuners including wafer type
- FORMULA EC-44 for ALL electrical contacts

FREE with ALL No-Noise Products
5" Plastic Extender Push-button Assembly for pin-point applications. Does not cause shorts!

14 Years of Recognized Leadership

ELECTRONIC CHEMICAL CORP.
813 Communipaw Ave., Jersey City 4, N. J.

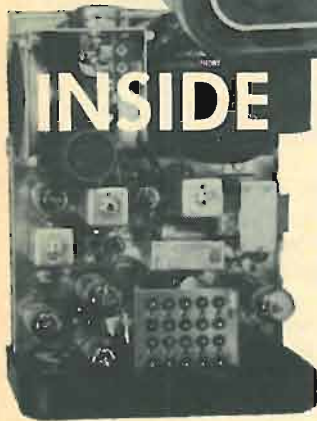

INSIDE AND OUT

General's rugged, dependable VS-2 is the World's most practical and economical 2-way radiotelephone. Features: Heavy talk power, 15 watt construction,* transistorized mobile power supply, rugged 18 guage chassis, electronic relays.....\$139.95.

* Under present rules part 19.32 the FCC does not provide for more than 5 (five) watt input in the Citizens Radio Service (26.965-27.255 MC Band).

10% DOWN - EASY PAYMENTS!
See your local General Dealer TODAY or write: Dept. 5,

GENERAL RADIOTELEPHONE COMPANY
3501 West Burbank Boulevard, Burbank, California
Phone: 849-6891 Area Code: 213



icing, preserving case-history information, recording symptomatic noises for later comparison, and such uses. Better than notes: tape won't blow away or get coffee spilled on it!—*Harold Davis*

Rod Cleans Solder Holes

You can make a printed circuit service aid by taking a small aluminum rod and grinding down one end to a fine point. Use it to clean holes of solder after removing a defective part and before the new part is replaced. Insert the tapered end into the circuit as soon as the solder is liquefied and hold it there until the solder cools. Since the solder will not stick to the aluminum, this leaves a clean opening.—*L. S. Kroll*

Cure for Cord Tangles

The radio-TV and electronic hobbyist and service technician has always been plagued by tangles in power cords. If microphones and telephones can have coil cords, why not other types of electronic equipment? There's no sense wasting hours untangling cords when a few minutes and dollars spent on coil cords bought from your electronic parts catalog will rid you of the trouble forever. (Allied catalog No. 50N938, price 83¢—6 feet long, 10 amperes capacity.)—*John A. Comstock*

END

CORNELL

33¢ PER TUBE

100 TUBES OR MORE:
30¢ PER TUBE

TUBES

1 YR. GUARANTEED

Mutual Conductance Lab tested, Individually Boxed, Branded and Code Dated

OZ4	6AU4	6CZ5	6SH7	786	12BL6
1B3	6AU5	6D6	6SJ7	787	12BY7
1H5	6AU6	6DA4	6SK7	788	12C5
1L4	6AV6	6DE6	6SL7	7C5	12CA5
1T4	6AW8	6DQ6	6SN7	7Y4	12DQ6
1U4	6AX4	6EM5	6S07	12AD6	12SN7
1X2	6BA6	6F6	6SR7	12AE6	12SQ7
2A5	6BC5				25L6
3CB6	6BD6				25Z6
5U4	6BG6				35W4
5V4	6BH6				35Z3
5Y3	6BJ6				35Z5
5Z3	6BL7				50A5
6A6	6BN4				50L6
6A8	6BN6				24
6AB4	6BQ6	6H6	6U7	12AF6	27
6AC7	6BZ6	6J5	6U8	12AT7	41
6AG5		6J6	6V6	12AU7	45
6AL5	6CB6	6K7	6W4	12AX7	47
6AN8	6CD6	6L6	6W6	12BA6	75
6AQ5	6CF6	6Q7	6X4	12BD6	77
6AS5	6CG7	6S4	6X5	12BE6	78
6AT6	6CG8	6SA7	7A7	12BF6	80
6AT8	6CM7	6SC7	7A8	12BH7	84/6Z4

If not shipped in 24 hrs
YOUR ORDER FREE!

Special!
With every \$10 Order
25¢ per tube
(No Limit) from this list.

Other tubes and CRT's at low prices... send for free list

LIVE IN THE EAST?
WAITED MONTHS FOR DELIVERY FROM OTHERS?
AIR MAIL AN ORDER TO CORNELL
AND RECEIVE DELIVERY TO THE EAST COAST
IN AS LITTLE AS 72 HOURS!!!

NO SUBSTITUTIONS WITHOUT YOUR PERMISSION
Tubes are new, seconds or used and so marked.

TERMS: FREE POSTAGE ON PREPAID USA ORDERS. Under \$5.00 add 50¢ for handling. Send 25% deposit on COD orders. No Canadian or foreign COD's—include postage. No 24 Hr. Free Offer on personal check orders. 5-DAY MONEY BACK OFFER!

CORNELL ELECTRONICS CO.
Dept. RE11 4217 University Ave., San Diego 5, Calif. • Phone: AT 1-9792



The Serviceman's
Always
Right...
When He Uses
QUIETROLE

The happiest customers are serviced by repairmen who use Quietrole... the amazing lubricant that so effectively silences pesky, noisy controls and switches on radios, TV sets and electronic instruments. If you want to leave your customers smiling, you'll do what good servicemen do everywhere...
USE QUIETROLE!



Now, with FREE EXTENDER TUBE for aerosol can to easily reach the most remote places. The best distributors everywhere are pleased to sell QUIETROLE! IN SPRAY CANS or 2, 4, 8 oz. BOTTLES

manufactured by
QUIETROLE
COMPANY

Spartanburg, South Carolina
In Canada: CROSS CANADA ELECTRONICS
12 Laurel Street, Waterloo, Ontario

HIGH FIDELITY

Buy,
Sell,
Find Out

You'll get good results if you advertise in

RADIO-ELECTRONICS

Classified Ads.
154 West
14th Street,
New York
11, N. Y.

new Patents

Low-Noise Amplifier

PATENT No. 2,979,668

William Crawford Dunlap, Jr., Birmingham, Mich.
(Assigned to Bendix Corp.)

At extremely low temperatures, germanium is an insulator. Placed in a magnetic field and biased by dc, the semiconductor begins to pass current. Doping the semiconductor unevenly makes some parts begin to conduct before others, and the transition from insulator to conductor occurs gradually.

The 200-volt dc power supply biases the semi-

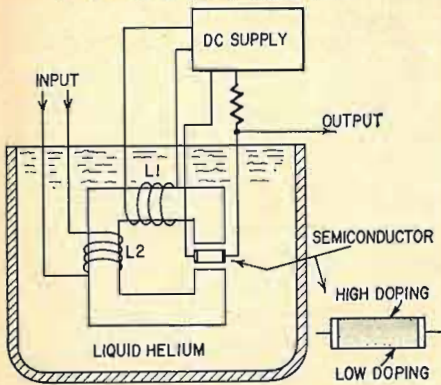

conductor and also passes current through L1 to create a magnetic field. This field is modulated by signal flow through L2. Magnetic core and semiconductor are immersed in liquid helium (4° K).

Varying the effective field at the semiconductor changes its resistance, producing corresponding changes in the output voltage.

Signal Identification

PATENT No. 3,092,732

Richard E. Milford, Glendale, Ariz.
(Assigned to General Electric Co.)

This circuit determines which of several signals is the most positive. Only two signals are shown here, but as many as 14 or more may be applied, each to its own stage. Signals may vary between -5 and 6 volts, for example. Normally the gate conducts, so 6 volts appears at lead A to block each signal stage.

To identify the desired signal, a positive pulse is impressed to block the gate. Then -14 volts appears at A.

Now consider a most-positive signal, S, ap-

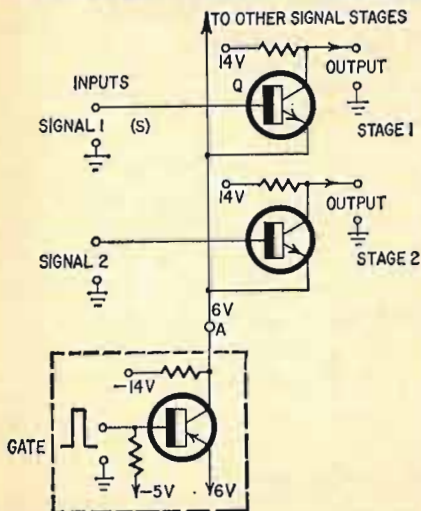

NO COMPETITORS

Nobody else but **EMC** designs in so much value



Compact, light-weight portability. Use it on the bench or in the field.

Full-view meter gives direct, clear-cut quality indications.

Full complement of sturdy sockets accepts compactron (12-pin), nuvistor, novar, 10-pin, 9-pin, octal, loctal, and miniature tubes.

Three heavy-duty controls for quick set-up of all tests. Check a fistful of tubes in the time it often takes to test one.

Precise programming. Only one socket per tube-base configuration prevents accidental plug-in.

12 slide switches for individual selection of tube pins provides versatility in testing, prevents obsolescence.

Tube Tester Model 213

THE MODEL 213 saves you time, energy, money ■ Checks for shorts, leakage, intermittents, and quality ■ Tests all tube types including magic eye, regulator, and hi-fi tubes ■ Checks each section of multi-purpose tubes separately ■ Gives long, trouble-free life through heavy-duty components, including permanently etched panel ■ Keeps you up to date with FREE, periodic listings on new tubes as they come out ■ Your best dollar value in a tube tester. Available in high-impact bakelite case with strap: \$28.90 wired; \$18.90 in kit form. Wood carrying case (illustrated) slightly higher.

EMC

ELECTRONIC MEASUREMENTS CORPORATION
625 Broadway, New York 12, New York
Export: Pan-Mar Corp., 1270 B'way, N. Y. 1, N. Y.

EMC, 625 Broadway, New York 12, N.Y.

Rush me FREE catalog describing all EMC value-loaded test instruments and name of local distributor.

NAME _____
ADDRESS _____
CITY _____ ZONE _____ STATE _____

RE 11

PROFESSIONAL technicians

use *Dave Rice's* OFFICIAL ORDER BOOKS for every TV-RADIO service call



This is the businesslike approach to service record keeping. Triplicate forms serve as order form, invoice and office record, with spaces for complete information on every job. Separate listings for receiving tubes, six tube, parts, serial numbers, labor and tax charges, signatures, etc. 75c a book, \$6.50 for dust-proof box of 10. In stock at your distributor.

FREE

Write for your free folder describing Dave Rice's OFFICIAL ORDER BOOKS, including an actual size sample copy of the handy order form.

ELECTRONIC PUBLISHING CO., INC.
133 N. JEFFERSON ST.
CHICAGO 6, ILLINOIS



Fill in coupon for a FREE One Year Subscription to OLSON ELECTRONICS Fantastic Bargain Packed Catalog—Unheard of LOW, LOW, DISCOUNT PRICES on Brand Name Speakers, Changers, Tubes, Tools, Stereo Amps, Tuners, CB, Hi-Fi's, and thousands of other Electronic Bargains. Credit plan available.

NAME _____
ADDRESS _____
CITY _____ ZONE _____ STATE _____

If you have a friend interested in electronics send his name and address for a FREE subscription also.

OLSON ELECTRONICS, INC.

741 Forge Street, Akron, Ohio 44308

plied to a transistor, Q. Base-emitter voltage is nearly zero, so S appears at all emitters. Since S is more positive than any other signal, it blocks every transistor but Q. Only Q generates a negative output pulse to identify itself.

Instant Monitoring

PATENT No. 2,969,529

Paul R. Gilson, West Covina, Calif. (Assigned to Burroughs Corp., Detroit)

In magnetic data processing, it is desirable to be able to check a recording immediately. This can be done if the read (playback) and write

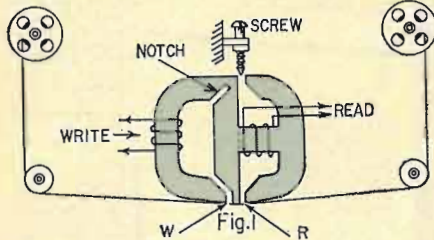

(recording) heads are near each other, so that the output may be compared with the input. However, when the heads are too close, undesirable magnetic coupling may result.

Fig. 1 shows a special core design that permits the heads to be within .05 inch of each other without coupling. W and R are the fixed gaps of the write and read heads, respectively. The notch is also a fixed magnetic gap. The upper-right gap is adjustable with a screw.

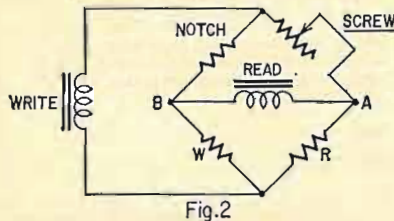

The core is actually a magnetic bridge that may be redrawn (Fig. 2) in the form of the more familiar electrical bridge. Reluctance is drawn as resistance, magnetomotive force as voltage. When the variable arm is adjusted for balance (the gap screw), the flux (current) through the bridge paths are such that no mmf (magnetomotive force - voltage, in this analogy) can appear across the read coil.

Since the write coil cannot affect the read coil, the only output from the latter will be from the tape.

Glide-Path Indicator

PATENT No. 3,049,667

Samuel L. Broadhead, Jr., Cedar Rapids, Iowa, and Arthur L. Kemper, Marion, Iowa. (Assigned to Collins Radio Co., Cedar Rapids)

This guidance system depends upon two tones: 90 and 150 cycles. An airplane pilot knows his exact position in flight from the relative strength

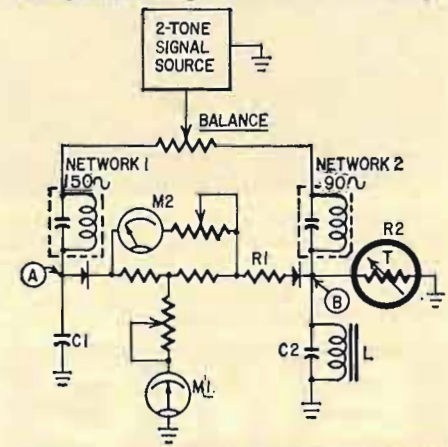

of these frequencies. Network 1 is inductive below 150 cycles, and C1 is added to resonate it to 90 cycles. Network 2 is capacitive above 90 cycles, and L is added to resonate it to 150 cycles. The

signal is essentially 90 cycles at A, and 150 cycles at B.

The rectified signals flow through M1 in opposite directions. This meter has a zero center, so its deflection shows which tone predominates and by how much. M2 is a voltmeter with a colored flag which shows only if the signal strength is high enough for reliable operation.

Thermistor R2 stabilizes the circuit. C2 is an rf bypass. R1 compensates for the nonlinearity of iron-core conductor L. END

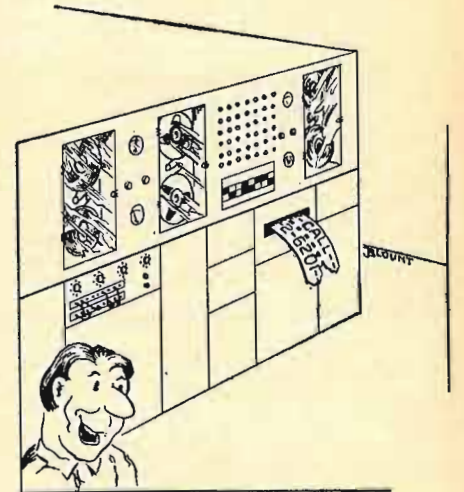

"Can't be too much wrong, Pete. It picked your shop."

RADIO-ELECTRONICS can use original puzzles: service stinkers, engineering problems or unique electronics brain-twisters are welcome so long as they are original and don't need a half-column of math to solve. We will pay \$10 for each—more for really hot ones.

GREGORY ELECTRONICS

SPECIAL PURCHASE

We bought a large quantity of 2-way radio units from a state police network and now pass huge savings on to you!



LINK 6000 NW SERIES

25-50mc 20F3 Emission Fully narrow banded (Tx and Rx), 12 volt, 50 watt. Complete with all accessories, less crystals and antenna.

\$168.00

Add \$40 for crystals, tuning and brand new antenna—ready to go on your frequency.



MOTOROLA

450-470 mc

T44A1, 12 volts, complete with all accessories, less crystals and antenna.

\$100

Same unit less accessories.	\$ 70
T44A6, 6/12 volts, complete with all accessories, less crystals and antenna.	\$125
Same unit less accessories.	\$ 95
T44A64, 6/12 volts, complete with all accessories, less crystals and antenna.	\$155
Same unit less accessories.	\$125

Tremendous Selections and Savings!

Guaranteed Reconditioned FM 2-Way Mobile Radios

G-E, RCA, Motorola and Others! Low, High and UHF Bands.

WE BUY FOR CASH!

Late model 2-way radio equipment. State price, condition and quality.



Write for New Fall-Winter 1963 Catalog

GREGORY ELECTRONICS CORPORATION

249 Rt. 46 • Phone 773-7550 • Saddle Brook, N. J.

ELECTRONIC TECHNICIANS

STATESIDE & OVERSEAS POSITIONS

Openings for men trained or experienced in military electronics to maintain or instruct in the following:

COMMUNICATIONS

RADAR

COMPUTERS

Let us review YOUR BACKGROUND NOW so that we may arrange for a personal interview with you in or near your home city. Save time and S-P-E-E-D your answer. Fill in the coupon below and mail to:

PHILCO TECHREP DIVISION

A Subsidiary of Ford Motor Company

P.O. BOX 4730—PHILADELPHIA 34, PA.

Please Mail This Coupon To The Above Address
c/o Department 804

MY NAME IS

ADDRESS

CITY PHONE.....

Discharge Rate or Rank

Branch of Service

Military or Commercial Electronic Exp.

Educational Background

An Equal Opportunity Employer

TUNE UP ELECTRONICALLY ANY CAR EVER MADE...

domestic or foreign; compact or limousine; 4 cylinder, 6 cylinder or 8 cylinder; 6 volt or 12 volt.

With New Improved Model AT-162

DWELL TACHOMETER

NOTE:
GIANT 6 1/2" METER FOR EASY, ACCURATE READINGS



Specifications

The Model AT-162 provides three dwell angle scales; 0 to 45 degrees, 0 to 60 degrees, and 0 to 90 degrees. The three dwell angle ranges specified above make this instrument suitable for making accurate dwell angle adjustments on all 4 cylinder, 6 cylinder, and 8 cylinder cars, both foreign and domestic.

The dual range tachometer is extremely versatile since it provides both a low range of 0 to 1000 RPM, necessary for making precise carburetor adjustments and the high range tachometer, 0 to 5000 RPM suitable for making all other tests at high engine speeds.

At last a streamlined instrument designed to provide the most important services for "tuning up" any and every car ever made from a Model A Ford up to and including the current automatic transmission cars produced today.

The Model AT-162 includes the very latest design Dwell Meter, working in conjunction with a dual range Tachometer and incorporating all modern improvements in circuitry design.

Assure easy starts, optimum performance and maximum gas economy with Model AT-162.

The Model AT-162 will perform the services specified below in addition to many other tasks too numerous to mention:

- Assure precise adjustments of points that are slightly worn or pitted.
- Indicate the most effective point setting without removing the distributor cap.
- Indicate the correct settings for external adjustment type distributors. (A feeler gauge cannot be used for making correct adjustments on this type of distributor since many manufacturers' specifications do not list the point gap in inches. They list only the dwell angle in degrees.)
- Insure maximum gas economy and quiet engine running. Read the exact RPM while the engine is in neutral position. Then adjust the carburetor in conformity with the car manufacturer's recommendations.
- To locate a "miss" you need only disconnect or "short" the spark plugs one at a time with the Model AT-162 switched to the Tachometer position.
- Cars with automatic transmissions function efficiently only if the fluid pressures are correctly maintained and since manufacturer's instructions always refer to RPM, the Model AT-162 (or an equivalent tachometer) is required to properly service automatic transmissions.

The Model AT-162 is the most complete unit in its price range ever produced. It comes absolutely complete, ready to use. Only

\$29⁹⁵

SEND NO MONEY WITH ORDER PAY POSTMAN NOTHING ON DELIVERY

Try it for 10 days before you buy. If completely satisfied then send \$5.00 and pay the balance at the rate of \$5.00 per month until the total price of \$29.95 (plus small P.P. and budget charge) is paid. If not completely satisfied, return to us, no explanation necessary.

ACCURATE INSTRUMENT CO., INC.
Dept. D-304, 911 Faile St., Bronx 59, N.Y.

Please rush me one Model AT-162. If satisfactory I agree to pay \$5.00 within 10 days and balance at rate of \$5.00 per month until total price of \$29.95 (plus small P.P. and budget charge) is paid. If not satisfactory, I may return for cancellation of account.

Name _____

Address _____

City _____ Zone _____ State _____



Classified Ads

Rates—55¢ per word . . . minimum 10 words. Payment must accompany all ads except those placed by accredited advertising agencies. Misleading or objectionable ads not accepted. Copy for January issue must reach us before November 14th. Figure one word: name of city (New York), name of state (New Jersey). Sets of characters as in key (741-RE), also abbreviations as 8x10 mm, A.C., D.C., C.O.D. Hyphenated words not normally considered such count as two words (Hi-Fi). ZONE NUMBER FREE. RADIO-ELECTRONICS, 154 West 14 St., New York, N. Y. 10011.

EDUCATION/INSTRUCTION

LEARN ELECTRONIC ORGAN SERVICING. New Home Study courses covering all makes electronic organ including transistors. Experimental kits—schematics—troubleshooting. Accredited NHSC-GI Approved. Write for free booklet. NILES BRYANT SCHOOL, 3631 Stockton Blvd., Dept. F. Sacramento 20, Calif.

MATHEMATICS. ELECTRONICS. Pay as you learn. Free brochure. INDIANA HOME STUDY INSTITUTE, P.O. Box 282, Saxonville, Mass.

LEARN WHILE ASLEEP. 92% effective. Build dynamic personality. Improve health. Motivate success. Details free. A.S.R. FOUNDATION, Box 70721RE, Henry Clay Sta., Lexington, Ky.

SLEEP LEARNING. Hypnotism! Tapes, records, books, equipment. Details, strange catalog FREE. RESEARCH ASSOCIATION, Box 24-RD, Olympia, Wash.

FCC LICENSE in 6 weeks. First Class Radio Telephone. Results Guaranteed. ELKINS RADIO SCHOOL, 2603E Inwood, Dallas, Tex.

LEARN ELECTRICITY, appliance repair in 32 compact lessons. WORLDWIDE INSTITUTE. Dept. 102, 2555 Shelley, Indiana, Penna.

FOR SALE

BUSINESS AIDS

10,000 CIRCULARS. \$39.00. Information and samples free. JASON, 2336 Orthodox, Philadelphia, Pa., 19137.

1,000 Business Cards, "Raised Letters" \$3.75 postpaid. Samples. ROUTH, RE11, 3910 Kipling, Greensboro, N. C.

General

JAPANESE MERCHANDISE from Radio to Camera. Any inquiries answered. Catalog, information and pricelist \$1.00. TOMIO UENO, No.538 Shibamatacho, Katushikaku, Tokyo.

FREE CATALOG—name-brand tubes 65% discount, phono needles 80% or more discount, phono cartridges, picture tubes 75¢ inch, parts, parts kits, silicon and selenium rectifiers, transmitting tubes, 7" TV test tube \$6.99, imported batteries, tube testers etc. Want to swap or sell tube inventory? Send us your offering. ARCTURUS ELECTRONICS CORP.—Dept. R.E., 502 22nd St., Union City, N. J.

TV SERVICE ORDER BOOKS for use with your rubber stamp. Duplicate or triplicate. Low cost. Write for FREE 32 PAGE CATALOG and Special Rubber Stamp Offer. OELRICH PUBLICATIONS, 6556 W. Higgins, Chicago, Ill. 60656.

BEFORE You Buy Receiving Tubes, Test Equipment, Hi-Fi Components, Kits, Parts, etc. . . . send for your Giant Free Zalytron Current Catalog, featuring all STANDARD BRAND TUBES all Brand New Premium Individually Boxed, One Year Guarantee—all at BIGGEST DISCOUNTS in America! We serve professional servicemen, hobbyists, experimenters, engineers, technicians. WHY PAY MORE? ZALYTRON TUBE CORP., 461 Jericho Turnpike, Mineola, N. Y.

1000 BUSINESS CARDS \$3.95. Rubber stamps \$1.00. Free Bargain List. ALCO, Box 244-R, Urbana, Ill.

BUY FROM FACTORIES! Appliances, cameras, watches, etc! Free details! CAM COMPANY, 436 Bloomfield Ave., Verona, N.J.

Canadians

GIANT SURPLUS BARGAIN PACKED CATALOGS. Electronics, Hi-Fi, Shortwave, Amateur, Citizens Radio, Rush \$1.00 (Refunded), ETCO, Box 741, Dept. R. Montreal 1, Can.

Electronics

CONVERT INEXPENSIVE BC-659 to CB with crystal filter, AVC, squelch bias, pi coupling. Conversion kit \$20.60—Plans only \$2.00. JAY'S CB SERVICE, PO Box 173, Citrus Heights, Calif.

PRECISION RESISTORS, carbon-deposit. Guaranteed 1% accuracy. Millions in stock. 1/2 watt 8¢. 1-watt, 12¢. 2-watt, 15¢. Leading manufacturers. ROCK DISTRIBUTING CO., 902 Corwin Rd., Rochester 10, N.Y.

TRANS-NITION Electronic Ignition parts kit, Negative ground \$25. Coil, Manual SPECIAL \$8.50. Manual \$2. ANDERSON ENGINEERING, Wrentham, Mass.

SAVE DOLLARS on radio, TV tubes, parts at less than manufacturer's cost. 100% guaranteed! No rebrand, pulls. Request Bargain Bulletin. UNITED RADIO, 1000-R, Newark, N. J.

PRINTED CIRCUIT BOARDS. Hams, Experimenters. Free catalog. P/M ELECTRONICS, Box 6288 Seattle, Wash. 98188.

GARAGE DOOR OPENERS \$60. Nationally advertised brands, highest quality. Finest radio controls \$45. Area dealerships available. DANIEL SEFTON, Whitehall #916, 4977 Bethesda, Md.

PROFESSIONAL ELECTRONICS PROJECTS—Organs, Timers, Computers, etc.—\$1 up. Catalog free. PARKS, Box 1665, Seattle, Wash. 98125.

CONVERT any television to sensitive, big-screen oscilloscope. Only minor changes required. No electronic experience necessary. Illustrated plans \$2. RELCO, Box 10563, Houston 18, Tex.

RADIO, TV components, testers, etc. Imported. UNITA, 545 Fifth, New York 17.

DIAGRAMS FOR REPAIRING RADIOS \$1.25. Television \$2.50. DIAGRAM SERVICE, Box 1151 RE, Manchester, Conn.

DIAGRAMS for TV. \$2.00; for radio, \$1.00. HIETT DIAGRAMS, 1307 Iturbide, Laredo, Tex.

VIDICON TV CAMERA KIT. Easily assembled with step-by-step instructions and pictorials. \$189.95. Free catalog. SEACOL ELECTRONICS, 507 East Olive Ave., Fresno 4, Calif.

IN SAN DIEGO, CALIF. your electronics parts discount house is ALPHA ELECTRONICS, 7077 University.

COIL WINDING METHODS Handbook—50¢. Experimenter's catalog 250 exclusive items—25¢, refundable. LABORATORIES, 1131-B Valota, Redwood City, Calif.

DIAGRAMS, service material. Radio, Television, \$1.00. SUPREME PUBLICATIONS, 1760 Balsam, Highland Park, Ill.

GOVERNMENT SURPLUS. Jeeps—\$223.83. Transmitters—\$6.18. Receivers—\$5.65. Typewriters—\$4.15. Oscilloscopes. Multimeters. Speakers, Walkie-Talkies. Typical Government Surplus Prices. Exciting details FREE. N.Y. ENTERPRISES, Box 402—F15, Jamaica, 30, N.Y.

BOOK. 200 ELECTRIC STUNTS. \$1.00 CUT-TRADO, 875 Arastradero, Palo Alto, Calif.

Audio—Hi-fi

HI-FI COMPONENTS, tape recorders at guaranteed "We Will Not Be Undersold" prices. All brands in stock. 15-day money-back guarantee. 2-year warranty. Write your requirements for quotation. No catalog. HI-FIDELITY CENTER, 1797D 1st Ave., New York 28, N.Y.

SALE ITEMS—tapes—recorders—component quotes. BAYLA, Box 131-RE, Wantagh, N. Y.

TAPE recorders, Hi-Fi components, Sleep-learning equipment, Tapes, Unusual values. Free catalog. DRESSNER, 1523 Jericho Turnpike, New Hyde Park 5, N.Y.

4/TR STEREO TAPES—bought, sold, rented, traded! Bargain closeouts! Catalog/COLUMBIA, 9651 Foxbury, Rivera, Calif.

WRITE FOR LOWEST QUOTATIONS. Components, Recorders, No Catalogs. HI-FIDELITY SUPPLY, 2817-SC Third, New York 55, N.Y.

MISCELLANEOUS

JUST STARTING IN TV SERVICE? Write for FREE 32 PAGE CATALOG of Service Order books, invoices, job tickets, phone message books, statements and file systems. OELRICH PUBLICATIONS, 6556 W. Higgins, Chicago, Ill. 60656.

ANTIQUÉ EDISON CYLINDER PHONOGRAPHS released from 50 years storage. All work. Complete. Concert Horn. Cylinders. Each—\$70. WHITLOCK'S STORAGE, 114 State, Brewer, Me.

SONGS INTO \$\$\$\$\$. New, unknown Songwriters, Songpoets, Composers share \$33 millions yearly. Any subject, we collaborate, publish, promote. Free appraisals, free samples, details. NORDYKE PUBLISHERS, 6000 Sunset, Hollywood, Calif. 29-90028.

PRINTING PRESSES. Type, Supplies. Lists 5¢. TURNBAUGH SERVICE, Mechanicsburg, Pa.

SERVICES

RAISED LETTER BUSINESS CARDS. \$3.95 per 1000. Samples. EDWARD PRINTING SERVICE, 7430 Selwick Drive, Parma 29, Ohio

ENGINEERING SERVICES. Equipment, invention, development. Research design. Inquiries held confidential. TODD CONSULTING ENGINEERS, 424 W. 119th, N.Y. 10027.

TV TUNERS REBUILT AND ALIGNED per Manufacturer's specifications. Only \$9.50. Guaranteed. We ship COD. VALLEY TUNERS, 5641-A Cahuenga, No. Hollywood, Calif.

METERS—MULTIMETERS REPAIRED and calibrated. BIGELOW ELECTRONICS, Box 71-B, Bluffton, Ohio.

TV TUNERS REBUILT AND ALIGNED Per manufacturer's specification. Only \$9.50. Any make UHF or VHF. We ship COD. 90-day written guarantee. Ship complete with tubes or write for free mailing kit and dealer brochure. J. W. ELECTRONICS, Box 51D, Bloomington, Ind.

TRANSISTORIZED products dealers catalog. \$1. INTERMARKET, CPO 1717, Tokyo, Japan.

SPEAKER RECONING. Satisfaction Guaranteed. C & M RECONO CO., 18 E. Trenton Ave., Morrisville, Pa.

ALL MAKES OF ELECTRICAL INSTRUMENTS AND TESTING equipment repaired. HAZELTON INSTRUMENT CO., 128 Liberty St., New York, N.Y.

WANTED

G-R, H-P, L&N, etc., Tubes, manuals, military electronics. ENGINEERING ASSOCIATES, 434 Patterson Road, Dayton 19, Ohio.

CASH PAID! Sell your surplus electronic tubes. Want unused, clean radio and TV receiving, transmitting, special purpose, Magnetrons, Klystrons, broadcast types, etc. Want military & commercial lab/test and communications equipment such as G.R., H.P. AN/UPM prefix. Also want commercial receivers and transmitters. For a fair deal write BARRY, 512 Broadway, New York 12, N.Y. WALKER 5-7000.

new Books



ABC'S OF BOOLEAN ALGEBRA, by Allan Lytel. Howard W. Sams & Co., Inc., 4300 W. 62 St., Indianapolis 6, Ind., 5 1/2 x 8 in. Paper, \$1.95.

Covers the subject of Boolean and switching algebra, with, however, too few actual examples in the electronics field.

RADIO ASTRONOMY, by Jean Louis Steinberg and James Lequeux. McGraw Hill Book Co., Inc., 330 W. 42 St., New York 36, N.Y. 6 x 9 in. 260 pp. Cloth, \$9.95.

Written by two European experts in the field. About one third of the book is devoted to electronic equipment for radio astronomy. Radio telescopes and interferometers each get a long chapter.

VECTOR AND PHASE ANALYSIS, by Alan Andrews. Howard W. Sams & Co., 4300 W. 62 St., Indianapolis 6, Ind. 5 1/2 x 8 1/2 in., 128 pp. Paper, \$2.95.

A self-study course on vectors as used for ac calculations, including practice examples and answers, and a table of trig functions.

ELECTRONICS CIRCUITS HANDBOOK, by Tom Kneitel, WB2AAI. Cowan Publishing Co., 300 W. 43 St., New York 36, N.Y. 6 x 9 in., 126 pp. Paper, \$3.00.

A compilation of useful schematics, construction hints and operating data on ham and CB equipment. Many items are unusual and hard to find elsewhere. Transmitters, receivers, test devices, noise limiters and frequency standards are included.

MODERN PHYSICS (2nd Edition), by Robert L. Sproull. John Wiley & Sons, Inc., 605 3rd Ave., New York 16, N. Y. 6 x 9 in., 630 pp. Cloth, \$9.75.

An advanced physics text, starting with fundamental particles, going through nuclei and atoms and wave-particle experiments to introductory quantum mechanics. A good deal of attention is given to electrical, thermal and magnetic properties of solids from the viewpoint of electronics.

TV SERVICING MADE EASY, by Wayne Lemons. Howard W. Sams & Co., Inc., 4300 W. 62 St., Indianapolis 6, Ind. 5 1/2 x 8 1/2 in., 160 pp. Paper, \$2.95.

Fast troubleshooting, service hints and test gadgets are described in practical language. Shows how to cut servicing time, particularly in the more complicated TV stages: horizontal sweep, high voltage, agc.

ESSENTIAL CHARACTERISTICS. Receiving Tube Dept., General Electric Co., Owensboro, Ky. 5 1/2 x 8 1/2 in., 302 pp. Paper, \$1.50

This spiral-bound manual has separate "strip" pages below the main pages, so that a tube's characteristics (main pages) may be consulted while viewing its basing diagram (in numerical order on "strip" pages). Pix tube and special tube listings, plate characteristics, useful schematics are included. END

SCHOOL DIRECTORY

ENGINEERING EDUCATION
for the Space Age

NORTHROP INSTITUTE of Technology is a privately endowed, nonprofit college of engineering offering a complete Bachelor of Science Degree Program and TWO-YEAR accredited technical institute curricula. Students from 50 states, many foreign countries. Outstandingly successful graduates employed in aeronautics, electronics and space technology. Write today for catalog—no obligation.

NORTHROP INSTITUTE OF TECHNOLOGY
1181 West Arbor Vitae Street, Inglewood 1, California

ENGINEERING DEGREES

Electronics, Mechanical, Also in Liberal Arts & Major in Accounting earned by

HOME STUDY

Resident Classes Also Available if Desired Specify course preferred

PACIFIC INTERNATIONAL COLLEGE OF ARTS & SCIENCES

Primarily a correspondence school
Chartered 1935

3719-M Santa Monica Blvd. Hollywood 38, Calif.

GET INTO ELECTRONICS

V.T.I. training leads to success as technicians, field engineers, specialists in communications, guided missiles, computers, radar and automation. Basic & advanced courses in theory & laboratory. Electronic Engineering Technology, an ECPD accredited Technical Institute curriculum. Assoc. degree in 29 mos. B.S. also obtainable. G.I. approved. Graduates in all branches of electronics with major companies. Start Feb., Sept. Dorms, campus. High school graduate or equivalent. Catalog.

VALPARAISO TECHNICAL INSTITUTE
Department C, Valparaiso, Indiana

Engineering Technician
A.S. Degree—2 Years
Electronics Engineer
B.S. Degree
Evening Courses Available

ELECTRONIC TECHNICAL INSTITUTE
970 W. Manchester Ave., Inglewood, Calif.
4863 El Cajon Blvd., San Diego, Calif.

small college year-round program

Professionally-oriented education... Bachelor of Science Degree in 36 Months in Electrical (Electronics or Power option), Mechanical, Civil, Chemical, Aeronautical Engineering; in Business Administration. One-year Drafting-Design Certificate Program. Founded 1884... rich heritage. Excellent faculty. Small classes. 200-acre campus. New library. Well-equipped labs. Residence halls. Modest costs. Outstanding placement of graduates. Enter Jan., March, June, Sept. Write G. A. McCarthy, Director of Admissions.

TRI-STATE COLLEGE
24113 College Avenue • Angola, Indiana

EARN Electronics Engineering DEGREE

You can earn an A.S.E.E. degree at home. College level HOME STUDY courses taught so you can understand them. Continue your education, earn more in the highly paid electronics industry. Missiles, computers, transistors, automation, complete electronics. Over 27,000 graduates now employed. Resident school available at our Chicago campus—Founded 1934. Send for free catalog.

American Institute of Engineering & Technology
1139 West Fullerton Parkway, Chicago 14, Ill.

FOR AN ELECTRONICS CAREER
Write For Free Catalog RE WEEKLY TUITION

MICROWAVE TECHNIQUES—TV INDUSTRIAL ELECTRONICS COMPUTERS—RADIO TRANSMITTERS—RADAR

PHILADELPHIA WIRELESS TECHNICAL INSTITUTE
1543 Pine Street Philadelphia 2, Pa.
Founded in 1908 • A Non-Profit Corp.

ENGINEERING B.S. DEGREE
SCIENCE MATH
IN 36 MOS.

U.S. NEEDS 50,000 NEW ENGINEERS A YEAR! EARN ACCREDITED B.S. DEGREE in Science or Engineering in 36 months—year-round program optional. 27-month engineering diploma also available. Classes start Jan., Sept., March, June. QUALITY EDUCATION. Graduates employed throughout the U. S. and abroad. Government approved for veteran training. Students from 50 states, 40 countries. 20 buildings; dorms, gym. Campus. New library and laboratories. Employment help provided. SAVE TIME AND MONEY. Write for catalog. 1616 E. Washington Boulevard, Fort Wayne 2, Indiana

Indiana Institute of Technology
formerly Indiana Technical College

Home Study Courses in
COMPUTER LOGIC
COMPUTER PROGRAMMING
TRANSISTOR PRINCIPLES
from the
PHILCO TECH CENTER

Study at home in your spare time and at your own pace. Choose from these courses:

1. Digital Computer Fundamentals. An up-to-date introduction to the logical construction of a computer, its design, operation and application.
2. Programming for Digital Computers. An introduction to the basic concepts and techniques of programming. Topics include number systems, flow charting, coding, debugging and program systems for the future.
3. Transistor Principles and Practice. A comprehensive course for experienced electronics technicians and engineers. Experiments verify theory and design. Pulse and special circuits are included.

RESIDENT TRAINING AT PHILADELPHIA write for free catalog on courses offered MAIL COUPON FOR FREE INFORMATION

PHILCO TECHNOLOGICAL CENTER RE-3
P.O. Box 4730, PHILADELPHIA 34, PENNA.

Please send information on the home study courses I have checked below.

Digital Computer Fundamentals, Programming for Digital Computers, Transistor Principles and Practices, Other

Name _____ Age _____
Occupation _____
Address _____
City _____ Zone _____ State _____

PHILCO
A SUBSIDIARY OF Ford Motor Company

ADVERTISING INDEX

Radio-Electronics does not assume responsibility for any errors appearing in the index below

PRE CHRISTMAS SALE

Jumbo Pak

FREE \$25 PLUS FREE \$1.00

WORTH OF

- Transistors
- Rectifiers
- Resistors
- Condensers
- Diodes
- Coils
- Knobs
- Etc. Etc.

ADD 25¢ FOR HANDLING

CHOOSE ANY ITEM IN THIS SALE AD FREE WITH EVERY \$10.00 ORDER!

BOTH FREE WITH ANY \$10.00 ORDER

FACTORY TESTED SEMI-KON-DUCTORS

- 6 2N408 TRANSISTORS, TO1, pnp, driver\$1
- 4 2N219 TRANSISTORS, mixer-convt, TO22\$1
- 2 2N296 25W TRANSISTORS, TO3, pnp\$1
- 6 ZENER DIODES, TO24, UPRITES, asst. v\$1
- 5 10 WATT TRANSISTORS, Gen'l purpose, TO3\$1
- 4 2N211/CK879 I.F. TRANSISTORS, pnp, TO22\$1
- 10 CITIZEN BAND TRANSSTRS, TO1, pnp, untested\$1
- 3 1000 MIL 800V TOP HAT RECTIFIERS, leads\$1
- 4 TEXAS INSTR. SILICON TRANSSTRS, pnp, TO22\$1
- 4 CK721 TRANSSTRS in new aluminum case, pnp\$1
- 4 HEARING AID TRANSISTORS, pnp, size 1/4 x 1/4"\$1
- 4 SUBMINIATURE 2N131 TRANSISTORS, rf-if, pnp\$1
- 25 "EPOXY" SILICON DIODES, untested\$1
- 10 SWITCHING TRANSISTORS, npn, 2N438 equals\$1
- 2 CBS 35W POWER TRANSSTRS, 2N1434, pnp, stud\$1
- 10 FAMOUS CK722 TRANSISTORS, pnp, untested\$1
- 15 PNP TRANSISTORS, asst. types and cases\$1
- 15 NPN TRANSISTORS, asst. types and cases\$1
- 4 100mc SB-100 TYPE TRANSISTORS, TO1 case\$1
- 20 TOP HAT RECTIFIERS, 750 mil, untested\$1
- 500-MC. 'MESA' SUBMINIATURE TRANSTR, pnp\$1
- 2 AMP SCR SILICON CONTROLLED RECT., stud\$1
- 15 CBS GERMANIUM DIODES, 1N34, 1N48 equals\$1
- 4 CBS 15W TRANSISTORS, 2N1504, stud\$1
- 3 CBS 20-WATT TRANSISTORS, pnp, stud, 2N1320\$1
- 3 CBS 20-WATT TRANSISTORS, npn, stud, 2N1321\$1
- 5 SUN BATTERIES TO 1 1/2" sizes, lite sensitive\$1
- 25 AMP SWITCHING TRANSISTOR, ignition too\$1
- 1 WATT ZENER DIODE, choose from 3 to 100V\$1
- 30 "KLIP IN" DIODES, like 1N82 of CBS\$1
- 25 SEMI-KON-DUCTORS; transstrs, diodes, rect.\$1
- 2 CBS 2N255 TRANSISTORS, TO3 case, pnp\$1
- 2 40-WATT TRANSISTORS, 2N174 type, TO36\$1
- 4 GENERAL ELECTRIC OUTPUT TRANSSTRS, 2N43\$1
- 15 AMP 200PIV AXIAL LEAD RECTIFIER, silicon\$1
- 5 GENERAL ELECTRIC 2N107 PNP TRANSISTORS\$1
- 4 GENERAL ELECTRIC 2N170 RF NPN TRANSSTRS\$1
- 4 HUGHES PLUG-IN DUAL SILICON RECTIFIERS\$1
- 15 UPRIGHT 1N434 SILICON DIODES, worth \$40\$1
- 10 TRANSISTOR SET, 5 PNP, 5 NPN, pop. types\$1
- 150 WATT NPN TRANSISTOR, 2N1015A, stud\$1
- 10 2-AMP SILICON POWER STUD RECTIFIERS\$1
- 6 AMP 1000 PIV SILICON STUD RECTIFIER\$1
- 2 'MESA' 4-WATT TRANSSTRS, npn, silicon, TO5\$1
- 4 2N35 NPN TRANSISTORS, TO22\$1
- 6 TRANSISTOR RADIO SET, osc-ifc-driver-p.p.\$1
- 2 25-AMP SILICON STUD RECTIFIERS\$1
- 3 40-WATT POWER TRANSISTORS, threaded case\$1
- 10 1000 MIL "EPOXY" RECTIFIERS, silicon\$1

WORLD'S MOST POPULAR \$1 PARTS PAKS

- 10 'MICRO' SNAP SWITCHES, 115 vac, 15A\$1
- 40 PRECIS'N RESISTORS, 1/2, 1, 2W, 1% & better\$1
- 5 TANTALUM ELECTROLYTICS, only 1/4 x 1/4" sizes\$1
- 10 UPRITE TRANSTR ELECT'LYTICS, 10 to 100mf\$1
- 30 'CORNING' LOW NOISE RESIST'S, 1/2, 1, 2W\$1
- 300-FT. HOOKUP WIRE, asst. colors, sizes\$1
- 50 ALLEN BRADLEY 1-WATT'S, resistors, 5% too\$1
- 60 TUBULAR CONDENSERS, to .5mf to 1KV\$1
- 40 DISC CONDENSERS, .27mf to .05mf to 1KV\$1
- 60 TUBE SOCKETS, receptacles, audio, etc.\$1
- 10 PANEL SWITCHES, rotary-micro-slide-power\$1
- 10 TRANSISTOR SOCKETS for pnp-npn transistors\$1
- 30 POWER RESISTORS to 50V, to 24 Kohms\$1
- 50 MICA CAPACITORS to .01mf, silvers too\$1
- 10 VOLUME CONTROLS to 1 meg, switch too\$1
- 10 ELECTROLYTICS to 450V to 500 mf\$1
- 50 RADIO & TV KNOBS, asst. colors, styles\$1
- 10 TRANSISTOR ELECTROLYTICS, to 100 mf\$1
- \$25 RADIO-TV SURPRISE, wide variety\$1
- 50 COILS & CHOKES, rf-if, osc-peaking-etc.\$1
- 35 ALLEN BRADLEY TWO WATTERS, 5% too\$1
- 100 ASST. HALF WATT RESISTORS, 5% too\$1
- 60 HI-Q RESISTORS, 1/2-1-2W to 1 meg, 5% too\$1
- 10 PHONO PLUG-IN JACK SETS, tunors-amps\$1
- 50 TERMINAL STRIPS, asst. 1-to-10 lug types\$1
- 35 SILVER MICAS, asst. values & voltages\$1
- 60 CERAMIC CONDENSERS, discs, npo's to .05mf\$1
- 4 TRANSISTOR TRANSFORMERS, worth \$25\$1
- 40 WORLD'S SMALLEST RESIST., 5% too, 1/10W\$1
- 40 SUBMINIATURE COND., to .05mf, cerall too\$1
- 100 PARTS SURPRISE, worth \$25, p. dkt. too\$1
- INFRA-RED PHOTO DETECTOR TRANSDUCER\$1
- INFRA-RED PARABOLIC REFLECTOR & FILTER\$1
- 6 UNPUNCHED PTD. CIRCUIT BDS., 3x7" sizes\$1

10¢ FOR OUR CHRISTMAS BARGAIN CATALOG ON:
 Semiconductors Poly Paks Parts

WANTED! CANADIAN 'N' FOREIGN CUSTOMERS TOO!

POLY PAKS

TERMS: send check, money order, include postage—avg. wt. per pkg 1 lb. Rated, net 30 days. CODs 25%

P.O. BOX 942R
 SO. LYNNFIELD, MASS.
 "PAK-KING" OF THE WORLD

Accurate Instrument Co.	109	Philco (Techrep Div)	108
Allied Radio Corp.	53, 54	Polypaks	112
Amperex Electronics Corp.	Second Cover	Precision Apparatus, Inc. (PACO)	78, 79
Antenna Specialists Co.	83	Progressive "Edu-Kits" Inc.	96
B & K Manufacturing Co.	77	Quam-Nichols Company	89
Benjamin Electronic Sound	92	Quietrole Company	106
Blonder-Tongue Labs	16	Rad-Tel Tube Company	99
Brooks Radio & TV Corp.	100, 101, 102	RCA (Electronic Components and Devices)	Cover 4
Burstein-Applebee Co.	103	RCA Institutes	70, 73
Capital Radio & Engineering Institute	11	RCA Test Equipment	22
Castle TV Tuner Service	14	RCA (Communications & Tubes Division)	21
CLASSIFIED ADS	110	(Howard W.) Sams & Co.	23, 88
Cleveland Institute of Electronics	9	(H. H.) Scott, Inc.	105
Conar Instruments (Div. of National Radio Institute)	94	Sencore	25
Cornell Electronics	7	Sonar Radio Corp.	74
Coyne Electrical School	105, 112	Sony Corp. of America	56
CREI Atomics (Div. of Capital Radio Engineering Institute)	90	Sprague	93
DeVry Technical Institute	7	Triad Distributor Div.	8
EICO Electronic Instrument Co.	26	University Loudspeakers, Inc.	75
Electronic Chemical Co.	105	Weller Electric Co.	17
Electronic Measurement Corp. (EMC)	107	Winegard Co.	84, 85
Electronic Publishing Co., Inc.	107	Workman Electronic Products, Inc.	100
Euphonics Corp.	97	Wuerth Products, Inc.	95
General Electric Co. (Receiving Tube Dept.)	12, 13	Xcelite, Inc.	18
General Radiotelephone Co.	106	SCHOOL DIRECTORY	page 111
Gernsback Library, Inc.	91	American Institute of Technology & Engineering Electronic Technical Institute	
Grantham School of Electronics	15	Indiana Institute of Technology	
Gregory Electronics Corp.	108	Northrup Institute of Technology	
Heald's Engineering College	104	Pacific International College of Arts & Sciences	
Heath Co.	58, 59, 61, 63, 65, 67	Philadelphia Wireless Technical Institute	
I-Triple-E	69	Philco Corp. Technological Center	
International Correspondence Schools	114	Tri-State College	
International Crystal Mfg. Co., Inc.	21	Valparaiso Technical Institute	
Jensen Manufacturing Co.	Cover 3	MARKET CENTER	page 113
Jerold Electronics Co.	3, 51	Audio Unlimited	
J F D Electronics Corp.	10	Beck Radio	
(E. F.) Johnson Co.	86	Carston	
Key Electronics Co.	112	Colordaptor	
Lafayette Radio	81, 82	Fair Radio Sales	
Massey Technical Institute	86	GM Photoelectronics	
Mercury TV Tuner Service	103	Merrell Electronics	
National Radio Institute	19, 20, 74	Oelrich Publications	
National Technical Schools	5	Relco	
North American Phillips Co., Inc. (Norelco)	98	Stereo-parti	
Olson Electronics, Inc.	107	Transistors Unlimited Co.	
Perma-Power Company	57	Warren Electronics Co.	
		Valley TV Tuner Service	
		Printed in U.S.A.	



COYNE
 TRAINS YOU
 IN SPARE TIME
 AT HOME

TELEVISION
 COLOR TV-
 RADIO-ELECTRONICS

FREE
 of Extra Charge
 to Graduates
TWO WEEKS
 Shop Training in Chicago

Coyne—and only Coyne—can give you this modern, TV Home Training. Easy to follow 250 photos and diagrams covering Radios-TV, Color, UHF, Transistors. We also show you how to start making money while learning, right at home. Get your basic training at home, then make a flash finish with 2 weeks of actual shop work in Chicago under direction of same instructors who guide our resident students.

LOW COST—Easy to Pay
 You don't pay for costly "put together" kits. Small monthly payments and low, low cost make it easy for everyone to train. Free employment service for graduates—or we show you how to start your own service business on a "shoestring." Send name today for complete facts and valuable book on Television. No salesman will call. Everything mailed free, postpaid.

Coyne Electrical School
 Chartered as an Educational Institution Not for Profit
 1501 W. Congress Parkway
 Dept. 83-H5, Chicago 7, Ill.

FREE Just Send Name
 No charge. No obligation. No salesman will bother you. Just send name for free copy of big 24 page book on quickest, lowest cost way to train for top pay job or business of your own. Mail coupon today.

**B.W. Cooke, Pres. Home Training Division, Dept. 83-H5
 1501 W. Congress Parkway, Chicago 7, Ill.**

Please mail free book and offer of two weeks personal training in Chicago without extra tuition for home study graduates. Explain low monthly payments.

NAME _____
 ADDRESS _____
 CITY & STATE _____

SEE YOUR COSTS SHRINK WITH KEY DISCOUNTS

Prove it for yourself! Rush us your list of stereo hi-fi components for an immediate price-busting quotation.

- Enjoy these advantages:
- LOWEST PRICES
 - SPEEDY DELIVERY
 - FACTORY WARRANTY
 - EASY PAYMENT PLAN

For a real eye-opener, send for our valuable money-saving audio discount catalog A-17, featuring the latest in stereo equipment.

KEY ELECTRONICS CO.
 518 East 95th St., Bklyn. 12, N.Y.



AUDIO unlimited, inc.

Specializes in **SAVING YOU MONEY**

- FACTORY FRESH COMPONENTS
- LOWEST POSSIBLE QUOTATIONS
- FAST DELIVERY
- TIME PAYMENTS UP TO 36 MOS.

We are **FRANCHISED** by OVER 50 **NATIONALLY FAMOUS MANUFACTURERS. WRITE FOR BARGAIN LIST.** Visit Our Warehouse
715-R 2nd Ave., (Nr. 38th)
New York 16, New York

CONVERT TO COLOR TV

COLORDAPTOR—A simple 10-tube circuit and rotating color wheel converts any size B & W TV to receive compatible color.

COLORDAPTOR — Easily attached to any TV set, does not affect normal operation, often built from parts experimenters have on hand, **BRILLIANT COLOR!**

Complete booklet—gives theory of operation, all construction details, schematic, and sample color filters. **\$195**

Essential Parts Kit—Includes all special parts—coils, delay line, crystal, color filters. Add \$1.00 for sets over 16". **\$19.95**

COLORDAPTOR
1798 Santa Cruz,
Menlo Park, Calif.

NOVICE OR ENGINEER

OHM'S LAW never forgotten with copyrighted tool. \$2.00 money order post-paid.

BECK RADIO, 6323 S. Dale Mabry, Tampa, Florida 33611

COMING NEXT MONTH

Radio-Electronics

COLOR TV ISSUE

LOW-COST BUSINESS AIDS FOR RADIO-TV SERVICE

Order books, invoice forms, job ticket books, service call books, cash books and statement books for use with your rubber stamp. Customer file systems, book-keeping systems, many others. Write for **FREE 32 PAGE CATALOG** now.

OELRICH PUBLICATIONS
6556 Higgins Rd., Chicago, Ill. 60656

RENT

FREE BROCHURE

STEREO TAPES

Postpaid 2 to 5 day delivery (48 States)

stereo-parti

1616-D TERRACE WAY, SANTA ROSA, CALIF.

SILICON TOP HATS OR DIODES

750 MA
LOWEST PRICES
GUARANTEED

LOW LEAKAGE NEWEST TYPE

PIV/RMS 50/35 .05 ea.	PIV/RMS 100/70 .09 ea.	PIV/RMS 200/140 .12 ea.	PIV/RMS 300/210 .18 ea.
PIV/RMS 400/280 .23 ea.	PIV/RMS 500/350 .28 ea.	PIV/RMS 600/420 .33 ea.	PIV/RMS 700/490 .38 ea.
PIV/RMS 800/560 .58 ea.	PIV/RMS 900/630 .68 ea.	PIV/RMS 1000/700 .78 ea.	PIV/RMS 1100/770 .88 ea.

ALL TESTS! AC & DC & FWD & LOAD
100 Dif. Pre. Res. 1/2, 1, 2 WATT—1% Tol. \$1.25
G.E. IN91 Diode—10 for \$1.00, 100 for \$8.00
Special 1000 PIV—750 MA. 10 for \$7.50

SILICON POWER DIODE STUDS

Amps	Piv	Sale	Amps	Piv	Sale
3	50	\$0.15	35	50	\$.95
3	100	.30	35	100	1.20
3	200	.50	35	200	1.50
3	400	.50	35	400	3.00
3	600	.60	50	50	3.25
12	100	.80	50	200	4.00
12	200	1.00	100	50	2.75
12	400	1.50	100	100	3.50
12	600	2.00	100	300	4.00

Money Back guarantee. \$2.00 min. order. Orders F.O.B. NYC. Include check or money order. Shpg. charges plus. C.O.D. orders 25% down.

WARREN ELECTRONICS CO.
NYC 7, NY 87 Chambers St. Wo 2-5727

TRANSISTORS***NEW

I.F. converter, switch, audio, also high frequency; PNP and NPN 3/\$1.00
Power transistors—20 to 70 watts \$1.60
Brand New, original package; full leads; Guaranteed—RCA, CBS, Raytheon, Texas Instru., U.S. Transistor, General Transistor.

DIODES***NEW

IN217—Hoffman Elec. Upright, gold leads Rectifier 25
IN537—IN539—Tophat; Raytheon, Motorola, General Elec. Rectifier 50
IN60—Micro-miniature diodes 8/\$1.00
Stud type Rectifier—400 PIV—750 MA. 50
Zener Diodes—12 volt; 1 amp. \$1.00
Transistor sockets—3 lead—(Cinch Co.) 10/\$1.00
Driver Transformer—sub-miniature—1/2-1/2-1/2 for transistor P.C. center-tapped 2/\$1.00
Audio Output Transformer—sub-miniature—1/2-1/2-1/2 for Transistor P.C. center-tapped 2/\$1.00
2 K ohm volume control with switch—P.C. (CTS) miniature 3/\$1.00
500 K ohm volume control with switch (Cutler-Hammer) 3/\$1.00
455 KC. I.F. sub-miniature transformer 2/\$1.00
455 KC. Dual I.F. sub-miniature transformer ea. 60
Parts for 2 Watt Audio Power amplifier. Consisting of 3 transistors, including 1 power transistor, resistors, electrolytic capacitors, together with schematic. Can be built in a 2" X 2" box \$3.00
Parts for 12 volt, 1 amp. REGULATED power supply, with schematic and instructions \$8.95
Code Oscillator module; completely assembled Matchbook size with schematic, etc. \$1.00
P. A. Amplifier Module; completely assembled with schematic—3 lead and instructions \$2.00

WRITE FOR FREE ADDITIONAL CATALOG.
Minimum order \$3.00
Prepaid Postage Free in U.S.

TRANSISTORS UNLIMITED COMPANY
Post Office Box #442, Great Neck, L. I., New York

FREE Catalog

OF THE WORLD'S FINEST
ELECTRONIC GOV'T
SURPLUS BARGAINS

**JUST OUT —
NEW EDITION**

IF YOU HAVEN'T RECEIVED A COPY OF OUR BIG NEW 1963 FALL / WINTER CATALOG, WRITE FOR YOUR COPY NOW! IT'S FREE!
Address Dept. RE

FAIR RADIO SALES
2133 ELIDA RD. • Box 1105 • LIMA, OHIO

Convert any television to sensitive

BIG-SCREEN OSCILLOSCOPE

with minor, inexpensive changes. Ingenious circuit. No electronic experience needed to follow our clearly illustrated plans. **TECHNICIANS, HAMS, EXPERIMENTERS, BROADCASTERS.** Use in shop, school, lab. Any set—any size screen.

FULL PLANS \$2

RELCO, Dept. R-10, Box 10563, Houston 18, Tex.

ELECTRONIC DESIGN CHARTS

By Norman H. Crowhurst

\$5.95
Clothbound
No. 110

Clear, accurate nomographs. Save hours of design time, eliminate uncertainty and mistakes. 59 different charts. A must for electronic engineers and technicians. Hard covers, spiral bound.

GERNSBACK LIBRARY, Inc. 113
164 W. 14 St., New York, N. Y. 10011

Enclosed is \$_____ Please send me _____
Electronic Design Charts @ \$5.95

Name.....
Street.....
City.....State.....

COLLARO \$16.95

CHANGER net 3 or more

1 OR 2—\$17.95 — With EV or Ronette Cartridge, Diamond Stylus, 4 pole motor. Wood Base \$3.50 extra. **FREE CATALOG.**

GM PHOTOELECTRONICS

623 So. Gay Street Knoxville 2, Tenn.

FAST SHIPMENTS

RECORDERS • TAPES

COMPONENTS • KITS

- BEST-BY-COMPARISON PRICES
- FACTORY SEALED CARTONS
- SEND FOR "QUOTES" ON PACKAGE DEALS AND SAVE MORE

WRITE FOR MONTHLY SPECIALS

CARSTON Studios
125-R East 88 St., New York 28, N. Y.

TV TUNERS REBUILT

and Exchanged **\$9.50** plus shipping chgs.

All Makes-Models **ONLY***

- Includes All Parts Except Tubes
- Aligned to Factory Specifications
- 90 Day Full Warranty
- Practical repairs

Ship tuner complete with tubes, broken parts, tuner cover. Give model # and state complaint.

VALLEY TV TUNER SERVICE • PO 9-4730
5641-A Cahuenga Blvd., North Hollywood, Calif.

ONLY MERRELL KITS

HAS THIS AMPLIFIER

SA-40 WILLIAMSON TYPE
20-20,000 cps magnetic inputs

\$4995

40 WATT STEREO AMPLIFIER W/PREAMPS

Complete line from \$19.95. 5% higher W. of Rockies
Detailed Instructions, Diagrams. Covers extra.
Write for Brochure, Name of Nearest Dealer

MERRELL KITS, 519-R Hendrix St., Brooklyn 7, N. Y.

PUZZLE: FIND AL

Al's got himself lost in his job.

He does his work. He draws his pay. He gripes, and hopes, and waits. But the big breaks never seem to come.

You have to hunt hard for Al. He's in a rut!

Then, who's the figure standing out in the picture? That's Tom. Tom grew tired of waiting. He decided to act. He took three important steps:

1. Wrote to I.C.S. for their three famous career books.
2. Enrolled for an I.C.S. job-related course.
3. Started to apply—on the spot—what he was learning.

The others began to say, "Ask Tom, he knows." The supervisor began to take notice. The boss began to receive reports on Tom's progress. *And Tom began to move!*

It's a fact worth remembering: An I.C.S. student always stands out!

P.S.—You'll find men like Al everywhere—griping, hoping, waiting—reading this and skipping on. But forward-looking fellows like Tom will take time to investigate, will mark and mail the coupon and get the three valuable career books free. They're men of action. And a few short months from now, you'll see them start to move!



Clip coupon here—and take your first big step to real success! I.C.S., Scranton 15, Penna.

Accredited Member
National Home Study Council

INTERNATIONAL CORRESPONDENCE SCHOOLS I C S

Box A7753K, Scranton 15, Penna.

(In Hawaii: P. O. Box 418, Honolulu. In Canada: I. C. S. Canadian, Ltd., Montreal.)

Without cost or obligation, rush me FREE Success Kit, with 3 valuable booklets: (1) How to Succeed; (2) opportunity booklet about the field I've checked below; (3) Sample I. C. S. Lesson.

ARCHITECTURE and BUILDING TRADES

- Air Conditioning
- Architecture
- Arch. Drawing
- Building Contracting and Estimating
- Carpentry & Millwork
- Heating
- House Planning
- Painting
- Plumbing

ART and DESIGN

- Commercial Art
- Fashion Illustrating
- Interior Decorating
- Magazine Illustrating
- Show Card & Sign
- Painting
- Sketching and Painting

AUTOMOTIVE

- Auto Body Rebuilding
- Auto Electric Technician
- Automobile Mechanic
- Engine (Gas & Diesel)
- Engine Tune-Up

- Transmission Specialist

AVIATION

- Aero Engineering
- Aircraft Drafting
- Aircraft Mechanic

BUSINESS

- Accounting
- Cost Accounting
- Public Accounting
- Bus. Administration
- Executive Training
- Marketing
- Personnel-Labor Relations
- Programming for Digital Computers
- Purchasing Agent
- Real Estate
- Salesmanship
- Sales Mgmt.
- Small Business Mgmt.
- Traffic Mgmt.

CHEMICAL

- Analytical Chemistry
- Chem. Engineering
- General Chemistry

- Lab. Technician
- Nuclear Energy
- Plastics
- Pulp, Paper

CIVIL ENGINEERING

- Civil Engineering
- Construction Engrg.
- Highway Engineering
- Reading Structural Blueprints
- Sanitary Engineering
- Structural Engineering
- Surveying & Mapping

DRAFTING

- Architectural
- Electrical and Electronic
- Mechanical
- Sheet Metal

ELECTRICAL

- Elec. Appliance Servicing
- Electrical Engineering
- Elec. Eng. Technician
- Elec. Motor Repairman
- Industrial Electronic Technician

- Industrial Telemetering
- Instrument Technician
- Practical Electrician
- Practical Lineman

ELECTRONICS

- Automation
- Basic Electronics
- Electronic Computers
- Electronic Technician
- Hi-Fi Stereo and Sound Systems
- Industrial Electronics
- Ultrasonics

ENGINEERING (Professional)

- Chemical
- Civil
- Electrical
- Mechanical

ENGLISH and WRITING

- Better Business Writing
- Introductory Technical Writing
- Short Story Writing

- Practical English

HIGH SCHOOL (Diploma)

- High School General
- High School Math
- High School Secretarial
- High School Vocational
- College Preparatory

MECHANICAL and SHOP

- Gas and Electric Welding
- Industrial Engineering
- Industrial Instrumentation
- Machine Design
- Machine Shop Practice
- Mechanical Engineering
- Reading Shop Blueprints

- Tool Design

- Toolmaking

- Safety Engineering

SECRETARIAL

- Clerk-Typist
- Professional Secretary

- Shorthand
- Stenographic
- Typist

STEAM and DIESEL POWER

- Boiler Inspector
- Power Plant Engineering
- Stationary Diesel Engineering
- Steam Engineering

SUPERVISION

- Foremanship—Suprv'n
- Personnel—Lab. Rel'n's

TV-RADIO

- Radio and TV Servicing
- Radio-Telephone License
- TV Technician
- Practical Radio-TV Engineering

MISCELLANEOUS

- Railroad
- Textile
- Other (please specify)

Name _____ Age _____ Sex _____
 Home Address _____
 City _____ Zone _____ State _____
 Occupation _____
 Employed by _____ Working Hours _____

Special low rates to members of U. S. Armed Forces!

FREE!

MAIL
THIS
CARD
TODAY

LAFAYETTE RADIO ELECTRONICS

1964
CATALOG
NO. 640



422
GIANT-
SIZE
PAGES

**LAFAYETTE
GIVES YOU MORE IN '64**

- **MORE CATALOG-** the biggest in our 43-year history; 422 giant-size illustrated pages.
- **MORE SELECTION-** if it's in hi-fi or electronics, it's at Lafayette.
- **MORE SERVICE-** more and more orders fully processed in 24 hours.
- **MORE BUYING POWER-** choose from Lafayette's three Easy-Pay credit plans.

**43 YEARS OF DEPENDABLE SERVICE AT
LAFAYETTE'S TRADITIONALLY LOW PRICES**

10 CONVENIENT LOCATIONS

SYOSSET, N. Y. 111 Jericho Turnpike.
(2 Blocks West of So. Oyster Bay Rd.)
Mail Order and Long Island Sales Center.

JAMAICA 33, N. Y. 165-08 Liberty Avenue
(Off Merrick Rd.)

NEW YORK 13, N. Y. 100 6th Avenue
(Just North of Canal St.)

SCARSDALE, N. Y. 691 Central (Park) Avenue
(1/2 Mile North of Ardsley Rd.)

BRONX 58, N. Y. 542 E. Fordham Road

NEWARK 2, N. J. 24 Central Avenue

PLAINFIELD, N. J. 139 W. 2nd Street

PARAMUS, N. J. 182 Route 17
(1 Mile North of Garden State Plaza)

BOSTON 10, MASS. 110 Federal Street

NATICK, MASS. 1400 Worcester Street
Rt. 9 (Opposite Shopper's World)

FREE!

LAFAYETTE 422-Pg. 1964 CATALOG!



"World's Hi-Fi & Electronics Shopping Center"

LAFAYETTE GIVES YOU MORE IN '64

MORE TAPE RECORDERS ...

From miniature portable recorders to complete tape decks... for fun at home to professional use, you'll find just the recorder you need at a popular Lafayette price.

LAFAYETTE PROFESSIONAL-TYPE 4-TRACK STEREO RECORDER

A complete recording studio in one case! Record 4-track stereo and monaural, plays 4 and 2-track stereo and 4-track monaural. Two matched stereo speakers. With 2 mikes, output cables, 7" take-up reel, 1200 ft. reel of tape.

169⁹⁵



RK-155WX

MORE CITIZENS BAND ...



HE-100L

399⁹⁵

2-for-
78.88

Lafayette offers more transceivers, more Walkie-Talkies and more accessories than ever before.

LAFAYETTE 12-TRANSISTOR C.B. WALKIE-TALKIE

The walkie-talkie with more new features—variable noise squelch, separate microphone and speaker, push-pull audio output, 12-transistors, diode, thermistor. Available with optional plug-in 117V power pack. With carrying case, batteries, earphone, crystals.

MORE STEREO HI-FI ...



You'll find a complete selection of stereo hi-fi equipment at Lafayette. All famous brands plus Lafayette's own top-rated components.

LAFAYETTE 24-WATT STEREO HI-FI PHONO SYSTEM Outstanding Performance At A Budget Price

LAFAYETTE SYSTEM PRICE

129⁵⁰

with FREE
Accessories
LS-225WXM



MATCHED COMPONENTS

Garrard Autoslim 4-Speed Automatic Changer
Lafayette LA-224 24-Watt Stereo Amplifier
Wood Base for Changer.
Empire 880 Diamond Needle Stereo Cartridge
2 Lafayette SK-124 2-Way Speaker Systems.

FREE with purchase of this system—record cleaning kit, stylus pressure gauge, all necessary hook-up wire and cable.

MORE HAM GEAR ...



Wired
HE-30WX 79⁹⁵

semi-kit
KT-320

64⁹⁵

Amateurs everywhere make Lafayette their headquarters for all their gear... from receivers and transmitters to the smallest accessory.

LAFAYETTE PROFESSIONAL-QUALITY 8-TUBE AMATEUR COMMUNICATIONS RECEIVER

4-band coverage—designed for today's crowded amateur bands. Outstanding bandwidth, selectivity and sensitivity with built-in Q-multiplier and edgewise S-meter.

MORE THAN EVER BEFORE ...

- More Radios • More Test Equipment • More Tools
- More TV and Radio Tubes, Parts, Accessories
- More Cameras • More Optics
- More P.A. Equipment • More Books

NO MONEY DOWN... UP TO 24 MONTHS TO PAY

FREE

MAIL
CARD
TODAY



send card today for your money-saving

ALLIED 444-PAGE 1964 CATALOG

WORLD'S LARGEST ELECTRONICS CATALOG
BIGGEST SELECTION • BIGGEST SAVINGS!

NO MONEY DOWN: NOW! MORE BUYING POWER WITH
YOUR ALLIED CREDIT FUND PLAN!

satisfaction guaranteed or your money back

**SEE
OTHER
SIDE**

For your FREE 1964 ALLIED
Catalog, fill in card, detach and
mail now. (Please give other
card to an interested friend.)

**SEND
CARD
TODAY**

**MAIL
NOW**

MAIL
NOW



FREE send card today for
your money-saving

ALLIED

1964 CATALOG

444 PAGES • WORLD'S LARGEST

SEE WHAT'S NEW • BIGGEST SELECTION • BIGGEST SAVINGS



1964 knight-kits[®]

Over 100 great do-it-yourself kits: Hi-Fi, Hobby, Citizens Band, Amateur, Intercom, Test Instrument—wonderful to build—savings up to 50%.

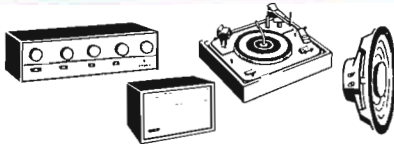

Stereo Hi-Fi

Complete selection of components and systems; Knight[®] super-value hi-fi; latest all-transistor equipment; all famous hi-fi makes—the best for less.



Citizens Band Radio

Latest 2-way radio for everyone—no exam required—complete selection of top-value CB equipment, including new Walkie-Talkies.



Tape Recording Values

Largest selection of complete recorders, including latest Stereo types; tape decks; accessories; top values in quality recording tapes in all leading makes.

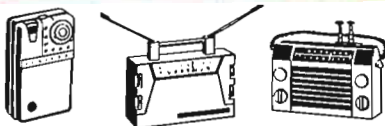

FM-AM & AM Radios

Best buys in a wide selection of compact transistor radios, including pocket types, and top quality FM-AM portable models.

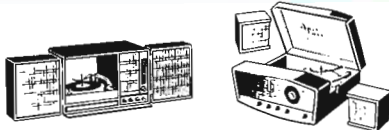

Phonographs & Accessories

Big values in phonographs; latest Stereo portables; full selection of phono accessories, including cartridges, turntables, pickups, etc.



Ham Station Equipment

Largest selection of famous-make receivers, transmitters, antennas—everything in Ham station gear at low, money-saving prices.



Test Instruments

Save on every type of instrument for home or professional use—see the largest selection in all the leading makes.

PLUS • PA Systems & Intercoms • Top values in Power Tools, Soldering Guns, Hardware
• Biggest selection of TV Tubes, Antennas; Parts, Tubes, Transistors, Books

satisfaction guaranteed or your money back

NO MONEY DOWN: Now! More Buying Power with your Allied Credit Fund Plan!

MAIL
NOW

FREE SEND CARD TODAY FOR YOUR
1964 ALLIED CATALOG
and give one card to an interested friend

MINIATURE SPEAKER SYSTEMS BY JENSEN

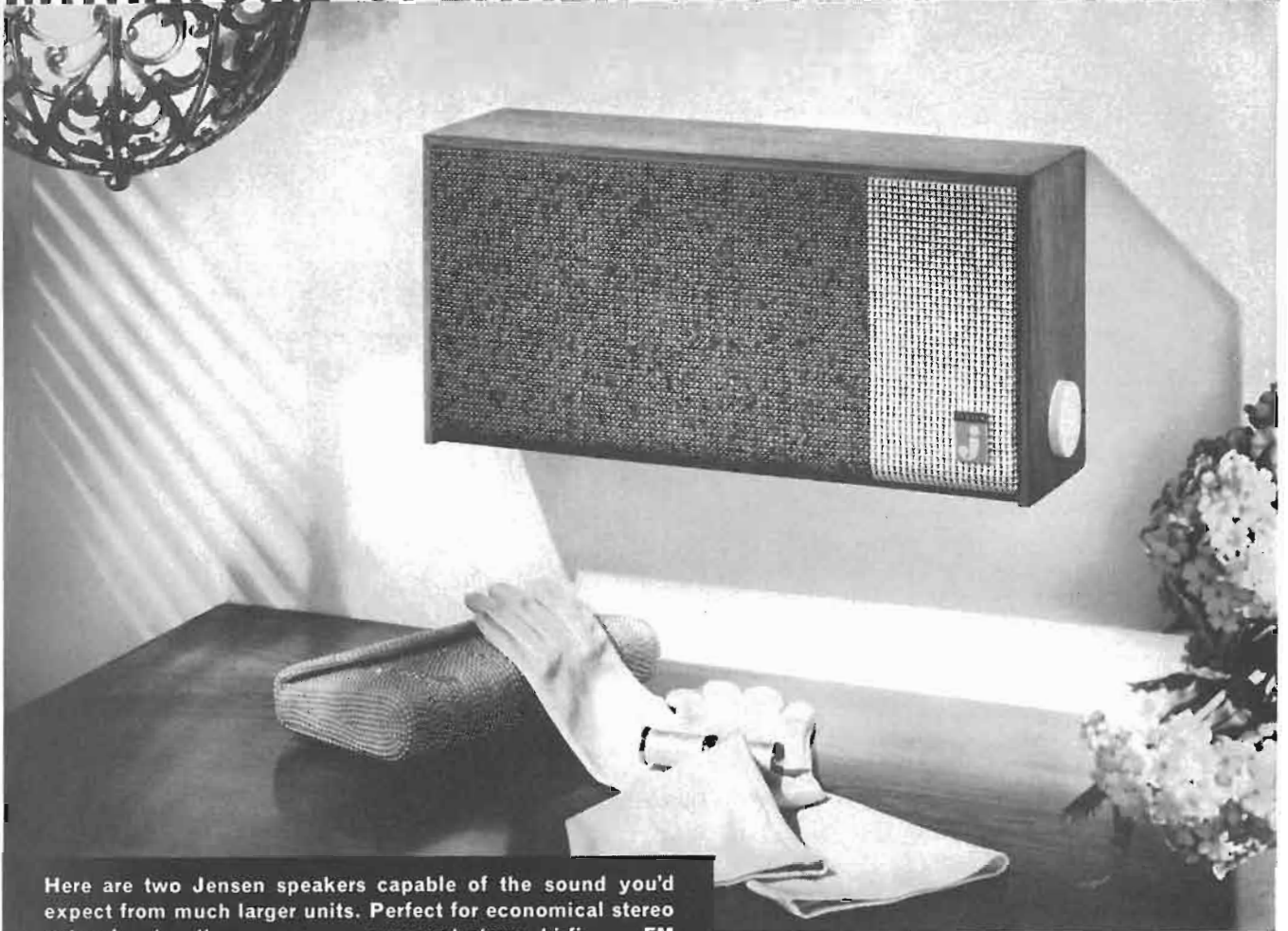

Here are two Jensen speakers capable of the sound you'd expect from much larger units. Perfect for economical stereo extension to other rooms . . . compact stereo hi-fi . . . FM Multiplex stereo . . . and so very flexible in decorative possibilities. Place them on any surface, or hang them on the wall. Built-in hangers are provided on the back. Both feature Jensen's custom two-tone grille fabrics and genuine oiled walnut cabinetry . . . and both are economically priced to fit easily into your budget. Write for Brochure MX for full details.

NEW ULTRA-COMPACT X-11

2-speaker 2-way system

A special woofer with a new moving system precisely matched to its diminutive enclosure is largely responsible for the truly remarkable performance of the X-11. A 3" tweeter extends high frequency response to 14,000 cycles. Improved efficiency gives full room volume with amplifiers of low power rating. Volume is adjustable by a control on the side of the cabinet for convenience in extension speaker applications. Dimensions: 6 $\frac{5}{8}$ " H, 13 $\frac{1}{16}$ " W, 4" D.



X-11 2-speaker 2-way system. May be used with amplifiers having 4, 8, or 16 ohm output. Power rating 6 watts. Adequate room sound with 1 watt to speaker. In oiled walnut \$29.75

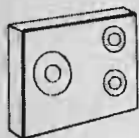

X-20 3-speaker 2-way system. May be used with amplifiers having 4, 8, or 16 ohm output. Power rating 6 watts. Adequate room sound with 1 watt to speaker. In oiled walnut \$39.95



SLIM COMPACT X-20 3-speaker 2-way system

Unbelievably excellent sound quality is yours from Jensen's famous X-20 speaker system. A specially designed woofer with powerful SYNTAX-6[®] magnet, plus two tweeters provide smooth, wide-range sound for your listening pleasure. Extra slim . . . perfect for wall mounting. Convenient side control allows volume adjustment. Dimensions: 12 $\frac{7}{8}$ " H, 15 $\frac{3}{8}$ " W, 2 $\frac{1}{2}$ " D.

PALMIER 1990

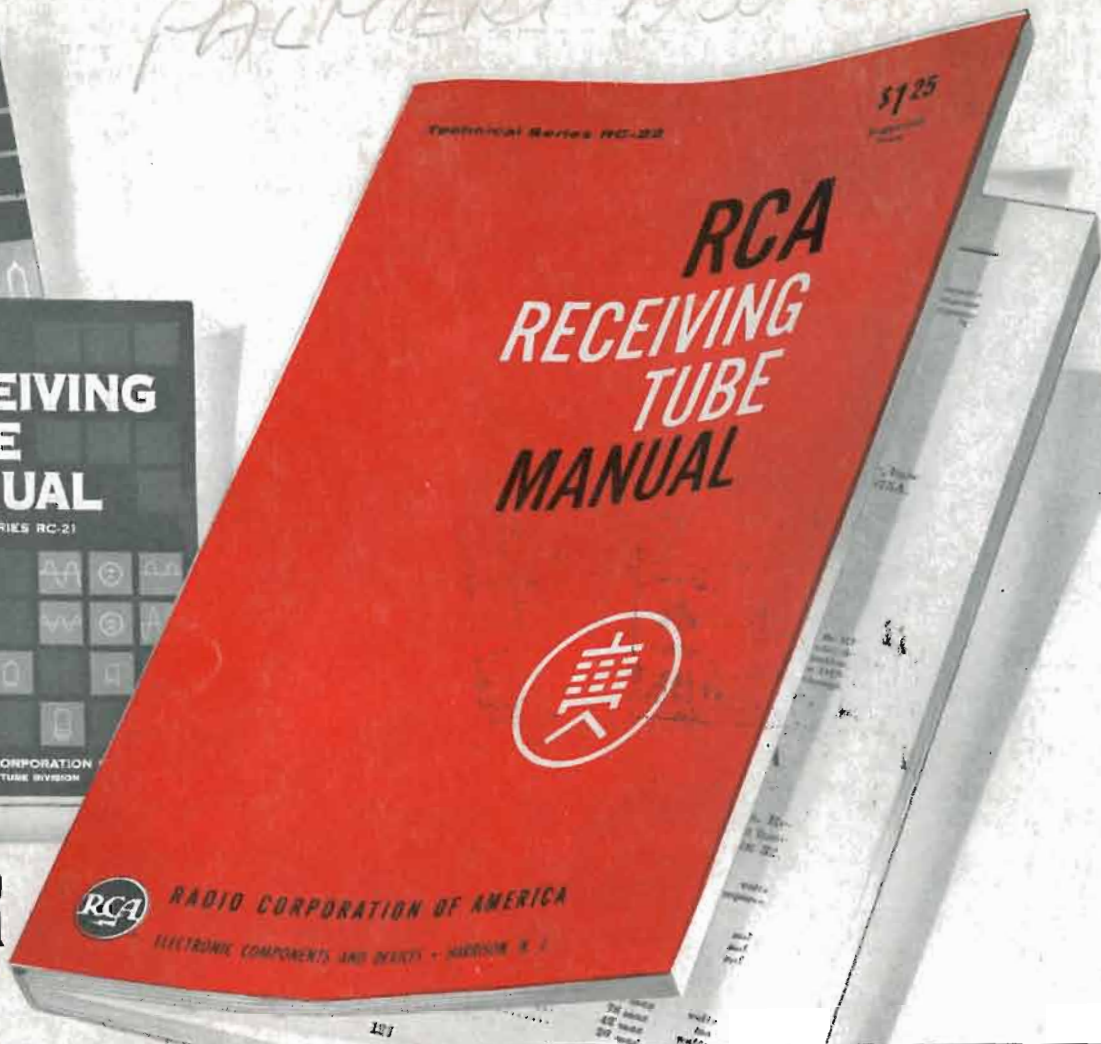
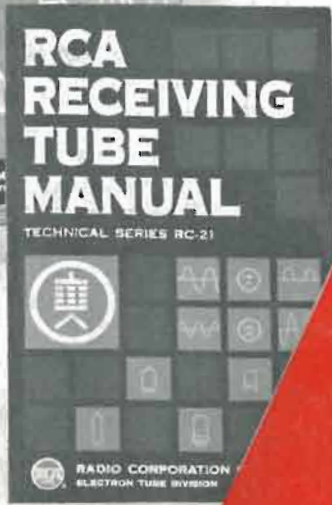
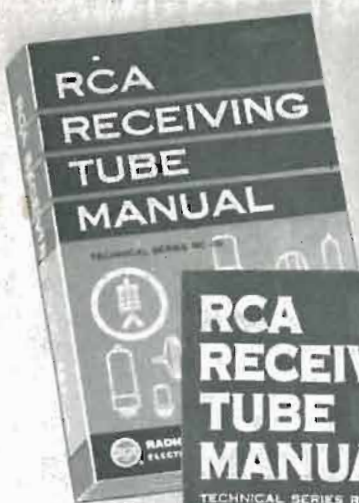

**BETTER
THAN
EVER!**

**The latest edition of the famous
RCA RECEIVING TUBE MANUAL ... JUST OUT!**

Each year we expand and improve our famous receiving tube manual—to keep it the most popular and up-to-date tube reference of its kind in electronics.

The latest edition—RC-22—is the biggest and best ever... almost 100 pages longer than the previous edition. It features:

- Over 100 new tube types (1)
- An expanded and completely detailed applications guide (2)
- New circuit diagrams for:
 - Citizens' Band Transceiver (3)
 - AM-FM Radio Receiver
 - FM Stereo Multiplex Adapter (4)
 - Nuvistorized FM Tuner
 - All-Purpose Power Supply
 - ...and much, much more!

NOW AVAILABLE FROM YOUR AUTHORIZED RCA TUBE DISTRIBUTOR.



RCA Electronic Components and Devices, Harrison, N. J.

The Most Trusted Name in Electronics

Technical Data

SHARP-CUTOFF PENTODE
6H56

Maximum ratings and other limits are indicated in the OUTLINE SECTION. Tube must be operated at recommended conditions for maximum life.

Plate Voltage	250 V
Control Grid Voltage	-10 V
Screen Grid Voltage	150 V
Control Grid Current	10 mA
Plate Current	100 mA
Control Grid Power	100 mW
Plate Power	10 W
Control Grid Power	100 mW
Control Grid Resistance	100 Ω
Control Grid Inductance	10 nH
Control Grid Capacitance	10 pF
Control Grid Inductance	10 nH
Control Grid Capacitance	10 pF
Control Grid Inductance	10 nH
Control Grid Capacitance	10 pF

(1)

Application Guide

Maximum Plate Power	10 W	Maximum Plate Power	10 W
Maximum Plate Current	100 mA	Maximum Plate Current	100 mA
Maximum Control Grid Current	10 mA	Maximum Control Grid Current	10 mA
Maximum Control Grid Power	100 mW	Maximum Control Grid Power	100 mW
Maximum Control Grid Resistance	100 Ω	Maximum Control Grid Resistance	100 Ω
Maximum Control Grid Inductance	10 nH	Maximum Control Grid Inductance	10 nH
Maximum Control Grid Capacitance	10 pF	Maximum Control Grid Capacitance	10 pF
Maximum Control Grid Inductance	10 nH	Maximum Control Grid Inductance	10 nH
Maximum Control Grid Capacitance	10 pF	Maximum Control Grid Capacitance	10 pF

(2)

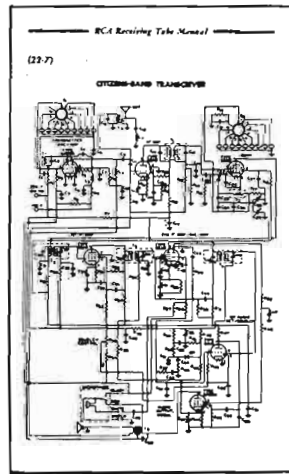

(3)

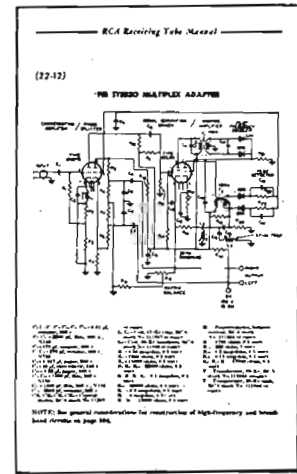

(4)