

MICRO™

The Magazine of the APPLE, KIM, PET
and Other 6502 Systems

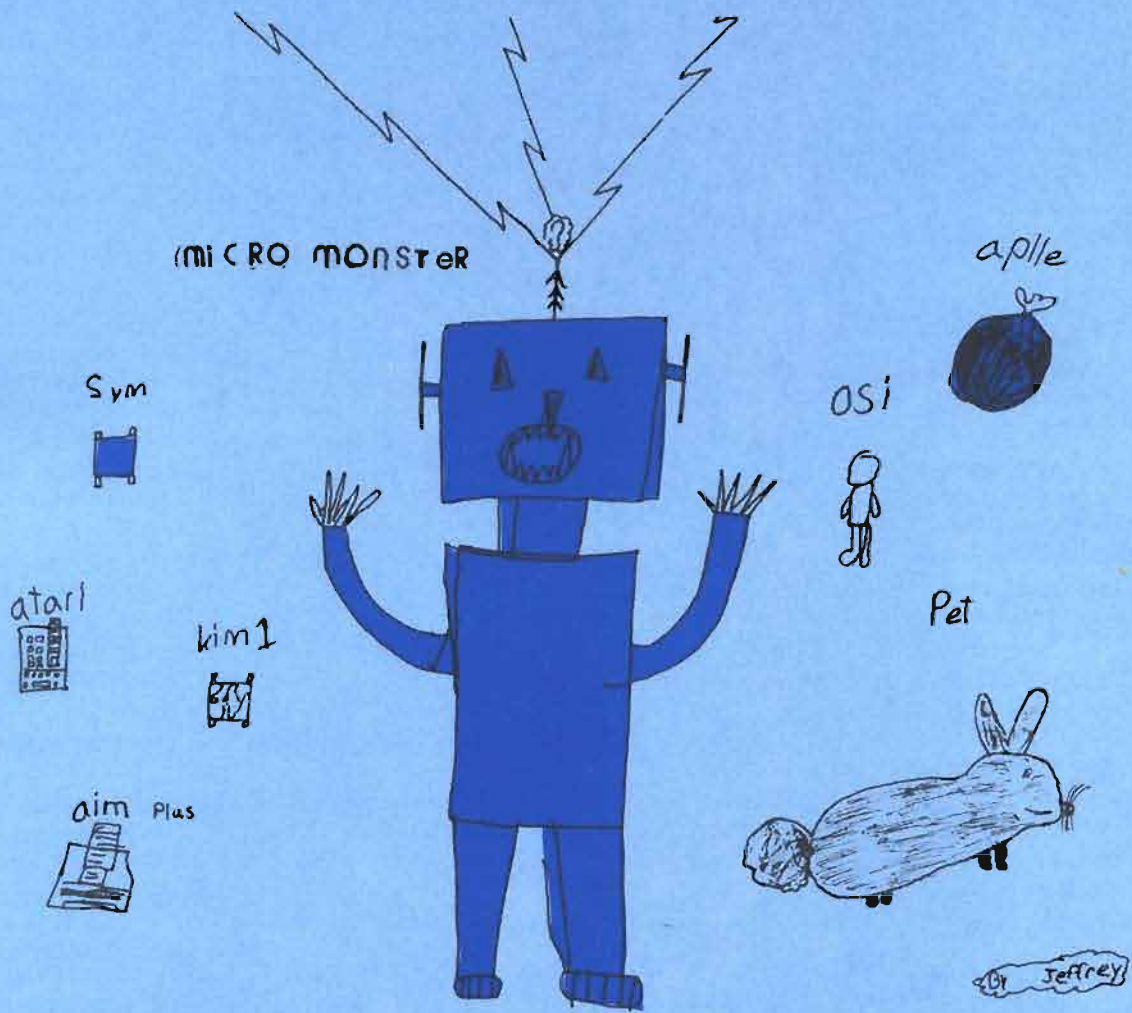

NO. 19 DECEMBER 1979 \$2.00

NOW PRESENTING . . .

Apple[®] software

for your Entertainment · Business · Education

Star Attractions:

FILEMASTER 2 programs: *FORMAT & RETRIEVAL* comprise a powerful data file manager. Great for everything from phone lists to legal abstracts. Needs 32K. Design your own data structure. Up to 500 characters per record. Up to 15 searchable fields in any combination. On Disk **\$34.95**

SPACE Multi-faceted simulation of life in interstellar society. You and opponents must make life & death decisions. Keeps track of your progress from one game to next. Needs 48K and Applesoft ROM. Disk **\$29.95**

Pot O'Gold I or our All New Pot O' Gold II A collection of 49 programs for 16K Apple. Everything from Logic to action games. Only a buck a game. Specify I or II. Price each: Tape **\$49** Disk **\$54**

ADVENTURE Fight off pirates and vicious dwarfs. 700 travel options, 140 locations, 64 objects. Needs ROM & 48K. Disk . . **\$29.95**

16K CASSETTE INVENTORY Use item number, description, stock amount, reorder amount, restock date, cost & sell price. Holds up to 140 items. Tape **\$35**

32K DISK INVENTORY: Use stock numbers description, vendor, record of purchase and sales date, amount on hand, cost & sell price, total value. Holds up to 300 items. Disk **\$40**

With Parts Explosion: Disk **\$50**

32K DATA BASE Cross file for phone lists, bibliographies, recipes. Run up to 9 lines of 40 columns each. Search by item anywhere. Disk **\$20**

24K HI-RES LIFE SIMULATION Conway's equations on 296x180 screen. A mathematical simulation to demo population growth with birth, death and survival as factors. Tape **\$10**

16K CIRCUIT LOGIC DEVELOPMENT AID Evaluate circuits of up to 255 gates, including AND, OR, NOR, NAND, XOR, XNOR and INVERTER. Tape **\$10**

16K MORSE CODE TRAINER Learn Morse Code, and transmit or receive over radio. Tape **\$10**

16K DEVIL'S DUNGEON: Adventure through dark passages where monsters, demons, poisonous gas, dropoffs threaten . . . all to discover fantastic treasures. Comes with instruction book. Tape . . . **\$10**

16K PACIFICA: Discover the floating island and rescue the beautiful princess. To win you must recover the enchanted crown, but you face the threat of magic spells and demons. Tape **\$9.95**

Don't see what you've been looking for, here? Then write for our FREE SOFTWARE CATALOG. We're saving one just for you!

To order, add \$2 shipping. California residents add 6% sales tax. Sorry, we can not ship to P.O. Boxes. VISA/MASTERCHARGE and BANKAMERICARD Welcomed!

RAINBOW'S CASINO 9 gambling games: Roulette, Blackjack, Craps, Horserace, and a few originals that Vegas hasn't heard about. Needs 16K. Tape **\$29.95**

16K SPACE WAR: You in your space capsule battle against the computer's saucer . . . in hi-res graphics. Tape **\$12**

16K MEMORY VERIFY Diagnostic routine to check range of memory. Indicates faulty addresses, data in memory cell, and faulty data. Tape **\$5**

16K APPEODION Music synthesis composes original Irish jigs. Enter your own music and save on tape or disk. Includes 3 Bach fugues. Tape **\$10**

16K APPEVISION Demo for Hi-Res graphics and music. Tape **\$10**

32K COMPU-READ 5 programs to teach you speed reading, in stages. Includes synonym and antonym identification. You control your rate of speed, or keep up with the computer's pace. Disk **\$24.95**

48K PERCEPTION I, II, III random shapes and sizes must be matched. In III, you control format and display time and get weighted scores. Needs ROM. Each Disk **\$24.95**

32K STORY TELLER Use your bizarre imagination and input key words for fantastic and funny tales. Never the same story twice. Tape **\$12.95**

32K WAR/RESCUE Engage in 10 battles with your infantry against the Apple robots. Calculate Apple's strategy and win more battles than the computer. Tape **\$12.95**

24K POLAR PLOT Plot polar equations in Hi-Res Graphics. Tape **\$10**

32K SHAPE SCALER Utility to generate and animate Hi-Res graphic shapes. Simple routine provided to inspect position of shapes, and specify precise X/Y coordinates and scale. Needs ROM. Disk **\$13.95**

32K ZINTAR/PROPHET Great party game. Under control of the mighty Zintar's edict you take a very special trip to the world of Krintar. Heightened visual graphics. Needs ROM. Disk **\$16.95**

APPLE MONITOR PEELED Everything you wanted to know about the Apple Monitor but couldn't figure out. User-written manual in plain English clears your confusion. Only **\$9.95**



Garden Plaza Shopping Center, Dept. 11A
9719 Reseda Blvd., Northridge, Ca 91324
Telephone: (213) 349-5560



HIGH RESOLUTION GRAPHICS

LOOK TO MTU. WE SUPPORT HIGH RESOLUTION GRAPHICS ON:
PET — AIM — KIM — SYM

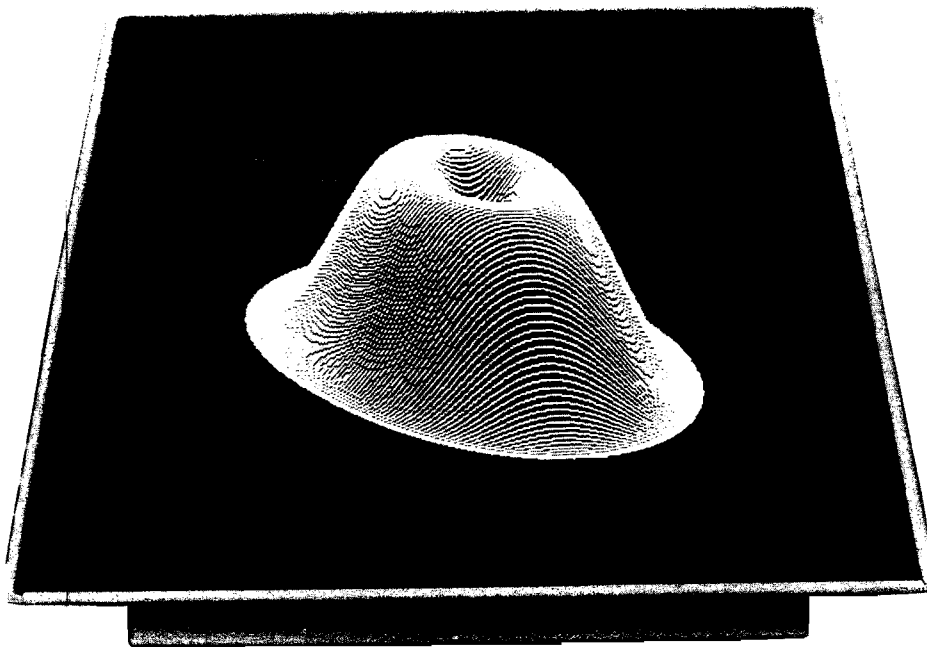
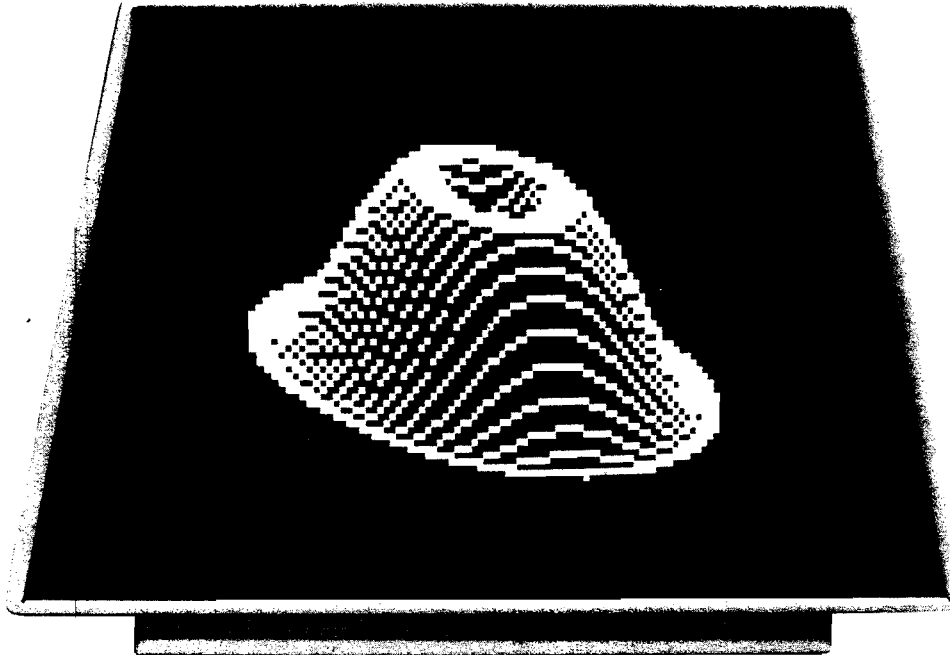

Micro Technology Unlimited

P.O. Box 4596, 841 Galaxy Way

Manchester, N.H. 03108

603-627-1464

Call Or Write For Our Full Line Catalog

Bringing Music Home

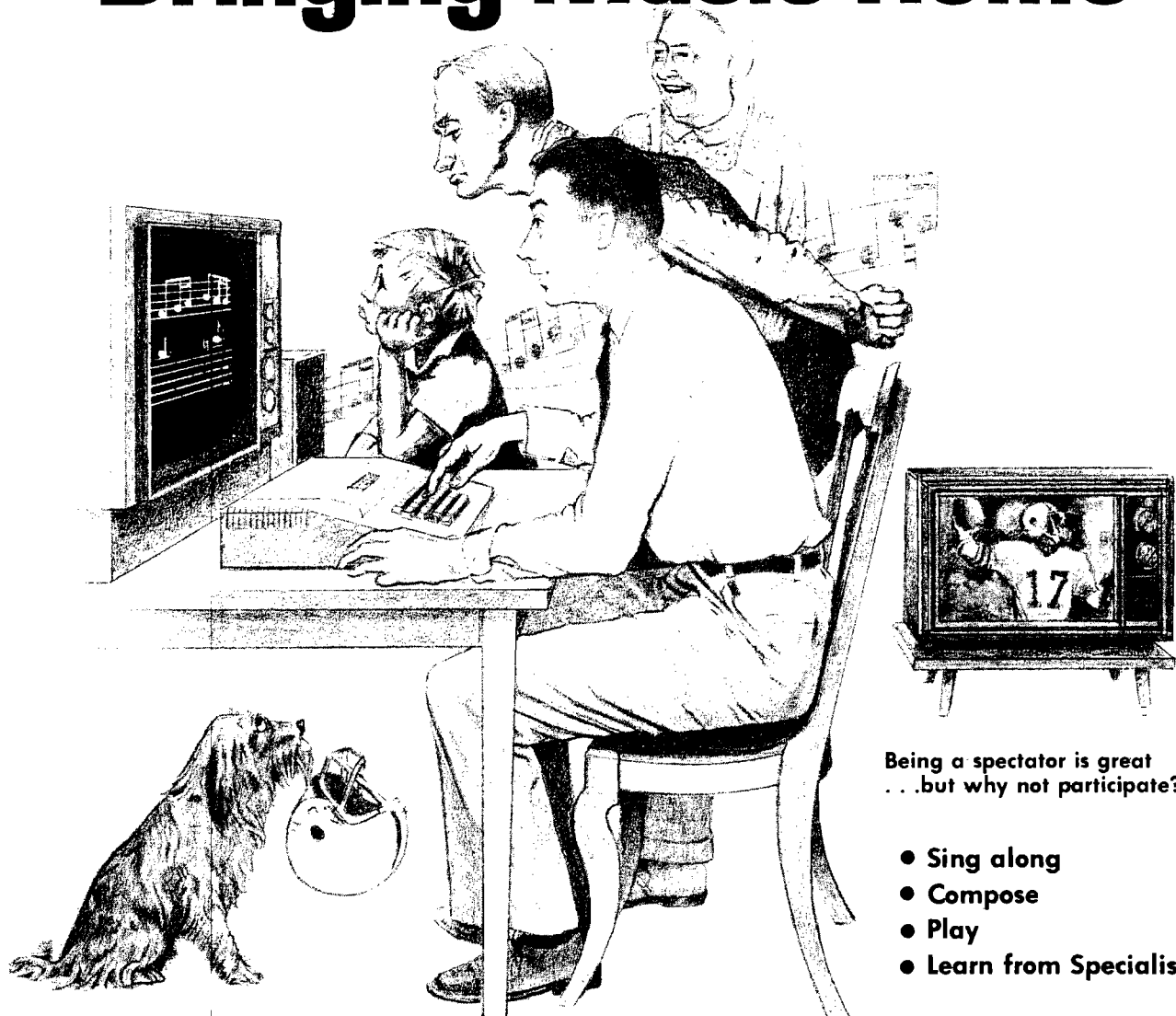

Being a spectator is great
...but why not participate?

- Sing along
- Compose
- Play
- Learn from Specialists

LET MICRO MUSIC TURN YOUR APPLE II® INTO A FAMILY MUSIC CENTER!

VISIT THE APPLE DEALER NEAREST YOU AND ASK FOR A DEMONSTRATION OF MMI'S MICRO COMPOSER™
The MICRO COMPOSER LETS YOU—

- Play up to 4 simultaneous voices
- See all 4 voices at the same time you're hearing the music—a must for music editing!
- Enter music notes by a fast, simple and well-tested coding system.
- Program the pitch, rhythm, and timbre of the music. Tempo is varied by the Apple paddle.
- Choose 7 different tone colors for each voice or create your own tone color.
- Compose, edit, display, and play music through an interactive, command-driven language that's easy to learn.
- Save your music on disk or cassette.
- Hear quality music sound at low cost through the MICRO MUSIC™ DAC card. No amplifier needed! Designed for MMI by Hal Chamberlin and Micro Technology Unlimited.
- Select from future MMI music instruction software to accompany the MICRO MUSIC DAC.

Ask your local dealer for information on MMI products, or contact:



Micro Music Inc 309 Beaufort, University Plaza, Normal, IL 61761

The MICRO COMPOSER is an APPLE II® compatible, low-cost music system designed by the folks at MMI. Our music software was designed by leading experts in music education. A simple step-by-step instruction manual leads you through entering, displaying, editing, and playing music with up to four voices—soprano, alto, tenor, and bass. You can change the sound of each voice to reed, brass, string, or organ sounds and you can even color your own music sounds!



HAVE FUN! THE MICRO COMPOSER comes complete with an instruction manual, software disk or cassette—in either Integer or Applesoft ROM BASIC, and the MICRO MUSIC DAC music card. Just plug the MICRO MUSIC DAC into the APPLE extension slot and connect the audio cable to a speaker.

Suggested retail price \$220.

MICRO™

Table of Contents

Data Statement Generator by Virginia Brady	5
Editorial	9
How to do a Shape Table Easily and Correctly by John Figueras	11
MICRO Product Review	23
Relocating PET BASIC Programs by Michael Tulloch	25
If You Treat It Nicely It Won't Byte by Jack Robert Swindell	31
Sharpen your AIM by Robert E. Babcock	37
An Additional I/O Interface for the PET by Kevin Eiler	40
A 60 X 80 Lite for the PET by Werner Kolbe	45
Applesoft Program Relocation by George S. Guild, Jr.	49
KIM and SYM Format Cassette Tapes on APPEE II by Steven Welch	51
Graphics and the Challenger 1P by William L. Taylor	61
Time of Day Clock and Calendar for the SYM-1 by Gasmir J. Suchyta, III and Paul W. Zitewitz	67
APPLE II Speed Typing Test With Input Time Clock by John Broderick	69
SUMTEST: A Memory Test Routine for the 6502 by S. Felton Mitchell, Jr.	73
The MICRO Software Catalogue: XV by Mike Rowe	75
6502 Bibliography: Part XV by William R. Dial	77

December 1979
Issue Number 19

Staff

Editor/Publisher
Robert M. Tripp

Assistant Editors
Mary Ann Curtis
Evelyn M. Heinrich

Business Manager
Maggie E. Fisher

Circulation Manager
Carol A. Stark

Production Assistant
L. Catherine Bland

Comptroller
Donna M. Tripp

Cover Artist
Jeffrey S. Tripp
(9 years old)

Advertiser's Index

Apple Shoppe	65	Powersoft, Inc.	118
Beta Computer Devices	47	Programma International	42, 43, 57
Classified Ads	68	Progressive Software	50
COMPAS	36	Rainbow Computers	11C
The Computerist, Inc.	35	RNB Enterprises	68
Computer Shop	30	SKYLES Electric Works	24, 40, 41, 79
Computer World	28, 29	Small Systems Services, Inc.	65, 69
Connecticut microComputers	58, 59, 60	Software	4
Electronic Specialists, Inc.	34	Softside Publications	111
H. Geller Computer Systems	27	Softside Software	42
Home Computers	8C	Southwestern Data Systems	63
Hudson Digital Electronics	72	S.P.A.R.C.	22
Information Unlimited Software	48	Synergistic Software	7
Instant Software, Inc.	70, 71	United Software of America	34
Micro Music, Inc.	2	Webcor Electronics	8
Micro Technology Unlimited	1, 8C	West Gate Electronics	60
Muse Software	17		

Data Statement Generator

Virginia Lee Brady
D-3 Arthur Ct., Apt. 453
Salisbury, MD 21801

If you have ever had trouble getting those pesky DATA statements at the end of your BASIC program correct, then you will appreciate this program which "writes" its own DATA statements! Written for APPLESOFT, it should be adaptable to other BASICs.

I had just finished adding several new data statements to a sewing program of mine that utilized a number of data statements, and now I was reading the information into their respective arrays. "BEEP," said the Apple, "****SYNTAX ERROR." I found the offending line; I'd left out one of the elements and Applesoft would not accept "RED" as a value for "YARDS." I entered the line again and this time I typed the wrong line number and erased my previous line. There ought to be a way, I decided, to let the Apple keep track of these things. I experimented with input statements, and while these allowed me to update the arrays, I couldn't save the information.

Using the information from Jim Butterfield's article on "Pet Basic" and the information in the Applesoft Manual, I developed a program that "writes" its own data statements. This routine automatically increments the line numbers and inputs the data elements in response to appropriate prompts. It's all poked into place and becomes a permanent part of the program.

It is first necessary to understand how ROM Applesoft is stored. The basic program begins at \$801 (2049 decimal) and there are only two bytes between the end of the program and the start of the simple variable table which begins at LOMEM:. Anytime a Basic line is entered, altered, or deleted, the value of LOMEM: is changed and the program must be rerun to incorporate this new value. Therefore, LOMEM: must be set at

some value past the end of the program to allow for expansion of the program without writing on top of the variable table.

To use this routine it is also necessary to recognize the following locations of a data statement in Applesoft:

- 2 bytes—pointer to next line of Basic (to next pointer)
- 2 bytes—hex equivalent of the line number
- 1 byte—"83"—token for 'DATA'
- N bytes—ASCII equivalents of the program line
- 1 byte—"00"—indicates the end of the line

Then the sequence starts again until there are two bytes of "00" in the first two positions (total of three "00" bytes in a row.)

The program uses the fact that the locations \$AF.BO (175-176 decimal) hold the value of the location where the next line number would go; or put another way, two less than this is where the "pointer to next line" would go. Call this PSN (for position). Thus the values to be poked into PSN and PSN + 1 are the low and high order bytes of the hex equivalent of LINE number. Then the DATA token (131 in decimal) is placed in PSN + 2. Since this program was designed to handle several elements in one data statement, a series of strings is next input as one string array. (It could just as easily have been done as several

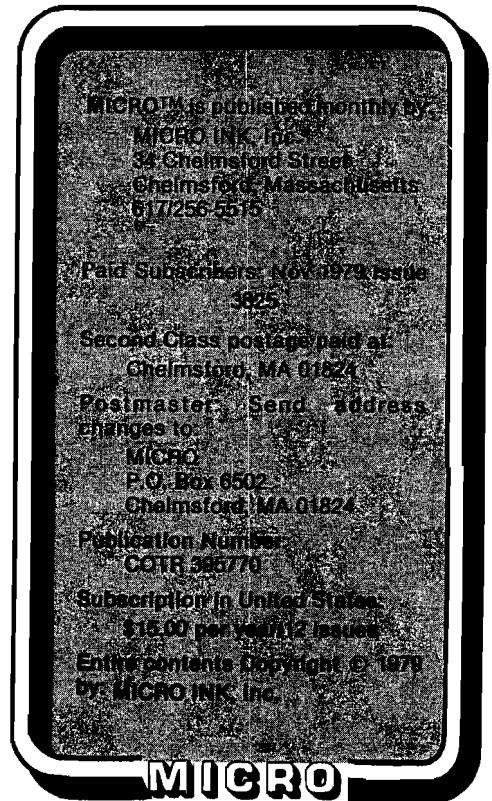

MICRO is published monthly by
MICRO INK, Inc.
34 Chalmers Street
Chalmersford, Massachusetts
01725-5515

Paid Subscribers: November 1979 issue
\$8.25

Second Class postage paid at
Chalmersford, MA 01824

Postmaster: Send address
changes to:

MICRO
P.O. Box 6502
Chalmersford, MA 01824

Publication Number
COTR 366770

Subscription in United States
\$15.00 per year/12 issues

Entrepreneurs Copyright © 1979
by MICRO INK, Inc.

MICRO

"INPUT A\$" 's, but using an array allows you to change a string before it is poked into memory). This is handled in lines 1035-1045. If there are no further changes, then the individual strings are concatenated into one long string with commas separating the individual substrings. Next this string is poked, one ASCII value at a time, into PSN+1+2; then the "0" is poked into the end as the terminator.

Since PSN + 1 + 3 is the start of the next line (remember the value of I was incremented one extra time in the FOR-NEXT loop), call this NUMBER, convert it into hex, and poke it into PSN-2 and PSN-1. If the program is to be continued, PSN is given the value of NUMBER + 2 and the sequence restarted. If this is to be the last entry, then place "0" into NUMBER and NUMBER + 1. All that remains is to reset the \$AF.BO pointers to reflect the new value of the end of the program (NUMBER + 2). This is done in line 1085.

List the program — the new data statement is in place at the end of the program and can be read into the necessary string of numeric variables. If

you want to use this program as a subroutine to an existing data program, where you already have some data statements being read in, you could use the fact that \$7B.7C gives the line from which data is being read. Then insert a statement that sets LINE equal to PEEK(123) + PEEK(124)*256.

If your program uses trailers, then have a TRAILER\$ that is the same as your trailer line (eg. "0,0,0,0"). To write over this, set PSN equal to PSN-6-LEN(TRAILER\$) and your first data statement will start that much earlier and replace this trailer. At the end of the program, handle this as before and poke the TRAILER\$ into place... This way every time you update your program, the original trailer is "erased" and re-appended after the last data statement.

It is important to remember that the line numbers you insert this way must be greater than those of an existing program line. If not, they will be placed at the end of the program, but will not be recognized as legitimate line numbers. (If you try to erase or list it, Applesoft, not finding it between the next lower and

next greater line numbers will think it does not exist.) Also, do not try to Control-C out of the program once it has started the "poking" portion, since the pointers would be incorrect at this point and Applesoft would not know where to find the end of the program.

Since I developed this routine, I have used it in another program and in both cases I have run into only one problem. When I've added lines, saved the program to tape and later tried to reload it, I got an error message even though it still listed and ran alright. This may have something to do with the header on the cassette tape which I know contains the length of the program; but I've not yet found out how to alter this. I would appreciate any information a reader could offer. This has not, however, been a problem when a disk is used. Other than that, it's worked fine and it sure beats typing:

3000 DATA RED, SOLID,
1.25,POLYESTER

3005 DATA BLUE/GREEN,
STRIPE, 1, COTTON...!!

```

10  REM EXAMPLE OF A ROUTINE THAT AUTOMATICALLY WRITES
20  REM ITS OWN DATA STATEMENTS THROUGH THE USE OF INPUT STRINGS
30  REM
40  REM VIRGINIA LEE BRADY
50  HOME
60  LOMEM: 4000
70  LINE = 2000
80  GOTO 1000
90  REM CALCULATE HI/LOW BYTES
100 HI=INT(NUMBER/256):LO=(NUMBER/256-HI)*256:RETURN
1000 REM INPUT SUBSTRINGS
1010 PSN=PEEK(175)+PEEK(176)*256
1015 INPUT"INPUT THE COLOR ";F$(1)
1016 INPUT"INPUT THE PATTERN ";F$(2)
1017 INPUT"INPUT THE YARDS IN DECIMAL ";F$(3)
1018 INPUT"INPUT THE FABRIC TYPE ";F$(4)
1020 REM ALLOW CHANGES
1035 FOR I = 1 TO 4:PRINT I; TAB(5)F$(I): NEXT I
1040 INPUT"ANY CHANGES ? ";Y$: IF LEFT$(Y$,1)="N" THEN 1050
1045 INPUT"WHICH ONE ? ";W: PRINT"CHANGE PART ";W;" TO ";: INPUT
    F$(W): GOTO 1035
1050 F$="":FOR I = 1 TO 3:F$= F$ + F$(I) + ","; NEXT: F$= F$+F$(I)
1055 LINE = LINE + 5: NUMBER = LINE: GOSUB 100
1060 POKE PSN, LO: POKE PSN + 1, HI: POKE PSN + 2, 131
1065 FOR I = 1 TO LEN(F$): PONE PSN + I + 2, ASC(MID$(F$,I,1)): NEXT I
1070 POKE PSN + I + 2,0: NUMBER = PSN + I +3:GOSUB 100
1075 POKE PSN -2,LO: POKE PSN-1,HI
1080 INPUT"ADD MORE ? ";Y$: IF LEFT$(Y$,1)="Y" THEN PSN = NUMBER + 2:
    GOTO 1015
1085 POKE NUMBER,0: POKE NUMBER + 1,0: NUMBER = NUMBER + 2: GOSUB 100:
    POKE 175,LO: POKE 176,HI
1090 END

```

Figure 1: "MAP" of Two New DATA Statements being Added

Original Last Line			First Added Line			New Last Line		
POINT LOW	08	1000	PSN-2	0A	2000	PSN-2	40	1234
POINT HIGH	10	1001	PSN-1	20	2001	PSN-1	12	1235
LINE LOW	64	1002	PSN	65	2002	PSN	66	1236
LINE HIGH	00	1003	PSN+1	00	2003	PSN+1	00	1237
"DATA"	83	1004	PSN+2	83	2004	PSN+2	83	1238
data	XX	1005	PSN+3	XX	2005	PSN+3	XX	1239
	XX	1006	PSN+I+3	XX	2006	PSN+I+3	XX	123A
"END"	00	1007		XX	2007		XX	123B
NEXT LOW	00/02	1008		XX	2008		XX	123C
NEXT HIGH	00/20	1009	"END"	00	2009		XX	123D
Orig. End		100A	NEXT LOW	36	200A		XX	123E
			NEXT HIGH	12	200B	"END"	00	123F
						NEXT LOW	00	1240
						NEXT HIGH	00	1241
						(AF.B0) → New End		1242

Note: Original Last Line
NEXT LOW/HIGH change from 0000
to 2002.

(AF.B0) → New End

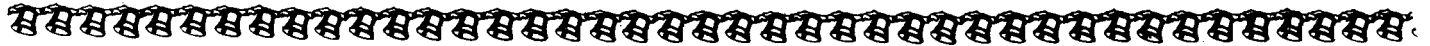

SYNERGISTIC SOFTWARE

MAILING LIST DATABASE

presents

HIGHER GRAPHICS

This new, user oriented mailing list program introduces professional quality and speed to the processing of name and address files. The self prompting features of Mailing List Database aid the user in creating and maintaining address files. Labels or printed lists can be readily produced at any time.

SINGLE KEYSTROKE COMMANDS - Any record can be displayed, edited, deleted or printed with just a few keystrokes. Updates and additions have never been easier.

CONVENIENT DATA ENTRY - All required inputs are prompted by the program. Recurring information and default names and numbers can be entered with a single keystroke.

MACHINE LANGUAGE SEARCHES - Any record can be found in less than one second by specifying part or all of 1 or 2 fields.

MACHINE LANGUAGE SORTS - All records can be sorted by any field or combination of any 2 or 3 fields. Sorting 200 records, comparing 50 characters takes less than a minute. After sorting, files can be saved, printed, or displayed.

FLEXIBLE APPLICATION - The program can be adapted to numerous commercial and personal uses. Current suppliers, customers, clients, patients, members, even Christmas card lists can be kept on individual, updated files at all times.

Mailing List Database is supplied on disk and comes with a program for automatically converting existing text mailing list files. It requires 48K Apple II with Applesoft on ROM (or language card) and at least one disk drive. Now available for \$34.50.

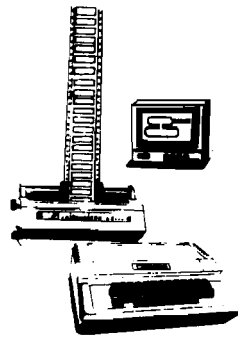

A collection of programs and shape tables that lets any programmer create detailed and beautiful high resolution displays and animation effects. Make your programs come alive by utilizing the full graphical capabilities of the Apple II. Package contains:

SHAPE MAKER - Create shapes with this easy to use shape table generator. Start new shape tables or add to existing one. Correct shapes as they're being produced. Delete unwanted shapes from the table. Display any/all shapes with any scale or rotation at any time.

TABLE COMBINER - Pull shapes from existing general purpose tables (see below) and add the ones you want into a new special purpose table. May combine shapes from any number of tables. All shapes can be viewed or deleted.

SCREEN CREATOR - Place your shapes on the high-res screen. Add areas of color and text to make detailed displays or game boards for high resolution games. A screen can be created in minutes with this easy to use program. Utilizes any number of shape tables and allows screen to be saved at any time.

SHAPES - Four shape tables with over 100 shapes are provided. Included are alphanumeric, chess figures, card symbols (club, spade, etc.), tanks, planes, spaceships, ships, cars, trees, mountains, buildings, etc. Add the shapes you like to your own tables.

HIGH RES TEXT - How to use high resolution graphics in your programs. Animation effects and display techniques.

Requires Apple II with 32K and disk drive. Complete package now available for \$24.95

AVAILABLE NOW AT YOUR DEALER OR SEND CHECK TO SYNERGISTIC SOFTWARE, 5221 120th AVE. S.E., BELLEVUE, WA 98006
(Washington State Residents add 5.3% sales tax)

RUN THIS PROGRAM
10 Enter data in form below
20 Goto mailbox
30 Mail form
40 Receive the Personal
Computer Catalog
50 End

Well Done!

Follow this simple program and you will receive The Personal Computer Catalog. The one reference book to fine quality personal computers, software, supplies and accessories.

This valuable catalog is FREE so mail your order today.

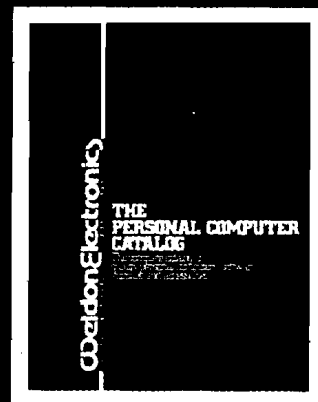

Name _____
Address _____
City _____ State _____ Zip _____
Do you own a computer? _____ What type? _____
Do you use your computer for: Business? _____
Personal? _____ Education? _____ Other? _____

Mail this form to:

Weldon Electronics

SERVING THE PERSONAL COMPUTER INDUSTRY

Or phone: (612) 884-1475

Weldon Electronics
4150 Hillcrest Road
Wayzata, MN 55391

Women and Children Last!

I have a feeling that the real "revolutionary" part of the microcomputer revolution is just starting to take place. Of course, parts have gotten smaller and cheaper; more software is available; new high level languages are coming along; and so forth. The real significance of all of these things lies, I believe, in the fact that millions of new people are going to get involved in computers and computing. While the overwhelming majority of individuals involved in all levels of computers currently are men, the microcomputer has made access to computers available to women and children too. This growing interest was demonstrated to me recently at a computer show in Boston. A significant number of the people who stopped by the MICRO booth to ask questions or talk about systems were women and teenagers. This issue of MICRO contains the first article by a woman. We have several articles in process from the younger set. The home computer is starting to make its effect.

I am hoping that the inclusion of these two new groups of computerists is going to have a beneficial impact on computing. Many of the individuals who owned the earliest micros were men already in the computer business in one way or another. They came to microcomputing with a large set of preconceived notions. Most microcomputer programs in use today are either games or new versions of old programs. Not

many really exciting new concepts, ideas, programs, techniques, languages, approaches, etc. have appeared — yet. One of the reasons has to be the self-imposed restraints of the microcomputer 'professionals'. Since they already know 'how to solve problems', they tend to use the old tools that they are used to: BASIC, index sequential access methods, etc., and may not be alert to the new possibilities that the microcomputer provides. Where are the 'innocents' willing and able to try new directions, create chaos out of order, invent new techniques?

Watching my six and eight year old children 'attack' the computer answers the question for me. They are not interested in what "Daddy knows about the computer". They just want to push and poke and find out for themselves. And my wife — she asks some pretty insightful questions when I try to explain why a program does what it does. Perhaps the concept of 'ego-less programming' really takes on meaning when you get amateurs just having fun.

If microcomputing is going to break out of the doldrums of games and inventory control, then significant numbers of new ideas and individuals are going to have to be added to the system. Perhaps 'a child will lead them'!

Robert M. Topp



**PO Box 6502
Chelmsford, Mass 01824
617-256-5515**

"The BEST of MICRO Volume 1" contains all of the important material from the first six issues of MICRO in book form.

"The BEST of MICRO Volume 2" contains all of the important material from the second six issues [#7 to 12] of MICRO in book form.

"ALL of MICRO Volume 2" is all six issues of Volume 2, issues 7 to 12, at a special reduced price for a limited time while supplies last.

Back Issues:

Issues 7 to 12:
Issues 13 on:

All payments must be in US dollars.
Make checks payable to: MICRO
Foreign payments in International Money Order or cash.

Subscription: One Year = 12 issues. Circle correct category and write amount in space provided.

Surface:

United States \$15.00
All Other Countries \$18.00

Air Mail:

Central America \$27.00
Europe/So. America \$33.00
All Other Countries \$39.00 \$

"BEST of MICRO Volume 1"

Surface \$7.00
Air Mail \$10.00 \$

"BEST of MICRO Volume 2"

Surface \$9.00
Air Mail \$13.00 \$

"ALL of MICRO Volume 2"

Surface \$9.00
Air Mail \$13.00 \$

No. Surface @ \$1.75 each = \$
Air Mail @ \$2.75 each
No. Surface @ \$2.25 each = \$
Air Mail @ \$3.25 each

TOTAL \$

If you are a subscriber, attach label or write subscription number here:

Name:

Address:

City: State: Zip:

Country (if not U.S.):

Help MICRO bring you the info you want by completing this short questionnaire.

Microcomputers Owned/Planning to Buy: AIM SYM KIM PET APPLE OSI Other:

Peripherals Owned/Planning to Buy: Memory Disk Video Printer Terminal Other:

Microcomputer Usage: Educational Business Personal Control Games Other:

Languages Used: Assembler BASIC FORTH PASCAL Other:

Your comments and suggestions on MICRO:





Introducing AppleSeed, our newest publication to whet your Apple* appetite!

We invite you to subscribe to AppleSeed - the magazine that is to the Apple II* what SoftSide is to the TRS-80**. It offers the newest in software programming hints and ideas tailored especially for your computer. AppleSeed features challenging programs for both the do-it-yourselfer and the individual interested in pre-packaged programs and games . . . your own preview of the best available on the market today. A typical slice of AppleSeed consists of one major (new 16K) commercial level program (completely listed for your keying pleasure), accompanied by two or three applications for practical use or fun, supplemented by informative articles to polish your Apple*. Get right to the core of your Apple* needs and order AppleSeed today! 12 issues, 1 year, \$15.00. AppleSeed is the newest member of . . .

SoftSide™

PUBLICATIONS

6 South Street, Milford, NH 03055
(803) 873-5144

*A registered trademark of Apple Computers. **A registered trademark of Radio Shack and Tandy Corp.

How to do a Shape Table Easily and Correctly!

John Figueras
65 Steele Road
Victor, NY 14564

The mechanism for generating shapes and characters in APPLE High Reslution Graphics is cumbersome and prone to error. A very clear explanation of the mechanism and pitfalls is presented here. But, best of all, a program is presented which permits the user to create the shapes interactively, using the Keyboard and Display.

The Problem

One of the most discouraging tasks facing the owner of an APPLE computer is the creation of a shape table. The table is required for generation of shapes and characters for high resolution graphics, since APPLE does not offer pre-formed plotting characters. Thus, if one wants to label the axes of a graph, the shape table can be used to supply the characters required for the labels. It is also useful for producing special shapes for games.

If, like me, the reader has ever tried to prepare a shape table using APPLE's procedure, I am sure he/she discovered, as I did, that the procedure is time-consuming, tedious, and error-prone. In several attempts, I have yet to generate a shape table using the manual procedure given by APPLE, that didn't end up with missing dots, spurious projections or an unpredicted shape. At first I thought the problem was of my own making, since APPLE's directions are clear and apparently faultless. The use of the words "apparently faultless" in the last sentence implies that what I found was in fact the case: APPLE's procedure for creating a shape table has

some real glitches. I discovered these in the course of pursuing the work described below, and developed a procedure that circumvents the glitches and produces perfect results every time. So, read on.

APPLE's procedure for preparation of a shape table is carried out as follows: the shape is first laid out as a dot pattern on a grid (Figure 1); a series of plotting vectors is superimposed on the pattern to trace out a continuous path that covers all points to be plotted. The plotting vectors are defined either as move-only or as plot-then-move vectors.

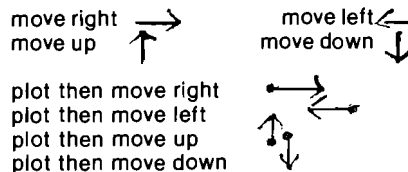

The shape in Figure 1 is reproduced in Figure 2 with the chain of plotting vectors superimposed. The plotting vector chain may start at any point, but in selecting this point you should know that the initial point in the shape is the point that gets plotted at coordinates

(X,Y) in the DRAW command. Therefore, your choice of initial point determines the justification of the shape or character with respect to the plotting location. If you want a center-justified character, then start the vector sequence at the center of the shape; a left-justified character must be started at the left side, and so on. The APPLE manuals give the impression that it is immaterial where you start the shape, but if you want to have your characters fall properly on a line, it is something you must attend to. Knowing justification of the shape is important in games where things bang together and in building up large patterns by plotting sub-units adjacent to each other—cases in which it is important to know where the boundaries of the shape fall relative to the point at which it is plotted.

The next step in preparing the shape table requires that the chain of plotting vectors in Figure 2 be unfolded into a linear string, beginning with the initial point of the pattern. For the shape in Figure 2, the following sequence of vectors is obtained after unfolding:

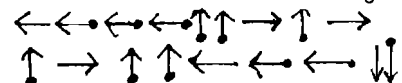

The plotting vector string is then broken up into groups of two or three, each group (confusion!) reading from right to left. To add a little more danger to the game, the rules require that no group of vectors may end with a move-up vector or with a plot-then-move vector, in which case the group will contain at most two plotting vectors. The table in Figure 3a shows how the above string is subdivided. In this case, because of the restrictions on termination, each group can contain only two vectors. The rules for formulating these vectors groups are actually quite soundly based, as will become clear in later considerations.

We are not done yet. In the next step, each plotting vector as it appears in the table in Figure 3a is replaced by a 3-bit (octal) code. The code is shown in Figure 4, along with the decimal equivalents. Note that the decimal code for a plot-then-move vector is obtained simply by adding decimal 4 to the corresponding move-only vector. There is a certain amount of method in this madness. The 3-bit code translation for the plotting vectors in Figure 4, which represent our shape, is displayed in Figure 3b.

The next opportunity for confusion (and error) appears now, when the bit-strings in Figure 3b are re-grouped and assembled into nybbles (Figure 3c) and the nybbles are each translated into hexadecimal numbers (Figure 3d). The pairs of hexadecimal numbers, of course, represent the content of one byte. This is the byte that is stored in the shape table. In essence, then, the shape table is a list of hexadecimal numbers, which, after translation into binary and re-grouping, represents the collection of 3-bit codes equivalent to the plotting vectors, which in turn represent the original shape. In the parlance of mathematics, the shape has been *mapped* onto the set of hexadecimal numbers.

If by now the reader is feeling a tingle of impatience with this description, multiply that feeling by a factor of at least ten, and you will be on the verge of understanding what it feels like to carry out these steps. To add to the frustration, there are enough booby traps laid by APPLE to ensure quite a decent probability that after you have gone through this travail, the shape that finally appears on your screen will be misshapen. With a computer at hand, it seems silly to be bogged down by a process like this—and that's what the rest of this article is about: a computer program in APPLESOFT BASIC that allows easy graphic input of a shape or character with automatic generation and storage of a correct shape table—graphics without tears, so to speak.

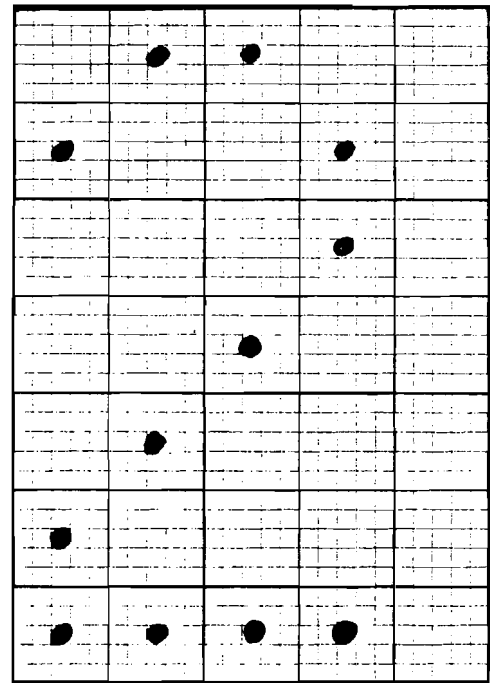

Figure 1: Shape to be coded

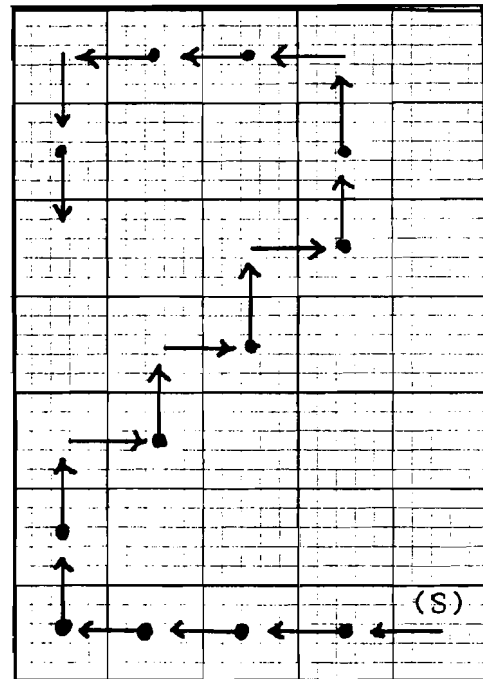

Fig. 2: Layout of Plotting Vectors. (S) is the starting point. With this choice of (S), the shape will be lower right justified and will plot with one empty column to the right of the shape.



















		00 111 011	0011 1011	3B
		00 111 111	0011 1111	3F
		00 100 100	0010 0100	24
		00 100 001	0010 0001	21
		00 100 001	0010 0001	21
		00 100 001	0010 0001	21
		00 011 100	0001 1100	1C
		00 111 111	0011 1111	37
		00 110 010	0011 0010	32

Fig. 3: Translation of shape vectors to Hexidecimal Code

Approach to a Solution

Every computer programmer has his own mind-set. For some, it is structure: a beautiful program that reads like a novel. For others—start at the middle and develop a nice, tight, efficient algorithm. I am an input-output bug. To me, the proper questions that should be first answered are: how can I make it easy for the user of the program to get his data into the program; and how can the output be made digestible? In the present case, of course, the major problem is one of input. With the equipment at hand—an APPLE keyboard, video screen and a couple of floppy disks—I settled on a display of a 15 × 15 grid and a cursor that can be moved by hitting appropriate keys (Up, Down, Left, and Right). The shape is created by plotting the shape as a dot pattern under control of the moveable cursor, using the P (for Plot) key to lay down the dot pattern. One necessary key is the Quit key, which informs the computer that the shape is done. A convenience key, E for Erase is provided to accommodate some of my sloppy keyboard habits; it facilitates undoing the last plotted point. The selection of keys U,D,L and R for directing the cursor was modeled after the set of allowed plotting vectors (there are no diagonal moves in the set), and was a fortunate selection for easy formulation of the algorithm.

While the general format for input was quite clear, the approach to translating that input into a shape table was not immediately clear. Two procedures are possible: you can store all of the input data in some sort of two-dimensional array in memory and then

analyze it, or you can take the input data as they are acquired and develop the shape table on the fly. I seriously considered the first path, and in fact, wrote a program that would translate the input pattern into a matrix of zeroes and ones. Further consideration showed that analysis of the pattern would be difficult, one of the major problems being that of ensuring proper plotting of the shape with respect to its starting point, i.e., justification. Moreover, the most efficient approach in terms of processing time and storage requirements for the shape table is to confine generation of the plotting vectors to the occupied cells of the grid as much as possible. Such pattern tracing on an arbitrary two dimensional array presents a formidable search problem, particularly with disconnected patterns. The solution of the problem of efficiently tracing the input pattern was obvious as soon as I realized that the keystrokes used by a person entering the pattern on the grid constituted a continuous record of the pattern. By analyzing the keystroke pattern, I could produce a string of equivalents. The inspiration for this may be tracable in part to my knowledge of the way in which chemical structures are recorded at Chemical Abstracts Service of the American Chemical Society, where chemical typewriters, used for creating chemical structures, are connected to computers which record the keystrokes of the operator entering the structure. The record of keystrokes can then be "played back" to reproduce the structure exactly as it was keyed in. With this basic approach decided upon, the outline of the required algorithm became clear:

- 1) Select the position in memory at which the shape table is to be stored.
- 2) Generate and display the working (15 × 15) grid.
- 3) Input the starting coordinates for the shape (required for justification).
- 4) Generate the proper 3-bit codes that represent the plotting vectors, based on the keystrokes used to input the pattern.
- 5) Assemble the 3-bit codes (in groups of two or three, depending upon APPLE'S strictures) into a byte.
- 6) Store the assembled byte in the shape table.
- 7) Provide for proper finishing-off of the current byte when the Quit key is hit.
- 8) Add an end-of-record mark (a zero byte) required by APPLE as a shape terminator.
- 9) Store the table.

Most of these steps are straightforward, but two of them, generation of the 3-bit codes that represent plotting vectors, and their assembly into bytes (steps 4 and 5, above), require further elaboration.

In APPLESOFT BASIC, the character returned by a keystroke is accessible with a "GET" command; the instruction GET KEY\$ will load the character accessed by the next keystroke into the variable KEY\$. We may examine KEY\$ to determine whether it contains a "D", "L", "U", or "R" and then do a table look-up (using the definitions in Figure 4) to retrieve the decimal value associated with the direction implied by the keystroke. Each decimal value, of course, as stored in memory will generate the proper 3-bit binary code. Subsequently, the keystroke preceding the current one (which we thoughtfully saved in variable KSVE\$) is examined. If KSVE\$ is a "P", then the current 3-bit code must represent a plot-then-move vector and decimal 4 us added to the decimal factor for the current key. If KSVE\$ is not a "P", then the current decimal key equivalent remains unaltered.

Assembly of the 3-bit codes into bytes involves only basic consideration of decimal to binary conversion. Byte assembly is done in the program as each 3-bit code becomes available, but for the purposes of discussion, let us assume that 3-bit codes, V_1, V_2, V_3 are available in that order from the last three keystrokes. The first 3-bit code initializes the byte:

$$\text{BYTE} = V_1 \quad 0000\overset{V_1}{\text{XXX}}$$

The second 3-bit code must be added to the byte, but must first be left-shifted three bits if the V_1 bits already present

are to remain unchanged. This is done by multiplying V_2 by 8:

$$\text{BYTE} = \text{BYTE} + 8 \cdot V_2 \quad \overset{V_2}{\text{00}} \overset{V_1}{\text{YYYYXX}}$$

Now for V_3 . To refresh your memory, you will observe in Figure 4 that all plot-then-move 3-bit codes have their left-most bits "on." Since there are only two bits remaining unfilled in the byte, there is no way in which the plot status of the third 3-bit code can be entered into the byte. In this case, processing of the byte stops, and it is stored in the shape table, while V_3 is used to initialize the next byte. This is the reason that plotting vectors cannot be stored as end vectors in a byte, one of APPLE'S restrictions previously noted. In similar fashion, if V_3 corresponds to a move-up vector, with all bits zero, it is not loaded into the current byte, but is used to initialize the next byte. The reason for this is not so obvious, but is related to the aforementioned deduction that plotting vectors cannot appear as end vectors in the byte. For, suppose that the zero move-up vector V_3 could be stored as an end vector; then everytime V_3 happened to be a plotting vector, the last two bits in the byte would be a zero, and undesired up-moves would be enabled whenever a plot-then-move vector happened to occur in V_3 . APPLE'S restrictions make sense!

In the event that V_3 is neither a move-up nor a plot-then-move vector, it is added to the byte, for it then consists of an unambiguous two-bit code (Figure 4) that can fit into the remaining two bits of the byte. Addition of V_3 requires a 6-bit left shift of V_3 to avoid changing the bits already present. This is done by multiplying V_3 by $64 (= 2^6)$:

$$\text{BYTE} = \text{BYTE} + 64 \cdot V_3 \quad \overset{V_3}{\text{ZZ}} \overset{V_2}{\text{YYYY}} \overset{V_1}{\text{XXXX}}$$

Earlier, I mentioned glitches designed into APPLE'S shape procedure that would offer problems in obtaining correct shapes in graphics. There are actually two kinds of glitches, one predictable and the other not. The predictable one is a consequence of two facts: 1) APPLE uses a zero byte as an end-of-record mark to terminate every shape; 2) the move-up vector is represented by a 3-bit code of 000. It follows that several move-up vectors in a row will generate an end-of-record mark and any part of the shape following thereafter will be forgotten. That's bad enough. Worse is the unexpected fact that move-up codes (000) that lie on the left part of the byte (most significant bits) are not recognized. For example, consider the two cases of a plot-then-move right command followed by a move-up command,

00000101 (decimal 5)
and a move-up command followed by a plot-then-move right command,

00101000 (decimal 40).

Presumably, these commands should give the same net result. That's what you think, and what I thought also! In fact, the move-up command implied in the left bits of decimal 5 is not recognized by the system, and the byte is interpreted as a plot-then-move right instruction only. Therefore, if you try to generate a 45° line with the sequence

plot-then-move-right: move-up:
plot-then-move-right: move-up...

you will get a horizontal line, whereas the sequence

move-up: plot-then-move-right:
move-up: plot-then-move-right...

will give the desired 45° line!! There is nothing in APPLE'S literature that would lead the unwary to suspect that these two sequences will not plot alike. Now you know the source of those misshapen shapes.

The two problems described in the preceding paragraph—premature end-of-record mark and non-plotting up-vectors that appear in the left bits—arise from the definition of the up-vector as a zero 3-bit string. In fact, a concise statement of the problem is that any byte with a value less than decimal 8 can be expected to misbehave, unless it is the last byte in the shape table. The solution to the problem lies in preventing the occurrence of

these dubious bytes. This can be done easily—especially with a computer program—by introducing dummy right- and left-moves. The technique is simple: check the value of the assembled byte; if it is less than decimal 8, the second vector in the byte must correspond to the move-up (000) vector. In that case, replace the left-most zero bits by a non-zero, move-right vector, transfer the move-up (000) vector to the next byte and follow it by a move-left vector. By placing the move-up (000) vector into the right-most three bits of the next byte, you ensure that it will be recognized as an up-vector. The succeeding move-left vector un-does the effect of the move-right vector installed in the preceding byte so that the correct shape is maintained. Implementation of this routine in a computer program is actually quite easy, and resolves the problems introduced by the up-vector. Frankly, I don't see how anyone could be expected to obtain predictable shapes from APPLE'S procedure using hand-methods for creating shape tables, considering the inherent problems posed by the zero up-vector.

THE PROGRAM(S)

Three programs were written to implement the computer-guided formulation of a shape table: A) a shape file initialization program (Figure 5); B) a shape creating program (Figure 7); C) a shape display program (Figure 8). These will be discussed briefly. I hope that the following discussions coupled with the comments scattered through the programs will enable you to follow the programs without difficulty.









<u>Plotting Vectors</u>	<u>3-bit Codes</u>	<u>Decimal Equivalents</u>
	000	0
	001	1
	010	2
	011	3
	100	4
	101	5
	110	6
	111	7

Fig. 4: Representation of Plotting Vectors as 3-bit Codes and decimal equivalents

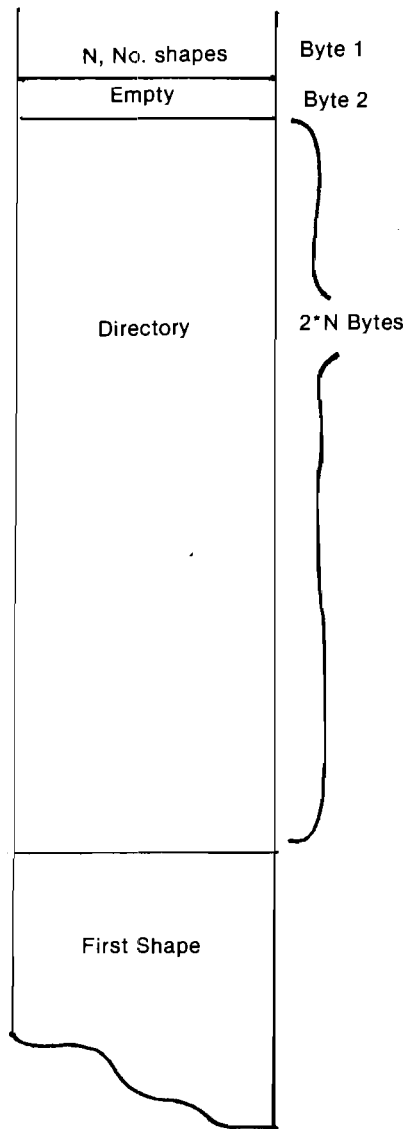

Fig. 5: Memory Map for Shape Table

Shape File Initialization

The principle shape-creating program requires a previously allocated disk file for shape table storage. The initialization program (Figure 6) creates the disk file and also establishes the name and length of the file. The program allocates space for the shape table directory based on the number of shapes to be stored in the file, a number that is declared by you during initialization. The memory map for a shape table is stored in the first byte of the table; its maximum value is therefore 255, and this is the maximum number of shapes that can be stored in one shape table. The directory contains addressing information that allows random access to

any shape in the table.

The directory falls between the first byte of the table and the beginning of the first shape. The amount of space allocated to the directory is determined by the number of shapes ultimately to be stored in the table; each shape requires two bytes in the directory for addressing. The shape tables themselves may be any length, up to a total length consistent with the 15×15 matrix in which the shapes are created. The shape tables are stored end-to-end as they are added to the file, each shape determining in a zero byte as end-of-record mark. The layout of the shape file requires that any tables added to the file be accurately done, because once a table is buried in the file, it cannot be simply replaced unless the replacement has precisely the same length.

The file initialization program is also used for creating the cursor required for mapping shapes on the 15×15 working grid produced by the principal program. This relieves the user of the need to generate the cursor himself everytime he opens a new shape file. The cursor is stored as the first shape in the shape file, and the shape-creating program assumes that the cursor has already been stored for its use. As a consequence of this arrangement, you must remember that the user-generated shapes start with the *second* shape table in the file.

Although the file initialization program zeroes out all of the bytes in the directory, there is no substantial reason for doing this, except that the string of zero bytes make it easy to determine where the directory ends and the shape tables begin in a memory dump. This advantage will last only until the directory is filled.

The Shape Creating Program

The BASIC program (Figure 7) that enables shape generation requires the use of dual floppy disks, but can be easily changed for single floppy use by replacing "D2" in step 110 by "D1." (Similar adjustments will have to be made in the initialization and display programs, which store and access the shape file from disk D2). Tape users will have to replace disk I/O by suitable tape I/O in steps 100, 110 and 1360.

The program loads a pre-existing shape file (created by the initialization program, if necessary) from disk, using the shape file name supplied by you on request from the program. The file is loaded into a memory location which you are also asked for by the program. A check is made (step 220) that there is room in the shape file directory for another entry. If not, you will be so advised and the program will abort. A pointer

to the shape file required by the APPLE system is set up in step 260. The 15×15 plotting grid is turned on (steps 300-330) and you will be asked to input the starting grid coordinates for the shape. Note, these are *grid* coordinates and *not* screen coordinates that are asked for. The cursor will be displayed on the center of the grid square that you have just selected as the starting point. Some user helps are displayed in the text area under the grid (steps 410-440), and you are off and running. Manipulation of the R, L, D, and U keys will move the cursor in the appropriate directions. The REPEAT key will work with these commands. Pressing the P key will plot a small circle inside the square in which the cursor currently resides, and this plotted point will become part of the shape table being built in memory. An image of the cursor will persist in the initial square—as a "negative" image if you happened to plot at that square. The persistent cursor image serves as a reminder to you of the location of the start of the shape. The cursor is made to disappear and reappear in adjacent squares as you press the move keys by XDRAW commands at steps 500 and 530; the IF statement at step 1040 in the subroutine that draws the plotting circle is responsible for keeping the persistent image of the cursor at the starting square. The flag, FLAG, that appears in step 480 and elsewhere is used to allow the cursor to be turned off in a plotted square and to be turned on again when the cursor moves to the next square.

Keystrokes are recorded in step 570. A previous step (550) saves the previous *two* keystrokes in KI\$ and KSVE\$. The former record, KI\$, is required to allow the erase feature, controlled by the E key and discussed below. KSVE\$ is needed for proper generation of plot-then-move 3-bit codes, also discussed below. Interpretation of a keystroke takes place in steps 590-710, a sequence of IF's called a *sieve*. This particular form of key screen was chosen because it gives almost complete protection against inadvertent entry of incorrect keys. Once you are in the program, you will find that the keyboard is effectively locked out for all keys except those required by the program. If a non-applicable key is pressed, the sieve eventually routes the program through step 710 back to another key access at step 570. Inside the sieve, when a keystroke has been identified as a move command (L,R,U,D), the appropriate X- or Y- coordinate adjustment is made and the decimal value of the 3-bit code applicable to the move is stored where the variable KSVE\$ is checked to see if the previous keystroke was a Plot command. If it were, SYMBOL is incremented by a 4 (remember Figure 4?), and SYMBOL is then transmitted to the byte assembly area, more of this later.

If the current keystroke corresponds not to a move command, but to a Plot command, the program sets the cursor disable flag, FLAG, calls the plot subroutine and then branches back to get the next keystroke (all of this is done in step 680). The Quit command forces a branch to a routine that closes out the current byte (starting at step 1080), adds a record mark (step 1170) and draws the completed shape (step 1170). At this juncture, you are asked a series of questions, the answers to which will allow you to:

- 1) forget the current shape and go back and try again without re-accessing the current shape file from disk;
- 2) keep the current shape, update the shape file directory and start a new shape;
- 3) forget the whole thing—add no new shapes to the file and quit;
- 4) load an updated shape file to disk and quit.

These alternatives will help you to avoid filling up the shape table with unwanted shapes, and allow you to experiment without being forced to save all of your experiments.

The closing out of the current byte preparatory to ending the current shape definition (step 1080) poses a problem if the last keystroke is a Plot command because a P command alone does not generate a vector. There is nothing to store after a final P command, unless it is followed by some sort of move. The problem is handled in steps 1100-1140 by adding an arbitrary up-move after a final Plot command to generate a plot-then-move-up vector. (Note that in the illustration Figure 2, the concluding vector is a plot-then-move-down. This was done for the sake of clarity in drawing only. The point is mentioned in case some unusually perceptive reader notices that the foregoing description does not tally with the example in Figure 2). The final vector is either added to the current byte, in which it will appear as the only entry. If the last keystroke prior to closing the current shape table is anything other than a Plot command, the current byte can be closed out immediately without further ado.

The erase command has the very limited capability of erasing the last Plot command only. As discussed before, a Plot command alone does not result in formation of a vector until it is followed by a command. Therefore, if a Plot command is issued in error and no move command follows it, no vector will be generated and the shape table remains unchanged at this point. It is therefore possible to undo the Plot command simply, without the complication of

analyzing the last byte for returning to the state that preceded the mistaken command (and it would be complicated!!). At the point at which the Plot command is mistakenly issued, KSVE\$ has a certain value. If we wish to go back to the condition prior to the mistaken Plot command, we must restore that value to KSVE\$ so that when the correct command is issued it is properly interpreted when KSVE\$ is examined subsequently. The character required for this purpose lies waiting in KI\$. Thus, the erase command loads this previous value into KSVE\$ and "unplots" the incorrect plotting circle by re-plotting with the color "black" (HCOLOR=0 in step 720). Note that because of these limitations, no plot command can be undone after a move has been made.

Byte assembly using the 3-bit codes (stored currently in SYMBOL) occurs in 780-980. The variable CYCLE keeps track of the number of 3-bit codes entered into the current byte (called BYTE in the program). After the second 3-bit code is loaded into BYTE (step 820) a check is made (step 840) to see if the byte is less than 8; if it is, we know that the byte contains an unrecognizable move-up vector in the left five bits. In that case, a dummy move-right 3-bit code is inserted into the byte, the byte is stored (step 860) and a new byte is formed consisting of the required move-up (000) followed by a dummy move-left (110) to compensate for the dummy move-right. The resulting byte contains the bit string 0001 1000, decimal 24, generated in step 880. Statements 950-980 take care of the cases in which the third 3-bit code is a plot-then-move code or a move-up only code, which require that the current byte be stored, and the current 3-bit code be loaded into the next byte.

The Display Program

It is likely that your disk or tape will be replete with shape files tailored to various uses, now that creating shape tables is so easy. A convenient display program will become essential in order to find out which shapes are stored where. The display program that accomplishes this (Figure 8) is an example of how shape files may be used in a program. The program constructs a 6x6 grid on the high resolution screen and displays one shape per grid cell. To identify the location of the shapes in the shape table, each occupied cell carries the shape index in the upper left-hand corner. The numerals required for plotting these indices are extracted from a shape table called NUMERALS that you will have to create at storage location 20000 (decimal) by means of the shape creating program. The numerals are restricted to a 5x7 grid, and are formatted as illustrated by the example in

Figure 1. Sufficient space is reserved in the display squares to accommodate three-digit numerals from 1 through 255. "Aha," you ask, "how can 255 shapes be displayed in a 6x6 grid?" The program provides for paging through the shape table, 36 shapes at a time. The paging is activated by hitting any alphanumeric key on the APPLE keyboard.

The display program opens by getting the shape files that it needs—one for numerals (step 50) and the table to be displayed (step 90). Pointers to the tables are set up (steps 70 and 120). Starting at step 180, each shape I is accessed in a FOR...NEXT loop. A grid-specific index is calculated (step 190) by taking the current shape index I modulo 36 (step 190). For the first shape in each group of 36 (I modulo 36 = 1), the screen is cleared (step 240) and the 6x6 grid is displayed (steps 250-330). The row and column positions for the I—th shape in the grid are found (steps 360, 370). The shape index is "unpacked" into its separate digits (steps 380-410) and these digits are plotted in the correct grid cell in the upper left-hand corner (steps 430-480). The NUMERALS shape table is accessed in step 420 by placing the pointer to the NUMERALS shape table in (decimal) addresses 232 and 233, so that subsequent DRAW commands will refer to this table. In similar fashion, when the shapes to be plotted are required, the address of the shape table must be entered into addresses 232, 233. This program illustrates how any number of shape tables may be used inside a program simply by supplying the correct pointers at the time that shapes are to be DRAWn or XDRAWn.

Parting Words

The 15x15 grid used for shape creation is the largest practical size for the APPLE screen with space provided for text. A larger grid can be accommodated by eliminating the text area, but this will compromise the required starting coordinate input. However, the number of cells could be increased by decreasing cell size and using a smaller plotting figure. If you try this, it is convenient to select a plotting grid with odd numbers of X and Y segments so that the central plotting area falls on a grid square and not at the intersection of two grid lines. This is of help in centering shapes.

You should also be aware, if it is not obvious by now, that the location of a shape on the grid has no bearing on where it plots in high resolution graphics, except with regard to the initial point of the shape, which alone determines justification. You may use any convenient subsection of the full grid for plotting, and it does not have to be the same subsection for each shape.

continued on page 19

MUSE™
THE LEADER IN QUALITY SOFTWARE

NEXT SUPER-TEXT SUPER-TEXT SUPER-TEXT SUPER-TEXT

SUPER-TEXT is a professional word processing system for the Apple II and Apple II Plus computers.

SUPER-TEXT is the most innovative word processor available on any personal microcomputer and includes features previously found only on word processing systems costing thousands more!

An advanced multiple paging system allows you to view two text screens simultaneously. You may keep notes or instructions on one text screen while you edit on the other.

SUPER-TEXT is a character oriented editor with complete cursor controls to easily move the cursor to any position in the text with a minimum of keystrokes.

Built in floating point math and automatic tabbing facilitate the preparation of all manual reports including financial reports, insurance forms, real estate settlements and more.

SUPER-TEXT is easier to operate than a typewriter yet challenges the flexibility of pencil and paper.

SELECTED FEATURES:

EDITING - Full floating cursor. Cursor control - left, right, up, down or to center of screen. Add or insert a character, word or line. Automatic carriage return eliminates a word breaking at the end of the screen line. Delete a character, word, line or screen. Automatic on screen tabbing and right or left justification of columns. Unlimited text movement. Scroll either a page or a line forward or back. Move to the beginning or end of the text or screen. Move to the last change made in the text. Move to a block marker. Global search and replace (selective or all). Block operations - copy, delete or save to disk. Select multiple or single screen mode.

ADVANCED FILE HANDLING - Requires only two keystrokes to load or save a file to disk. The file name does not have to be entered which eliminates misspelling

and "FILE NOT FOUND" errors. Save entire text or portion of to disk. Complete file merging capabilities.

MATH - Automatic column totals. Formula computations. User selectable number of decimal positions. Automatically switches to scientific notation when necessary. 14 significant digits.

PRINT CONTROLS - Upper and lower case printing without additional hardware. Automatic paragraph indentation. Single or double space printing. Selectable right justification of text. Variable page length and width. Automatic page numbering. Selectable chapter-relative page numbering. Automatic print tabbing. Right or left justification of columnar data. Single sheet or continuous form printing. Superscripting and subscripting. Underscoring. Line centering. Automatic link and printing of multiple text files. (48k) 99.95

MICRO INFORMATION SYSTEM™ (48k) \$99.95 is a breakthrough in effective information systems of any size. This one system handles accounts payable/receivable, inventories, appointment calendars, cost estimating, real estate listings, sales solicitations, manpower accounting, selective mailings and label printing, dietary information, phone directories and more! On diskette.

U-DRAW II™ (32k) \$39.95, a complete graphics package for the Apple II with disk. You can create a figure and rotate, expand, contract or move it anywhere on your video screen with a few simple keystrokes. Save individual figures or complete drawings on disk and recall them later. U-DRAW II automatically builds and edits multi-figure shape tables that are directly transferable to your BASIC programs. You won't find better graphics capabilities at 100 times the price!

APPILOT EDU-DISK™ (32k) \$49.95 A complete multi-program C. A. I. system for the APPLE II. Includes program editor and APPILOT interpreter on diskette with extensive on-line HELP lessons plus documentation manual.

THREE MILE ISLAND™ (48k) \$39.95 - Is the technology of a nuclear reactor too complex to handle? Now you have the opportunity to decide for yourself, with THREE MILE ISLAND a realistic simulation of a pressurized nuclear reactor. Four spectacular displays monitor the containment building, turbines, filters, condenser, reactor core and the pump house. Valves, pumps, turbines, filters and control rods are individually activated by keyboard command. The comprehensive documentation describes in detail the operating mechanisms and component interactions.

SUPER-LOAD CASSETTES

U-DRAW (16k) \$17.95
ELECTRIC CRAYON (8k) \$17.95
MAZE GAME (8k) \$12.95
ESCAPE (16k) \$12.95
SIDE SHOWS (8k) 12.95
TANK WAR (16k) \$12.95
MUSIC BOX (8k) \$12.95
BASEBALL (16k)* \$14.95
UNCLE SAM'S JIGSAW (32k)* \$12.95
GLOBAL WAR (32k)* \$17.95

* Plus APPLESOFT Board

MUSE™
THE LEADER IN QUALITY SOFTWARE



Available from dealers or write today to the
MUSE CO., 7112 Darlington Drive, Baltimore, MD 21234



Order by phone (301) 661-8531 MASTERCHARGE and VISA welcome

Software for the Apple II

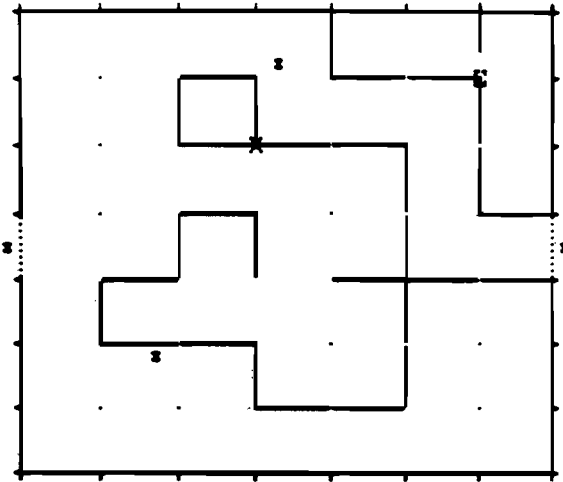

SCORE: 108

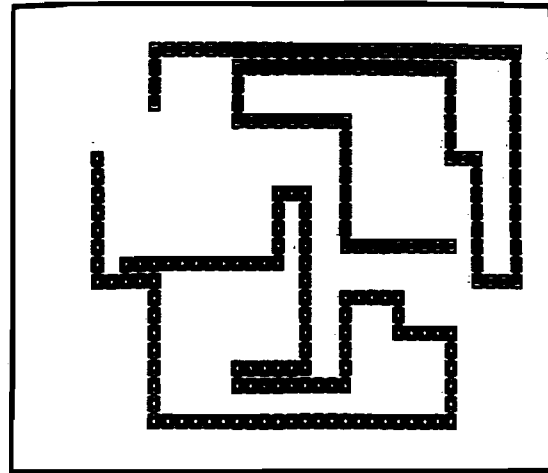

SCORE: 105

DYNAMAZE—a dazzling new real-time game. You move in a rectangular game grid, drawing or erasing walls to reflect balls into your goal (or to deflect them from your opponent's goal). Every ball in your goal is worth 100 points, but you lose a point for each unit of elapsed time and another point for each time unit you are moving. Control the speed with a game paddle: play as fast as ice hockey or as slowly and carefully as chess. Back up and replay any time you want to; it's a reversible game. By Don Stone. Integer Basic (plus machine language); 32 K; \$9.95.

ULTRA BLOCKADE— the standard against which other versions have to be compared. Enjoy Blockade's superb combination of fast action (don't be the one who crashes) and strategy (the key is accessible open space—maximize yours while minimizing your opponent's). Play against another person or the computer. New high resolution graphics lets you see how you filled in an area—or use reversibility to review a game in slow motion (or at top speed, if that's your style). This is a game that you won't soon get bored with! By Don Stone. Integer Basic (plus machine language); 32 K; \$9.95.

What is a **REVERSIBLE GAME**? You can stop the play at any point, back up and then do an "instant replay", analyzing your strategy. Or back up and resume the game at an earlier point, trying out a different strategy. Reversibility makes learning a challenging new game more fun. And helps you become a skilled player sooner.

WORLD OF ODYSSEY—a new adventure game utilizing the full power of Disk II, which enables the player to explore 353 rooms on 6 different levels full of dragons, dwarfs, orcs, goblins, gold and jewels. Applesoft II 48K; \$19.95 includes diskette.

PERQUACKEY—an exciting vocabulary game which pits the player against the clock. The object of the game is to form words from a group of 10 letters which the computer chooses at random. The words must be 3 to 10 characters in length with no more than 5 words of any particular length. Each player has only 3 minutes per turn. The larger the words the higher the score. Applesoft II 16K; \$9.95.

APPLESHIP—is a naval game in which two players enter their ships in respective oceans. Players take turns trying to blast their opponent's ships out of the water. The first player to destroy their opponent's ships may win the game. A great low-res graphics game. Applesoft II 32K; \$14.95.

Available at your
local computer store

Call or write for our free
SOFTWARE CATALOG

Apple II is a registered
trademark of
Apple Computer, Inc.

DEALER INQUIRIES INVITED

POWERSOFT, INC.

P. O. BOX 157
PITMAN, NEW JERSEY 08071
(609) 589-5500

Programs Available on Diskette
at \$5.00 Additional

- Check or Money Order
- Include \$1.00 for shipping and handling
- C.O.D. (\$1.00 add'tl. charge)
- Master Charge and VISA orders accepted
- New Jersey residents add 5% sales tax

6: Shape File Initialization Program

```

10 REM SHAPE FILE INTIALIZATION
20 INPUT "NAME OF SHAPE TABLE ";
NAME$
30 INPUT "STARTING ADDRESS, DECIM
AL "; ADDR
40 INPUT "NO. OF SHAPES TO BE ST
ORED "; N
50 REM ZERO DIRECTORY
60 FOR I = 0 TO 2 * N + 1
70 POKE ADDR + I, 0: NEXT
80 REM CALCULATE INDEX TO CURSO
R
90 N = 2 * N + 2
100 REM PUT CURSOR INDEX INTO D
IRECTORY
110 POKE ADDR + 2, N - 256 * INT
(N / 256)
120 POKE ADDR + 3, INT (N / 256)

130 REM CALC INITIAL ADDRESS TO
CURSOR
140 INIT = ADDR + N
150 REM ENTER CURSOR SHAPE VECT
ORS
160 DATA 62,36,45,54,04,00
170 FOR I = 0 TO 5
180 READ A: POKE INIT + I, A: NEXT

190 REM GET INDEX TO NEXT SHAPE

200 N = N + 6
210 REM STORE NEW INDEX IN DIRE
CTORY
220 POKE ADDR + 4, N - 256 * INT
(N / 256)
230 POKE ADDR + 5, INT (N / 256)

240 REM UPDATE SHAPE COUNTER
250 POKE ADDR, 1
260 REM STORE INITIALIZED FILE
ON DISK
270 D$ = CHR$(4)
280 PRINT D$:"NONON C.I.D"
290 PRINT D$:"ESAVE" + NAME$ + "
,A" + STR$(ADDR) + ",L" +
STR$(N) + ",U0,02"
300 END

```

7: Shape Creating Program

```

10 PRINT TAB(6):"****CREATE A
SHAPE TABLE****"
20 PRINT
30 PRINT TAB(5):"BY J. FIGUERA
S, ROCHESTER, N.Y.": PRINT
40 PRINT TAB(16)"9/12/79": PRINT

50 PRINT TAB(17)"*****": PRINT

60 REM INPUT TABLE NAME AND LOC
ATION
70 INPUT "SHAPE TABLE NAME "; NAM
E$
80 INPUT "STARTING ADDRESS, DECIM
AL "; ASVE
90 REM DISK ACCESSES USE DISK D
2
100 D$ = CHR$(4): PRINT D$:"NON
ON C.I.D"
110 PRINT D$:"BLOAD " + NAME$ +
",A" + STR$(ASVE) + ",U0,0
2"
120 REM GET CAPACITY MAX OF FIL
E
130 MAX = PEEK (ASVE + 2) + 256 *
PEEK (ASVE + 3)
140 MAX = (MAX - 2) / 2
150 REM GET NO. OF SHAPES IN TA
BLE
160 N = PEEK (ASVE)
170 REM GET FILE LENGTH
180 INDEX = PEEK (ASVE + 2 * N +
2) + 256 * PEEK (ASVE + 2 *
N + 3)
190 REM COMPUTE ADDRESS OF NEXT
FREE BYTE
200 ADDR = ASVE + INDEX
210 REM SEE IF FILE IS FULL
220 IF MAX > N THEN 260
230 PRINT "SHAPE TABLE FULL. NEX
T FREE BYTE AT "; ADDR
240 GOTO 1370
250 REM SET UP APPLE POINTERS T
O TABLE
260 POKE 232, ASVE - 256 * INT (
ASVE / 256): POKE 233, INT (
ASVE / 256)

```

```

270 REM UPDATE SHAPE COUNTER
280 N = N + 1: POKE ASUE,N
290 REM DISPLAY PLOTTING GRID.
INITIALIZE COUNTER. CYCLE
300 HCOLOR= 3: SCALE= 1: ROT= 0:
CYCLE = 0
310 HCR
320 FOR X = 0 TO 150 STEP 10: HPL0T
X,0 TO X,150: NEXT
330 FOR Y = 0 TO 150 STEP 10: HPL0T
0,Y TO 150,Y: NEXT
340 REM CLEAR TEXT AND GET INIT
IAL PLOT COORDS
350 PRINT : PRINT : PRINT : PRINT

360 PRINT "ENTER STARTING COORDS
"
370 INPUT "X " :X:X = 10 * X - 5
380 INPUT "Y " :Y:Y = 10 * Y - 5
390 DRAW 1 AT X,Y:XS = X:YS = Y
400 REM CLEAR TEXT. DISPLAY INS
TRUCTIONS
410 PRINT : PRINT : PRINT : PRINT

420 PRINT "MOVE PLOT CURSOR WITH
KEYS"
430 PRINT " L-LEFT R-RIGHT U-
UP D-DOWN"
440 PRINT " P TO PLOT. Q TO QUI
T."
450 REM INITIALIZE KEY#.PLOT CU
RSOR
460 KEY# = "" :KSUE# = "" : GOTO 57
0
470 REM FLAG RE-ENABLES CURSOR
AFTER A PLOT DISABLE
480 IF FLAG = 1 THEN 520
490 REM ERASE CURSOR IN PREVIOUS
S SQ.
500 XDRAW 1 AT X1,Y1
510 REM PLOT CURSOR AT NEW X,Y.
SAVE X,Y
520 X1 = X:Y1 = Y:FLAG = 0
530 XDRAW 1 AT X,Y
540 REM SAVE LAST TWO KEYSTROKE
S. KI# IS NEEDED FOR ERASE R
OUTINE.
550 KI# = KSUE# :KSUE# = KEY#
560 REM GET NEW KEYSTROKE
570 GET KEY#
580 REM GO TO SIEVE TO GET 3-B
IT PLOT VECTOR FROM KEY# AND
KSUE#

```

```

590 IF KEY# < > "U" THEN 610
600 SYMBOL = 0:Y = Y - 10: GOTO 7
60
610 IF KEY# < > "R" THEN 630
620 SYMBOL = 1:X = X + 10: GOTO 7
60
630 IF KEY# < > "D" THEN 650
640 SYMBOL = 2:Y = Y + 10: GOTO 7
60
650 IF KEY# < > "L" THEN 670
660 SYMBOL = 3:X = X - 10: GOTO 7
60
670 IF KEY# < > "P" THEN 690
680 FLAG = 1: GOSUB 1000: GOTO 57
0
690 IF KEY# = "Q" THEN 1000
700 REM NEXT STATEMENT PROTECTS
FROM KEYING ERROR
710 IF KEY# < > "E" THEN 570
720 HCOLOR= 0:FLAG = 0: GOSUB 10
00
730 REM SET UP PRE-PLOT STATUS
740 KSUE# = KI#: HCOLOR= 3: GOTO
500
750 REM ADJUST 3-BIT VECTOR FOR
PLOT
760 IF KSUE# = "P" THEN SYMBOL =
SYMBOL + 4
770 REM LOAD 3-BIT VECTOR INTO
BYTE
780 CYCLE = CYCLE + 1
790 IF CYCLE < > 1 THEN 810
800 BYTE = SYMBOL: GOTO 480
810 IF CYCLE < > 2 THEN 900
820 BYTE = BYTE + 8 * SYMBOL
830 REM PROTECT AGAINST PREMATURE
RE END-OF-RECORD
840 IF BYTE > 7 THEN 480
850 REM ENTER DUMMY RIGHT MOVE
AND STORE BYTE.
860 BYTE = BYTE + 8: POKE ADDR, BY
TE: ADDR = ADDR + 1
870 REM ENTER UP MOVE AND DUMMY
LEFT MOVE IN NEW BYTE
880 BYTE = 24 * CYCLE = 2: GOTO 480

890 REM IF THIRD 3-BIT VECTOR
IS A MOVE ONLY, FINISH BYTE. E
LSE LOAD BYTE INTO TABLE AND
STORE 3-BIT VECTOR IN NEXT
BYTE.

```

```

900 IF SYMBOL > 3 THEN 930
910 BYTE = BYTE + 64 * SYMBOL
920 REM STORE BYTE
930 POKE ADDR.BYTE:ADDR = ADDR +
1
940 REM STORE 3-BIT VECTOR IN N
EXT BYTE IF NEEDED
950 IF SYMBOL = 0 OR SYMBOL > 3 THEN
980
960 REM PREPARE FOR NEXT BYTE I
ET NEXT 3-BIT VECTOR
970 CYCLE = 0: GOTO 400
980 CYCLE = 1: BYTE = SYMBOL: GOTO
400
990 REM PLOT ROUTINE
1000 FOR Y2 = Y - 3 TO Y + 3 STEP
6: H PLOT X - 1,Y2 TO X + 1,Y
2: NEXT
1010 FOR Y2 = Y - 2 TO Y + 2 STEP
4: H PLOT X - 2,Y2 TO X + 2,Y
2: NEXT
1020 FOR Y2 = Y - 1 TO Y + 1: H PLOT
X - 3,Y2 TO X + 3,Y2: NEXT
1030 REM TURN OFF CURSOR IN PL
OTTED SO.
1040 IF X = XS AND Y = YS THEN RETURN

```

```

1050 XDRAW 1 AT X,Y: RETURN
1060 REM PREPARE BYTE FOR QUIT
1070 REM CLOSE OUT BYTE FOR MOU
E-ONLY
1080 IF KSUE# (< > "P" THEN 1150

```

```

1090 REM USE PLOT-THEM-UP VECTO
R TO END
1100 IF CYCLE (< > 2 THEN 1120
1110 POKE ADDR.BYTE:ADDR = ADDR +
1
1120 IF CYCLE (< > 1 THEN 1140
1130 BYTE = BYTE + 32: GOTO 1150
1140 BYTE = 4
1150 POKE ADDR.BYTE:ADDR = ADDR +
1
1160 REM ADD RECORD MARK,DISPLA
Y NEW SHAPE.
1170 POKE ADDR.0:ADDR = ADDR + 1
: XDRAW N AT 200,75
1180 INPUT "SAVE SHAPE? Y/N ":KI
$
1190 IF KI# = "Y" THEN 1220
1200 N = N - 1: GOTO 100
1210 REM GET INDEX FOR NEXT FRE
E BYTE
1220 N = N + 1: ADDR = ADDR - ASUE

```

```

1230 IF N < MAX THEN 1270
1240 PRINT "WARNING: TABLE FULL
WITH THIS SHAPE "
1250 IF N > MAX THEN 1310
1260 REM STORE INDEX IN DIRECTO
RY
1270 POKE ASUE + 2 * N,ADDR - 25
6 * INT (ADDR / 256)
1280 POKE ASUE + 2 * N + 1, INT
(ADDR / 256)
1290 INPUT "DONE? Y/N ":KI#
1300 IF KI# = "N" THEN 100
1310 INPUT "SAVE TABLE? Y/N ":KI
$
1320 REM RESPONSE PROTECTED 000
INST RANDOM KEY HIT
1330 IF KI# = "Y" THEN 1360
1340 IF KI# = "N" THEN 1370
1350 GOTO 1310
1360 PRINT D#: "SSANE" + NAME# +
"A" + STR# (ASUE) + ".L" +
STR# (ADDR)
1370 END

```

8: The Display Program

```

10 REM ****DISPLAY SHAPE TABLE*
***
20 REM LOAD NUMERALS SHAPE FILE
30 PRINT : PRINT : PRINT "HIT AN
Y KEY FOR EACH PAGE OF TABLE
"
40 D# = CHR# (4): PRINT D#: "NONO
N C.I.O"
50 PRINT D#: "BLOOD NUMERALS,0200
00,02"
60 REM SET UP POINTER TO NUMERA
LS
70 NHI = 70: NLI = 32
80 REM GET TABLE FOR DISPLAY
90 INPUT "SHAPE TABLE NAME ":NAM
E#
100 INPUT "STARTING ADDRESS ":AD
DR
110 REM SET UP POINTER TO SHAPE
TABLE
120 AHI = INT (ADDR / 256): ALO =
ADDR - 256 * AHI
130 REM GET NO. OF SHAPES FOR D
ISPLAY

```



```

140 NN = PEEK (ADDR)
150 REM INITIALIZE SCREEN
160 HGR : POKE - 16382,0
170 HCOLOR= 3: SCALE= 1: ROT= 0
180 FOR I = 1 TO NN
190 IMOD = I - 36 * INT (I / 36)

```

```

200 IF IMOD < > 1 THEN 350
210 GET KEY#
220 REM SCLEAR SCREEN AND CREAT
E GRID
230 REM GRID WILL HOLD 36 SHAP
ES
240 CALL 62450
250 HPL0T 0,0 TO 269,0 TO 269,19
0 TO 0,190 TO 0,0
260 FOR L = 45 TO 269 STEP 45
270 FOR J = 0 TO 190 STEP 10
280 HPL0T L,J
290 NEXT J: NEXT L
300 FOR L = 30 TO 190 STEP 30
310 FOR J = 0 TO 269 STEP 10
320 HPL0T J,L
330 NEXT J: NEXT L
340 REM CALCULATE GRID SQUARE C
ORDRS
350 IF IMOD = 0 THEN IMOD = 36
360 ROW = INT ((IMOD - 1) / 6)
370 COL = IMOD - 6 * ROW - 1
380 C1 = INT (I / 100)
390 C2 = I - 100 * C1
400 C2 = INT (C2 / 10)
410 C3 = I - 10 * INT (I / 10)
420 POKE 232,NL0: POKE 233,NH1
430 C1 = C1 + 2: C2 = C2 + 2: C3 =
C3 + 2
440 IF C1 = 2 THEN 460
450 DRAW C1 AT 45 * COL + 5.30 *
ROW + 7
460 IF C2 = 2 AND C1 = 2 THEN 48
0
470 DRAW C2 AT 45 * COL + 10.30 *
ROW + 7
480 DRAW C3 AT 45 * COL + 15.30 *
ROW + 7
490 REM NOW GET SHAPES
500 POKE 232,ALO: POKE 233,AH1
510 DRAW I AT 45 * COL + 20.30 *
ROW + 15
520 NEXT I
530 GET KEY#
540 TEXT
550 END

```



NIBBLE

NIBBLE is an unusual new Newsletter for Apple II Owners. Each Issue will follow a major theme... such as:

- * DATA BASE MANAGEMENT
- * PROGRAMS FOR THE HOME
- * TEXT PROCESSING
- * COMPUTING FOR KIDS
- * SMALL BUSINESS JOBS
- * GAMES AND GRAPHICS
- * PRACTICAL PASCAL
- * etc.

Significant programs will be in each issue, surrounded by articles which show how to USE the programming ideas in your OWN programs.

Examples of Upcoming Articles...

- * Building a Numeric Keypad.
- * Home Credit Card Management.
- * LO RES Shape Writing.
- * Arcade Shooting Gallery Game.
- * Random #'s in Assy. Language.
- * HI RES Weaving Design.

And many many more. NIBBLE will literally "Nibble Away" at the mysteries of the Apple II to help Beginning and Advanced Programmers, Small Businessmen, and the Whole Family enjoy and USE the Apple MORE!

It costs a paltry \$15.00 for 8 Issues! It will invite and publish user ideas and programs. DON'T WAIT! Send your check or money order right now, to receive the January issue! Mail to:

S. P. A. R. C.
P. O. Box 325
Lincoln, Mass. 01773

Software Publishing And Research Co.

MICRO Product Review

As outlined briefly in MICRO 18:58, MICRO is instituting a review policy/procedure in which a "Review Staff" of volunteer, independent, qualified computerists will be asked to review 6502 based products: hardware, software, books, etc.

Product Submission

While any 6502 based product is "fair game" for a review, we plan to handle products whose manufacturer requests a review first. The procedure is simple. Fill out the attached "Review Request Form" and send it to us. We will select products for review from the submitted forms and select a reviewer from our Review Staff. We will contact the reviewer to make sure he is willing to review the product, has time to do the review, has no "conflict of interest", etc. Once a reviewer is set, we will contact you to supply a sample of the product you wish reviewed. This will be sent to the reviewer. Upon receipt of the review, we will send a copy to you. You will have a chance to make comments about the review, clear up any misunderstandings, point out items that may have been

overlooked, discuss significant changes and improvements being planned, etc. If valid errors in the review are pointed out, we will get back to the reviewer and see that all points are clearly covered and understood before the review is printed. This does **not** mean that you will have any editorial rights in regards to what is finally printed. It does mean that you will have opportunities to help insure that the review adequately covers the important features of your product and that minor problems will not be blown out of perspective.

In the event that a review is, in our opinion, biased — too bad or too favorable — we may have a second reviewer evaluate the product. Our goal is to be able to present to the MICRO readers a review that is as complete and unbiased as possible. We think that this will be an important service both to the readers and to the manufacturers. Here will be a way to get a fair evaluation about your product out to thousands of interested readers (customers?). Since the review will be by an independent reviewer, the material will have a lot more impact than a

"self-serving" product news release.

Supplying Samples

The manufacturer must furnish a sample of the material to be reviewed. In the case of books and software, the sample will normally be kept by the reviewer and not returned. In the case of hardware, the sample will be returned. We would like to suggest, in the case of hardware, that the reviewer be permitted to purchase the hardware at dealer price or some other reasonable discount if he so desires. If such a discount is acceptable to you, this should be mentioned on the Review Request Form. The reviewer will not be informed about any product discount until after the review is finalized in order to prevent any unwanted bias from entering into the review.

All of this effort to provide a new method for getting reviews is intended to produce accurate, unbiased, believable reviews. These will be of service to the readers and manufacturers. We hope that you will submit your 6502 based product for review. It should benefit everyone.

Robert M. Trumpf

MICRO Review Request Form

Manufacturer:

Address:

City: State: Zip:

Phone: Days: Evenings:

Name of Product:

Description of Product:

.....

.....

6502 Systems it works with:

.....

Special Equipment/Software Required:

.....

Retail Price: First Delivery: Number Delivered:

I declare that I am the manufacturer, or legal representative of the manufacturer, and request that MICRO produce a review on this product. I agree to provide a sample of the product for review. I understand that software or book samples will not be returned, but that hardware samples will normally be returned. I am/am not willing to provide a discount on the hardware sample to the reviewer.

Signed: Date:

Title:

Please complete, using additional pages if necessary, and return to: **MICRO, P.O. Box 6502, Chelmsford, MA 01824**



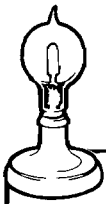

Skyles Electric Works

You love your PET, but you'll love it more with this BigKeyboard?

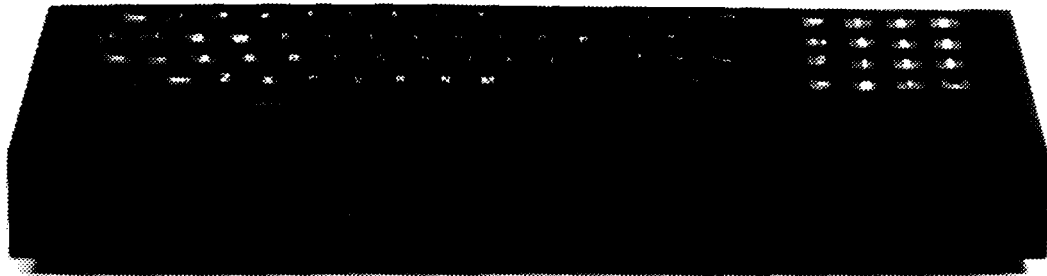

74KB Big KeyBoards @ \$125.00 (Plus \$5.00 shipping & handling)

The Skyles Big KeyBoard™. More than 15 inches wide. A layout nearly identical to the PET Keyboard and with *all* functions—alpha, numeric, graphics, special symbols, lower case alpha—on full-sized, almost plump, key-tops double-shot to guarantee lifetime durability.



Actual size

Would you like to turn on your PET ... and see this

8KB 8K Memory Expansion Systems @ \$250.00
(Plus \$3.50 shipping & handling)

16KB 16K Memory Expansion Systems @ \$450.00
(Plus \$5.00 shipping & handling)

24KB 24K Memory Expansion Systems @ \$650.00
(Plus \$5.00 shipping & handling)

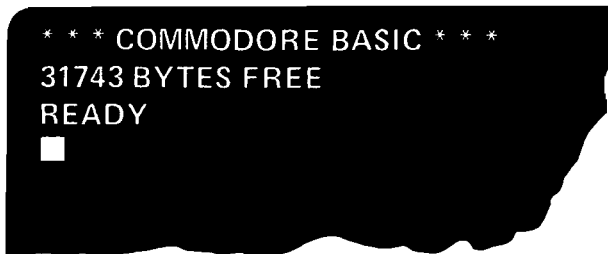

Skyles Memory Expansion Systems are complete; nothing more to buy. • First quality static RAMs • Solid soldered on first quality glass epoxy board • Separate PET Adapter Printed Circuit Board connects directly to data bus on your PET—no rat's nest of hanging hand-wiring • Ribbon cable and 50 pin connectors that keep your PET open to the outside world (one on the 8KB; *two* on the 16KB and 24KB).

- ___ 8KB Memory Expansion System(s) at \$250 each. \$ _____
(Adds 8,192 bytes; total 15,359) (*shipping and handling \$3.50 each*)
- ___ 16KB Memory Expansion System(s) at \$450 each. \$ _____
(Adds 16,384 bytes; total 23,551) (*shipping and handling \$5.00 each*)
- ___ 24KB Memory Expansion System(s) at \$650 each. \$ _____
(Adds 14,576 bytes; total 31,743) (*shipping and handling \$7.00 each*)
- ___ 74KB Big KeyBoard(s) at \$125 \$ _____
(*shipping and handling \$5.00 each*)
- ___ SPECIAL DEAL(S): 8KB Memory and 74KB KeyBoard at \$350 complete \$ _____
- ___ SPECIAL DEAL(S): 16KB Memory and 74KB KeyBoard at \$525 complete \$ _____

* Please add 6% sales tax if you are a California resident; 6.5% if a resident of BART, Santa Clara or Santa Cruz Counties (CA). Please add shipping and handling costs as indicated.

VISA, MASTERCARD ORDERS CALL (800) 227-8398 (except California residents)
CALIFORNIA ORDERS PLEASE CALL (415) 494-1210

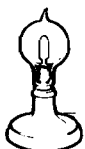

Skyles Electric Works

10301 Stonydale Drive
Cupertino, CA 95014
(408) 735-7891

Relocating PET BASIC Programs

Michael Tulloch, Ph.D.
103 White Circle
Niceville, FL 32578

Some important details are presented about the organization of PET BASIC and a technique is provided to permit BASIC programs to be shifted to different memory locations.

Have you ever wanted to time share with your PET? How about ROM routines in BASIC? You can do both of these and more by writing "shifted" BASIC programs and redirecting PET's monitor. First, I'm going to very briefly describe where PET stores BASIC programs and where the important pointers are located. Then, I'll tell you how to ENTER and RUN BASIC programs anywhere in PET's lower 32K of memory. Finally, I'll give you a practical example.

Initialization

When PET's monitor initializes memory, either with power on or by executing SYS(64824), a bunch of things happen. PET writes decimal 36 (24 HEX or screen symbol \$) into each memory location. After each location is written the same location is read. PET thus actively determines its contiguous memory size by finding the first non-36 location. Since the lower page (decimal 0 to 1032) is used as a scratch pad, PET starts its memory check at decimal 1024. Memory size is stored in 134, 135, as two bytes. The first byte is low and the second byte is high, standard 6502 format. After determining memory size, PET initializes its BASIC program memory to ready it for a BASIC program. Table 1 gives these values. Just why these location hold what they do requires a detailed description of how PET BASIC works. Such a description is too long for this article.

But, this peculiar pattern is necessary.

Scratch Pad Usage

The scratch pad memory also has some other important values. As I mentioned above, memory size was stored in 134, 135. Now six additional values are inserted. These values are called pointers. They point to locations in the program memory where the monitor goes during BASIC execution and/or program entry. These pointers are BASIC start address, simple variables start address, array variables start address, available space start address, top of strings and bottom of strings. Let's see just where these pointers are stored and what their initial values are. The BASIC pointer, which is stored in memory location 122, 123, is initialized to 1025. This pointer tells the monitor where to start storing and reading BASIC program statements. The simple variables pointer, which is stored in memory location 124, 125, is initialized to 1028. This pointer tells the monitor where the simple variables start. The array variables pointer, which is stored in memory locations 126, 127, is also initialized to 1028. This pointer is always equal to the simple variables pointer until an array variable is DIMensioned. It performs a similar function to that of the simple variables pointer. The available space pointer, stored in memory locations 128,

129, is initialized to 1028. Top and bottom of string variable pointers are stored in memory locations 132, 133, and 130, 131 respectively. Strings are stored top down while both simple and array variables are stored bottom up. Figure 1 shows how PET's monitor arranges the BASIC program and variables in memory. To store a BASIC program in a different place in memory we have to change the values of these pointers. Let's assume for a moment that these seven pointers have been changed. This will force the monitor to try to store a program, entered from the keyboard, in a location defined by pointer values. However, there is one more thing which must be done. The area which has been defined by the seven pointers must be initialized as shown in table 1. Once that has been done everything is ready. The program is entered in the normal fashion. When completed, the program can be executed without any further adjustments. It can be RUN or reLOADED as long as PET isn't turned off. Programs entered this way aren't in the normal place for a BASIC program.

Saving Shifted Programs

Saving a shifted program isn't as straightforward as you might wish. For those lucky enough to have Version 2 ROMs it's easy. All you have to do is call the machine language monitor and SAVE the program like you would SAVE a machine language program. The rest of us have to resort to tricking the PET.

```

100 POKE241,1:REMDEVICE #(1=TAPE 1)
105 A=PEEK(122):B=PEEK(123):
    REM BASIC START POINTER
110 POKE247,A:POKE248,B:
    REM SAVE FROM POINTER
120 B=PEEK(124):POKE229,B:REM BASIC
130 B=PEEK(125):POKE230,B:REM END
140 SYS63153:
    REM ROM SAVE ROUTINE
READY.

```

Figure 2

Shifted programming has several advantages but there are also some pitfalls. I'm sure that I haven't found them all. I'll tell you about those that I've fallen into, and Murphy will find some new ones for you. As a first example, let's take the case where shifted programs are loaded in under keyboard control. When this is done, all memory above 1024 is reinitialized. Any shifted programs already in memory are 36'd out. The only way to prevent this is to adjust the top of memory pointer so that it points below the existing shifted programs. This must be done before attempting to LOAD from the keyboard. Shifted (or normal) programs LOADED under program control do not 36 out memory. But the first part of memory may be set up to receive BASIC. In addition, pointers aren't changed.

Another pitfall is the tendency for PET to "go away". Any error in pointer setup will usually cause this problem. It is the rule rather than the exception. Version 2 ROMs are rumored to allow a warm reset. Unfortunately, they aren't available for the old 8K PETs yet.

A third pitfall is really just the result of careless programming. The available space within any program should be reduced as much as possible. Program space includes variable and string space. Although my PET has 16K of memory (half in BETSI), I've found it easy to over-run memory or to overlap programs. If multiple BASIC programs are to coexist, a memory map and some planning are necessary. I don't have a dynamic adjustment routine. Perhaps

someone familiar with the PET monitor could adapt its program adjustment software. It works on normal programs and it sure is fast. PET uses the routine whenever new lines are added or old lines deleted. If variable pointers are the same for all programs and if assignment statements are used to initialize all programs, then several programs might be able to share the variable working area. I haven't tried a lot of this, but it does work in simple cases. This technique will allow FORTRAN like passed variable subroutines, support BLOCK type statements and conserve a lot of memory.

So much for the pitfalls, here's some of the good news. The shifted program technique can be used for BASIC programs to coexist with Commodore's tape machine language monitor. Sure, you'll be able to buy a new set of ROMs that have the monitor—someday. But you can have nearly the same thing now. You may need an additional routine to transfer the bottom of page one (0A-22 hex) memory back and forth between machine language monitor and BASIC usage. Both BASIC and the machine language monitor want this part of memory for scratch pad.

What else can be done with shifted BASIC programs? ROM BASIC programs, truly modular development, library routines, and lots more. Now that BASIC programs can be placed wherever you want them, your imagination is the only limit.

**T.D.Q.
TAPE DATA QUERY
THE IDEAL SOLUTION FOR PERSONAL AND
VERY-SMALL BUSINESS DATA MANAGEMENT
PET-8K TRS-80-LVL II**

- * COMPLETE CASSETTE FILE MANAGEMENT SYSTEM
 - ENGLISH-LIKE COMMAND LANGUAGE
 - REPORT GENERATOR
 - UTILITY PACKAGE
 - NO PROGRAMMING KNOWLEDGE REQUIRED
 - REQUIRES 2 CASSETTE RECORDERS
- * T.D.Q. APPLICATION CASEBOOK

— COMPLETE DIRECTIONS TO MICRO-COMPUTERIZE:

- | | |
|--|---|
| <ul style="list-style-type: none"> ● INVENTORY CONTROL ● ACCOUNTS RECEIVABLE ● ORDER PROCESSING ● LABEL PRINTING ● CHECK PRINTING ● INVOICE PRINTING | <ul style="list-style-type: none"> ● CUSTOMER DIRECTORY ● APPOINTMENT SCHEDULING ● VENDOR MASTER FILE ● PAYROLL JOURNAL ● CHECKBOOK JOURNAL ● TELEPHONE BOOK ● RENT COLLECTION |
|--|---|

** SPECIAL YEAR-END SALE PRICE — \$100.00** — INCLUDES:
CASEBOOK; 2 CASSETTES; 3 USER'S MANUALS & REF. CARDS

ORDERS MUST BE RECEIVED BY JAN. 31, 1980
SEND CHECK OR MONEY-ORDER TO:

**H. GELLER COMPUTER SYSTEMS
DEPT. M
P.O. BOX 350
NEW YORK, N.Y. 10040
(N.Y. RESIDENTS ADD SALES TAX)**

apple[®] computer

Apple II Reference Manual	\$10.00
Apple Soft Manual	10.00
Programmer's Guide (Computer Station)	5.95
Apple II Monitor Peeled	9.95
Software Directory for Apple	
• Business, Finance & Utility	4.95
• Games, Demo, Utility	4.95
Best of Contact '78	2.50
Programming in PASCAL (Grogono)	9.90

INTERFACE CARDS	
Prototyping / Hobby Card	\$ 24.00
Parallel Printer Interface Card	180.00
Communications Card & DB25 Connector Cable	215.00
High-Speed Serial Interface Card	195.00
Language System with Pascal (48K RAM & Disk II Required)	495.00
Applesoft II Firmware Card	200.00
16 Input Analog Card	295.00

ACCESSORIES	
Disk II—Drive Only	495.00
Disk II—Drive & Controller (32K Min. RAM Recommended)	595.00
Vinyl Carrying Case	30.00
Tape Recorder	40.00
Programmers Aid No. 1 Firmware (For Use with Integer BASIC)	50.00
Clock/Calendar Card	199.00
Auto-Start ROM Package (For Apple II Only)	65.00
Digitizer Pad by Talos (Kitform)	499.00

High Resolution Light Pen	199.00
Micromodem (D.C. Hayes)	379.00
12" B/W Leebes Monitor	148.00
Cable from Monitor to Apple II	9.95
13" Color TV Compatible with Apple II	290.00
Sup-R-Modulator (RF)	25.00

LITE PEN used with TV or monitor screen	34.95
ALF Music Synthesizer Boards	265.00
Supertalker	279.00
Anadex DP-8000 with tractor 8" paper width and interface to Apple	1050.00
Centronics 779-2 for Apple II with parallel interface	1245.00

SOFTWARE FOR APPLE II	
PASCAL from Programma	49.95
FORTH	49.95
LISP—Interactive disk assembler	34.95
WHATSIIT—Excellent conversational data base manager	32K 100.00 48K 125.00
SARGOM—Champ of 2nd West Coast Computer Faire	19.95
APPLE PIE—Excellent text editor	24.95
FORTE—Music editor in hires	19.95
FASTGAMMON—Excellent backgammon game with graphics	Tape 20.00 Disk 25.00
APPLE Z1—Excellent blackjack game	9.95
BRIDGE CHALLENGER—Computer bridge	14.95
FINANCIAL MANAGEMENT SYSTEM	
• Accounts Payable	Ledger Processing
• Accounts Receivable	• Payroll
• Inventory Control	• \$800 Complete
• \$200 Each Package	• \$10 for Manual

SOFTWARE (Send for complete Software Catalog \$1.00)	
Dow Jones Portfolio Evaluator / Stock Quote Reporter Disk	50.00
Microchess 2.0 Chess Disk	25.00
Disk Utility Pack with DOS 3.2	25.00
The Controller (General Business System)	625.00
Apple Post (Mailing List System)	49.95
Bowling Program Diskette	15.00
The Cashier (Retail Store Management)	250.00
Checkbook Cassette	20.00
Applesoft II Language & Demo Cassette	20.00
RAM Test Tape with Manual	7.50
Finance 1-2 Cassette Package	49.95
Datamover / Teletop Cassette (Com. Card & Modem Req'd)	7.50
Bowling Program Tape	20.00
Pascal with Language System (48K RAM & Disk II Required)	495.00



New for Apple Computer Owners at Low ComputerWorld Prices

8" Disk Drives with housing \$1295.00 for single drive \$1895.00 for dual drive

A PROFESSIONAL BUSINESS SYSTEM



2001-B	\$795	CBM 2022	\$995
2001-16N	\$995	CBM 2023 Printer	\$849
2001-32N	\$1295	IEEE to IEEE Cable	\$49.95
2001-32B	\$1295	CBM 2040	\$1295
External Cassette	\$95	2001-16B	\$995
PET to IEEE Cable	\$39.95		

Join Now

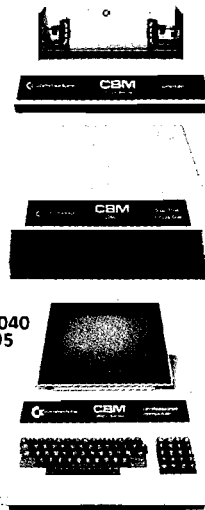

Joystick for Apple II Only \$39.95 each.

ComputerWorld's Complete Library of 600 Apple II programs Only \$60.00

PET™

Commodore PET Service Kit	\$30.00
Beeper—Tells when tape is Loaded	24.95
Petunia—Play music with PET	29.95
Video Buffer—Attach another display	29.95
Combo—Petunia and Video Buffer	49.95

SOFTWARE FOR PET

Mirrors and Lenses	19.95	Checkers and Baccarat	7.95
The States	14.95	Chess	19.95
Real Estate 1 & 2	59.95	Series and Parallel	19.95
Momentum and Energy	19.95	Circuit Analysis	19.95
Projectile Motion	19.95	Home Accounting	9.95
Mortgage	14.95	BASIC Math	29.95
Dow Jones	7.95	Game Playing with BASIC	9.95
Petunia Player Sftwr	14.95	Vol. I, II, III	9.95

Become a member of ComputerWorld's RAYGAMCO Computer Discount Club.

By being a RAYGAMCO Member you receive substantial discounts on every item you purchase, including all hardware, software, accessories, even books and paper! You will also receive a monthly newsletter with all the latest available for your particular computer system, and much, much more — exclusive to RAYGAMCO Members only!

Here's how to join.

Nothing to buy. Simply complete the self-addressed postcard in this magazine with name, address, and your computer system. You'll receive your personalized RAYGAMCO Computer Discount Club Membership Card in the mail with information on how to use your card when ordering for big savings!

Charter RAYGAMCO Members' Special. Join now and receive 20% OFF of any purchase.*

*20% offer expires December 24, 1979. Offer is valid for RAYGAMCO Members only.

ComputerWorld

A RAYGAM COMPANY

6791 Westminster Ave., Westminister, CA 92683 (714) 891-2587

WANTED: ATARI®

• • • FIND IT AT COMPUTERWORLD.

ATARI® 800™ PERSONAL COMPUTER SYSTEM

PRICE INCLUDES:

Computer Console
BASIC Language Cartridge
Education System Master Cartridge
BASIC Language Programming Manual (Wiley)
800 Operator's Manual with Note Book
ATARI 410 Program Recorder
Guide to BASIC Programming Cassette
8K RAM Module • Power Supply •
TV Switch Box

\$999⁹⁹

ATARI® 400™ PERSONAL COMPUTER SYSTEM

PRICE INCLUDES:

Computer Console
BASIC Language Cartridge
BASIC Language Programming Manual (Wiley)
400 Operator's Manual with Note Book
Power Supply
TV Switch Box

\$549⁹⁹



PERIPHERALS AND ACCESSORIES

ATARI® 810™ DISC DRIVE* DISKETTES

\$749.99

CX8100 BLANK DISKETTES*
CX8101 DISK FILE MANAGER*
\$5.00/ea.

ATARI® 820™ PRINTER*

\$599.99

ACCESSORY CONTROLLERS
CX2C-01 DRIVING CONTROLLER PAIR
CX3D-04 PADDLE CONTROLLER PAIR
CX4D-04 JOYSTICK CONTROLLER PAIR
\$19.95/ea.

ATARI® 410™ PROGRAM RECORDER \$89.99 ADD-ON MEMORY (800 ONLY)

CX852 8K RAM MEMORY MODULE \$124.99
CX853 16K RAM MEMORY MODULE \$249.99

SOFTWARE

ROM CARTRIDGES

CXL4001 EDUCATION SYSTEM MASTER
CARTRIDGE \$34.99
KEY: (j) = uses joystick controller
(p) = uses paddle controller
(d) = uses driving controller

GAMES \$49.99/ea.

CXL4004 BASKETBALL (j)
CXL4005 LIFE (j)
CXL4006 SUPER BREAKOUT™ (p)
CX4008 SUPER BUG™** (d)

APPLICATION \$69.99

CXL4002 ATARI BASIC
CXL4003 ASSEMBLER DEBUG**
CXL4007 MUSIC COMPOSER
CXL4009 COMPUTER CHESS** (j)

EDUCATION SYSTEM CASSETTE PROGRAMS \$39.99/ea.

CX6001 U.S. HISTORY
CX6002 U.S. GOVERNMENT
CX6003 SUPERVISORY SKILLS
CX6004 WORLD HISTORY (WESTERN)
CX6005 BASIC SOCIOLOGY
CX6006 COUNSELING PROCEDURES
CX6007 PRINCIPLES OF ACCOUNTING
CX6008 PHYSICS

CX6009 GREAT CLASSICS (ENGLISH)
CX6010 BUSINESS COMMUNICATIONS
CX6011 BASIC PSYCHOLOGY
CX6012 EFFECTIVE WRITING
CX6013 AUTO MECHANICS
CX6014 PRINCIPLES OF ECONOMICS
CX6015 SPELLING
CX6016 BASIC ELECTRICITY
CX6017 BASIC ALGEBRA

BASIC GAME AND PROGRAM CASSETTES

CX4101 GUIDE TO BASIC PROGRAMMING*
CX4102 BASIC GAME PROGRAMS*
\$29.95/ea.

*October Delivery **November Delivery

—Prices subject to change.—

We Promise to Deliver!

- We GUARANTEE ship dates on prepaid Computer System orders.*
- If for reasons beyond our control we miss a ship date, WE WILL REFUND THE SHIPPING AND HANDLING CHARGES TO YOU — PLUS GIVE YOU A 10% DISCOUNT ON YOUR NEXT PURCHASE OF ANY ATARI SOFTWARE!
- For prepaid Computer System orders, you'll receive an Accessory Controller of your choice.

*All prepaid orders must be for full amount by Cashier's Check only, payable to ComputerWorld. California residents, please add 6% sales tax.

ORDERING INFORMATION:

1. Type or print item(s) you wish to order.
2. If you pay by personal check: please allow 2 weeks for personal check to clear.
3. If you pay with bank card: We accept VISA, BankAmericard, MasterCharge. Please include bank card number, card expiration date, and your signature.
4. Add 50¢ for postage and handling of books, manuals, catalogs, and magazines. Add \$10.00 for shipping, handling, and insurance for hardware and systems orders.
5. Send orders to ComputerWorld, 6791 Westminster Ave., Westminster, CA 92683. California residents, please add 6% sales tax.

TELEX 182274

ComputerWorld

A RAYGAM COMPANY

6791 Westminster Ave., Westminster, CA 92683 (714) 891-2587

SOMETHING FOR EVERYONE

610 Boards \$298

8K static expandable
to 24K and dual mini-
floppy controller

Grow to a FLOPPY on your C1-P or SYM.

COLOR COMPUTERS 16 COLORS

The C4P and C8P offer a brilliant array of 16 colors including black available in both alphabets and graphics. The C4P and C8P have execution speed that is twice as fast as Apple II, or Commodore PET and over THREE times as fast as TRS-80 more display than other personal computers.

As you can see, the C4P and C8P are truly exceptional premium computers with just their standard features alone. Above and beyond that they are easily expandable to add exciting advanced features like word processing, additional memory, voice I/O, and our new universal telephone interface (UTI).



\$399 for COLOR MONITORS

BEAT THE RUSH-ORDER OR PICK IT UP NOW!

* Apple II, Commodore PET, TRS-80, and Atari 800 are registered trade names of Apple Computer Inc., Commodore Business Machines Ltd., Radio Shack, Atari, respectively.

Name _____

Address _____

City _____

State _____ Zip _____

Phone _____

COMPUTERSHOP
 Boston 590 Comm. Ave. (across from B.U.) 247-0700
 Union NH Rte 108 603-473-2323
 Cambridge 288 Norfolk St. (near M.I.T.) 661-2670

Send me a \$ _____ enclosed

Payment by: BAC (VISA) _____ Master Charge _____

Credit Card Account # _____

Expires _____

TOTAL CHARGED OR ENCLOSED _____

All orders shipped insured UPS unless otherwise requested

If You Treat It Nicely It Won't Byte

Jack Robert Swindell
P.O. Box 8193
Canton, OH 44711

Tools and techniques for using the Superboard II are presented — including a Double Disassembler. This program gives a lot of information about each byte of memory, not just the opcode. Several other Superboard features are discussed.

I selected the Superboard II for use as an intelligent terminal in a PDP-II system. It enables the designer of a distributed processing system to take a number of liberties due to the speed and power of each distributed branch. Before this multi-processor system can come into full operation, a number of things need to be discovered about the internal workings of the Superboard. This article describes some of the tools, techniques and discoveries found on the road to the goal. I hope you find them as useful as I have.

In order to really gain an understanding of the inner workings, a disassembler or something similar will be required, as the monitor leaves a lot to be desired. The listing in figure 1 uses about 3.6K of memory, i.e. you need at least 5K to run it. It is a combination

mnemonic lister and intelligent disassembler. The leftmost column will *a/ways* print a mnemonic, thusly treating each and every instruction as though it were only one byte in length. The rightmost column attempts to decipher whether the instruction is one, two, or three bytes in length and differentiate its print to distinguish op-codes from their operands. Columns two and three are the address and op-code in decimal form to help when using PEEK and POKE at later times. The fourth column prints any valid ASCII characters that it finds to help with the recognition of text or buried cues when the disassembler "gets confused" and has to re-sync itself or might need some help.

The reason I mention manual re-sync is that one soon grows weary of

seeing "resync?????" time and time again when the program is running through a giant table of either string data or numeric data. Of course it *will* re-sync...but why waste the paper? On to columns five and six; these have the address and op-code in hexadecimal format to help when looking in books (which are nearly all in hex now). The rightmost and seventh column is what it is all about.

The seventh column is the intelligent column. It attempts to convey to you its interpretation of what it's reading out of memory. It does not resequence the order of bytes for printing when looking at a multi-byte instruction as many disassemblers do. I didn't deem it necessary at the time. To illustrate my point, look at illustration 2. The JSR at hex 0222 has AB directly following it and CD two bytes later. A little human

Fig. (Listing) 1.

```

*****
* 1 o'clock-31 * 7 o'clock 31*
* 2 o'clock-30 * 8 o'clock 30*
* 3 o'clock 1 * 9 o'clock-1 *
* 4 o'clock 34 * 10 o'clock-34*
* 5 o'clock 33 * 11 o'clock-33*
* 6 o'clock 32 * 12 o'clock-32*
*****

```

To run this routine place the number which you wish merged to the display in register A. Load the starting video address in register B. Put the video incrementing factor in register C. Gosub 50000. Once A, B, and C are loaded they remain intact after program execution.

A picture is worth a thousand words (2K bytes?). Load and run the program in figure (4) to see both how all the different display angles look and what happens when a scientific notation display is caused to overlap the edge of the display when run at a steep angle. Make sure you load figure (3) or it will try and call a non-existent subroutine.

On-Screen Expose'

Did you know that there is a graphics/control character that you can print on the screen by just pressing two keys? There is! Control G will create the character that you see when you try to type in a line that's a bit too long. You can type it into a string just like it was a letter or symbol. As an added bonus, if you have a printer tied in, it will ring its bell...instant prompt.

I have one more thing of interest for you before I return to bury myself in my favorite world of semiconductors and software. The location (in page zero) of the on screen text begins at 19 decimal and continues up to 90 decimal which always contains a zero when examined. Therefore 71 bytes can be defined, the 72nd is a zero. To see what I mean do the following in command mode:

- 1) Press Return (to make sure everything is terminated).
- 2) Hold down the space bar until the screen starts to show the control G characters mentioned earlier.
- 3) Press Return (this clears the on screen text internally).
- 4) Type
perfectly: FORS = 19T090: ?CHR\$(PEEK(S));: NEXTS.
- 5) Press Return.

Now do you see what I mean? Happy computing, that's all for now. Would anyone want to hear about a Superboard speedup? Almost 2MHz or double speed and it doesn't alter the I/O baud rates, however, none of the OSI RAM chips could cut the mustard. If you want an article on this, write! Bye.

```

10 REM Double Disassembler
20 REM Written by
30 REM Jack Robert Swindell
40 REM August 23, 1979
100 DATA"BRK",1,"ORA-I-X",2,"?",9,"?",9
110 DATA"?",9,"ORA-O-P",2,"ASL-O-P",2,"?",9
120 DATA"PHP",1,"ORA-IMM",2,"ASL-A",1,"?",9
130 DATA"?",9,"ORA",3,"ASL",3,"?",9
140 DATA"BP",2,"ORA-I-Y",2,"?",9,"?",9
150 DATA"?",9,"ORA-O-P-X",2,"ASL-O-P-X",2,"?",9
160 DATA"CLC",1,"ORA-Y",3,"?",9,"?",9
170 DATA"?",9,"ORA-X",3,"ASL-X",3,"?",9
180 DATA"JSR",3,"AND-I-X",2,"?",9,"?",9
190 DATA"BIT-O-P",2,"AND-O-P",2,"ROL-O-P",2,"?",9
200 DATA"PLP",1,"AND-IMM",2,"ROL-A",1,"?",9
210 DATA"BIT",3,"AND",3,"ROL",3,"?",9
220 DATA"BMI",2,"AND-I-Y",2,"?",9,"?",9
230 DATA"?",9,"AND-O-P-X",2,"ROL-O-P-X",2,"?",9
240 DATA"SEC",1,"AND-Y",3,"?",9,"?",9
250 DATA"?",9,"AND-X",3,"ROL-X",3,"?",9
260 DATA"RTI",1,"EOR-I-X",2,"?",9,"?",9
270 DATA"?",9,"EOR-O-P",2,"LSR-O-P",2,"?",9
280 DATA"PHA",1,"EOR-IMM",2,"LSR-A",1,"?",9
290 DATA"JMP",3,"EOR",3,"LSR",3,"?",9
300 DATA"BVC",2,"EOR-I-Y",2,"?",9,"?",9
310 DATA"?",9,"EOR-O-P-X",2,"LSR-O-P-X",2,"?",9
320 DATA"CLI",1,"EOR-Y",3,"?",9,"?",9
330 DATA"?",9,"EOR-X",3,"LSR-X",3,"?",9
340 DATA"RTS",1,"ADC-I-X",2,"?",9,"?",9
350 DATA"?",9,"ADC-O-P",2,"ROR-O-P",2,"?",9
360 DATA"PLA",1,"ADC-IMM",2,"ROR-A",1,"?",9
370 DATA"JMP-I",3,"ADC",3,"ROR",3,"?",9
380 DATA"BVS",2,"ADC-I-Y",2,"?",9,"?",9
390 DATA"?",9,"ADC-O-P-X",2,"ROR-O-P-X",2,"?",9
400 DATA"SEI",1,"ADC-Y",3,"?",9,"?",9
410 DATA"?",9,"ADC-X",3,"?",9,"?",9
420 DATA"?",9,"STA-I-X",2,"?",9,"?",9
430 DATA"STY-O-P",2,"STA-O-P",2,"STX-O-P",2,"?",9
440 DATA"STY",1,"?",9,"TXA",1,"?",9
450 DATA"STY",3,"STA",3,"STX",3,"?",9
460 DATA"BCC",2,"STA-I-Y",2,"?",9,"?",9
470 DATA"STY-O-P-X",2,"STA-O-P-X",2,"STX-O-P-X",2,"?",9
480 DATA"TYA",1,"STA-Y",3,"TXS",1,"?",9
490 DATA"?",9,"STA-X",3,"?",9,"?",9
500 DATA"LDY-IMM",2,"LDA-I-X",2,"LDX-IMM",2,"?",9
510 DATA"LDY-O-P",2,"LDA-O-P",2,"LDX-O-P",2,"?",9
520 DATA"TAY",1,"LDA-IMM",2,"TAX",1,"?",9
530 DATA"LDY",3,"LDA",3,"LDX",3,"?",9
540 DATA"BCS",2,"LDA-I-Y",2,"?",9,"?",9
550 DATA"LDY-O-P-X",2,"LDA-O-P-X",2,"LDX-O-P-X",2,"?",9
560 DATA"CLV",1,"LDA-Y",3,"TSX",1,"?",9
570 DATA"LDY-X",3,"LDA-X",3,"LDX-Y",3,"?",9
580 DATA"CPY-IMM",2,"CMP-I-X",2,"?",9,"?",9
590 DATA"CPY-O-P",2,"CMP-O-P",2,"DEC-O-P",2,"?",9
600 DATA"INY",1,"CMP-IMM",2,"DEX",1,"?",9
610 DATA"CPY",3,"CMP",3,"DEC",3,"?",9
620 DATA"BNE",2,"CMP-I-Y",2,"?",9,"?",9
630 DATA"?",9,"CMP-O-P-X",2,"DEC-O-P-X",2,"?",9
640 DATA"CLD",1,"CMP-Y",3,"?",9,"?",9
650 DATA"?",9,"CMP-X",3,"DEC-X",3,"?",9
660 DATA"CPX-IMM",2,"SBC-I-X",2,"?",9,"?",9
670 DATA"CPX-O-P",2,"SBC-O-P",2,"INC-O-P",2,"?",9
680 DATA"INX",1,"SBC-IMM",2,"NOP",1,"?",9
690 DATA"CPX",3,"SBC",3,"INC",3,"?",9
700 DATA"BEQ",2,"SBC-I-Y",2,"?",9,"?",9
710 DATA"?",9,"SBC-O-P-X",2,"INC-O-P-X",2,"?",9
720 DATA"SED",1,"SBC-Y",3,"?",9,"?",9
730 DATA"?",9,"SBC-X",3,"INC-X",3,"?",9
800 REM End of data table
900 CLEAR
1000 PRINT"6502 Double Disassembler - 1979 - J. Swindell"
1010 PRINT
1020 INPUT"Input low&high addresses of block to be listed:Decimal";P;Q
1030 PRINT:PRINT:PRINT:PRINT
1040 PRINT"MNE";TAB(15);"A-DEC";TAB(25);"O-DEC";TAB(33);"ASCII";
1050 PRINTTAB(39);"A-HEX";TAB(48);"O-HEX";TAB(55);"MNE(if valid)"
1060 PRINT:PRINT
1070 FORU=PTOQ
1080 M=PEEK(U)
1090 RESTORE
1100 FORD=OTOM

```

GREAT PET SOFTWARE

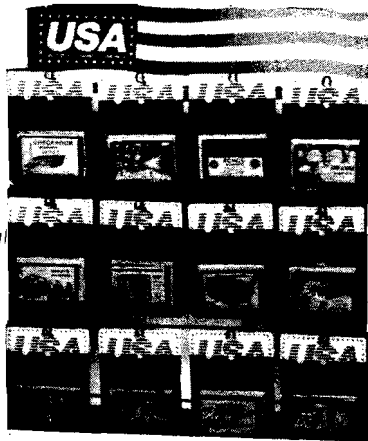

"Precise, humanized, well documented an excellent value" are the applauds now being given to United Software's line of software. These are sophisticated programs designed to meet the most stringent needs of individuals and business professionals. Every package is fully documented and includes easy to understand operator instructions.

DATABASE MANAGEMENT SYSTEM - A comprehensive, interactive system like those run on mainframes! Six modules comprising 42K of programming allow you to; create, edit, delete, display, print, sort, merge, etc., etc. - databases of up to 10,000 records. Printer routines automatically generate reports and labels on demand. 60 pages of concise documentation are included. Requirements - 16-32K PET and 2040 Dual Disk (printer optional). . . . **Cost \$125**

ACCOUNTS RECEIVABLE/PAYABLE - A complete, yet simple to use accounting system designed with the small businessman in mind. The United Software system generates and tracks purchase orders and invoices all the way through posting "controlled" accounts payable and accounts receivable subsystems. Keyed Random Access file methods makes data access almost instantaneous. The low-cost solution for the first time computer user with up to 500 active accounts. Requirements - 32K PET, Dual Disk, any 80-column printer. . . . **Cost \$175**

CASH RECEIPTS & DISBURSEMENTS - Makes it a breeze to track all outgoing payments made by any type of business operation. Checks are tracked by number and categorized by type of expense. Sorting, summary, and audit trails make it easy to post to general ledger. This system also categorizes incoming receipts. Uses KRAM file access method. Requirements - 32K PET, Dual Disk (printer optional). . . . **Cost \$99.95**

KRAM - Keyed Random Access Method - The new, ultra-fast access method for the PET Disk, provides keyed retrieval/storage of data, in either direct or sequential mode, by either full or partial key values. Written by United Software in 6502 machine code, and designed with the PET in mind, it exploits all the benefits of the PET Disk, allowing full optimization of your system. Eliminates the need for "Sort" routines! KRAM provides flexibility never seen on a micro before. KRAM is modeled after a very powerful access method used on large-scale IBM Virtual Storage mainframes. So "KRAM" all you can into your PET - it will love you for it. . . . **Cost \$79.95**

(Sublicenses available to software houses.)

PROGRAMS FOR ENTERTAINMENT	
Space Intruders	
("Best Game of 1979")	\$19.95
Jury/Hostage	12.50
Kentucky Derby/Roulette	9.95
Alien I.Q./Tank	9.95
Tunnelvision/Maze Chase	14.95
Submarine Attack	9.95
Battle of Midway	7.95
Laser Tank Battle	9.95
Swarm	14.95
Super Startrek	14.95
PET Music Box	29.95
UNITED SOFTWARE PROGRAMS FOR BUSINESS	
Checkbook	\$15.95
Mortgage	15.95
Finance	12.95
Bonds	12.95
Stock Analyzer	22.95
Stock Options	24.95
6502 Macro Assembler	49.95

Look for the RED-WHITE-BLUE United Software Display at your local computer dealer, or send check or money order, plus \$1.00 shipping to:

UNITED SOFTWARE OF AMERICA
750 Third Ave.
New York, N.Y. 10017 Dealer inquiries invited

```

1110 READM$,N
1120 NEXTO:IFN=9THENN=5
1130 PRINTM$;TAB(15);U;TAB(25);M;TAB(33);
1140 IFM<320RM>126THENPRINTCHR$(32);
1150 IFM>=32ANDM<127THENPRINTCHR$(M);
1160 R=U
1170 GOSUB1300
1180 PRINTTAB(39);J$;TAB(48);
1190 D=M
1200 GOSUB1400
1210 PRINTI$;TAB(55);
1220 IFV=0THENT=N
1230 IFV=0THENPRINTM$
1240 IFV=0ANDT=5THENPRINT'Resync';FORB=1TO58:
PRINT'?'*;NEXTB:PRINT'?'
1250 IFV=0THENPRINT'***';I$;'***'
1260 V=V+1;IFV=T THENV=0:PRINT
1270 NEXTU:PRINT:PRINT:PRINT:PRINT
1280 PRINT'END OF RUN':PRINT:PRINT
1290 END
1300 D=INT(R/256)
1310 GOSUB1400
1320 J$=I$
1330 I=R-I*256
1340 GOSUB1400
1350 J$=J$+I$
1360 RETURN
1400 E=INT(D/16)
1410 F=D-E*16
1420 H=E
1430 GOSUB1500
1440 I$=H$
1450 H=F
1460 GOSUB1500
1470 I$=I$+H$
1480 RETURN
1500 IFH<10THENH$=MID$(STR$(H),2,1)
1510 IFH<0THENH$="0"
1520 IFH=10THENH$="A"
1530 IFH=11THENH$="B"
1540 IFH=12THENH$="C"
1550 IFH=13THENH$="D"
1560 IFH=14THENH$="E"
1570 IFH=15THENH$="F"
1580 RETURN

```

DISK DRIVE WOES? PRINTER INTERACTION? MEMORY LOSS? ERRATIC OPERATION? DON'T BLAME THE SOFTWARE!

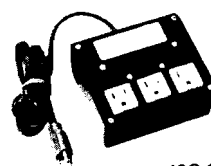

ISO-1



ISO-2

Power Line Spikes, Surges & Hash could be the culprit! Floppies, printers, memory & processor often interact! Our unique ISOLATORS eliminate equipment interaction AND curb damaging Power Line Spikes, Surges and Hash.

- *ISOLATOR (ISO-1A) 3 filter isolated 3-prong sockets; integral Surge/Spike Suppression; 1875 W Maximum load, 1 KW load any socket \$54.95
- *ISOLATOR (ISO-2) 2 filter isolated 3-prong socket banks; (6 sockets total); integral Spike/Surge Suppression; 1875 W Max load, 1 KW either bank \$54.95
- *SUPER ISOLATOR (ISO-3), similar to ISO-1A except double filtering & Suppression \$79.95
- *ISOLATOR (ISO-4), similar to ISO-1A except unit has 6 individually filtered sockets \$93.95
- *ISOLATOR (ISO-5), similar to ISO-2 except unit has 3 socket banks, 9 sockets total \$76.95
- *CIRCUIT BREAKER, any model (add-CB) Add \$ 6.00
- *CKT BRKR/SWITCH/PILOT any model (-CBS) Add \$11.00

PHONE ORDERS 1-617-655-1532

Electronic Specialists, Inc.

171 South Main Street, Natick, Mass. 01760



Dept. MI

THE COMPUTERIST INC

P.O. Box 3, S. Chelmsford, MA 01824
617/256-3649

MEMORY PLUS™ FOR AIM/SYM/KIM



8K STATIC RAM LOW POWER
Sockets for 8K Eprom
6522 I/O Port
ON BOARD REGULATORS
EPROM PROGRAMMER

MEMORY PLUS: \$200.00 FULLY ASSEMBLED AND TESTED

EXPAND YOUR SYSTEM WITH MEMORY PLUSTM

MEMORY PLUS combines four of the most important system expansion capabilities on one PC board. This board uses the standard **KIM-4 Expansion Bus** and is the same size/shape as the KIM-1/SYM-1 so it can be conveniently placed under any AIM/SYM/KIM system. The four functions are:

- 8K RAM** - with low power 2102 static RAM - the most important addition for most systems.
- 8K EPROM** - sockets and address decoding for up to 8K of Intel 2716 type EPROM.
- EPROM Programmer** - program your EPROMS on the board! **I/O - 6522 Versatile Interface** provides two 8 bit I/O ports, two multi-mode timers, and a serial/parallel shift register

Other features of Memory Plus include:

- On-board voltage regulators for +5V for general power and +25V for the EPROM Programmer.
- Independent switch selection of the RAM and ROM starting addresses.
- All IC's socketed for easy field replacement.
- Fully assembled and burned in - ready to plug in and go.
- Documentation includes a 60+ page manual with schematics, program listings, 2716 and 6522 data sheets, and a cassette tape with an EPROM Programming Program and a Memory Test.
- Over 800 **MEMORY PLUS** units are already in use with **AIMs, SYMs and KIMs**
- May be directly connected to your system with our cable or through our **MOTHER PLUSTM** board.

IT'S EASY TO ADD VIDEO PLUSTM TO YOUR SYSTEM.

VIDEO PLUS is the most powerful expansion board ever offered for 6502 based systems. It has many important video features including:

- Programmable Display Format** - up to 100 characters by 30 lines on a good monitor.
- A ROM Character Generator with **UPPER and lower case ASCII** characters.
- A **Programmable Character Generator** for up to 128 user defined characters which may be changed under program control. You can define **graphics, music symbols, chess pieces, foreign characters, gray scale** - and change them at will! May be used with an inexpensive TV set or an expensive monitor.
- Up to **4K of Display RAM**, with **Hardware scrolling, programmable cursor**, and more.

In addition to the video features, **VIDEO PLUS** also has:

- A **Keyboard Interface** which will work with any "reasonable" keyboard.
- A built-in **Light Pen Interface**.
- Provision for a **2K EPROM** or ROM for video control or other software.
- All of the memory - **6K RAM** and **2K EPROM** can be used as system memory whenever it is not in use as display or programmable character generator
- VIDEO PLUS** may be used directly as an expansion of an AIM/SYM/KIM system, or has provision for the addition of a 6502 for use as a **Stand-Alone** system or Terminal!

Only requires +5V and has on board voltage regulators. Since it's the same size/shape as the KIM or SYM, it may easily be placed under an AIM/SYM/KIM system. It uses the **KIM-4** expansion format. Fully assembled, tested and burned in. Connect directly to your system or via the **MOTHER PLUS** board.

VIDEO PLUS™ FOR AIM/SYM/KIM

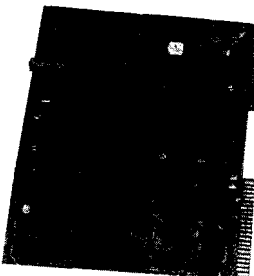

UPPER/lower case ASCII
128 Additional User Programmable Characters: GRAPHICS
SYMBOLS-FOREIGN CHARACTERS
Programmable Screen Format up to 80 CHARACTERS - 24 LINES
KEYBOARD and LIGHT PEN interfaces
Up to 4K DISPLAY RAM
Provision for 2K EPROM
Provision to add 6502 for STAND-ALONE SYSTEM

ASSEMBLED AND TESTED WITH 2K DISPLAY RAM
VIDEO PLUS: \$245.00

ADD YOUR OWN CIRCUITS WITH PROTO PLUSTM

PROTO PLUS is the simple way to add special circuits to your system. It is the same size and shape as the KIM and SYM, making it extremely easy to use with these systems, and can be neatly added to the AIM as well. It provides about 80 square inches of work area. This area has provision for about **40 14/16 pin sockets**, about **4 24/40 pin sockets**, **3 regulators**, etc. The connections to the board are made through two sets of gold plated fingers - exactly like the AIM/SYM/KIM. This means that there are a total of 88 edge connections - more than enough for most applications. This is a professional quality, double sided board with plated through holes. The layout was designed so that you can use wire wrap sockets or solder sockets - each IC pad comes out to multiple pads. There is room for voltage regulators and a number of other "non-standard" devices. The **PROTO PLUS** will plug directly into the **MOTHER PLUS** making for a handy package.

PROTO PLUS™ FOR AIM/SYM/KIM

Same **SIZE** and **SHAPE** as KIM/SYM

Professional Quality

Double Sided, Plated through Holes

Two Sets of **GOLD Plated Dual 22 Fingers**

Designed for **WIRE WRAP** or **SOLDER** Connections

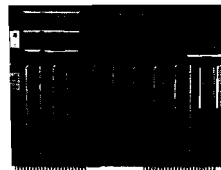

Provisions for **40 14/16 pin sockets**
4 24/40 pin sockets
3 voltage regulators

PROTO PLUS: \$40.00

PUT IT ALL TOGETHER WITH MOTHER PLUSTM.

MOTHER PLUS provides the simplest way to control and package your expanded system. **MOTHER PLUS** does three major things: 1 - provides a method of interconnecting the individual boards (**MEMORY PLUS, VIDEO PLUS, PROTO PLUS**); 2 - provides buffering for the address, data and control signals; and, 3 - acts as a traffic cop for determining which addresses are reserved for the processor and which for the expansion boards. It supports the **standard KIM-4 Expansion Bus**, so it is electrically compatible with a large number of expansion boards. It is structured so that the processor board fits into the top slots with the expansion boards mounting below. This permits a system to be neatly packaged - it doesn't have its guts hanging out all over a table top. Provision is also made for application connections through solder eyelet connectors. Specifically designed to work with **AIM/SYM/KIM** systems. Other features are: a terminal for bringing power into your system; phono jacks for the **Audio In/Audio Out**; phono jacks for connecting a TTY device; provision for a **TTY/HEX switch** for the KIM; a **16 pin I/O socket** for accessing the host Port A/Port B; plus two undedicated 16 pin sockets which may be used to add inverters, buffers, or whatever to your system.

Prices listed do not include shipping and handling. Please write for complete catalog and order form.

MOTHER PLUS™ FOR AIM/SYM/KIM

ADD UP TO FIVE ADDITIONAL BOARDS

AUDIO/TTY CONNECTIONS
POWER TERMINALS
APPLICATION CONNECTORS

FULLY BUFFERED
FULLY DECODED
KIM-4 Bus Structure

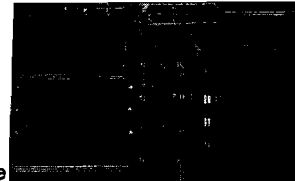

MOTHER PLUS: \$80.00 FULLY ASSEMBLED AND TESTED

The **COMPUTERIST** makes it easy for you to expand your **AIM, SYM, or KIM** system.



compas
microsystems

P.O. Box 687
224 S.E. 16th Street
Ames, Iowa 50010

DAIM

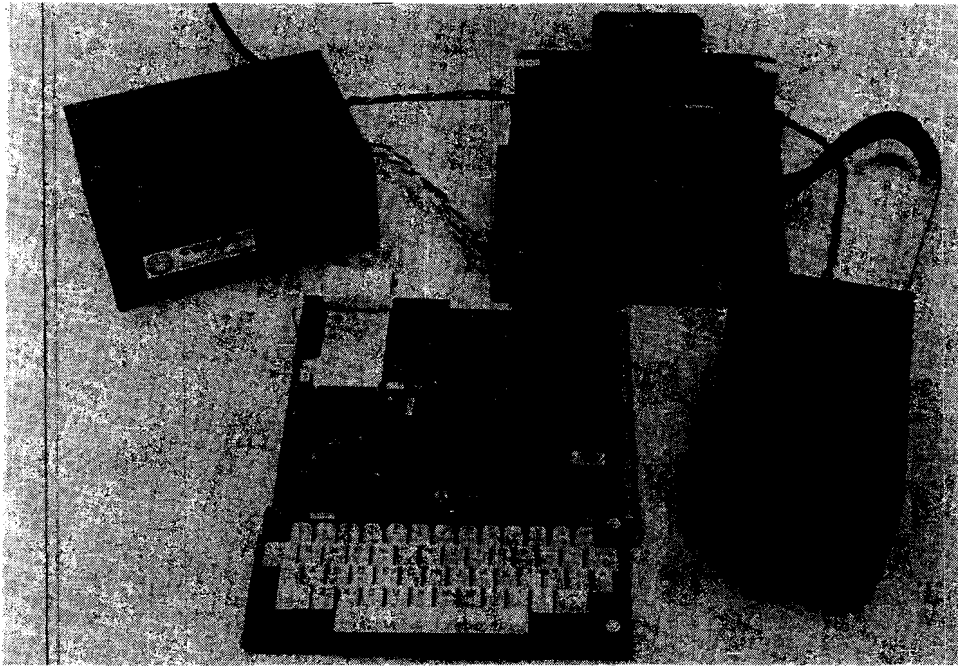

DAIM is a complete disk operating system for the ROCKWELL INTERNATIONAL AIM 65. The DAIM system includes a controller board (with 3.3K operating system in EPROM) which plugs into the ROCKWELL expansion motherboard, packaged power supply capable of driving two 5 1/4 inch floppy drives and one or two disk drives mounted in a unique, smoked plastic enclosure. DAIM is completely compatible in both disk format and operating system functions with the SYSTEM 65. Commands are provided to load/save source and object files, initialize a disk, list a file, list a disk directory, rename files, delete and recover files and compress a disk to recover unused space. Everything is complete — plug it in and you're ready to go! DAIM provides the ideal way to turn your AIM 65 into a complete 6500 development system. Also pictured are CSB 20 (EPROM/RAM) and CSB 10 (EPROM programmer) which may be used in conjunction with the DAIM to provide enhanced functional capability. Base price of \$850 includes controller board with all software in EPROM, power supply and one disk drive. Now you know why we say —

There is nothing like a

DAIM

Phone 515-232-8187

Sharpen Your AIM

Robert E. Babcock
1706 Fawcett Ave.
White Oak, PA 15131

A collection of four programs are presented which enhance the capabilities of the basic AIM 65. These programs improve hex loading, clear memory, move memory and slow down the display.

Recently several Rockwell AIM-65 microcomputer systems were purchased for use in teaching courses in microprocessors and microcomputers at the campus of the Pennsylvania State University at which I teach. These were intended to supplement the KIM-1 systems which have been used for that purpose for the past three years. The press of other activities has prevented more than intermittent exposure to the full capabilities of the AIM-65; however, some basic impressions and evaluations are possible.

Overall, the impression has been highly favorable. First, due to the similarity with the KIM-1, the AIM has been easy to learn. Even students with virtually no exposure to any type of microcomputer have had little difficulty in learning to use the system effectively. In this regard, the documentation provided with the AIM-65 is excellent. The AIM-65 Microcomputer User's Guide is easy to follow and has a sizeable number of examples to clarify concepts stated in the material related to a portion of the system or its operation. Identification of many of the most useful subroutines and their characteristics has proved to be a special blessing. The clock program used as an application example at the end of the manual involves virtually every mode of operation. It provides an excellent base for understanding the system and in addition serves as a firm foundation for a flexible data sampling and logging system. Although a few errors exist in the User's Manual, most are of minor consequence.

Second, the extensive monitor program has a great many features not generally found in a system of this price class. These features make it possible to program the AIM more rapidly and with fewer errors than is possible for an essentially identical program using the KIM-1. The features which come to mind most readily are the mnemonic entry capability, the disassembler, and the text editor. The printer with its hard copy put the topping on the physical attributes of the system. Less visible, but equally as convenient, are the cassette interface with its much higher speed and flexibility when compared with the KIM-1. The ability to use the KIM format permits the application of many KIM programs to the AIM. Finally, the 20 character display with the ability to use alphanumerics expands the capabilities of the AIM-65.

No system is completely without its shortcomings and the AIM is no exception. Fortunately, the shortcomings are few and most are easily corrected. One of the problems arises from the fact that in the memory modify mode, (I), the program is returned to the system monitor after four entries. While all that is necessary to return to the modify mode is to again press (I), often when entering a program from a hex dump format or entering hex values into a table or entering a short ASCII message statement, it is easy to forget to re-enter (I). The short program shown below, HEX LOAD, uses the same format as the M followed by (I) process but automatically remains in the modify mode until terminated by an ESC. There is a printout of the entered characters and the address of the lowest byte just as in the normal operation. The only difference is that it is no

longer necessary to enter (I) after each four entries. To use HEX LOAD, begin execution at 0600 (or the beginning address selected if in a different location) by the usual entries, "(*)=0600", RETURN, "G", RETURN. The display will show "= ". Enter the address at which hex entries are to start, RETURN, and the starting address will be displayed with the prompt "A". Make the desired hex entries as a continuous string, then terminate with ESC.

```
HEX LOAD
(K)*=0600
/20
```

```
0600 20 JSR EAAE
0603 20 JSR E83E
0606 A0 LDY #00
0608 20 JSR EA5D
060E 90 BCC 0613
060D C9 CMP #20
060F DC BNE 0623
0611 F0 BEQ 061E
0613 20 JSR EB78
0616 F0 BEQ 061E
0618 4C JMP EB33
061E 20 JSR E83E
061E C8 INY
061F C0 CPY #04
0621 D0 ENE 0608
0623 20 JSR E2CD
0626 20 JSR EA13
0629 20 JSR E2DE
062C 20 JSR E83E
062F D0 BNE 0606
```

SLOW DIS
(K)*=0200
/38

```

0200 A9 LDA #4B
0202 20 JSR E97A
0205 A9 LDA #2A
0207 20 JSR E97A
020A 20 JSR EAAE
020D B0 BCS 0200
020F 20 JSR E5D7
0212 20 JSR EB37
0215 20 JSR E785
0218 20 JSR EA24
021B 20 JSR F46C
021E AD LDA A425
0221 38 SEC
0222 65 ADC EA
0224 8D STA A425
0227 90 BCC 022C
0229 EE INC A426
022C 20 JSR EA24
022F 20 JSR E907
0232 20 JSR E790
0235 F0 BEQ 023D
0237 20 JSR 0240
023A 4C JMP 021E
023D 4C JMP E1A1
0240 A9 LDA #10
0242 85 STA AC
0244 A9 LDA #00
0246 8D STA A00E
0249 A9 LDA #FF
024B 8D STA A008
024E 8D STA A009
0251 A9 LDA #20
0253 2C BIT A00D
0256 F0 BEQ 0253
0258 AD LDA A008
025B C6 DEC AC
025D D0 BNE 0249
025F 60 RTS

```

ZERO PAGE LOCATIONS USED:

00AC Timing Loops
00EA Length (Used by monitor ROM)

The second difficulty is an annoyance with the speed at which disassembly occurs when the printer is not in operation. This mode of operation

is sometimes desirable to conserve paper while debugging or while checking for a particular part of a program. The program left, SLOW DIS, introduces about a 1 second delay between steps during disassembly without the printer. Location 0241 can be modified to change the speed as desired. Execute the program in the normal way using (*)=0200, RETURN, "G", RETURN. The display will indicate "K*=". Enter the starting address of the material to be disassembled and the number of steps as in normal operation. If an indefinite number of steps was selected by "SPACE", then the program must be terminated by ESC.

One of the major advantages of the AIM-65 over the KIM-1 and other similar systems using 7-segment read-out displays (limited to six digits), is the relative ease of using meaningfully prompted programs which eliminate the need to record or remember the proper addresses into which data must be entered to initiate the program. With prompting, the required information can be asked for, inserted, and stored in appropriate locations under program control. Two utility programs, CLEAR and MOVER, included below, are of the prompted type. MOVER is a data transfer program capable of moving any amount of data either forward or backward to a designated starting address. Execution of the program results in a prompting message of "OLD FROM=" to elicit the entry of the starting address of the data to be moved. After the address has been entered and RETURN activated, "TO=" calls for the ending address of the data to be moved. When RETURN is again used, the prompt "NEW FROM=" appears to bring about entry of the starting address at which the moved data is to start. This time RETURN causes execution of the move process, completion of which is indicated by a cleared display except for the normal " " at the left side of the display. Similarly, CLEAR uses prompting messages, "CLR FROM=" and "TO=" to obtain the limiting addresses of the area into which zeros or any other designated character may be entered. The area can be of any size.

A general breakdown of the features of these two programs can be used to show the various sections and their functions. In CLEAR, the program from 0300 through 0314 provides the prompt message generation; 0315 through 0330 contains the address input and storage functions; 0331 through 033D contains the calculation of the high and low order bytes of the length of the area involved; and the remainder of the program performs the actual data storage procedure. Location 0340 may be modified to any value with which it is desired to load a selected memory area. Locations 035F - 0361 contain the "CLR" message.

CLEAR

(K)*=0300
/46

```

0300 20 JSR EA13
0303 A0 LDY #00
0305 B9 LDA 035F
0308 48 PHA
0309 29 AND #7F
030B 20 JSR E97A
030E C8 INY
030F 68 PLA
0310 10 BPL 0305
0312 20 JSR E83E
0315 20 JSR E7A3
0318 AD LDA A41C
031B 85 STA 00
031D AD LDA A41D
0320 85 STA 01
0322 20 JSR E7A7
0325 B0 BCS 0322
0327 AD LDA A41C
032A 85 STA 02
032C AD LDA A41D
032F 85 STA 03
0331 38 SEC
0332 A5 LDA 02
0334 E5 SEC 00
0336 85 STA 04
0338 A5 LDA 03
033A E5 SBC 01
033C F0 BEQ 034C
033E AA TAX
033F A9 LDA #00
0341 A8 TAY
0342 91 STA (00),Y
0344 C8 INY
0345 D0 BNE 0342
0347 E6 INC 01
0349 CA DEX
034A D0 BNE 0342
034C E6 INC 04
034E A9 LDA #00
0350 A0 LDY #00
0352 91 STA (00),Y
0354 C8 INY
0355 C4 CPY 04
0357 D0 BNE 0352
0359 20 JSR EA13
035C 4C JMP E1A1
(M)=035F 43 4C D2

```

MOVER

(K) *=0200
/96

```

0200 20 JSR EA13
0203 A0 LDY #00
0205 20 JSR 02B8
0208 20 JSR E7A3
020B 20 JSR F910
020E 20 JSR E7A7
0211 B0 BCS 0208
0213 20 JSR EA13
0216 AD LDA A41A
0219 85 STA A0
021B AD LDA A41B
021E 85 STA A1
0220 AD LDA A41C
0223 85 STA A2
0225 AD LDA A41D
0228 85 STA A3
022A A0 LDY #04
022C 20 JSR 02B8
022F 20 JSR E83E
0232 20 JSR E7A3
0235 AD LDA A41C
0238 85 STA A4
023A AD LDA A41D
023D 85 STA A5
023F 38 SEC
0240 A5 LDA A2
0242 E5 SEC A0
0244 85 STA A8
0246 A5 LDA A3
0248 E5 SEC A1
024A 85 STA A9
024C 18 CLC
024D A5 LDA A4
024F 65 ADC A8
0251 85 STA AA
0253 A5 LDA A5
0255 65 ADC A9
0257 85 STA AB
0259 38 SEC
025A A5 LDA A4
025C E5 SBC A0
025E 85 STA A6
0260 A5 LDA A5
0262 E5 SBC A1
0264 85 STA A7
0266 90 BCC 0297
0268 A0 LDY #FF
026A C6 DEC A3
026C C6 DEC AB
026E E6 INC A2

```

```

0270 E6 INC AA
0272 A6 LDX A9
0274 F0 BEQ 0286
0276 B1 LDA (A2),Y
0278 91 STA (AA),Y
027A 88 DEY
027B C0 CPY #FF
027D D0 BNE 0276
027F C6 DEC A3
0281 C6 DEC AB
0283 CA DEX
0284 D0 BNE 0276
0286 E6 INC A8
0288 E1 LDA (A2),Y
028A 91 STA (AA),Y
028C 88 DEY
028D C6 DEC A8
028F D0 BNE 0288
0291 20 JSR EA13
0294 4C JMP E1A1
0297 A0 LDY #00
0299 A6 LDX A9
029B F0 BEQ 02AE
029D B1 LDA (A0),Y
029F 91 STA (A4),Y
02A1 C8 INY
02A2 D0 BNE 029D
02A4 E6 INC A1
02A6 E6 INC A5
02A8 CA DEX
02A9 D0 BNE 029D
02AB E6 INC A8
02AD E1 LDA (A0),Y
02AF 91 STA (A4),Y
02B1 C8 INY
02B2 C4 CPY A8
02B4 D0 BNE 02AD
02B6 F0 BEQ 0291
02B8 B9 LDA 02C6,Y
02BB 48 PHA
02BC 29 AND #7F
02BE 20 JSR E97A
02C1 C8 INY
02C2 68 PLA
02C3 10 BPL 02B8
02C5 60 RTS

```

(E)=02C6 4F 4C 44 A0
() 02CA 4E 45 07

ZERO PAGE LOCATIONS USED:

CLEAR

```

0000 Start ADDR Low
0001 Start ADDR High
0002 Ending ADDR Low
0003 Ending ADDR High
0004 Length Low

```

MOVER

```

00A0 OLD Start ADDR Low
00A1 OLD Start ADDR High
00A2 OLD Ending ADDR Low
00A3 OLD Ending ADDR High
00A4 NEW Start ADDR Low
00A5 NEW Start ADDR High
00A6 Move Distance Low
00A7 Move Distance High
00A8 PGM Length Low
00A9 PGM Length High
00AA NEW Ending ADDR Low
00AB NEW Ending ADDR High

```

A similar examination of MOVER will show that the segment from 0200 through 023E generates the prompting messages by way of a subroutine at 02B8 - 02C5, obtains the requested addresses and stores them. From 023F through 0266 is found the calculation procedures for the length of the data to be moved, determination of the new ending address, and decision as to whether movement is forward or backward. Movement upward in address by starting at the end and working back to the start is contained in 0268 through 0294, while movement downward in address is handled from 0297 through 02B7. The "OLD" and "NEW" messages are contained in 02C6 - 02CC.

These programs have been found very useful in assisting an already powerful system to be even more responsive to the desires of the programmer. Other programs which would be very helpful would be the ability to insert an instruction into the middle of a program with automatic movement of the remainder to make room, as is done in the text editor and some assemblers. Related would also be a deletion procedure with automatic closure. Not enough time has been available to accomplish these programs. Perhaps later...

Receipt of the 8K basic ROM's for the AIM-65 has finally occurred after a lengthy wait. Not enough opportunity has arisen to delve into that aspect of the AIM very deeply, as yet. A brief exposure has made a very favorable impression. The addition of the BASIC makes the AIM-65 into exactly what its name implies; a self-contained Advanced Interactive Microcomputer.

A Warning:

The **MACROTeA™**
is for Professional
Programmers — and Very
Serious Amateurs — Only

Now: a machine language programming powerhouse for the knowledgeable programmer who wants to extend the PET's capabilities to the maximum. The MacroTeA, the Relocating Macro Text Editor/Assembler from Skyles Electric Works.

The Skyles MacroTeA is a **super powerful text editor**. 26 powerful editing commands. String search and replace capability. Manuscript feature for letters and other text. Text loading and storage on tape or discs. Supports tape drives, discs, CRT, printers and keyboard.

The Skyles MacroTeA is a **relocating machine language assembler with true macro capabilities**. A single name identifies a whole body of lines. You write in big chunks, examine, modify and assemble the complete program. And, when loading, the MacroTeA goes where you want it to go. Macro and conditional assembly support. Automatic line numbering. Labels up to 10 characters long.

The Skyles MacroTeA is an **enhance Monitor**. 11 powerful commands to ease you past the rough spots of program debugging.

The Skyles MacroTeA is a **warm start button**. Over 1700 bytes of protected RAM memory for your object code.

There's no tape loading and no occupying of valuable RAM memory space: The Skyles MacroTeA puts 10K bytes of executable *machine language* code in ROM (from 9800 to BFFF — directly below the BASIC interpreter). 2K bytes of RAM (9000 to 97FF).

Like all Skyles Products for the PET, it's practically **plug in and go**. No tools are needed. And, faster than loading an equivalent size assembler/editor from tape, the MacroTeA is installed permanently.

The Skyles MacroTeA: 13 chips on a single PCB. Operates interfaced with the PET's parallel address and data bus or with the Skyles Memory Connector. (When ordering, indicate if the MacroTeA will interface with a Skyles Memory Expansion System. You can save \$20.) Specifications and engineering are up to the proven Skyles quality standards. Fully warranted for 90 days. And, as with all Skyles products, fully and intelligently documented.

VISA, Mastercharge orders call (800) 227-8398 (Except Calif.)
California orders please call (415) 494-1210.



Skyles Electric Works

10301 Stonydale Drive, Cupertino, CA 95014, (408) 735-7891

An Additional I/O Interface for the PET

Interfacing a VIA 6522 to your PET is simple.

Kevin Eler
P.O. Box 3032
Edson, Alberta T0E 0P0
Canada

The 6522 VIA chip has a lot of interesting features, however, many of them are on the "PB" side of the chip. The Commodore PET does not have the "PB" lines on its user port, only the "PA" lines. The following interface gives not only the wanted "PB" lines but also an extra set of "PA" lines & CB1, CB2, CA1, & CA2.

The Hardware

The circuit itself uses only a 6522 VIA and two 7411's. It is mostly direct interfacing, other than the address lines which had to be decoded. Once built, it connects directly to the Memory Expansion Port.

The interface (in figure 1) is designed to occupy the top 16 bytes of RAM. It should be noted here that adding another interface is as simple as changing the address decode. For example, by placing an inverter on "BA4" (see figure 2) the circuit would occupy the 16 bytes of RAM just under the top 16 bytes. (note-if you build both of the circuits from figures 1 & 2 you would have two VIA's and would be using the top 32 bytes of RAM). The original circuit is shown in figure 1.

The Software

After connecting it, operation is very simple. The addresses concerned and what they are follows. (for the circuit

shown in figure 1)
32752 - QRB
32753 - QRA
32754 - DDRB
32755 - DDRA
32756 - TIL-L TIC-L
32757 - TIC - H
32758 - TIL-L
32759 - TIL-H
32760 - T2L-L T2C-L
32761 - T2C-H
32762 - SR
32763 - ACR
32764 - PCR
32765 - IFR
32766 - IER
32767 - ORA (no handshake)

The operation is as with other VIA-- PEEK POKE etc., only with the previously listed addresses.

Note--for the addresses which operate the circuit in figure 2, simply subtract 16 from each address.

Output Example

To create a tone on CB2 for the circuit in figure 1;
POKE 32763, 16 (ACR)
POKE 32762, 15 (SR)
POKE 32760, 155 (Timer 2) for the circuit in figure 2.
POKE 32747, 16 (ACR)
POKE 32746, 15 (SR)
POKE 32744, 155 (Timer 2)
For further specs. on the "PB" port of the 6522, refer to the 6522 data sheet.

ASSEMBLE LIST

```
0100 :MOVE TBL 1 TO TBL2
0110 :BA $400
0400— A/ 0B 0120 LOOP LDY #00
0402— B9 0B 04 0130 LDA TBL1.Y
0405— 89 0B 05 0140 STA TBL2.Y
0408— C8 0150 INY
0409 D0 F7 0160 BNE LOOP
0170 :
040B 0180 TBL1 :DS 256
050B 0190 TBL2 :DS 256
0200 :
0210 : EN
```

LABEL FILE 1 = EXTERNAL

START = 0400 LOOP = 0402 TBL1 = 040B
TBL2 = 050B
110000,060B,060B

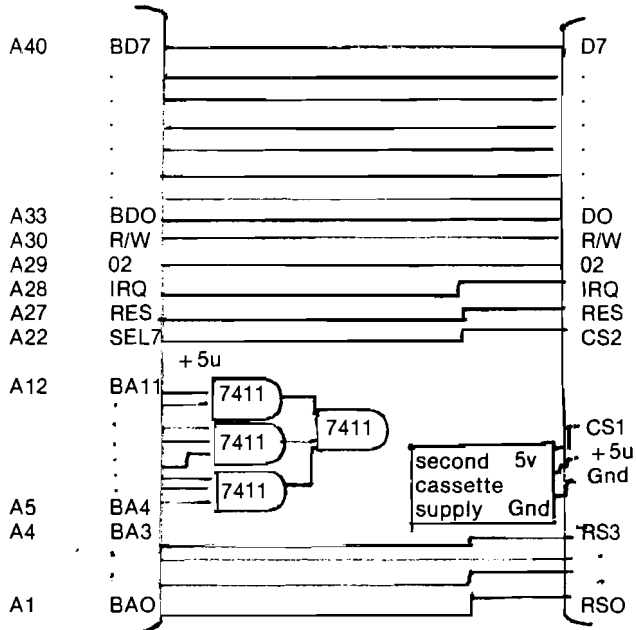

Figure 1: Interface designed to occupy top 16 bytes of RAM

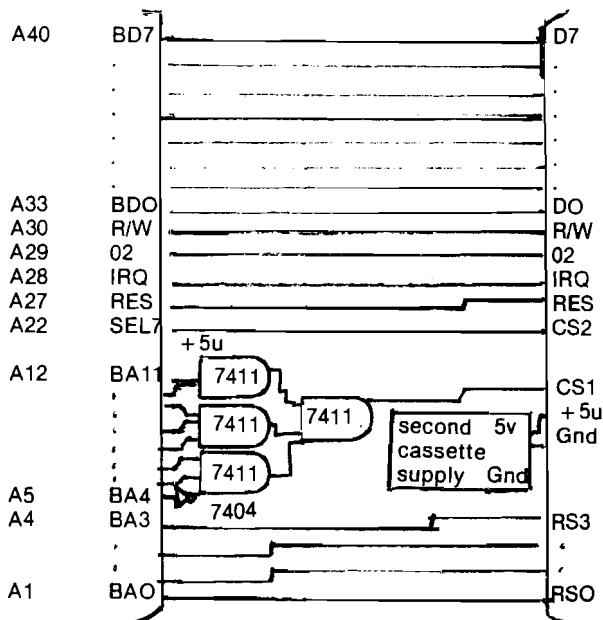

Fig. 2: Interface designed to occupy 16 bytes just under top 16 bytes of RAM.

To Order PROGRAMMER'S TOOLKIT or MacroTeA —

Custom designed to plug into your PET. So, when ordering, please indicate if your Toolkit:

... will be used with the Skyles Memory Expansion System, or	\$80.00*
... will be used with the ExpandaPet, or Expandmem	\$80.00*
... will be used with the PET 2001-8 alone	\$80.00*
<i>(We furnish connectors to the memory expansion bus and to the second cassette interface.)</i>	
... will be used with the PET 2001-16, -32 (chip only)	\$50.00*
... will be used with Skyles MacroTeA	\$50.00*

Your MacroTeA. Custom designed for your PET. So specify your PET model when ordering. \$395.00*

(Important Savings: If it's to be used with a Skyles Memory Expansion System, the MacroTeA can plug directly into the Skyles connector. **So you save \$20.** The Skyles MacroTeA is only \$375.00 when interfaced with the Skyles Memory Expansion System.)

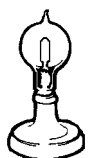

Send your check or money order to Skyles Electric Works. VISA, Mastercharge orders may call (800) 227-8398. (California residents: please phone (415) 494-1210.)

Ten Day Unconditional Money-Back Guarantee on all products sold by Skyles Electric Works, except chip only. California residents: please add 6-6 1/2% California sales tax.

Skyles Electric Works 10301 Stonydale Drive, Cupertino, CA 95014, (408) 735-7891

Is Programming Fun?

Have More Fun,
Make Fewer Errors,
Complete Programs Much
Faster...with the
**BASIC PROGRAMMER'S
TOOLKIT™**

Now you can modify, polish, simplify, add new features to your PET programs far more quickly while reducing the potential for error. That all adds up to more fun... and the **BASIC Programmer's Toolkit**.

The magic of the Toolkit: 2KB of ROM firmware on a single chip with a collection of machine language programs available to you from the time you turn on your PET to the time you shut it off. No tapes to load or to interfere with any running programs. And the **Programmer's Toolkit** installs in minutes, without tools.

Here are the 10 commands that can be yours instantly and automatically... *guaranteed* to make your BASIC programming a pleasure:

AUTO	RENUMBER	DELETE
HELP	TRACE	STEP
OFF	APPEND	DUMP
FIND		

Every one a powerful command to insure more effective programming. Like the **HELP** command that shows the line on which the error occurs... and the erroneous portion is indicated in reverse video:

```
HELP
500 J = SQR(A*B/C)
READY
```

... Or the **TRACE** command that lets you see the sequence in which your program is being executed in a window in the upper corner of your CRT:

```
TRACE
READY.
RUN #100
#110
#150
```

The **Programmer's Toolkit** is a product of Harry Saal and his associates at Palo Alto ICs.

So, if you really want to be into BASIC programming — and you want to have fun while you're doing it, order your **BASIC Programmer's Toolkit** now. We guarantee you'll be delighted with it.

NEW APPLE II® SOFTWARE

PROGRAMMA

Software Program Products

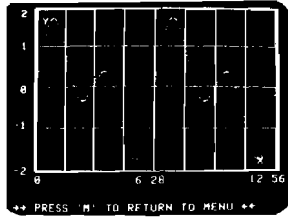

FUNCTION PLOT \$24.95



APPLE INVADERS GAME

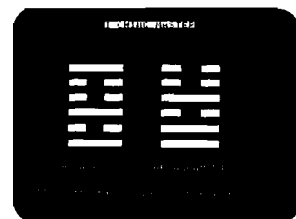

I-CHING \$15.95



TRIVIA BOX \$19.95

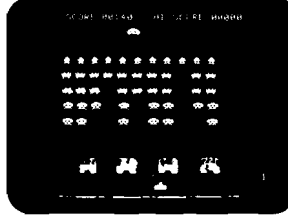

CASSETTE \$15.95



SHAPE BUILDER \$19.95

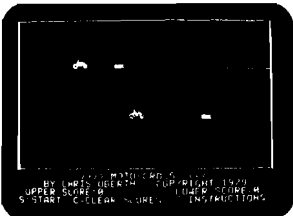

MOTO-CROSS \$9.95

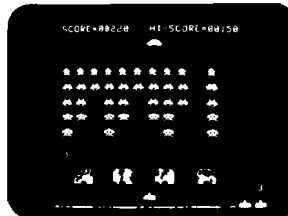

DISKETTE \$19.95

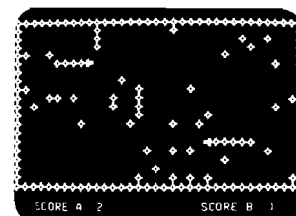

BLOCKADE \$9.95

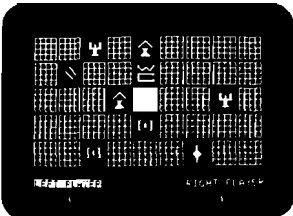

FRUSTRATION \$9.95

AND MORE...

ACTIVE FILTERS	\$24.95
ALIEN INVASION	9.95
AMPERSORT II	15.95
APPLE ALLEY	6.95
BASEBALL	15.95
BATTLEFIELD	9.95
BREAKTHRU	9.95
CHECK BOOK	34.95
DATABASE MAILER	29.95
DEATH RACE	15.95
EARTH QUEST	19.95
HOME BUDGET	24.95
HOUSEHOLD FINANCE	24.95
MINI GENERAL LEDGER	59.95
MOUSE HOLE	6.95
PEG JUMP	9.95
RICOCHETTE	9.95
STAR VOYAGER	15.95
STUNT CYCLE	15.95

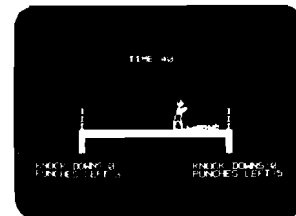

BOXING \$9.95

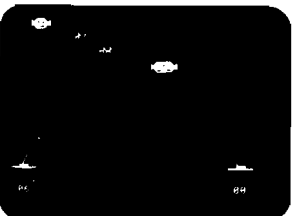

GUIDED MISSILE \$15.95

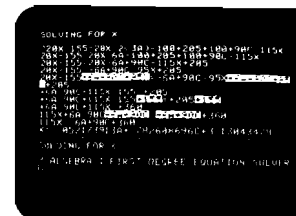

ALGEBRA I \$15.95

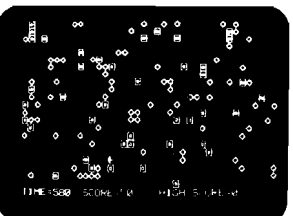

LASER BLAST \$9.95

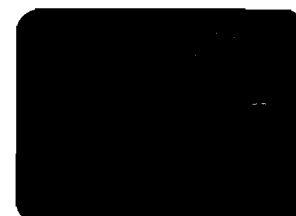

SPACE WAR \$9.95

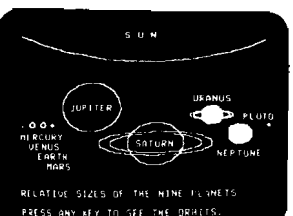

THE PLANETS \$15.95

PROGRAMMA
INTERNATIONAL, Inc.
3400 Wilshire Blvd.
Los Angeles, CA 90010
(213) 384-0579
384-1116
384-1117

Dealer Inquiries Invited



SIRIUS \$15.95

All orders must include 3% postage and handling. California residents add 6% sales tax. VISA and MASTERCARD accepted.

Apple II is a trademark of Apple Computers, Inc.

APPLE INVADER

THE GAME DROVE JAPAN CRAZY

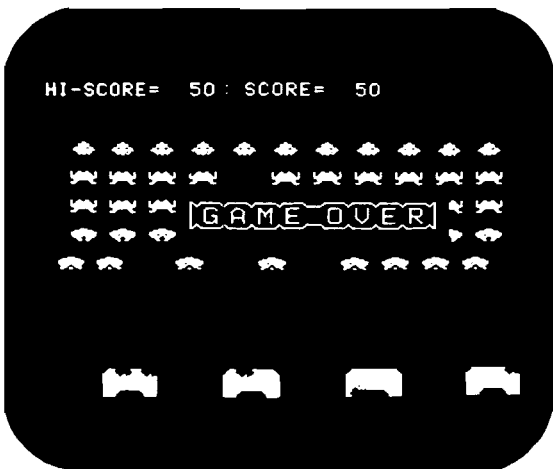
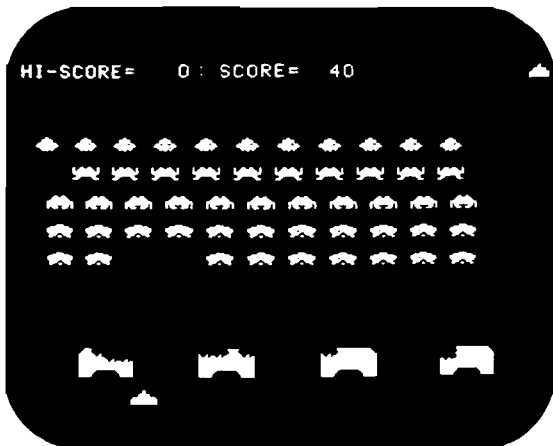
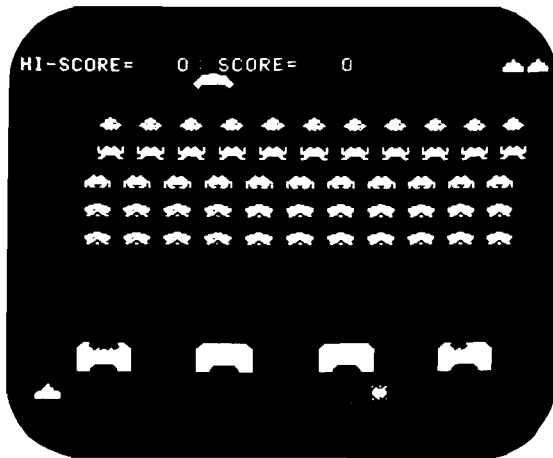

NEW!

From the leader
of Apple II[®]
Software

- UNIQUE HI-RES GRAPHICS
- REALISTIC SOUND EFFECTS
- REAL-TIME ACTION
- FUN & EXCITING
- CHALLENGING
- ADDICTING

Requires 32K APPLE II
with Integer Basic

Price: \$15.95 on cassette
\$19.95 on disk

Apple II is a Trademark of Apple Computer, Inc.

PROGRAMMA INTERNATIONAL, Inc.
3400 Wilshire Blvd. Los Angeles, CA 90010
(213) 384-0579 384-1116 384-1117

Announcement

PROGRAMMA

NEW SOFTWARE

softside SOFTWARE

305 Riverside Drive New York, N.Y. 10025

KAROW
PLINK
PLUNK

SOUNDWARE



the pet program.

1 GRAPHICS PAC 2 New Version

Quadruple your PET's graphic resolution. Why be stuck with the PET's cumbersome 25 x 40 1000 point display. With Graphics Pac you can directly control (set and clear) 4000 points on screen. It's great for *graphing, plotting, and gaming*. Graphics Pac allows you to plot in any combination of two modes: 4 Quadrant graphing with (0,0) center screen, and Standard graphing with (0,0) plotted in the upper left hand corner. Complete documentation shows how you can *merge* this useful routine with any of your own programs *without retyping* either one! All this on a high quality Microsette for only \$9.95.

2 ASSEMBLER 2001

A full featured assembler for your PET microcomputer that follows the *standard set of 6502 mnemonics*. Now you can take full advantage of the computing abilities of your PET. *Store and load* via tape, *run* through the SYS or USR functions. *List and edit* too with this powerful assembler. No other commercial PET assembler gives you all these features plus the ability to *look at the PET'S secret Basic ROMs all in one program*. This valuable program is offered at \$15.95.

3 BIKE

An exciting new simulation that puts you in charge of a bicycle manufacturing empire. Juggle inflation, breakdowns, seasonal sales variations, inventory, workers, prices, machines, and ad campaigns to keep your enterprise in the black. *Bike is dangerously addictive*. Once you start a game you will not want to stop. To allow you to take short rest breaks, Bike lets you store the data from your game on a tape so you can continue where you left off next time you wish to play. Worth a million in fun, we'll offer BIKE at \$9.95.

4 PINBALL

Dynamic usage of the PET's graphics features when combined with the fun of the *number 1 arcade game* equals an *action packed video spectacle* for your computer. Bumpers, chutes, flippers, free balls, gates, a jackpot, and a little luck guarantee a great game for all. \$9.95.

Authors: Our royalties are unbeatable

★☆☆☆☆☆ **MUSICAL MADDNESS** ☆☆☆☆☆☆ ★
SPECIAL add an exciting new dimension to your PET computer SOUND
with Soundware's soundsational music box
and sonicsound software from Softside & Soundware

★THE SOUNDWORKS★

The *Soundware music box* for your PET comes complete with controllable volume, an earphone jack, a *demo tape* with two programs, an instruction book, and a *one year warranty*. this sturdy unit is enclosed in an *attractive plastic case*. Notes tell how to *program your own sound effects*. All this during our *musical madness* for just 29.95

WORD FUN: *Speller*: fun ways to practice spelling + *Scramble* + *Flashcards* 9.95

★MUSICAL SOFTWARE★

ACTION PACK: *Breakthru* + *Target* + *Caterpillar*: non stop graphic action 9.95
PINBALL: a video action spectacle with real time flippers, chutes gates, bumpers, tags etc. 9.95
CLASSICS: *Checkers* + *Backgammon Board* + *Piano Player*: checkers vs. computer or friend. Piano plays Minute Waltz 9.95
MUSIC MANIA: Try to repeat a growing sequence of tones. With graphics. Challenge to the best ear 9.95

A 60 × 80 Life for the PET

Werner Kolbe
Hardstr. 77
CH 5432 Neuenhof
Switzerland

Have you ever wished that your PET display was bigger, especially when playing the Game of LIFE? Here is a method of providing a moveable window that permits you to examine any portion of an area that is:
'Larger than Life'.

When you have played some time with the 25 x 40 LIFE by Dr. Covitz, you will find that the area is too small for many patterns to expand. Therefore I decided to write a program which gives them more space. As I still wanted to use the nice round CHR\$(81) dots as cell symbols, I decided to show only a section of the whole area on the screen. The screen is practically used as a movable window which can be shifted in 8 directions by the number keys 1 to 9. The '5' is used to bring it back into the center.

Program Description

The BASIC part of the program does the following: Line 0 sets the memory pointers to prevent BASIC from destroying the machine code and to restore the "end of BASIC" pointer in dec 124, 125. Then in sub. 100, a short explanation, is given. The cells are set on the screen in the input mode with A\$. where A\$ is not used. Line 4 to 10 do the shifting of the

screen versus the Life area. The pointer PA which determines the displayed section is changed by the pokes into 2940, 2941. Line 3 again raises the memory pointer and lifts the "end of BASIC" pointer over the end of the machine code. Thus it is possible to save the whole program including machine code by a simple SAVE.

The machine program starts at the location hex 0A80. The memory used as Life-area starts at 0C51 and ends at 1F11. All necessary pointers are located in the BASIC input buffer from 0029 to 003F. They are initialized with the subroutine INIT from TBL2 starting at 0B6A. The pointer P9 points (indexed by Y) to the place which is currently investigated. The pointers P1 to P8 point to the neighboring places. PA points to the upper left corner of the displayed section and PS to the start of the screen. CNT is a page counter.

Cells are represented by bit 7 of the memory. The cells for the next generation are stored in bit 6. Subroutine CLEAR sets everything to zero. Then in NE the screen is inspected and if a 51 is found, bit 7 is set in the associated memory place. Subroutine INPDEX increases the pointers PS by dec 40 and PA by dec 80 if one row has gone through (Y running). By storing hex 34 respectively hex 3C into E811 the screen is switched off resp. on again to avoid "snow". After START the new generation is computed. The number of neighbors is counted by inspection of the neighboring places and decreasing X if bit 7 is set. If the life condition is found for the next generation, bit 6 is set in the memory place. When one page is worked through, all high values of the pointers P1 to P9 are incremented. The pages are counted by CNT. With RESTORE, the old generation is pushed out by a left shift, and the new one

OAFE	A9	OC		LDA=P9H	OB4C	A0	17	INIT	LDY=17
OBOO	8D	05	OB	STA P9H'	OB4E	BE	69	OB	LDX TBL2-1,Y
OBO3	1E	51	OC	ASL P9',X	OB51	96	28		STX TBL-1,Y
OBO6	CA		LB4	DEX	OB53	88			DEY
OBO7	DO	FA		BNE LB4	OB54	DO	F8		BNE LB7
OBO9	EE	05	OB	INC P9H'	OB56	60			RTS
OBOC	C6	3F		DEC CNT					
OBOE	10	F3		BPL LB4					
OB10	A9	34	TSCR	LDA=34	OB57	20	4C	OB	CLEAR
OB12	8D	11	E8	STA E811	OB5A	E6	3F		JSR INIT
OB15	A2	18		LDX=18	OB5C	A9	00		INC CNT
OB17	A0	27	LB5	LDY=27	OB5E	91	29	LB8	LDA=00
OB19	B1	3B	LB6	LDA (PA),Y	OB60	88			STA (Pl),Y
OB1B	10	04		BPL 04	OB61	DO	FB		DEY
OB1D	A9	51		LDA=51	OB63	E6	2A		BNE LB8
OB1F	DO	02		BNE 02	OB65	C6	3F		INC PLH
OB21	A9	20		LDA=20	OB67	10	F5		DEC CNT
OB23	91	3D		STA (PS),Y	OB69	60			BPL LB8
OB25	88			DEY					RTS
OB26	10	F1		BPL LB6	TBL2			TBL	
OB28	20	34	OB	JSR INPDEX	OB6A	00		TBL2	0029 00 P1L
OB2B	10	EA		BPL LB5	OB6B	0C			002A 0C P1H
OB2D	A9	3C		LDA=3C	OB6C	01			002B 01 P2L
OB2F	8D	11	E8	STA E811	OB6D	0C			002C 0C P2H
OB32	58			CLI	OB6E	02			002D 02 P3L
OB33	60			RTS BACK TO BASIC	OB6F	0C			002E 0C P3H
					OB70	50			002F 50 P4L
OB34	18		INPDEX	CLC	OB71	0C			0030 0C P4H
OB35	A9	50		LDA=50	OB72	52			0031 52 P5L
OB37	65	3B		ADC PAL	OB73	0C			0032 0C P5H
OB39	85	3B		STA PAL	OB74	A0			0033 A0 P6L
OB3B	90	03		BCC 03	OB75	0C			0034 0C P6H
OB3D	E6	3C		INC PAH	OB76	A1			0035 A1 P7L
OB3F	18			CLC	OB77	0C			0036 0C P7H
OB40	A9	28		LDA=28	OB78	A2			0037 A2 P8L
OB42	65	3D		ADC PSL	OB79	0C			0038 0C P8H
OB44	85	3D		STA PSL	OB7A	51			0039 51 P9L
OB46	90	02		BCC 02	OB7B	0C			003A 0C P9H
OB48	E6	3E		INC PSH	OB7C	B5			003B B5 PAL
OB4A	CA			DEX	OB7D	11			003C 11 PAH
OB4B	60			RTS	OB7E	00			003D 00 PSL
					OB7F	80			003E 80 PSH
					OB80	12			003F 12 CNT

KIM/SYM/AIM-65—32K EXPANDABLE RAM

DYNAMIC RAM WITH ON BOARD TRANSPARANT REFRESH THAT IS COMPATIBLE WITH KIM/ SYM/AIM-65 AND OTHER 6502 BASED MICROCOMPUTERS.

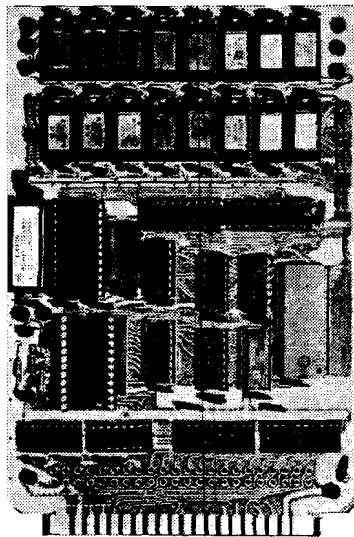

ASSEMBLED/ TESTED	}	WITH 32K RAM	\$419.00
		WITH 16K RAM	\$349.00
		WITHOUT RAM CHIPS	\$279.00
		HARD TO GET PARTS ONLY (NO RAM CHIPS)	\$109.00
BARE BOARD AND MANUAL		\$49.00	

- * PLUG COMPATIBLE WITH KIM/SYM/AIM-65. MAY BE CONNECTED TO PET USING ADAPTOR CABLE. SS44-E BUS EDGE CONNECTOR.
- * USES -5V ONLY (SUPPLIED FROM HOST COMPUTER BUS). 4 WATTS MAXIMUM.
- * BOARD ADDRESSABLE IN 4K BYTE BLOCKS WHICH CAN BE INDEPENDENTLY PLACED ON 4K BYTE BOUNDARIES ANYWHERE IN A 64K BYTE ADDRESS SPACE.
- * ASSEMBLED AND TESTED BOARDS ARE GUARANTEED FOR ONE YEAR, AND PURCHASE PRICE IS FULLY REFUNDABLE IF BOARD IS RETURNED UNDAMAGED WITHIN 14 DAYS.
- * BUS BUFFERED WITH 1 LS TTL LOAD.
- * 200NSEC 4116 RAMS.
- * FULL DOCUMENTATION

PET INTERFACE KIT \$49.00

CONNECTS THE ABOVE 32K EXPANDABLE RAM TO A 4K OR 8K PET. CONTAINS EXPANSION INTERFACE CABLE, BOARD STANDOFFS, POWER SUPPLY MODIFICATION KIT AND COMPLETE INSTRUCTIONS.

8502, 84K BYTE RAM AND CONTROLLER SET
MAKE 64K BYTE MEMORY FOR YOUR 6800 OR 6502. THIS CHIP SET INCLUDES:

- * 32 MSK 4116-3 16KX1, 200 NSEC RAMS.
- * 1 MC3480 MEMORY CONTROLLER.
- * 1 MC3242A MEMORY ADDRESS MULTIPLEXER AND COUNTER.
- * DATA AND APPLICATION SHEETS. PARTS TESTED AND GUARANTEED.

\$325.00 PER SET

16K X 1 DYNAMIC RAM
THE MK4116-3 IS A 16,384 BIT HIGH SPEED NMOS DYNAMIC RAM. THEY ARE EQUIVALENT TO THE MOSTEK, TEXAS INSTRUMENTS, OR MOTOROLA 4116-3.

- * 200 NSEC ACCESS TIME. 375 NSEC CYCLE TIME.
- * 16 PIN TTL COMPATIBLE.
- * BURNED IN AND FULLY TESTED.
- * PARTS REPLACEMENT GUARANTEED FOR ONE YEAR.

\$8.50 EACH IN QUANTITIES OF 8

BETA COMPUTER DEVICES
P.O. BOX 3465
ORANGE, CALIFORNIA 92665
(714) 633-7280

ALL ORDERS MUST BE PAID FOR IN ADVANCE. WE DO NOT SHIP UNPAID FOR ORDERS. PLEASE ALLOW 4-6 WEEKS FOR DELIVERY. PHONE ORDERS WELCOME.

ALL ASSEMBLED BOARDS AND MEMORY CHIPS CARRY A FULL ONE YEAR REPLACEMENT WARRANTY.

EASYWRITER,* the 1st true Word Processor for the Apple!*

Are you looking for the best Word Processor for your Apple? Well we are so sure you'll choose **EasyWriter** that we've prepared this ad to help you make your decision **EASY**. Check out these powerful features:

- Incremental spacing to support your Qume, Diablo, or Spinwriter
- Character oriented (No line numbers to deal with)
- Menu selectable routines for all known printers and interfaces
- Word wrap around on screen for continual text entry
- Our own new high speed DOS (Twice as fast as Apple's)
- Of course full editing, disk, and printer commands
- Subscripting, Superscripting, and MORE MORE MORE . . .

The straight facts make EasyWriter the only logical choice. By the same people who brought you WHATSIT. Available at your local computer store or our new California office!

793 Vincente **146 N. Broad Street**
Berkeley, CA 94707 **Griffith, IN 46319**
(415) 525-4046 **(219) 924-3522**

It Isn't Software Until it Works!
A perfect Christmas gift!

***EasyWriter**

EasyWriter is a TM of Cap'n Software

***Dr. Memory**

Dr. Memory is a TM of Muse

***Big Edit**

Big Edit is a TM of Gravey, Martin & Sampson, Inc.

***Apple Pie**

Apple Pie is a TM of Programma International, Inc.

***Super-Text**

Super-Text is a TM of Muse

Apple

Apple is a TM of Apple Computers, Inc.

Whatsit

Whatsit is a TM of Computer Headware

	<i>EasyWriter*</i>	<i>Dr. Memory*</i>	<i>Big Edit*</i>	<i>Apple Pie*</i>	<i>Super-Text*</i>			
Incremental Spacing	X							
Character Oriented Screen	X				X			
Printer Interface Routines	X							
Word Wrap Around	X				X			
Editing Commands	X	X	X	X	X			
High Speed Disk	X							
50 Pages of Text per Disk	X							
Subscripting & Superscripting	X				X			
Your Choice								

ORDER FORM

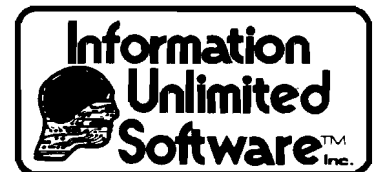

CUT ALONG DOTTED LINE

Name: _____

Company: _____

Address: _____

City: _____ **State:** _____ **Zip:** _____

I would like more information on:

ITEM	QUANTITY	PRICE	TOTAL
Easy Writer (EZ 2)		\$ 99.95	
Whatsit Model A-1 (Apple)		125.00	
Whatsit Model CP-2 (CP/M)		150.00	
Whatsit Model NS-3 (N Star)		100.00	
Whatsit Manual		25.00	
EasyWriter Manual		30.00	
Subtotal			\$
CA Residents add 6% sales tax			\$
Shipping & Handling			\$ 2.50
GRAND TOTAL			\$

Master Charge or Visa Number: _____

Applesoft Program Relocation

George S. Guild, Jr.
117 Cardinal Drive
Hampton, VA 23664

Here is a simple technique to change the program storage space when using Applesoft.

Integer BASIC has commands to set boundaries for both the program upper limit (HIMEM) and data lower limit (LOMEM). This gives Integer BASIC users total freedom to protect areas of memory for HIRES graphics and/or machine language subroutines. Applesoft however, uses *fixed* program storage, and uses HIMEM and LOMEM only to set the upper and lower boundaries of stored data. This lack of flexibility can result in problems when using Applesoft.

For example, RAM Applesoft users were forever limited to 4K of program space, when they wanted to use HIRES graphics, even if 48K of memory was available. Setting LOMEM to \$6000 (24576) preserves all 4K for programming with data saved above the HIRES page 2. Users of the Heuristics Speechlab have found that the firmware stores its data starting at \$800 (2048). This data would overwrite any BASIC program created by the ROM Applesoft, limiting its use to Integer BASIC.

The sequence of commands shown in the insert allows Applesoft users to overcome this limitation. First decide where you want your program to start, i.e. the lowest address of the program. For example, if you want to use the memory space above HIRES page 2, this address would be \$6000 (24576) for the start of program storage. Store \$00 to the first three bytes here and then set the program pointer (\$67, 68) to the starting address plus one.

Programs loaded will now start at \$6000 until you reset the pointer or reload/reinvoke Applesoft. CLEAR, NEW, LOAD, and RESET do not affect this pointer. Change the start address and program pointer for your requirements.

Do not set the program pointer lower than \$801 for ROM Applesoft or \$3001 for RAM Applesoft because doing so will either interfere with the text screen area (\$400 to \$800) or overwrite the RAM interpreter which is stored at \$800 to \$2FFF.

Users of DOS versions earlier than DOS 3.2 may have to execute a CALL 3314, for disk Applesoft, or a CALL 54514, for ROM Applesoft, in order to update programs loaded from disk. DOS 3.2 does the required CALL automatically. Cassette systems have no such problem.

JSAVE	If the program you wish to relocate is in memory you must save it first.
J"Reset"	Enter monitor.
*6000:00 00 00	Store zeroes at beginning of new program space. If omitted, strange syntax errors occur.
*67:01 60	Set program pointer to new start address plus one. Note that pointer is stored in low byte first, then high byte, as usual for 6502 microprocessor.
*3D0G	Disk system return to BASIC. (Cassette system/ROM Applesoft: Control-B; RAM Applesoft: 0G)
JNEW	Initialize Applesoft
JLOAD	Program will be loaded starting at address \$6000.

PROGRESSIVE SOFTWARE

Presents Software and Hardware for your APPLE

SALES FORECAST provides the best forecast using the four most popular forecasting techniques: linear regression, log trend, power curve trend, and exponential smoothing. Neil D. Lipson's program uses artificial intelligence to determine the best fit and displays all results for manual intervention. **\$9.95**

CURVE FIT accepts any number of data points, distributed in any fashion, and fits a curve to the set of points using log curve fit, exponential curve fit, least squares, or a power curve fit. It will compute the best fit or employ a specific type of fit, and display a graph of the result. By Dave Garson. **\$9.95**

PERPETUAL CALENDAR may be used with or without a printer. Apart from the usual calendar functions, it computes the number of days between any two dates and displays successive months in response to a single keystroke. Written by Ed Hanley. **\$9.95**

STARWARS is Bob Bishop's version of the original and best game of intergalactic combat. You fire on the invader after aligning his fighter in your crosshairs. This is a high resolution game, in full color, that uses the paddles. **\$9.95**

ROCKET PILOT is an exciting game that simulates blasting off in a rocket ship. The rocket actually accelerates you up and over a mountain, but if you are not careful, you will run out of sky. Bob Bishop's program changes the contour of the land every time you play the game. **\$9.95**

SPACE MAZE puts you in control of a rocket ship that you must steer out of a maze using paddles or a joystick. It is a real challenge, designed by Bob Bishop using high resolution graphics and full color. **\$9.95**

MISSILE ANTI-MISSILE displays a target on the screen and a three dimensional map of the United States. A hostile submarine appears and launches a pre-emptive nuclear attack controlled by paddle 1. As soon as the hostile missile is fired, the U.S. launches its anti-missile controlled by paddle 0. Dave Moteles' program offers high resolution and many levels of play. **\$9.95**

MORSE CODE helps you learn telegraphy by entering letters, words or sentences, in English, which are plotted on the screen using dots and dashes. Ed Hanley's program also generates sounds to match the screen display, at several transmission speed levels. **\$9.95**

POLAR COORDINATE PLOT is a high resolution graphics routine that displays five classic polar plots and also permits the operator to enter his own equation. Dave Moteles' program will plot the equation on a scaled grid and then flash a table of data points required to construct a similar plot on paper. **\$9.95**

UTILITY PACK 1 combines four versatile programs by Vince Corsetti, for any memory configuration.

POSTAGE AND HANDLING

Please add \$1.00 for the first item
and \$.50 for each additional item.

- Programs accepted for publication
- Highest royalty paid

U.S. and foreign dealer and distributor inquiries invited
All programs require 16K memory unless specified

- **Integer to Applesoft conversion:** Encounter only those syntax errors unique to Applesoft after using this program to convert any Integer BASIC source.
- **Disk Append:** Merge any two Integer BASIC sources into a single program on disk.
- **Integer BASIC copy:** Replicate an Integer BASIC program from one disk to another, as often as required, with a single keystroke.
- **Applesoft Update:** Modify Applesoft on the disk to eliminate the heading always produced when it is first run.
- **Binary Copy:** Automatically determines the length and starting address of a program while copying its binary file from one disk to another in response to a single keystroke. **\$9.95**

BLOCKADE lets two players compete by building walls to obstruct each other. An exciting game written in Integer BASIC by Vince Corsetti. **\$9.95**

TABLE GENERATOR forms shape tables with ease from directional vectors and adds additional information such as starting address, length and position of each shape. Murray Summers' Applesoft program will save the shape table anywhere in usable memory. **\$9.95**

OTHELLO may be played by one or two players and is similar to chess in strategy. Once a piece has been played, its color may be reversed many times, and there are also sudden reverses of luck. You can win with a single move. Vince Corsetti's program does all the work of keeping board details and flipping pieces. **\$9.95**

SINGLE DRIVE COPY is a special utility program, written by Vince Corsetti in Integer BASIC, that will copy a diskette using only one drive. It is supplied on tape and should be loaded onto a diskette. It automatically adjusts for APPLE memory size and should be used with DOS 3.2. **\$19.95**

SAUCER INVASION lets you defend the empire by shooting down a flying saucer. You control your position with the paddle while firing your missile at the invader. Written by Bob Bishop. **\$9.95**

HARDWARE

LIGHT PEN with seven supporting routines. The light meter takes intensity readings every fraction of a second from 0 to 588. The light graph generates a display of light intensity on the screen. The light pen connects points that have been drawn on the screen, in low or high resolution, and displays their coordinates. A special utility displays any number of points on the screen, for use in menu selection or games, and selects a point when the light pen touches it. The package includes a light pen calculator and light pen TIC TAC TOE. Neil D. Lipson's programs use artificial intelligence and are not confused by outside light. The hi-res light pen, only, requires 48K and ROM card. **\$34.95**

TO ORDER

Send check or money order to:

P.O. Box 273
Plymouth Meeting, PA 19462

PA residents add 6% sales tax.

KIM and SYM Format Cassette Tapes on APPLE II

Steven M. Welch
309 S. Sunset
Longmont, CO 80501

Now you can swap programs and data between your APPLE and any AIM, SYM or KIM via cassette I/O.

Many KIM and SYM owners have graduated to bigger and better 6502 systems as their needs and financial situations changed. If you are one of these people, and find that your KIM is sitting in the corner gathering dust because your APPLE is so much easier to work with, read on. With this program, you can use your APPLE as a "host computer" for assembly language program development and then "down load" the finished program into your single board computer (SBC). Just like the big boys! Not only will you make better use of your several hundred dollar investment, but you will also have the bonus of a new set of computer jargon to bore your friends. The value of developing assembly language programs in this fashion cannot be fully appreciated until you use the APPLE to develop a sizeable program for the SYM or KIM. The many miseries of hand assembling magically disappear. The constant verbal self-abuse which generally accompanies calculator keyboard entry and debugging quickly becomes a fading memory. Have you ever forgotten to initialize a loop counter only to realize it 300 bytes of hand assembly later?

The program listed here was produced to fill a need; a need to develop a large program on a SYM. I estimate that we have saved an absolute minimum of 2 man-months in the development of a 1500 byte program by using the APPLE for entry, debugging and assembling. Also, having a real assembler easily available to us, we have written better code and have not needed the numerous patches and kludges which inevitably crop up when one writes large programs in machine code. At the University of Colorado at Boulder, where I am employed, we are developing a microprocessor-controlled Charge Coupled Photo Diode [CCPD] spectrographic detector for the Sommers-Bausch Observatory using a SYM-1 computer. Although this is a very nice SBC, it lacks certain features which are highly desirable in a computer that will be us-

ed for program development, e.g., fast mass storage, an assembler, text editor, ASCII keyboard, and display device. It seemed to us that the controlling program was going to take a great deal of time to devise without these several conveniences.

The "big boys" get around the lack of these features by purchasing [usually for \$10-20,000], a Microprocessor Development System. While our observatory didn't have the ten or twenty thousand dollars to throw away, we did have access to an APPLE II computer belong-

```

;SYM AND KIM FORMAT CASSETTE TAPE OUTPUT FOR APPLE II
;
;
; LARGELY COPIED FROM THE SYNERTEK MANUAL, AND REPRODUCED
; HERE WITH THE PERMISSION OF SYNERTEK SYSTEMS CORP.
; (STARTING AT PAGE 8 OF THE AUDIO CASSTTE INTERFACE PROGRAM)
;
;BY STEVE WELCH, 13 JUNE 79, 309 S SUNSET, LONGMONT, CO 80501,USA
; MOST SW COMMENTS ARE INDICATED BY ---
;
    .DEF    TAPOUT=3C020
;--- USE APPLE GAME PADDLE ANNUNCIATOR #0 FOR TAPE RECORDER
;--- ON-OFF CONTROL. RECORDER ON IS LOW
    .DEF    TAPEON=3C059    ;---PUT 0 HERE TO TURN ON
    .DEF    TAPEOF=3C056   ;---PUT 1 HERE TO TURN OFF
    .DEF    TM1500=$47     ;---PROB SHOULD BE TWEAKED
    .DEF    TIME99=$1A     ;---FOR DELAY ROUTINE
    .DEF    EOT=$04
    .DEF    SYN=$16
    .DEF    BUFADL=$E7     ;---ARBITRARY PLACE ON ZERO PAGE
    .DEF    BUFADH=$E8
    .DEF    CHAR=$EA
;
;---PROGRAM STARTS HERE, LINE 390 OF SYM CODE, LOC 8E87
;
    .DEF    BEGIN=$1000    ;---MUST START IN MIDDLE OF PAGE
;
    .LOC    BEGIN ;---OUT OF THE WAY OF MOST SYM PROGS
;--- INITILIZE
1080 20 B011 SYMOUT: JSR    START    ;---ENTRY- PARAMETERS SET BEFORE CALL
1083 A0 00          LDY#    $00     ;---IN CASE WE TAKE KIM BRANCH
1085 2C E011       BIT     MODE    ;---TEST BIT 7 OF MODE (1=SYM,0=KIM)
1088 10 0D         BPL     DUMPT1   ;KIM-D0 128 SYNS
;--- WRITE 8 SECOND MARK (THIS COULD BE SHORTER)
108A A2 08        LDX#    $8       ;8 TIMES ...
108C A0 15        MARK8A: LDY#    $15 ;... ONE SEC (21 DELAYS PER SEC)
108E 20 9511      MARK8B: JSR    DELAY ;---BENIGN PAUSE, SYM USES KIM CHAR
1091 88           DEY
1092 D0 FA        BNE     MARK8B
1094 CA           DEX
1095 D0 F5        BNE     MARK8A
;--- WRITE 256 SYNS, FOR SYNC
1097 A9 16        DUMPT1: LDA#    SYN
1099 20 0711      JSR    OUTCTX
109C 88           DEY
109D D0 F8        BNE     DUMPT1
;--- WRITE START CHARACTER
109F A9 2A        LDA#    '*'
10A1 20 0711      JSR    OUTCTX
;--- WRITE ID
10A4 AD DF11      LDA    ID
10A7 20 3B11      JSR    OUTBTX

```

ing to my boss, Dr. Bruce Bohannon. The APPLE has almost all of the features of the typical Microprocessor Development System, except perhaps, a means of communicating with the SBC in question. How can an APPLE talk to a SYM? Fortunately, both computers use the 6502 micro-processor chip, so programs assembled for the APPLE have little or no trouble running on the SYM or KIM. Also fortunately, all of these machines have a means of reading and writing programs on audio cassettes. It goes without saying, of course, that the tape formats of these machines are totally incompatible. So we had to do some translating; either convince the SYM to speak APPLE, or convince the APPLE to speak SYM. Since it's easier to develop programs on the APPLE [that's why I did all this in the first place], I decided to teach my APPLE to speak SYM.

It turns out that there is another good reason to teach the APPLE SYMese. The SYNERTEK people, who make the SYM, have been so kind as to publish listings of the SYM monitor in the back of their manual. This monitor listing has routines in it which produce SYM or KIM cassette tapes. The result is that the program is very easily modified to run on the APPLE. No timers are used (the APPLE has none), and the serial data is sent out through a single bit of a 6522 output port. Although the APPLE doesn't have any 6522s, it does have several single bit outputs, and in particular, it has a single bit output with the level adjusted to be used as a cassette recorder interface. Even though this is not a 6522 output, under certain conditions it can be *thought* of as one. The way that the APPLE works, any time the address of the cassette output port appears on the address bus, the cassette output flip-flop changes state. On the other hand, in the SYM, we send a particular bit pattern to an address and these bits appear on the output latch. Basically, what this means, is that we can *pretend* that the APPLE cassette is the SYM cassette output if we write only to this output when we want to *change* the level of the cassette port. With the APPLE, it should be noted, there is no control over the phase of the output signal, but all of the cassette-read routines in question are not sensitive to phase. Fortunately, through good luck or the good planning of the programmers at SYNERTEK, 90% of the cassette output code was written in just this way. This feature makes the program a snap to adapt to the APPLE. Once I had picked out the proper pieces of the SYNERTEK code and figured out what they had done, I had only to change a few lines to obtain the results listed here. Since I did not write the program, I won't explain how it works, but I have heavily commented the listing for those readers who are interested.

Using the Program

It is a good idea to make a SYNC tape first. The APPLE output level is about 1/2 of the SYM's output level which may require changing the volume on playback from the usual value. Also, the APPLE does not have a high-frequency roll-off capacitor which the SYM uses, and as a result, the tone controls may need adjustment. The SYNC tape enables you to set the controls properly on your tape recorder (as outlined in the SYM manual, Appendix F). To make a SYNC tape, load the SYMOUT program into your APPLE, set the mode by setting the parameter, MODE (location \$11E0), to \$80 for SYM format or to \$00 for KIM format and begin the program at SYNC: (\$1000). This is an endless loop, so record a few minutes of the output before you hit RESET and use the resultant tape to set the level and tone on the tape recorder when reading it into the SYM (see Appendix F in SYM manual). Once you have the proper level and tone settings, down-loading your program is fairly easy. First, load the SYMOUT program. Then, load your executable program into RAM. Next, put in the parameters: Starting Address (\$11DB-C),

Ending Address (\$11DD-E), Tape I.D. Number (\$11DF), and the MODE (11E0) and start the program at SYMOUT: (\$1080). Record the program, play it into your SYM, and there you have it!

Direct Computer to Computer Communication

A discovery by Dr. Bohannon: If your tape recorder has a monitor hookup, through which you can listen to whatever is being recorded, you can hook up the APPLE directly to the SYM and reduce the error rate astronomically! On our SYM (whose tape interface is modified as per MICRO's instructions), we have about a 70% chance of a successful load of our 1500 byte program with our tape recorder, a Sony. The level and tone control settings are extremely critical as well. When the machines are hooked up directly through the monitor jack of our tape recorder, we have success *every* time and the level and tone settings are unimportant. I've also found that several of my tape recorders work very well this way and have the monitor feature through the earphone jack even though it is not marked.

```

J--- WRITE STARTING ADDRESS
10AA AD D811 LDA SAL
10AD 20 3811 JSR OUTBCX
10B0 AD DC11 LDA SAH
10B3 20 3811 JSR OUTBCX
10B6 2C E011 BIT MODE ;KIM OR HS?
10B9 10 0C BPL DUMPT2
J--- WRITE ENDING ADDRESS +1
10BB AD DD11 LDA EAL
10BE 20 3811 JSR OUTBCX
10C1 AD DE11 LDA EAH
10C4 20 3811 JSR OUTBCX
J--- START OF MEMORY DUMP...
J--- FIRST CHECK IF THIS IS THE LAST BYTE OUT
10C7 A5 E7 DUMPT2: LDA BUFADL ;---LOAD ADDRESS OF CURRENT BYTE
10C9 CD DD11 CMP EAL
10CC D0 29 BNE DUMPT4 ;---COMPARE TO ENDING ADDRESS
10CE A5 E8 LDA BUFADH
10D0 CD DE11 CMP EAH
10D3 D0 22 BNE DUMPT4 ;---BRANCH IF WE HAVE MORE TO OUTPUT
J--- YUP, LAST BYTE... WRITE "/"
10D5 A9 2F LDA# '/'
10D7 20 0711 JSR OUTCTX
J--- WRITE CHECKSUM
10DA AD E111 LDA CHKL
10DD 20 3B11 JSR OUTBTX
10E0 AD E211 LDA CHKH
10E3 20 3B11 JSR OUTBTX
J---WRITE TWO EOT'S
10E6 A9 04 LDA# EOT
10E8 20 3B11 JSR OUTBTX
10EB A9 04 LDA# EOT
10ED 20 3B11 JSR OUTBTX
J---OK, NOW WE'RE DONE, SO CLEAN UP & EXIT
10F0 18 CLC ;---INDICATE SUCESS
J--- SKIPPED LOTS OF STUFF, MOSTLY SYM SPECIFIC
10F1 A2 01 LDX# $01 ;---SHUT OFF TAPE RECORDER
10F3 0E 58C0 STX TAPEOF
10F6 60 RTS ;---AND WE'RE ALL DONE
J--- NEXT IS THE CODE WHICH OUTPUTS THE NEXT MEM LOCATION
10F7 A8 00 DUMPT4: LDY# $0 ;---FIND THE NEXT BYTE
10F9 B1 E7 LDA#Y BUFADL
10FB 20 3811 JSR OUTBCX ;WRITE IT & UPDATE CHECKSUM
10FE E6 E7 INC BUFADL ;BUMP BUFFER ADDR
1100 D0 C5 BNE DUMPT2
1102 E6 E8 INC BUFADH ;CARRY
1104 4C C710 JMP DUMPT2 ;---GO BACK & SEE IF WE'RE DONE

```

```

j--- START OF VARIOUS CHARACTER OUT ROUTINES
j
j
1107 2C E011 OUTCTX: BIT MODE JHS OR KIM?
110A 10 47 BPL OUTCHT ;KIM TAKES BRANCH
j
j
j OUTBTH -NO CLOCK
j A-X DESTROYED
j MUST RESIDE ON ONE PAGE - TIMING CRITICAL
j
110C A2 09 OUTBTH: LDX# $9 ;8 BITS*START BIT
110E 8C E411 STY TEMP2
1111 85 EA STA CHAR
j---CANT READ LEVEL ON APPLE, SO NEXT INSTRUCTION IS DUMMY
1113 AD E311 LDA TEMPI j--- FOR TIMING
1116 46 EA GETBIT: LSR CHAR
1118 49 E5 STA TAPOUT ;INVERT LEVEL
111A 8D 20C0 STA TAPOUT ;HERE STARTS FIRST 416 USEC PERIOD
111D A0 47 LDY# TH1500
111F 88 A416 DEY
1120 D0 FD BNE A416
1122 90 11 BCC NOFLIP
1124 49 E5 EOR# TPBIT ;NOFLIP IF BIT 0
1126 8D 20C0 STA TAPOUT ;BIT IS 1 - INVERT OUTPUT
j
j END OF FIRST 416 USEC PERIOD
1129 A0 46 B416; LDY# TH1500-1
112B 88 B416B; DEY
112C D0 FD BNE B416B
112E CA DEX
112F D0 E5 BNE GETBIT
1131 AC E411 LDY TEMP2
1134 60 RTS
1135 EA NOFLIP: NOP
1136 90 F1 BCC B416
j
1138 20 AC11 OUTBXC: JSR CHKT j--- GO UPDATE CHECKSUM
113B 2C E011 OUTBTX: BIT MODE
113E 30 CC BMI OUTBTH ;HS
j OUTBTC - OUTPUT ONE KIM BYTE
j
1140 A0 OUTBTC: TAY
1141 AA LSR#
1142 4A LSR#
1143 4A LSR#
1144 4A LSR#
1145 20 4811 JSR HEXOUT j---SHIFT HI NIBBLE INTO PLACE
1148 29 0F HEXOUT: AND# $0F j AND OUTPUT HI NIBBLE FIRST
114A C9 0A HEXOUT: CMP# $0A j CONVERT LO NIBBLE TO ASCII
114C 18 CLC
114D 30 02 BMI HEX1
114F 69 07 ADC# $07
1151 69 30 HEX1: ADC# $30
j
j OUTCHT: OUTPUTS AN ASCII CHAR IN KIM FORMAT
j (MUST RESIDE ON ONE PAGE, FOR TIMING)
j
1153 8E E311 OUTCHT: STX TEMP1 ;SAVE X & Y
1156 8C E411 STY TEMP2
1159 85 EA STA CHAR
115B A9 FF LDA# SFF
115D A8 PHA
115E AD E411 LDA TEMP2
1161 46 EA LSR CHAR ;USE FF V/SHIFTS TO COUNT BITS
1163 A2 12 LDY# $12 ;SAVE BIT COUNTER
1165 B0 02 BCS HF ;---DUMMY FOR TIMING
1167 A2 24 LDX# $24 ;GET DATA BIT IN CARRY
j ;ASSUME ONE
j ;BIT IS ZERO
j
j--- START OF VARIOUS CHARACTER OUT ROUTINES
j
j
1169 A0 19 HF: LDY# $19
116B 49 E5 EOR# TPBIT
116D 8D 20C0 STA TAPOUT
1170 86 DEY
1171 D0 FD BNE HFPI
1173 CA DEX
1174 D0 F3 BNE HF
1176 A2 10 LDX# $10
1178 B0 02 BCS LF20
117A A2 0C LDX# $0C
117C A0 27 LDY# $27
117E 49 E5 EOR# TPBIT
1180 8D 20C0 STA TAPOUT
1183 88 DEY
1184 D0 FD BNE LFPI
1186 CA DEX
1187 D0 F3 BNE LF20
1189 68 PLA
118A 0A ASLA
118B D0 D0 BNE KIMBIT
118D AE E311 LDY TEMP1
1190 AC E411 LDY TEMP2
1193 90 TYA
1194 60 RTS
j
j--- WE NEED A DELAY FUNCTION, BECAUSE THE SYM PROG USES THE KIM
j CHAROUT ROUTINE WITH OUTPUT DISABLED TO DELAY (& WE CAN'T)
j
j--- THIS ONE SHOULD BE 1/21 SEC , SINCE IT EMULATES
j--- THE KIM CHAR OUT ROUTINE, WHICH THE SYM PROGRAM USES
1195 8E E311 DELAY: STX TEMP1 j---PRESERVE X
1198 8C E411 STY TEMP2 j--- AND Y
119B A2 00 LDX# $00 j---DO OUTER LOOP 256 TIMES
119D A0 1A LOOP0: LDY# TIME99 j---LOOP
119F 88 LOOP1: DEY
11A0 D0 FD BNE LOOP1
11A2 CA DEX
11A3 D0 F8 BNE LOOP0
11A5 AE E311 LDY TEMP1
11A8 AC E411 LDY TEMP2
11AB 60 RTS
j
j--- CHKT... UPDATE CHECKSUM FROM BYTE IN ACC
j
11AC A0 CHKT: TAY
11AD 10 CLC
11AE 6D E111 ADC CHKL
11B1 8D E111 STA CHKL
11B4 90 03 BCC CHKT10
11B6 EE E211 INC CHKH
11B9 98 CHKT10: TYA
11BA 60 RTS
j
j--- START... LEAVING OUT SOME UNNECESSARY JUNK
11BB 20 C711 START: JSR ZERCK ;ZERO CHECKSUM
11BE 20 D011 JSR P2SCR j---THATS WHAT THEY NAMED IT
11C1 A9 00 LDA# $00 j---TURN ON TAPE RECORDER
11C3 8D 59C0 STA TAPEON
11C6 60 RTS
11C7 A9 00 ZERCK: LDA# $00
11C9 8D E111 STA CHKL
11CC 8D E211 STA CHKH
11CF 60 RTS
j
j--- P2SCR... THIS MOVES THE STARTING ADDRESS TO THE
j RUNNING BUFFER ADDRESS. THE WEIRD NAME
j IS DUE TO THE NAMES OF THE LOCATIONS
j WHICH WE ARE MOVING IN THE SYM BOOK
j

```



```

;
; AND STICKS IN BUFFER.
;
; --- CALLED BY MAIN LOOP
1032 2C 00C0 GETKEY: BIT KEYBD
1035 30 01          RTS
1037 60          ;BIT 7 SET IF KEY PRESSED
;TAKES BRANCH IF KEY PRESSED
1038 AD 00C0 GOON2: LDA KEYBD
;GET CHAR
103B 29 7F      AND# $7F
;CLEAR KEYBOARD STROBE
103D 2C 10C0   BIT KEYSTB
;NOV CHECK FOR SPECIAL CHARS
1040 20 9810   JSR CHKSPC
;NOV STICK THIS CHAR IN BUFFER
1043 A0 00    LDY# $00
;INCREMENT POINTER
1045 E6 F0    INC POINTL
;CHECK FOR CARRY
1047 D0 02    BNC SAVEIT
;INCREMENT HI BYTE
1049 E6 F1    INC POINTH
;STICK IT
104B 91 F0    SAVEIT: STA#0Y POINT
104D 60          RTS

;
; --- CHKBUF: CHECK BUFFER, AND IF THERE IS SOMETHING IN IT,
; SEND IT OUT TO THE OUTPUT PORT. (ECHO IF ON)
;
; --- CALLED BY MAIN LOOP
104E A5 F0    CHKBUF: LDA POINTL
;FIRST LETS SEE IF BUFFER EMPTY
1050 CD F410   CMP BUFTML
;CHECK- IF POINT .NE. BUFTM,
1053 D0 07    BNE NOTMT
;THEN GO OUTPUT THE NEXT CHAR
1055 A5 F1    LDA POINTH
;CHECK HI BYTE
1057 CD F510   CMP BUFTMH
;TAKE BRANCH IF BUFFER IS EMPTY
105A F0 20    BEQ BUFDUN
;NOW WAIT TILL BOARD IS READY
105C A0 00    NOTMT: LDY# $00
;TBR BIT)
105E AD C1C0 WAIT: LDA STATUS
AND# $01
1061 29 01    BEQ WAIT
1063 F0 F9    STA OUTPUT
;FALLS THRU WHEN BOARD READY-GET CHAP
1067 8D C2C0   BIT ECHO
;SEND TO OUTPUT PORT
106A 2C F210   BPL NOECHO
106D 10 03    JSR CHROUT
;YES, SEND CHAR TO TV
106F 20 7D10   NOECHO: DEC POINTL
;NOW DECREMENT BUFFER POINTER
1072 C6 F0    LDA POINTL
1074 A5 F0    CMP# $FF
;TEST FOR BORROW
1076 C9 FF    BNE BUFDUN
1078 D0 02    BNC POINTH
;DECREMENT HI BYTE
107A C6 F1    DEC POINTH
107C 60          BUFDUN: RTS

*** ASM65 *** (V2A) MAR-79

;
; --- PAGE
; --- CHRROUT: SENDS ASCII CHARACTER IN ACCUMULATOR TO SCREEN
; ALSO KEEPS TRACK OF CURSOR, AND CHANGES ASCII
; LOWER CASE TO REVERSE VIDEO.
;
; --- CALLED BY GETCHR, AND (WHEN ECHO ON) CHRBUF
; SAVE CHAR...
; FIRST RESTORE CURSOR
107D 48          LDY CH
107E A4 24    LDA#Y BASL
1080 B1 28    EOR# $C0
1082 49 C0    AND# $3F
1084 91 28    STA#Y BASL
1086 68          PLA
1087 09 80    ORA# $80
;FIX FOR APPLE SCREEN
1089 20 CB10   JSR CHKLC
;CHECK & FIX LOWER CASE TO REVERSE VID
108C 20 F0FD   JSR COUT
;PUT CHARACTER ON SCREEN
108F A4 24    LDY CH
1091 B1 28    LDA#Y BASL
1093 49 C0    EOR# $C0
1095 91 28    STA#Y BASL
1097 60          RTS

;
; --- GETKEY: IF KEY IS PRESSED, GETS KEY, CONVERTS TO ASCII,
; AND PUTS IT ON SCREEN.
;
; --- CALLED BY MAIN LOOP
1023 AD C1C0 GETCHR: LDA STATUS
1026 29 80    AND# $80
;FIRST CHECK HAS DATA COME IN
1028 D0 01    BNE GOON
;MASK OFF DATA AVAILABLE
102A 60          RTS
;TAKES BRANCH, GOT SOMETHING
102B AD C0C0 GOON: LDA INPUT
;GET CHAR FROM BOARD
102E 20 7D10   JSR CHROUT
;SEND IT TO TV
1031 60          RTS

;
; --- GETKEY: IF KEY IS PRESSED, GETS KEY, CONVERTS TO ASCII,
; AND PUTS IT ON SCREEN.
;
; --- CALLED BY MAIN LOOP
1017 20 3210 MAIN: JSR GETKEY
;GET KEY PRESSED, STICK IN BUFFER
101A 20 2310   JSR GETCHR
;GET CHAR FROM INPUT, PUT ON SCREEN
101D 20 4E10   JSR CHKBUF
;OUTPUT NEXT CHAR FROM BUFFER
1020 4C 1710   JMP MAIN

;
; --- GETCHR: GETS ASCII CHARACTER FROM INPUT PORT
; AND PUTS IT ON SCREEN.
;
; --- CALLED BY MAIN LOOP
1003 AD C1C0 GETCHR: LDA STATUS
1006 29 80    AND# $80
;FIRST CHECK HAS DATA COME IN
1008 D0 01    BNE GOON
;MASK OFF DATA AVAILABLE
100A 60          RTS
;TAKES BRANCH, GOT SOMETHING
100B AD C0C0 GOON: LDA INPUT
;GET CHAR FROM BOARD
100E 20 7D10   JSR CHROUT
;SEND IT TO TV
1011 A9 60          RTS
;IM HOME POSITION
1013 A4 24    LDY CH
1015 91 28    STA#Y BASL

;
; --- MAIN LOOP OF PROGRAM
;
; --- INITILIZE, HOME & START CURSOR
1000 A9 00          LDA# $00
1002 8D F410   STA BUFTML
1005 85 F0    LDA# $00
1007 A9 00          LDA# $00
1009 8D F510   STA BUFTMH
100C 85 F1    LDA# $01

100E 20 58FC HOMEIT: JSR HOME
1011 A9 60          LDA# $60
1013 A4 24    LDY CH
1015 91 28    STA#Y BASL

;
; --- MAIN LOOP OF PROGRAM
1017 20 3210 MAIN: JSR GETKEY
;GET KEY PRESSED, STICK IN BUFFER
101A 20 2310   JSR GETCHR
;GET CHAR FROM INPUT, PUT ON SCREEN
101D 20 4E10   JSR CHKBUF
;OUTPUT NEXT CHAR FROM BUFFER
1020 4C 1710   JMP MAIN

;
; --- GETCHR: GETS ASCII CHARACTER FROM INPUT PORT
; AND PUTS IT ON SCREEN.
;
; --- CALLED BY MAIN LOOP
1023 AD C1C0 GETCHR: LDA STATUS
1026 29 80    AND# $80
;FIRST CHECK HAS DATA COME IN
1028 D0 01    BNE GOON
;MASK OFF DATA AVAILABLE
102A 60          RTS
;TAKES BRANCH, GOT SOMETHING
102B AD C0C0 GOON: LDA INPUT
;GET CHAR FROM BOARD
102E 20 7D10   JSR CHROUT
;SEND IT TO TV
1031 60          RTS

;
; --- GETKEY: IF KEY IS PRESSED, GETS KEY, CONVERTS TO ASCII,
; AND PUTS IT ON SCREEN.
;
; --- CALLED BY MAIN LOOP
1032 2C 00C0 GETKEY: BIT KEYBD
1035 30 01          RTS
1037 60          ;BIT 7 SET IF KEY PRESSED
;TAKES BRANCH IF KEY PRESSED
1038 AD 00C0 GOON2: LDA KEYBD
;GET CHAR
103B 29 7F      AND# $7F
;CLEAR KEYBOARD STROBE
103D 2C 10C0   BIT KEYSTB
;NOV CHECK FOR SPECIAL CHARS
1040 20 9810   JSR CHKSPC
;NOV STICK THIS CHAR IN BUFFER
1043 A0 00    LDY# $00
;INCREMENT POINTER
1045 E6 F0    INC POINTL
;CHECK FOR CARRY
1047 D0 02    BNC SAVEIT
;INCREMENT HI BYTE
1049 E6 F1    INC POINTH
;STICK IT
104B 91 F0    SAVEIT: STA#0Y POINT
104D 60          RTS

;
; --- CHKBUF: CHECK BUFFER, AND IF THERE IS SOMETHING IN IT,
; SEND IT OUT TO THE OUTPUT PORT. (ECHO IF ON)
;
; --- CALLED BY MAIN LOOP
104E A5 F0    CHKBUF: LDA POINTL
;FIRST LETS SEE IF BUFFER EMPTY
1050 CD F410   CMP BUFTML
;CHECK- IF POINT .NE. BUFTM,
1053 D0 07    BNE NOTMT
;THEN GO OUTPUT THE NEXT CHAR
1055 A5 F1    LDA POINTH
;CHECK HI BYTE
1057 CD F510   CMP BUFTMH
;TAKE BRANCH IF BUFFER IS EMPTY
105A F0 20    BEQ BUFDUN
;NOW WAIT TILL BOARD IS READY
105C A0 00    NOTMT: LDY# $00
;TBR BIT)
105E AD C1C0 WAIT: LDA STATUS
AND# $01
1061 29 01    BEQ WAIT
1063 F0 F9    STA OUTPUT
;FALLS THRU WHEN BOARD READY-GET CHAP
1067 8D C2C0   BIT ECHO
;SEND TO OUTPUT PORT
106A 2C F210   BPL NOECHO
106D 10 03    JSR CHROUT
;YES, SEND CHAR TO TV
106F 20 7D10   NOECHO: DEC POINTL
;NOW DECREMENT BUFFER POINTER
1072 C6 F0    LDA POINTL
1074 A5 F0    CMP# $FF
;TEST FOR BORROW
1076 C9 FF    BNE BUFDUN
1078 D0 02    BNC POINTH
;DECREMENT HI BYTE
107A C6 F1    DEC POINTH
107C 60          BUFDUN: RTS

*** ASM65 *** (V2A) MAR-79

APPLE GLASS TTY PROGRAM
;
; TERMINAL PROGRAM - MAKES APPLE LOOK LIKE A STUPID TERMINAL
; BY STEVE WELCH, 14 AUG 1979
; PHONE (303)-776-3414
; 309 S SUNSET, LONGMONT, CO 80501, USA
;
; FIRST SOME DEFINITIONS...
; THIS PROGRAM USES ELECTRONIC SYSTEMS SERIAL I/O BOARD
;DEF SLOT=$40 ;(10*SLOT THAT BOARD IS IN)
;DEF STATUS=$C081+SLOT
;DEF INPUT=$C080+SLOT
;DEF OUTPUT=$C082+SLOT

;DEF COUT=$FD0 ;APPLE MONITOR CHAR OUT
;DEF HOME=$FC58 ;CLEAR SCR #HOME CURSOR
;DEF BASL=$28 ;CURSOR POSITION (SORTA)
;DEF CH=$2A ;CURSOR HORIZONTAL POS.
;DEF KEYBD=$C000 ;KEYBOARD DATA
;DEF KEYSTB=$C010 ;KEYBOARD STROBE CLEAR
;DEF PDL0=$C061 ;APPLE PADDLE SWITCH ZERO
;DEF PDL1=$C062 ; " " ONE
;DEF BEEP=$FF3A

;DEF POINT=$F0 ;ACTUAL BUFFER POINTER
;DEF POINTL=$POINT ; " " LO BYTE
;DEF POINTH=$F1 ; " " HI BYTE

; .LOC $1000

; --- INITILIZE, HOME & START CURSOR
LDA# $00
STA BUFTML
LDA# $00
STA BUFTMH
LDA# $01
STA POINTH

;SET BEGINNING OF BUFFER TO $2000
LDA# $2000
STA BUFTML
; AND SET BUFFER EMPTY
LDA# $00
STA BUFTMH
STA POINTH

;PUT FLASHING CURSOR ON SCREEN
LDA# $60
LDY CH
STA#Y BASL

; --- MAIN LOOP OF PROGRAM
;
; --- INITILIZE, HOME & START CURSOR
LDA# $00
STA BUFTML
LDA# $00
STA BUFTMH
LDA# $01
STA POINTH

;SET BEGINNING OF BUFFER TO $2000
LDA# $2000
STA BUFTML
; AND SET BUFFER EMPTY
LDA# $00
STA BUFTMH
STA POINTH

;PUT FLASHING CURSOR ON SCREEN
LDA# $60
LDY CH
STA#Y BASL

; --- MAIN LOOP OF PROGRAM
;
; --- CALLED BY MAIN LOOP
1023 AD C1C0 GETCHR: LDA STATUS
1026 29 80    AND# $80
;FIRST CHECK HAS DATA COME IN
1028 D0 01    BNE GOON
;MASK OFF DATA AVAILABLE
102A 60          RTS
;TAKES BRANCH, GOT SOMETHING
102B AD C0C0 GOON: LDA INPUT
;GET CHAR FROM BOARD
102E 20 7D10   JSR CHROUT
;SEND IT TO TV
1031 60          RTS

;
; --- GETKEY: IF KEY IS PRESSED, GETS KEY, CONVERTS TO ASCII,
; AND PUTS IT ON SCREEN.
;
; --- CALLED BY MAIN LOOP
1032 2C 00C0 GETKEY: BIT KEYBD
1035 30 01          RTS
1037 60          ;BIT 7 SET IF KEY PRESSED
;TAKES BRANCH IF KEY PRESSED
1038 AD 00C0 GOON2: LDA KEYBD
;GET CHAR
103B 29 7F      AND# $7F
;CLEAR KEYBOARD STROBE
103D 2C 10C0   BIT KEYSTB
;NOV CHECK FOR SPECIAL CHARS
1040 20 9810   JSR CHKSPC
;NOV STICK THIS CHAR IN BUFFER
1043 A0 00    LDY# $00
;INCREMENT POINTER
1045 E6 F0    INC POINTL
;CHECK FOR CARRY
1047 D0 02    BNC SAVEIT
;INCREMENT HI BYTE
1049 E6 F1    INC POINTH
;STICK IT
104B 91 F0    SAVEIT: STA#0Y POINT
104D 60          RTS

;
; --- CHKBUF: CHECK BUFFER, AND IF THERE IS SOMETHING IN IT,
; SEND IT OUT TO THE OUTPUT PORT. (ECHO IF ON)
;
; --- CALLED BY MAIN LOOP
104E A5 F0    CHKBUF: LDA POINTL
;FIRST LETS SEE IF BUFFER EMPTY
1050 CD F410   CMP BUFTML
;CHECK- IF POINT .NE. BUFTM,
1053 D0 07    BNE NOTMT
;THEN GO OUTPUT THE NEXT CHAR
1055 A5 F1    LDA POINTH
;CHECK HI BYTE
1057 CD F510   CMP BUFTMH
;TAKE BRANCH IF BUFFER IS EMPTY
105A F0 20    BEQ BUFDUN
;NOW WAIT TILL BOARD IS READY
105C A0 00    NOTMT: LDY# $00
;TBR BIT)
105E AD C1C0 WAIT: LDA STATUS
AND# $01
1061 29 01    BEQ WAIT
1063 F0 F9    STA OUTPUT
;FALLS THRU WHEN BOARD READY-GET CHAP
1067 8D C2C0   BIT ECHO
;SEND TO OUTPUT PORT
106A 2C F210   BPL NOECHO
106D 10 03    JSR CHROUT
;YES, SEND CHAR TO TV
106F 20 7D10   NOECHO: DEC POINTL
;NOW DECREMENT BUFFER POINTER
1072 C6 F0    LDA POINTL
1074 A5 F0    CMP# $FF
;TEST FOR BORROW
1076 C9 FF    BNE BUFDUN
1078 D0 02    BNC POINTH
;DECREMENT HI BYTE
107A C6 F1    DEC POINTH
107C 60          BUFDUN: RTS

*** ASM65 *** (V2A) MAR-79

```



APPLE II® JOYSTICK & EXPANDA-PORT

PROGRAMMA

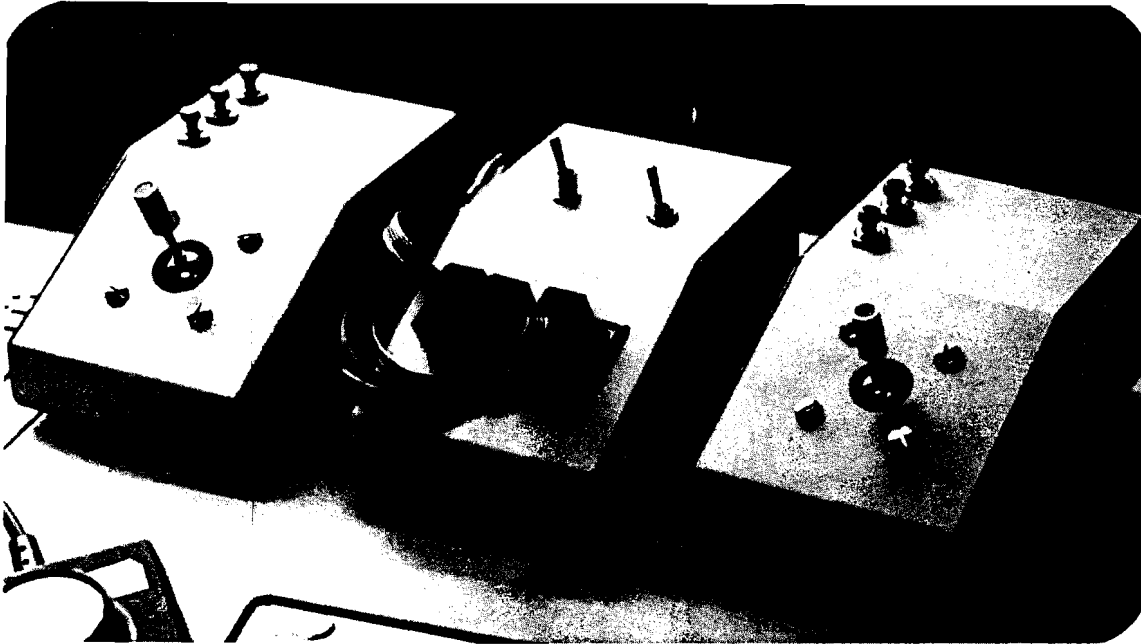
Computer
System
Products

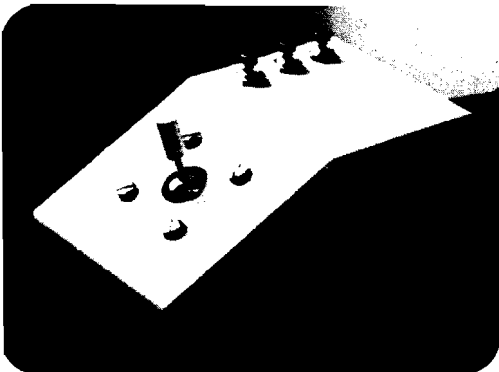

EVERY APPLE II OWNER SHOULD HAVE ONE!



JOYSTICK \$49.95

The PROGRAMMA JOYSTICK is an input peripheral that attaches to the APPLE II Computer's game I/O Port. The JOYSTICK is a must for the serious game player, and it offers a degree of linearity not currently available with other joysticks. The ease of maneuverability and the availability of the "functional" switches make the PROGRAMMA JOYSTICK a much needed enhancement to any APPLE II Computer System owner. The PROGRAMMA JOYSTICK comes completely assembled and tested, including a User's Guide.

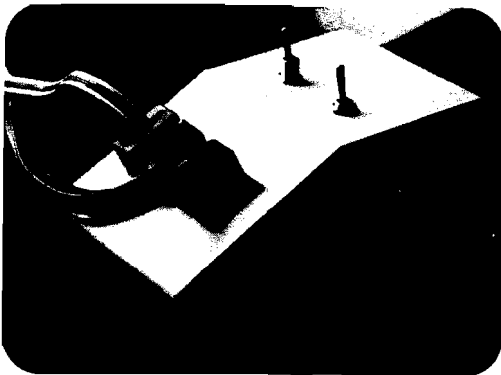

EXPANDA-PORT \$49.95

The PROGRAMMA EXPANDA-PORT is a multi-port expander for the game I/O port of any APPLE II Computer System. In addition to allowing expansion for up to six devices, the EXPANDA-PORT contains a built-in speaker that replaces the function of the Apple II's speaker. The switches on the EXPANDA-PORT allow for the selection of the specific device desired and for the switching of that device. No unplugging of any device connected to the EXPANDA-PORT is required. The PROGRAMMA EXPANDA PORT comes completely assembled and tested, including a User's guide.

The PROGRAMMA JOYSTICK and EXPANDA-PORT are available on a limited basis through your local computer dealer. Apple II is a registered trademark of Apple Computers, Inc.

**PROGRAMMA
INTERNATIONAL, INC.**

3400 Wilshire Blvd.
Los Angeles, CA 90010 (213) 384-0579 • 384-1116 • 384-1117

Data Acquisition Modules

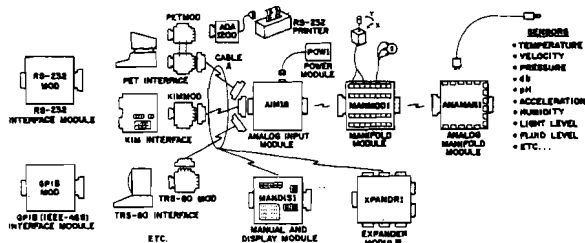

The world we live in is full of variables we want to measure. These include weight, temperature, pressure, humidity, speed and fluid level. These variables are continuous and their values may be represented by a voltage. This voltage is the analog of the physical variable. A device which converts a physical, mechanical or chemical quantity to a voltage is called a sensor.

Computers do not understand voltages: They understand bits. Bits are digital signals. A device which converts voltages to bits is an analog-to-digital converter. Our AIM16 (Analog Input Module) is a 16 input analog-to-digital converter.

The goal of Connecticut microComputer in designing the DAM SYSTEMS is to produce easy to use, low cost data acquisition modules for small computers. As the line grows we will add control modules to the system. These acquisition and control modules will include digital input sensing (e.g. switches), analog input sensing (e.g. temperature, humidity), digital output control (e.g. lamps, motors, alarms), and analog output control (e.g. X-Y plotters, or oscilloscopes).

Analog Input Module



The AIM16 is a 16 channel analog to digital converter designed to work with most microcomputers. The AIM16 is connected to the host computer through the computer's 8 bit input port and 8 bit output port, or through one of the DAM SYSTEMS special interfaces.

The input voltage range is 0 to 5.12 volts. The input voltage is converted to a count between 0 and 255 (00 and FF hex). Resolution is 20 millivolts per count. Accuracy is $0.5\% \pm 1$ bit. Conversion time is less than 100 microseconds per channel. All 16 channels can be scanned in less than 1.5 milliseconds.

Power requirements are 12 volts DC at 60 ma.

The POW1 is the power module for the AIM16. One POW1 supplies enough power for one AIM16, one MANMOD1, sixteen sensors, one XPANDR1 and one computer interface. The POW1 comes in an American version (POW1a) for 110 VAC and in a European version (POW1e) for 230 VAC.

AIM16... \$179.00
POW1a... \$ 14.95
POW1e... \$ 24.95

Connectors

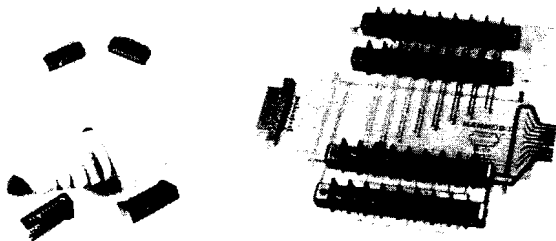

The AIM16 requires connections to its input port (analog inputs) and its output port (computer interface). The ICON (Input CONNector) is a 20 pin, solder eyelet, edge connector for connecting inputs to each of the AIM16's 16 channels. The OCON (Output CONNector) is a 20 pin, solder eyelet edge connector for connecting the computer's input and output ports to the AIM16.

The MANMOD1 (MANifold MODule) replaces the ICON. It has screw terminals and barrier strips for all 16 inputs for connecting pots, joysticks, voltage sources, etc.

CABLE A24 (24 inch interconnect cable has an interface connector on one end and an OCON equivalent on the other. This cable provides connections between the DAM SYSTEMS computer interfaces and the AIM16 or XPANDR1 and between the XPANDR1 and up to eight AIM16s.

ICON... \$ 9.95
OCON... \$ 9.95
MANMOD1... \$59.95
CABLE A24... \$19.95

XPANDR1

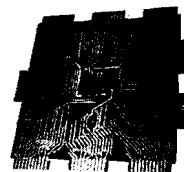

The XPANDR1 allows up to eight AIM16 modules to be connected to a computer at one time. The XPANDR1 is connected to the computer in place of the AIM16. Up to eight AIM16 modules are then connected to each of the eight ports provided using a CABLE A24 for each module. Power for the XPANDR1 is derived from the AIM16 connected to the first port.

XPANDR1... \$59.95

TEMPSENS



This module provides two temperature probes for use by the AIM16. This module should be used with the MANMOD1 for ease of hookup. The MANMOD1 will support up to 16 probes (eight TEMPSENS modules). Resolution for each probe is 1°F.

TEMPSENS2P1 (-10°F to 120°F) ... \$49.95

PET Printer Adapter

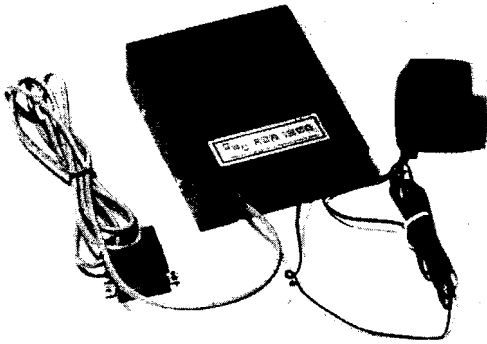

The CmC ADA 1200 drives an RS-232 printer from the PET IEEE-488 bus. Now, the PET owner can obtain hard copy listings and can type letters, manuscripts, mailing labels, tables of data, pictures, invoices, graphs, checks, needlepoint patterns, etc., using RS-232 standard printer or terminal.

A cassette tape is included with software for plots, formatting tables and screen dumps. The ADA1200 sells for \$169.00 and includes case, power supply and cable.

Order direct or contact your local computer store.

VISA AND M/C ACCEPTED — SEND ACCOUNT NUMBER, EXPIRATION DATE AND SIGN ORDER.
ADD \$3 PER ORDER FOR SHIPPING & HANDLING — FOREIGN ORDERS ADD 10% FOR AIR POSTAGE

CONNECTICUT microCOMPUTER, Inc.
150 POCONO ROAD
BROOKFIELD, CONNECTICUT 06804
TEL: (203) 775-9659 TWX: 710-456-0052

Apple-Doc

By Roger Wagner

An Aid to the Development
and Documentation of Applesoft Programs

This 3 program set is a must to anyone writing or using programs in Applesoft! It not only provides valuable info. on each of your programs, but allows you to change any element throughout the listing almost as easily as you would change a single line!!

With Apple-Doc you can produce a list of every variable in your program and the lines each is used on, each line called by a GOTO, GOSUB, etc., in fact, every occurrence of almost anything!

You can rename variables, change constants and referenced line #'s, or do local or global replacement editing on your listing.

In fact, we guarantee that after purchase, if you don't feel APPLE-DOC is one of the most valuable programs in your library we will even refund your money! (Upon return of product.)

Unheard of? Yes! But that's how good APPLE-DOC really is!

That's not all! Send for free info. or visit your nearest Apple dealer.

Only \$19.95 Please specify diskette or tape.
(Calif. residents add 6% Sales Tax)

Available from your local computer store or:

Southwestern Data Systems
P.O. Box 582-M
Santee, CA 92071
(714) 562-3670

(Dealer inquiries invited)

Put Yourself in Control with the APPLETHROTTLE

That's right! The APPLETHROTTLE will turn your game paddles into a speed controller. By simply pushing a button, you can stop your computer for as long as you want. Release the button, and your computer enters a slow-motion mode with one paddle controlling the speed. And if that isn't enough, look at these additional features:

- Plugs into any slot
- Works with machine language, Integer BASIC, and Applesoft
- Normal - slow - stop
- Use to LIST, TRACE, RUN, etc.
- NO SOFTWARE to load
- Unveil program secrets

APPLETHROTTLE **\$89.95**

And there's more! No more multiple LIST commands to view small program sections. With the APPLETHROTTLE, you'll be able to list or trace long programs while watching your program flow in slow-motion. So get in control with the APPLETHROTTLE and order yours today!

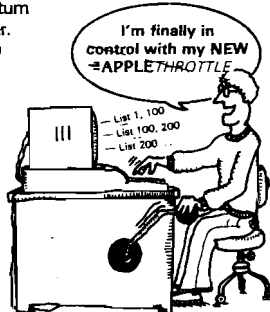

APPTIME, a Real Time Clock for the Apple II. Plugs directly into any slot and keeps time even when computer is off. Features 12/24 Hour, BCD/ASCII data format, and AC/Crystal time base selection. Includes software examples for machine language and BASIC programs. Completely assembled and tested.
APT-1 Real Time Clock \$79.95

PROTOBOARD, with over 1300 holes on 0.1 centers for designing your own circuits.
APB-1 Protoboard \$17.95

VERBATIM 5 1/4" DISKETTES
Soft-Sector Box of 10 ... **\$34.50**
(plastic file case included)

PET Word Processor

**8K
and
16/32K
PET
versions**

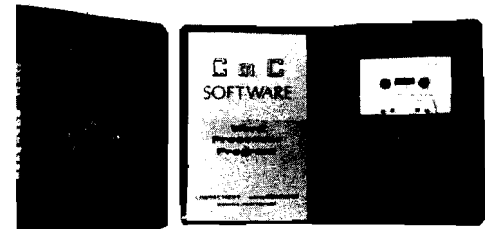

This program permits composing and printing letters, flyers, advertisements, manuscripts, etc., using the COMMODORE PET and a printer.

Printing directives include line length, line spacing, left margin, centering and skip. Edit commands allow you to insert lines, delete lines, move lines and paragraphs, change strings, save files onto and load files from cassette (can be modified for disk), move up, move down, print and type.

Added features for the 16/32K version include string search for editing, keyboard entry during printing for letter salutations, justification, multiple printing and more.

A thirty page instruction manual is included.
The CmC Word Processor Program for the 8K PET is \$29.50. The 16/32K version is \$39.50.

Order direct or contact your local computer store.

VISA AND M/C ACCEPTED — SEND ACCOUNT NUMBER, EXPIRATION DATE AND SIGN ORDER.
ADD \$1 PER ORDER FOR SHIPPING & HANDLING — FOREIGN ORDERS ADD 10% FOR AIR POSTAGE

CONNECTICUT microCOMPUTER, Inc.
150 POCONO ROAD
BROOKFIELD, CONNECTICUT 06804
TEL: (203) 775-9659 TWX: 710-456-0052



west side electronics
P.O. Box 636, Chatsworth, CA 91311
We pay all shipping in Continental U.S.A.
Others add 10%. California residents add 6% tax



Graphics and the Challenger 1P

William L. Taylor
246 Flora Road N.W.
Leavittsburg, OH 44430

The Challenger computers have some interesting graphic capabilities. A discussion of the inner workings of the graphics and programs for using them are presented.

Introduction

Recently I purchased an OSI Challenger C1P, and I find its graphics and polled keyboard to be interesting tools for the programmer. But to the computer hobbyist with little experience in programming, it may seem very confusing. Since the C1P's introduction, I have seen few articles describing the graphics capabilities or use of the polled keyboard.

Part I

Programming the C1P in BASIC to utilize the graphics elements contained in the character generator and the polled keyboard are simple tasks when one understands how these functions work. This article will explain the polled keyboard functions and give a brief description of a program that I have written in Microsoft OSI BASIC to implement the graphics characters contained in the C1P character generator ROM.

The user of the C1P will find the keyboard a very interesting feature. Every key on the keyboard can be programmed and read under BASIC. This makes for real-time utilization of the keyboard. The program included in part I of this article shows how the keys are

read with a PEEK statement and how the keyboard is strobed with a POKE statement. The keyboard is laid out in a matrix of eight rows and eight columns. To use the keyboard in a program, that is, a direct access in a running program; the programmer must first disable Control C. In the normal polling routine in a program the keyboard is interrogated to check for a Control C to signal the computer that a break is desired in the program. The Control C must be disabled.

To disable Control C, a flag in RAM must be set to 1. Normally the flag is set to 0. Next, the row that the key or keys that are to be read must be strobed. To do this, we POKE the row number. In the C1P, the rows are labeled R0 through R7. Each row has a decimal value assigned to it. The C1P keyboard is accessed in the following manner: POKE (57088), 127. This statement signals the keyboard that a row is to be examined for a key closure. To check the row for a closure the column in which the desired key is located must be examined. We do this with a PEEK statement, such as, IF PEEK(57088) = 127 THEN 100. This statement checks for the 1 key. If the 1 key were closed, then a jump to line 100 would be executed.

In the program that I have provided, you will see how the keyboard is polled

to read the keys 1 through 8. If any of these keys are pressed the computer makes a decision concerning where to jump for a specific task. The following example shows how Control C is disabled and the row is strobed: 30 POKE 530,1: POKE (y),127. Variable Y is the keyboard location which is 57088 decimal. The next step is to read the columns in which the expected keys are located. For this we must PEEK the columns. This is done in lines 35 through 80 in the BASIC program. By examining the program further, we see that if a key from 1 to 8 is pressed, the program will jump to a subroutine. These subroutines are located at lines 100-800. It is in these subroutines that the actual plotting and writing of the graphics are accomplished.

At this point, a few words about the OSI C1P video display are in order. This display can produce up to four pages of alpha- numerics, which are in a 25 character line by 25 lines format. The alpha- numerics include upper case and lower case letters, the numeral set, punctuation marks, and 160 graphics elements.

Part I of this article is mostly concerned with the graphics elements and how they are executed in a BASIC program. To display any character on the

video monitor screen, the ASCII equivalent must be written in the video memory. This memory occupies 1 kilobyte of memory dedicated to the video display. This memory is located at D000 through D3FF hex, or 53379 to 54171 decimal. In the program I have set the video graphics pointer to point to mid-screen, as can be seen in the program at line 15. The mid-screen position is contained in the variable L. This is set to 53775 decimal.

The complete code set for the alpha-neremics and the graphics elements is listed in the OSI "Graphics Manual" for the Challengers, so I will not delay in explaining all the elements or their codes, but rather, define the character that will be used in the enclosed program. In each of the subroutines in the BASIC program, the decimal code character is POKEd out to some video memory location. An example is 100 POKE L+A, 161. This places a square box on the screen depending on the value of L+A. If the program were just started and the 1 key were pressed and held down, the box would be placed at 53775 decimal, or mid-screen. If the key were kept held down the box would then be written at L+A again, but at 31 greater than the last box because A was incremented by 31 in the statement at line 110. As long as the 1 key is held down, the box would continue to be written at a location 31 places greater. This forms a diagonal downward to the left bottom of the screen. If the key is then released the program will halt and wait for another key to be pressed. If, for instance, the 6 key were next pressed, then the box would be written upward from the last point displayed on the screen where the diagonal ended. In examining the program, you will see that there are eight subroutines beginning at line 100 through line 850. These subroutines form a method for plotting the point where the box can be drawn from the use of the keys 1 through 8 on the keyboard. These keys are used as pointers, and they are defined in figure 1. The figure shows the direction of angle for each key. Each subroutine has a delay loop that allows the user to obtain a single point with a single key closure.

I have presented a brief description of the C1P's polled keyboard, and how to place a graphics element out to the video monitor screen with a BASIC program. This BASIC program allows an "etch-a sketch" type drawing on the monitor screen. From this quick description of the keyboard function and how a BASIC program can be used to read the keyboard in real-time, and from the explanation of how to place a graphics character out to the monitor screen with a BASIC program, you will be able to write similar programs using these techniques.

Listing 1

```

10 FOR R= 1 TO 32: PRINT: NEXT R
12 A=0:B=0:C=0:D=0
13 E=0:F=0:G=0:H=0
15 L=53775
20 Y=57088
30 POKE 530,1:POKE Y, 127
35 IF PEEK(Y)=127 THEN 100
40 IF PEEK(Y)=191 THEN 200
45 IF PEEK(Y)=223 THEN 300
50 IF PEEK(Y)=239 THEN 400
55 IF PEEK(Y)=247 THEN 500
60 IF PEEK(Y)=251 THEN 600
65 IF PEEK(Y)=253 THEN 700
70 POKE Y, 191
75 IF PEEK(Y)=127 THEN 800
80 GOTO 30
100 POKE L+A, 161
110 A=A+31
140 FOR T= 1 TO 300:NEXT T
145 L=L+A
147 A=0
150 GOTO 30
200 POKE L+B, 161
210 B=B+32
240 FOR T= 1 TO 300:NEXT T
245 L=L+B
247 B=0
250 GOTO 30
300 POKE L+C, 161
310 C=C+33
340 FOR T= 1 TO 300: NEXT T
345 L=L+C
347 C=0
350 GOTO 30
400 POKE L+D, 161
410 D=D+1
440 FOR T= 1 TO 300: NEXT T
445 L=L+D
447 D=0
450 GOTO 30
500 POKE L+E, 161
510 E=E+31
540 FOR T= 1 TO 300: NEXT T
545 L=L+E
547 E=0
550 GOTO 30
600 POKE L+F, 161
610 F=F+ -32
640 FOR T= 1 TO 300: NEXT T
645 L=L+F
647 F=0
700 POKE L+G, 161
710 G=G+ -33
740 FOR T= 1 TO 300: NEXT T
745 L=L+G

```

```

747 G=0
750 GOTO 30
800 POKE L+H, 161
810 H=H+ -1
840 FOR T= 1 TO 300: NEXT T
845 L=L+H
847 H=0
850 GOTO 30

```

Part II

Now I will expand the basic programming principles pertaining to the development of graphics elements. This time we will develop graphic elements that represent large numbers as viewed on the system monitor screen. Please remember that the program following part 2 of this article is for demonstrating the methods of using a BASIC program to generate graphics elements utilizing the expanded graphic capabilities of the graphics generator that is resident in the C1P, and the OSI C2-4P computers.

I hope to give the reader the building blocks that will enable him to develop larger graphics programs using the techniques discussed here and in a companion article, in which I will give a BASIC program for a twelve hour clock that utilizes the large graphics numbers. The demonstration program is written in BASIC. It is written in subroutines and modular blocks. In the subroutines the graphic elements for the large numbers are generated and POKEd out to the C1P's video display. To begin, the subroutine at lines 1000 through 1100 will generate a large number (in this case, a large number 1).

To describe the operation of the subroutine, refer to the program listing 2. At line 1000 the screen parameters are set up with a FOR-NEXT loop (FOR A=5400 TO 54128 STEP 32). Line 1010 POKE A, 161: NEXT A. In these statement lines, the variable A will be incremented by 32 for every pass through the FOR-NEXT loop. When this portion of the subroutine is executed, the value 161 in statement line 1010 will place a white square block on the monitor screen beginning at the initial value in the A variable. In this instance the A variable will contain decimal 54000, located on the monitor screen near the bottom right hand corner. With every pass through the FOR-NEXT loop a white block will be placed 32 places ahead of the last video graphics character. On the C1P's monitor 32 places will place the next character directly below the last character placed on the screen. This FOR-NEXT loop in the subroutine will generate of place four white squares, one over the other, which will develop the graphics representation of the number one on the monitor screen.

Listing 2

```

1 REM NUMBER GRAPHICS DEMONSTRATOR
2 REM BY W.L.TAYLOR
3 REM JULY 4 1979
5 PRINT " THIS IS A DEMONSTRATION"
10 PRINT " OF THE C1P GRAPHICS AND LARGE NUMBERS"
20 PRINT " ALL NUMBERS FROM 1 TO 10 WILL BE DISPLAYED"
30 GOSUB 2900
39 REM INITIALIZE USR VECTOR FOR JUMP TO 2FE8
40 POKE 11,232: POKE 12,47
49 REM GENERATE RANDOM NUMBER FROM 0 TO 10
50 R= INT((11+1)*RND(1)-1)
52 REM COMPARE RANDOM NUMBER AND JUMP TO LARGE NUMBER TABLE
55 IF R > 11 THEN 50
56 IF R < 0 THEN 50
59 REM EXECUTE FAST SCREEN ERASE
60 X=USR(X)
65 IF R= 11 THEN GOSUB 1900
67 IF R= 11 THEN GOSUB 1000
70 IF R= 1 THEN GOSUB 1000
80 IF R= 2 THEN GOSUB 1100
90 IF R= 3 THEN GOSUB 1200
100 IF R= 4 THEN GOSUB 1300
110 IF R= 5 THEN GOSUB 1400
120 IF R= 6 THEN GOSUB 1500
130 IF R= 7 THEN GOSUB 1600
140 IF R= 8 THEN GOSUB 1700
150 IF R= 9 THEN GOSUB 1800
160 IF R= 10 THEN GOSUB 1900: GOSUB 2000
165 IF R= 0 THEN GOSUB 2000
170 FOR I= 1 TO 1000: NEXT I
180 X= USR(X)
190 GOTO 50
999 REM GENERATE LSD 1
1000 FOR A= 54000 TO 54128 STEP 32
1010 POKE A,161:NEXT A
1020 RETURN
1099 REM GENERATE LSD 2
1100 FOR A= 54000 TO 54002
1110 POKE A,161: NEXT A
1120 POKE 54034,161
1130 FOR A= 54064 TO 54066
1140 POKE A,161: NEXT A
1160 POKE 54096,161
1170 FOR A= 54128 TO 54130
1180 POKE A,161: NEXT A
1190 RETURN
1199 REM GENERATE LSD 3
1200 FOR A= 54000 TO 54002
1210 POKE A,161: NEXT A
1220 FOR A= 54064 TO 54066
1240 POKE A,161: NEXT A
1250 POKE 54098,161
1260 FOR A= 54128 TO 54130
1270 POKE A,161: NEXT A
1280 RETURN
1299 REM GENERATE LSD 4

```

At this point I will give a brief description of the BASIC program, explaining the unique features. This will give the user a better understanding of how the graphic characters can be utilized in other programs, such as games, clock programs, etc. In the BASIC program at line 30, a jump to subroutine at line 2900 will load a machine language subroutine in user memory. that will be used for an ultra-fast screen erase when needed by the Main Line BASIC program. The Machine Language object code for the fast screen erase routine is stored in DATA statements at lines 3000 through 3030.

This data is read with a READ statement and POKEd into user memory at 12264 decimal through 12287 decimal. This corresponds with 2FE8 Hex through 2FFE Hex. The machine code routine when executed with the BASIC program will clear the last two pages of screen memory (that is, the bottom half of the C1p's monitor screen). This was done so that the user could utilize the top half for displaying a message and have it remain until the need to erase that half of the screen is desired. After the machine code is loaded into user memory, a RETURN from subroutine will be executed and the program will return to line 40, where the USR vector will be initialized to point to the beginning of the fast screen routine in user memory. The USR vector locations in the C1p are located at 11 and 12 decimal or 0B and 0C Hex. At line 50 a random number is generated and stored in the R variable. The statements at lines 55 and 56 insure that the random number will be only 0 through 10. The statement at line 60 will execute the fast screen erase. This is the USR function of BASIC, which causes a jump to the USR Vector at 11 and 12, where the jump to the fast screen erase is located. After the fast screen erase routine has been executed and the Op code Hex 60 is reached in the machine code routine, a return to BASIC will be executed and continue at line 65. The program from line 65 through 165, is a table where the random number from the random number generator is compared to fixed constants. If the random number equals any of the constants, a jump to the subroutine that generates that number will occur. At line 170, the FOR-NEXT loop will allow the last generated video display to be viewed for the period of time that was set in the loop. The statement in line 180, calls up the fast screen erase machine code routine. The statement at line 190 forces a new pass through the mainline program.

From the program listing, you will see that the formation of the video graphics digits are developed in subroutines. These subroutines begin at

line 1000. There is a subroutine for each of the least significant digit and a subroutine for the next most digit. To develop the digit 10, we must use two of the subroutines. This would also be the case for any number greater than 10. The program is separated by REM statements. Each module will begin with a REM statement that defines the function of the subroutine, and if the reader analyses each module he will get a clear picture of how the numbers are generated and placed on the monitor screen.

The program listing beginning at line 3500, gives the object code listing for the fast screen erase. This is the machine code that is loaded into user memory when the BASIC program initializes the user memory through the BASIC subroutine at line 2899. The BASIC program listing has the fast screen erase routine loaded at 12264 to 12287 decimal. This was loaded at the top of a 12k memory. If your C1P does not have this much memory, you will have to change the program to work with the amount of memory that you may have in your system. The program listing gives the necessary changes for either an 8K or 4K memory system. These changes are listed starting at line 3500. A word of caution must be conveyed at this time. The user must set the memory size of his machine to reflect the size of memory that will allow the machine code routine to be entered and protected. That is, the memory size must be set when bringing up BASIC to less than the beginning of the machine code routine. If your system has only 4K of memory, set the memory size to 4050 decimal. If your memory has 8K, set the memory size to 8160. If you should have 12K, as my memory does, then set the size to 12263. Be sure that you change subroutine beginning at 2899 for your personal system depending on the amount of memory your system has available.

In conclusion, I have presented what I think will help you with the programming techniques needed to understand the inner workings of the C1P's graphics capabilities, and the use of BASIC as a tool to be utilized with the graphics capabilities of the C1P, or other Challenger computers. The development of large graphics numbers is only one example of how the expanded graphics set of the C1P can be used. The same techniques used in this article can be utilized for more complex exploration of the graphics and BASIC programming functions to develop programs such as games etc. In a future article, I will further expand the example program here to include a larger number set and have the C1P function as a twelve hour clock running under a BASIC program. Until then, good luck.

```

1300 FOR A= 54000 TO 54064 STEP 32
1310 POKE A,161: NEXT A
1320 FOR A= 54064 TO 54066
1330 POKE A,161: NEXT A
1340 FOR A= 54002 TO 54130 STEP 32
1350 POKE A,161: NEXT A
1360 RETURN
1399 REM GENERATE LSD 5
1400 FOR A= 54000 TO 54002
1410 POKE A,161: NEXT A
1420 FOR A= 54064 TO 54066
1425 POKE A,161: NEXT A
1430 FOR A= 54128 TO 54130
1440 POKE A,161: NEXT A
1450 POKE 54032,161: POKE 54098,161
1460 RETURN

1499 REM GENERATE LSD 6
1500 FOR A= 54000 TO 54002
1510 POKE A,161: NEXT A
1520 FOR A= 56064 TO 54066
1530 POKE A,161: NEXT A
1540 FOR A= 54128 TO 54130
1550 POKE A,161: NEXT A
1560 POKE 54032,161: POKE 54096,161: POKE 54098,161
1570 RETURN
1599 REM GENERATE LSD 7
1600 FOR A= 54000 TO 54002
1610 POKE A,161: NEXT A
1620 FOR A= 54002 TO 54130 STEP 32
1630 POKE A,161: NEXT A
1640 RETURN
1699 REM GENERATE LSD 8
1700 FOR A= 54000 TO 54128 STEP 32
1710 POKE A,161: NEXT A
1720 FOR A= 54002 TO 54130 STEP 32
1730 POKE A,161: NEXT A
1740 FOR A= 54001 TO 54129 STEP 64
1750 POKE A,161: NEXT A
1760 RETURN
1799 REM GENERATE LSD 9
1800 FOR A= 54002 TO 54130 STEP 32
1810 POKE A,161: NEXT A
1820 FOR A= 54000 TO 54002
1830 POKE A,161: NEXT A
1840 FOR A= 54064 TO 54066
1850 POKE A,161: NEXT A
1860 FOR A= 54128 TO 54130
1870 POKE A,161: NEXT A
1880 POKE 54032,161
1890 RETURN
1899 REM GENERATE SMD 1
1900 FOR A= 53998 TO 54126 STEP 32
1910 POKE A,161: NEXT A
1930 RETURN
1999 REM GENERATE LSD 0

```

```

2000 FOR A= 54000 TO 54002
2010 POKE A,161: NEXT A
2020 FOR A= 54000 TO 54128 STEP 32
2030 POKE A,161: NEXT A
2040 FOR A= 54002 TO 54130 STEP 32
2050 POKE A,161: NEXT A
2060 POKE 54129,161
2070 RETURN
2899 REM FAST ERASE ROUTINE MACHINE CODE LOAD
2900 FOR R= 12264 TO 12287
2920 READ F: POKE R,F: NEXT R
2930 RETURN
3000 DATA 169,32,160,4,162,0,157,0
3010 DATA 210,232,208,250,238,240
3020 DATA 47,136,208,244,169,210
3030 DATA 141,240,47,96
3500 REM MACHINE CODE FAST SCREEN ERASE
3510 REM LOADS AT HEX 2FEB TO 2FFF
3520 REM 2FEB A9 20 00 04 A2 00 9D 00 D2 B8 D0 FA
3530 REM EE F0 2F B8 D0 F4 A9 D2 8D F0 2F 60
3540 REM TYPE CONTROL C TO END
3550 REM CHANGE LINE 2900 TO (FOR R= 4072 TO 4095) FOR A 4K
SYSTEM
3560 REM CHANGE LINE 3000 TO 3030 TO REFLECT THE NEXT LIST
DATA 169,32,160,4,162,0,157,0
3010 DATA 210,232,208,250,238,240
3020 DATA 47,136,208,244,169,210
3030 DATA 141,240,47,96
3580 REM THESE ARE FOR A 4K CTP
3590 REM CHANGE LINE 40 (40 POKE 11,232: POKE 12,15)

```

The PET[®] Gazette and PET User Notes are now a part of

COMPUTE.

The Journal for Progressive Computing™

Continuing major sections on Business, Industrial and Educational Applications and Resources, Plus The PET[®] Gazette, The ATARI[®] Gazette, The APPLE[®] Gazette and The SBC (Single Board Computer) Gazette. All in each issue!

A Sampling of Our 104 page "Super" Fall Issue:

Tokens in Microsoft BASIC: Harvey Herman. ATARI Computers: The Ultimate Teaching Machines?: John Victor. Carl Moser Presents a Universal 6502 Memory Test. Microcomputers in Nuclear Instrumentation: Joe Byrd. AIM 65 Review: Don Clem. Mastering The Ohio Scientific Challenger II: A Learn-By-Doing Approach: Keith Russell and Dave Shultz. CORVUS IIA Disk Drive for APPLE: A Review by Michael Tulloch. Pierre Barrette on Microcomputers in Education. Len Lindsay Reviews Three Word Processors. PET in Transition/ROM Upgrade Map: Jim Butterfield. Trace for the PET: Brett Butler. 32K PET Programs Arrive: Len Lindsay. Using Direct Access Files With the Commodore 2040 Dual Disk Drive: Chuck Stuart, plus Reviews, Resources and Products.

New Features Coming in January include: "Rambling" by Roy O'Brien and "The Tape Exchange" by Gene Beals.

1980 Bimonthly Subscription (Six Issues)	\$ 9.00
"Super" Fall Issue With 1980 Subscription	1.00
	<hr/> \$10.00

Make Check or Money Order Payable to **COMPUTE.**
Post Office Box 5119
Greensboro, North Carolina 27403 USA

COMPUTE., the new
6502 resource magazine for
PET, Apple, Atari, Kim, Sym, Aim
and OSI Owners.

COMPUTE. The Journal for Progressive Computing is published by Small System Services, Inc. of Greensboro, North Carolina. Robert Lock, Editor/Publisher.

The Apple Shoppe

JOURNAL OF APPLE APPLICATIONS

Vol. No.

EDITED BY
DAVID E. SMITH

PUBLISHED BY **COMPUTE.**
tutor.

YOU BOUGHT THE BEST! NOW LEARN TO USE IT!

AT LAST!

A magazine devoted to **Applications** as well as **Technique** for the Apple Computer.

THE APPLE SHOPPE WILL TEACH YOU HOW TO DO ALL THOSE FANCY THINGS ON THE APPLE. LEARN HOW OTHERS ARE USING THEIR APPLES IN THE HOME, SCHOOLS AND BUSINESSES.

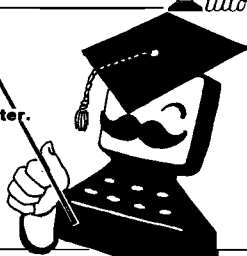

CHECK THESE FEATURES:

- ✓ Feature Articles on Apple Applications
- ✓ Program of the Month—'How To' with Listings
- ✓ New Products Review—Alf Boards, Pascal, etc
- ✓ Language Lab—Learn Basic, Pascal, Forth, Lisp, Pilot
- ✓ Future Projects—Participate in a new program design called "The China Syndrome"
- ✓ Graphics Workshop—Learn secrets formerly known only to "Super Programmers"

YES I want to learn how to get the most out of my Apple. Send me a one year subscription. I enclose \$12.

NAME: _____

ADDRESS: _____

CITY _____ STATE _____ ZIP _____ PHONE _____

NO, I already know it all, but send me a free sample of next issue.

Send check or money order to: Apple Shoppe, P.O. Box 701, Placencia, CA 92670
or call (714) 996-0441

SYM-1, 6502-BASED MICROCOMPUTER

- FULLY-ASSEMBLED AND COMPLETELY INTEGRATED SYSTEM that's ready-to-use
- ALL LSI IC'S ARE IN SOCKETS
- 28 DOUBLE-FUNCTION KEYPAD INCLUDING UP TO 24 "SPECIAL" FUNCTIONS
- EASY-TO-VIEW 6-DIGIT HEX LED DISPLAY
- KIM-1* HARDWARE COMPATIBILITY
The powerful 6502 8-Bit MICROPROCESSOR whose advanced architectural features have made it one of the largest selling "micros" on the market today.
- THREE ON-BOARD PROGRAMMABLE INTERVAL TIMERS available to the user, expandable to five on-board.
- 4K BYTE ROM RESIDENT MONITOR and Operating Programs.
- Single 5 Volt power supply is all that is required.
- 1K BYTES OF 2114 STATIC RAM onboard with sockets provided for immediate expansion to 4K bytes onboard, with total memory expansion to 65, 536 bytes.
- USER PROM/ROM: The system is equipped with 3 PROM/ROM expansion sockets for 2316/2332 ROMs or 2716 EPROMs
- ENHANCED SOFTWARE with simplified user interface
- STANDARD INTERFACES INCLUDE:
 - Audio Cassette Recorder Interface with Remote Control (Two modes: 135 Baud KIM-1* compatible, Hi-Speed 1500 Baud)
 - Full duplex 20mA Teletype Interface
 - System Expansion Bus Interface
 - TV Controller Board Interface
 - CRT Compatible Interface (RS-232)
- APPLICATION PORT: 15 Bi-directional TTL Lines for user applications with expansion capability for added lines
- EXPANSION PORT FOR ADD-ON MODULES (51 I/O Lines included in the basic system)
- SEPARATE POWER SUPPLY connector for easy disconnect of the d-c power
- AUDIBLE RESPONSE KEYPAD

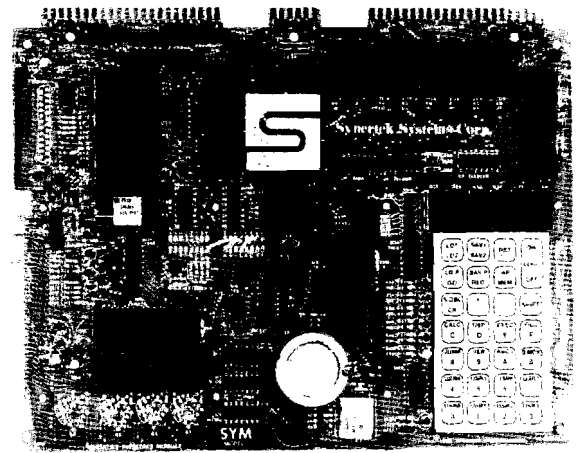

Synertek has enhanced KIM-1* software as well as the hardware. The software has simplified the user interface. The basic SYM-1 system is programmed in machine language. Monitor status is easily accessible, and the monitor gives the keypad user the same full functional capability of the TTY user. The SYM-1 has everything the KIM-1* has to offer, plus so much more that we cannot begin to tell you here. So, if you want to know more, the SYM-1 User Manual is available, separately.

SYM-1 Complete w/manuals	\$269.00
SYM-1 User Manual Only	7.00
SYM-1 Expansion Kit	75.00

Expansion includes 3K of 2114 RAM chips and 1-6522 I/O chip.

SYM-1 Manuals: The well organized documentation package is complete and easy-to-understand.

SYM-1 CAN GROW AS YOU GROW. Its the system to BUILD-ON. Expansion features that are soon to be offered:

*BAS-1 8K Basic ROM (Microsoft)	\$159.00
*KTM-2 TV Interface Board	349.00

*We do honor Synertek discount coupons

QUALITY EXPANSION BOARDS DESIGNED SPECIFICALLY FOR KIM-1, SYM-1 & AIM 65

These boards are set up for use with a regulated power supply such as the one below, but, provisions have been made so that you can add onboard regulators for use with an unregulated power supply. But, because of unreliability, we do not recommend the use of onboard regulators. All I.C.'s are socketed for ease of maintenance. All boards carry full 90-day warranty.

All products that we manufacture are designed to meet or exceed industrial standards. All components are first quality and meet full manufacturer's specifications. All this and an extended burn-in is done to reduce the normal percentage of field failures by up to 75%. To you, this means the chance of inconvenience and lost time due to a failure is very rare; but, if it should happen, we guarantee a turn-around time of less than forty-eight hours for repair.

Our money back guarantee: If, for any reason you wish to return any board that you have purchased directly from us within ten (10) days after receipt, complete, in original condition, and in original shipping carton; we will give you a complete credit or refund less a \$10.00 restocking charge per board.

VAK-1 8-SLOT MOTHERBOARD

This motherboard uses the KIM-4* bus structure. It provides eight (8) expansion board sockets with rigid card cage. Separate jacks for audio cassette, TTY and power supply are provided. Fully buffered bus.

VAK-1 Motherboard **\$129.00**

VAK-2/4 16K STATIC RAM BOARD

This board using 2114 RAMs is configured in two (2) separately addressable 8K blocks with individual write-protect switches.

VAK-2 16K RAM Board with only **\$239.00**

8K of RAM (1/2 populated)

VAK-3 Complete set of chips to **\$175.00**

expand above board to 16K

VAK-4 Fully populated 16K RAM **\$379.00**

VAK-5 2708 EPROM PROGRAMMER

This board requires a +5 VDC and +12 VDC, but has a DC to DC

multiplier so there is no need for an additional power supply. All software is resident in on-board ROM, and has a zero-insertion socket.

VAK-5 2708 EPROM Programmer **\$269.00**

VAK-6 EPROM BOARD

This board will hold 8K of 2708 or 2758, or 16K of 2716 or 2516 EPROMs. EPROMs not included.

VAK-6 EPROM Board **\$129.00**

VAK-7 COMPLETE FLOPPY-DISK SYSTEM (May '79)

VAK-8 PROTOTYPING BOARD

This board allows you to create your own interfaces to plug into the motherboard. Etched circuitry is provided for regulators, address and data bus drivers; with a large area for either wire-wrapped or soldered IC circuitry.

VAK-8 Prototyping Board **\$49.00**

POWER SUPPLIES

ALL POWER SUPPLIES are totally enclosed with grounded enclosures for safety, AC power cord, and carry a full 2-year warranty.

FULL SYSTEM POWER SUPPLY

This power supply will handle a microcomputer and up to 65K of our VAK-4 RAM. ADDITIONAL FEATURES ARE: Over voltage Protection on 5 volts, fused, AC on/off switch. Equivalent to units selling for \$225.00 or more.

Provides +5 VDC @ 10 Amps & ±12 VDC @ 1 Amp

VAK-EPS Power Supply **\$125.00**

*KIM is a product of MOS Technology

KIM-1* Custom P.S. provides 5 VDC @ 1.2 Amps

and +12 VDC @ .1 Amps

KCP-1 Power Supply **\$41.50**

SYM-1 Custom P.S. provides 5 VDC @ 1.4 Amps

VCP-1 Power Supply **\$41.50**



ENTERPRISES
INCORPORATED

2967 W Fairmount Avenue
Phoenix AZ 85017
(602)265-7564



Time of Day Clock and Calendar for the SYM-1

Casmir J. Suchyta, III
and Paul W. Zitzewitz
Univ. of Michigan, Dearborn
4901 Evergreen Road
Dearborn, MI 48128

Now you can have a Clock and Calander running in your SYM at the same time you are running programs in BASIC. The concepts presented can be easily generaliz-ed into other 'multi-task' operations.

Here is a machine language subroutine for the SYM-1 BASIC which keeps track of time and date while allowing BASIC programs to be run.

A useful adjunct to a microcomputer, especially one used in a system, is a continuously running clock which can be used to record the time at which events occur or to generate signals at specified times. The SYM-1 includes timers on the 6522 VIA chips which make implementation of such a clock easy. The clock can be started, set, and read from BASIC.

The clock is based on the use of the 6522 to generate a train of accurately spaced interrupts. The April, 1979, issue of MICRO contained an article by John Gieryc (page 31) which presented the techniques of setting up and servicing the interrupts. The clock is an adaptation of those techniques. The program consists of sections which set the clock, initialize the interrupt, service the interrupt, and update the clock. The clock-calendar needs to be reset only on February 29!

The program is loaded into the highest bytes of available memory. On a 4K machine this is \$0F54-\$0FFF. After the program is loaded, BASIC is initialized with Memory Size set at 3920 to avoid overwriting the program. The clock is set and started by the command PRINT USR(3924,M,d,h,m), where the four parameters represent the month, date,

hour, and minute, respectively. The program stores the times, then initializes the interrupt and starts the timer as described in MICRO 11:31. The timer located at \$ACxx was used to avoid interference with the cassette tape routines. Once every 1/20 second an interrupt occurs which is serviced in the routines starting at \$0F90. Accumulator and registers are pushed on to the stack, then the 1/20 of seconds, seconds, minutes, and hours are incremented as needed. These four updates are done in an indexed loop, using a table of comparison values (20 fractions, 60 seconds, 60 minutes, 24 hours) stored at \$0FE9 to see if the next timing unit should be incremented. The days and months cannot be incremented in the same loop, and so are done in the routines starting at \$0FBD. There is a comparison table giving the number of days (plus one) in each month starting at \$0FF4 used to determine if the month should be incremented. When all needed increments are made the flag is cleared and the saved registers pulled back from the stack.

The clock may be read from BASIC by PEEKing at the appropriate storage locations. To print the date and time in the form 7/20/1979 17:45:02 execute the command PRINT PEEK(4083)"/" PEEK(4082)"/"/1979 "PEEK(4081)":"PEEK(4080)":"PEEK(4079). The number of the month in the date can be replaced by a three letter abbreviation by using the following short program to print the date.

```
1 A$ = "JANFEBMARAPRPMAYJUN-
JUL AUG SEPOCTNOVDEC"
2 MO = 1 + 3*(PEEK(4083) - 1)
3 PRINT
MID$(A$,MO,3);PEEK(4082);"/",1979"
```

Starting each program with this routine will let you know exactly when you did each job. Another use of the clock is to serve as an alarm clock. You may want the SYM to turn on a light, or start an experiment at a certain time. To do this include a tight loop which includes an IF statement comparing one or more of the storage locations with the desired time. When the comparison is good, the loop will be exited and the computer can execute the command.

```
." F54-FFF
CF54 3C FF CF 68 3D F1 0E 63 E3
CF5C 68 8D F2 0F 63 63 3D F3 2F
CF64 0F 63 2E 36 8E A9 9C 3D 9C
CF6C 7E A6 A9 0F 3D 7F A6 A9 D3
CF74 C0 3D 0E AC AD 2D AC 29 69
CF7C 0F 9D 0D AC A9 C0 3D 0B 6F
CF84 AC A9 5E 8D 06 AC A9 C3 BF
CF8C 3D 05 AC 6E 03 48 8A 48 7F
CF94 95 43 D3 A9 00 A9 2E 99 19
CF9C ED 0F C8 C0 05 F0 1A 18 C4
CFA4 B9 ED 0F 69 01 D9 E8 0F B3
CFAC F0 EB 99 ED 0F A9 C3 9D 1C
CFB4 07 AC 68 A8 68 AA 68 28 81
CFBC 40 18 AD F2 0F 69 21 AE 9F
CFC4 F3 0F DD F3 0F F0 06 9D 03
CFC C F2 0F 4C B1 0F A9 21 9D 47
CFDA F2 0F F3 ED 0F F0 06 8E A1
CFDC F3 0F 4C B1 0F A2 01 3E E0
CFEA F3 0F 4C B1 0F 14 3C 3C 7A
CFEC 18 00 05 1E 34 0E 1E 05 11
CFF4 20 1D 28 1F 20 1F 20 20 C0
CFFC 1F 20 1F 20 3A
493A
```

Listing: Time-of-Day Clock and Calendar

ORG \$0F54
 MIN * \$0FF0
 HR * \$0FF1
 DAY * \$0FF2
 MON * \$0FF3
 COMP * \$0FFD
 ACCESS * \$8B86

OF54 8C F0 OF Setime
 OF57 68
 OF58 8D F1 OF
 OF5B 68
 OF5C 68
 OF5D 8D F2 OF
 OF60 68
 OF61 68
 OF62 8D F3 OF
 OF65 68
 OF66 20 86 8B
 OF69 A9 90
 OF6B 8D 7E A6
 OF6E A9 OF
 OF70 8D 7F A6
 OF73 A9 C0
 OF75 8D 0E AC
 OF78 AD 0D AC
 OF7B 29 BF
 OF7D 8D 0D AC
 OF80 A9 C0
 OF82 8D 0B AC
 OF85 A9 50
 OF87 8D 06 AC
 OF8A A9 C3
 OF8C 8D 05 AC
 OF8F 60
 OF90 08 Intprt
 OF91 48
 OF92 8A
 OF93 48
 OF94 48
 OF95 48
 OF96 D8 INCR
 OF97 A0 00
 OF99 A9 00 LOOP
 OF9B 99 ED OF
 OF9E C8
 OF9F C0 05
 OFA1 F0 1A
 OFA3 18
 OFA4 B9 ED OF
 OFA7 69 01
 OFA9 D9 E8 OF
 OFAC F0 EB
 OFAE 99 ED OF
 OFB1 A9 C3 RETN
 OFB3 8D 07 AC
 OFB6 68
 OFB7 A8
 OFB8 68
 OFB9 AA
 OFBA 68
 OFBB 28
 OFBC 40
 OFBD 18 ADDAY
 OFBE AD F2 OF
 OFC1 69 01
 OFC3 AE F3 OF
 OFC6 DD F3 OF
 OFC9 F0 06
 OFCB 8D F2 OF
 OFCE 4C B1 OF
 OFD1 A9 01 REDAY
 OFD3 8D F2 OF
 OFD6 E8
 OFD7 E0 0D
 OFD9 F0 06
 OFDB 8E F3 OF
 OFDE 4C B1 OF
 OFE1 A2 01 END
 OFE3 8E F3 OF
 OFE6 4C B1 OF

STY MIN Stores minutes
 PLA Pulls hours
 STA HR and stores
 PLA Pulls Day
 and stores
 STA DAY Pulls month
 PLA and stores
 STA MON Clears stack
 PLA
 JSR ACCESS Unwrite protect the system RAM
 LDA1m \$90 Store low
 STA \$A67E byte IRQ
 LDA1m \$0F Store high
 STA \$A67F byte IRQ
 LDA1m \$C0 Set
 STA \$AC0E IER
 LDA \$AC0D Set
 AND \$BF
 STA \$AC0D IFR
 LDA1m \$C0 Set
 STA \$AC0B ACR
 LDA1m \$50 Set
 STA \$AC06 and
 LDA1m \$C3 start
 STA \$AC05 timer
 RTS return
 PHP Push processor
 PHA Accum
 TXA
 PHA X reg
 TYA
 PHA Y reg
 CLD Clear dec flag
 LDY1m \$00 Zero Y
 LDA1m \$00 A
 STAY COMP Zeros counter
 INY To next counter
 CPY1m \$05 Need new day?
 BEQ ADDAY Go to it
 CLC Clear carry
 LDAY COMP Get counter value
 ADC1m \$01 increment
 CMPY HIGH-1 Comp with highest
 BEQ LOOP Go to zero and carry to next
 STAY COMP Store new value
 LDA1m \$C3 Finished; clear
 STA \$AC07 interrupt flag
 PLA Restore
 TAY Y reg
 PLA
 TAX X reg
 PLA Accum
 PLP Processor
 RTI Leave
 CLC Clear carry
 LDA DAY Get day
 ADC1m \$01 increment
 LDY MON Put month in x reg
 CMPx MON See if at last day
 BEQ REDAY Yes, go to month change
 STA DAY Save new day
 JMP RETN Leave
 LDA1m \$01 Back to day one!
 STA DAY Save
 INX To next month
 CPX \$0D At end of year (13)?
 BEQ END Go to reset year
 STX MON Save new month
 JMP RETN Leave
 LDX1m \$01 Back to January (1)
 STX MON Save
 JMP RETN Leave

OFE9 14 3C 3C HIGH
 OFEC 18 00 00
 OFEF 00 00 00
 OFF2 00 00
 OFF4 20 1D 20
 OFF7 1F 20 1F
 OFFA 20 20 1F
 OFFD 20 1F 20

Table of highest values of fractions, seconds, minutes, hours, (dummy) followed by storage area for fractions, seconds, minutes, hours, days, months
 Table of max days in each month (plus one) for the twelve months.

Classified Ads

KIM 65 NEWSLETTER
 Six bimonthly issues for \$5.00 in U.S. and Can. (\$12.00 elsewhere)
 The Target, c/o Donald Clem
 RR no. 2
 Spencerville, Ohio 45887

DATA ENCRYPTION FOR SUPERBOARD II—Powerfully, secure algorithm, fast and efficient. Video and/or UART I/O. Easy to use software system available on high quality cassette tape. \$21.95 includes detailed instruction manual.
 D. WOLF, Ph.D.
 15 Princess Road
 London, NW1 England

SYM-1 OWNERS—SYM/KIM Appendix to First Book of KIM details changes to KIM games run on BASIC SYM-1. Changes shown line by line, load, modify, and run. Appendix only \$4.25. First Book of KIM \$9, combo both \$12.50 postpaid. California residents please add 6 per cent sales tax. Order from:
 Robert A. Peck
 P.O. Box 2231
 Sunnyvale, CA 94087

PET MACHINE LANGUAGE GUIDE comprehensive manual to aid the machine language programmer. More than 30 routines are fully detailed so that the reader can put them to use immediately. Specify old or new ROMS. \$6.95 plus .75 for postage. Visa or Mastercard accepted. Money back guarantee (10 days). Contact:
 ABACUS SOFTWARE
 P.O. Box 7211
 Grand Rapids, MI 49510

NEW BOWLING PROGRAM FOR APPLE. One to four players compete in a standard bowling game. Challenging game with excellent quality AP-PLESOFT program. Cassette \$9.95. Order from:
 C.E. Howerton
 125 Marcella Road
 Hampton, VA 23666

Computers in Psychiatry/Psychology. Bimonthly newsletter. Diagnosis, testing, research, office management, therapy, bibliography, program library. \$25. Institutions, Libraries. Outside U.S. \$15 Vol. 2 (current), \$15 Vol. 1; Canada & Hawaii \$20. Contact:
 Box Z
 26 Trumbull St.
 New Haven, CT 06511

MICRO

APPLE II Speed Typing Test With Input Time Clock

John Broderick, CPA
8635 Shagrock
Dallas, TX 75238

**So, you think you are a pretty fast typist! Care to take a
Speed Typing Test on your APPLE?**

The quick brown fox jumped over...

The speed typing test is a must for all APPLEiers, like myself, who consider themselves expert typists. However, I did not set out to write a typing test, but to make an input subroutine (GOSUB 8400) which puts the user under the pressure of a time clock.

Try the program below:

2000 call-936:

2010 VV = 10: rem set VTAB

2020 TT = 1: rem set TAB

2030 GOSUB 8400

2040 GOTO 2000

You should hear and see the time at the bottom of the screen with the seconds and tenths of seconds flying by as you type in an alpha-numeric string.

Subroutine 8400 reads the keyboard in line 8434 with K equal to the ASCII number. Line 8447 subtracts 159 from ASCII so that now K is equal to the position of the equivalent character in string A\$ (line 8406). So you can see that we are slowly building up two words in W\$ at line 8447 by adding, to the end of string W\$, the next letter coming in on the keyboard until the ASCII equivalent of carriage return (141) is detected at line 8444.

Now when the princess falls into the snake pit, if she doesn't make the right decision fast enough the snakes will probably get her.

```

WRITTEN BY JOHN BRODERICK
DALLAS, TEXAS
14 REM JUNE 21, 1979
SUBROUTINE 8400 IS A SELF
CONTAINED INPUT TIME CLOCK

16 REM DEFINE VV=VTAB & TT=TAB
THEN GOSUB8400-THIS DOES THE
SAME AS AN ORDINARY INPUT W$

20 REM COPYWRITED-CAN NOT BE SOLD
BUT CAN BE GIVEN AWAY
40 DIM TYPES$(250): CALL -936: POKE
33,36
80 INPUT "DO YOU WISH TO MAKE UP YO
UR OWN TEST SENTENCE Y/N ? "
,TYPES
84 IF TYPES#"Y" THEN 90: PRINT
: PRINT "ENTER TEST SENTENCE NOW
": PRINT : PRINT : INPUT TYPES$
: GOTO 100
90 TYPES="NOW IS THE TIME FOR ALL G
OOD MEN TO COME TO THE AID OF TH
EIR COUNTRY."
100 CALL -936: PRINT :ERR=0: PRINT
"YOU ARE TAKING A SPEED TYPING T
EST"
120 PRINT : PRINT "TYPE THE NEXT SEN
TENCE APPEARING ON THE SCREEN A
S FAST AS YOU CAN"
130 FOR I=1 TO 4000: NEXT I: REM

135 REM --- BODY OF PROGRAM ---
140 CALL -936:ERR=0
150 VV=13: REM SET SUBROUT VTAB
160 TT=1: REM SET SUBROUT TAB
170 VTAB (9): TAB 1: PRINT TYPES$
: GOSUB 8400
180 VTAB (16): TAB 1
200 IF W$=TYPES$ THEN 510: REM

204 REM COMPUTE ERRORS 210-410
210 FOR I= LEN(W$) TO LEN(TYPES$
):W$(I+1)=BS(1,1): NEXT I
220 FOR I=1 TO LEN(TYPES): IF I>
LEN(W$) THEN ERR=ERR+1: IF
I>LEN(W$) THEN NEXT I
230 IF W$(I,I)#TYPES(I,I) THEN
ERR=ERR+1: NEXT I
400 PRINT : PRINT : CALL -198: PRINT
" ";ERR;" ERRORS HIT RETU
RN": GOTO 520

410 CALL -198: PRINT " ";ERR;" ERRO
RS";" HIT RETURN"
500 REM - COMPUTE WPM
501 T=(X*23)+J:L= LEN(TYPES): IF
L<1 THEN 520
502 L=L-(ERR*6): IF L<0 THEN GOTO
506
503 WPM=(L*12*20)/T
506 VTAB (24): TAB 30: PRINT WPM;
" WPM": VTAB (16): TAB 1: RETURN

510 PRINT " CORRECT - HIT RETURN"
: PRINT : PRINT : PRINT :
520 GOSUB 500: INPUT W$:WPM=0: GOTO
140: REM

8400 REM -SUBROUTINE TO INPUT VIA
KEYBOARD TO RETAIN AND
INPUT WORD IN W$
8405 IF SWITCH=1 THEN 8407:SWITCH=
1: DIM W$(255),A$(70),BS(2)
:BS=" "
8406 A$=" #$$&'()*+,-./0123456789:;
'=?@ABCDEFGHIJKLMNPOQRSTUVWXYZ
/m "
8407 Y=T: POKE -16336,0:W$=" ":
X=0:J=0
8410 FOR U=1 TO 250
8412 REM USER AREA HERE X=SECONDS
SO USER CAN TEST X LIKE
IF X=12 THEN RETURN
8430 J=J+1: IF J<23 THEN 8434:X=
X+1:J=0
8431 FOR BB=1 TO 3:KK= PEEK (-16336
)- PEEK (-16336): NEXT BB: GOTO
8434
8434 VTAB (24): TAB 13:U=U-1: PRINT
X;". ";J*10/23;" SECONDS";:
K= PEEK (-16384)
8437 IF K#136 THEN 8444:Y=Y-1
8438 VTAB (VV): TAB TT+Y-1: PRINT
BS(1,1)
8440 W$(1)=W$(1, LEN(W$)-1)
8441 VTAB (13): TAB 1: PRINT W$
8442 POKE -16368,0: NEXT U
8444 IF K=141 THEN 8540: IF K<160
THEN NEXT U
8447 K=K-159:W$(Y)=AS(K,K)
8461 POKE -16368,0: VTAB (VV): TAB
TT: PRINT W$:Y=Y+1: NEXT U
8540 Y=1: CALL -756: RETURN

```

Instant Software, the Best Value

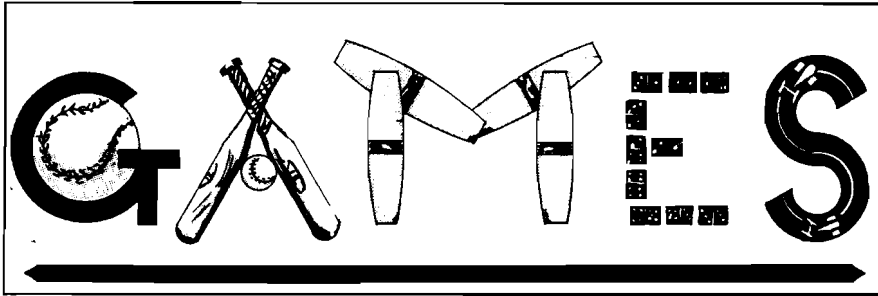

We have it all—conflict simulation, games of chance, fast-paced fun. We have a package of good times for every taste.

TREK-X Command the Enterprise as you scour the quadrant for enemy warships. This package not only has superb graphics, but also includes programming for optional sound effects. A one-player game for the PET 8K. **Order No. 0032P \$7.95.**

GOLF Without leaving the comfort of your chair, you can enjoy a computerized 18 holes of golf with a complete choice of clubs and shooting angles. You need never cancel this game because of rain. One or two players can enjoy this game on the Apple with Applesoft II and 20K. **Order No. 0018A \$7.95.**

BOWLING/TRIOLOGY Enjoy two of America's favorite games transformed into programs for your Apple:

- **Bowling**—Up to four players can bowl while the Apple sets up the pins and keeps score. Requires Applesoft II.
 - **Trilogy**—This program can be anything from a simple game of tic-tac-toe to an exercise in deductive logic. For one player.
- This fun-filled package requires an Apple with 20K. **Order No. 0040A \$7.95.**

TANGLE/SUPERTRAP These two programs require fast reflexes and a good eye for angles:

- **Tangle**—Make your opponent crash his line into an obstacle.
- **Supertrap**—This program is an advanced version of Tangle with many user control options. Enjoy these exciting and graphically beautiful programs. For one or two players with an 8K PET. **Order No. 0029P \$7.95.**

CHECKERS/BACCARAT Play two old favorites with your PET.

- **Checkers**—Let your PET be your ever-ready opponent in this computer-based checkers program.
- **Baccarat**—You have both Casino- and Blackjack-style games in this realistic program. Your PET with 8K will offer challenging play anytime you want. **Order No. 0022P \$7.95.**

CASINO I These two programs are so good, you can use them to check out and debug your own gambling system!

- **Roulette**—Pick your number and place your bet with the computer version of this casino game. For one player.
- **Blackjack**—Try out this version of the popular card game before you go out and risk your money on your own "surefire" system. For one player. This package requires a PET with 8K. **Order No. 0014P \$7.95.**

CASINO II This craps program is so good, it's the next best thing to being in Las Vegas or Atlantic City. It will not only play the game with you, but will also teach you how to play the odds and make the best bets. A one-player game, it requires a PET 8K. **Order No. 0015P \$7.95.**

TURF AND TARGET Whether on the field or in the air, you'll have fun with the Turf and Target package. Included are:

- **Quarterback**—You're the quarterback as you try to get the pigskin over the goal line. You can pass, punt, hand off, and see the result of your play with the PET's superb graphics.
- **Soccer II**—Play the fast-action game of soccer with four playing options. The computer can play itself or a single player; two can play with computer assistance, or two can play without help.
- **Shoot**—You're the hunter as you try to shoot the bird out of the air. The PET will keep score.
- **Target**—Use the numeric keypad to shoot your puck into the home position as fast as you can. To run and score, all you'll need is a PET with 8K. **Order No. 0097P \$7.95.**

DUNGEON OF DEATH Battle evil demons, cast magic spells, and accumulate great wealth as you search for the Holy Grail. You'll have to descend into the Dungeon of Death and grope through the suffocating darkness. If you survive, glory and treasure are yours. For the PET 8K. **Order No. 0064P \$7.95.**

PET DEMO I You can give yourself, your family, and your friends hours of fun and excitement with this gem of a package.

- **Slot Machine**—You won't be able to resist the enticing messages from this computerized one-armed bandit.
 - **Chase**—You must find the black piece as you search through the ever-changing maze.
 - **Flying Pheasant**—Try to shoot the flying pheasant on the wind.
 - **Sitting Ducks**—Try to get your archer to shoot as many ducks as possible for a high score.
 - **Craps**—It's Snake Eyes, Little Joe, or Boxcars as you roll the dice and try to make your point.
 - **Gran Prix 2001**—Drivers with experience ranging from novice to professional will enjoy this multi-leveled race game.
 - **Fox and Hounds**—It's you against the computer as your four hounds try to capture the computer's fox.
- For true excitement, you'll need a PET 8K. **Order No. 0035P \$7.95.**

PENNY ARCADE Enjoy this fun-filled package that's as much fun as a real penny arcade—at a fraction of the cost!

- **Poetry**—Compose free verse poetry on your computer.
 - **Trap**—Control two moving lines at once and test your coordination.
 - **Poker**—Play five-card draw poker and let your PET deal and keep score.
 - **Solitaire**—Don't bother to deal, let your PET handle the cards in this "old favorite" card game.
 - **Eat-Em-Ups**—Find out how many stars your Gobbler can eat up before the game is over.
- These six programs require the PET with 8K. **Order No. 0044P \$7.95.**

MIMIC Test your memory and reflexes with the five different versions of this game. You must match the sequence and location of signals displayed by your PET. This one-player program includes optional sound effects with the PET 8K. **Order No. 0039P \$7.95.**

MIMIC (see description for the PET version 0039P) This package requires the Apple 24K. **Order No. 0025A \$7.95.**

ARCADE I This package combines an exciting outdoor sport with one of America's most popular indoor sports:

- **Kite Fight**—It's a national sport in India. After you and a friend have spent several hours maneuvering your kites across the screen of your PET, you'll know why!
 - **Pinball**—By far the finest use of the PET's exceptional graphics capabilities we've ever seen, and a heck of a lot of fun to boot.
- Requires an 8K PET. **Order No. 0074P \$7.95.**

ARCADE II One challenging memory game and two fast-paced action games make this one package the whole family will enjoy for some time to come. Package includes:

- **UFO**—Catch the elusive UFO before it hits the ground!
 - **Hit**—Better than a skeet shoot. The target remains stationary, but you're moving all over the place.
 - **Blockade**—A two-player game that combines strategy and fast reflexes.
- Requires 8K PET. **Order No. 0045P \$7.95.**



Business

On the bottom line you'll know that our business packages mean better business for you.

ACCOUNTING ASSISTANT This package will help any businessman solve many of those day-to-day financial problems. Included are:

- **Loan Amortization Schedule**—This program will give you a complete breakdown of any loan or investment. All you do is enter the principal amount, interest rate, term of the loan or investment, and the number of payments per year. You see a month-by-month list of the principal, interest, total amount paid, and the remaining balance.
- **Depreciation Schedule**—You can get a depreciation schedule using any one of the following methods: straight line, sum of years-digits, declining balance, units of production, or machine hours. Your computer will display a list of the item's lifespan, the annual depreciation, the accumulated depreciation, and the remaining book value. This package requires the PET 8K. **Order No. 0048P \$7.95.**

ACCOUNTING ASSISTANT (see the description for the PET version 0048P) This package requires the Apple 16K. **Order No. 0088A \$7.95.**



BOX 120
 ALLAMUCHY, N.J. 07820
 201-362-6574

HUDSON DIGITAL ELECTRONICS INC.

THE HDE CARD CAGE

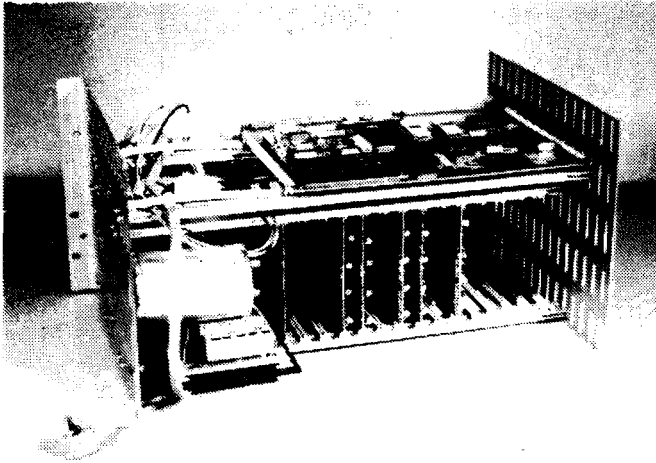

Shown With KIM-1 (not included)

VERSIONS

KIM*	AVAILABLE
AIM*	1st Qtr. 80
SYM*	1st Qtr. 80

\$525.00

Complete With Power Supply

Now you can expand your 65XX single board micro-computer into a powerful microprocessor based system with the 19" (RETMA standard) HDE DM816-CC15 Card Cage. The DM816-CC15 has virtually all of the features you need for even the most demanding situations. Complete with power supply, backplane, card guides and supports, the HDE DM816-CC15 accepts state of the art 4 1/2" wide cards permitting your system to remain a compact configuration, while expanding with a variety of functions.

HDE has developed the DM816-CC15 for the demanding industrial marketplace. Consequently, you can design your KIM*, AIM* or SYM* based installation using RETMA standard cabinet or rack components. Sufficient clearance has been included for custom front panel switches, lights and controls as well as cable and fan installation at the rear. The microcomputer is mounted to permit convection cooling in all but the most densely packed situations.

The self-contained power supply is rated +8 VDC at 12 A and ±16 VDC at 3 A (both unreg.). The backplane, with the standard S44 bus, accepts up to 15 cards and has on board 5VDC and 12VDC regulators. In addition to power on reset, the backplane in-

cludes the logic connectors for remote reset stop and single step as well as cassette and 20 mA loop terminal I/O. Provisions for data and address bus termination are included. Two 16 pin DIP pads are available for unique requirements and the micro-computer application and expansion connectors are extended to the backplane further increasing the utility of the total package.

Other HDE products include:

- 5 1/4" and 8" single/dual disk systems
- 8K static RAM memory
- Prototyping cards
- Software (disk and cassette)
 - Text Editor (TED)
 - Text Output Processing System (TOPS)
 - Assembler (ASM)
 - Comprehensive Memory Test (CMT)
 - Dynamic Debugging Tool (DDT)

Watch for announcements:

EPROM Card, RS232 Card, PIA Card, DAC Card

- * KIM is a Commodore product
- * AIM is a Rockwell International product
- * SYM is a Synertec product

HDE PRODUCTS - BUILT TO BE USED WITH CONFIDENCE

AVAILABLE DIRECT OR FROM THESE FINE DEALERS:

Johnson Computer Plainsman Microsystems
 Box 523 Medina, Ohio 44256 (216) 725-4560
 Box 1712 Auburn, Alabama 36830 (800) 633-8724

ARESCO
 P.O. Box 43 Audubon, Pa. 19407 (215) 631-9052

Long Island Computer General Store
 103 Atlantic Ave. Lynbrook, N.Y. 11563 (516) 887-1500

Lone Star Electronics
 Box 488 Manchaca, Texas 78652 (512) 282-3570

Computer Lab of N.J.
 538 Route 10 Ledgewood, N.J. 07852 (201) 584-0556

SUMTEST: A Memory Test Routine for the 6502

S. Felton Mitchell, Jr.
 c/o The Bit Stop
 P.O. Box 973
 Mobile, AL 36601

No microcomputer is better than its RAM memory. Here is a RAM memory test that can be adapted to any 6502 based system.

SUMTEST is a short (107 byte) machine language program to test memory. The algorithm is not original with me, as I have seen similar routines published for the 8008, 8080, and 6800 microprocessors. I have not, however, seen the SUMTEST algorithm used in a 6502 memory test routine.

SUMTEST will detect all "stuck" bits, and will print the error address and the offending bit pattern. SUMTEST will also detect address sensitive errors, such as the act of writing to hex location 0208 changing the contents of hex location 03BC. The sensitive address errors can result from shortened address lines or interaction of adjacent memory cells within a memory chip. SUMTEST will not detect byte sensitive memory failures (except by accident).

The routine is assembled to reside in the first part of page 01, the stack page for the 6502. The stack page is intentionally used due to the fact that if your 6502 machine is running, at least the few bytes of page 01 used by the

stack are "good." The routine can be relocated elsewhere in memory if you want to test the first part of page 01 where the routine resides. You will not be able to test the top few bytes of page 01 used as stack space by the program, as any modification of the stack area while the routine is running will result in a program bomb.

The program as currently assembled uses KIM output routines. If your machine is not a KIM (as mine is not), then you will have to substitute your system print routines. The print routines are defined at the beginning of the listing supplied.

The algorithm used calculates a data byte to store each memory location

```

SYMBOL TABLE 3000 3096
BGNADH 0081   BGNADL 0080   CMPADL 0161   COUNTR 0084
CRLF  1E2F   ENDADH 0083   ENDADL 0082   ERROR  012B
INCPTR 015B  INIT  0100   LOOPA  0108   LOOPB  0115
ONCE  0121   OUTCH  1EA0   OUTSP  1E9E   PRBYT  1E3B
RETURN 011C  RTN   016B   SETEM  014A   SUMTST 0100
SUMUM  0153  TEST  0103   TMPADH 0086   TMPADL 0085
TMPY   0087
  
```

Figure 1

```

SYMBOL TABLE 3000 3096
BGNADL 0080   BGNADH 0081   ENDADL 0082   ENDADH 0083
COUNTR 0084   TMPADL 0085   TMPADH 0086   TMPY   0087
INIT  0100   SUMTST 0100   TEST  0103   LOOPA  0108
LOOPB  0115  RETURN 011C  ONCE  0121   ERROR  012B
SETEM  014A  SUMUM  0153  INCPTR 015B  CMPADL 0161
RTN   016B  CRLF  1E2F   PRBYT  1E3B  OUTSP  1E9E
OUTCH  1EA0
  
```

Figure 2

Listing 1

to be tested by adding the high order address and the low address of each location to a "counter" byte. After all locations to be tested have been filled with their calculated data byte, the routine then recalculates the data byte that should be stored in each location and checks it against the actual contents of the location. If the data in memory is different from the calculated value, then the location and offending bit pattern are printed. As previously mentioned, there can be differences due to "stuck" bits or interaction of memory locations. Each time that the routine is successfully executed, it will print a "plus" on the system terminal. To completely test the memory (adding all 256 possible "counter" byte combinations to the address), it is necessary to have 256 "plusses" printed on your terminal. The program listing is exhaustively commented and should be pretty much self explanatory for even a novice machine language programmer.

To test 4K of memory occupying hex locations 200 to 2FFF, enter 00 at 0080, 20 at 0081, 00 at 0082, and 30 at 0083 (end address plus 1) and run at 0010. If no errors are detected, you will get a string of plusses on your terminal. Remember that 256 plusses are required to complete the test. An example of an error would be a carriage return line feed on the terminal, a four digit address (in hex), a space and a two digit number. The two digit number represents the bad bit pattern. Now convert the "bad bit" pattern to its binary equivalent. Each "1" in the binary pattern represents a bad bit at the memory location printed. If 23A840 was printed on your terminal, it would mean that bit 6 was bad at location 23A8. By reference to the memory board documentation, you should be able to determine which chip on the board is faulty.

An interesting observation was made during the development of the program. My machine is a homebrew S100 bus, dual processor system. I have a 6502 and a 6800 on an S100 prototype board, each sharing all of the system except for a little PROM which is unique for each microprocessor. The system clock is derived from the clock generator in the 6502 (1MHz.). An equivalent SUMTEST program for the 6800 would cycle through my 24K of memory with no errors detected. The 6502 SUMTEST program would consistently catch several bad bytes. Apparently there is a few nanosecond's difference in the timing of the two microprocessors, and that was just enough for some of the memory to fail. All of the memory that tested bad on the 6502 was purchased from one vendor as 450 nanosecond memory. So be aware that a few nanoseconds can make a big difference, and purchase your memory from a reputable supplier.

```

0100      SUMTST ORG  $0100  ASSEMBLE IN STACK PAGE
      REMEMBER THAT THE ROUTINE DESTROYS THE CONTENTS OF
      THE MEMORY TESTED.
0100      BGNADL .    $0080  START ADDRESS OF MEMORY TO BE
      TESTED
0100      BGNADH .    $0081
0100      ENDADL .    $0082  END ADDRESS &1 OF MEMORY TO BE
      TESTED
0100      ENDADH .    $0083
0100      COUNTR .    $0084  COUNTER AND SEED FOR TEST
0100      TMPADL .    $0085  WORKING ADDRESS POINTER
0100      TMPADH .    $0086
0100      TMPY .      $0087  TEMPORARY STORAGE OF Y

      KIM ROM ROUTINES USED
0100      CRLF .      $1E2F  CARRIAGE RETURN - LINE FEED
0100      OUTCH .     $1EA0  OUTPUT ASCII CHARACTER
0100      PRIBYT .    $1E3B  PRINT 1 HEX BYTE AS TWO ASCII
0100      OUTSP .     $1E9E  OUTPUT BLANK

```

```

0100 20 2F 1E INIT JSR CRLF PRINT CR/LF
0103 A0 00 TEST LDYIM $00 INITIALIZE INDEX REGISTER
0105 20 4A 01 JSR SETEM CREATE WORKING ADDRESS POINTER
0108 20 53 01 LOOPA JSR SUMUM CALCULATE TEST DATA BYTE
010B 91 85 STAIY TMPADL STORE THE TEST BYTE
010D 20 5B 01 JSR INCPTR INCREMENT THE WORKING POINTER
0110 D0 F6 BNE LOOPA MORE TO BE TESTED?
0112 20 4A 01 JSR SETEM REINITIALIZE WORKING POINTER
0115 20 53 01 LOOPB JSR SUMUM RECALCULATE THE TEST DATA BYTE
0118 51 85 EOR1Y TMPADL CHECK MEMORY WITH CALCULATED
      TEST BYTE
011A D0 0F BNE ERROR GO TELL IF TEST FAILED
011C 20 5B 01 RETURN JSR INCPTR INCREMENT THE WORKING POINTER
011F D0 F4 BNE LOOPB MORE TO BE TESTED?
0121 A9 2B ONCE LDAIM '& PRINT A "PLUS" TO INDICATE
      SUCCESS
0123 20 A0 1E JSR OUTCH PRINT ASCII
0126 E6 84 INC COUNTR SET UP NEW PATTERN
0128 4C 03 01 JMP TEST TEST UNTIL MANUAL RESET
012B 84 87 ERROR STY TMPY SAVE Y
012D 48 PHA SAVE THE BAD BIT PATTERN
012E 20 2F 1E JSR CRLF PRINT CR/LF
0131 A5 86 LDA TMPADH GET HIGH ADDRESS OF ERROR
0133 20 3B 1E JSR PRIBYT PRINT IT
0136 A5 85 LDA TMPADL GET LOW ADDRESS OF ERROR
0138 20 3B 1E JSR PRIBYT PRINT IT
013B 20 9E 1E JSR OUTSP PRINT A SPACE
013E 68 PLA RESTORE THE BAD BIT PATTERN
013F 20 3B 1E JSR PRIBYT PRINT IT
0142 20 2F 1E JSR CRLF PRINT A CR/LF
0145 AA 87 LDY TMPY RESTORE Y
0147 4C 1C 01 JMP RETURN CONTINUE WITH THE TEST

```

SUBROUTINES

```

014A A5 80 SETEM LDA BGNADL GET BEGINNING ADL
014C 85 85 STA TMPADL MAKE A COPY
014E A5 81 LDA BGNADH GET BEGINNING ADH
0150 85 86 STA TMPADH MAKE A COPY
0152 60 RTS

0153 18 SUMUM CLC GET READY TO ADD
0154 A5 86 LDA TMPADH GET WORKING POINTER ADH
0156 65 85 ADC TMPADL ADD IN WORKING POINTER ADL
0158 65 84 ADC COUNTR ADD IN COUNTER
015A 60 RTS RETURN WITH CALCULATED TEST DATA BYTE
      IN A REGISTER

015B E6 85 INCPTR INC TMPADL INCREMENT WORK POINTER ADL
015D D0 02 BNE CMPADL PAGE NOT CROSSED
015F E6 86 INC TMPADH INCREMENT WORK POINTER ADH
0161 A5 85 CMPADL LDA TMPADL GET ADL OF WORK POINTER
0163 C5 82 CMP ENDADL SEE IF END OF MEMORY TO BE
      TESTED
0165 D0 04 BNE RTN RETURN IF NO MATCH
0167 A5 86 LDA TMPADH GET ADH OF END OF MEMORY TO BE
      TESTED
0169 C5 83 CMP ENDADH SEE IF ADH'S MATCH
016B 60 RTN RETURN WITH RESULTS OF CMP IN Z FLAG

```

The MICRO Software Catalogue: XV

Mike Rowe
P.O. Box 6502
Chelmsford, MA 01824

Name: **Mother Goose Rhymes**
System: **APPLE II**
Memory: **16K**
Language: **Integer BASIC and Machine Language**

Description: Children who love Mother Goose Rhymes will have fun with this interactive program using missing words. The program enjoyably guides children towards reading mastery.

Copies: **Just Released**
Price: **\$9.95** for cassette
Includes: **Cassette and loading instructions**
Author: **George Earl**
Available from:

George Earl
1302 S. Gen. McMullen Dr.
San Antonio, TX 78237

Name: **SYM/KIM Appendix**
System: **SYM-1**
Memory: **1K**
Monitor Version:
1.0 or 1.1 — works with both
Language: **Machine Language**
Hardware: **SYM-1 alone, no additions or expansion memory required**

Description: This appendix is used as a supplement to the "First Book of Kim" (pub. by Hayden Books). It takes the entire recreational program section of the FBOK and provides the user with detailed changes to each program to allow them to run on an unmodified 1K SYM-1. The user is assumed to have access to the FBOK since only the changes are detailed in the appendix (along with explanations as needed). The basic goal of the appendix was to allow the purchaser of the most basic (1K) SYM to have some beginning software. Since the instructions indicate 'load the KIM program, modify parts as follows... then run', one might consider purchasing KIM games tapes and loading them using the KIM format load available on the SYM-1. Then he could modify the program and redump it for his own personal use later, using the SYM format. The modification techniques used in the appendix can also be used to convert other KIM programs for use on the SYM-1.

Copies: **20 delivered (as of 10/79) more available**
Price: **\$4.25**, First Class postpaid — Appendix only
\$9.00, First Book of Kim, separately
\$12.50, combo First Book of Kim and Appendix (FBOK and combo delivered 4th class or add \$2.00 for first class. Cal. residents add 6% sales tax.

Available from Author:
Robert A. Peck
P.O. Box 2231
Sunnyvale, CA 94087

Name: **PET Quick Reference Card**
System: **PET**
Memory: **4K, 8K, 16K, and 32K**
Language: **English**
Hardware: **None**

Description: A complete summary of the Commodore PET BASIC language along with examples and definitions of every command. Also on the card is a table of the PET's graphic characters with their hexadecimal equivalents. Machine language programmers will find a table of important memory locations (for all model PETs), as well as information on the user port, PET sound, and the IEEE—488 interface bus. The information that PET owners used to have to hunt for in several books and magazines is now in one quick, convenient place!

Copies: **Just released**
Price: **\$3.50** postpaid
Available from: **Leading Edge Computer Products**
P.O. Box 3872
Torrance, CA 90510

Name: **Dakin5 Programming Aids**
System: **APPLE II**
Memory: **48K**
Language: **Assembler/Applesoft II**
Hardware: **APPLE II, 2 Disk II's, and printer**

Description: Set of seven programs: 1) Lister — prints BASIC programs using full line capacity of printer. Peeker — displays or prints all or selected records from a text file. 3) Cruncher — removes REM statements and compresses code in Applesoft programs. 4) Text File Copy — copies a particular text file from one diskette to another. 5) Prompter — data entry subroutine that handles both string and numeric data. Options for using commas, decimal points, and leading zeros, with right-justified numerics. Alphanumeric data is left-justified with trailing spaces added as required. Maximum field length can be specified to prevent overflow in both numeric and alphanumeric fields. 6) Calculator — an addition/subtraction subroutine that handles numeric string data. Written in Assembler code, and using twenty place accuracy, it functions 40 times faster than if written in an equivalent BASIC subroutine. 7) Diskette Copy — formats an output disk, copies each track, and verifies that the output matches the input.

Copies: **Just released**
Price: **\$39.95**
Includes: **35 page documentation and program diskette**
Author: **Dakin5 Corporation** (developer of The Controller for Apple Computer, Inc.)
Available from: **Local Apple dealers**

Name: **Stock Market Option Account**
System: **APPLE II Computer**
Memory: **32K with Applesoft ROM**
48K with Applesoft RAM
Language: **Applesoft II**
Hardware: **Disk II, 132 column printer**

Description: The Stock Market Option Account program stores and retrieves virtually every option traded on all option exchanges. A self-prompting program allowing the user to enter short/long contracts. Computes gross and net profits/losses, and maintains a running cash balance. Takes into account any amending of cash balances such as new deposits and/or withdrawals from the account. Instantaneous read-outs (CRT or printer) of options on file, cash balances, P/L statement. Includes color bar graphs depicting cumulative and individual transactions. Also includes routine to proofread contracts before filing.

Copies: **Just Released**
Price: **\$19.95 + \$2.00 (P&H)** — Check or Money Order
Includes: **Diskette and Complete Documentation**
Available from:
Mind Machine, Inc.
31 Woodhollow Lane
Huntington, N.Y. 11743

Name: **IFO-DATA BASE MANAGER PROGRAM**
System: **APPLE II OR APPLE PLUS COMPUTERS**
Memory: **48K**
Language: **APPLESOFT II** on Firmware (or **APPLE II** plus computer)
Hardware: **Single Disk Drive and Serial or Parallel Printer**

Description: The IFO (Information File Organizer) Program can be used for sales activity, inventory, check registers, balance sheets, price markups, library functions, client/patient billing and many more applications. In order to use the IFO no prior programming knowledge is required. All commands are in English and are self-prompting. Up to 20 header can be created and a maximum of 1000 records can be stored on a single diskette. Information can be sorted (ascending or descending order) on any field and cross-referenced using 5 criteria on up to 3 levels of searches. Mathematical functions (adding, dividing, multiplying, squaring) can be performed on any 2 columns of data or on 1 column of data in combination with a constant to create a new column of data. Information in the data base can be printed in up to 10 different report formats using a 40, 80 or 132 column, serial or parallel printer or may be viewed on the screen only. There are numerous error protection devices in the program so that the program is easy to use and allows the user to run the program error free.

Copies: **Just Released.**
Includes: **Program Diskette and Instruction Manual**
Price: **\$100 (Manual Only:\$20)**
Author: **Gary E. Haffer**
Available From:
Software Technology for Computers
P.O. Box 428
Belmont, MA 02178

Name: **BASIC Programmer's Toolkit**
System: **PET**
Memory: **All**
Language: **Machine Language Firmware**
Hardware: **All standard PETs, or with Betsl, Expand amem or Skyles add-on memory**

Description: The BASIC Programmer's Toolkit is a collection of programming aids, coded in 6502 machine language, and delivered as a 2KByte add-on ROM. Adds 10 new commands to the PET; namely, AUTO, RENUMBER, DELETE, HELP, TRACE, STEP, OFF, APPEND, DUMP and FIND. Commands are entered as shown above, with optional parameters. Guaranteed to make the developing and debugging of BASIC programs for the PET faster and easier.

Copies: **Several thousand** in use already
Price: **\$49.95 or \$79.95** (depending on version)
Author: **Palo Alto IC's**, a division of Nestar Systems, Inc.
430 Sherman Avenue
Palo Alto, California 94306
Available from: **Local PET dealers**

Name: **Astronomer**
System: **APPLE II**
Memory: **16K with Applesoft ROM, 32K with Applesoft RAM**
Language: **Applesoft II**
Hardware: **Applesoft ROM (optional)**

Description: Astronomer applies the personal computer to aspects of astronomy which previously were available only in almanacs for specific times and conditions. Using expressions in the Almanac for Computers (U.S. Naval Observatory), times of sunrise-sunset-twilight, sidereal time, precession and Julian Date are calculated in this program for any date, time or location. The computations are completed without delay and conditions are set through an efficient user-interface.

Copies: **New Program**
Price: **\$10 + \$2** handling and postage
Includes: **Complete documentation**
Author: **Bruce Bohannon**
Available from:
Bruce Bohannon
2212 Pine Street
Boulder, CO 80302

Name: **DISCOUNT & YIELD**
System: **PET**
Memory: **8K**
Language: **BASIC**
Hardware: **PET(8K) With Cassette**

Description: Discount and Yield is designed to provide the time-value calculations necessary to determine the required discount or yield when purchasing or selling contract for deeds, land contracts or mortgages. The program will also handle the complexity of calculating discounts and yields when prepayments are made at nonscheduled intervals.

Copies: **Just Released**
Price: **\$8.95**
Includes:
Cassette and instructions
Author: **D.J. Romain**
Available from:
D. J. Romain, P.E.
405 Reflection Road
Apple Valley, MN 55124

6502 Bibliography: Part XV

William R. Dial
438 Roslyn Avenue
Akron, OH 44320

505. MICRO No. 13

Dial, Wm. R., "6502 Information Resources Updated", pgs. 29-30.

Additional and updated information on the publisher's address, subscription rates etc. for the publications cited in the 6502 Bibliography.

Lipson, Neil D., "The Color Gun for the Apple II", pgs. 31-32
Turn your Apple into a device which will determine the colors of any object.

Tripp, Robert M., "Ask the Doctor--Part V", pgs. 34-36
Discussion of AIM or SYM problems in loading KIM format cassette tapes, a short routine to get by the SYM "2F" loading bug and a routine which mimics the KIM SCANDS routine on the SYM.

Reich, L.S., "Computer-Determined Parameters for Free-Radical Polymerization.", pgs 38-40
Program for determining parameters for weight-fraction versus polymer size. Includes Example run using polystyrene data.

DeJong, Marvin L., "AIM 6522 Based Frequency Counter", pgs. 41-42
Using the AIM 65 as a six digit frequency counter capable of counting to at least 450kHz.

Scarpelli, Anthony T., "KIM—The Tunesmith", pgs. 43-52
Play, compose, save and play back music on your KIM.

Rowe, Mike (staff), "The MICRO Software Catalog:IX" pgs. 53-54
Ten interesting software offerings are reviewed.

Gieryc, Jack, "SYM-1: Speak to Me", pgs. 57-58
Some starting techniques for storing speech. Lots of memory is the key—about 5K per second of speech.

Kemp, David P., "Reading PET Cassettes without a PET", pgs. 61-63
A program is given which makes it possible for a SYM-1 to read a PET cassette.

506. Recreational Computing 7, No. 6 (May/June 1979)

Day, Jim, "PT2: Apple Scan Simulation", pg. 5.
An Applesoft II program that simulates a high resolution PPI scan.

507. The Cider Press 2 No. 3 (June 1979)

Larsen, LeRay, "Having Disk Problems?" pg. 5
A bad sector of a disk can often be rectified by putting a small amount of recording tape lubricant on the window. Then erase and reinitialize.

Wilson, Gene, "Apple II Utility Disk Software Review", pg. 5
Review of a diskette by Roger Wagner of Southwestern Data Systems, P.O. Box 582, Santee, CA 92071

Anon, "Disk of the Month — June, 1979", pg. 4
19 programs totaling some 60 kilobytes.

508. Byte 4 No. 6 (June, 1979)

Watson, Alan III, "More Colors for your Apple", pgs. 60-68
How to get additional High Resolution Colors out of your Apple.

Leedom, Bob, "Approximation Makes Magnitude of Difference", pgs. 188-189 (June, 1979)
Some tips in adapting a fast Fourier transform program for the 6800 to a KIM 6502 system.

509. Kilobaud Microcomputing No 31 (July, 1979)

Lindsay, Len, "PET-Pourri", pgs. 6-7
Information on the new 32K PETs with full size keyboards, how to modify programs for the new PET, further discussion of cassette problems, etc.

Anon, "Ohio Scientific Small Systems Journal", pgs. 8-11
Discussion of the OS-DMS data management system.

Pepper, Clement S., "Safe Ports", pgs. 60-62
Protect your I/O ports with this bidirectional buffer. Implemented on a KIM-1.

Chamberlain, Bruce S., "OSI's Superboard II", pgs. 66-70
A favorable review of this inexpensive micro board.

Lindsay Len, "Teach an old PET New Tricks" pgs. 72-74
Some reference charts to make less difficult the job of modifying programs for the OLD PET to run on the NEW PET

Sybex, 2020 Milvia St., Berkeley, CA 94704, pg. 104
Rodney Zak's new book "6502 Applications Book" is advertised.

Hallen, Rod, "The 6502 and Its Little Brothers" pgs. 124-126
A discussion of some of the other members of the 65xx family.

510. 6502 User Notes No. 15 (June, 1979)

Williams, J.C., "A 32K Dynamic RAM Board for the KIM-4 Bus" pg. 1
Constructional Article.

Green, Jim, "650X Save and Restore Routines pg. 4
Routines save and recover A,Y, and X register values.

Kantrowitz, Mark, "Telephone Dailer" pgs. 6-9
Saves and dials up to 16 different telephone numbers.

Flynn, Christopher, "Some Important BASIC Mods" pg. 9
MLDSPT can be used to activate user-written machine language routines. ARRSV/ARRLOD provides an easy way to save and load data on cassette from BASIC arrays.

Mulder, Bernhard, "Focal Mods" pg. 13
Speed it up a little with these mods.

Clements, William D., Jr., "Tiny BASIC Cassette Save and Load" pg. 13-14
Add save and load commands to your TINY BASIC.

Day, Michael E., "TINY BASIC Strings" pgs. 14-16
Here is a string MOD accessed thru USR

Fatovic, J., "Assembler" pgs. 16-17
A symbol table sort for the MOS/Aresco Assembler.

Scanlon, Leo, "Warning" pg. 18
A warning about the types of thermal paper to use in the AIM 65. Apparently some types are abrasive and can ruin the printer head.

Goga, Larry, "Notes on AIM User I/O" pgs. 18-20
All about RDRUB and also a Memory test Program.

Campbell, John R., "Modification to KIMS1 to add 4K to RAM to Memory Space Below Monitor" pg. 20
How to add 4K from address \$0000 to \$13FF.

Schilling, Heinz J., "CPU Bug" pg. 22
A bug in the JMP Indirect instruction of the 6502.

The Editor, "6522 Info and Data Sheet Corrections" pg. 22
A number of corrections are given.

Lewart, Cass, "Extending the Range of KIM-1 Timer to 1:32640" pgs. 22-23
A simple fix to make the extension.

DeJong, Marvin L., "SYM and AIM Timer Locations." pg. 23
This will help in modifying programs to run on AIM or SYM.

Boisvert, Conrad, "Use of the RDY Line to Halt the Processor" pg. 23.
A simple circuit is given.

Nazarian, Bruce, "Additions to the MTU Software Package" (KIM) pg. 26
Some additions and changes for Hal Chamberlain's DAC Software.

Lewart, Cass R., "A Simple Microprocessor Interface Circuit" pg. 26
An interface to let KIM control LEDs, relays, or AC operated appliances.

511. Personal Computing 3 No. 7 (July, 1979)

McKee, Paul, "Merging on the Challenger", pg. 8
Discussion of merging two BASIC programs.

Franklin, Larry, "Line Renumbering on the OSI" pg. 9
Discussion and modification of a line renumbering program.

Scarpelli, Anthony T., "Making Music with Fractals" pgs. 17-27
Random Tones on the KIM-1.

512. Southeastern Software Newsletter, Issue 10 (June, 1979)

Banks, Guil, "Diskette Space", pgs. 1-2
Machine Language program to tell how much space is left on a diskette. Also an Integer Basic program to call up the routine. With tutorial discussion by the editor.

Anon, "Input/Output Control Block", pg. 3
Discussion of uses for the IOB and Device Characteristics Table for the Apple II DOS 3.2 System.

Howard, Clifton M., "How to Use the TOKEN Routine", pg. 4
A step-by-step description of how to use the TOKEN Routine.

Anon, "Shorthand Commands for 3.2", pg. 5
How to add a series of shorthand controls to the Apple DOS 3.2 system.

Anon, "Turning Your Printer On", pg. 6
Short program to turn printer on and off.

513. Stems from Apple 2 Issue 6 (June, 1979)

Griffith, Joe, "Plotting Algebraic Equations", pg. 3
Several programs for different types of equations.

Hoggatt, Ken, "Ken's Korner", pgs. 6-7
Discussion of the Apple Contributed programs Nos. 3, 4 and 5. Also covered are the character generator and the character table.

Anon, "Apple Stem's Software List"
A list of 100 programs for the Apple was enclosed with the newsletter.

514. Call — Apple 2, No. 5 (June, 1979)

Golding, Val J., "Hiding Out in BASIC", pg. 5
Discussion of methods of imbedding machine code in Basic, Poke Statements, Monitor Routine, Data and Read Statements, Linker, and other routines.

Winston, Alan B., "The Multilingual Apple", pgs. 11-13
Discussion of the Fourth Language and a look at the CHRs pseudo-function and GET C\$ for Apple Integer Basic.

Anon, "DOS 3.2 Changes", pg. 15
Rewriting file-oriented programs to accommodate the change to the Apple DOS 3.2 System.

Thyng, Mike, "Applemash", pg. 5
How to pass basic serial data thru your Apple Communications Card.

Kotinoff, Jeff, "LORES Color Picture", pg. 19
Two color programs for the Apple II.

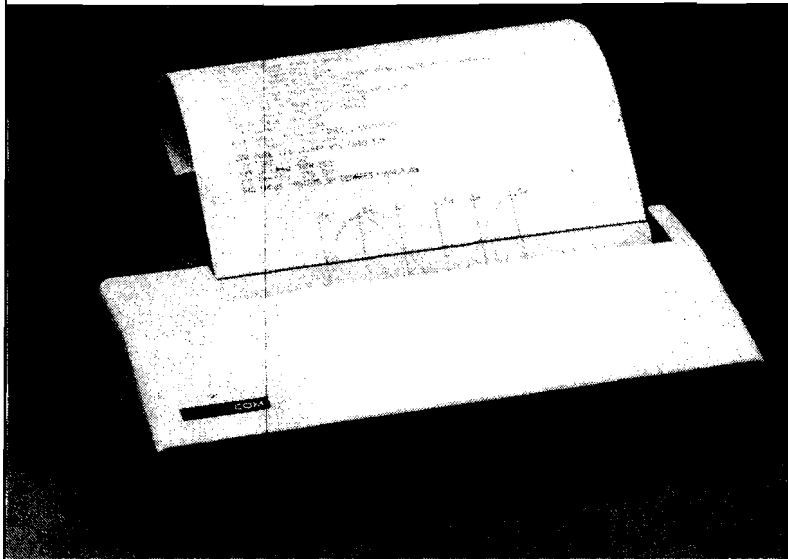
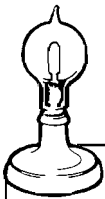

- 80 characters per line
- 8½ inch wide thermal paper
- Full graphics at 60 dots/inch
- Interfaced to PET
- Works with all PET peripherals
- 40 character per second rate
- Microprocessor controlled
- Bidirectional look-ahead printing
- Quiet operation
- No external power supplies
- Only two driven parts
- High reliability
- Clear 5 x 7 characters
- Attractive metal and plastic case

The Skyles PAL-80™ is a high speed thermal printer offering the combination of text printing at 80 characters per line and continuous graphics at 60 dots per inch. In the text mode, upper and lower case data are printed at 40 characters per second. The 5 x 7 characters provide clear readable copy on white paper; no hard to find, hard to read aluminized paper.

In the graphics mode, seven bits of each byte correspond to the seven dots in each of the 480 print positions per line. Since the computer driving the printer has full control over every print position, it can print graphs, bar charts, line drawings, even special and foreign language symbols. Despite its low cost, the Skyles PAL-80 is a

true intelligent printer with full line buffering and bi-directional look-ahead printing.

High reliability is designed in: The thick film thermal print head has a life expectancy of 100,000,000 characters. Two DC stepping motors provide positive control of the print head and the paper drive.

The Skyles PAL-80 operates directly from a 115V 60 Hz line (230V 50 Hz available). No external power supplies are required.

It comes complete with an interface for the PET: a two and a half foot cable plugs into the IEEE interface at the back of your PET. Works with all PET models and PET or Skyles peripherals.

Please send me _____ Skyles PAL-80 printer(s) complete with 2½ foot interface cable to attach to my PET at **\$675.00 each*** (Plus \$10.00 shipping and handling). I also will receive a test and graphics demonstration tape at no additional charge and over 150 feet of 8½ inch wide black on white thermal paper \$ _____

I would also like to order _____ rolls of 8½ inch wide by 85 ft. long thermal paper (black ink) at \$5.00 each \$ _____

_____ 10 roll cartons at \$45.00 \$ _____

VISA, Mastercharge orders call (800) 227-8398
California orders call (415) 494-1210

*California residents add 6 to 6½% sales tax where applicable.

PAL-80 SPECIFICATIONS

TEXT

Format 80 characters per eight inch line
6 lines per inch nominal

Print speed 40 characters per second

Line Feed 50 milliseconds nominal

Character Set 96 Characters, including upper and lower case, numerals, and symbols

GRAPHICS

Format 480 print positions per line

Print Speed 240 print positions per second

COMMON

Paper 8½ inch wide thermal paper, available in 85 foot folls, black image on white

Dimensions 12"W x 10"D x 2¾"H

Weight 8 lbs (3.6 kg)

From the Makers of THE Basic Switch™ for Old PET® Owners comes

The Spacemaker™

for New PET Owners

No Room For Your ROM?

If you're an owner of a "new-style" PET, you've probably discovered by now that your Commodore Word Processor ROM and your BASIC Programmers Toolkit ROM both go into the same empty socket in your PET. With the Spacemaker,™ you'll simply install both ROMs on the Spacemaker, plug it into your empty ROM socket, and flip a convenient external switch to select either the Toolkit or the Word Pro ROM.

Spacemaker \$27.00

ROMdriver \$37.00

Switch ROMs Manually or from Software

The ROMdriver™ is a companion device that can drive up to three Spacemakers ... allowing ROM selection on each Spacemaker under software control. The Spacemaker will be available in December, 1979. The ROMdriver in January, 1980. The Spacemaker is designed for both manual switching and software switching, so ROMdriver is not required for use of the Spacemaker in manual mode.

Spacemaker and **ROMdriver** will be available at these and other dealers:

A B Computers

115 E. Stump Road
Montgomeryville, PA 18936

New England Electronics Co., Inc.

679 Highland Avenue
Needham, Mass. 02194

or may be ordered directly from

Small System Services, Inc.

900 Spring Garden Street
Greensboro, NC 27403
919-272-4867

M/C Visa Accepted. N.C. Residents
add 4% Sales Tax.



**PET-AIM
KIM-SYM**

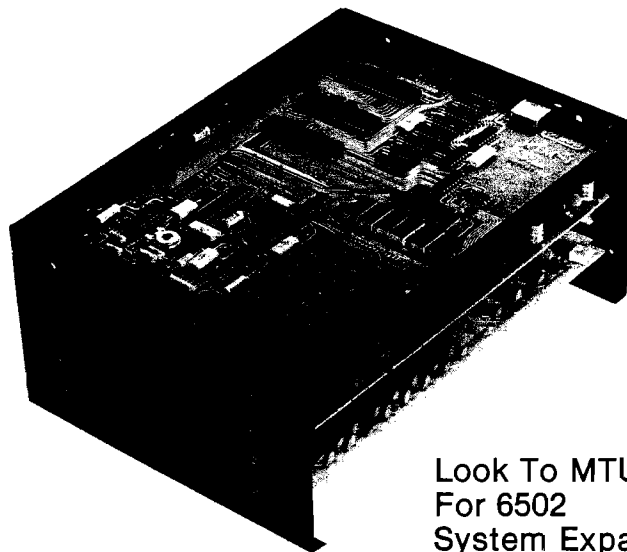

Look To MTU
For 6502
System Expansion



Micro Technology Unlimited

P.O. Box 4596, 841 Galaxy Way
Manchester, N.H. 03108
603-627-1464

Call Or Write For Our Full Line Catalog

Commodore

340K Dual Drive



CBM 2040
\$1295⁰⁰

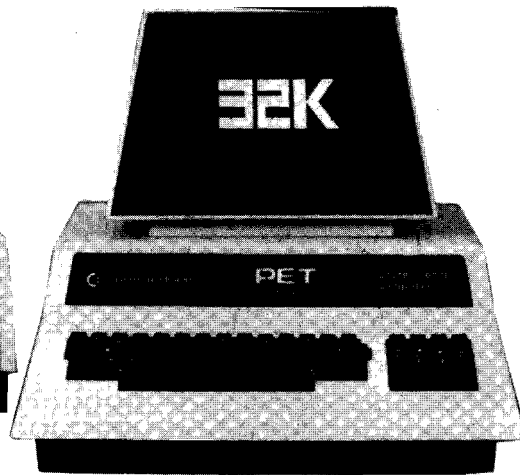

2001 - 32N \$1295⁰⁰

80 Column
Dot Matrix Printer

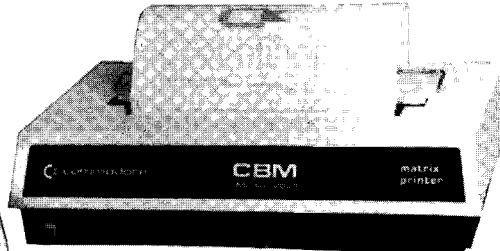

PRINTERCOM
2022 \$995⁰⁰
2023 \$849⁰⁰

2001 - 8N \$795⁰⁰
2001 - 16B \$995⁰⁰
2001 - 16N \$995⁰⁰
2001 - 32B \$1295⁰⁰
16/32K DIAGNOSTIC KIT \$225⁰⁰
AUDIO AMPLIFIER PET \$29⁹⁵

N DENOTES GRAPHICS ON LARGE KEYBOARD
B DENOTES NO GRAPHICS ON LARGE KEYBOARD

PET to IEEE Cable \$39⁹⁵
IEEE to IEEE Cable \$49⁹⁵
C2N CASSETTE \$95⁰⁰
8K DIAGNOSTIC KIT \$30⁰⁰
DISKETTES:
DYSAN [Business Quality] 5/\$24⁵⁰
VERBATIM 10/31⁹⁵

BUSINESS SOFTWARE

OSBORNE — CMS

General Ledger Disk \$295⁰⁰
Accounts Payable Disk \$195⁰⁰
Accounts Receivable Disk \$195⁰⁰
Word Processor 16/32K Disk \$99⁰⁰

Inventory Control Disk \$195⁰⁰
[Available 12-1-79]
Mailing List Disk \$95⁰⁰
Payroll Disk \$295⁰⁰
[Available 1-15-80]
Word Processor Tape \$24⁹⁵

CBM — MIS

General Ledger Disk \$120⁰⁰
Accounts Receivable Disk \$120⁰⁰
Accounts Payable Disk \$120⁰⁰
Payroll Disk \$120⁰⁰

Inventory Disk \$120⁰⁰
Job Cost/Bid Disk \$120⁰⁰
Customer Information
[Mailing List] Disk \$120⁰⁰

CBM — MIS Complete 7 Module Set \$795⁰⁰

All 16N/16B Upgrade to 32K \$310⁰⁰

Ship computer and check to:

HOME COMPUTERS

1775 E. Tropicana
(Liberace Plaza)
Las Vegas, NV 89109
702/736 - 6363

FREE Software
LAS VEGAS series with any PET
computer purchase or upgrade
to 32K, valued at \$200⁰⁰ or
more, including other software.