

THE No 1 UK MAGAZINE FOR ELECTRONICS TECHNOLOGY & COMPUTER PROJECTS

EPE EVERYDAY PRACTICAL ELECTRONICS

www.epemag.com

ROLLING CODE KEYLESS ENTRY SYSTEM

- ★ Up to 16 keyfob transmitters
- ★ Two door-strike outputs
- ★ High security
- ★ Alarm system



RECYCLE IT

A low-cost large-display anemometer from recycled parts

FAST CHARGER FOR NiMH BATTERIES

A versatile, safe charger to suit any size cells

PLUS

BREADBOARDING PROJECTS

★ Festive Lights

\$8.75 US \$10.25 CAN
AUGUST 2009 PRINTED IN THE UK



7 25274 07806 6

Copyright © 2008, Wimborne Publishing Ltd
(Sequoia House, 398a Ringwood Road, Ferndown, Dorset BH22 9AU, UK)

and TechBites Interactive Inc.,
(PO Box 857, Madison, Alabama 35758, USA)

All rights reserved.

WARNING!

The materials and works contained within *EPE Online* — which are made available by Wimborne Publishing Ltd and TechBites Interactive Inc — are copyrighted. You are permitted to make a backup copy of the downloaded file and one (1) hard copy of such materials and works for your personal use. International copyright laws, however, prohibit any further copying or reproduction of such materials and works, or any republication of any kind.

TechBites Interactive Inc and Wimborne Publishing Ltd have used their best efforts in preparing these materials and works. However, TechBites Interactive Inc and Wimborne Publishing Ltd make no warranties of any kind, expressed or implied, with regard to the documentation or data contained herein, and specifically disclaim, without limitation, any implied warranties of merchantability and fitness for a particular purpose.

Because of possible variances in the quality and condition of materials and workmanship used by readers, *EPE Online*, its publishers and agents disclaim any responsibility for the safe and proper functioning of reader-constructed projects based on or from information published in these materials and works. In no event shall TechBites Interactive Inc or Wimborne Publishing Ltd be responsible or liable for any loss of profit or any other commercial damages, including but not limited to special, incidental, consequential, or any other damages in connection with or arising out of furnishing, performance, or use of these materials and works.

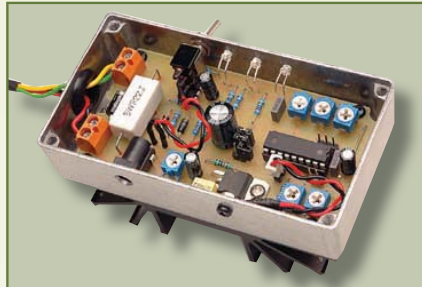

© Wimborne Publishing Ltd 2009. Copyright in all drawings, photographs and articles published in *EVERYDAY PRACTICAL ELECTRONICS* is fully protected, and reproduction or imitations in whole or in part are expressly forbidden.

Our September 2009 issue will be published on Thursday 13 August 2009, see page 80 for details.

Everyday Practical Electronics, August 2009

Projects and Circuits

- ROLLING CODE KEYLESS ENTRY SYSTEM – PART 1** by John Clarke **10**
 Rolling code makes it super secure. Can respond to up to 16 keyfob transmitters
- SIMPLE DATA-LOGGING WEATHER STATION – PART 2** by Glenn Pure **24**
 Records rainfall and temperature, and operates completely unattended
- FAST CHARGER FOR NiMH BATTERIES** by John Clarke **36**
 Can charge up to 15 identical NiMH or NiCad cells
- BREADBOARDING PROJECTS** by Dr Malcolm Plant **56**
 Part 11 – Festive Lights
- INGENUITY UNLIMITED** **62**
 Optical Motion Detector

Series and Features

- TECHNO TALK** by Mark Nelson **22**
 Diatomic power
- RECYCLE IT** by Julian Edgar **48**
 A low-cost large-display anemometer
- INTERFACE** by Robert Penfold **60**
 Calculated connection
- CIRCUIT SURGERY** by Ian Bell **64**
 Filter circuits – Part 2
- PIC N' MIX** by Mike Hibbett **68**
 PIC RS232 terminal
- NET WORK** by Alan Winstanley **74**
 The more things change; A plateful of spam

Regulars and Services

- EDITORIAL** **7**
- NEWS** – Barry Fox highlights technology's leading edge **8**
 Plus everyday news from the world of electronics
- ELECTRONICS TEACH-IN 2** **23**
 New book with Free CD-ROM – Using PIC Microcontrollers
- BACK ISSUES** Did you miss these? **34**
- PIC PROJECTS CD-ROM** **46**
 A plethora of handPICed projects
- PIC RESOURCES CD-ROM** **47**
 EPE PIC Tutorial V2, plus PIC Toolkit Mk3 and a selection of PIC-related articles
- SUBSCRIBE TO EPE** and save money **55**
- ELECTRONICS MANUALS** **59**
 The Modern Electronics Manual and Electronic Service Manual on CD-ROM
- CD-ROMS FOR ELECTRONICS** **70**
 A wide range of CD-ROMs for hobbyists, students and engineers
- READOUT** Matt Pulzer addresses general points arising **73**
- DIRECT BOOK SERVICE** **75**
 A wide range of technical books available by mail order, plus more CD-ROMs
- EPE PCB SERVICE** **78**
- ADVERTISERS INDEX** **80**

08717 Credit Card Sales 177 168

PIC & ATMEL Programmers

We have a wide range of low cost PIC and ATMEL Programmers. Complete range and documentation available from our web site.

Programmer Accessories:

40-pin Wide ZIF socket (ZIF40W) £14.95
18Vdc Power supply (PSU120) £19.95
Leads: Parallel (LDC136) £3.95 / Serial (LDC441) £3.95 / USB (LDC644) £2.95

NEW! USB & Serial Port PIC Programmer



USB/Serial connection. Header cable for ICSP. Free Windows XP software. See website for PICs supported. ZIF Socket and USB lead extra. 18Vdc.

Kit Order Code: 3149KT - £49.95

Assembled Order Code: AS3149 - £59.95

NEW! USB 'All-Flash' PIC Programmer



USB PIC programmer for all 'Flash' devices. No external power supply making it truly portable. Supplied with box and Windows XP Software. ZIF Socket and USB lead not incl.

Assembled Order Code: AS3128 - £49.95

Assembled with ZIF socket Order Code: AS3128ZIF - £64.95

'PICALL' ISP PIC Programmer



Will program virtually all 8 to 40 pin serial-mode AND parallel-mode (PIC15C family) PIC microcontrollers. Free Windows software. Blank chip auto detect for super fast bulk programming. Optional ZIF socket.

Assembled Order Code: AS3117 - £29.95

Assembled with ZIF socket Order Code: AS3117ZIF - £44.95

ATMEL 89xxxx Programmer



Uses serial port and any standard terminal comms program. 4 LED's display the status. ZIF sockets not included. Supply: 16Vdc.

Kit Order Code: 3123KT - £27.95

Assembled Order Code: AS3123 - £37.95

Introduction to PIC Programming



Go from complete beginner to burning a PIC and writing code in no time! Includes 49 page step-by-step PDF Tutorial Manual, Programming Hardware (with LED test section), Win 3.11—XP Programming Software (Program, Read, Verify & Erase), and 1rewritable PIC16F84A that you can use with different code (4 detailed examples provided for you to learn from). PC parallel port.

Kit Order Code: 3081KT - £16.95

Assembled Order Code: AS3081 - £24.95

PIC Programmer Board



Low cost PIC programmer board supporting a wide range of Microchip® PIC™ microcontrollers. Requires PC serial port. Windows interface supplied. Kit Order Code: K8076KT - £39.95

PIC Programmer & Experimenter Board



The PIC Programmer & Experimenter Board with test buttons and LED indicators to carry out educational experiments, such as the supplied programming examples. Includes a 16F627 Flash Microcontroller that can be reprogrammed up to 1000 times for experimenting at will. Software to compile and program your source code is included. Kit Order Code: K8048KT - £39.95

Assembled Order Code: VM111 - £59.95

Controllers & Loggers

Here are just a few of the controller and data acquisition and control units we have. See website for full details. 12Vdc PSU for all units: Order Code PSU445 £7.95

USB Experiment Interface Board



5 digital input channels and 8 digital output channels plus two analogue inputs and two analogue outputs with 8 bit resolution. Kit Order Code: K8055KT - £38.95

Assembled Order Code: VM110 - £64.95

Rolling Code 4-Channel UHF Remote



State-of-the-Art. High security. 4 channels. Momentary or latching relay output. Range up to 40m. Up to 15 Tx's can be learnt by one Rx (kit includes one Tx but more available separately). 4 indicator LED's. Rx: PCB 77x85mm, 12Vdc/6mA (standby). Two & Ten Channel versions also available. Kit Order Code: 3180KT - £49.95

Assembled Order Code: AS3180 - £59.95

Computer Temperature Data Logger



Serial port 4-channel temperature logger. °C or °F. Continuously logs up to 4 separate sensors located 200m+ from board. Wide range or tree software applications for storing/using data. PCB just 45x45mm. Powered by PC. Includes one DS1820 sensor. Kit Order Code: 3145KT - £19.95

Assembled Order Code: AS3145 - £26.95

Additional DS1820 Sensors - £3.95 each

Most items are available in kit form (KT suffix) or pre-assembled and ready for use (AS prefix).

4-Ch DTMF Telephone Relay Switcher



Call your phone number using a DTMF phone from anywhere in the world and remotely turn on/off any of the 4 relays as desired. User settable Security Password, Anti-Tamper, Rings to Answer, Auto Hang-up and Lockout. Includes plastic case. 130 x 110 x 30mm. Power: 12Vdc. Kit Order Code: 3140KT - £74.95

Assembled Order Code: AS3140 - £89.95

8-Ch Serial Port Isolated I/O Relay Module



Computer controlled 8 channel relay board. 5A mains rated relay outputs and 4 opto-isolated digital inputs (for monitoring switch states, etc). Useful in a variety of control and sensing applications. Programmed via serial port (use our new Windows interface, terminal emulator or batch files). Serial cable can be up to 35m long. Includes plastic case 130x100x30mm. Power: 12Vdc/500mA. Kit Order Code: 3108KT - £64.95

Assembled Order Code: AS3108 - £79.95

Infrared RC 12-Channel Relay Board



Control 12 onboard relays with included infrared remote control unit. Toggle or momentary. 15m+ range. 112 x 122mm. Supply: 12Vdc/0.5A

Kit Order Code: 3142KT - £59.95

Assembled Order Code: AS3142 - £69.95

Audio DTMF Decoder and Display



Detect DTMF tones from tape recorders, receivers, two-way radios, etc using the built-in mic or direct from the phone line. Characters are displayed on a 16 character display as they are received and up to 32 numbers can be displayed by scrolling the display. All data written to the LCD is also sent to a serial output for connection to a computer. Supply: 9-12V DC (Order Code PSU445). Main PCB: 55x95mm. Kit Order Code: 3153KT - £34.95

Assembled Order Code: AS3153 - £44.95

Telephone Call Logger



Stores over 2,500 x 11 digit DTMF numbers with time and date. Records all buttons pressed during a call. No need for any connection to computer during operation but logged data can be downloaded into a PC via a serial port and saved to disk. Includes a plastic case 130x100x30mm. Supply: 9-12V DC (Order Code PSU445). Kit Order Code: 3164KT - £54.95

Assembled Order Code: AS3164 - £69.95

Hot New Products!

Here are a few of the most recent products added to our range. See website or join our email Newsletter for all the latest news.

4-Channel Serial Port Temperature Monitor & Controller Relay Board

4 channel computer serial port temperature monitor and relay controller with four inputs for Dallas DS18S20 or DS18B20 digital thermometer sensors (£3.95 each). Four 5A rated relay channels provide output control. Relays are independent of sensor channels, allowing flexibility to setup the linkage in any way you choose. Commands for reading temperature and relay control sent via the RS232 interface using simple text strings. Control using a simple terminal / comms program (Windows HyperTerminal) or our free Windows application software. Kit Order Code: 3190KT - **£69.95**
Assembled Order Code: AS3190 - **£84.95**



40 Second Message Recorder

Feature packed non-volatile 40 second multi-message sound recorder module using a high quality Winbond sound recorder IC. Stand-alone operation using just six onboard buttons or use onboard SPI interface. Record using built-in microphone or external line in. 8-24 Vdc operation. Just change one resistor for different recording duration/sound quality. sampling frequency 4-12 kHz. Kit Order Code: 3188KT - **£28.95**
Assembled Order Code: AS3188 - **£36.95**
120 second version also available



Bipolar Stepper Motor Chopper Driver

Get better performance from your stepper motors with this dual full bridge motor driver based on SGS Thompson chips L297 & L298. Motor current for each phase set using on-board potentiometer. Rated to handle motor winding currents up to 2 Amps per phase. Operates on 9-36Vdc supply voltage. Provides all basic motor controls including full or half stepping of bipolar steppers and direction control. Allows multiple driver synchronization. Perfect for desktop CNC applications. Kit Order Code: 3187KT - **£39.95**
Assembled Order Code: AS3187 - **£49.95**



Video Signal Cleaner

Digitally cleans the video signal and removes unwanted distortion in video signal. In addition it stabilises picture quality and luminance fluctuations. You will also benefit from improved picture quality on LCD monitors or projectors. Kit Order Code: K8036KT - **£32.95**
Assembled Order Code: VM106 - **£49.95**



Most items are available in kit form (KT suffix) or assembled and ready for use (AS prefix).

Motor Speed Controllers

Here are just a few of our controller and driver modules for AC, DC, Unipolar/Bipolar stepper motors and servo motors. See website for full details.

DC Motor Speed Controller (100V/7.5A)

Control the speed of almost any common DC motor rated up to 100V/7.5A. Pulse width modulation output for maximum motor torque at all speeds. Supply: 5-15Vdc. Box supplied. Dimensions (mm): 60Wx100Lx60H. Kit Order Code: 3067KT - **£17.95**
Assembled Order Code: AS3067 - **£24.95**



Computer Controlled / Standalone Unipolar Stepper Motor Driver

Drives any 5-35Vdc 5, 6 or 8-lead unipolar stepper motor rated up to 6 Amps. Provides speed and direction control. Operates in stand-alone or PC-controlled mode for CNC use. Connect up to six 3179 driver boards to a single parallel port. Board supply: 9Vdc. PCB: 80x50mm. Kit Order Code: 3179KT - **£15.95**
Assembled Order Code: AS3179 - **£22.95**



Computer Controlled Bi-Polar Stepper Motor Driver

Drive any 5-50Vdc, 5 Amp bi-polar stepper motor using externally supplied 5V levels for STEP and DIRECTION control. Opto-isolated inputs make it ideal for CNC applications using a PC running suitable software. Board supply: 8-30Vdc. PCB: 75x85mm. Kit Order Code: 3158KT - **£23.95**
Assembled Order Code: AS3158 - **£33.95**



Bidirectional DC Motor Speed Controller

Control the speed of most common DC motors (rated up to 32Vdc/10A) in both the forward and reverse direction. The range of control is from fully OFF to fully ON in both directions. The direction and speed are controlled using a single potentiometer. Screw terminal block for connections. Kit Order Code: 3166v2KT - **£22.95**
Assembled Order Code: AS3166v2 - **£32.95**



AC Motor Speed Controller (700W)

Reliable and simple to install project that allows you to adjust the speed of an electric drill or 230V AC single phase induction motor rated up to 700 Watts. Simply turn the potentiometer to adjust the motors RPM. PCB: 48x65mm. Not suitable for use with brushless AC motors. Kit Order Code: 1074KT - **£14.95**
Assembled Order Code: AS1074 - **£23.95**



See www.quasarelectronics.com for lots more motor controllers

QE
QUASAR
electronics
The Electronic Kit Specialists Since 1993

Credit Card Sales
0871 717 7168

Electronic Project Labs

Great introduction to the world of electronics. Ideal gift for budding electronics expert!

500-in-1 Electronic Project Lab

Top of the range. Complete self-contained electronics course. Takes you from beginner to 'A' Level standard and beyond! Contains all the hardware and manuals to assemble 500 projects. You get 3 comprehensive course books (total 368 pages) - *Hardware Entry Course*, *Hardware Advanced Course* and a microprocessor based *Software Programming Course*. Each book has individual circuit explanations, schematic and connection diagrams. Suitable for age 12+. Order Code EPL500 - **£179.95**
Also available: 30-in-1 £19.95, 50-in-1 £29.95, 75-in-1 £39.95, 130-in-1 £44.95 & 300-in-1 £69.95 (see website for details)



Tools & Test Equipment

We stock an extensive range of soldering tools, test equipment, power supplies, inverters & much more - please visit website to see our full range of products.

Two-Channel USB Pc Oscilloscope

This digital storage oscilloscope uses the power of your PC to visualize electrical signals. Its high sensitive display resolution, down to 0.15mV, combined with a high bandwidth and a sampling frequency of up to 1GHz are giving this unit all the power you need. Order Code: PCSU1000 - **£399.95**



Personal Scope 10MS/s

The Personal Scope is not a graphical multimeter but a complete portable oscilloscope at the size and the cost of a good multimeter. Its high sensitivity - down to 0.1mV/div - and extended scope functions make this unit ideal for hobby, service, automotive and development purposes. Because of its exceptional value for money, the Personal Scope is well suited for educational use. Order Code: HPS10 - **£169.95**



See website for more super deals!

No.1
for KITS



www.quasarelectronics.com

Secure Online Ordering Facilities • Full Product Listing, Descriptions & Photos • Kit Documentation & Software Downloads

EVERYDAY PRACTICAL ELECTRONICS FEATURED KITS



August '09

Everyday Practical Electronics Magazine has been publishing a series of popular kits by the acclaimed Silicon Chip Magazine Australia. These projects are 'bullet proof' and already tested down under. All Jaycar kits are supplied with specified board components, quality fibreglass tinned PCBs and have clear English instructions. Watch this space for future featured kits.



FAST NI-MH BATTERY CHARGER KIT

KC-5453 £12.50 plus postage & packing

A truly versatile charger, capable of handling up to 15 of the same type of Ni-MH or Ni-Cd cells. Build it to suit any size cells or cell capacity and set your own fast or trickle charge rate. It also has overcharge protection including temperature sensing. Ideal for PC enthusiasts who burn through a lot of batteries. Kit includes solder mask & overlay PCB, programmed micro and all specified electronic components. Case, heatsink and battery holder not included.

As published in EPE August 2009



NEW TO EPE

PIC LOGIC PROBE KIT

KC-5457 £5.00 + post & packing

NEW TO EPE

Operating on 2.8 to 15VDC, this logic probe is suitable for use on the most modern circuits. It's also extremely compact with SMT devices on a PCB only 5mm wide, so it will fit inside a very slim case. It's capable of picking up a pulse only 50mS long and will also detect and hold infrequent pulses when in latch mode. Kit includes PCB and all specified electronic components including pre-programmed PIC. You'll need to add your own case and probe - a clear ballpoint pen and a darning needle work well.

As published in EPE Magazine July 2009



SMS CONTROLLER MODULE KIT

KC-5400 £17.00 plus postage & packing

Control appliances or receive alert notification from anywhere. By sending plain text messages this kit will allow you to control up to eight devices. At the same time, it can also monitor four digital inputs. It works with old Nokia handsets such as the 5110, 6110, 3210, and 3310, which can be bought inexpensively. Kit supplied with PCB, pre-programmed microcontroller and all electronics components with manual. Requires a Nokia data cable which can be readily found in mobile phone accessory stores.

As published in EPE March 2007

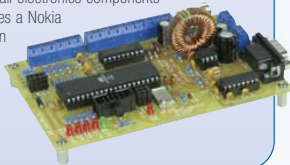

STUDIO 350 - HIGH POWER AMPLIFIER KIT

KC-5372 £50.75 plus postage & packing

Studio quality sound and distortion with tremendous power output. This will deliver a whopping 350WRMS into 4 ohms, or 200WRMS into 8 ohms. Using eight 250V 200W plastic power transistors, it is super quiet, with a signal to noise ratio of -125dB(A) at full 8 ohm power. Harmonic distortion is just 0.002%, and frequency response is almost flat (less than -1dB) between 15Hz and 60kHz! Kit supplied in short form with PCB & electronic components.

As published in EPE Oct/Nov 2006

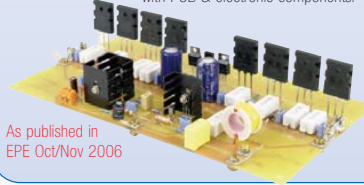

GALACTIC VOICE KIT

KC-5431 £13.50 plus postage & packing

Be the envy of everyone at the next Interplanetary Conference with this galactic voice simulator kit. Effect and depth controls allow you to simulate everything from the metallically-endowed C-3PO, to the hysterical ranting of the Daleks. The kit includes PCB with overlay, enclosure, speaker and all components.

As published in EPE August 2008



LED WATER LEVEL INDICATOR KIT - MKII

KC-5449 £11.75 plus postage & packing

This simple circuit illuminates a string of LEDs to quickly indicate the water level in a rainwater tank. The more LEDs that illuminate, the higher the water level is inside the tank. The input signal is provided by ten sensors located in the water tank and connected to the indicator unit via light duty figure-8 cable. Kit supplied with PCB with overlay, machined case with screenprinted lid and all electronic components.

- Requires: 8mm (OD) PVC hose/pipe (length required depending on depth of tank)
- Requires 12-18V AC or DC plugpack

As published in EPE March 2009



VOLTAGE MONITOR KIT

KC-5424 £6.75 plus postage & packing

This versatile kit will allow you to monitor the battery voltage, the airflow meter or oxygen sensor in your car. It has a 10 LED bar graph that lights in response to the measured voltage, preset 9-16V, 0-.5V and 0-1V range. Features a fast response time, high input impedance and auto dimming for night time driving. Kit includes PCB with overlay, LED bar graph and all electronic components.

As published in EPE November 2007

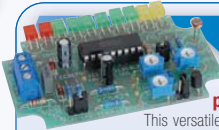

COURTESY INTERIOR LIGHT DELAY KIT

KC-5392 £6.00 plus postage & packing

Many modern cars feature a time delay on the interior light, allowing driver and passengers time to buckle up and get organised before the light dims and finally goes out. This kit enables your car to have the same handy feature, with a soft fade out after a set time has elapsed, and much simpler universal wiring than previous models we have had. Suitable for circuits switching ground or +12V or 24VDC (car & truck with negative chassis)

- Kit supplied with PCB, overlay & all electronic components

As published in EPE February 2007



3V TO 9V DC TO DC CONVERTER KIT

KC-5391 £4.75 plus postage & packing

This enables you to use regular Ni-Cd or Ni-MH 1.2V cells, or Alkaline 1.5V cells for 9V applications. Using low cost, high capacity rechargeable cells, this kit will pay for itself in no-time! Imagine the extra capacity you can have using two 900mAh D cells instead of a low capacity 9V cell. Kit supplied with PCB, and all electronic components.

As published in EPE June 2007



THE 'FLEXITIMER' KIT

KA-1732 £6.00 plus postage & packing

Uses a handful of components to accurately time intervals from a few seconds to a whole day. It can switch a number of different output devices on and off at timed intervals. Powered by a battery or mains plugpack, this kit includes PCB and all components.

As published in EPE September 2007

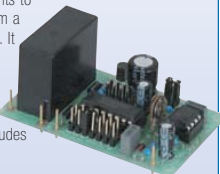

- Secure on-line ordering
- ALL prices in Pounds Sterling
- Minimum order ONLY £10

ORDER YOUR FREE CATALOGUE TODAY!



Jaycar Electronics

0800 032 7241

www.jaycarelectronics.co.uk

LIGHTING & TEST KITS FOR ELECTRONIC ENTHUSIASTS



EMERGENCY 12V LIGHTING CONTROLLER

KC-5456 £20.50 plus postage & packing

Automatically supplies power for 12V emergency lighting during a blackout. The system is powered with a 7.5Ah SLA battery which is maintained via an external smart charger. Includes manual override and over-discharge protection for the battery. Kit supplied with all electronic components, screen printed PCB, front panel and case. Charger and SLA battery available separately.



FREQUENCY METER KIT MKII

KC-5440 £20.50 plus postage & packing

This compact and low cost 50MHz frequency meter is invaluable for servicing and diagnostics. This upgraded version features an automatic indication of units (Hz, kHz, MHz or GHz) and prescaler. Kit includes PCB with overlay, enclosure, LCD and all electronic components.



- Powered by 5 x AAA batteries or DC plugpack

SERIAL PROGRAMMER KIT

KC-5467 £21.75 plus postage & packing

This very cost effective programmer kit can handle all the DSPIC30F family of PIC microcontrollers and almost all of the regular PICs available in a DIP package. It uses freely available software for PCs and is easy to build. Microchip offers free documentation and source code on their website so getting started should be a breeze. Supplied with screen printed PCB, 2 x 40 pin ZIF sockets and all specified components.



12V LIGHT OPERATED RELAY KIT

KG-9090 £7.25 plus postage & packing

This kit can operate as a twilight on/off switch or as a light trigger relay. Operated from 12 volts, this versatile project triggers a 6 amp relay when the light intensity falls below an adjustable threshold. Turn lights on around the house when it goes dark or trigger an alarm when a light is switched on. Kit supplied with Kwik Kit PCB, relay and all electronic components.



FLICKERING FLAME LIGHTING KIT

KC-5234 £5 plus postage & packing

This lighting effect uses a single 20 watt halogen lamp to mimic it's namesake. Mounted on a compact PCB, it operates from 12VDC and uses just a handful of readily available components. Use it for stage performances or for unique lighting effects at home.



- Includes 20W halogen lamp, PCB plus electronic components
- Now includes SL-2735 ceramic base

TRANSISTOR TESTER KIT

KA-1119 £8.25 plus postage & packing

Have you ever unsoldered a suspect transistor only to find that it checks OK? Avoid these hassles with this in-circuit transistor, SCR and diode tester. The kit will, test drives WITHOUT the need to unsolder them from the circuit! Includes a jiffy box, battery, electronic components, and panel showing truth table for device checking.



LUXEON STAR LED DRIVER KIT

KC-5389 £8.75 plus postage & packing

Extremely bright & efficient, Luxeon high power LEDs offer up to 120 lumens per unit, and will last up to 100,000 hours! This kit allows you to power the fantastic 1W, 3W, and 5W Luxeon Star LEDs from 12VDC. Use them in your car, boat, or caravan. Kit supplied with PCB, and all electronic components.



1 watt LED star modules available in a range of colours £3.75
 ZD-0500 - Red; ZD-0502 - Amber; ZD-0504 - Green; ZD-0506 - Blue; ZD-0510 - Warm White

NEON TUBE SOUND DISPLAY KIT

KC-5322 £6.00 plus postage & packing

This kit drives any colour neon tube in the Jaycar range and has the option of turning the tube either on or off to the beat of the music. With this latest kit you can now use any output from your car stereo - unlike its predecessor it is not limited to being exclusively driven by a subwoofer output. Kit supplied with PCB plus all specified electronic components.

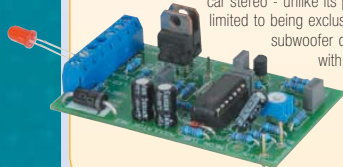

DIGITAL MULTIMETER KIT

KG-9250 £7.25 plus postage & packing

Learn everything there is to know about component recognition and basic electronics with this



comprehensive kit. From test leads to solder, everything you need for the construction of this meter is included. All you'll need is a soldering iron!

- Meter dimensions: 67(W) x 123(H) x 25(D)mm

POST & PACKING CHARGES

Order Value	Cost
£10 - £49.99	£5
£50 - £99.99	£10
£100 - £199.99	£20
£200 - £499.99	£30
£500+	£40

Max weight 12lb (5kg).
 Heavier parcels POA.
 Minimum order £10.

Note: Products are despatched from Australia, so local customs duty & taxes may apply.
 Prices valid until 31/8/09

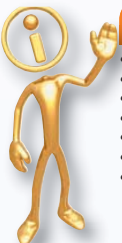

HOW TO ORDER

- **ORDER ON-LINE:** www.jaycarelectronics.co.uk
- **PHONE:** 0800 032 7241*
- **FAX:** +61 2 8832 3118*
- **EMAIL:** techstore@jaycarelectronics.co.uk
- **POST:** P.O. Box 107, Rydalmere NSW 2116 Australia
- **ALL PRICING IN POUNDS STERLING**
- **MINIMUM ORDER ONLY £10**

*Australian Eastern Standard Time (Monday - Friday 09.00 to 17.30 GMT + 10 hours only)
 Expect 10-14 days for air parcel delivery

FREE CATALOGUE

Checkout Jaycar's extensive range

We have kits & electronic projects for use in:

- Audio & Video
- Car & Automotive
- Computer
- Power
- Learning & Educational
- General Electronics Projects
- Gifts, Gadgets & Just for fun!
- Lighting
- Test & Meters

For your FREE catalogue log on to:
www.jaycarelectronics.co.uk/catalogue
 or check out the range at:
www.jaycarelectronics.co.uk



0800 032 7241

www.jaycarelectronics.co.uk

Jaycar
 Electronics

4000 Series		74LS Series		Linear ICs		Diodes		Thyristors		Resistors		Fuses		Diodes		Transistors		Diodes		Resistors																																																																																																																																																																																																																																																																																																																																																																																																																																																																																																																																																																																																																																																																																																																																																																																																																																																																																																																																																																																																																																																																																																																																																																																																			
4000B	0.27	74HC153	0.30	74LS266	0.14	OP200GP	£5.60	2N5600	0.19	1%W Carbon Film 5%	E12 Series	10Ω-1M	0.02 Each	0.80 per 100	4000B	0.27	74HC154	0.30	74LS273	0.32	OP275GP	£2.57	1N914	0.05	1/4W Carbon Film 5%	E12 Series	10Ω-10K	0.02 Each	0.80 per 100	4001B	0.16	74HC157	0.22	74LS279	0.24	OP282GP	£2.27	1N4001	0.04	1/2W Carbon Film 5%	E12 Series	10Ω-10K	0.02 Each	0.80 per 100	4002B	0.19	74HC158	0.22	74LS283	0.47	OP283GP	£5.20	1N4002	0.05	1/4W Carbon Film 5%	E12 Series	10Ω-10K	0.02 Each	0.80 per 100	4006B	0.65	74HC161	0.61	74LS365	0.21	OP290GP	£4.28	1N4003	0.05	1/4W Carbon Film 5%	E12 Series	10Ω-10K	0.02 Each	0.80 per 100	4009UB	0.23	74HC162	0.45	74LS367	0.61	OP297GP	£4.61	1N4004	0.04	1/2W Carbon Film 5%	E12 Series	10Ω-10K	0.02 Each	0.80 per 100	4010B	0.23	74HC163	0.45	74LS368	0.21	OP400GP	£11.81	1N4005	0.04	1/2W Carbon Film 5%	E12 Series	10Ω-10K	0.02 Each	0.80 per 100	4011B	0.16	74HC164	0.40	74LS373	0.39	OP495GP	£8.69	1N4006	0.04	1/2W Carbon Film 5%	E12 Series	10Ω-10K	0.02 Each	0.80 per 100	4012B	0.16	74HC165	0.21	74LS374	0.38	RC1436	£1.00	1N4007	0.03	1/4W Carbon Film 5%	E12 Series	10Ω-10K	0.02 Each	0.80 per 100	4013B	0.18	74HC173	0.38	74LS378	0.62	SG3524N	0.82	1N4141	0.03	1/4W Carbon Film 5%	E12 Series	10Ω-10K	0.02 Each	0.80 per 100	4014B	0.30	74HC174	0.37	74LS390	0.63	SG3543	£5.68	1N4149	0.07	1/2W Carbon Film 5%	E12 Series	10Ω-10K	0.02 Each	0.80 per 100	4016B	0.20	74HC193	0.39	74LS395	0.26	SSM141P	£5.12	1N5400	0.08	1/2W Carbon Film 5%	E12 Series	10Ω-10K	0.02 Each	0.80 per 100	4017B	0.26	74HC195	0.32	74LS395	0.26	SSM2142P	£6.16	1N5401	0.08	1/2W Carbon Film 5%	E12 Series	10Ω-10K	0.02 Each	0.80 per 100	4018B	0.25	74HC240	0.37	74LS395	0.26	SSM2143P	£3.78	1N5402	0.08	1/2W Carbon Film 5%	E12 Series	10Ω-10K	0.02 Each	0.80 per 100	4019B	0.25	74HC241	0.37	74LS395	0.26	TBA120S	£0.75	1N5404	0.09	1/2W Carbon Film 5%	E12 Series	10Ω-10K	0.02 Each	0.80 per 100	4020B	0.27	74HC244	0.34	74LS395	0.26	TBA800	£0.74	1N5405	0.09	1/2W Carbon Film 5%	E12 Series	10Ω-10K	0.02 Each	0.80 per 100	4021B	0.22	74HC245	0.34	74LS395	0.26	TDA1820M	£0.55	1N5407	0.10	1/2W Carbon Film 5%	E12 Series	10Ω-10K	0.02 Each	0.80 per 100	4022B	0.28	74HC251	0.30	74LS395	0.26	TD1170S	£0.80	1N5408	0.10	1/2W Carbon Film 5%	E12 Series	10Ω-10K	0.02 Each	0.80 per 100	4023B	0.23	74HC253	0.25	74LS395	0.26	TD1A200A	£2.24	6A05	0.27	1/2W Carbon Film 5%	E12 Series	10Ω-10K	0.02 Each	0.80 per 100	4024B	0.22	74HC257	0.25	74LS395	0.26	TD2003V	£1.25	6A1	0.30	1/2W Carbon Film 5%	E12 Series	10Ω-10K	0.02 Each	0.80 per 100	4025B	0.27	74HC259	0.27	74LS395	0.26	TD2030AV	£1.24	6A2	0.32	1/2W Carbon Film 5%	E12 Series	10Ω-10K	0.02 Each	0.80 per 100	4026B	0.27	74HC273	0.32	74LS395	0.26	TD2050V	£2.51	6A6	0.32	1/2W Carbon Film 5%	E12 Series	10Ω-10K	0.02 Each	0.80 per 100	4027B	0.21	74HC299	0.61	74LS395	0.26	TD2822A	£0.99	6A8	0.30	1/2W Carbon Film 5%	E12 Series	10Ω-10K	0.02 Each	0.80 per 100	4028B	0.21	74HC365	0.28	74LS395	0.26	TD2653A	£2.57	6A10	0.10	1/2W Carbon Film 5%	E12 Series	10Ω-10K	0.02 Each	0.80 per 100	4029B	0.38	74HC367	0.38	74LS395	0.26	TD3718DP	£2.09	6A137	0.27	1/2W Carbon Film 5%	E12 Series	10Ω-10K	0.02 Each	0.80 per 100	4030B	0.17	74HC368	0.29	74LS395	0.26	TEA5115	£3.21	BA1	0.11	1/2W Carbon Film 5%	E12 Series	10Ω-10K	0.02 Each	0.80 per 100	4035B	0.13	74HC373	0.35	74LS395	0.26	TL061CP	£0.21	BA2	0.11	1/2W Carbon Film 5%	E12 Series	10Ω-10K	0.02 Each	0.80 per 100	4040B	0.24	74HC374	0.34	74LS395	0.26	TL062CP	£0.22	BA4	0.12	1/2W Carbon Film 5%	E12 Series	10Ω-10K	0.02 Each	0.80 per 100	4041B	0.31	74HC390	0.37	74LS395	0.26	TL064CP	£0.20	BA6	0.12	1/2W Carbon Film 5%	E12 Series	10Ω-10K	0.02 Each	0.80 per 100	4042B	0.19	74HC393	0.37	74LS395	0.26	TL071CN	£0.60	BA8	0.09	1/2W Carbon Film 5%	E12 Series	10Ω-10K	0.02 Each	0.80 per 100	4043B	0.35	74HC393	0.37	74LS395	0.26	TL072CN	£0.20	BAW22	0.07	1/2W Carbon Film 5%	E12 Series	10Ω-10K	0.02 Each	0.80 per 100	4046B	0.42	74HC563	0.56	74LS395	0.26	TL074CN	£0.25	BA16	0.05	1/2W Carbon Film 5%	E12 Series	10Ω-10K	0.02 Each	0.80 per 100	4047B	0.25	74HC574	0.27	74LS395	0.26	TL081CN	£0.17	BY127	0.18	1/2W Carbon Film 5%	E12 Series	10Ω-10K	0.02 Each	0.80 per 100	4048B	0.29	74HC595	0.29	74LS395	0.26	TL082CN	£0.27	BY133	0.10	1/2W Carbon Film 5%	E12 Series	10Ω-10K	0.02 Each	0.80 per 100	4049B	0.29	74HC597	0.22	74LS395	0.26	TL084CN	£0.44	0A200	0.32	1/2W Carbon Film 5%	E12 Series	10Ω-10K	0.02 Each	0.80 per 100	4049UB	0.17	74HC688	0.46	74LS395	0.26	TL7705ACP	£0.82	0A91	0.27	1/2W Carbon Film 5%	E12 Series	10Ω-10K	0.02 Each	0.80 per 100	4050B	0.20	74HC4002	0.37	74LS395	0.26	UA741CN	£5.99	0A91	0.27	1/2W Carbon Film 5%	E12 Series	10Ω-10K	0.02 Each	0.80 per 100	4051B	0.23	74HC4017	0.24	74LS395	0.26	UA741CN	£5.99	0A91	0.27	1/2W Carbon Film 5%	E12 Series	10Ω-10K	0.02 Each	0.80 per 100	4052B	0.23	74HC4020	0.36	74LS395	0.26	UA741CN	£5.99	0A91	0.27	1/2W Carbon Film 5%	E12 Series	10Ω-10K	0.02 Each	0.80 per 100	4053B	0.20	74HC4049	0.35	74LS395	0.26	UA741CN	£5.99	0A91	0.27	1/2W Carbon Film 5%	E12 Series	10Ω-10K	0.02 Each	0.80 per 100	4054B	0.56	74HC4051	0.31	74LS395	0.26	UA741CN	£5.99	0A91	0.27	1/2W Carbon Film 5%	E12 Series	10Ω-10K	0.02 Each	0.80 per 100	4055B	0.34	74HC4059	0.50	74LS395	0.26	UA741CN	£5.99	0A91	0.27	1/2W Carbon Film 5%	E12 Series	10Ω-10K	0.02 Each	0.80 per 100	4060B	0.17	74HC4052	0.34	74LS395	0.26	UA741CN	£5.99	0A91	0.27	1/2W Carbon Film 5%	E12 Series	10Ω-10K	0.02 Each	0.80 per 100	4063B	0.41	74HC4053	0.22	74LS395	0.26	UA741CN	£5.99	0A91	0.27	1/2W Carbon Film 5%	E12 Series	10Ω-10K	0.02 Each	0.80 per 100	4066B	0.17	74HC4060	0.23	74LS395	0.26	UA741CN	£5.99	0A91	0.27	1/2W Carbon Film 5%	E12 Series	10Ω-10K	0.02 Each	0.80 per 100	4067B	0.20	74HC4064	0.24	74LS395	0.26	UA741CN	£5.99	0A91	0.27	1/2W Carbon Film 5%	E12 Series	10Ω-10K	0.02 Each	0.80 per 100	4068B	0.19	74HC4078	0.32	74LS395	0.26	UA741CN	£5.99	0A91	0.27	1/2W Carbon Film 5%	E12 Series	10Ω-10K	0.02 Each	0.80 per 100	4069UB	0.18	74HC4511	0.84	74LS395	0.26	UA741CN	£5.99	0A91	0.27	1/2W Carbon Film 5%	E12 Series	10Ω-10K	0.02 Each	0.80 per 100	4070B	0.15	74HC4514	0.84	74LS395	0.26	UA741CN	£5.99	0A91	0.27	1/2W Carbon Film 5%	E12 Series	10Ω-10K	0.02 Each	0.80 per 100	4071B	0.20	74HC4538	0.80	74LS395	0.26	UA741CN	£5.99	0A91	0.27	1/2W Carbon Film 5%	E12 Series	10Ω-10K	0.02 Each	0.80 per 100	4072B	0.25	74HC4543	0.90	74LS395	0.26	UA741CN	£5.99	0A91	0.27	1/2W Carbon Film 5%	E12 Series	10Ω-10K	0.02 Each	0.80 per 100	4073B	0.17	74LS900	0.38	74LS395	0.26	UA741CN	£5.99	0A91	0.27	1/2W Carbon Film 5%	E12 Series	10Ω-10K	0.02 Each	0.80 per 100	4076B	0.30	74LS900	0.38	74LS395	0.26	UA741CN	£5.99	0A91	0.27	1/2W Carbon Film 5%	E12 Series	10Ω-10K	0.02 Each	0.80 per 100	4077B	0.15	74LS902	0.21	74LS395	0.26	UA741CN	£5.99	0A91	0.27	1/2W Carbon Film 5%	E12 Series	10Ω-10K	0.02 Each	0.80 per 100	4078B	0.30	74LS903	0.22	74LS395	0.26	UA741CN	£5.99	0A91	0.27	1/2W Carbon Film 5%	E12 Series	10Ω-10K	0.02 Each	0.80 per 100	4081B	0.30	74LS904	0.30	74LS395	0.26	UA741CN	£5.99	0A91	0.27	1/2W Carbon Film 5%	E12 Series	10Ω-10K	0.02 Each	0.80 per 100	4082B	0.21	74LS908	0.14	74LS395	0.26	UA741CN	£5.99	0A91	0.27	1/2W Carbon Film 5%	E12 Series	10Ω-10K	0.02 Each	0.80 per 100	4085B	0.28	74LS909	0.15	74LS395	0.26	UA741CN	£5.99	0A91	0.27	1/2W Carbon Film 5%	E12 Series	10Ω-10K	0.02 Each	0.80 per 100	4086B	0.33	74LS910	0.27	74LS395	0.26	UA741CN	£5.99	0A91	0.27	1/2W Carbon Film 5%	E12 Series	10Ω-10K	0.02 Each	0.80 per 100	4093B	0.16	74LS111	0.25	74LS395	0.26	UA741CN	£5.99	0A91	0.27	1/2W Carbon Film 5%	E12 Series	10Ω-10K	0.02 Each	0.80 per 100	4094B	0.12	74LS112	0.25	74LS395	0.26	UA741CN	£5.99	0A91	0.27	1/2W Carbon Film 5%	E12 Series	10Ω-10K	0.02 Each	0.80 per 100	4098B	0.30	74LS114	0.29	74LS395	0.26	UA741CN	£5.99	0A91	0.27	1/2W Carbon Film 5%	E12 Series	10Ω-10K	0.02 Each	0.80 per 100	4099B	0.35	74LS124	0.29	74LS395	0.26	UA741CN	£5.99	0A91	0.27	1/2W Carbon Film 5%	E12 Series	10Ω-10K	0.02 Each	0.80 per 100	4502B	0.32	74LS200	0.29	74LS395	0.26	UA741CN	£5.99	0A91	0.27	1/2W Carbon Film 5%	E12 Series	10Ω-10K	0.02 Each	0.80 per 100	4503B	0.40	74LS211	0.29	74LS395	0.26	UA741CN	£5.99	0A91	0.27	1/2W Carbon Film 5%	E12 Series	10Ω-10K	0.02 Each	0.80 per 100	4504B	0.40	74LS212	0.29	74LS395	0.26	UA741CN	£5.99	0A91	0.27	1/2W Carbon Film 5%	E12 Series	10Ω-10K	0.02 Each	0.80 per 100	4508B	0.14	74LS226	0.17	74LS395	0.26	UA741CN	£5.99	0A91	0.27	1/2W Carbon Film 5%	E12 Series	10Ω-10K	0.02 Each	0.80 per 100	4510B	0.45	74LS227	0.25	74LS395	0.26	UA741CN	£5.99	0A91	0.27	1/2W Carbon Film 5%	E12 Series	10Ω-10K	0.02 Each	0.80 per 100	4511B	0.27	74LS230	0.20	74LS395	0.26	UA741CN	£5.99	0A91	0.27	1/2W Carbon Film 5%	E12 Series	10Ω-10K	0.02 Each	0.80 per 100	4512B	0.40	74LS237	0.13	74LS395	0.26	UA741CN	£5.99	0A91	0.27	1/2W Carbon Film 5%	E12 Series	10Ω-10K	0.02 Each	0.80 per 100	4515B	0.99	74LS239	0.23	74LS395	0.26	UA741CN	£5.99	0A91	0.27	1/2W Carbon Film 5%	E12 Series	10Ω-10K	0.02 Each	0.80 per 100	4516B	0.47	74LS338	0.18	74LS395	0.26	UA741CN	£5.99	0A91	0.27	1/2W Carbon Film 5%	E12 Series	10Ω-10K	0.02 Each	0.80 per 100	4518B	0.42	74LS440	0.14	74LS395	0.26	UA741CN	£5.99	0A91	0.27	1/2W Carbon Film 5%	E12 Series	10Ω-10K	0.02 Each	0.80 per 100	4520B	0.68	74LS451	0.24	74LS395	0.26	UA741CN	£5.99	0A91	0.27	1/2W Carbon Film 5%	E12 Series	10Ω-10K	0.02 Each	0.80 per 100	4521B	0.68	74LS452	0.24	74LS395	0.26	UA741CN	£5.99	0A91	0.27	1/2W Carbon Film 5%	E12 Series	10Ω-10K	0.02 Each	0.80 per 100	4526B	0.40	74LS483	0.18	74LS395	0.26	UA741CN	£5.99	0A91	0.27	1/2W Carbon Film 5%	E12 Series	10Ω-10K	0.02 Each	0.80 per 100	4527B	0.40	74LS484	0.28	74LS395	0.26	UA741CN	£5.99	0A91	0.27	1/2W Carbon Film 5%	E12 Series	10Ω-10K	0.02 Each	0.80 per 100	4529B	0.44	74LS492	0.45	74LS395	0.26	UA741CN	£5.99	0A91	0.27	1/2W Carbon Film 5%	E12 Series	10Ω-10K	0.02 Each	0.80 per 100	4532B	0.24	74LS493	0.58	74LS395	0.2

Virging on the ridiculous

No, that's not a spelling mistake - just my recent experience with Virgin Media, which claims to be 'The UK's leading entertainment and communications company'.

I'm sure our readers are more than appreciative of the great contributions digital electronics has made to our lives. From intercontinental communications to the wonderful clarity of CDs, we are all enriched by the flow of data made possible by hardworking and mostly unacknowledged engineers. Keeping this data moving should be a mere technical detail, but as anyone who has a failing PC, broken internet link - or in my case landline - will confirm, the technology becomes completely sidelined by a call-centre-based service sector that manages to turn the whole troubleshooting experience into blood pressure torture.

It's not just the endless code entry, the appalling music while you wait your turn, the 'cheery' voice announcing 'recording for training purposes', it's not even the utter uselessness of the poor soul at the end of the line when you finally get through. What is extraordinary is the corporate ethos of a complete lack of customer care. I have been without a phone for over two weeks, and I 'might' get an engineer in another two weeks time. I have been systematically misled, kept at home waiting for staff that don't keep appointments, and my calls and emails are not answered. To the best of my knowledge I am not paranoid - I very much doubt that I have been singled out for this level of 'service', it is presumably the default setting.

So, a small piece of advice - don't just check the technical specification: find out about service before you sign on with a provider.

Last, but not least, guess what the telephone number for customer complaints with the 'UK's leading... communications company' is - yup, there isn't one. You couldn't make it up.

Mind

AVAILABILITY

Copies of *EPE* are available on subscription anywhere in the world (see opposite) and from all UK newsagents (distributed by SEYMOUR). *EPE* can also be purchased from retail magazine outlets around the world. An Internet online version can be purchased and downloaded for just \$18.99US (approx £13) per year, available from www.epemag.com

SUBSCRIPTIONS

Subscriptions for delivery direct to any address in the UK: 6 months £19.95, 12 months £37.90, two years £70.50; Overseas: 6 months £23.00 standard air service or £32.00 express airmail, 12 months £44.00 standard air service or £62.00 express airmail, 24 months £83.00 standard air service or £119.00 express airmail.

Online subscriptions, for downloading the magazine via the Internet, \$18.99US (approx £13) for one year available from www.epemag.com.

Cheques or bank drafts (in £ sterling only) payable to *Everyday Practical Electronics* and sent to *EPE* Subs. Dept., Wimbome Publishing Ltd, Sequoia House, 398a Ringwood Road, Ferndown, Dorset BH22 9AU. Tel: 01202 873872. Fax: 01202 874562. **Email:** subs@epemag.wimbome.co.uk. Also via the Web at: www.epemag.com. Subscriptions start with the next available issue. We accept MasterCard, Maestro or Visa. (For past issues see the Back Issues page.)

BINDERS

Binders to hold one volume (12 issues) are available from the above address. These are finished in blue PVC, printed with the magazine logo in gold on the spine. Price £7.95 plus £3.50 p&p (for overseas readers the postage is £6.00 to everywhere except Australia and Papua New Guinea which cost £10.50). Normally sent within seven days, but please allow 28 days for delivery - more for overseas.

Payment in £ sterling only please. Visa, Maestro and MasterCard accepted. Send, fax or phone your card number, card expiry date, valid from date and card security code (the last 3 digits on or just under the signature strip), with your name, address etc. Or order on our secure server via our UK website. **Overseas customers** - your credit card will be charged by the card provider in your local currency at the existing exchange rate.

Editor: MATT PULZER

Consulting Editors: DAVID BARRINGTON
JOHN BECKER

Subscriptions: MARILYN GOLDBERG

General Manager: FAY KEARN

Editorial/Admin: (01202) 873872

Advertising and Business Manager:

STEWART KEARN (01202) 873872

On-line Editor: ALAN WINSTANLEY

EPE Online (Internet version) Editors:

CLIVE (Max) MAXFIELD and ALVIN BROWN

Publisher: MIKE KENWARD

READERS' TECHNICAL ENQUIRIES

Email: techdept@epemag.wimbome.co.uk

We are unable to offer any advice on the use, purchase, repair or modification of commercial equipment or the incorporation or modification of designs published in the magazine. We regret that we cannot provide data or answer queries on articles or projects that are more than five years' old. Letters requiring a personal reply must be accompanied by a stamped self-addressed envelope or a self-addressed envelope and international reply coupons. We are not able to answer technical queries on the phone.

PROJECTS AND CIRCUITS

All reasonable precautions are taken to ensure that the advice and data given to readers is reliable. We cannot, however, guarantee it and we cannot accept legal responsibility for it. A number of projects and circuits published in *EPE* employ voltages that can be lethal. You should not build, test, modify or renovate any item of mains-powered equipment unless you fully understand the safety aspects involved and you use an RCD adaptor.

COMPONENT SUPPLIES

We do not supply electronic components or kits for building the projects featured, these can be supplied by advertisers.

We advise readers to check that all parts are still available before commencing any project in a back-dated issue.

ADVERTISEMENTS

Although the proprietors and staff of *EVERYDAY PRACTICAL ELECTRONICS* take reasonable precautions to protect the interests of readers by ensuring as far as practicable that advertisements are bona fide, the magazine and its publishers cannot give any undertakings in respect of statements or claims made by advertisers, whether these advertisements are printed as part of the magazine, or in inserts. The Publishers regret that under no circumstances will the magazine accept liability for non-receipt of goods ordered, or for late delivery, or for faults in manufacture.

TRANSMITTERS/BUGS/TELEPHONE EQUIPMENT

We advise readers that certain items of radio transmitting and telephone equipment which may be advertised in our pages cannot be legally used in the UK. Readers should check the law before buying any transmitting or telephone equipment, as a fine, confiscation of equipment and/or imprisonment can result from illegal use or ownership. The laws vary from country to country; readers should check local laws.



NEWS

A roundup of the latest Everyday News from the world of electronics



Camming Piracy

The UK government refuses to make laws which specifically ban camcording in cinemas. Barry Fox reports.

HI-DEF camcorders small enough to hide in a hat can now be used to make pirate DVDs. The official line is that Section 6 of the Fraud Act 2006 already covers camcording. But there have been no successful test cases to prove it. Cinemas use military-style night vision goggles to look for pirates, but these are no help if the camcorder is hidden. British company Technical Lamp Supplies, of Slough, has now come up with a way to detect a camcorder, even when it is carefully hidden.

CamScan electronically sniffs the cinema for the tell-tale radio frequencies which leak from a video camera. Each camera uses slightly different circuitry, so CamScan can distinguish one camcorder from another. Says TLS, "CamScan offers cinema operators their first real chance to stop early pirated copies being illegally recorded."

The company placed 10 CamScan systems in UK cinemas last year, says TLS Sales Director Nick Simmonds. That followed a 2006 pilot project in six UK

cinemas. The 2008 installations have since been removed for fine-tuning, but modified CamScans were recently re-installed at two UK cinemas. "We have sold eight systems to MovieLabs in the US," Simmonds said, referring to the Palo Alto, California-based research and development think tank of the six major studios. "These have been used by Disney and two security companies."

When camcording is detected, CamScan triggers an alarm on a central console, alerting cinema security staff to where the recording is taking place. Because the system can distinguish between different camera types, there need be no false alarms from cameras phones in pockets. CamScan also waits for five minutes continuous recording before the alarm is triggered.

For obvious reasons, TLS won't divulge technical details, but the basic idea derives from detectors used during World War II and the Cold War to find spy radios by driving a van with sensitive electronics down the street. The same system was

then adapted to detect TV sets in homes without TV licences. With analogue TVs the van can even tell what station the set is tuned to.

"The system is still in development and it's difficult to say what its final price will be," says Simmonds. But the prototype systems that TLS sold to MovieLabs currently cost around £2000 for an eight-screen control box, plus £200 per screen for detection heads. "Unfortunately, I cannot comment on those products at this time," says MovieLabs President Steve Weinstein.

As I have grown to expect, the Motion Picture Association retreats to a stunned silence when asked any remotely technical question. FACT, the UK's anti-piracy organisation, is more forthcoming. "Yes there have been trials of CamScan which have shown some pretty good results in detecting recording devices" says Eddy Leviten, FACT's Head of Communications.

MicroRFID Modules

APDanglia have announced the release of the RFIDREAD series of three low-cost 125kHz RFID reader/writer modules, including a PCB with RS232 and one R/W PCB with UART Tx/Rx TTL output. Intended for OEMs and hobbyists alike, these small profile modules, complete with built-in antenna, allow users to quickly and economically add an RFID reader/writer to their own products without the need for lengthy research and development cycles.

Each module comes complete with a simple-to-use set of commands for performing the standard functions required for accessing the popular EM4100 and T5557 transponders available on the market. Dimensions of the fully encapsulated microRFID module are only 25 × 25 × 10mm, including antenna. Mounting to a PCB is via a 0.1-inch pinout header. These modules are said to be ideal for all embedded applications.

For a limited period only, APD are offering *EPE* readers a 10% introductory discount on these products. To take advantage, go to www.apdanglia.org.uk/offer.html. For free R/W software download and more details of all their RFID products, go to

www.apdanglia.org.uk – see their advert on page 79 of this issue.

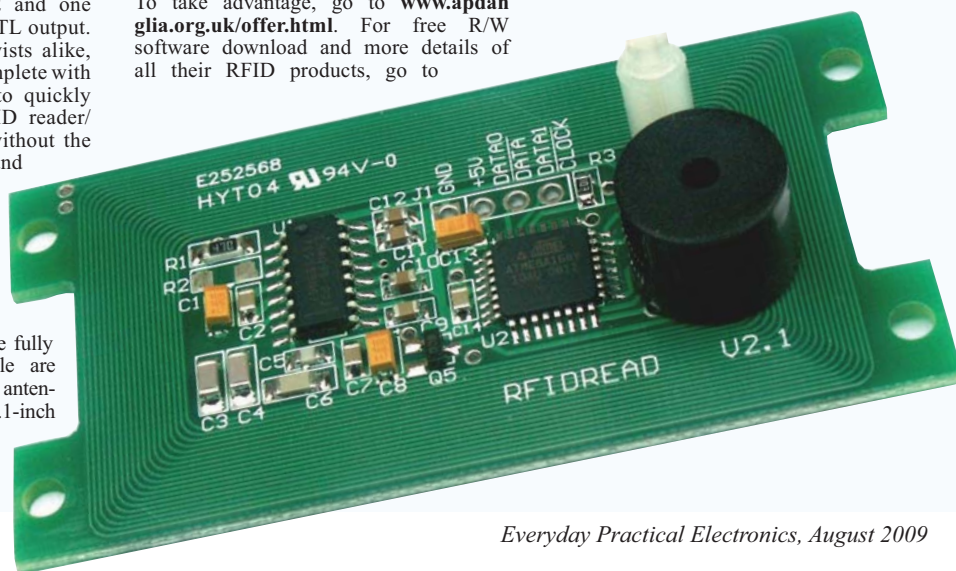

PICO ADDS MATHS CHANNELS

PicoScope, the PC oscilloscope software from Pico Technology, is one of the best-known oscilloscope packages on the market. Its carefully designed ergonomics and clear, uncluttered display have set a benchmark for PC oscilloscope displays. With the latest release, PicoScope can now display mathematical functions of input signals alongside the original inputs.

To add a maths channel, just click a button and a wizard will guide you through the process. You can quickly select one of the built-in functions, such as inversion or addition, or create your own from the highly flexible equation editor. All the standard arithmetic, exponential and trigonometric functions are supported. You can control the entire process using the mouse, or type equations using the keyboard if you prefer.

The number of waveforms you can display is virtually unlimited. You can have eight waveforms in one 'view', but if you need more you can simply open another view. Maths channels can be used in both oscilloscope and spectrum analyser modes.

Another new feature is input filtering. You can now apply a digital low-pass filter with adjustable cut-off frequency to each input channel independently. This can be used to reject noise and reduce jitter, resulting in cleaner waveforms.

Among the other improvements in this release is the ability to use the colour persistence and equivalent-time sampling modes at the same time. This allows you to spot intermittent glitches in fast repetitive signals that are beyond the real-time sampling rate of the oscilloscope.

Alan Tong, managing director of Pico Technology, commented: "Since we launched PicoScope 6, we have been continually adding new features and improving its performance to make sure that our customers always have the best available software. All these new features are available free of charge to new and existing users."

PicoScope 6.2.0 can be downloaded from the Pico Technology website at www.picotech.com. Free technical support and updates are available to all Pico customers.

Free energy saving bulbs

Energy saving light bulb specialist Eco Promotion has launched a scheme in which consumers can take advantage of free energy saving light bulbs and benefit from substantially reduced energy costs. Eco Promotion, together with the Energy Saving Trust can assist UK householders switch from old style light bulbs to the next generation of money saving technology.

All traditional inefficient tungsten filament light bulbs are being phased out over the next few years, to be replaced by energy saving light bulbs. Savings made by switching to the new bulbs can be considerable – with an average of £3 per year for each bulb, that could represent a total saving of around £45 per household.

There are currently two free offers available as part of the Eco Promotion. The first is for a free pack of ten 12W GE Energy Saving Trust-approved spiral bulbs worth £20. These high quality bulbs recently won the *Which?* Magazine 'Best Buy' and are considered to be one of the best energy saving light bulbs on the market. Savings made in the lifetime of this free pack of bulbs is a staggering £180. Eco Promotion only requires you to pay for post and packing, full details of which can be found on their website.

Also available as part of the Eco Promotion is a pack of two free GE Dusk to Dawn Sensor Bulbs. These bulbs, worth £20, have been specially designed to improve your home security. At just 15W, the bulbs use considerably less energy than conventional bulbs and have the added feature of automatically switching on at dusk and switching off again at dawn, so giving the impression that someone is at home, even when the house may be empty. Again these bulbs are currently available free of charge from Eco Promotion with just the post and packing to pay for.

Eco Promotion claims it is now one of the UK's leading suppliers of energy saving products and offers Heatkeeper radiator panels, safety packs, solar kits and energy saving kits. Working closely with the Energy Saving Trust, the company is constantly searching for new and innovative energy saving and eco-friendly products to add to its range. Dealing exclusively with top of the range manufacturers such as GE Lighting, JML, Proteam and Solar Technology Ltd, the company says it has built up an enviable reputation as one of the UK's leading online suppliers of energy saving products.

Visit www.ecopromotion.co.uk to claim the free energy saving light bulbs.

Three new gas sensors from Parallax

Parallax has released three new gas sensors each designed for use in gas detection equipment:

The MQ-7 CO gas sensor can be used to detect the presence of carbon monoxide in home, automotive or industrial settings. It has high sensitivity to carbon monoxide (CO) gas, a stable and long life and a simple drive circuit.

The MQ-2 methane gas sensor can be used to detect the presence of methane in home, automotive or industrial settings. It has a wide detecting scope, a stable and long life, a simple drive circuit and a fast response with high sensitivity.

The MQ-5 LPG gas sensor can be used to detect the presence of propane in home, automotive or industrial settings. It has a high sensitivity to propane gas, a stable and long life and a simple drive circuit.

For more information visit www.parallax.com.

GPS Receiver Module

Parallax has just released a new product, the PMB-248 GPS receiver module. With this module you can track up to 12 satellites to pinpoint your location on the globe. With TTL and RS-232 level outputs you can connect this receiver to any microcontroller or your PC. Small size and low power consumption make this GPS receiver a great choice for robotics, vehicle tracking, fleet management and auto pilot, as well as for navigation systems.

This high sensitivity GPS receiver features the SONY CXD2951A-4 chipset and includes a built-in rechargeable battery for memory and RTC backup. The receiver can track up to 12 satellites for fast acquisition and supports the NMEA0183 V2.2 protocol.

For more information visit www.parallax.com.

SchmartBoard patent

SchmartBoard has announced that a patent has been granted for its 'EZ' technology for hand soldering surface mount technology (SMT) electronic components.

In summary, the patent covers a modification of circuit board technology. A normal PCB consists of two main components on the surface. The solder mask, which comprises the coloured areas, and the electronic pads, which are the metallic areas. The electronic pads are on top of the solder mask, and this is where the electronic components are placed. This system works well when circuits are mass-produced using precise robotic pick and place technology. However, when circuits need to be hand soldered for projects or prototyping, the average engineer does not have the dexterity or expertise to do it.

SchmartBoard's new patent calls for the solder mask to be much higher than the pads. Additionally the pads are pre-tinned with solder. What this modification does is allow the electronic components to easily be hand placed by virtually anyone. Because the solder is already on the pads, a user simply takes a soldering iron and melts the solder to the component leads or runs the boards through a re-flow oven. This technology makes it virtually impossible to create shorts or bridges when hand soldering SMT components.

"Our technology is utilised by three main user groups: industry, education and hobbyists," says Neal Greenberg, SchmartBoard's VP sales and marketing. "It has saved significant time and money for industry, allowed SMT technology to be used in education, and has made it possible for hobbyists to use current component technology. SchmartBoard's website has videos of SMT parts being soldered and offers a free demo board with chip for users to try for themselves before purchasing."

For more information browse www.schmartboard.com.

EP EVERYDAY PRACTICAL
ELECTRONICS

If you have some breaking news you would like to share with our readers then please email:

editorial@wimborne.co.uk

Rolling Code Keyless Entry System



Versatile IR unit also functions as an alarm

Part.1: By JOHN CLARKE

Ideal for keyless entry for doors in cars, homes and industry, this Keyless Entry System features a rolling code to ensure high security. It also has two door-strike outputs, an alarm system and provision to use up to 16 separate keyfob transmitters with the same receiver.

LOTS OF DIFFERENT electronic systems have now been developed for keyless entry. These include systems that require a coded electronic key, such as RF and infrared transmitters, RFIDs (Radio Frequency Identification Devices), keypads and swipe cards. There are also units that do not require a coded electronic key and these include fingerprint, face and iris recognition.

Regardless of format, electronic keys usually comprise a small keyfob-style transmitter and a receiver that goes

with the door lock mechanism. The transmitter sends a string of data that is unique to each individual lock and this data must match the data stored in the receiver before the lock will be released. The concept is roughly similar to a standard metal key, which has a pattern of peaks and valleys along its length. These peaks and valleys must match the tumblers within the lock in order for the lock to open.

With any type of lock, there is always a problem of security. Keys can easily

be copied, while many conventional RF and infrared transmitters are far from tamper-proof. One technique is to use a special receiver to intercept and copy the transmitted code. Once copied, the signal can then be re-transmitted to the door lock to gain unauthorised entry.

In fact, this technique was commonly used by car thieves in carparks and proved very effective against early electronic locking systems. It could also be used to open automatic garage doors and gain access to buildings.

Rolling code security

Modern transmitters now circumvent this problem by changing their code each time they send a signal. So if an unauthorised person captures the transmitted code, re-sending this code will not unlock the door. This is because the door lock is now expecting a new code based on an algorithm

that both the transmitter and receiver have in common.

This code changing technique is commonly called a 'rolling code', although it is sometimes also called 'code hopping'. It renders copying useless and thus provides a very high level of security. It is also virtually impossible to send a correct code without having a valid rolling code transmitter. This is because of the huge number of code variations possible.

Because of its security advantages, a rolling code transmitter forms the basis of the Rolling Code Keyless Entry System described here. In fact, the odds of picking a correct code at random for our rolling code transmitter are one in 1.4 trillion or roughly one in 10^{12} .

If you want to know more about rolling code transmissions, refer to the separate panel elsewhere in this article.

Main features

Our new Rolling Code Keyless Entry System comprises a small keyfob-style transmitter and a separate receiver. The transmitter is small enough to be attached to a keyring, and has two pushbutton switches, each capable of sending a separate code. Each time one of the switches is pressed, a small indicator LED flashes to indicate that the transmitter has sent its code.

The larger of the two switches activates the alarm functions of the receiver. It arms the unit so that it will sound an alarm should there be unauthorised access.

The alarm functions include an electric door strike control (this allows the door to be opened), two alarm inputs (eg, to monitor doors, windows or other sensors), and an arm/disarm output. The door strike can optionally be set to operate on arming, on disarming or both.

In addition, an alarm output is provided to sound a siren if required.

The second, smaller pushbutton switch on the transmitter is independent of the alarm. It can be used to operate a separate door strike or some other device connected to the receiver. Such devices can include a light or a siren that can be used as a panic alarm. This can be optionally set to operate momentarily or can be toggled on and off with each switch pressing.

The door strike outputs can be set to operate from between 0 to 64 seconds, while the inputs can include delayed operation from 0 to 64 seconds. These

Features

Transmitter

- Rolling code infrared transmission
- Small keyfob style case
- Dual function buttons
- Randomisation of code parameters feature
- Synchronising of parameters feature
- Up to 16 identifications

Receiver

- 12V operation
- Up to 16 separate transmitters can be synchronised
- Dual function with an independent output
- Two alarm inputs with exit and entry delays
- Two door strike outputs
- Alarm output
- Arm/disarm output and LED indicator
- IR receive acknowledge LED
- Strike 1 operates on arm, disarm or both
- Strike 2 operates independently with momentary operation or toggle output
- Arm output invert option
- Adjustable door strike, entry/exit delay and alarm periods
- 200-code look ahead feature
- Transmitter lockout feature

delayed inputs allow the alarm to be armed while giving the user enough time to exit the door without setting off the alarm. An identical delay period allows the alarm to be disarmed on entry.

During the exit delay period, the ARM indicator LED in the receiver unit flashes on and off at a one second rate. At the end of the exit delay, this LED indicates that the unit is armed by flashing briefly once every second. This conserves power and increases its effectiveness when it comes to attracting attention.

An Acknowledge/Power LED is also included in the receiver. This normally flashes with a very short duty cycle. However, when the receiver picks up a signal from the transmitter, the Ack/Power LED flashes at a very high rate. It also shows if the received code is invalid by momentarily blinking off and on.

If the code is correct, the receiver responds to the signal. The transmission range is about 4m, which should be sufficient for most purposes. **Note, however, that it will not work if the IR receiver is in direct sunlight.**

Setting it up

Before using the Infrared Rolling Code Alarm, both the transmitter and the receiver must be set up correctly.

First, each transmitter must be given a separate identity ranging from 1 to 16. This is selected using link options on the transmitter board, but note that no two transmitters should be given the same identity.

Second, the transmitter must be randomised. This changes the initial rolling code and algorithm parameters to ensure that the transmitter code is going to be unique.

The third step involves synchronising the transmitter and receiver. This process involves sending the rolling code parameters to the receiver, as described next month. You can synchronise from 1 to 16 transmitters, provided each has a different identity.

Also included is a facility to prevent any or all transmitters from operating the receiver once they have been synchronised. This 'lockout' feature can be useful if a transmitter has been lost and you no longer want it to work with your alarm system.

A transmitter identity can be locked out individually, but if you don't know the identity of a lost transmitter, all identities can be locked out. The transmitters that are to be used with the receiver are then re-synchronised.

Constructional Project

Parts List – Rolling Code Keyless Entry System

Receiver

- ★ 1 PC board, code 721, size 61mm × 122mm
- 1 UB3-type plastic box, size 130mm × 68mm × 44mm
- 5 2-way PC-mount screw terminal blocks (5mm or 5.08mm pin spacing)
- 1 SPST vertical mount micro tactile switch, with 0.7mm actuator (S1)
- 3 3-way pin header terminal strips (2.54mm spacing)
- 4 2.54mm jumper shunts
- 3 PC stakes
- 1 25mm length of 0.8mm tinned copper wire

Semiconductors

- 1 PIC16F88-I/P microcontroller programmed with irrcroll.hex (IC1)
- 1 78L05 low-power 5V regulator (REG1)
- 1 38kHz infrared receiver (IRD1)
- 2 BD681 Darlington NPN transistors (Q1,Q2)
- 2 BC337 NPN transistors (Q3,Q4)
- 1 16V 1W Zener diode (ZD1)
- 4 1N4004 1A diodes (D1-D4)
- 1 1N5404 3A diode (D5)
- 2 3mm red LEDs (LED1,LED2)

Capacitors

- 5 100µF 16V PC electrolytic
- 3 100nF MKT polyester
- 3 10nF MKT polyester
- 1 1nF MKT polyester

Resistors (0.25W, 1%)

- 4 10kΩ 1 220Ω
- 2 2.2kΩ 2 100Ω
- 2 1kΩ 1 10Ω
- 2 680Ω

Test Components

- 4 red LEDs
- 4 2.2kΩ 0.25W 1% resistors

Transmitter

- ★ 1 PC board, code 722, measuring 30 × 36mm
- 1 keyfob remote control case (Jaycar HB-5605 or equivalent)
- 1 12V A23 car alarm battery (9.5 diameter × 27mm)
- 2 SPST SMD tactile switches 6 × 6 × 3.85mm (S1,S2)
- 1 TO-3P transistor silicone insulating washer, cut to 20 × 24mm
- 5 PC stakes
- 1 25mm length of 0.8mm tinned copper wire
- 1 ICSP 5-pin connector (CON1)

Semiconductors

- 1 PIC16F628A-20/SO 18-lead SOIC microcontroller, programmed with irxmroll.hex (IC1)
- 1 MC78M05 DPAK 5V regulator (REG1)
- 1 MMBT100 SOT-23 SMD NPN transistor (Q1)
- 1 MMBT200 SOT-23 SMD PNP transistor (Q2)
- 2 1N4148 diodes (D1,D2)
- 1 3mm infrared emitting LED (LED1)
- 1 green gull wing style surface mount LED (2.2 × 2.2mm) (LED2)

Capacitors

- 2 1µF monolithic ceramic
- 1 100nF monolithic ceramic

Resistors (0.25W, 1%)

- 2 10kΩ 2 22Ω
- 3 1kΩ
- 2 10kΩ horizontal trimpots (VR1,VR2)

- ★ Printed circuit boards available from the *EPE PCB Service*

Transmitter circuit

OK, so much for the background details. Let's now take a look at how the circuit works, starting with the transmitter – see Fig.1.

IC1, a PIC16F628A microcontroller, forms the heart of the transmitter circuit. The circuit might look quite simple, but there are a lot of 'smarts'

hidden inside the PIC micro, including the software necessary to generate the rolling code.

Under normal conditions, switches S1 and S2 are open circuit and transistor Q2 is off, so no power is applied. This is done to ensure long battery life. If power were continuously applied, the current drawn from the battery

would be around 4mA because of the quiescent current of the 5V regulator.

Conversely, pressing either S1 or S2 connects the 12V battery to the input of regulator REG1 via diode D1 or D2. A 22Ω resistor is included in series between the battery and the switches to limit the initial charging current into the 1µF bypass capacitor at REG1's input. This minimises wear on the switch contacts.

When power is applied to REG1's input, its output delivers a regulated +5V rail to IC1. As a result, the micro powers up and runs its internal software program.

Switch check

One of the first things the program does is check which switch was pressed (this happens after a short delay to make sure the switch is fully closed). In operation, the program can decide if S1 or S2 is pressed because of the 10kΩ resistor connected between S2 and the micro's RA4 input.

It works like this. Initially, RA4 is set low by the program. This pin is then made open circuit so that it can be pulled high if switch S2 was closed. However, if S1 was closed instead, the RA4 pin will stay at 0V. By checking the voltage on RA4, the program can thus determine which switch was pressed and initiate the correct function codes for that switch.

The 10kΩ resistor is necessary to limit the current into the internal clamping diodes at RA4 when S2 is closed. In practice, the positive clamp diode will conduct, clamping the RA4 input to 0.6V above the +5V supply. This protects the input from damage.

Diodes D1 and D2 protect the regulator from reverse polarity should the battery be inserted the wrong way around. These diodes also isolate the switch outputs from each other, so that the RA4 input will only go high if S2 is pressed. If S1 is pressed, the 12V at REG1's input reverse biases D2, and so is blocked from reaching RA4.

Next, the program sets RA2 at pin 1 of the micro high. This output drives the base (B) of NPN transistor Q1 via a 10kΩ resistor. As a result, Q1 switches on and this in turn switches on transistor Q2.

This action latches the supply to regulator REG1, even if switch S1 or S2 is released. This is necessary to allow time for the rolling code calculations to

Specifications

Transmitter

Standby current: 0mA

Total transmit current: rolling code transmission = 35mA for 80ms; synchronise = 35mA for 100ms; randomisation = 10mA.

Infrared transmit frequency: 38.46kHz

Code transmission rate: 1.024ms

Encoding: a high (or a 1 bit) is transmitted as a 512 μ s burst of 38.46kHz infrared signal, followed by 512 μ s of no transmission. A low (or 0 bit) is transmitted by a 512 μ s period of no transmission, followed by a 512 μ s burst of 38.46kHz infrared signal.

Rolling code: sends four start bits, an 8-bit identifier, the 48-bit code plus four stop bits. The start bits include a 16.4ms gap between the second start bit and the third start bit.

Synchronise code: sent as two blocks. Block 1 sends four start bits, the 8-bit identifier, a 32-bit seed code and four stop bits. Block 2 sends four start bits, a 24-bit multiplier, the 8-bit increment and 8-bit scramble values, and four stop bits. The start bits include a 16.4ms gap between the second start bit and the third start bit.

Code randomisation: alters the multiplier values, the increment value, the scramble value and the seed code at a 40 μ s rate.

Infrared transmission range: 4m

Receiver

Supply Current: 7.6mA typical when armed and with no external devices powered.

Strike 1 period: adjustable from 0-64 seconds in 0.25s steps approximately.

Strike 2 period: adjustable from 0-64 seconds in 0.25s steps approximately.

Input 1 delay: adjustable from 0-64 seconds in 0.25s steps approximately for exit and entry delays.

Input 2 delay: adjustable from 0-64 seconds in 0.25s steps approximately for exit and entry delays.

Alarm period: adjustable from 0-128 seconds in 0.50s steps approximately

the transmitter and amplifies this to a constant level. This signal is then fed to a 38kHz bandpass filter to remove any 50Hz or 100Hz mains signal and other noise. It then demodulates the signal to produce a serial data burst at IRD1's pin 1 output.

This serial data signal from IRD1 is fed to the RB4 input of IC1 via a 100 Ω resistor. A 1nF capacitor filters out any transients.

IRD1 is powered from the receiver's +5V supply rail. A 100 Ω resistor and a 100 μ F capacitor provide supply decoupling and filtering, to prevent the receiver from producing false signals due to power line changes.

As well as the IR receiver, there are two other inputs to the PIC

microcontroller. These are alarm sensor inputs – Input 1 and Input 2 – and these connect to the RB5 and RB6 inputs of IC1 via 2.2k Ω resistors. Each input is also bypassed using a 100nF capacitor to filter out transients and thus prevent false triggering of the alarm.

When these inputs are open, both RB5 and RB6 are held high (ie, at +5V) via internal pull-up resistors. In practice, this means that you can use normally-open (NO) or normally-closed reed switch and magnet assemblies to trigger the inputs.

If you use an NO switch, the input will normally be high and the system will trigger if a switch is closed. Conversely, if an NC switch is used, the

input will normally be pulled low but will go high if the switch is opened.

Basically, any change in level when a reed switch opens or closes will be detected and sound the alarm at the end of the entry period – provided that the receiver is in its armed state. Note, however, that the alarm will not sound if the receiver is still within its exit delay period.

Door strike outputs

When an IR signal transmission is received, the output from IRD1 is processed by IC1. This then drives Darlington transistors Q1 and Q2 as appropriate to control the door strike outputs (ie, Strike1 and Strike2).

As shown, Q1 and Q2 are driven via 680 Ω resistors from IC1's RB0 and RA2 outputs respectively. Diodes D1 and D2 clamp the voltage produced by the door strike solenoid to the supply rail when the transistor is switched off.

Transistors Q1 and Q2 are both BD681 Darlington types and can be used to drive loads up to 1.5A. A typical electric door strike only draws about 800mA at 12V.

The other two outputs are the Alarm and Arm outputs and these are controlled by transistors Q4 and Q3 (both BC337) respectively. Q4 is driven by IC1's RB1 output via a 220 Ω current limiting resistor. However, the base current is sufficient for the transistor to remain fully saturated for a 200mA load and this is ideal for many piezo sirens.

Similarly, transistor Q3 is driven via a 10k Ω resistor from IC1's RB2 output. Q3's collector provides the Arm output and this can be used as a toggle output to set a second alarm system.

Typically, you would use a 1k Ω pull-up resistor between the Arm output and the +12V rail, so that the level can swing between 0V and 12V. Alternatively, Q3's collector could be used to drive a relay coil. In this case, the 10k Ω base resistor will need to be reduced to 1k Ω so that the transistor can remain in saturation while driving a 285 Ω 12V relay coil.

The unit can be optionally configured with Q3 either on or off when armed. This is set using link LK4.

When LK4 is in the '+' position, Q3 is on when the unit is armed and off when disarmed. In this case, the RB3 input is held at +5V via an internal pull-up resistor within IC1.

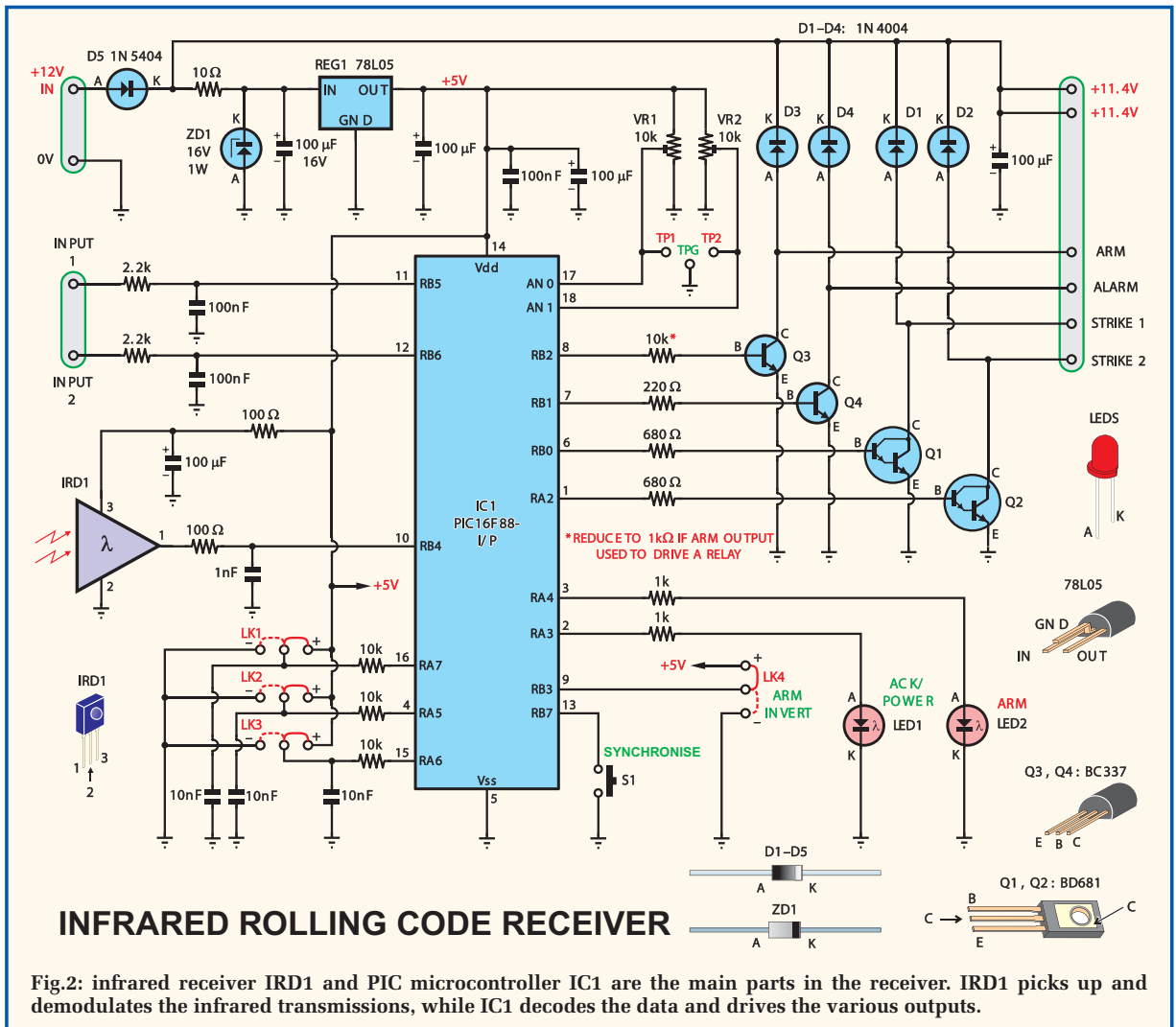

Moving LK4 to the '-' position pulls RB3 to ground and changes the sense of the Arm output. In this case, Q3 is off when the unit is armed and on when disarmed.

LED 2 indicates the state of the unit. It's driven from the RA4 output of IC1 via a 1kΩ resistor and flashes when the unit is armed.

There are two different flash styles. During the entry and exit delay periods, the LED flashes with a 50% duty cycle (ie, it is on for half the time and off for half the time). However, at the end of the delay period, it flashes on for only 4% of the duty cycle (ie, each flash is very brief).

Other link options

Links LK1, LK2 and LK3 are included to provide further options.

For example, LK1 can be tied to either the +5V rail or to 0V, or it can be left open. These three options determine how the Strike1 output operates. Basically, Strike1 can be set to operate when the unit is armed, when it is disarmed or on both arming and disarming.

In operation, the software programmed into the PIC micro decides where the link is inserted by running a few tests. First, it takes the RA7 output high (5V) and then sets the RA7 pin as an input to read the voltage. If the voltage is now low, then the link must be in the '-' position. However, if the input remains high, then the link is either in the '+' position or is open circuit (it remains high when the link is open because of the charge on the associated 10nF capacitor to ground).

To test if the link is in the '+' position or open, the RA7 pin is made an output again and is driven low (to 0V). The RA7 pin is then changed to an input and the level checked again. If the voltage is now high, then the link must be in the '+' position. Conversely, if the voltage is low, then the link is open.

The 10kΩ resistor in series with RA7 is there to prevent shorting when this pin is taken high and low with a link in position.

LK2 sets Strike2's operation for either momentary operation or for toggle operation. This link pulls the RA5 input either to +5V when it is in the '+' position (momentary) or to 0V when it is in the '-' position (toggle). Note that this link cannot be left open because the RA5 pin can only be used as an input.

Constructional Project

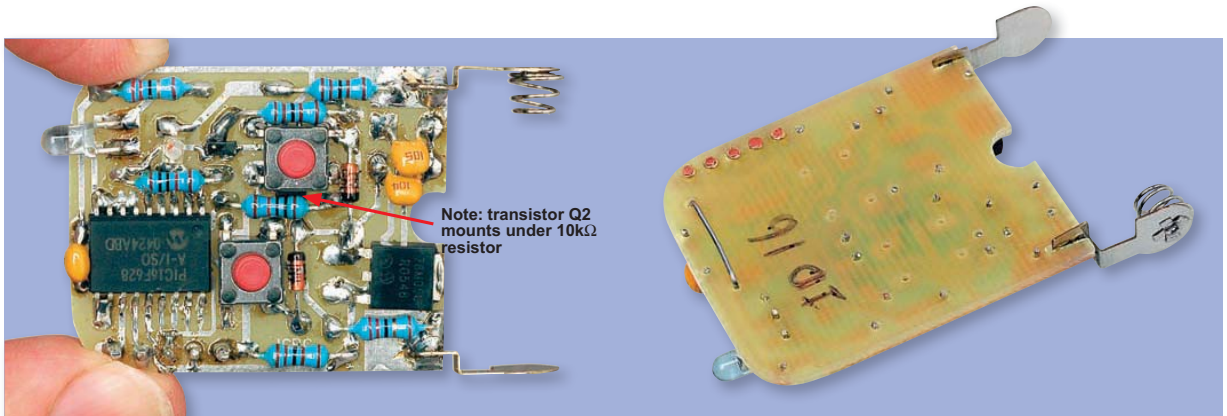

Note: transistor Q2 mounts under 10kΩ resistor

These two larger-than-life-size photos clearly show how the parts are mounted on the transmitter board. You will need a fine-tipped soldering iron (2mm diameter or less) and a magnifying glass to do the assembly.

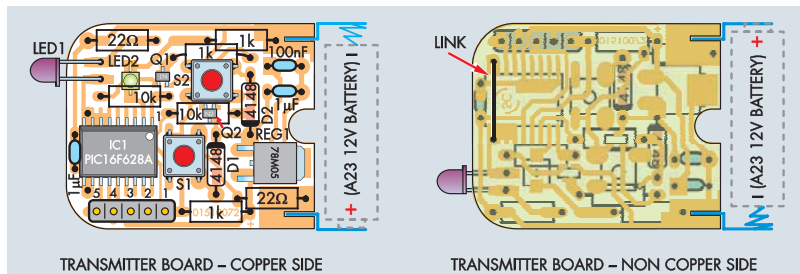

Fig.3: follow these parts layout diagrams to build the transmitter board. Note that you have to set the transmitter's identity before installing IC1 (see text) and don't forget transistor Q2 – it goes under a 10kΩ resistor, just below S2.

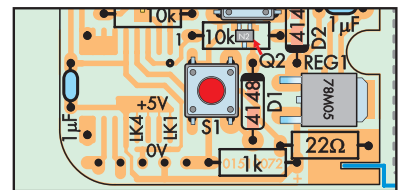

Fig.4: this enlarged track section shows the locations of links LK1-LK4 on the transmitter board. The transmitter identity is changed by breaking one or more of the thinned link connections to the +5V rail and bridging them (with solder) to the adjacent 0V rail instead.

LK3 is used in conjunction with trimpots VR1 and VR2 to set the various time periods. These include the Strike1 and Strike2 momentary on periods, the entry and exit delays for Input1 and Input2, and the alarm period.

As shown in Fig.2, trimpots VR1 and VR2 are connected across the 5V supply and their wipers (moving contact) connect to analogue inputs AN0 and AN1 respectively. The voltage applied

to each analogue input is converted to a digital value within the software and it is these values that determine the timeout periods.

Synchronise switch

Switch S1 is the Synchronise switch, and this connects to the RB7 input. This input is normally held high via an internal pull-up resistor, but when S1 is closed, it pulls RB7 to 0V.

Basically, S1 is used to synchronise the receiver with the transmitter. It is also used when setting the time periods. In

addition, if S1 is closed during power-up, it selects the transmitter identity lockout function.

Power supply

Power for the circuit is from a 12V supply such as a battery or DC plugpack. Diode D5 provides reverse polarity protection and is rated at 3A so that it can handle the currents that may be drawn by an electric door strike and siren.

The 10Ω resistor and Zener diode ZD1 provide transient protection, with the Zener clamping voltages over 16V. The 10Ω resistor limits the current through ZD1 to a safe level.

Following ZD1, the supply is filtered using a 100μF capacitor and applied to the 3-terminal regulator REG1. The resulting regulated +5V rail is then

Capacitor Codes

Value	μF Code	IEC Code	EIA Code
100nF	0.1μF	100n	104
10nF	.01μF	10n	103
1nF	.001μF	1n0	102

Resistor Colour Codes (Transmitter)

No.	Value	4-Band Code (1%)	5-Band Code (1%)
2	10kΩ	brown black orange brown	brown black black red brown
3	1kΩ	brown black red brown	brown black black brown brown
2	22Ω	red red black brown	red red black gold brown

Table 1: Transmitter Identity

Identity	LK1	LK2	LK3	LK4
1	+	+	+	+
2	+	+	+	-
3	+	+	-	+
4	+	+	-	-
5	+	-	+	+
6	+	-	+	-
7	+	-	-	+
8	+	-	-	-
9	-	+	+	+
10	-	+	+	-
11	-	+	-	+
12	-	+	-	-
13	-	-	+	+
14	-	-	+	-
15	-	-	-	+
16	-	-	-	-

used to power IC1 and the infrared receiver (IRD1).

Power on/off indication is provided by LED1, which also acknowledges the infrared signal. Normally, LED1 flashes with a 4% duty cycle about twice per second. However, when an infrared signal is received, it flashes at the infrared reception rate.

LED1 also flashes with an even duty cycle for a short time at the end of synchronisation and if the infrared signal is incorrect.

Construction

The Rolling Code Keyless Entry System is built on two PC boards: a Receiver board, code 721, and a Transmitter board, code 722. Both boards are available from the *EPE PCB Service*.

We'll start with the transmitter assembly, which is the trickier of the two. In order to fit in the keyfob case, the transmitter board measures just 30 × 36mm and uses lots of surface-mount components.

However, these are not too difficult to solder in, provided you have a soldering iron tip that is just 2mm in diameter or finer. A magnifying glass (or, preferably, a 'maggie lamp') is also required to check your soldering, while a length of 1.5mm de-soldering braid (Solderwick) would also be useful for cleaning up any excess solder that may flow between connections.

Fig.3 shows the component layout on the PC board. The first step is to check the PC board carefully for any



The keyfob case is supplied with the key switch covers mounted as shown here. This assembly must be removed.

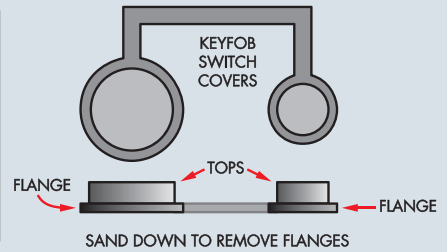

Fig.5: once the switch covers have been removed, the flanges are ground down using 180-grit sandpaper, so that only the tops remain (see text).

breaks in the copper or shorts between tracks. Repair any faults that you do find (rare these days), then check the shape of the board. It should have a curved front edge and a small circular cut out at the other end. In addition, there should be two slots for the battery clips.

Next, check that the PC board fits neatly into the base of the keyfob case. If it does not fit, it's just a matter of filing it neatly along the edges until it does.

Setting the identity

Before mounting any of the parts, it's first necessary to set the

transmitter's identity – but only if more than one transmitter is to be used. If more than one transmitter is used, then each will require a unique identity.

As supplied, the PC board initially ties links LK1 to LK4 to the +5V supply rail. This is Identity1, or ID1. If only one transmitter is to be used, then you don't have to do a thing – just leave it at the default identity (ID1).

If you do wish to change the identity, it's just a matter of altering one or more of the links as shown in Table 1. You do that by breaking the link's thinned connection to the +5V track



Above: the finished transmitter board inside its keyfob-style plastic case. Power comes from a 12V A23 car alarm battery. Note how the keyswitch covers are mounted on the lid, using a 20 × 24mm silicone washer – see text.

Reproduced by arrangement with SILICON CHIP magazine 2009.
www.siliconchip.com.au

Right: the two keyswitch covers are attached to the 20 × 24mm silicone washer as shown here. Use silicone sealant to 'glue' them in place. The keyfob lid can be used as a template to position them correctly.



Constructional Project

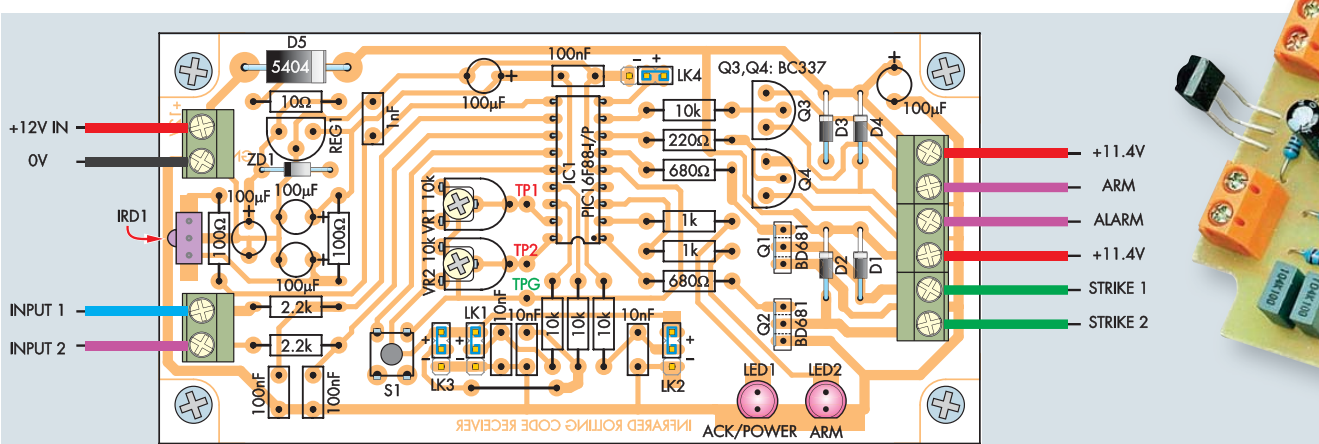

Fig.6: follow this diagram to mount the parts on the receiver board. Use a socket for the PIC microcontroller and take care to ensure that all polarised parts are correctly orientated. The infrared receiver module (IRD1) can either be mounted on the board (as in the prototype) or connected via shielded cable (see diagram next month).

and connecting it to the adjacent 0V track instead via a small solder bridge.

Make sure, however, that a link connection is not made to both the +5V and 0V tracks. We have labelled the +5V connection with a plus (+) sign and the 0V connection with a minus (-) sign.

It is important to select the identity now because the +5V track section cannot be accessed when IC1 is in place. The +5V connections should only be broken with a sharp craft knife and, once broken, should not be resoldered. That's because IC1 would no longer sit properly on the board, making it difficult to solder its pins.

The selected identity should be marked on the back of the PC board using a marker pen. For example, if the identity is 2, write ID2 on the PC board. This number can also be written on the back of the keyfob transmitter case, in the indentation provided.

Software

If you are building the unit from a kit, then IC1 will be supplied pre-programmed. If not, you will have

to program the PIC yourself using a suitable programmer. As previously mentioned, we have provided two programming options, the first of which is to use the in-circuit programming connector on the PC board.

Alternatively, you can build and use the surface mount adaptor board to be described next month, so that IC1 can be programmed out of circuit.

The software files will be available via the *EPE* Library site, accessed via www.epemag.com. Pre-programmed PICs will also be available from Magenta Electronics – see their advert in the issue for contact details.

Parts assembly

Except for a single wire link, all parts for the transmitter mount on the copper side of the PC board. Don't install the link yet though – that step comes after you install IC1.

To install IC1, position it on the board with its pin 1 at top right – see Fig.3 (pin 1 is indicated by a small adjacent dot in the body of the IC). Carefully adjust it so that its pins line

up with the tracks and use a clothes peg (or some other small spring-clamp) to hold it in position.

That done, solder a couple of diagonally opposite pins, check that everything is correct, then remove the peg and carefully solder the remaining pins.

The main thing to watch out for here is unwanted solder bridges between adjacent copper tracks. If this does happen, use some solder wick to draw up the excess solder to clear the short. A magnifying glass will be handy here to inspect your work.

Note that pins 6 to 9 and 10 and 11 are connected together anyway, so solder between these pins is OK.

Once the IC is in, you can install the link beneath it on the other side of the board. This link must sit flat against the board, otherwise the board will not sit down in the case correctly.

The remaining surface mount components – Q1, Q2, LED2 and REG1 – can now be soldered in place. **Transistor Q1 has an N1 label on its top, while Q2 has an N2 label instead.**

Resistor Colour Codes (Receiver)

No.	Value	4-Band Code (1%)	5-Band Code (1%)
4	10kΩ	brown black orange brown	brown black black red brown
2	2.2kΩ	red red red brown	red red black brown brown
2	1kΩ	brown black red brown	brown black black brown brown
2	680Ω	blue grey brown brown	blue grey black black brown
1	220Ω	red red brown brown	red red black black brown
2	100Ω	brown black brown brown	brown black black black brown
1	10Ω	brown black black brown	brown black black gold brown

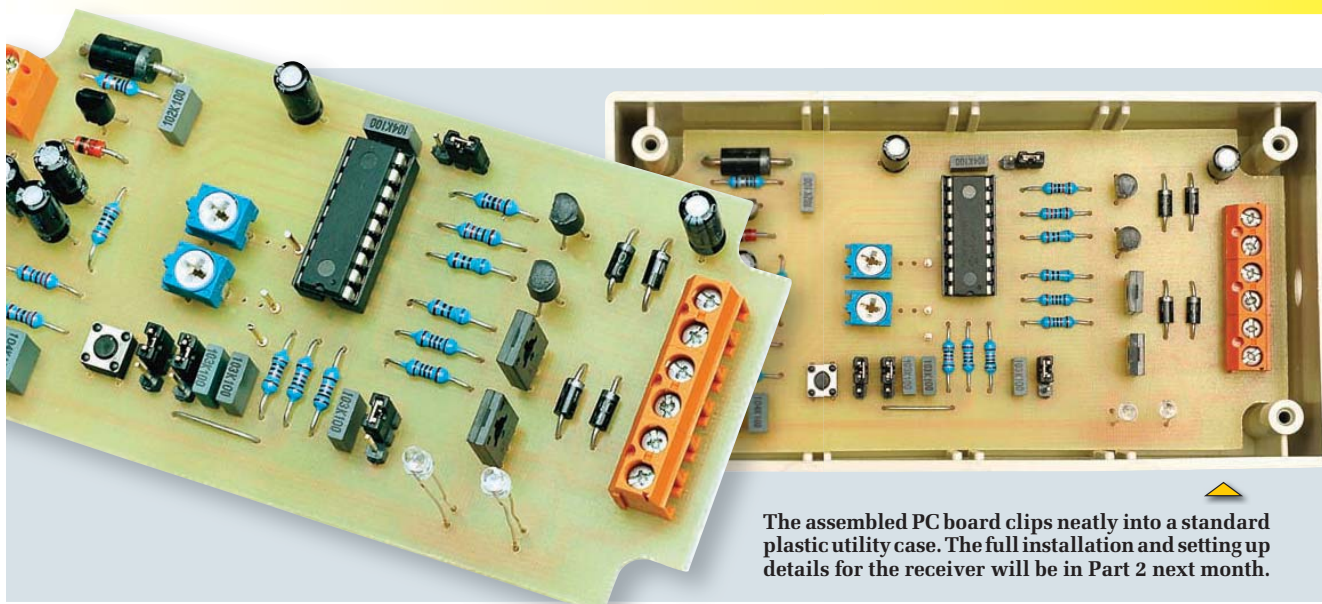

The assembled PC board clips neatly into a standard plastic utility case. The full installation and setting up details for the receiver will be in Part 2 next month.

These numbers relate to the MMBT100 and MMBT200 types respectively. Don't get them mixed up.

Installing the semiconductors

The orientation of the two transistors is obvious – they have one pin on one side of the body and two on the other side. REG1 has a GND tab plus IN and OUT pins that must be soldered to the PC board. The central pin between the IN and OUT pins is left unconnected.

Be careful with the orientation of LED2 – its cathode lead is the longer of the two.

Next, solder in switches S1 and S2, then install five PC stakes for the ICSP header. These pins are inserted from the non-copper side of the PC board and soldered in position. The pins are then trimmed on the copper side to 3mm in height. On the underside, they are trimmed and filed to 0.5mm.

The standard components can now be installed. These must be mounted flat against the PC board or as close to it as possible in the case of the 10kΩ resistor that straddles Q2. Take care with the orientation of diodes D1 and D2 and note that the tops of the three monolithic capacitors must be no more than 4mm above the PC board.

In particular, the two capacitors near REG1 can be laid over at about 45°, while the one adjacent to IC1 needs to have its leads adjusted so it can be pushed down onto the PC board far enough to meet the 4mm height requirement.

Cut all the leads beneath the PC board (ie, on the non-copper side) flush with the surface.

LED1 can go in next. Its anode lead is the longer of the two (unlike LED2) and this lead must go towards IC1. To mount it, first bend its leads down by 90° exactly 2mm from its body, then insert the leads into the PC board. Finally, push the LED all the way down onto the PC board, solder the leads and cut them flush with the underside.

Note that a small circular notch is required in the rim of the keyfob base for the LED to sit in. This can be made using a small rat-tail file. When this notch has been made, file a matching notch in the top half of the keyfob case.

Battery terminals

The battery terminals are installed by first placing the PC board in the base of the case. That done, the terminals are slid into position and soldered. Make sure that the terminal with the spring is located as shown in Fig.3.

Switch cover modifications

The key switch covers that are supplied with the keyfob case have to be modified to suit the two switches on the PC board.

As supplied, the two switch covers are already secured in place in the keyfob lid. This assembly must be removed and the covers carefully ground down to 1.5mm thick – see Fig.5. This is done by placing some 180-grit sandpaper onto a flat bench and sanding the switch covers until they are flat on their base.

That done, cut out a 20 × 24mm rectangular piece from a silicone TO-3 washer (20 × 24mm) to make a new switch cover assembly. It's then simply

a matter of attaching the switch covers to this washer using silicone sealant – see photo. Use the keyfob lid as a template to position the covers correctly.

Receiver assembly

Now for the receiver – see Fig.6. As usual, start by checking the PC board for any defects. Check also that the hole sizes for the screw terminal blocks are correct and enlarge them if necessary.

That done, check that the PC board fits inside the specified utility case. File the board edges to get it to fit if necessary but don't file them too much, otherwise the board will not lock correctly into the wall slots.

Fig.6 shows the assembly details. Install the wire link first, then install the resistors. The accompanying table shows the resistor colour codes, but you should also check them using a digital multimeter.

The diodes and the IC socket can go in next, taking care to orient each with the correct polarity. Follow these with the capacitors, again making sure that the electrolytics go in correctly. The three PC stakes for TP1, TP2 and TPG can then be installed.

Depending on your requirements, LEDs 1 and 2 can either be mounted directly on the PC board or mounted externally and connected using wire leads. Be sure to mount each LED with its cathode lead (the shorter of the two) towards the lower edge of the PC board.

Similarly, IRD1 can either be mounted directly on the PC board or connected

Frequently Asked Questions

One question that's often asked about rolling code systems is what happens if the transmitter is out of range and one of the transmit switches is pressed? Will the receiver still work when the transmitter is later brought within range and the button pressed again?

This question is asked because the code the receiver was expecting has already been sent and the transmitter has rolled over to a new code. So how does the system get around this problem?

The answer to this is that the receiver will acknowledge a signal that is the correct length and data rate, but it will not trigger unless it receives the correct code. So if the signal format is correct but the code is incorrect, the receiver then calculates the next code that it would expect, and checks this against the received code. If the code is now correct the receiver will unlock the door.

If the code is still incorrect, the receiver calculates the next expected code and will do this up to 200 times. If none of these are correct, the receiver keeps its original code, but it will not trigger. In fact, the only way to trigger the receiver after this is to re-synchronise it to the transmitter.

Of course, a second transmitter will still operate the receiver (provided they have been synchronised in the first place). That's because this transmitter has a different identity and a different code to the other transmitter.

Automatic synchronisation

Some rolling code transmitters systems offer automatic synchronisation if the transmitter and receiver lose sync. In these systems, the receiver includes a code 'look-ahead' feature, as described above, but the number of look-ahead codes is usually limited to fewer than 200. What happens is that if the code is not recognised after all the look-ahead calculations have

been made, the receiver changes its synchronisation method.

Basically, the receiver requires two separate transmission codes before restoring correct operation. On the first transmission, it calculates the next code it should receive using this received code as the basis for calculation. If the second code sent by the transmitter is the same as the code that was calculated, the receiver operates.

The drawback of this latter scheme is somewhat less security since, in theory, two successive transmission codes could be intercepted and recorded. These codes could then be re-transmitted to synchronise and thus trigger the receiver.

Calculating the code

Another question that's often asked is how does the receiver know which code to expect from the transmitter, since this changes each time?

The answer to this is that the transmitter and the receiver both use the same calculation to determine the next code. They also both use the same variables in the calculation and these variables tend to be unique values that no other transmitter uses.

For example, if the calculation for consecutive codes requires the original calculated code to be multiplied by 100 and the number 7 added to it, then both the transmitter and receiver will use these numbers to perform the calculation.

Without knowing both the multiplier and the increment value, it would be very difficult to predict the next code. This is particularly true because of the very large numbers involved. The values quoted for the multiplier and increment value are not as simple as 100 and 7 but are 24 bits and eight bits respectively in length.

In addition, the code length is 48 bits with as many as 2.8×10^{14} combinations. This reduces by a factor of 200

because of the look ahead feature to a 1 in 1.4×10^{12} chance of striking the correct code – still impossibly long odds.

Code scrambling

A further complication with the transmitted code is that the code is not necessarily sent in sequence. There are also 32 possible scrambling variations that can be applied to the code.

What if the transmitter sends two consecutive codes that are the same and the code is intercepted and re-transmitted to open the lock? This is highly improbable and our rolling code transmitter has safeguards to prevent the same code appearing twice in succession. For each code calculation, a comparison is made between the current and last code. If the code is the same, the code is recalculated after an increment of the code value to ensure successive code calculations diverge. It is this new code that is transmitted.

The receiver performs the same recalculation so that the new code will be accepted.

Another question concerns the use of different transmitters. Does each transmitter use the same rolling code calculation and if so, wouldn't the receiver lose its synchronisation if several transmitters were used? The answer is that the receiver will not lose synchronisation, even if one of the transmitters is not generally used. This is because each transmitter operates independently from the others.

Only 16 transmitters can be used with a given receiver and each must have its own different identity from 1 to 16. The identity is built into each transmitter and synchronisation is required for each transmitter.

The codes sent by each transmitter are different and the code includes the transmitter identity value. The receiver has 16 different rolling code and calculation parameters, and so each transmitter is treated independently.

using twin-core shielded cable (see diagram in Part 2 next month).

Trimpots VR1 and VR2 and the 3-way and 2-way pin headers for LK1-LK4 are next on the list. That done, install REG1 and transistors Q1 to-Q4. Q1 and Q2 must be installed with their metal faces towards IC1.

Finally, complete the board assembly by installing switch S1 and the screw terminal blocks. Note that the 6-way terminals at the righthand edge of the PC board are made up using three 2-way blocks. These are joined by sliding their dovetail joints together before installing them on the PC board.

That's all we have space for this month. Next month, we'll complete the construction and describe the installation and setting-up procedures, including setting the entry and exit delays. We'll also describe the optional SOIC adaptor board, so that you can program the PIC microcontroller out of circuit.

The new PicoScope 4000 Series high-resolution oscilloscopes

PicoScope 4000 Series

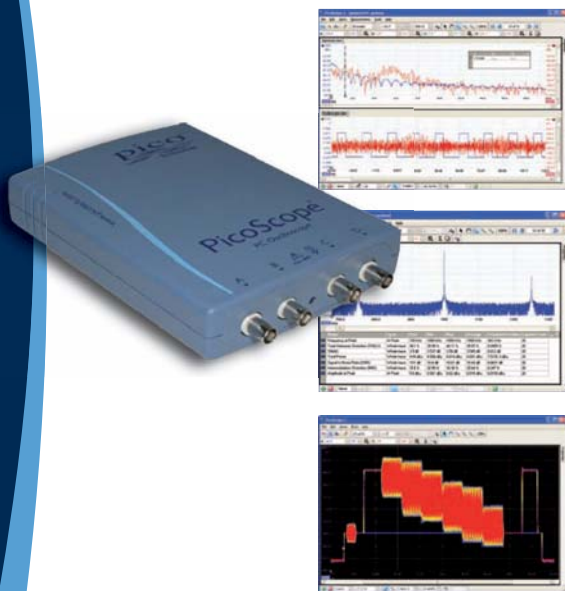

The PicoScope 4224 and 4424 High Resolution Oscilloscopes have true 12-bit resolution inputs with a vertical accuracy of 1%. This latest generation of PicoScopes features a deep memory of 32 M samples. When combined with rapid trigger mode, this can capture up to 1000 trigger events at a rate of thousands of waveforms per second.

- **PC-based** - capture, view and use the acquired waveform on your PC, right where you need it
- **Software updates** - free software updates for the life of the product
- **USB powered and connected** - perfect for use in the field or the lab
- **Programmable** - supplied with drivers and example code

Resolution	12 bits (up to 16 bits with resolution enhancement)
Bandwidth	20 MHz (for oscilloscope and spectrum modes)
Buffer Size	32 M samples shared between active channels
Sample Rate	80 MS/s maximum
Channels	PicoScope 4224: 2 channels PicoScope 4424: 4 channels
Connection	USB 2.0
Trigger Types	Rising edge, falling edge, edge with hysteresis, pulse width, runt pulse, drop out, windowed

SHERWOOD ELECTRONICS

Buy 10 x £1 Special Packs and choose another one FREE

SP1	15 x 5mm Red LEDs	SP137	4 x W005 1.5A bridge rectifiers
SP2	12 x 5mm Green LEDs	SP138	20 x 2.2/63V radial elect. caps.
SP3	12 x 5mm Yellow LEDs	SP142	2 x CMOS 4017
SP5	25 x 5mm 1 part LED clips	SP143	5 Pairs min. crocodile clips
SP6	15 x 3mm Red LEDs		(Red & Black)
SP7	12 x 3mm Green LEDs	SP144	5 Pairs min. crocodile clips
SP8	10 x 3mm Yellow LEDs		(assorted colours)
SP9	25 x 3mm 1 part LED clips	SP146	10 x 2N3704 transistors
SP10	100 x 1N4148 diodes	SP147	5 x Stripboard 9 strips x
SP11	30 x 1N4001 diodes		25 holes
SP12	30 x 1N4002 diodes	SP151	4 x 8mm Red LEDs
SP18	20 x BC182B transistors	SP152	4 x 8mm Green LEDs
SP20	20 x BC184B transistors	SP153	4 x 8mm Yellow LEDs
SP23	20 x BC549B transistors	SP154	15 x BC548B transistors
SP24	4 x CMOS 4001	SP156	3 x Stripboard, 14 strips x
SP25	4 x 555 timers		27 holes
SP26	4 x 741 Op Amps	SP160	10 x 2N3904 transistors
SP28	4 x CMOS 4011	SP161	10 x 2N3906 transistors
SP29	4 x CMOS 4013	SP164	2 x C106D thyristors
SP33	4 x CMOS 4081	SP165	2 x LF351 Op Amps
SP34	20 x 1N914 diodes	SP166	20 x 1N4003 diodes
SP36	25 x 10/25V radial elect. caps.	SP167	5 x BC107 transistors
SP37	12 x 100/35V radial elect. caps.	SP168	5 x BC108 transistors
SP38	15 x 47/25V radial elect caps	SP172	4 x Standard slide switches
SP39	10 x 470/16V radial elect. caps.	SP173	10 x 220/25V radial elect. caps
SP40	15 x BC237 transistors	SP174	20 x 22/25V radial elect. caps
SP41	20 x Mixed transistors	SP175	20 x 1/83V radial elect. caps.
SP42	200 x Mixed 0.25W C.F. resistors	SP177	10 x 1A 20mm quick blow fuses
SP47	5 x Min. PB switches	SP178	10 x 2A 20mm quick blow fuses
SP49	4 x 5 metres stranded-core wire	SP181	5 x Phono plugs - asstd coils
SP102	20 x 8-pin DIL sockets	SP182	20 x 4.7/63V radial elect. caps.
SP103	15 x 14-pin DIL sockets	SP183	20 x BC547B transistors
SP104	15 x 16-pin DIL sockets	SP186	8 x 1M horizontal trim pots
SP109	15 x BC557B transistors	SP189	4 x 5 metres solid-core wire
SP112	4 x CMOS 4093	SP192	3 x CMOS 4066
SP115	3 x 10mm Red LEDs	SP195	3 x 10mm Yellow LEDs
SP116	3 x 10mm Green LEDs	SP197	6 x 20-pin DIL sockets
SP118	2 x CMOS 4047	SP198	5 x 24-pin DIL sockets
SP124	20 x Assorted ceramic disc caps	SP199	5 x 2.5mm mono jack plugs
SP130	100 x Mixed 0.5W C.F. resistors	SP200	5 x 2.5mm mono jack sockets
SP131	2 x TL071 Op Amps		
SP133	20 x 1N4004 diodes		
SP134	15 x 1N4007 diodes		
SP135	5 x Miniature slide switches		
SP136	3 x BFY50 transistors		

RESISTOR PACKS - C.Film

RP3	5 each value - total 365 0.25W	£3.40
RP7	10 each value - total 730 0.25W	£4.65
RP10	1000 popular values 0.25W	£6.60
RP4	5 each value - total 305 0.5W	£4.20
RP8	10 each value - total 610 0.5W	£6.85
RP11	1000 popular values 0.5W	£8.95

Catalogue available £1 inc. P&P or
FREE with first order.
P&P £1.75 per order. NO VAT
Cheques and Postal Orders to:
SHERWOOD ELECTRONICS,
10 NEWSTEAD STREET,
MANSFIELD, NOTTS. NG19 6JJ

e CRICKLEWOOD ELECTRONICS

Established 1981



Frustrated with your supplier?
Visit our component packed
website for a vast range of
parts - old and new,
many unavailable elsewhere!
www.cricklewoodelectronics.com

1000's OF PRICES REDUCED!

Alternatively phone us on
020 8452 0161 with your
requirements.



Visit our Shop, Call or Buy online at:
www.cricklewoodelectronics.com

020 8452 0161 Visit our shop at:
40-42 Cricklewood Broadway
London NW2 3ET

Diatomic Power

Renewable energy, from non-fossil fuel sources, is what we want. Solar cells don't come cheap, but a recent discovery based on algae may change all this. Mark Nelson examines the process and its prospects.

WIND, wave and solar power each have their advantages and protagonists, and while wind and waves come and go, there's always light (for half of the day in most places). Bright sunlight is not essential for electricity generation from solar cells; average daylight is good enough for efficient ones. So why don't we make more of PV (photovoltaic) technology, to use the proper name?

In a word (or two), cost-effectiveness. PV power is expensive: efficient solar cells are too expensive for most applications and cheap solar cells are inefficient. An effective array of cheap solar cells tends to be very bulky and while this is not a problem for some applications, it's hardly an elegant or universal solution.

Pinball wizards

Before solar cells can take centre stage for power generation something has to be done to improve their cost-efficiency ratio and nobody imagines this can be an overnight discovery. Scientists the world over are working on this 'holy grail' project and currently one of the most interesting developments comes from researchers in the Pacific Northwest in the USA.

Engineers at Oregon State University have discovered a way to use an ancient life form to create one of the newest technologies for solar energy. Even better, their systems may be significantly simpler to build than existing silicon-based solar cells.

The key to their discovery is diatoms, or rather the shells of these marine algae. Diatoms are tiny, single-celled life forms that have existed in the oceans for at least 100 million years. The basis for much of other life in the oceans, they possess rigid shells that can be used to create order in a natural way at the extraordinarily small level of nanotechnology.

By using biology instead of conventional semiconductor manufacturing approaches, researchers at Oregon State University and Portland (Oregon) State University have created a new way to make 'dye-sensitized' solar cells, in which photons bounce around as if in a pinball machine, striking these dyes and producing electricity. Although this technology may be slightly more expensive than some existing approaches to making dye-sensitized solar cells, it has the potential to triple the electrical output.

End of the road for silicon?

"Most existing solar cell technology is based on silicon and is nearing the limits of what we may be able to accomplish with that," says Greg Rorrer, an OSU professor of chemical engineering. "There's an enormous

opportunity to develop different types of solar energy technology, and it's likely that several forms will ultimately all find uses, depending on the situation."

Dye-sensitized technology, for instance, uses environmentally benign materials and works well in lower light conditions, he continues. And the new findings offer advances in manufacturing simplicity and efficiency.

Different approach

"Dye-sensitized solar cells already exist," Rorrer said. "What's different in our approach are the steps we take to make these devices, and the potential improvements they offer."

The new system is based on living diatoms, which are extremely small, single-celled algae, which already have shells with the nanostructure that is needed. They are allowed to settle on a transparent conductive glass surface, and then the living organic material is removed, leaving behind the tiny skeletons of the diatoms to form a template.

A biological agent is then used to precipitate soluble titanium into very tiny 'nanoparticles' of titanium dioxide, creating a thin film that acts as the semiconductor for the dye-sensitized solar cell device. Steps that had been difficult to accomplish with conventional methods are made easy through the use of these natural biological systems, using simple and inexpensive materials.

"Conventional thin-film, photo-synthesising dyes also take photons from sunlight and transfer it to titanium dioxide, creating electricity," explains Prof. Rorrer. "But in this system the photons bounce around more inside the pores of the diatom shell, making it more efficient."

Confession time

Rorrer is honest enough to confess that the physics of this process are not fully understood. Nevertheless, it definitely works. More so than materials in a simple flat layer, the tiny holes in diatom shells appear to increase the interaction between photons and the dye to promote the conversion of light to electricity, and improve energy production in the process.

Diatoms are ancient, microscopic organisms that are found in the fossil record as far back as the time of the dinosaurs. They are a key part of the marine food chain and help cycle carbon dioxide from the atmosphere. But in recent years their tiny, silica shells have attracted increasing attention as a way to create structure at the nano level. Nature is the engineer, not high-tech tools. This is providing a more efficient, less costly way to produce some of the most advanced materials in the world.

Clever creatures

Regular readers of this magazine will, of course, know already that diatoms are clever creatures and have other scientific applications. Back in 2007 we reported how Prof. Ken Sandhage from the Georgia Institute of Technology was using diatoms to create gas sensors able to detect pollution more rapidly and efficiently than conventional devices.

Researchers in Georgia had created a new class of gas sensors based on diatoms, using a chemical process that converts the shells' original silica (silicon dioxide, SiO₂) into the semiconductor material silicon. The converted shells, which retain the 3D shape and nanoscale detail of the originals, could also be useful as battery electrodes, chemical purifiers and in other kinds of application requiring complex shapes that nature can produce better than humans.

There's no shortage of designs in this marine Meccano set, either.

According to the *Aquatic Microbe Forum*, some 100,000 species of diatoms exist in nature, and each forms a microshell with a unique and often complex 3D shape that includes cylinders, wheels, fans, doughnuts, circles and stars. Sandhage and his research team have worked for several years to take advantage of these complex shapes by converting the original silica into materials that are more useful. Since scientists already know how to culture diatoms in large volumes, harnessing the diatom genetic code could allow mass-production of complex and tailored microscopic structures.

Says Sandhage, "Diatoms are fabulous for making very precise shapes, and making the same shape over and over again by a reproduction process that, under the proper growth conditions, yields microshells at a geometrically-increasing rate. Diatoms can produce three-dimensional structures that are not easy to produce using conventional silicon-based processes. The potential here is for making enormous numbers of complicated 3D shapes and tailoring the shapes genetically, followed by chemical modification as we have conducted to convert the shells into functional materials such as silicon."

Puzzle find

Changing subject, if you're a seasoned visitor to amateur radio rallies, you'll know how the strangest things can turn up for sale. Vibrators for generating alternating current from battery supplies are not uncommon finds at these events, but the recent Dunstable Downs electronics boot fair had some externally driven vibrators. Does any reader know how these worked and what kind of drive was required? And no, I didn't buy one of them!

FREE
CD-ROM

ELECTRONICS TEACH-IN 2

£7.99

FROM THE PUBLISHERS OF
EP EVERYDAY PRACTICAL
ELECTRONICS

USING PIC MICROCONTROLLERS

A practical introduction

- ★ Breadboard layouts to aid understanding
- ★ Free software on CDROM
- ★ Simple programmer project
- ★ Free PIC Toolkit software

Everything you need
to get you started



PLUS PIC N' MIX

A host of practical
programming and
interfacing information

C FOR PIGS

A beginners guide
to using the C
programming
language to programme
PIC microcontrollers

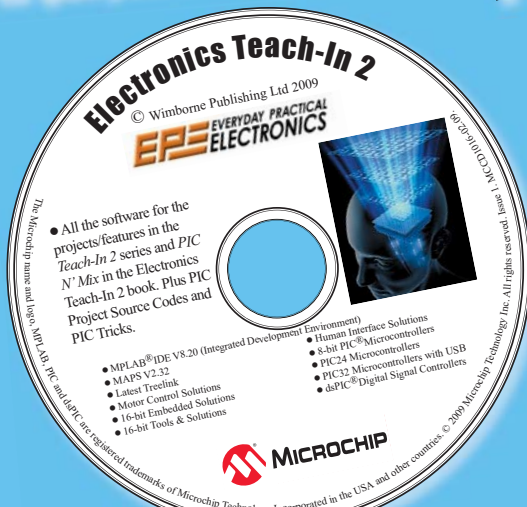

● All the software for the projects/features in the Teach-In 2 series and PIC N' Mix in the Electronics Teach-In 2 book. Plus PIC Project Source Codes and PIC Tricks.

- MPLAB® IDE V8.20 (Integrated Development Environment)
- MAPS V2.32
- Latest TreeLink
- Motor Control Solutions
- 16-bit Embedded Solutions
- 16-bit Tools & Solutions
- Human Interface Solutions
- 8-bit PIC® Microcontrollers
- PIC32 Microcontrollers with USB
- PIC32 Microcontrollers with USB
- dsPIC® Digital Signal Controllers

 MICROCHIP

ISBN 978-1-898805-16-8



9 781898 805168

ELECTRONICS TEACH-IN 2

now on sale in WHSmiths
or available direct from us:

01202 873872
www.epemag.com



Simple Data-Logging Weather Station

Part 2 –
by Glenn Pure

This month, we get into the nitty-gritty of building it – all the mechanical detail and then the actual construction.

BY NOW, we've hopefully whetted your appetite with this simple design. Most of the mechanical detail here is 'roll your own', but there is an alternative commercial rain sensor available if you don't have the time or inclination to make one – see later. For those who do, read on!

Rain sensor

The rain sensor uses a tipping bucket mechanism, consisting of a rain collection funnel that feeds water into a pivoting bucket divided into two opposing halves. When one side of the

bucket fills and tips, it empties itself, at the same time positioning the opposing side under the funnel outlet, where it can fill, tip and repeat the cycle.

The tipping back and forth can be detected in various ways. Since power consumption was important for this project, a passive sensing mechanism was chosen. This involves momentarily closing a switch each time the bucket tips. As shown in the circuit diagram last month (Fig.1), the switch (S3) closure pulls the rain sensor line low (it is normally held high by a 220k Ω pull-up resistor).

To keep the design simple and maximise reliability, a magnetic reed switch, mounted on a bracket next to the tipping bucket, was used.

The switch is closed by a tiny 'rare-earth' magnet (measuring only 3 × 2mm) that is mounted on the tipping bucket. As the bucket swings, the magnet moves past the reed switch, closing it for a brief moment.

A similar mechanism is found in many commercial rain sensors, and because the reed switch is glass-sealed, it has the advantage of being practically immune to moisture and corrosion.



The main funnel is glued using silicone sealant into a 100mm PVC pipe end cap, which has its end removed. Note the mesh leaf and insect trap on the bottom end.

To achieve its light weight and non-magnetic properties, the tipping bucket and its mount are made from 0.7mm thick aluminium sheet. You may well have some of this in your junk box, salvaged from those utility boxes that come with both an aluminium lid and a plastic one.

The only problem with using this sheeting is that it is work-hardened, making it difficult to bend and shape easily. This can be fixed simply by heating, which will anneal the aluminium and make it much easier to shape. I used a blow torch for maybe 10 or 20 seconds, with the flame constantly moving over the piece.

Do **not** heat it so that it starts to glow. If you don't have a blowtorch, try sitting the sheet on an electric stove (solid) hotplate for a minute or two.

Tipping bucket

However, before annealing the sheet, mark out and cut the bucket



Here's the way the magnet is mounted on the tipping bucket – it (or in some cases they) is (are) glued into this hole made in the side (top) of the tipping bucket.



The water then passes into a secondary funnel, mounted on a U-shaped bracket fixed to another (complete) PVC pipe end cap. You can see this end cap in the next photo.

according to the plan shown in Fig.4. For accurate cutting, use a utility knife to score the sheet repeatedly, then bend it back and forth along the score line to snap it (bending it only 10° or so each way is enough). Practise on a scrap piece – you will quickly get the idea.

Next, very lightly score a line along the centres of the drill holes. Continue this line across the whole width of the sheet, as it is useful later when centring and mounting the divider between the two halves of the bucket.

Drill the holes now, as it is a lot easier before the bucket is bent into shape. The holes for the axle in the tipping bucket should be very slightly larger than the axle, and located as marked on the template. It's important that the axle sits close (a millimetre or two) below the bottom of the main body of the bucket, as this makes for more sensitive operation.

Now anneal the sheet, then proceed to bend it into shape. Start by bending

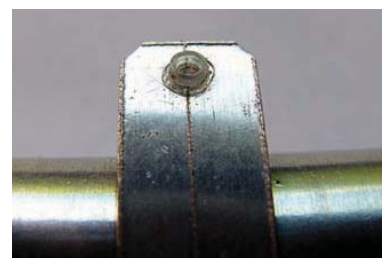

Another close-up of an important part: the plastic washer which stops the bucket mechanism fouling the mounting bracket. Without this, the readings may be erroneous.



Under the secondary funnel is the tipping bucket mechanism, which fills with water and tips when it gets too heavy. A magnet on the tipper trips a reed switch to indicate one 'fill'.

the bucket supports (containing the axle holes) back down against the body of the bucket. Keep the bend sharp, for example by clamping along the bend line in a vice.

Next, shape the main body of the bucket by bending it over a tube or rod about 25 to 30mm in diameter. A broom handle works well, as does some one-inch diameter PVC pipe. Make sure the result is symmetrical and even in shape, both lengthways and sideways. The aluminium should be quite soft and easy to reshape if necessary.

Finally, cut a divider to separate the two halves of the bucket. The width of the divider will depend on the diameter of the rod used to shape the bucket.

The divider is 'glued' into place using a small amount of silicone sealant or epoxy. It's a good idea to include narrow (3mm wide) right-angle flanges on the sides of the divider to help glue it in



Once the bucket has tipped and the water measured, it needs to escape. These mesh-covered holes in the pipe end cap are for that purpose. Note the measurement for the two screw holes.

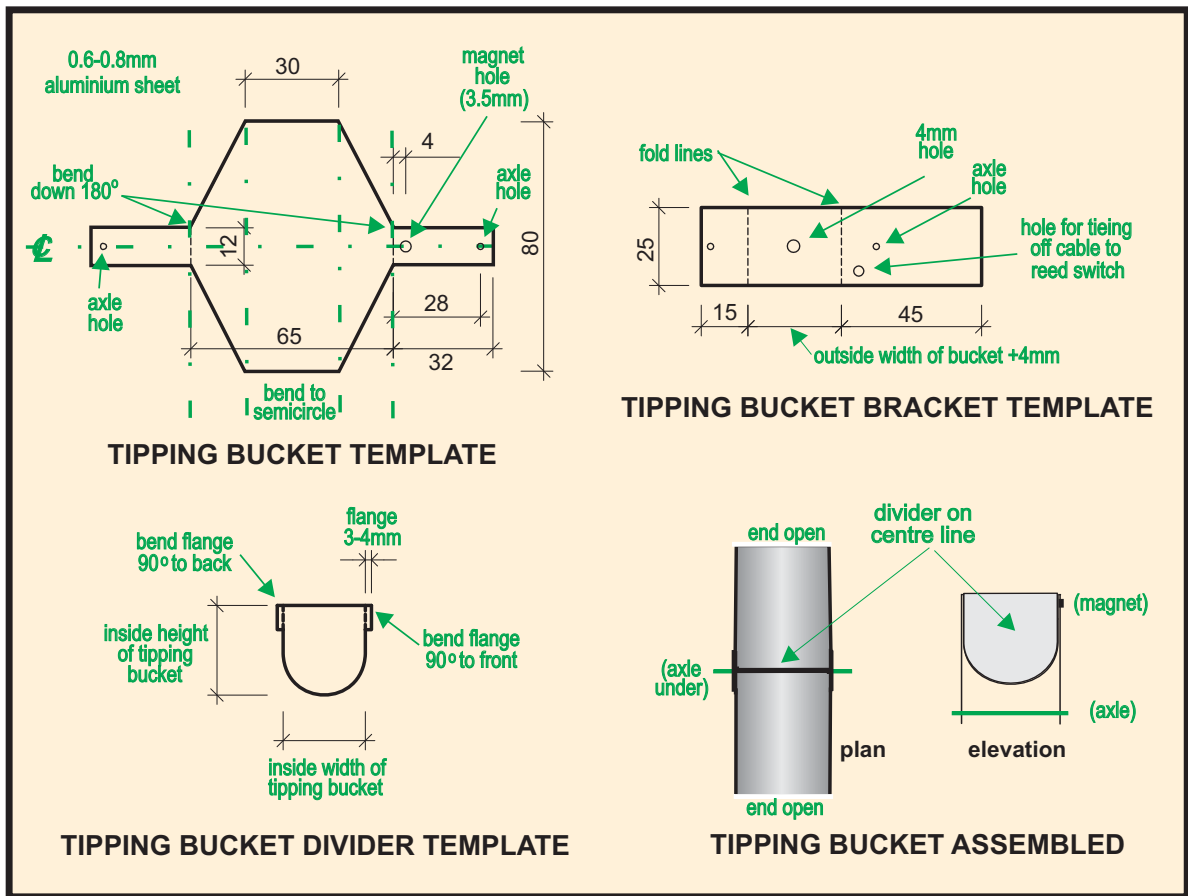

Fig. 4: follow this diagram to make the tipping bucket assembly for the Simple Data Logging Weather Station.

place (see template). Once the glue has set, smear a thin bead of silicone sealant along the edge of the divider, where it meets the inside of the bucket, to ensure water doesn't flow from one half of the bucket to the other. A cotton tip from the medicine cupboard will do the trick. Minimise the amount of silicone applied, but apply it to both halves of the bucket to better balance the two sides.

The rare earth magnet can now be glued into the locator hole on the upper side of the tipping bucket – see Fig. 4 and photo.

One more thing is needed to finish the tipping bucket. When it is in operation, it appears to empty more efficiently and consistently if the inside surface of the bucket is water repellent.

This can be achieved by coating it with a silicone car polish. Don't be tempted to smear a thin coat of silicone sealant as this tends to be sticky and collects fine particles over time, impeding the proper operation of the tipping bucket.

Axle and bracket

The tipping bucket pivots on a thin axle. For this, a short length of stainless steel wire (1.4mm in diameter) was used, although galvanised steel wire would probably be fine. The diameter isn't critical. The wire was obtained from the whisk part of a stainless steel egg whisk.

A bracket to mount the tipping bucket on its axle can now be made from another piece of aluminium sheet (don't use steel sheet as it is magnetic). Again, drill the holes in this for the axle before bending.

The exact dimensions of the bracket will depend on the width of the tipping bucket. Precision isn't necessary, since washers or spacers should be used to keep the tipping bucket away from direct contact with the bracket, ensuring an unimpeded tipping action.

Such spacers (or washers) are also important to ensure minimum sideways play of the tipping bucket on

the axle. Avoiding such play will keep the magnet on the bucket positioned a constant distance from the reed switch each time it swings past. A distance of about 3 to 4mm should be the target (face of magnet to centre axis of reed switch). Adjustment of the bracket to achieve the correct spacing is made by simply bending it.

If the magnet is too close, the force of attraction between it and the reed switch can be sufficient to cause the tipping bucket to lock in the centre position. If the gap is too great, the reed switch simply won't close. The spacers can be cut from the end of the plastic ink tube of a ballpoint pen.

Reed switch

The reed switch is glued to the outside of the bracket that holds the tipping bucket. Be aware that the part of the reed switch that is most sensitive to the magnet is either end of the switch, not the middle of it. Therefore, ensure the reed switch is mounted

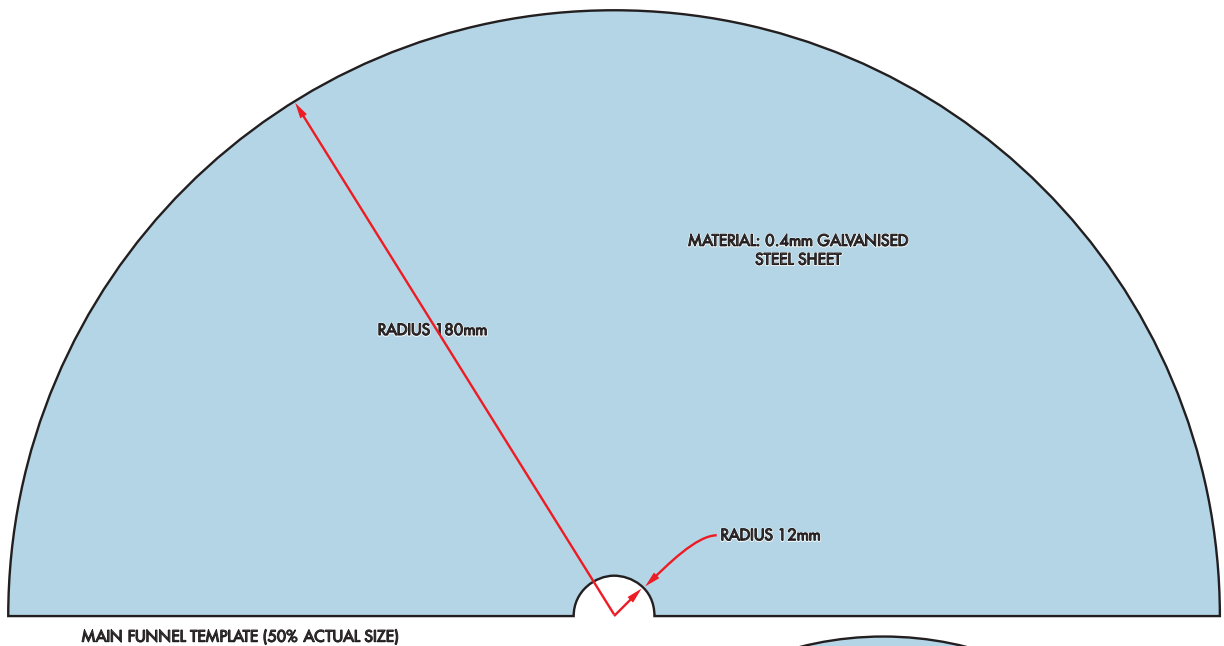
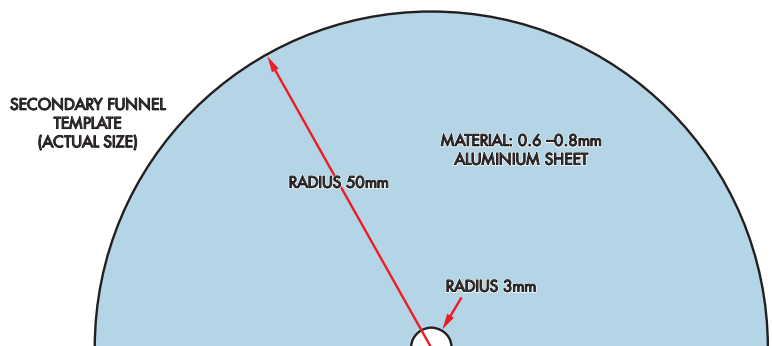

Fig.5: these two templates will help you make your main (primary) and secondary funnels. The main funnel catches the rain, the secondary funnel directs it into the tipping mechanism. Note that the main funnel template needs to be blown up 200% when photocopying, otherwise it will be a tad too small! The overlap when you bend the funnel shapes should be about 8mm. Seal this overlap with silicone sealant.



so the magnet swings past one end (see Fig.6). A separation of 3 to 4mm between the magnet and the reed switch is best.

Care is needed when soldering wires to the reed switch, since it appears to partly melt at soldering temperature. Hence it is essential to use a good heat-sink between the switch and the end of the wire being soldered (firmly gripping with a pair of needle-nose pliers will achieve this).

Once soldered up, the switch and connections should be covered with sealant to waterproof them, since the connecting wires on the switch are made from steel and will corrode over time if they get wet.

Rain funnels

The tipping bucket is housed inside a length of 100mm diameter PVC sewer pipe. A rain collection funnel is fitted to the top end of the pipe. The funnel was made from thin (0.4mm) galvanised steel sheet (see Fig.5).

After bending, it was held in shape with pop rivets, then the joint was soldered up, although silicone sealant would be fine also. A piece of fine wire gauze was then bent and glued over the bottom end of the funnel. The gauze was scavenged from a frying pan cover – the type used to stop fat spattering. Two-part epoxy or silicone sealant would be fine to glue this in place.

To fit the funnel to the top of the pipe, use a PVC pipe end cap. Cut the end out of this cap, effectively leaving only the side wall, which now forms a 'plastic ring'.

Fix the funnel into this ring with acrylic or silicone sealant. Since neither of these sealants will stick very well to the PVC, it's a good idea to run a bead of epoxy around the inside of the ring, after the sealant has cured. Make sure there is no sealant or glue fouling the inside of the PVC ring, otherwise it won't slide onto the pipe later.

By mounting the funnel this way, it will slip nicely over the end of the pipe and be held in place by gravity. A hole tapped into the pipe and a machine screw can always be added to make sure it doesn't move.

A small secondary funnel has also been included. This sits between the main collection funnel and the tipping bucket and enables the rain collected from the main funnel to be aimed accurately into the tipping bucket mechanism.



Just in case you haven't come across one before, this is a glass-encapsulated magnetic reed switch of the type used in this project. Its contacts are normally open, and close in a magnetic field. The most sensitive areas of a reed switch are towards each end.

Constructional Project

It's best to make the secondary funnel from annealed aluminium sheet, since this is much easier to bend into shape. This funnel is held over the tipping bucket by a U-shaped bracket. It would be a good idea to coat the inside surface of the secondary funnel, so that it is also water repellent (as you did for the tipping bucket surface).

The tipping bucket itself, along with the secondary funnel, is bolted onto another end cap, which slips onto the bottom of the PVC pipe. The two are mounted together to keep them in good alignment.

Two M4 × 20mm long screws (with locking nuts) have also been tapped into the end cap and sit underneath each half of the tipping bucket (see photo). They are used to adjust the amount the bucket will hold before it tips. Brass or stainless steel machine screws (M4) and nuts should be used throughout for corrosion resistance.

There are two larger holes opposite one another near the edge of the end cap. The holes should be about 12 to 15mm in diameter and are the exit points for the water from the tipping bucket when it tips. Make sure the outside of these holes are also covered with fine wire gauze (glued in place) so that insects or other debris cannot get inside the sensor and foul the mechanism.

Calibration

Once the sensor is assembled, calibration can then be done. Make sure the end cap is placed on a level surface before starting. Calibration is done by slowly dripping water into the primary or secondary funnel and measuring how much it takes before the bucket tips.

Do this 10 or 20 times and average the results. Aim for about 5ml each time, using the adjustment screws under each side of the bucket to fine-tune the tipping point. Ensure the same amount of water is needed no matter which direction the bucket is tipping.

To convert the amount needed to cause the bucket to tip into millimetres of rain, first measure the diameter of the top of the primary funnel in centimetres then calculate the area of this opening. (To find the area, divide the diameter by two to get the radius, square this value then multiply by π (ie, 3.1416)).

The area in square centimetres will be the number of millilitres of rain the funnel will collect for every 10mm of rainfall. You will get a value of about 250ml for a 180mm diameter funnel, or about 25ml per mm of rainfall. If it takes 5ml to fill and tip the bucket each time, that is 0.2mm of rainfall for each bucket tip.

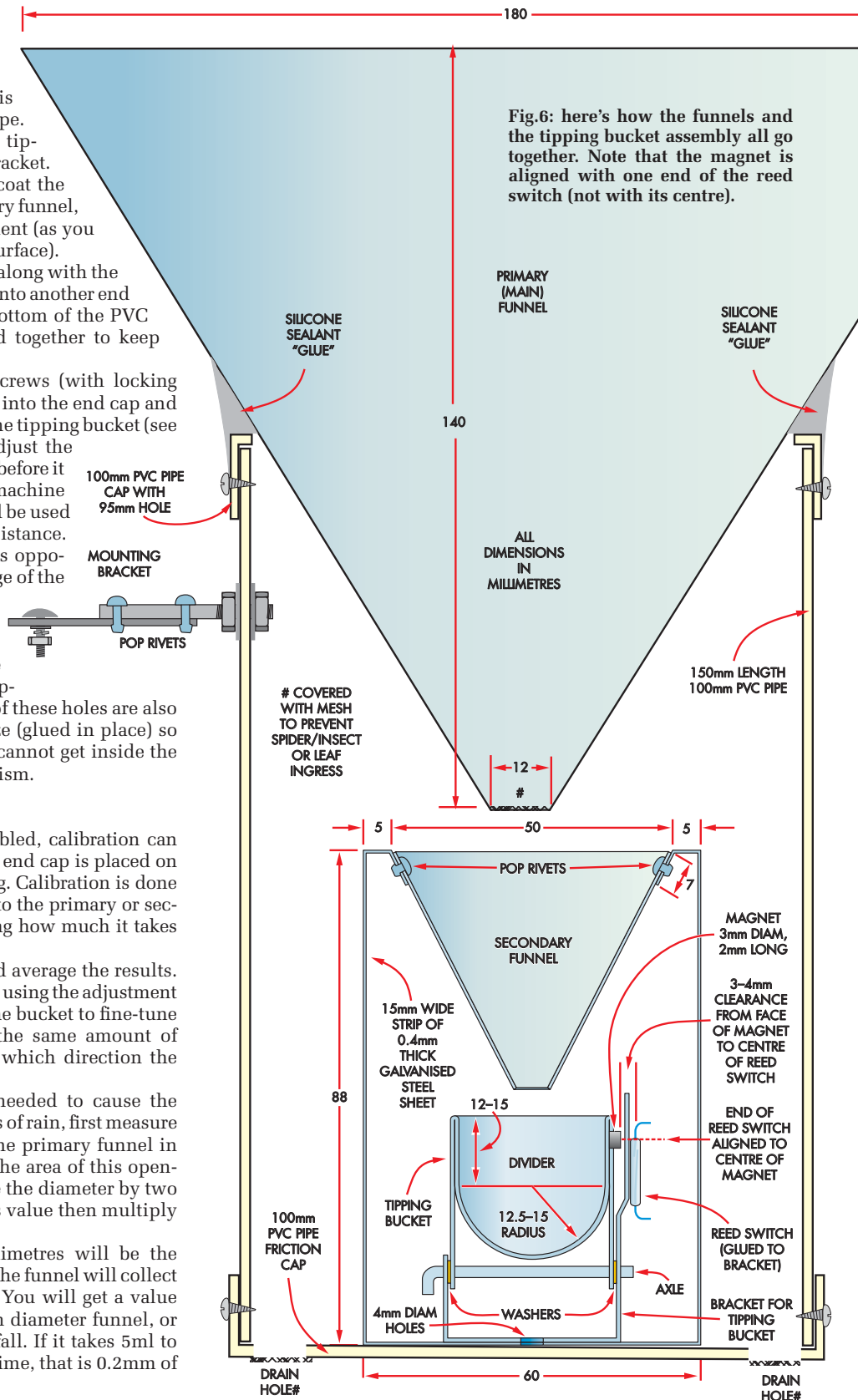

Electronics housing

We showed the electronics 'box' in Part 1 last month. However, it needs to be housed so that it is protected from the elements.

A 'case' can be made from the same 100mm PVC pipe and a friction-fit pipe end, as used to make the rain gauge. However, in this instance, I elected to use only a top cover, leaving the bottom open to the elements 'just in case' something leaked and it filled with water.

The 'electronics' box is not secured to the pipe; rather it hangs from a simple metal bracket mounted on the pipe top cover. The cabling simply drops out of the bottom of the case.

All cabling must be secured to star pickets or to some other mounting pole – a cable dangling in the breeze is too much of a temptation for curious wildlife and household pets!

Mounting the sensors and the controller

Most of the hard work is now almost completed. The main job left to do is to assemble and mount the bits and pieces. Since this is designed for use in remote locations, it is assumed that a quick and simple way to mount the

sensors and weatherproof the electronics is needed.

A star picket, commonly used for fencing was used. These have convenient pre-drilled holes, through which brackets made from bolts and steel strips can be mounted. The photos illustrate how to make these up.

The mount for the rain gauge is constructed so that it can be tilted on two axes, enabling the sensor to be levelled when installed. Specifically, the base of the sensor, on which the tipping bucket is mounted, should be set so it is level, otherwise accuracy will be degraded.

By the way, I haven't done a check to see how accurate the rain gauge is, but commercial units of this type are typically accurate to within a few percent.

As indicated above, the control box containing the electronics is also fitted inside a length of PVC sewer pipe fitted with an end-cap. This end-cap is fitted with a metal bracket bent up from a piece of sheet metal. A second bracket is attached to the plastic box, so that it can be hung in place – see photos.

Initial set up

The only job to do is to perform the clock correction if accuracy better than about five seconds a day is needed.

First, start the weather station by inserting three AA batteries into the battery clip. The temperature or rain

sensors don't need to be connected. You will need an accurate means of measuring 24 hours to within a second or so. A handheld GPS or good quartz wristwatch will do the job.

Alternatively, find a time service on the internet. You will have to use one that gives a seconds reading and automatically increments this (for example, try www.timeanddate.com).

First, reset the controller using the Reset button. With the case open, press the clock correction switch (S2) momentarily and note the exact time it was pressed.

The LED will come on as soon as the switch is closed and stay on for four seconds to indicate that the clock correction process has successfully started. Note that the clock correction switch will be disabled 30 minutes after a reset (assuming the controller has been programmed with a 30 minute logging frequency).

At the same time the next day, about 20 seconds before 24 hours has elapsed, the LED will come on. At exactly 24 hours, press the clock correction switch again. The LED will turn off and the correction value will be stored. This value is stored in the PIC in non-volatile memory, so is retained even if power is removed from the PIC.

If you forget to press the switch, the LED will turn off after about 40 seconds,

Parts list (louvred housing)

All sheet metal used is 0.4mm thick galvanised steel (0.6mm thick aluminium is preferable for the louvres themselves but is harder to obtain).

Sheet metal

- 1 170 × 170mm (top cover)
- 1 150 × 150mm (top)
- 5 400 × 25mm (louvres)
- 4 110 × 20mm (corner supports – you should use galvanised steel for strength to make these, even if you do make the louvres from aluminium sheet)

Other

- 30 small pop rivets (to fix louvres to corner supports)
- 3 M4 × 30mm machine screws and nuts
- 3 M4 × 20mm tapped spacers
- 1 mounting bar made from aluminium channel (12 × 12mm), approx 150mm long (for mounting the housing)
- 2 6-8mm long pop rivets (for mounting bar)
- 1 50 × 8mm bolt, head cut off, with nut and two washers to suit (for mounting bar)

Parts list (rain gauge)

- 1 360mm square sheet metal (main funnel and bucket parts, U-shaped bracket)
- 1 100mm diameter semi-circle
- 1 150mm length of 100mm diameter PVC pipe with friction caps
- 1 magnetic reed switch
- 1 3mm diameter × 2mm rare earth magnet
- Various screws, pop rivets and scraps of metal

Reproduced by arrangement
with SILICON CHIP
magazine 2009.
www.siliconchip.com.au

Making The Temperature Sensor Housing

For accurate readings, the location of the temperature sensor is important. It must be placed so that it is not affected by radiant heat from the sun or other direct heat sources. It should also not get wet, as evaporation would cool a wet sensor – yet there should be free air movement around the sensor to enable it to be at equilibrium with the current air-temperature.

To achieve the right conditions, professional weather stations usually include a louvred housing that is typically mounted a fixed height above ground level (1.25 metres is apparently the international standard). The housing shades the sensor and stops it getting wet, while allowing free air flow.

If the housing itself gets hot, then it can heat air that passes through it and cause an incorrect reading at the sensor. Therefore, the housing should be painted white so as to minimise the absorption of radiated heat. It must also be designed to reduce the chance that the housing itself will create localised heating or cooling of the sensor that's different to the current air-temperature.

A louvred housing can be made relatively easily from thin sheet metal. Aluminium sheet about 0.6mm thick is ideal for ease of handling, low thermal mass and weight, but it may be hard to obtain. If this isn't available, use 0.4mm galvanised steel sheeting.

The housing design consists of a top, a top cover over this to improve

resistance to radiant heat from overhead, four vertical corner supports and five louvres made from bent sheet metal which fix directly to the corner supports. The easiest way to assemble the housing is with pop rivets. A piece of aluminium channel is also pop riveted or bolted on to the inner top cover for mounting the whole assembly.

Construction

Commence construction by cutting out all the sheet metal parts (see photo). The dimensions for these parts are given in the parts list on the previous page. Don't bend any of the parts yet. It's a good idea to drill the holes that will be needed for assembly now, since this is easier to do on flat (unbent) sheet.

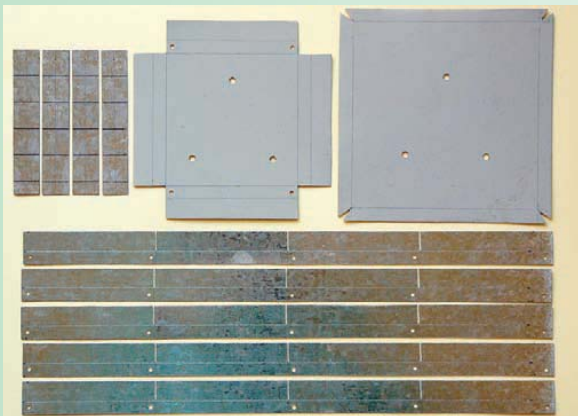

It's not a template, but this photo can be used as a cutting and drilling guide for your temperature sensor housing.

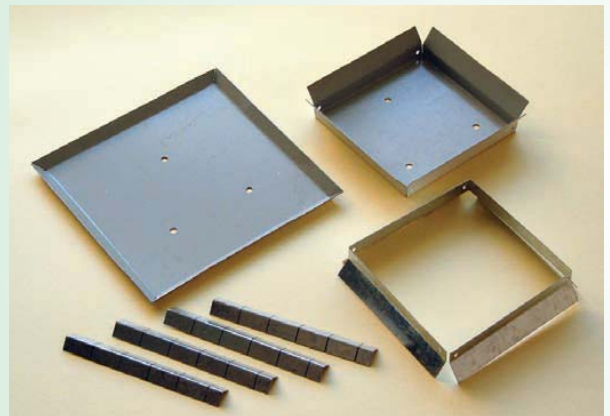

Here are the components for one side of the housing – the largest piece is the top cover, the four pieces below are side guides.

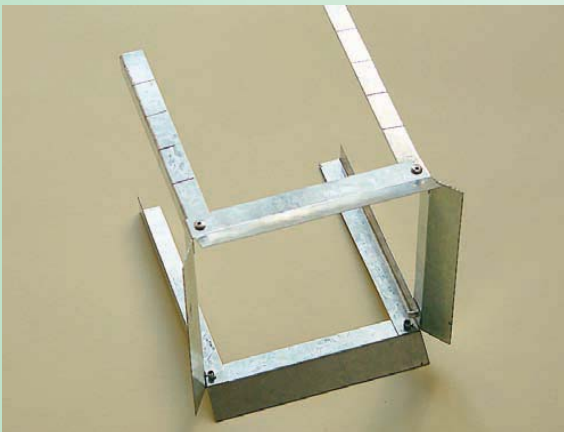

Here is that first louvre fixed to the four side supports. Once you have achieved this, the rest is easy!

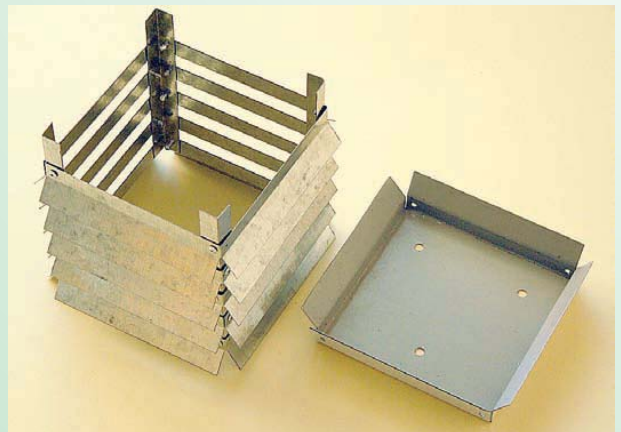

A few minutes later and all louvres are fitted, now ready for the top cover to be fixed in place.

Start with the top and top cover. First, tape them together in accurate alignment and drill three holes (4mm dia.) as shown in the photos – this will ensure that the holes in the top cover align with those in the top when you come to screw the top cover on. Four holes for pop rivets can also be drilled in the top – see photo below left.

Pop rivet holes can also be drilled in the louvres. Don't drill any holes in the corner supports though. Now bend the top and top cover into shape, as well as bending the corner supports and louvres as shown in the photo below.

Mark lines at 20mm intervals along the corner supports (these will be used to align the louvres). The last line marked will be only 10mm from the end of the corner support and is where the first (bottom-most) louvre will be mounted. Drill and pop rivet the bottom louvre to

the corner supports so its top edge aligns with the 10mm line (see photo).

The easiest way to drill the corner supports is to clamp a short length of scrap timber (19 × 42mm cross-section) to the work bench so it protrudes from the bench. Hold the corner support with a large bulldog clip while the louvre is placed over it and the hole is drilled (see photo).

The next louvre up can now be pop-riveted into place, aligning its top edge with the next mark 20mm along the corner support. Fix the remaining louvres into place. When all the louvres are fixed, the top can be pop riveted on. The top should slide nicely over the upper ends of the corner supports if you have measured, cut and bent accurately.

The housing is now almost finished. It's now time to make the mounting bar, which is made from a piece of

12mm aluminium channel – see below left. This makes it fairly straightforward to fit a bolt to the other end (an 8mm dia. bolt will fit easily in the channel).

The easiest way to hold the bolt in place is to put it in a vice and crush the top edges of the channel over the bolt shaft (see photo). Two-part epoxy will ensure it stays in place.

Next, rivet the mounting bar to the inner top cover, after first cutting away a portion of the channel so that the mounting bar will sit flat on the cover. The prototype louvred housing shown in the photos in Part 1 had the mounting bar fixed under the top cover, but this is clumsy so don't try it. Now fix the top cover in place with machine screws and spacers.

Finally, the housing should be painted white to minimise absorption of radiant heat. A can of fast drying spray paint is the easiest way to do this. Remember that several light coats are better than one heavy coat.

The temperature sensor (IC5 – see Part 1, last month) itself is mounted on short lengths of wire that are suspended from the corner supports of the louvred housing (simply bend them around the top of the corner supports between the top and the first louvre). The sensor should be mounted in about the centre of the louvred housing and can be held in place with a twist tie or short length of wire. Make sure it can't drop out when left unattended for a lengthy period.



Drilling holes in small, thin bits of metal is not only tricky, it can be dangerous if you don't properly clamp and support the work.

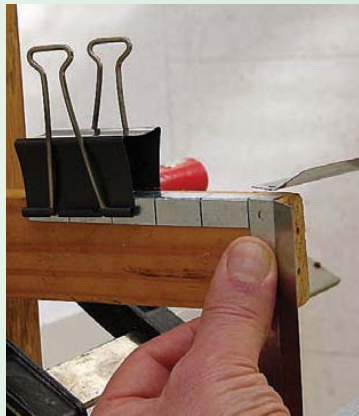

Here we are preparing the first louvre, ready for securing to the corner support with a pop rivet.



The mounting bar is made from a piece of U-shaped (channel) aluminium with an 8mm bolt crushed in position then secured with two-part epoxy. This is then secured to the (inner) top cover with pop rivets. The outer top cover, which helps prevent the housing from heating up and giving false readings, is mounted 12mm above the inner top cover by means of 12mm threaded nylon standoffs so there is no heat conduction from one part to the other.

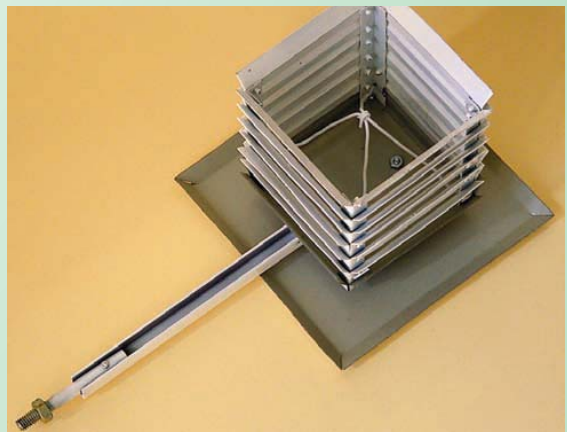

An upside-down finished view of the housing. The four stiff wires inside the housing support the temperature sensor.



Left: the controller box inside its PVC pipe case. It hangs free on brackets fixed as shown above. The pipe mounting bolt is flexible to allow the pipe to be moved at will.

but no correction value will be recorded and the controller will simply resume normal operation.

Logging weather data

Set up the rain and temperature sensors, power up the weather station, and reset it. Make a note of the time and date at which the reset occurred. The first data will be recorded 30 minutes (or one logging frequency) after the reset.

The rain and temperature sensors can be plugged in at any time, although, obviously, nothing will be recorded until they are.

Even though the temperature sensor is a programmable digital device, the software in the weather station enables

it to be plugged in and unplugged even when the weather station is operating. If the rain sensor is left unplugged or is faulty, zero values will be recorded for temperature.

There is nothing else to do, except come back in a month – or a year – and download the data.

Downloading the data

Downloading data is straightforward. Instructions are printed on the front label of the weather station (see Fig.7). Freeware data-logging software is used to receive the data (see below) on your computer or laptop. This software will write the data to any file you nominate.

Data is transmitted in text form as comma-separated values that can easily be imported into spreadsheets. A 'header' is transmitted first, listing the total number of data points recorded since the last reset.

The weather station does not record the time directly. You will need to calculate the time of each data record based on the time the weather station was reset (or powered up) and the logging frequency. Don't forget that the first data set isn't recorded until one logging period after the weather station is started.

Error detection

Some basic error detection is also built into the software. When each data record is written, the value 255 (decimal) is also written to all four bytes of the next record.

During a data dump, if the weather station software encounters these values, it will transmit the following text string 'BREAK' then 'NULL' on the next line.

Since data only up to the last valid record are normally transmitted, such a BREAK will never be seen during a normal dump operation. It will occur if there was a power down and power up, or an internal reboot of the weather station while it was operating.

A reboot will occur if the software detects some abnormal conditions during operation, such as a suspicious looking interrupt. It can also occur if the internal record counter becomes corrupted, although this is unlikely.

An entire dump of the weather station's data can also be performed. This will show a BREAK where data finished recording following the most recent reset. BREAKs may also be seen further into the data record from some earlier resets (only those that weren't overwritten since the last reset).

Performing a full data dump of the entire EEPROM contents is easy. Simply do a reset on the weather station just before doing a data dump.

A sample spreadsheet (Fig.8.) is attached showing weather data recorded in the author's backyard in Canberra. Some plots of the data are also shown, including

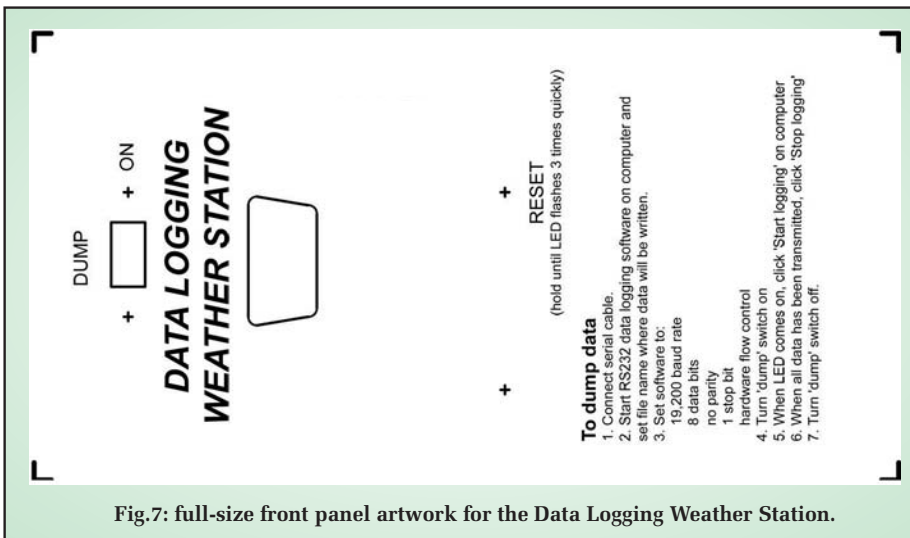

Fig.7: full-size front panel artwork for the Data Logging Weather Station.

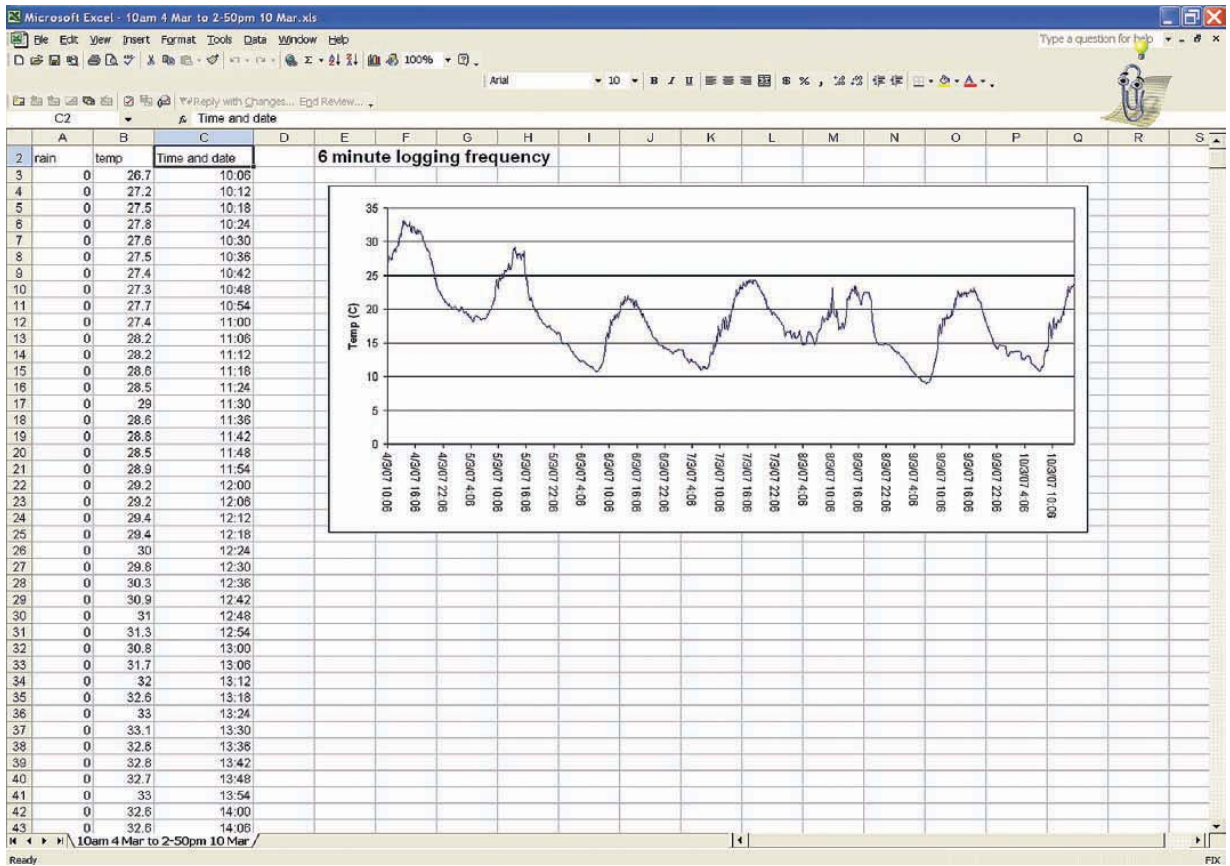

Fig. 8: an Excel spreadsheet from the author's installation. Because the data from the Weather Station is virtually 'universal' in format, it can be used in a wide range of applications.

a very heavy rain event where about 50mm fell in 30 minutes. The rain gauge is able to handle both heavy and light rainfall events, although you can expect problems with extremely heavy rain or hail storms.

Changing logging frequency

The firmware is nominally written for a 30-minute logging frequency, meaning rain and temperature will be recorded every 30 minutes. The logging frequency can be changed by modifying the firmware, recompiling this and reprogramming the resultant hex file into the PIC.

The software for the PIC contains the following defined constants near the start:

```
LOG_FREQ EQU D'6' ; Frequency
              (minutes) with which data is logged
HRS24 EQU D'240' ; =
              (No of minutes in 24 hours)/LOG_FREQ
```

Changing these will change the logging frequency. The above example shows a logging frequency of six

minutes. Setting LOG_FREQ to 30 (decimal) and HRS24 to 48 (decimal) will give a 30-minute logging frequency and a normal 24-hour clock.

Logging frequencies down to one minute are possible, but the HRS24 value can only be a maximum of 255. The only thing HRS24 affects is the frequency with which clock error correction occurs (including the initial setting of the clock error).

So, if LOG_FREQ is set to 1 and HRS24 set to 255, the PIC will apply the clock correction value every LOG_FREQ x HRS24 minutes (ie, 1 x 255 minutes).

Similarly, performing an initial clock calibration will complete 255 minutes after it is started, not 24 hours later.

Obtaining parts and software

The data logging software is available from www.eltima.com/products. Download the freeware 'RS232 data logger' under 'serial port software'.

Buying the magnet 'mail order' is a case where it costs far more to pack and

post than the (tiny) items are worth.

If you wish to avoid the high pack and post charges, I'm willing to provide them for a nominal shipping charge. Check my web page for details (www.evans-pure.net/weather.htm).

Alternatively, you may be able to scrounge a suitable magnet or two from, say, an old hard disk drive. Most reed switches are quite sensitive and will work with most magnets. The advantage of the 'rare earth' magnets used here is their incredible size-to-power ratio.

Commercial rain sensor

For those who don't want to make their own rain sensor, a commercially available sensor is available for about \$90 (US). It uses a similar mechanism to the sensor described here. It is made by Peet Bros in the US – see their website: www.peetbros.com. You will need to order the 'Rain gauge – wired'.

I haven't tested it myself, but have investigated its specifications and am confident it will work. **EPE**

STORE YOUR BACK ISSUES ON CD-ROMS



- VOL 1: BACK ISSUES** – January 1999 to June 1999
Plus some bonus material from Nov and Dec 1998
- VOL 2: BACK ISSUES** – July 1999 to December 1999
- VOL 3: BACK ISSUES** – January 2000 to June 2000
- VOL 4: BACK ISSUES** – July 2000 to December 2000
- VOL 5: BACK ISSUES** – January 2001 to June 2001
- VOL 6: BACK ISSUES** – July 2001 to December 2001
- VOL 7: BACK ISSUES** – January 2002 to June 2002
- VOL 8: BACK ISSUES** – July 2002 to December 2002
- VOL 9: BACK ISSUES** – January 2003 to June 2003
- VOL 10: BACK ISSUES** – July 2003 to December 2003
- VOL 11: BACK ISSUES** – January 2004 to June 2004
- VOL 12: BACK ISSUES** – July 2004 to December 2004
- VOL 13: BACK ISSUES** – January 2005 to June 2005
- VOL 14: BACK ISSUES** – July 2005 to December 2005
- VOL 15: BACK ISSUES** – January 2006 to June 2006
- VOL 16: BACK ISSUES** – July 2006 to December 2006
- VOL 17: BACK ISSUES** – January 2007 to June 2007
- VOL 18: BACK ISSUES** – July 2007 to December 2007
- VOL 19: BACK ISSUES** – January 2008 to June 2008
- VOL 20: BACK ISSUES** – July 2008 to December 2008
- NEW – FIVE YEAR CD-ROM – Jan 2003 to Dec 2007**

NOTE: These CD-ROMs are suitable for use on any PC with a CD-ROM drive. They require Adobe Acrobat Reader (available free from the Internet – www.adobe.com/acrobat)

WHAT IS INCLUDED

All volumes include the *EPE Online* editorial content of every listed issue, plus links to all the available **PIC Project Codes** for the PIC projects published in those issues. **Please note that we are unable to answer technical queries or provide data on articles that are more than five years old.** Please also ensure that all components are still available before commencing construction of a project from a back issue.

FIVE YEAR CD-ROM NOW AVAILABLE

ONLY £16.45 (£29.95 FOR 5 YEAR) each including VAT and p&p

A great way to buy EPE Back Issues – our CD-ROMs contain back issues from our EPE Online website plus bonus articles, all the relevant PIC software links and web links. Note: no free gifts are included.

Order on-line from www.epemag.com or by phone, fax, email or post

BACK ISSUES CD-ROM ORDER FORM

Please send me the following Back Issue CD-ROMs.
Volume Numbers:.....

Price £16.45 each, £29.95 for Five Year CD-ROM – includes postage to anywhere in the world.

Name

Address

Post Code.....

I enclose cheque/P.O./bank draft to the value of £



please charge my Visa/Mastercard/Maestro £

Card No.

Card Security Code (The last 3 digits on or just under the signature strip)

Valid From..... Expiry Date

Maestro Issue No.....





SEND TO: Everyday Practical Electronics, Wimborne Publishing Ltd., Sequoia House, 398a Ringwood Road, Ferndown, Dorset BH22 9AU.

Tel: 01202 873872. Fax: 01202 874562.
E-mail: orders@epemag.wimborne.co.uk

Payments must be by card or in £ Sterling – cheque or bank draft drawn on a UK bank.
Normally posted within seven days of receipt of order.

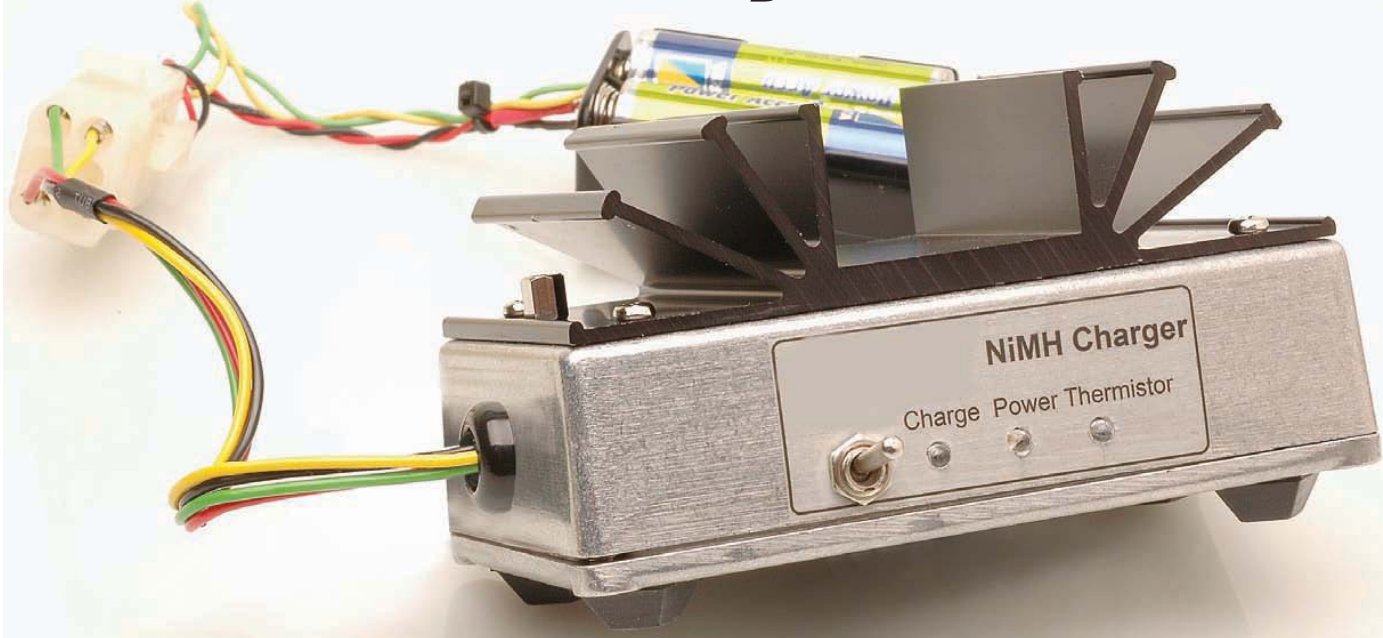
Select the features you want in this



Fast Charger for NiMH batteries

This is a truly versatile charger. It can charge up to 15 identical NiMH or NiCad cells. You can build it to suit any size cells or cell capacity and you can set the charge rate. It can fast charge, trickle charge and has safeguards, including temperature sensing, to prevent overcharging.

STANDARD NiMH (nickel metal hydride) and NiCad chargers are available just about anywhere, from hobby stores to supermarkets, the service station and even your local chemist or newsagent.

However, they usually only charge two or four AA cells and at quite a slow rate – typically, they will take between four and 15 hours to charge. But what if you want to charge at a much higher rate, or more than four cells at a time? Or cater for C and D type cells or battery packs?

The only complete answer is to build the Fast NiMH Charger.

It can charge from one cell up to 15 cells simultaneously and battery packs up to 18V for both NiMH and NiCad types. Charging can be set from just a few milliamps up to 2.5A and it includes a reliable end-of-charge detection, with extra safeguards included to prevent over-charging.

Safety is important when charging NiMH and NiCad cells and batteries, because they can be destroyed or have their life seriously shortened if the charger is left on for too long after the battery pack has reached full charge.

by JOHN CLARKE

To see why over-charging can destroy a battery pack, have a look at Fig.1. This shows the typical voltage, temperature and internal pressure rise of a cell or battery pack with charge. Once charging goes past the 100% point, the temperature and internal pressures rapidly rise and the voltage initially rises and then falls.

Continual overcharging will damage the cells due to the elevated temperature. This accelerates chemical reactions that contribute to the ageing process. In extreme cases during overcharging, excessive internal pressure can open their safety vents to release



These 1500, 1700 and 1800mAh 'AA' NiMH batteries were once considered 'state of the art'. Now 2500mAh are quite common (we've even seen claims of 3000+ 'AA'). Our new charger will handle these, as well as C and D type cells and even battery packs.

the pressure. These vents will re-close after the pressure is released but the cells will already have been damaged.

Full charge detection

Full charge can be determined in one of two ways. The conventional way has been to monitor the voltage across the battery pack and detect the point where the voltage begins to rise rapidly and then fall. This form of end-point detection is called dV/dt (ie, change in voltage with respect to time).

In practice, the critical end-point can be difficult to detect at low currents, particularly with NiMH cells. In fact, dV/dt end-point detection with NiMH cells is neither safe nor practical.

The only safe way is to monitor the temperature of the cells. Very few chargers do this.

This far more reliable method, especially with NiMH cells, monitors the temperature rise of one or two cells within the battery pack. During charging the cells do not heat up much because most of the incoming power is converted into useful stored energy. However, once the cells become fully charged, the charging current (and power) is converted to heat, and so the cells quickly rise in temperature.

This temperature change at the charging end-point is called dT/dt – change in temperature over time. The critical temperature rise is of the order of 2°C per minute. This is where normal charging should stop.

Some chargers, ours included, may have a top-up charge after the end-point to ensure full charging. After top-up, the cells can be 'trickle-charged' to maintain full charge. In this situation, the cells are deliberately left connected

Main Features

- Designed for NiMH cells, but will handle NiCads too
- Charging timeout
- dT/dt (temperature change rate) for end of charge detection
- Over and under cell temperature detection
- Power, charging and thermistor indication LEDs
- Adjustable charging timeout limit
- Adjustable dT/dt setting
- Optional top-up and trickle charging
- Adjustable charge current
- Adjustable top-up and trickle charge currents
- Over-temperature cut out for charger

to the charger, in the knowledge that they won't be damaged but will be absolutely 'full to the brim' when they are needed.

Our new Fast NiMH Charger requires a small thermistor to be installed in the battery pack or cellholder, in close contact with one of the cells, so it can monitor temperature. The beauty of this system is that it will recharge any cell, regardless of whether it is flat or only partially discharged – but you will not over-charge it.

Cool safeguards

However, there is a proviso here, and it applies when you are charging very cold batteries – they may rapidly rise in temperature during charging.

This could cause a false dT/dt end of charge condition.

To circumvent this, the dT/dt measurement for end of charge detection is only enabled when the cell temperature is at least 25°C . Should the thermistor end-point detection fail, a timer is included that will switch off charging after a preset period.

Further safeguards to protect the cells are also included. Charging will not start, or will stop, if the NTC thermistor for the cells is disconnected or if the temperature is under 0°C or over 55°C . Should the charger itself become too hot, charging will pause and the temperature is measured after two minutes to check if it has cooled sufficiently to restart charging.

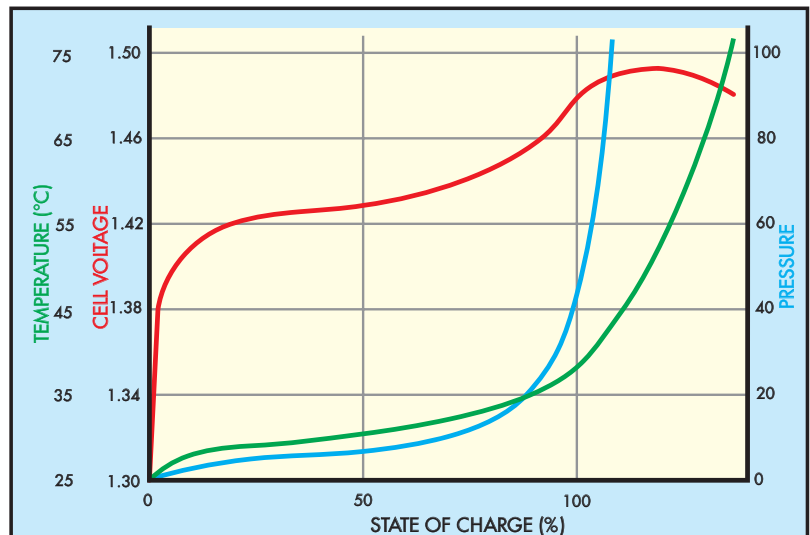

Fig. 1: typical charging curves for NiCad batteries (NiMH are similar). Cell temperature (green) and voltage (red) are most often used to detect the 'end point' or 100% charge – in NiMH cells, the voltage is much less reliable.

Constructional Project

Specifications

Maximum input voltage.....	30V
Maximum charge current.....	2.5A
Charge current adjustment.....	From 0 to 2.5A, corresponding to 0V to 2.5V at TP4 using VR4 (in approximately 40mA steps)
Timeout adjustment.....	From 0 to 5 hours, corresponding to 0V to 5V from VR1 at TP1. 0 to 25 hour with x5 link installed (LK1)
dT/dt adjustment.....	From 0.5 to 5°C rise/minute, corresponding to 0.5 to 5V from VR2 at TP2.
dT/dt measurement.....	Once every minute when cells reach 25°C or more
Top up and trickle charge.....	Top up available when LK2 is installed. Trickle enabled when LK3 is installed
Trickle charge adjustment.....	Adjustable using VR3 from 0 to 500mA, corresponding to 0V to 5V at TP3 Adjustable in approximately 5mA steps
Top up charge.....	4x trickle setting for 1 hour
Cell over-temperature cutout.....	55°C
Cell under-temperature detection.....	0°C
Charger over-temperature cutout.....	50°C

Select the features you want

In its simplest form, our Fast NiMH Charger includes only the temperature detection feature. You can add top-up

and trickle charging if you want (no extra components are required) and set all the charge parameters: full charge current, trickle charge, timeout period and

dT/dt values. Full charge can be set from about 40mA up to 2.5A, while trickle can be set from 10mA up to 500mA. Timeout can be set from between 0 to 25- hours, while dT/dt can be selected from between 0.5°C rise per minute to 5°C per minute.

More details concerning the adjustments are included in the setting up section of this article.

LED status

Three LEDs indicate the status of the charger controller. The power LED is lit whenever power is applied to the charger (obviously!) while the thermistor LED lights if the thermistor is disconnected, or if there is an over or under-temperature detection.

For over-temperature (>55°C), the thermistor LED will flash once a second (1Hz) while for under-temperature (<0°C) the LED will flash once every two seconds (0.5Hz). Over heating of the charger itself causes the Thermistor LED to flash once every four seconds.

Finally, the charging LED is continuously lit during the main charging cycle and switches off when charging is complete.

If top-up and/or trickle charging are selected, the charging LED will flash

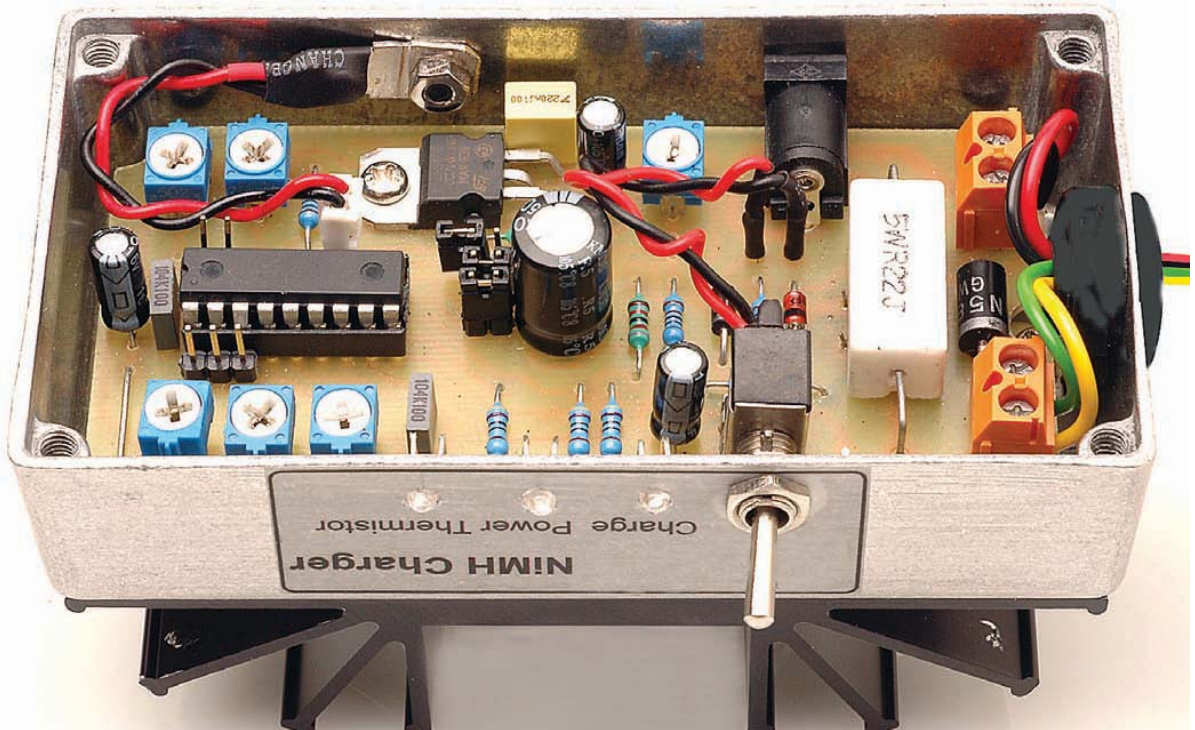

A view inside the NiMH Fast Charger. As you can see, the PC board sits in the bottom of the diecast box, as normal. But when the lid is screwed on, it becomes the base and the whole thing is turned over so the PC board is actually upside-down.

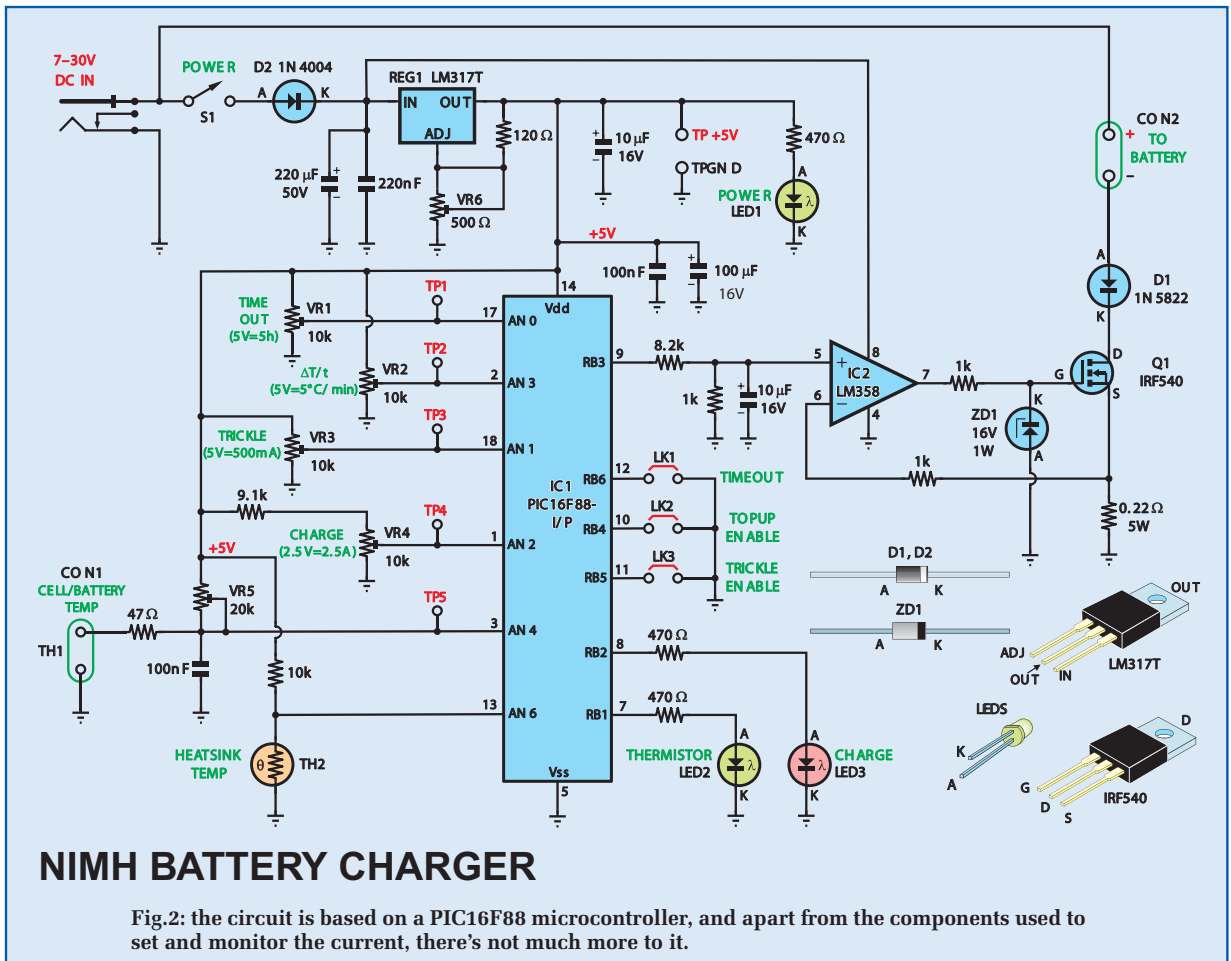

at 1Hz during top-up and at 0.5Hz during trickle charge. Note that if the thermistor LED is lit or flashing, the charging LED will be off, indicating that charging has paused or stopped.

Circuit details

The full circuit diagram for the Fast NiMH Charger is shown in Fig.2. The circuit is based around a PIC16F88-I/P microcontroller, IC1. Apart from the complexity of the software for IC1, there is not much else to it.

Two NTC thermistors are used in the circuit. NTC stands for 'negative temperature coefficient' and this means that the resistance of the thermistor is progressively reduced as the temperature rises.

Thermistor TH1 monitors the cell or battery pack being charged. It is connected via a 2-way terminal block (CON1) and forms a voltage divider with 20kΩ trimpot VR5 across the 5V supply. Preset VR5 is adjusted so that

the voltage across the thermistor is 2.5V at 25°C.

The voltage across the thermistor is monitored at the AN4 input (pin 3) of IC1 via a 47Ω resistor and a 100nF filter capacitor. These are included to remove radio frequency (RF) signals and noise that could be present due to the thermistor being connected remotely from the circuit.

The voltage at the AN4 input is converted into a digital value and the values are compared against the over and under temperature values and for dT/dt changes.

Trim pots VR1, VR2 and VR3 are used to set the timeout, dT/dt and trickle charge values. The wiper of each trimpot connects to the AN0, AN3 and AN1 inputs respectively and these inputs can receive between 0V and 5V, depending upon the setting of the trimpot.

For the full charge current input at AN2, preset VR4 connects to the +5V

supply via a 9.1kΩ resistor. This restricts adjustment to a nominal 2.5V maximum (for a 2.5A maximum setting).

The voltage inputs are all converted to digital values within IC1, so that the settings can be processed in software.

Test points TP1, TP2, TP3, TP4 and TP5 are provided for setting the trim pots when using a multimeter. There is also a TP GND terminal for the negative probe of your multimeter.

The voltages measured at each test point directly relate to the setting's value. For example, setting VR1 to give 4V at TP1 will set the timeout to four hours.

The timeout value can be multiplied by a factor of five if jumper link LK1 is inserted. This ties pin 12 to ground. With LK1 out, pin 12 is pulled to +5V via an internal pullup resistor within IC1, and timeout is set at x1.

Links LK2 and LK3 work in a similar manner. LK2 enables the top-up and LK3 enables the trickle charge modes.

Constructional Project

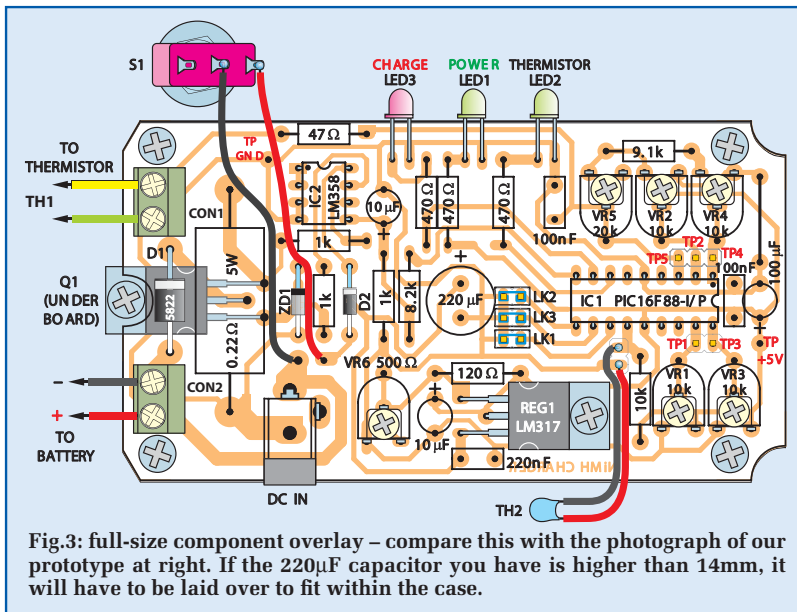

Fig.3: full-size component overlay – compare this with the photograph of our prototype at right. If the 220µF capacitor you have is higher than 14mm, it will have to be laid over to fit within the case.

Outputs RB1 and RB2 of IC1 drive the Thermistor and Charge LEDs respectively via 470Ω resistors.

Constant current source

Op amp IC2 and MOSFET Q1 are connected to provide a controlled current source to charge the battery (connected via CON2). Op amp IC2 compares the voltage across the 0.22Ω 5W resistor (at pin 6) with the DC voltage derived from the RB3 output of IC1 (at IC2 pin 5).

The output from RB3 is a 5V 500Hz pulse-width-modulated signal, which is fed to a divider and filter network comprising 8.2kΩ and 1kΩ resistors and a 10µF capacitor. The filter network smooths the pulse output to give a DC voltage.

It is this smoothed DC voltage which effectively sets the current level provided by MOSFET Q1 to the battery.

Diode D1 is included to prevent the battery from discharging via the intrinsic reverse diode inside MOSFET Q1, when the power is off. D1 is a 3A Schottky diode, specified because it has less than half the forward voltage of a normal power diode. Typically, it has about 380mV across it (at 2.5A) compared with a standard diode which has 0.84V across it at 2.5A. The lower voltage drop also means less power loss in the diode; 0.95W at 2.5A compared to 2.1W in a standard diode.

Power for the circuit is taken from a DC plugpack supply via diode D2. This diode provides reverse polarity

protection for the following capacitor and regulator REG1.

An LM317T is used to provide a regulated 5V supply to IC1 and the trim pots. This was chosen in preference to a standard 5V regulator because it can be adjusted to supply a precise 5V, using trimpot VR6, to make the settings of VR1 to VR5 more accurate.

Voltage requirements

To fully charge a battery you will require up to 1.8V per cell from your plugpack, even though the nominal terminal voltage shown on the battery pack is 1.2V per cell. Hence, to charge a 6V battery which has five cells, you will need a DC input voltage of 9V (5 × 1.8V). Similarly, an 18V battery will have 15 cells and you will need 27V (15 × 1.8V) to charge it fully.

However, while the voltage requirement for charging one, two or three cells is less than 7V, in practice you need more than 7V at the input to ensure that the LM317T regulator operates correctly, ie, remains in regulation.

You can operate the charger in a car, in which case the input voltage will be around 12V with the engine stopped and up to 14.4V with the engine running. With 12V in, you can charge up to six cells (ie, a 7.2V battery). With 14.4V (ie, engine running), you can charge up to eight cells (ie, a 9.6V battery).

Note also that using a supply voltage that is significantly higher than required to charge the cells will cause

the charger to heat up more than necessary. For example, at 2.5A and with 10V higher than the battery voltage, there is going to be 25W dissipated in the charger. The heatsink will certainly become hot and the charger will shut down when it reaches 50°C. So you may have to reduce charge current if the supply voltage is high compared to the battery voltage.

Charge current

Maximum charging current is limited by the mAh capacity of the cell or battery (as can be seen in Table 1) and the rating of the DC plugpack or power supply. So, if you charge at 2.5A, the power supply or plugpack must be able to deliver this current.

Note that most 'transformer' type plugpacks cannot supply this amount of current, while some 'electronic' plugpacks (ie, those with a switch-mode supply) may be able to.

Software

The software files will be available via the EPE Library site, access via www.epemag.com. Pre-programmed PICs will also be available from Magenta Electronics – see their advert in this issue for contact details.

Construction

The Fast NiMH Charger is constructed using a 98mm × 53mm PC board, code 720. This board is available from the *EPE PCB Service*. The printed circuit board component layout and wiring is shown in Fig.3.

It is housed in a diecast box measuring 111mm × 60mm × 30mm. A fan heatsink (that's fan-shaped, not a heat-sink with a fan) measuring 55 × 105 × 25.5mm mounts on the case to ensure that the charger runs reasonably cool.

Begin construction by checking the PC board for any defects, such as shorted tracks and breaks in the copper. Check also that the hole sizes are correct. Holes for the DC socket and the 2-way screw terminals will need to be larger than the 0.9mm holes required for the other components.

Also check that the corners have been shaped to clear the internal corner posts of the box and that the 6mm diameter access semicircle for Q1's screw has been cut from the edge of the PC board – see Fig.3.

Insert the resistors first. Use the resistor colour code table as a guide to each value, or use a digital multimeter

The complete charger, reproduced close to life size. Q1 is mounted under the PC board – you can just see its tab poking out the left side (between the terminal blocks). Inset below is the wiring of the NTC thermistor, which attaches to the side of the box, monitoring temperature rise.

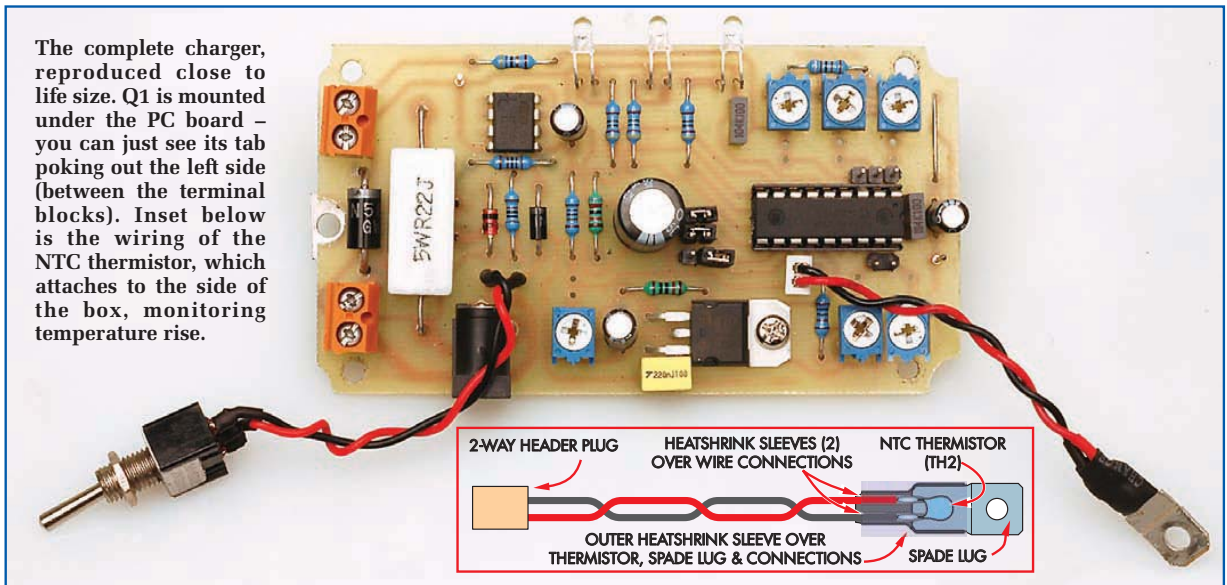

to check each resistor before inserting it into the PC board.

Next, install the wire link (top right in Fig.3), the diodes, the PIC (IC1) socket and IC2, taking care to orient each with the correct polarity. Do not insert IC1 in its socket at this stage.

The capacitors can go in next. Note that the electrolytic types must be oriented with the polarity shown. If the 220µF 50V capacitor is higher than the 14mm-high type used, it may need to be mounted on its side (over ZD1 and D2) to allow room to fit into the box.

Follow these parts with the 2-way and the 3-way headers for the jumper links, then install PC stakes for test points TP1-TP5 and for the thermistor TH2 connection. Also, install the PC stakes for switch S1, TP GND and TP +5V test points.

The bases of each of the three LEDs should be 15mm above the surface of the PC board. Orient them with the anode (longer lead) toward the left of the PC board. LED1 and LED2 are the green

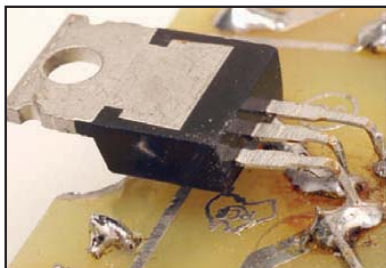

This close-up shows how Q1's legs are bent up and soldered to the copper underside of the PC board.

LEDs, while LED3 is a red LED. They are ultimately bent over at right angles at a point 10mm above the PC board, so that they fit through their matching holes in the side of the charger box.

Next, solder the trimpots in place. They have different values, so be sure to install the correct unit in each position. Note that the 10kΩ trimpots may be marked with 103, the 20kΩ with a 203 and the 500Ω with a 501 instead of the actual (ohms) value.

Regulator REG1 lies flat on the PC board with its leads bent over to insert into the appropriate holes. It is secured using an M3 screw and nut.

Now install the DC socket and 2-way screw terminal connectors. At this point, apart from MOSFET Q1, the PC board assembly is complete.

Mounting Q1

Q1, an IRF540 MOSFET, is not actually mounted on the PC board – it screws to the case 6mm underneath the board. As shown in the photo, its legs are bent



Here's how the thermistor (TH2) is 'heatshrinked' to a spade lug and then secured to the box side.

up 90° and are soldered to the copper underside of the board (they just poke through the upper surface, underneath the 0.22Ω 5W resistor).

You need to get the MOSFET into the right position so that when the completed PC board is placed in the box, a hole can be drilled through the case and heatsink.

This is a little tricky to achieve because the centre leg, the drain (D), is actually shorter than its gate or source legs. Bend the drain up 90° 5mm out from the body of the MOSFET and similarly bend the source and gate legs up 90° 7mm out from the body.

Now solder Q1 in position and turn the board over. The hole through Q1's heatsink should be right in the middle of the access semicircle cut in the edge of the PC board.

Boxing it

Insert the PC board into the diecast box and mark out the corner mounting holes in the base of the box and also the hole position for Q1. Drill these



The battery temperature thermistor (TH1) is mounted inside a modified battery holder so it contacts two cells.

Constructional Project

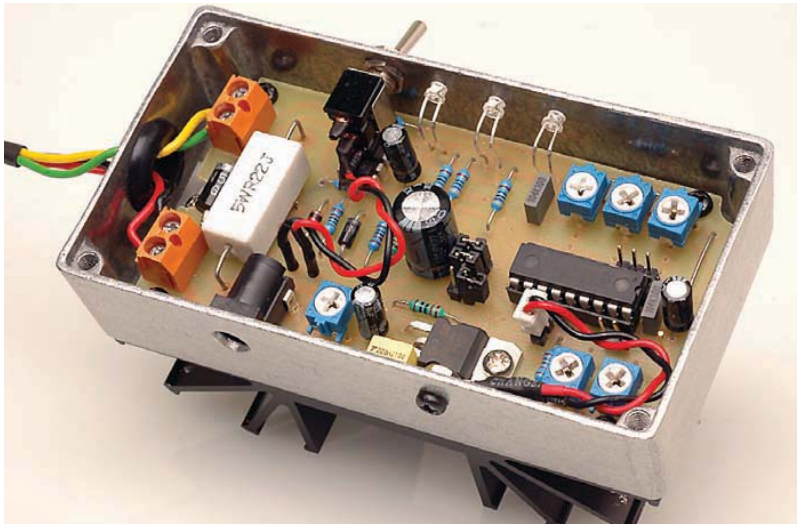

This view shows the mounting positions for the LEDs and switch (front) plus DC socket and thermistor (rear).

out to 3mm in diameter. Now place the heatsink squarely onto the base of the box and mark out the four corner mounting holes and the Q1 hole onto the back of the heatsink. Drill these out using a 3mm drill bit.

Deburr the holes with a larger drill bit and in particular, make sure that the area around the hole inside the box for Q1 to mount on is smooth, so that the insulating washer will not be punctured.

Holes need to be drilled in the side of the box, as shown in Fig.5. These holes are for the three LEDs and power switch on one side and the DC socket and thermistor TH2 mount on the other side.

The end of the box adjacent to Q1's hole needs a 9.5mm hole for the cable grommet (our photos in fact show a 12.5mm grommet – because we had one – but a 9.5mm grommet would be better).

Thermistor TH2 is mounted on a spade terminal using a 4mm length of heatsink tubing. This then mounts on the box to detect heatsink temperature. First, cut the thermistor leads to 5mm length and solder two 50mm lengths of light-duty insulated wire to it. Insulate the joints with 1.5mm heatshrink tubing. Now attach the two free wire ends to the 2-pin header connector. The thermistor can be attached to the spade terminal with the heatshrink tubing.

Beware sheep in wolf's clothing!

Be careful if you buy NiMH batteries over the 'net – you might not quite get what you expect.

We've seen several warnings about the ratings of rechargeable batteries coming from suppliers in Hong Kong and China (among other places) and readily available on eBay, for example.

It seems some of Asia's inscrutable manufacturers or distributors simply print whatever they think will sell their cells without too much angst. If that means labelling a 1500mAh cell (which of course is much cheaper to produce), as a 2500mAh, then so be it.

Another source has warned about 'C' and 'D' cells, which are actually 'AA' cells inside a 'C' or 'D' case.

Even if you do pay a little more to buy your NiMH or NiCad cells from reputable retailers (and that's not always the case anyway), you have the availability of recourse if your purchase isn't what it appeared to be, or what you thought it should be.

Try doing that with an email address in, well, where? The old maxim applies: if it looks too good to be true, it probably is!

While you are about it, cut, solder and insulate a similar pair of wires for switch S1. These wires should be roughly 70mm long. One connects to the centre terminal of the switch and it doesn't matter which terminal the other goes to – if it appears to work 'upside down' (ie, off in the down position), you simply turn the switch through 180°.

Assembly

The heatsink and PC board are screwed to the bottom of the box, which (when completed) is then turned over and becomes the top side. The lid then becomes the base.

Before mounting the heatsink, apply a thin smear of heatsink compound to its base. Then attach the heatsink to the box bottom with the M3 × 10mm screws and 6.3mm threaded plastic standoffs.

Next, secure Q1 to the base of the box, along with its silicone insulating washer and insulating bush. We used an M3 × 10mm from the inside and a 6mm M3 tapped spacer on the outside. You could use just an M3 nut here, but the exposed screw thread does not look as neat as the spacer – and besides, the spacer is easier to grip when tightening it up!

The PC board is secured to the nylon spacers using four M3 × 5mm screws.

Before going any further, check to make sure that the metal tab of Q1 is, in fact, isolated from the metal box. With your multimeter on a mid-range ohms scale, connect one lead to the box and the other to Q1's tab (or the cathode [striped end] of diode D1).

The reading should be above 1MΩ. If it is low ohms, check that the insulating washer and bush are installed correctly and that the washer is not punctured. If you get a low reading, correct the problem before proceeding.

Attach a suitable card side panel label to the box and bend the LED leads over to just protrude through the holes in the side of the box.

The previously-prepared thermistor (TH2) attaches to the side of the box with an M3 × 5mm screw and nut. Its wires connect to the PC board as shown. The 70mm-long wires from switch S1 (which sits directly over IC2) connect to the appropriate PC stakes and both the switch itself and the PC stakes are insulated with heatshrink tubing.

Wire the terminals on the PC board for the battery and thermistor (TH1) using medium-duty wire. Use red for battery positive, black for battery negative and

Parts List – Fast NiMH Charger

1 PC board, code 720, available from the <i>EPE PCB Service</i> , size 98 × 53mm	5 M3 × 10mm screws	2 3mm green LEDs (LED1,LED2)
1 diecast box, 111 × 60 × 30mm	1 M3 × 6mm tapped spacer	1 3mm red LED (LED3)
1 fan type heatsink, 55 × 105 × 25.5mm	2 M3 nuts	1 16V 1W Zener diode (ZD1)
1 mini SPDT toggle switch (S1)	1 6.4mm spade lug, chassis hole mounting	1 1N5822 3A Schottky diode (D1)
2 2-way PC-mount screw terminals	1 TO-220 silicone insulating washer	1 1N4004 1A diode (D2)
1 PC-mount 2.5mm DC socket	1 3mm TO-220 insulating bush	Capacitors
1 18-pin IC socket	1 battery holder, suit charged cells	1 220 μ F 50V PC electrolytic
5 2-way headers	2 cable ties	1 100 μ F 16V PC electrolytic
1 3-way header	30mm length of 0.8mm tinned copper wire	2 10 μ F 16V PC electrolytic
3 jumper shunts	120mm lengths of red, black, green and yellow medium-duty hookup wire	1 220nF MKT polyester
4 PC stakes	120mm lengths of red and black light-duty hookup wire	2 100nF MKT polyester
1 2-way jumper connector	Heatsink compound	Resistors (0.25W, 1%)
2 NTC thermistors (10k Ω @ 25°C) (TH1, TH2)	Semiconductors	1 10k Ω 3 470 Ω
1 4-way (or 6-way) automotive connector	1 PIC16F88-I/P microcontroller, programmed with NiMHCharger.hex (IC1)	1 9.1k Ω 1 120 Ω
1 9.5mm grommet	1 LM358 dual op amp (IC2)	1 8.2k Ω 1 47 Ω
4 small adhesive rubber feet	1 IRF540 MOSFET (Q1)	3 1k Ω 1 0.22 Ω 5W
1 50mm length of 1.5mm diameter heatshrink tubing	1 LM317T adjustable 3-terminal regulator (REG1)	Potentiometers
1 50mm length of 4mm diameter heatshrink tubing		1 500 Ω horizontal trimpot (code 501) (VR6)
4 6.35mm nylon M3 tapped spacers		4 10k Ω horizontal trimpots (code 103) (VR1-VR4)
6 M3 × 5mm screws		1 20k Ω horizontal trimpot (code 203) (VR5)

yellow and green wires for the thermistor wiring. These pass through the cable grommet and into the terminals.

Because we wanted to make the charger adaptable to other batteries, the other ends of the wire connect to an automotive connector plug and socket, which then connects to the battery holder and thermistor. For a permanent connection, the connector could be omitted, with the battery holder/thermistor wires going straight to the appropriate places on the battery holder.

Ensure the connections to the thermistor are sleeved with heatshrink tubing to prevent any shorts to the battery holder terminals.

The thermistor needs to be mounted in the battery holder so that it contacts at least one of the cells under charge. We drilled a hole in a 4×AA cell holder so that the thermistor is sandwiched between the cells in the holder (see photo).

Depending on the type of battery holder you use (or none at all) your cells may need to have the thermistor mounted with some Velcro or similar around the cell body.

Setup

With IC1 still out of its socket, now connect your plugpack to the DC socket

(positive to the centre of the plug) and turn on. The power LED should light.

Connect a multimeter between TP +5V and TP GND and adjust trimpot VR6 for a reading of 5.0V. Now check that there is 5V between pin 14 and pin 5 of the IC1 socket. If this is correct, switch off power, wait a short time and then install IC1 into its socket.

Adjustments

Thermistor TH1 setting is adjusted using VR5, so that the voltage between TP5 and TP GND is 2.5V when the thermistor is at 25°C (ie, if the ambient temperature is 25°C, adjust VR5 so that the voltage between TP5 and TP GND is 2.5V). If the ambient is 20°C, set it for 2.8V or to 2.2V for 30°C. Both the timeout and dT/dt values are adjusted using trimpots VR1 and VR2. Test points have been included to allow easy measurement.

The timeout can be set from 0 to 25 hours. In its simplest arrangement, the voltage at TP1 gives the timeout in hours. For example, if VR1 setting gives 5V between TP1 and TP GND, the timeout is five hours. If you need longer than this time period, then you can install LK1. This acts as a x5 multiplier so that the time period is increased.

So, for example, with LK1 installed and VR1 set so that TP1 is 5V, the timeout will be 25 hours. Similarly, if TP1 is 1.2V, then the timeout will be six hours (5 × 1.2).

Refer to the 'NiMH charger settings' section to work out the timer value required. Table 1 at the end of this article also shows typical settings for various capacity cells.

Temperature rise detection (dT/dt) can be adjusted from between 0.5°C per minute rise to 5°C per minute rise. This is done using VR2 and measuring between TP2 and TP GND. There is a direct correlation between the voltage and the setting: a setting of 2.5V at TP2 will set the dT/dt value to 2.5°C per minute rise. Initially, set VR2 so that the voltage at TP2 is 2.5V.

Option

Installing links LK2 and LK3 enables top-up and trickle charge respectively. If you want top-up only, install LK2; if you want both top-up and trickle charge install LK2 and LK3; if you want trickle without top-up, install LK3 only.

If any of these two links are selected, you will need to set the trickle charge rate. The top-up charge is

Constructional Project

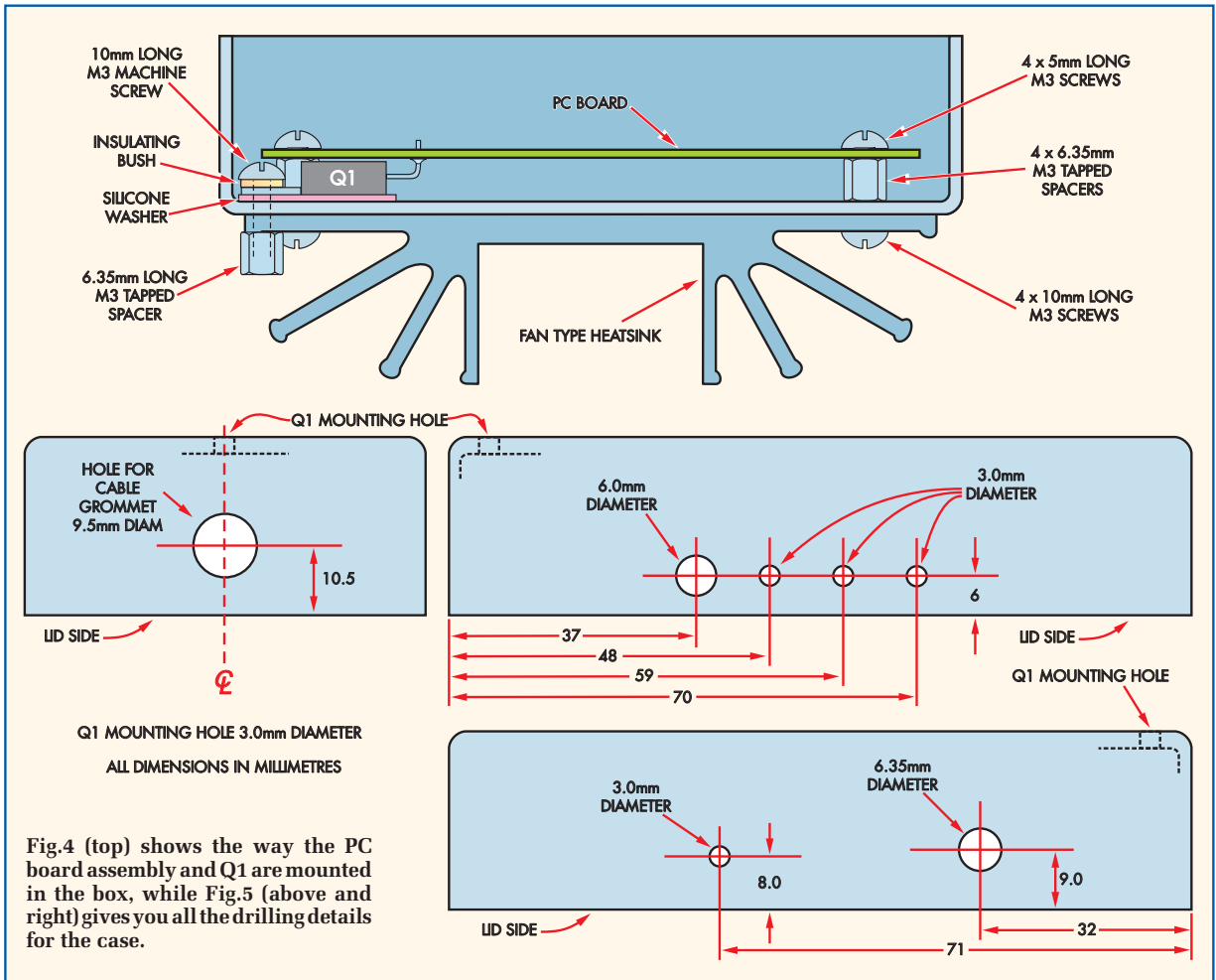

fixed at four times the trickle charge. Trickle charge, trimpot VR3 allows adjustment from 500mA down to less than 20mA.

Note that some battery packs have a thermistor already installed. This should not be used unless it has the same resistance characteristics as the one specified. The thermistor should measure about 10kΩ at 25°C and the

resistance should fall with increasing temperature.

NiMH charger settings

Before setting up the charge, timeout and trickle settings you need some extra snippets of information. You will need to know the Ah rating (or mAh) of the cells or the battery – this will normally be printed on the side of the cells or battery.

You also need to know the nominal battery voltage or the number of cells connected in series, the plugpack voltage and the plugpack current rating.

Note that when using slow charging rates (eg, charging over 15 hours) the top-up current will be greater than the charge rate. In this case, do not enable top-up. At faster rates (eg, charging over five hours) the top-up may be

Resistor Colour Codes

	No.	Value	4-Band Code (1%)	5-Band Code (1%)
o	1	10kW	brown black orange brown	brown black black red brown
o	1	9.1kW	white brown red brown	white brown black brown brown
o	1	8.2kW	grey red red brown	grey red black brown brown
o	3	1kW	brown black red brown	brown black black brown brown
o	3	470W	yellow violet brown brown	yellow violet black black brown
o	1	120W	brown red brown brown	brown red black black brown
o	1	47W	yellow violet black brown	yellow violet black gold brown

Table 1: Typical settings for the Fast NiMH Charger for a range of cell capacities.

Battery or cell capacity	Trickle current (LK3 in) Top up with LK2 will be 4 x trickle setting	Slow charge (15h) (VR1 @ 3V, LK1 in) (Do not select top-up)	Standard charge (5h) (VR1 @ 5V, LK1 out) (Top-up not recommended)	Fast charge (1.5h*) (* at or below 2.5A) (VR1 @ 1.5V, LK1 out)
200mAh	10mA (VR3 @ 100mV)	20mA (VR4 @ 20mV)	60mA (VR4 @ 60mV)	200mA (VR4 @ 200mV)
400mAh	20mA (VR3 @ 200mV)	40mA (VR4 @ 40mV)	120mA (VR4 @ 120mV)	400mA (VR4 @ 400mV)
700mAh	35mA (VR3 @ 350mV)	70mA (VR4 @ 70mV)	210mA (VR4 @ 210mV)	700mA (VR4 @ 700mV)
900mAh	45mA (VR3 @ 450mV)	90mA (VR4 @ 90mV)	270mA (VR4 @ 270mV)	900mA (VR4 @ 900mV)
1000mAh	50mA (VR3 @ 500mV)	100mA (VR4 @ 100mV)	300mA (VR4 @ 300mV)	1.0A (VR4 @ 1.0V)
1500mAh	75mA (VR3 @ 750mV)	150mA (VR4 @ 150mV)	450mA (VR4 @ 450mV)	1.5A (VR4 @ 1.5V)
2000mAh	100mA (VR3 @ 1.0V)	200mA (VR4 @ 200mV)	600mA (VR4 @ 600mV)	2.0A (VR4 @ 2.0V)
2400mAh	120mA (VR3 @ 1.2V)	240mA (VR4 @ 240mV)	720mA (VR4 @ 720mV)	2.4A (VR4 @ 2.4V)
2500mAh	125mA (VR3 @ 1.25V)	250mA (VR4 @ 250mV)	750mA (VR4 @ 750mV)	2.5A (VR4 @ 2.5V)
2700mAh	135mA (VR3 @ 1.35V)	270mA (VR4 @ 270mV)	810mA (VR4 @ 810mV)	2.5A (1.6h) (VR4 @ 2.5V) (VR1 @ 1.6V, LK1 out)
3000mAh	150mA (VR3 @ 1.50V)	300mA (VR4 @ 300mV)	900mA (VR4 @ 900mV)	2.5A (1.8h) (VR4 @ 2.5V) (VR1 @ 1.8V, LK1 out)
3300mAh	165mA (VR3 @ 1.65V)	330mA (VR4 @ 330mV)	990mA (VR4 @ 990mV)	2.5A (2h) (VR4 @ 2.5V) (VR1 @ 2.0V, LK1 out)
4000mAh	200mA (VR3 @ 2.0mV)	400mA (VR4 @ 400mV)	1.2A (VR4 @ 1.2V)	2.5A (2.4h) (VR4 @ 2.5V) (VR1 @ 2.4V, LK1 out)
4500mAh	225mA (VR3 @ 2.25V)	450mA (VR4 @ 450mV)	1.35A (VR4 @ 1.35V)	2.5A (2.7h) (VR4 @ 2.5V) (VR1 @ 2.7V, LK1 out)
5000mAh	250mA (VR3 @ 2.5V)	500mA (VR4 @ 500mV)	1.5A (VR4 @ 1.5V)	2.5A (3h) (VR4 @ 2.5V) (VR1 @ 3.0V, LK1 out)
9000mAh	450mA (VR3 @ 4.5V)	900mA (VR4 @ 900mV)	2.5A (5.4h) (VR4 @ 2.5V) (VR1 @ 1.08V, LK1 in for x5)	2.5A (5.4h) (VR4 @ 2.5V) (VR1 @ 1.08V, LK1 in [x5])

similar to the charge rate and again top-up is not recommended.

Timeout

Timeout should be set to 1.5 times the Ah rating of the battery divided by the charge current. So, a 2500Ah battery charged at 1A should be charged after 2.5 hours, which means that the timeout is set to 3.75h. This would be a 3.75V setting at TP1.

Any changes to the timeout value when charging will not take effect until power is switched off and on again. This includes changes to the

LK1 setting. Any changes to other settings will be incorporated in the charging.

Trickle

The trickle charge requirement is calculated by dividing the amp hour rating of the cells by 20. So, for example, if the cells are 2400mAh, then the trickle current should be 120mA.

When testing, the charger may stop before full charge or it may tend to overcharge the batteries. Under-charge will be evident if the

charging period is too short and the batteries do not deliver power for the expected period. In this case, turn VR2 further clockwise to increase the dT/dt value.

If the battery pack appears to get hot after full charge has been reached, turn VR2 back anticlockwise for a lower dT/dt value. **EPE**

Reproduced by arrangement with SILICON CHIP magazine 2009.
www.siliconchip.com.au



Recycle It!



BY JULIAN EDGAR

A low-cost large-display anemometer

Live in a windy area? Like to have a big dial showing the outside wind speed? Here's an anemometer that you can build for next to nothing.

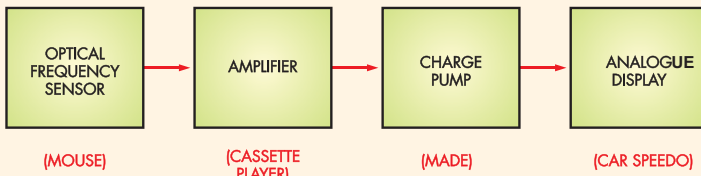
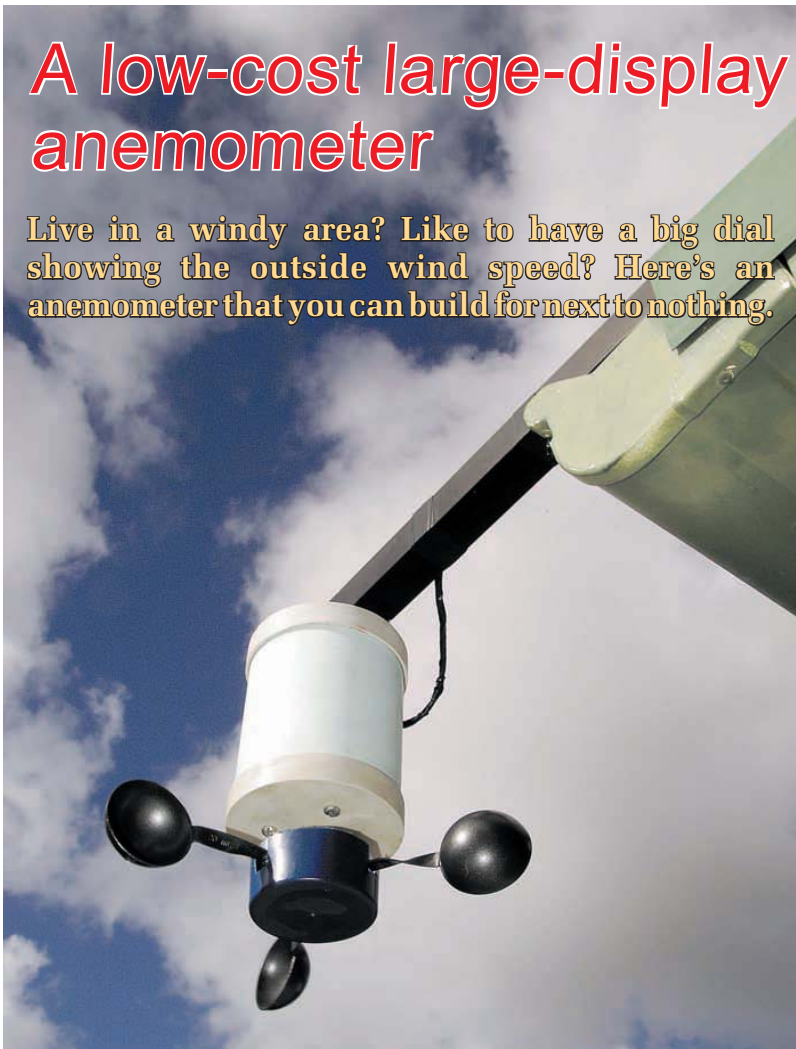

Fig.1: the anemometer uses the internals of a discarded mouse to generate a frequency output proportional to wind speed. This signal is fed into an amplifier (salvaged from a cassette player) which feeds a charge pump circuit made from a handful of passive components. The resulting voltage is displayed on the speedo.

IF YOU'RE A SAILOR or kite flyer, it's a must to know wind speed; and even if you're neither of these, it's fun to watch the display. The measurement range here will depend on how you set it up, but typically you'll be able to read speeds from just a few km/h upwards.

Cost? Well, depending on how you source the components, you're looking at very little. Best of all, this is a project that will totally stun your friends or spouse – they will wonder how the hell you made a working instrument from all that junk!

Components

Hang onto your seat folks; this project is for 'serious ratters' only. Why? Well to make this design, you'll need a whole bunch of stuff, but most you will be able to pick up for next-to-nothing at a few garage or boot sales. Alternatively, it's a project to keep in mind as you collect bits and pieces over a period of time.

First up, you'll need the video head assembly from a VHS video cassette recorder. The bearings have to be in good nick, so before removing the head from the VCR, give it a spin while listening closely.

The vast majority will spin superbly – they have really good bearings – but

PS2 MOUSE CABLE
(PLUG VIEWED FROM PINS)

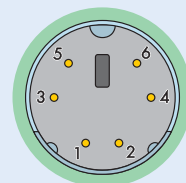

PIN CONNECTIONS
 1: DATA 4: +5V
 2: NC 5: CLOCK
 3: GND 6: NC

Fig.2: the mouse plug pinouts. You can easily find the pin-outs for other mouse plugs by doing a web search for 'mouse pinouts'.

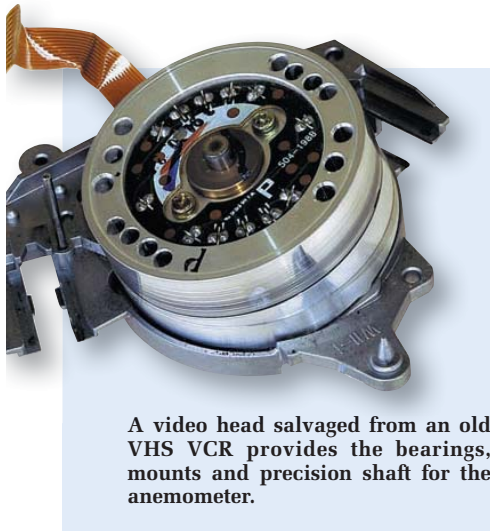

A video head salvaged from an old VHS VCR provides the bearings, mounts and precision shaft for the anemometer.

occasionally you'll find one that's a bit gritty in its rotation. If that's the case, get hold of another! (We showed you how to scrounge the video head from a VCR in *Recycle It!* in the May '09 issue.) The VCR used here came from a garage sale.

Second, you'll need an old cassette player, preferably a battery/mains portable one. It doesn't matter if it's stereo or mono, but go for a small design that uses an amplified speaker. We picked one up for a couple of pounds at a garage sale.

Third, you'll need an old computer mouse of the sort that uses a ball. We already had one stuffed away in a drawer, so that part didn't cost anything.

Last of all, you'll need an electronic speedo or tachometer from a car. Alternatively, if you can't lay your hands on one of those, you can use a VU meter from an old cassette deck (see *Recycle It!* Feb '09 issue for more on using salvaged VU meters). The speedo used here was purchased, at a knock-down price, from a local scrapyards for very little.

They're the major bits, but in addition you'll need some discrete electronic components – some of which almost certainly can be rattled from the VCR. You also need three kitchen measuring spoons, a short length of 90mm plastic pipe and some 90mm plastic end caps.

Anemometer design

So, how do we turn all those bits and pieces into an anemometer? In

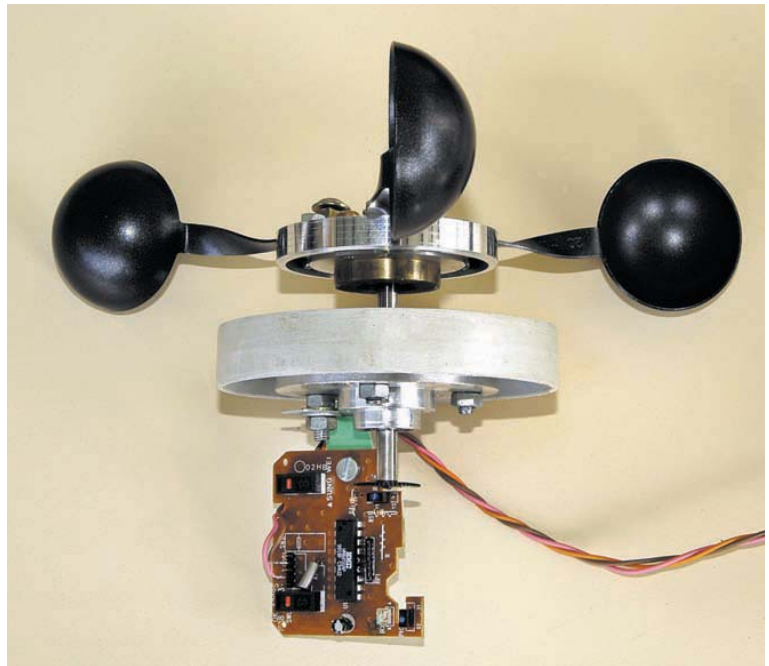

In this view, you can see (from top to bottom), the stainless steel measuring spoons that form the cups, the upper section of the video head, the shaft, the upper pipe cap, the lower section of the video head containing the bearings, the slotted optical wheel and sensors, and the mouse circuit board.

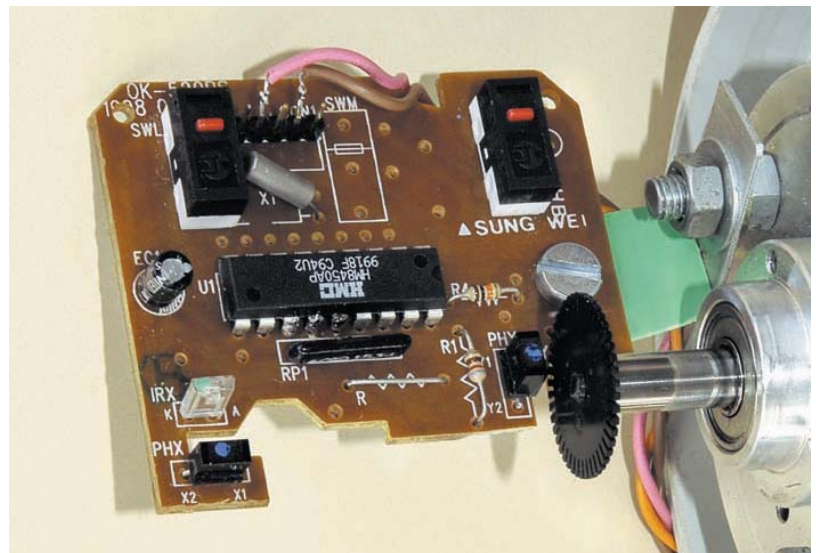

The slotted optical sensor wheel is glued to the end of the shaft. The mouse circuit board is mounted so that the slotted wheel interrupts the light beam between an LED and its adjoining sensor – just as it did in the mouse. Only one of the two mouse sensors is used (the unused one can be seen at bottom left).

summary, the video head provides the low-friction ball bearings, hardened steel shaft and aluminium bearing housing. The measuring spoons – they're usually stainless steel – are

used to form the anemometer cups (they mount on one end of the shaft).

The computer mouse donates the LED/phototransistor pair and also the finely slotted wheel that interrupts the

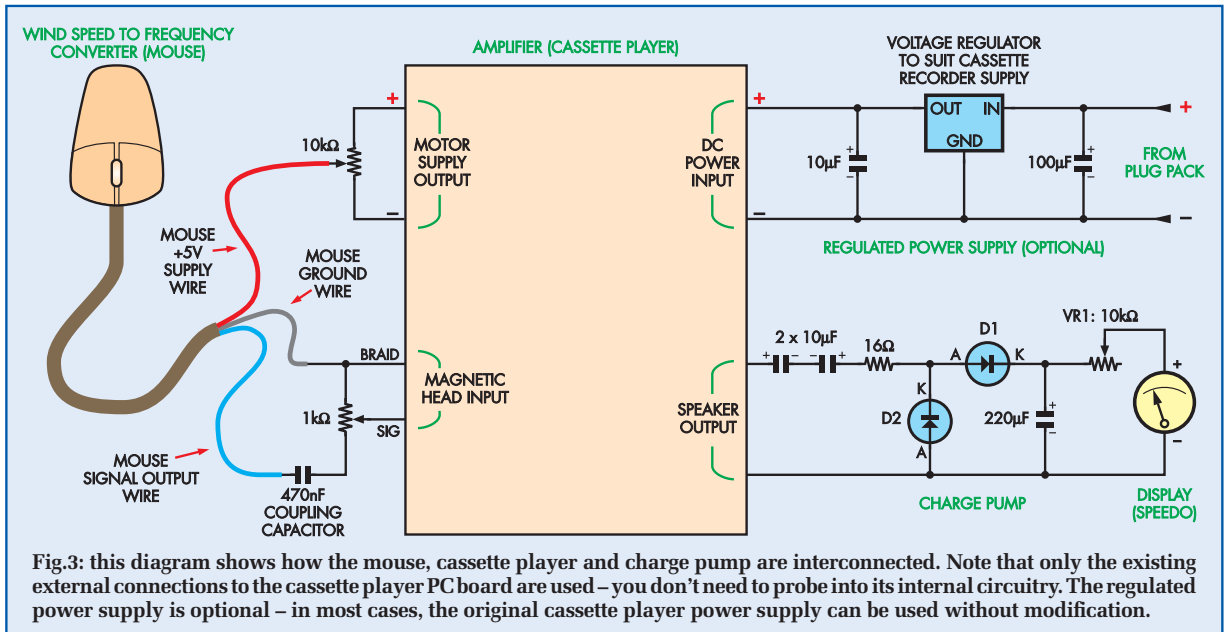

light beam as it spins. These components are used to generate a frequency that varies in proportion to wind speed.

The signal from the mouse is then amplified by the cassette player amp and fed into a charge pump circuit that comprises just a handful of passive components. This circuit converts the frequency into a voltage, which is then read on the car speedo (or VU meter). If you use a speedo, you'll be able to read the wind speed directly in km/h from the dial.

By altering the charge pump capacitors, a variety of meters can be catered for.

To make it all happen you don't need to get deeply into the intricacies of the circuits of the mouse, cassette deck or speedo – provided you have a frequency reading meter, it's all pretty straightforward. Fig.1 shows a block diagram of how the anemometer works.

Main Features

- Large analogue display
- Span can be set to suit local wind conditions
- Works down to very low wind speeds
- Linear or non-linear scales
- Makes use of junked equipment
- Very cheap to make

Building it

The key to making the anemometer is to build it in the right sequence of steps – that way, you can test each part of the system as you go along.

Optical sensor: the mouse is used to provide the optical sensor of the anemometer. The PC board in the mouse remains intact – we just tap into it to extract the signal. The first step is to power up the mouse and then find the signal output, which is taken directly from the photosensor.

Fig.2 shows the pinouts of the plugs used on PS2 mice. In this application, we need to use only the power (+5V) supply and ground (GND) connections.

Open up the mouse, cut off the cable and then use Fig.2 to identify the power and ground leads. Apply 5V to these leads (the voltage doesn't have to be absolutely precise, so four partially flat 1.5V cells are fine, or you can use an adjustable bench power supply) and then use a frequency measuring meter to probe the pins of one of the two internal light receptors (positive probe of the meter to the device and negative to the ground wire). Alternatively, you can probe the pins of the IC to find the same signal.

Now spin the small slotted wheels by hand and keep probing until you find a pin that has an output frequency that increases with the speed of one of the wheels. In the prototype, this

varied from about 40Hz to 2000Hz. Of course, if you have one, a scope is ideal for this sort of pin finding. Carefully solder a wire to this signal pin.

The output of the sensor is likely to be a varying DC signal. In fact, you don't even need a frequency meter to check this – just use your trusty old analogue multimeter switched to a low DC voltage range. At low frequency outputs, the needle will flicker faster or slower, depending on the speed of the wheel.

To block this DC component of the signal, wire a 470nF (0.47µF) capacitor in series with the output – this converts the signal to an AC waveform.

You now have an optical sensor with a high-resolution frequency output!

Amplifier: the cassette deck is used to amplify the small signals coming from the optical sensor. To achieve this, the signal output from the optical sensor is connected to the tape head input of the cassette player.

Access the cable that goes to the tape head. In most cheap cassette players, this will comprise just a single signal wire inside the shield. Connect this signal wire to the signal output of the optical sensor, then connect the shield (braid) of the head input wire to the ground wire of the mouse – see Fig.3.

Power up both the cassette player and the mouse, set the cassette player volume to full and press the 'play'

The mouse circuit board is held in position by a bracket formed from scrap aluminium sheet. Note that heatshrink has been used as an insulator between the board tracks and the bracket.

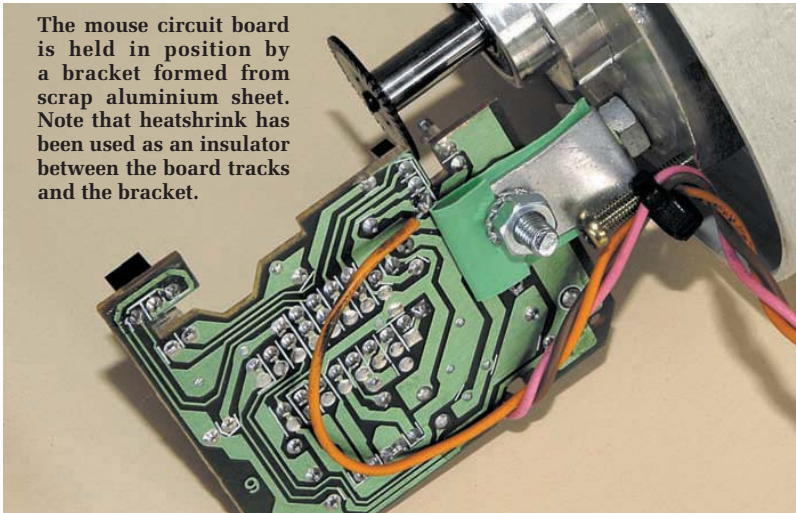

button. When you spin the optical wheel in the mouse, you should hear a noise from the cassette player's speaker that changes in pitch with wheel speed (in fact, if all you want is an audible wind speed indicator, you can pretty well stop right now – the wiring part of the project is finished!).

If you have difficulty finding the right wires from the head (perhaps because there are four wires or multiple heads), touch the different head connections with a finger while the tape player is running. Touching the correct signal wire will result in a loud hum in the speaker.

If you are using a mains-powered cassette player, you **must** take great care that you cannot come into contact with the high voltages. In this case, it is best to extend the head wires outside of the case and then temporarily close it up again.

Because the amplifier has very high gain, it is susceptible to picking up noise. To reduce this, a 1k Ω potentiometer is wired across the mouse output, with the wiper (moving contact) connected to the amplifier. In use, this pot is adjusted so that adequate signal is provided without there being too much noise present (indicated by lots of noise in the speaker, even with no rotation of the wheel). This wiring – and in fact the complete circuit of the anemometer – is shown in Fig.3.

You now have a high gain amplifier suitable for amplifying the output of the optical sensor!

Spinning assembly: disassemble the video head, gutting it of any electronics that you see. Pulling the head apart usually requires a Phillips head

screwdriver and a small metric Allen key. Some brass collars are also a light press-fit on the shaft – these can be removed by gently using a hammer and a punch. Prise out the black magnetic material that is within the head. It easily shatters, so be careful when doing this – it's best to wear safety glasses when performing this operation.

Once you've got the head bare, you can build the impeller. We used three small (1 teaspoon or 20ml) measuring spoons from a supermarket. These particular ones were made of stainless steel with a non-slip (and non-corrosive!) coating.

The spoons were bolted together, using the existing holes located at one end of the handles. The spoons were then spread evenly (ie, with a 120° spacing) and matching holes were drilled through the spinning aluminium housing and the handles of the spoons. The spoons were then bolted in place using short screws and nuts and once this was done, the heads of the spoons were carefully twisted through 90° to form the anemometer cup assembly.

The completed assembly should spin freely in even the lightest puff of wind. If the assembly is out of balance, hold the shaft horizontally and see which cups always points downwards. Place a small weight on the side opposite. Getting the assembly well-balanced yields dividends in longevity – an out-of-balance shaft puts a greater load on the bearings.

The half of the video head that contains the bearings is bolted to the

The spinning disc has lots of slots in it – we counted 40, but that might not be right! In any case, the output resolution of the sensor is very good – if you wish, you can calibrate the scale to read wind speeds of just a few kilometres per hour.



Stainless steel measuring spoons were used to form the anemometer cups. These were bought (gasp!) new for the project. You need three spoons of the same (15 or 20ml) size.

inside of a 90mm PVC pipe cap. As with the rotating part of the head, some new holes will probably need to be drilled through the aluminium for the mounting bolts.

The next step is to fit the slotted mouse wheel to the opposite end of the shaft to the cups. Cut the slotted encoder wheel off its plastic shaft and then use a fine flat file to smooth each side, being careful not to burr the tiny slots. Then, using instant adhesive, very carefully glue the slotted wheel to the end of the anemometer shaft. It needs to be perfectly concentric; ie,

Recycle It

The rotating assembly can be balanced by adding weights – here a bolt and some extra nuts (arrowed) have been placed on one side of the assembly.

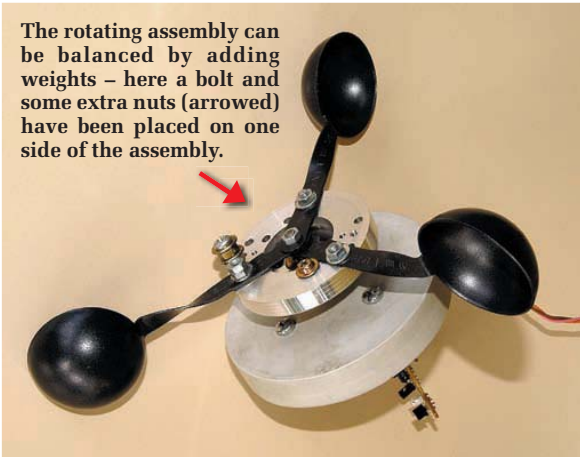

The speedo was mounted in a small picture frame. Note that it is easy to backlight the dial – all car speedos have this facility, and in some, even the needle is illuminated!

when the shaft is turning there is no run-out.

The mouse PC board is mounted so that the slotted wheel spins between the LED and its adjacent photosensor. We used a small piece of scrap aluminium to make the locating bracket. Note that if the shaft has a tendency to slide downwards through the bearings, so causing clearance problems between the slotted wheel and its sensor, place a drop of instant glue on the shaft right next to a bearing before sliding it through the bearing to the correct position.

You now have a very sensitive and durable spinning anemometer head with a variable frequency output!

Display: the display can comprise an electronic car speedo or tachometer, or a cassette deck VU meter.

The car instruments make for a much more impressive readout, so we've used one of those. In any case, we don't need the frequency-to-voltage converter that's used within these car instruments; instead, as mentioned earlier, we make our own charge pump system. Doing this means that we can match the amplified output of the optical sensor to a very wide range of meters, as well as easily changing characteristics like smoothing and range.

Remove the speedo or tacho and strip it down until just the meter and its electric movement remain. When a low voltage (eg, 2V) is applied, the meter should swing full scale. Take note of the positive and negative leads, as revealed by this test.

If you're using a speedo, you should be able to retain the standard km/h scale. Alternatively, if you use a tacho or you want the scaling to be different to the original on the speedo, a new scale will need to be made using a scanner, PC and printer (see *Recycle It!* in the Nov '08 issue for more on rescaling car tachos). In this case, the positions of

the increments will be found during the calibration procedure (see below).

You now have a large analogue anemometer readout!

Power supplies: two voltages need to be provided: 5V to the mouse circuit and (usually) 6V to the cassette player (we now know these components as the optical sensor and amplifier, respectively).

If absolute accuracy in the wind speed readout isn't required, the amplifier can be powered directly by the mains, batteries or a plugpack – whatever was originally used by the cassette player. The down-side of this approach is that the displayed wind speed will vary with supply voltage fluctuations. This is because the square-wave amplified output is driven from rail to rail – the cassette player is no longer acting as a feedback amplifier.

The alternative is to use a voltage regulator, which is what we chose to do. As well as providing better instrument accuracy, this also allows easy calibration in a car, as the system can be powered from the car supply. We powered the regulator from a spare plugpack we had previously salvaged.

The supply for the optical sensor is obtained by simply using a 10kΩ pot across the power feed that originally went to the cassette player motor, adjusted to provide 5V when loaded by the optical sensor.

Fig.3 shows the power supply wiring, both for the amplifier and the optical sensor.

Frequency-to-Voltage converter: the frequency-to-voltage converter (charge pump) is the final stage in the build

A Fun Instrument

If you want a fun instrument rather than a calibrated km/h design, simply pick capacitors in the charge pump that give full-scale deflection of the speedo when the cups are quickly flicked. Then use a computer, scanner and printer to make a scale that shows wind speeds like 'Boring', 'Some Excitement', 'Hell It's Blowing', 'Where's The Cat Gone?', 'Take Shelter!' and 'Are We Still Alive?'.

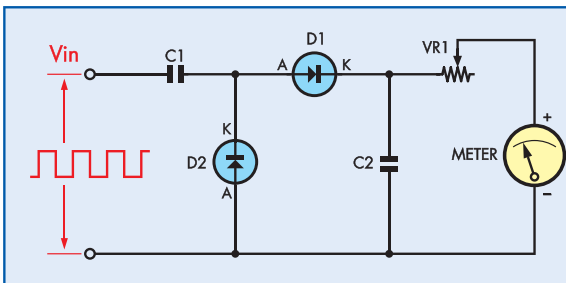
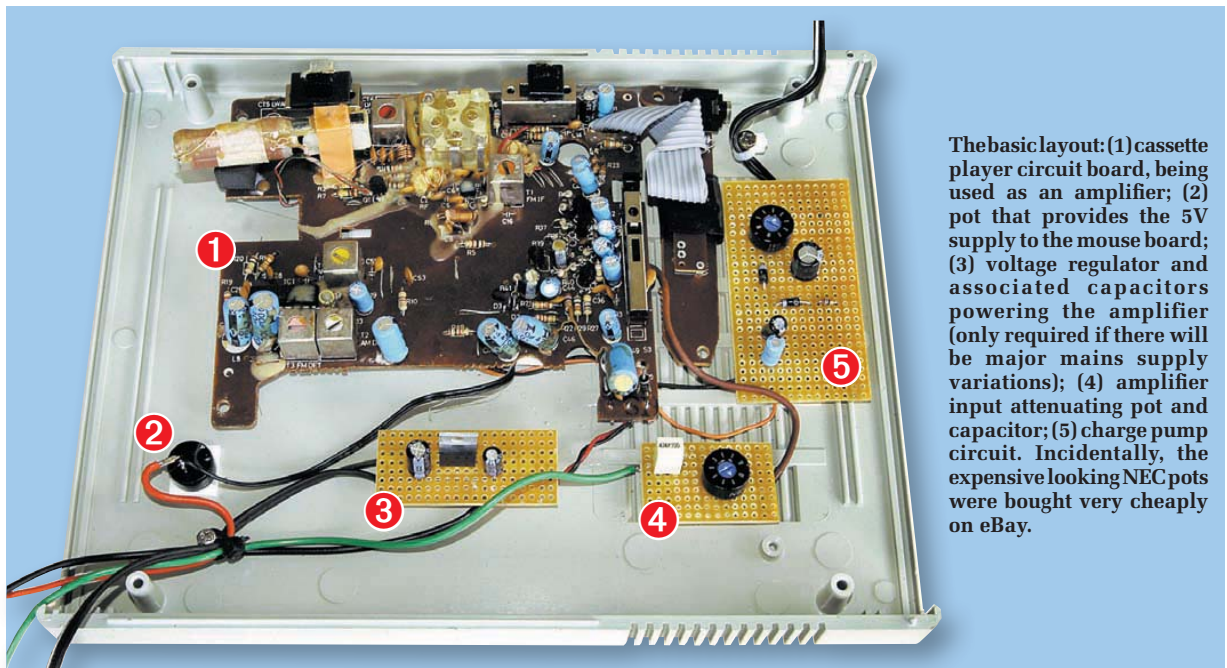

Fig.4: this charge pump circuit is used to convert the amplified frequency signal from the mouse to a DC signal proportional to the wind speed.



The basic layout: (1) cassette player circuit board, being used as an amplifier; (2) pot that provides the 5V supply to the mouse board; (3) voltage regulator and associated capacitors powering the amplifier (only required if there will be major mains supply variations); (4) amplifier input attenuating pot and capacitor; (5) charge pump circuit. Incidentally, the expensive looking NEC pots were bought very cheaply on eBay.

and is best optimised on the bench with the whole system working.

Fig.4 shows the way in which the charge pump works. For the moment, disregard VR1. Initially, capacitors C1 and C2 are discharged. When the input voltage goes high, C1 starts to charge through diode D1 and C2. Because C1 is much smaller than C2 (see Fig.3), C1 fully charges earlier than C2 and when this occurs, current stops flowing. However, during this process, C2 has received a small charge increase.

When the input voltage goes low, C1 discharges through D2, but C2 does not discharge because D1 blocks the discharge path. The result is that each time the input voltage goes high, a small amount of charge is added to C2, resulting in C2's voltage rising in proportion with the input frequency. Capacitor C2 powers the meter; ie, C2 is being constantly discharged by the meter's resistive load. VR1 allows adjustment of the meter's deflection for a given voltage level across C2.

Capacitor C2 should be kept as low as possible, but must be sufficient to provide a damped meter movement at the lowest frequency output at which the amplifier will work. If the speedo needle flickers when the cups are turned at the slowest speed at which you will be making measurements (this value depends on the scale you have

chosen), then C2 needs to be increased until the needle moves smoothly.

C1 needs to be small enough to allow it to fully discharge during the time that the input signal is low. In the prototype, where the car speedometer has a 100Ω resistance, C1 comprises two 10μF electrolytic capacitors (wired negative to negative to make the pair non-polarised), while C2 has a value of 220μF. The 16Ω resistor in series with C1 reduces the peak current through the amplifier.

Note that if you are using a VU meter instead of a car speedo, C1, C2 and the resistor in series with C1 will all be much lower in value.

It all starts to sound a bit complicated, but when you realise that the frequency-to-voltage charge pump circuit uses only six low-cost components, you can breathe easily again!

To find the best values for C1 and C2, initially lash up the anemometer circuit on the bench – power supplies and all. Start with the capacitor values cited above and set VR1 so that its resistance is as low as possible. Spin the anemometer cups by hand – rotating them fairly slowly – and check that the speedo (or VU meter needle) smoothly deflects a little.

Now spin the cups faster and check that the deflection is greater. Adjust



This is the cassette player that donated its amplifier. In many cases it will be easiest to use the original cassette player power supply and mount the new components inside.



The working anemometer, seen positioned high on the roof. The cup covering the centre section of the rotating assembly was made from an aerosol cap. For improved durability, everything you see here should be painted.

VR1 and check that the deflection for a given cup speed is reduced.

If the deflection is too small, increase the value of C1. If the needle deflection becomes non-linear at high speed (ie, its deflection is much less than expected), reduce the value of C1 and then reduce C2 proportionately. In short, just play around with the capacitor values (always keeping C1 much lower than C2) until the needle behaves as wanted over a variety of cup speeds.

Note that as a set-up guide, a fast flick of the anemometer cups will spin them to a wind speed of about 40km/h. If you only want to measure wind speeds up to 50km/h, size the capacitors so that you get nearly full scale deflection with a fast whiz of the cups.

Final assembly

The rotating assembly is completed by adding the short section of 90mm plastic pipe and the second end-cap.

Use PVC pipe adhesive to glue these parts together.

Alternatively, if you want to be able to easily disassemble the container, use self-tapping screws to hold one of the end-caps in place. Make sure you seal the hole where the cable exits. Note that the anemometer is orientated so that its rotating cups are below the plastic housing – this helps prevent the ingress of water. The prototype was mounted using square aluminium tube. This tube was bolted to the upper end cap.

We mounted the electronics in a new box. The cassette player PC board was removed from its original case. However, especially if you are going to use the cassette player's power supply, we suggest that you leave everything inside the cassette player, placing the charge pump and other minor components inside. If you remove the cassette player PC board to mount it in a new box, keep in mind that you must bridge the

switch that is normally activated when the 'Play' button is pressed – otherwise, the amplifier won't work. The display is easily mounted remote to the main box, so if retaining the cassette player housing, it's easy to tuck it out of sight.

While it might appear that the distance between the head and amplifier should be kept very short, we had no difficulties in stretching this distance to 25 metres, using salvaged multi-core alarm cable.

Calibration

Calibration is easily achieved by placing the whole device in a moving car, locating the rotating assembly outside, and then calibrating against the speedo reading. Just make sure that you do the calibration on a still day! The device can be powered by the car supply or the cassette player's internal batteries.

If you are using a preformed, linear scale, setting the correct needle position with VR1 should be done at a couple of speeds. Note that because of non-linearities in the anemometer aerodynamics, amplifier and meter, you won't get a perfectly accurate readout at all wind speeds – but you should be within 10% everywhere.

If you are devising your own scale, start with one with linear markings (eg, 1 to 10) on the scale. Write down the wind speed at each of the markings are then print out a revised scale with these speeds in the correct positions. Incidentally, if you want to decrease the sensitivity to high wind speeds (ie, expand the lower wind speed scale), tweaking the value of C1 upwards will do this for you!

Conclusion

This is a fun and engrossing project to make – from disassembling the mouse and video head, to trying different charge pump capacitor values to give you the scale and sensitivity that you want. The anemometer is sufficiently sensitive to spin with wind speeds of just 2 to 3km/h (and has an output resolution to measure those speeds too!) and if well balanced, is still rugged enough to cope with high speeds and full weather exposure.

Best of all, it makes use of a heap of stuff you'd otherwise just throw away!

EPE

Reproduced by arrangement
with SILICON CHIP
magazine 2009.
www.siliconchip.com.au

Rat It Before You Chuck It!



Whenever you throw away an old TV (or VCR or washing machine or dishwasher or printer) do you always think that surely there must be some good salvageable components inside? Well, this column is for you! (And it's also for people without a lot of dough.) Each month we'll use bits and pieces sourced from discards, sometimes in mini-projects and other times as an ideas smorgasbord.

And you can contribute as well. If you have a use for specific parts which can

easily be salvaged from goods commonly being thrown away, we'd love to hear from you. Perhaps you use the pressure switch from a washing machine to control a pump. Or maybe you have a use for the high-quality bearings from VCR heads. Or perhaps you've found how the guts of a cassette player can be easily turned into a metal detector. (Well, we made the last one up but you get the idea...)

If you have some practical ideas, write in and tell us!

Breadboarding Projects

by Dr Malcolm Plant

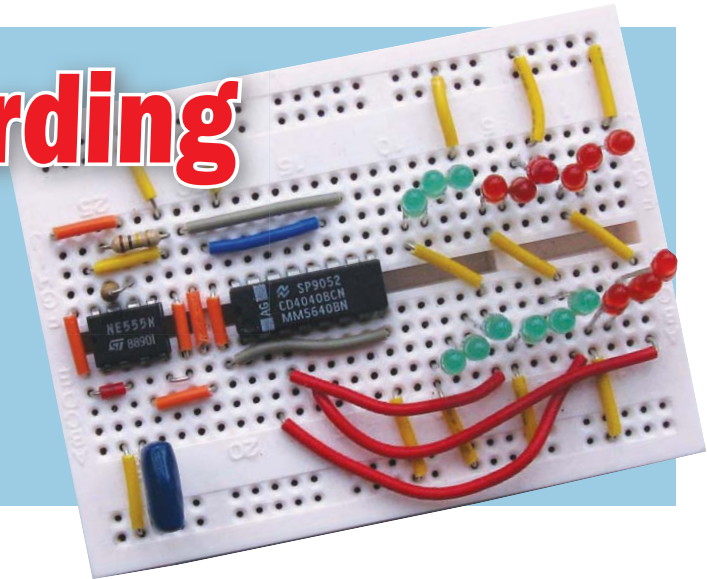

A beginner's guide to simple, solder-free circuit prototyping Part 11: Festive Lights

Project 19: Festive Lights

USING a few components you can easily assemble a light display that switches on and off at different repetition rates 18 light emitting diodes (LEDs) arranged in groups. This performance

could be incorporated in a festive display such as a small cardboard shape representing a tree, animal or such like.

Circuit diagram

The circuit is shown in Fig.11.1 and can be regarded as comprising two main building blocks. The first of these uses a 555 timer, IC1, operating as an astable that generates

pulses at a frequency determined by resistors R1 and R2, and polyester capacitor C1. The output pulses from pin 3 of IC1 are coupled directly to the clock terminal, pin 10, of IC2, a 4040 CMOS frequency counter/divider integrated circuit, which is the second building block.

IC2 being a binary divider means that the input frequency is divided by factors of 2, 4, 8, 16 etc, and these divided

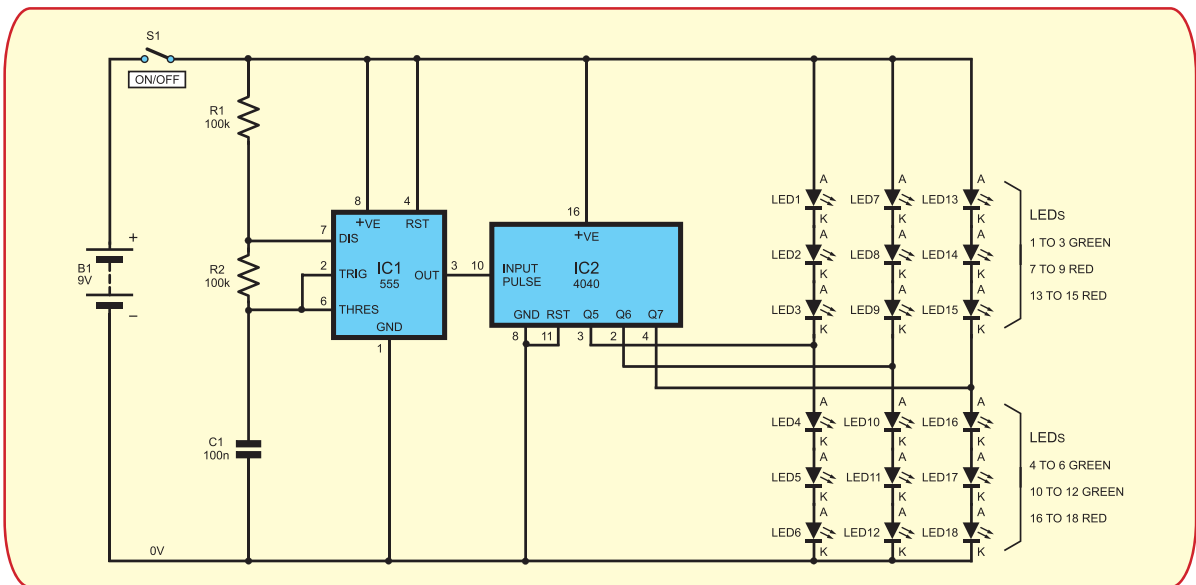

Fig. 11.1. Complete circuit diagram for the Festive Lights project

frequencies are available at the output pins to drive the LEDs, which are arranged in three banks. Each bank comprises six LEDs, three of which are on at any moment while the other three are off, each group flashing alternately on and off. In this case, the pins used are 3(+32), 2(+64) and 4(+128) so that each bank of six LEDs flashes at a different frequency.

Flash rate

Thus, if those connected to pin 3 flash at frequency f_0 , those connected to pin 2 flash at $f_0/2$, while those connected to pin 4 flash at $f_0/4$. If the astable frequency is 48Hz, the frequencies at these pins are about 1.5Hz, 0.75Hz and 0.375Hz.

Given the component values in the circuit, i.e. $R1 = R2 = 100k\Omega$ and $C1 = 100nF$ or $0.1\mu F$, the frequency of the astable is given by $1/(0.7(2 \times R2 + R1) \times C1)$. Therefore, the frequency is $1/(0.7 \times 300k\Omega \times 0.1\mu F) = 1/(0.7(3 \times 10^5 \times 10^{-7}))$

Component Info

IC1, type 555 timer IC

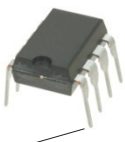

PIN 1

Viewed from the top, an indented dot and a 'half-moon' shape at one end indicate pin one. The pins are numbered anti-clockwise ending at pin 8 opposite pin 1.

IC2, type 4040 frequency counter/divider



PIN 1

Once pin 1 has been identified, pins are numbered 1 to 16 going anticlockwise.

LED1 to LED 18, 3mm green (9) and red (9) light-emitting diodes



The longer lead is the anode, the shorter lead is the cathode.

Components needed...

Festive Lights

Integrated circuit, IC1: type 555 timer

Integrated circuit, IC2: type 4040 CMOS frequency counter/divider

Light emitting diodes, LED1 to LED 18: Suggest nine green, nine red, or colours to choice

Capacitor, C1: value 100nF (0.1μF) polyester

Resistors, R1, R2: value 100kΩ. Both 0.25W 5% carbon film

Switch, S1 (On/Off): single-pole, single-throw (SPST)

Battery, B1: 9V plus connecting leads

Protobloc and wire links



Fig. 11.2. Waveform produced by the astable

$= 1/(0.7 \times 3 \times 10^{-2}) = 10/0.21 = 50\text{Hz}$ approximately. This is close to the assumed value of 48Hz used above. The flashing frequency of the LEDs attached to pin 3 of IC2 is thus about 1.5 per second.

As Fig.11.2 shows, the frequency of the astable was checked with a

hand-held oscilloscope and found to be close to 50Hz as indicated by the two markers on the rectangular waveform pattern. The two markers indicate the period of the waveform as 21ms giving a frequency of $1/21\text{ms} = 1000/21 = 47.6\text{Hz}$.

Notes

- The LEDs do not require series resistors, provided each bank comprises no less than three LEDs and the supply voltage does not exceed 9V

- None of the component values are critical and it is worth experimenting with resistors R1, R2 and capacitor values.

- Other outputs of IC2 can be selected to provide different division frequencies and hence different flashing frequencies. The relevant pins are 5, 6 and 7. **EPE**

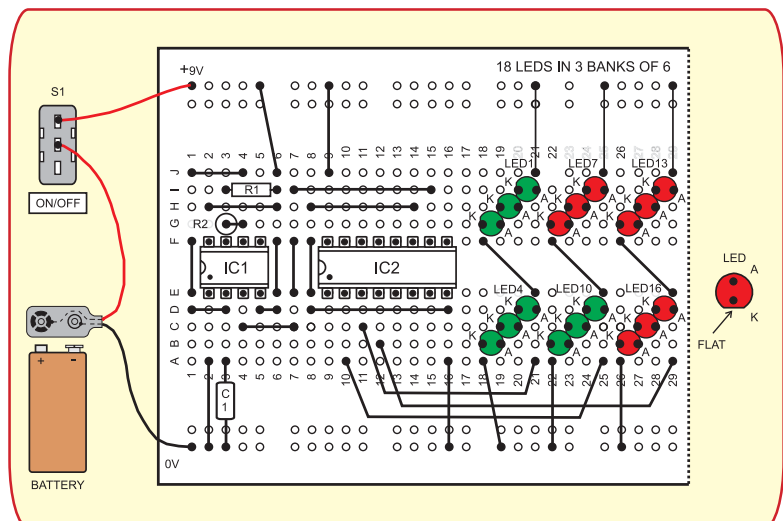
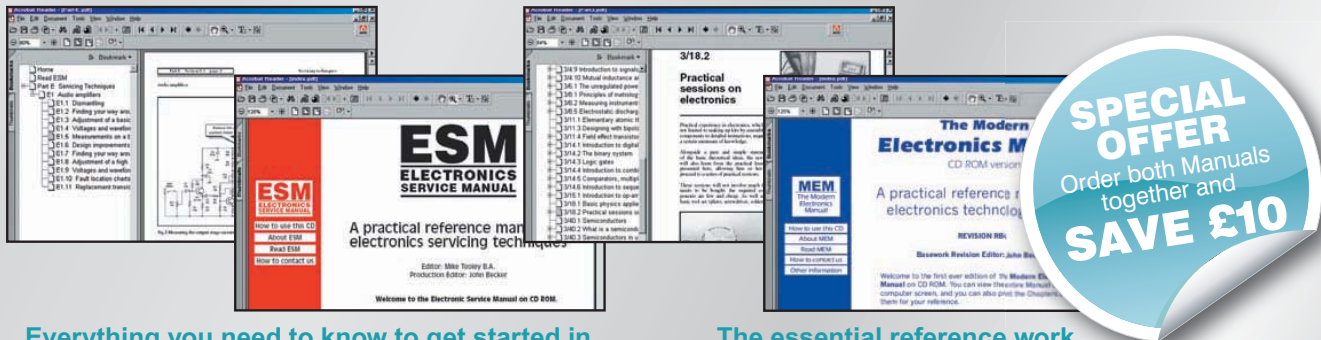

Fig. 11.3. Protobloc assembly and wiring details for the Festive Lights circuit

ELECTRONICS MANUALS ON CD-ROM £29.95 EACH

ELECTRONICS SERVICE MANUAL

MODERN ELECTRONICS MANUAL



SPECIAL OFFER
Order both Manuals together and **SAVE £10**

Everything you need to know to get started in repairing electronic equipment

- Around 900 pages • Fundamental principles • Troubleshooting techniques • Servicing techniques • Choosing and using test equipment • Reference data • Manufacturers' web links • Easy-to-use Adobe Acrobat format • Clear and simple layout • Vital safety precautions • Professionally written • Supplements

SAFETY: Safety Regulations, Electrical Safety and First Aid. **UNDERPINNING KNOWLEDGE:** Electrical and Electronic Principles, Active and Passive Components, Circuit Diagrams, Circuit Measurements, Radio, Computers, Valves and manufacturers' Data, etc. **PRACTICAL SKILLS:** Learn how to identify Electronic Components, Avoid Static Hazards, Carry Out Soldering and Wiring, Remove and Replace Components. **TEST EQUIPMENT:** How to Choose and Use Test Equipment, Assemble a Toolkit, Set up a Workshop, and Get the Most from Your Multimeter and Oscilloscope, etc. **SERVICING TECHNIQUES:** The Manual includes vital guidelines on how to Service Audio Amplifiers. The Supplements include similar guidelines for Radio Receivers, TV Receivers, Cassette Recorders, Video Recorders, Personal Computers, etc. **TECHNICAL NOTES:** Commencing with the IBM PC, this section and the Supplements deal with a very wide range of specific types of equipment – radios, TVs, cassette recorders, amplifiers, video recorders etc. **REFERENCE DATA:** Diodes, Small-Signal Transistors, Power Transistors, Thyristors, Triacs and Field Effect Transistors. Supplements include Operational Amplifiers, Logic Circuits, optoelectronic Devices, etc.

The essential reference work for everyone studying electronics

- Over 800 pages • In-depth theory • Projects to build • Detailed assembly instructions • 1 Full components checklists • Extensive data tables • Manufacturers' web links • Easy-to-use Adobe Acrobat format • Clear and simple layout • Comprehensive subject range • Professionally written • Supplements

BASIC PRINCIPLES: Electronic Components and their Characteristics; Circuits Using Passive Components; Power Supplies; The Amateur Electronics Workshop; The Uses of Semiconductors; Digital Electronics; Operational Amplifiers; Introduction to Physics, including practical experiments; Semiconductors and Digital Instruments.

CIRCUITS TO BUILD: The Base Manual describes 12 projects including a Theremin and a Simple TENS Unit. **ESSENTIAL DATA:** Extensive tables on diodes, transistors, thyristors and triacs, digital and linear i.c.s. **EXTENSIVE GLOSSARY:** Should you come across a technical word, phrase or abbreviation you're not familiar with, simply look up the glossary and you'll find a comprehensive definition in plain English. The Manual also covers **Safety** and provides web links to component and equipment **Manufacturers and Suppliers**.

Full contents list available online at: www.epemag.com

SUPPLEMENTS: Additional CD-ROMs each containing approximately 500 pages of additional information on specific areas of electronics are available for £19.95 each. Information on the availability and content of each Supplement CD-ROM will be sent to you.

PRESENTATION: CD-ROM suitable for any modern PC. Requires Adobe Acrobat Reader which is included on the CD-ROM.

Wimborne Publishing Ltd., Sequoia House, 398a Ringwood Road, Ferndown, Dorset BH22 9AU. Tel: 01202 873872. Fax: 01202 874562.

PLEASE send me

- THE MODERN ELECTRONICS MANUAL CD-ROM
 ELECTRONICS SERVICE MANUAL CD-ROM
 I enclose payment of £29.95 (for one manual) or £49.90 for both manuals (saving £10 by ordering both together).

FULL NAME

ADDRESS

POSTCODE

SIGNATURE

- I enclose cheque/PO in UK pounds payable to Wimborne Publishing Ltd.
 Please charge my Visa/Mastercard/Maestro

Card No Maestro Issue No

Valid From Expiry Date Card Security Code

(The last 3 digits on or just under the signature strip)

ORDER FORM

Simply complete and return the order form with your payment to the following address:

**Wimborne Publishing Ltd,
 Sequoia House, 398a Ringwood Road,
 Ferndown, Dorset BH22 9AU**

Price includes postage to anywhere in the World

We will happily exchange any faulty CD-ROMs but since the content can be printed out we do not offer a refund on these items.



Your CD-ROM(s) will be posted to you by first class mail or airmail, normally within four working days of receipt of your order

INTERFACE

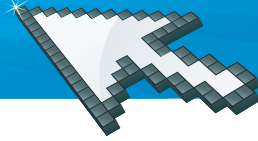

CALCULATED CONNECTION

This series is not primarily aimed at beginners, and it is generally written on the assumption that the reader understands the basics of computer interfacing. However, we do, occasionally, consider some fundamental aspects of computer interfacing, and will do so in this month's *Interface* article.

Most PC add-ons communicate with the outside world via 8-bit parallel ports. Even when using some form of serial port of the computer, such as a RS232C or USB type, there will be a conversion to parallel data in the add-on device and communication with the outside world will ultimately be in parallel form.

Hidden values

There are two fundamentally different ways of using an 8-bit port, and with one method the port is used to read a numeric value from a peripheral, or to write a numeric value to it. As a couple of examples, with a computer controlled power supply you would perhaps write values from 0 to 255 to the peripheral, producing output voltages from 0 to 25.5V with 0.1V resolution. A temperature interface could provide values from 0 to 255, representing a temperature range of 0 to 127.5 degrees Celsius, with 0.5 degree resolution.

In both cases, the hardware could be relatively complex, but the software is usually very straightforward. The data is sent or received in binary form on eight digital lines, but the computing language provides the binary-to-decimal or decimal-to-binary conversions.

It is usually necessary for the program to provide some simple mathematics in order to get the scaling right, but there is no need for the programmer to have an understanding of binary arithmetic. Everything is handled in decimal form, and the binary origins of the data are hidden from the programmer.

With some types of interfacing, it is actually strings of characters that are handled by the computer program, albeit with some mathematics provided by a microcontroller in the interface. Again, the application program is unlikely to involve even the slightest hint of binary arithmetic.

An 8-bit port can only handle a range of 256 values from 0 to 255, but a wider range of values can be accommodated using a 16-bit port, or two 8-bit types used together to provide 16-bit transfers. This gives a range of 65536 values from 0 to 65535, which is more than enough for the vast majority of real-world applications.

When combining two 8-bit values to produce the full 16-bit type, it is still unnecessary to get involved with binary values or arithmetic. It is just a matter of multiplying the most significant byte by 256 and adding it to the least significant byte.

Right lines

The second way of using a port does not use the lines together to transfer values, but instead has each one providing a separate function. In some cases, these lines are of the handshake variety, which simply means that they are used to control the flow of data into and (or) out of the computer via another port.

In other instances they are not used in a supporting role, but are providing the main

A bit clever

The standard way of reading one bit of a port is to use so-called 'bitwise' operations, and in this context it is the bitwise AND operation that is of use. When you look at the result of a bitwise AND operation, with the figures in decimal form, it tends to look nonsensical. You really have to look at the figures in their binary versions in order to make sense of things.

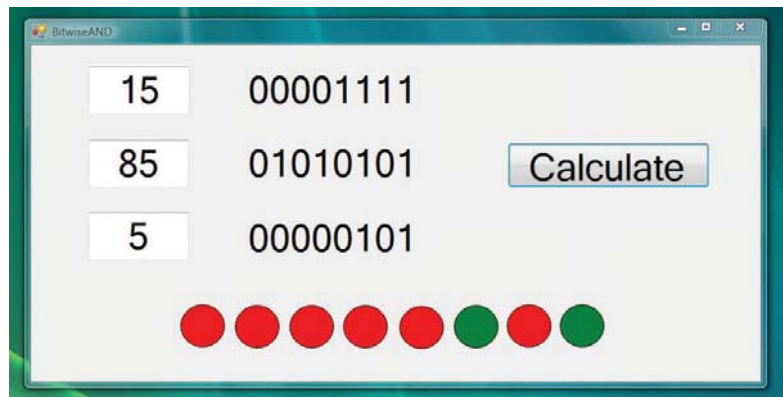

Fig.1. Demonstration program in action

function. For example, they could be used to control electric motors or lights via relay drivers, or to monitor sensors in an alarm system.

In both cases, the lines have individual functions and are not working together to transfer numeric data or strings, but the programming language will not necessarily have the ability to handle the lines on an individual basis. Instead, all the output lines must be set at the desired states by writing the appropriate value to the output port. This complicates matters if it is only necessary to change the state of one line, because care has to be taken to leave all the others at their original states. Reading one line is not possible, but the state of an individual line can be determined by reading the value from the port and using some mathematics to effectively eliminate the lines that are of no interest.

It is worth pointing out that micro-controllers are generally designed to be able to handle things on a more bit-by-bit basis when necessary, and may well have instructions that apply to specific lines of a port. Consequently, with a PC add-on based on a microcontroller it might be possible to handle some line reading and writing in the microcontroller without recourse to the PC. This will not always be a practical proposition though, and some applications will require the PC to be in full control of the add-on gadget.

A bitwise AND operation takes each bit of the first number and pairs it with the corresponding bits of the second number. There is only a 1 in a bit of the answer if that bit is 1 in the first number and the second number. A 1 and a 0 or two 0s result in 0 being placed in the corresponding bit of the answer. The AND operator provides essentially the same function as a set of eight 2-input AND gates.

The program in Listing 1 demonstrates the use of bitwise ANDing. This has three textboxes that are used to enter the two numbers to be processed, and to display the answer. There are three labels that are used to display the binary equivalents of the three decimal values. A button is operated when new values are ready for processing. Fig.1 shows the program in action, with decimal values of 15 and 85 being bitwise ANDed to produce an answer of 5. The decimal figures seem to lack reason, but matters are clearer when the binary values are considered. It is only bits 0 and 2 that are set at 1 in both the values, and so it is only these bits that are set to 1 in the answer. These represent 1 and 4 respectively in decimal, giving a total of 5.

Masking

The way in which bitwise ANDing is used to mask bits that are not of interest is very simple. Suppose that it is only bit 7 that is of interest. This bit is set at one in the masking number, but all the other bits are set

to zero. In decimal terms this means using a masking value of 128. Bitwise ANDing the value read from a port with a masking value of 128 ensures that bits 0 to 6 are set at 0 in the answer, since they cannot be at 1 in both the numbers being processed. The same is not true of bit 7, which is at 1 in the masking number, and will also be set at 1 in the answer

if bit 7 of the port is also at 1. In other words, a value of 0 is obtained if bit 7 of the port is at logic 0, and a value of 128 is produced if bit 7 of the port is at logic 1. Only these two values can be produced, and the states of the other seven lines of the port are irrelevant.

It has been assumed here that only one input line will be read, but in some

applications it might be necessary to read a few bits. This can be achieved by reading the relevant bits individually, or by using a masking number that enables them to be read as a group. For example, suppose that bits 0 to 3 are of interest, and bits 4 to 7 must be masked. Using a masking value of 15 (00001111 in binary) excludes bits 4 to 7, and reads the value present on bits 0 to 3.

In the demonstration program, a series of bitwise AND instructions are used to determine the state of each bit in the three values, so that their binary equivalents can be printed in the three label components. In a real-world situation the program would often poll the input line, and use a conditional instruction to perform a certain task when the line goes to the appropriate state.

Sometimes, an input line must be used to control an on-screen indicator light, and this facility is included in the demonstration program. The answer of the bitwise AND operation is displayed on a set of eight 'lights', which go red for logic 0 or green for logic 1.

The Line and Shape objects are not a standard part of Visual BASIC 2008 Express Edition, but they can be added via the optional Power Pack download. The latter should be considered essential if you need to produce virtual indicator lights, meters, control knobs, or whatever.

Listing 1

Public Class Form1

```
Private Sub Button1_Click(ByVal sender As System.Object, ByVal e As System.EventArgs) Handles Button1.Click
```

```
    TextBox3.Text = TextBox1.Text And TextBox2.Text
    Dim B0, B1, B2, B3, B4, B5, B6, B7 As Byte
    Dim D0, D1, D2, D3, D4, D5, D6, D7 As Byte
    Dim F0, F1, F2, F3, F4, F5, F6, F7 As Byte
```

```
    B0 = (TextBox1.Text And 1)
    If (TextBox1.Text And 2) = 2 Then B1 = 1
    If (TextBox1.Text And 4) = 4 Then B2 = 1
    If (TextBox1.Text And 8) = 8 Then B3 = 1
    If (TextBox1.Text And 16) = 16 Then B4 = 1
    If (TextBox1.Text And 32) = 32 Then B5 = 1
    If (TextBox1.Text And 64) = 64 Then B6 = 1
    If (TextBox1.Text And 128) = 128 Then B7 = 1
    Label1.Text = B7 & B6 & B5 & B4 & B3 & B2 & B1 & B0
```

```
    D0 = (TextBox2.Text And 1)
    If (TextBox2.Text And 2) = 2 Then D1 = 1
    If (TextBox2.Text And 4) = 4 Then D2 = 1
    If (TextBox2.Text And 8) = 8 Then D3 = 1
    If (TextBox2.Text And 16) = 16 Then D4 = 1
    If (TextBox2.Text And 32) = 32 Then D5 = 1
    If (TextBox2.Text And 64) = 64 Then D6 = 1
    If (TextBox2.Text And 128) = 128 Then D7 = 1
    Label2.Text = D7 & D6 & D5 & D4 & D3 & D2 & D1 & D0
```

```
    F0 = (TextBox3.Text And 1)
    If (TextBox3.Text And 2) = 2 Then F1 = 1
    If (TextBox3.Text And 4) = 4 Then F2 = 1
    If (TextBox3.Text And 8) = 8 Then F3 = 1
    If (TextBox3.Text And 16) = 16 Then F4 = 1
    If (TextBox3.Text And 32) = 32 Then F5 = 1
    If (TextBox3.Text And 64) = 64 Then F6 = 1
    If (TextBox3.Text And 128) = 128 Then F7 = 1
    Label3.Text = F7 & F6 & F5 & F4 & F3 & F2 & F1 & F0
```

```
        If F7 = 1 Then OvalShape1.FillColor = Color.Green Else OvalShape1.FillColor = Color.Red
        If F6 = 1 Then OvalShape2.FillColor = Color.Green Else OvalShape2.FillColor = Color.Red
        If F5 = 1 Then OvalShape3.FillColor = Color.Green Else OvalShape3.FillColor = Color.Red
        If F4 = 1 Then OvalShape4.FillColor = Color.Green Else OvalShape4.FillColor = Color.Red
        If F3 = 1 Then OvalShape5.FillColor = Color.Green Else OvalShape5.FillColor = Color.Red
        If F2 = 1 Then OvalShape6.FillColor = Color.Green Else OvalShape6.FillColor = Color.Red
        If F1 = 1 Then OvalShape7.FillColor = Color.Green Else OvalShape7.FillColor = Color.Red
        If F0 = 1 Then OvalShape8.FillColor = Color.Green Else OvalShape8.FillColor = Color.Red
```

End Sub

```
Private Sub Form1_Load(ByVal sender As System.Object, ByVal e As System.EventArgs) Handles MyBase.Load
```

```
End Sub
End Class
```

Write lines

In order to write to a single line of an output port, without altering the states of the other lines, it is essential to know the current states of the other lines. Since it is not normally possible to read the current levels from an output port, this must be achieved by using a variable to store the last value written to the port. This value can then be bitwise ANDed with a masking number that operates in the opposite way to a masking number used to read a single line.

The masking value has all the bits set to 1, apart from the bit that is to be changed. For example, if bit 2 is to be changed, a masking value of 251 (255 - 4, or 11111011 in binary) would be used. If bit 2 is to be set at 0, the value obtained from this operation would be written to the port. It is just a matter of adding 4 to the value before writing it to the port if bit 2 must be set at 1. There are other ways of achieving the same thing, such as a method that uses the exclusive OR (XOR) bitwise operator, but they are really just variations on the same basic method.

**TO ADVERTISE IN
EVERYDAY
PRACTICAL
ELECTRONICS
PLEASE CONTACT
Stewart Kearn on
01202 873872**

**or email
stewart.kearn@
wimborne.co.uk**

Ingenuity Unlimited

Our regular round-up of readers' own circuits

WIN A PICO PC-BASED OSCILLOSCOPE WORTH £799

- 200MHz Analogue Bandwidth Dual Channel Storage Oscilloscope
- Spectrum Analyser
- Frequency Meter
- Multimeter
- USB Interface.

If you have a novel circuit idea which would be of use to other readers then a Pico Technology PC-based oscilloscope could be yours.

After every 20 published IU circuits, Pico Technology will be awarding a PicoScope 3206 digital storage oscilloscope for the best IU submission. In addition a PicoScope 2105 Handheld 'Scope worth £199 will be presented to the runner up.

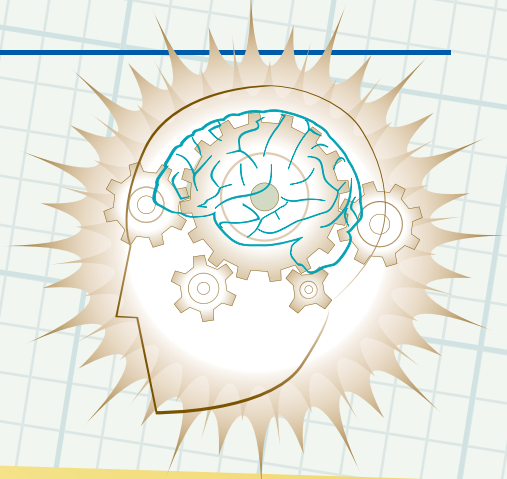
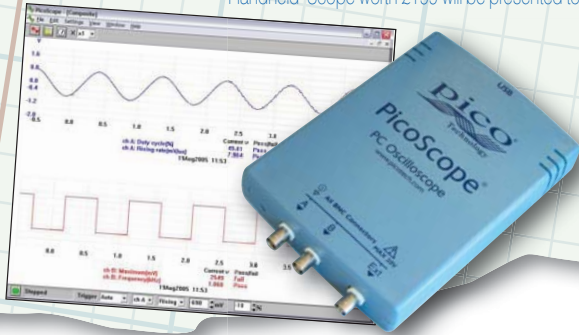

We pay between £10 and £50 for all material published, depending on length and technical merit. We're looking for novel applications and circuit designs, not simply mechanical, electrical or software ideas. Ideas must be the reader's own work and must not have been published or submitted for publication elsewhere.

The circuits shown have NOT been proven by us. Ingenuity Unlimited is open to ALL abilities, but items for consideration in this column should be typed or word-processed, with a brief circuit description (between 100 and 500 words maximum) and include a full circuit diagram showing all component values. Please draw all circuit schematics as clearly as possible. Send your circuit ideas to: Ingenuity Unlimited, Wimborne Publishing Ltd., Sequoia House, 398a Ringwood Road, Ferndown, Dorset BH22 9AU. Email: editorial@epemag.wimborne.co.uk. Your ideas could earn you some cash and a prize!

Optical Motion Detector – Ronchigrated

The main problem with an optical motion detector is that it has to be equally sensitive to dark targets on a bright background or to bright targets on a dark background. This detector incorporates a homemade Ronchi grating which causes any target (bright or dark) to produce equal numbers of 'bright-up' or 'dark-up' pulses as it moves across the field of view. This means

that the motion detector circuit (Fig.1) can be simplified greatly by operating only with one polarity of signal, although in practice it is always easier to detect bright-up signals.

Ronchi grating

Ronchi gratings are simple patterns of dark lines printed on a transparent material. The lines must always be arranged to cover 50%

of the area of the grating, but apart from that they can be printed in a wide variety of shapes.

The grating I made has lines and spaces 5mm wide, positioned 50mm from the phototransistor (TR6). Spacing depends on the size of target you want to detect and is calculated (by similar-triangles) to be about as wide as the target when projected out to target range. My 5mm grating would be

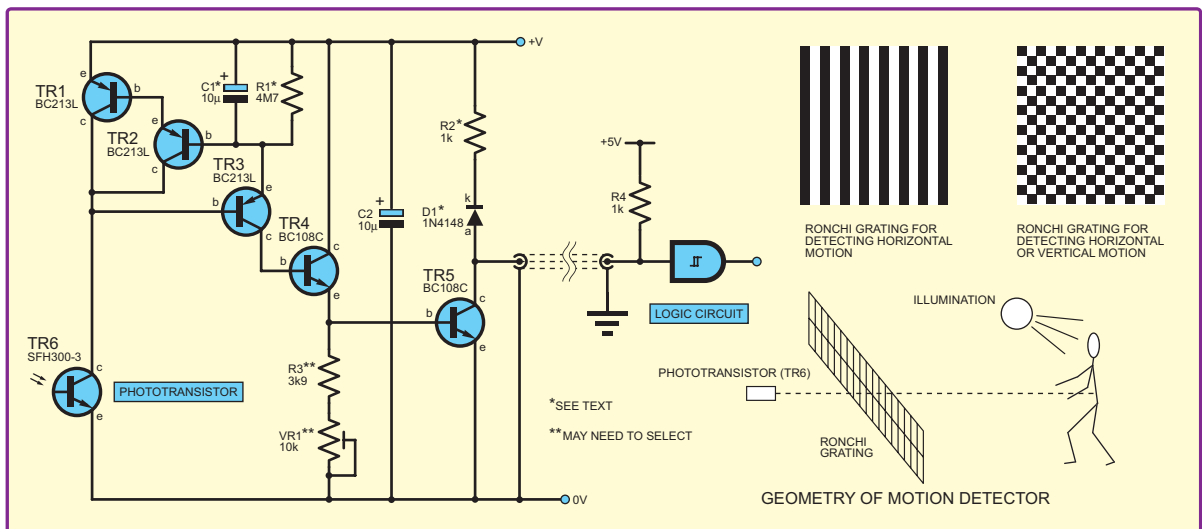

Fig.1. Circuit diagram for the Optical Motion Detector

suitable for a man-target at about 5m range, though in practice the range isn't critical.

There are lots of ways to make the grating, and it doesn't have to be a great work of art to be effective, as long as the edges are fairly sharp. I made the lines using black electrical tape, but they could be computer-drawn and printed on transparent film. The ultimate form of Ronchi would be to paint broad black and white 'zebra' stripes on a wall where an intruder has to pass, but putting the stripes inside the detector enclosure is simpler.

Fig.1 shows some examples of gratings. It also includes the optical layout of the detector, which is basically just a phototransistor (TR6) 'staring' through the grating at the outside world. It needs a good light-tight enclosure, and to be electrically screened, as the detector has a lot of gain. The inside should be painted matt-black and it will also need suitable light-baffles and a hood to prevent unwanted light from hitting the phototransistor.

Circuit description

The Optical Motion Detector circuit (Fig.1) consists of two stages. The first stage, based around TR1 and TR2, supplies a constant voltage to the phototransistor

(TR6). Because of capacitor C1 and resistor R1, it becomes a constant current supply when the phototransistor current increases rapidly. This means that current changes go entirely to the base (b) of TR3. This stage also works as an adaptive threshold, so the detector ignores the mains ripple which rides on artificial light sources.

The second stage is a Darlington arrangement for TR3 and TR4 to drive the TR5 open-collector output stage. This is intended to interface with logic circuits. Preset VR1 sets the sensitivity once the detector is installed. VR1 is adjusted to set the base of TR5 to 300mV to 350mV to give good sensitivity without too many false alarms under ambient conditions.

The detector is powered by current stolen from a logic pull-up, but it can also be run from a separate supply, eg 9V, by removing diode D1. The 1k resistor, R2, is there to prevent the circuit from 'crowbaring' the supply if too much light accidentally enters the enclosure.

This detector doesn't include a monostable like many circuits do. It is assumed that the downstream logic will sort out multiple detections. It takes about one second to recover from a detection. You can experiment with the values of C1 and R1 to adjust the sensitivity to target speed and the recovery time.

Walter Gray, Farnborough

INGENUITY UNLIMITED BE INTERACTIVE

IU is your forum, where you can offer other readers the benefit of your Ingenuity. Share those ideas, earn some cash and possibly a prize.



Why not take a look at our website:
www.epemag.com



Get your magazine 'instantly' anywhere in the world – buy and download from the web.

TAKE A LOOK, A FREE ISSUE IS AVAILABLE

A one year subscription (12 issues) costs just \$18.99(US)

Back issues are also available



ANDRE LAMOTHE'S
XGAMESTATION
LEARN STEP-BY-STEP HOW TO DESIGN
AND BUILD YOUR OWN VIDEO GAME CONSOLE!

Design inspired by the Atari 800/2600,
Sinclair ZX Spectrum, Apple II & Commodore 64!

Complete Package eBook Integrated IDE

SX52 CPU 80 MIPS! **OPEN SOURCE!**

FEATURES:

- Great for Hobbyists AND Students!
- Complete Software Development Kit!
- eBook on Designing the XGS Console!
- Parallax SX-Key Compatible!
- Fully Assembled XGS Micro Edition Unit!
- The Fun Way to Learn Embedded Systems!

PAL & NTSC COMPATIBLE!

WWW.XGAMESTATION.COM
SUPPORT@NURVE.NET PH 5 12.266.2399(USA)

Filters circuits Part 2

Last month, in response to a question about filters on the *EPE Chatzone* (chatzones.co.uk) from **Paul Goodson** we discussed some of the basic concepts behind filter circuits. Filters are circuits that pass signals at certain frequencies (in the pass band) while rejecting signals at other frequencies (in the stop band). A frequency that divides the pass band from the stop band is a cut-off frequency.

We described various terms and characteristics related to filters, such as pass band, stop band, cut-off frequency, roll-off, ripple, rise-time and overshoot, and poles and zeros. This month we will be making use of these terms to describe the various filter types which are available.

As Paul hinted in his question, full analysis of filter circuits requires some advanced mathematics; however, it is possible to design good filter circuits without doing a vast amount of algebra. Indeed, traditionally, many filters were designed using a 'cookbook' approach in which tables of values and simple formula could be applied to find the required component values. These days it is even easier, with software applications available that calculate the component values for you. We will look at an example of such software this month.

Your application should define your basic filter response (high-pass, low-pass etc) cut-off frequency, required attenuation in the stop band, sharpness of cut-off and allowable pass band ripple. These specifications can be visualised using a diagram like the one shown in Fig.1. The filter's frequency response curve has to fit into the unshaded region in order to meet the specification.

The major design decisions are what filter type to use, and what circuit to implement it with. For each type of filter there may be further options or variations to choose. Similarly, with each basic circuit type there may be further choices to make. When using filter synthesis software these decisions will be reflected in the information you have to provide to the software.

Filter software

The free filter synthesis programme we use in this article is from NuhertzTechnologies (www.nuhertz.com) of Phoenix, Arizona. They were founded in 1999 and describe themselves as a worldwide leader in low and high frequency filter synthesis and analysis. They have developed numerous advanced filter synthesis algorithms to provide design automation of frequency selective circuits.

One of Nuhertz's main products is Filter Solutions, an advanced filter design software application. They also provide a lower cost 'light' version and, most importantly for hobbyist and student designers, a free version called Filter Free. Filter Free can be downloaded from www.nuhertz.com/download.html.

There are, of course, filter synthesis applications that are worth checking out. One example is FilterPro from Texas Instruments (see focus.ti.com/docs/toolsw/folders/print/filterpro.html). This provides more user control over component values and can synthesise higher order filters than Filter Free, but it is restricted to low-pass filters and supports fewer filter types and circuit configurations than Filter Free.

Taking a look at the screen shot of Filter Free (Fig.2) you will see various sections of the window. A brief outline of these is given below. Other filter synthesis software will require similar data input.

Filter type: The mathematical function on which the filter is based. We will discuss this in more detail shortly. The Filter Free

help system also provides information on each filter type, including details of any type-specific settings.

Filter attributes: Set order, cut-off frequency and various additional options depending on filter type. Filter Free is limited to a maximum of third order filters.

Implementation: Select one of passive lumped, passive distributed, active, switched capacitor or digital filter. Choose Active for the op amp-based analogue filters which we are discussing here.

Filter class: High-pass, low-pass etc. Choose the form of filter you want.

Freq scale: Controls scale format on frequency response graphs. Set to **Hz** and **log** for a standard frequency response graph using a Hertz frequency scale.

Graph limits: Controls range over which frequency response graph and time response waveforms are plotted. A good starting point for Min Freq and Max Freq is one tenth and ten times the cut-off frequency (f_c) respectively.

A suggested start point for these times are Min Time = 0 and Max Time = 10/ f_c . These can easily be adjusted if the graphs are not as required.

Ideal filter response: This section has four buttons which display the corresponding information when the button is clicked. In Filter Free these are idealised plots based on the mathematic functions and are not based on a simulation of the circuit implementation.

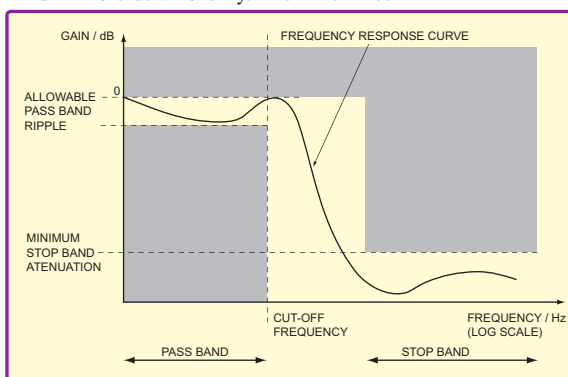

Fig. 1. Visualising a filter specification (low-pass filter)

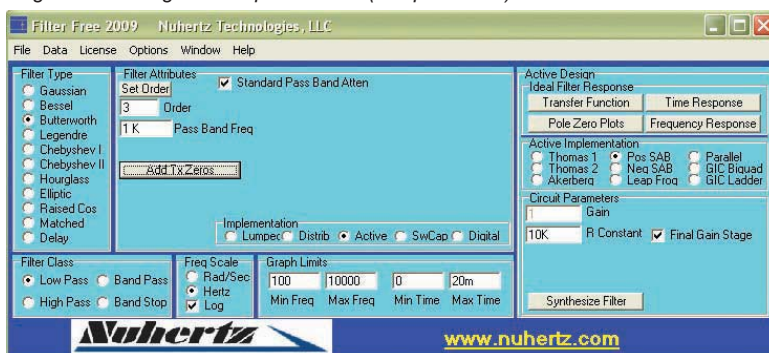

Fig. 2. Screen shot of Filter Free

Active implementation: Determines which circuit configuration is used by Filter Free to synthesise the filter. We will discuss this in more detail later. Note that some implementations may not be available for some types of filter. The Filter Free help system provides details on the filter implementations.

Circuit parameters: Set circuit-specific parameters. These also depend on the type and class of filter selected. Refer to the Filter Free help system for full details. Clicking the Synthesis Filter button provides you with a schematic of your filter and access to a SPICE netlist.

As you can see from the screen shot (Fig.2) FilterFree provides eleven different types, but we will limit our discussion this month to just three of these: *Bessel*, *Butterworth* and *Chebyshev*, which are possibly the most commonly used filter types. Some filter design software may be limited to just one or two types.

The names of filter types typically come from the underlying mathematical functions on which they are based, these in turn are typically named after the mathematicians who discovered or developed the theory behind those functions. For example, Bessel filters are named after the German mathematician Friedrich Wilhelm Bessel (1784–1846) and Chebyshev filters are named after Russian mathematician Pafnuty Lvovich Chebyshev (1821–1894). Incidentally, there are many ways of spelling (transliterating from Russian) the name Chebyshev, so do not be surprised if you see it spelt differently!

Butterworth filters

The Butterworth filter provides the flattest possible pass band, but does not roll off as fast as other types, such as Chebyshev filters. Gain in the stop band rolls off steadily towards zero (minus infinity in dB).

The time response to a pulse shows some ringing. The frequency response of a 1kHz third-order low-pass Butterworth filter is shown in Fig.3.

Bessel filters

Bessel filters have a soft cut-off, but have a delay which varies very little across the pass band. This means that waveforms of in-band signals suffer little distortion passing through the filter. The Butterworth filter gain in the stop band rolls off steadily towards zero (minus infinity in dB). The frequency response of a 1kHz third-order low pass Bessel filter is shown in Fig.4.

The flat gain (linear phase) response is important in some applications, such as high quality audio. In the time domain, pulses applied to a Bessel filter show very little overshoot and ringing. In cases where low signal distortion is needed, using a higher order (more components and complexity) Bessel filter to get the required cut-off sharpness may be preferable to a simpler Butterworth filter.

Chebyshev filters

Chebyshev filters have relatively steep roll-off at the cut-off frequency in comparison with Butterworth and Bessel filters. The gain of type-I Chebyshev filters varies in the pass band, and they are often referred to in terms of the magnitude of

this ripple. Increasing the magnitude of the ripple makes the cut-off sharper. Chebyshev filters show more ringing in response to input pulses than Butterworth and Bessel filters.

The gain of the less common type-II Chebyshev filters is flat in the pass band, but has ripple in the stop band. These filters do not have as sharp a cut-off as type-I Chebyshev filters. When designing a type-II Chebyshev filter you need to know how much attenuation you need in the stop band as, unlike the other filters described here, the attenuation does not increase continuously as you move away from the cut-off frequency.

In Fig.5 is shown the response of a third-order 1.0kHz type-I Chebyshev filter with 3dB ripples, and Fig.6 shows a third-order 1.0kHz type-II Chebyshev filter designed to have a -30dB stop band attenuation.

The cut-off frequency for Butterworth and Bessel filters is -3dB below the gain depth in the pass band. This is the standard -3dB (half power) point often used to define bandwidth. However, for type-I Chebyshev filters the ripple amplitude is often used to define the cut-off frequency. So for a -1dB ripple with Chebyshev filters the cut-off would be 1dB below the maximum gain in the pass band. This is the definition used by Filter Free. Note that some filter design recipes or software may assume -3dB. Filter design software may let you redefine the cut-off point from whatever the default is. In Filter Free untick the Standard Pass Band Atten box if you need a non-standard definition of cut-off frequency.

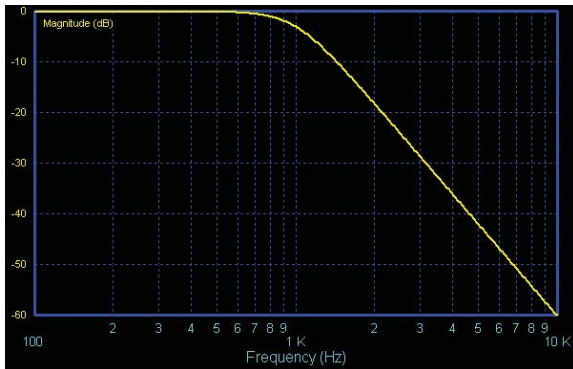

Fig.3. Butterworth third-order low-pass filter response (output from Filter Free)

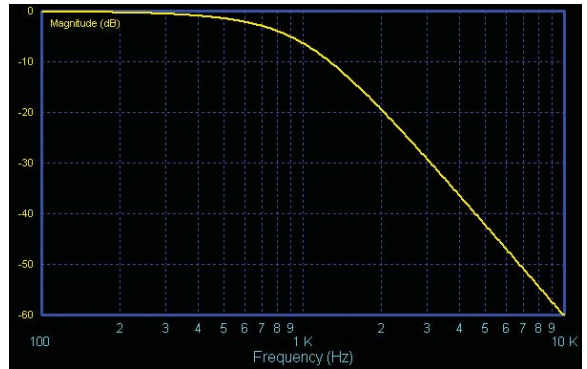

Fig.4. Bessel third-order low-pass filter response (output from Filter Free)

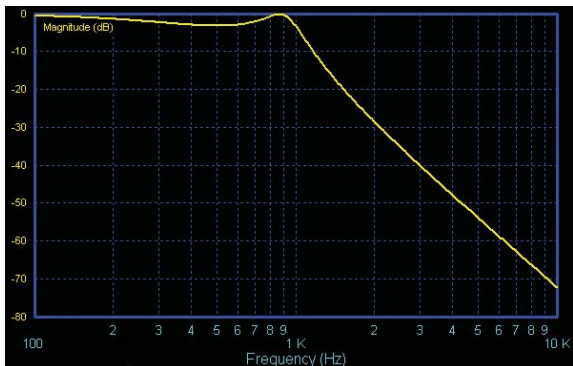

Fig.5. Type-I Chebyshev third-order low-pass filter response (output from Filter Free)

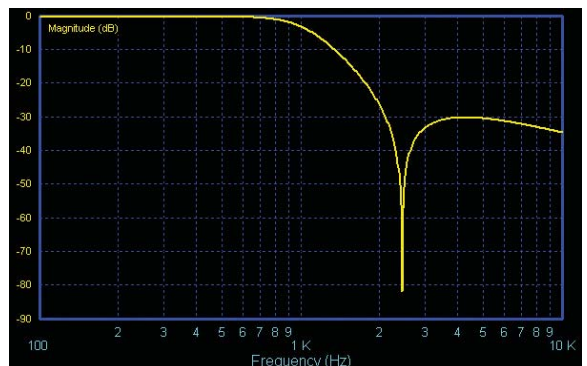

Fig.6. Type-II Chebyshev third-order low-pass filter response (output from Filter Free)

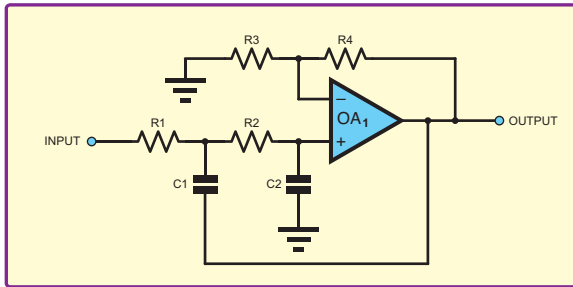

Fig.7. Second order Sallen and Key low-pass filter

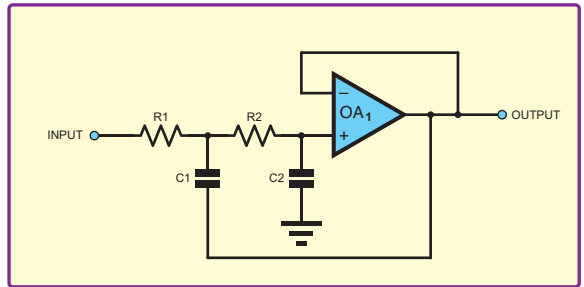

Fig.8. Second order Sallen and Key low-pass filter, unity gain version

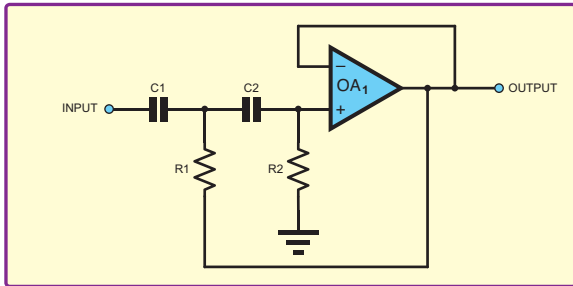

Fig.9. Second order Sallen and Key high-pass filter, unity gain version

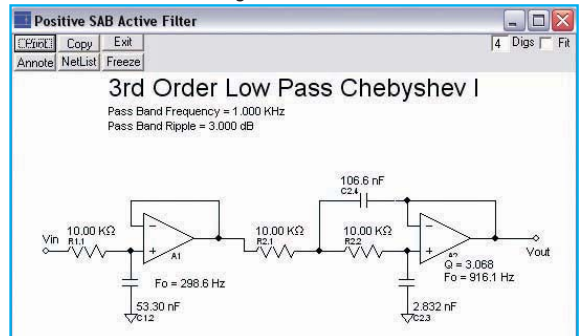

Fig.10. Filter synthesised by Filter Free. This has the frequency response shown in Fig.5

Other considerations

Another major filter design decision is which circuit is used to implement it. Filter Free provides up to nine filter implementation choices. The circuits vary in terms of the number of components they require, with the number of op amps and capacitors usually being of key concern.

Another important issue, particularly with higher order filters, is the sensitivity of the filter design to the components used. The quality of a real filter will never quite match the ideal filter described by the mathematics. Imperfections in the op amp will reduce the filter's performance and some filter circuits are more sensitive to op amp imperfections than others.

The filter synthesis process determines exact values for the resistors and capacitors in the circuit. In a real circuit we can never have these exact values because of the limitation to preferred values and component tolerances. Some filter circuits are very sensitive to component values so that only a small difference between the required value and the

implementation may take the filter out of specification. The type of filter also has an impact on sensitivity. For example Chebyshev filters are more sensitive to component variation than Butterworth filters.

In this article we restrict our discussion to the Pos SAB option, which is short for Positive Single Amplifier Biquadratic filters. The well-known Sallen and Key filter falls into this category. The basic schematic of a second-order low pass Sallen and Key filter is shown in Fig.7. Positive single amplifier biquad filters are more sensitive to component errors than op amp imperfections.

The circuit in Fig.8 is a form of the Sallen and Key circuit in which the amplifier gain is unity. The unity-gain Sallen-Key filter inherently has excellent gain accuracy because the gain is determined by the accuracy of a resistor ratio, as it is in Fig.7.

The high pass version of the Sallen and Key filter is very similar, with the resistors and capacitors swapped round as shown in Fig.9.

For third-order filters an op amp-buffered RC filter is put in front of a second-order Sallen and Key stage. An example circuit of this type, as synthesised by Filter Free is shown in the screenshot in Fig.10. Note that the resistors in the circuit are 10kΩ. This value is determined by the R Constant value in the Circuit Parameters section of the Filter Free window. If the capacitor values in the synthesised circuit are excessively large or small, this resistance value should be changed.

For higher order filters multiple second-order stages are used, with the addition of a first order RC stage for odd-ordered filters. Synthesis of filters of higher than third-order is not available in the free version of the Nuhertz software, but may be available in other free filter synthesis software.

NEWSAGENTS ORDER FORM

Please reserve/deliver a copy of **Everyday Practical Electronics** for me each month

Title: _____ First Name: _____ Surname: _____

Address: _____

Postcode: _____ Tel: _____

Everyday Practical Electronics is published on the second Thursday of each month and distributed S.O.R. by SEYMOUR.

Make sure of your copy each month – cut out or photocopy this form, fill it in and hand it to your newsagent

EPSE EVERYDAY PRACTICAL ELECTRONICS

Laser  *Why tolerate when you can automate?*

X-10 Home Automation

KATS KATS AV transmission and IR control system

BARIX Barix Ethernet based MP3, communications and control systems

C-Bus Shop
C-Bus and C-Bus Wireless
www.cbus-shop.com

www.laser.com

Laser Business Systems Ltd
Tel: +44 (0) 20 8441 9788
Fax: +44 (0) 20 8449 0430
Email: info@laser.com
16 Garthland Drive, EN5 3BB

Integrators, Installers, Trade and Retail customers welcome

**TO ADVERTISE IN
EVERYDAY PRACTICAL
ELECTRONICS
PLEASE CONTACT
Stewart Kearn on
01202 873872
or email
stewart.kearn@wimborne.co.uk**

EPE BINDERS

**KEEP YOUR MAGAZINES SAFE
- RING US NOW!**



This ring binder uses a special system to allow the issues to be easily removed and re-inserted without any damage. A nylon strip slips over each issue and this passes over the four rings in the binder, thus holding the magazine in place. The binders are finished in hard-wearing royal blue PVC with the magazine logo in gold on the spine. They will keep your issues neat and tidy but allow you to remove them for use easily. The price is £7.95 plus £3.50 post and packing. If you order more than one binder add £1 postage for each binder after the initial £3.50 postage charge (overseas readers the postage is £6.00 each to everywhere except Australia and Papua New Guinea which costs £10.50 each). Send your payment in £'s sterling cheque or PO (Overseas readers send £ sterling bank draft, or cheque drawn on a UK bank or pay by card), to:

Everyday Practical Electronics, Wimborne Publishing Ltd, Sequoia House, 398a Ringwood Road, Ferndown, Dorset BH22 9AU.
Tel: 01202 873872. Fax: 01202 874562.
E-mail: editorial@epemag.wimborne.co.uk
Web site: <http://www.epemag.com>

We also accept card payments. Mastercard, Visa, or Maestro. Send your card number and card valid from and expiry date plus Maestro Issue No. and the security code on the back of the card with your order.



THE ORIGINAL SINCE 1994
PCB-POOL
Beta LAYOUT
Specialising in Prototype PCBs

NEW! Free Laser Stencil with all Prototype PCB orders

NEW! 1 WD prototype service

NEW! Chemical Tin Finish (no extra cost)

Free Phone
UK 0800 389 8560

@ Simply send your layout files and order ONLINE
PCB-POOL.COM • sales@pcb-pool.com



Beta LAYOUT

FLUX 2000 • Designline • EXAM • cadsoft • CleanTech • NATIONAL INSTRUMENTS • Easy-PC • PULSONIX

MAGENTA

ELECTRONICS LTD

MICROSTEPPER Stepping Motor Driver



KIT 920
£18.76

Special Offer - Kit 920 + MD23
200 Step motor **£31.91**

May 09 EPE. 1/2 1/4 1/8 and 1/16 microstep driver for standard 4 phase unipolar motors. Up to 46V at 3A.

Adjustable current with efficient PWM control. Opto isolated inputs and outputs for computer (LPT)# or logic level control. SLA7062M driver chip contains all sequencer logic - Only needs Step and Direction inputs. Kit includes PTH circuit board Chip, and all components. # Connection details and (Slow speed) demo PC software: free download from website.

20W Stereo Amp.



KIT 914
£11.90

Includes all parts & heatsink for stereo & mono

Low distortion 11W/channel Stereo/20W Mono. True (rms) Real Power. High Slew Rate/bandwidth & low noise. Ideal MP3 booster. Short Circuit & Overtemp. Protected. STA7360 chip. Needs 8 to 18V supply. EPE Project May2005.

All Prices Include VAT, Add £3.00 P&P per order, or £7.99 for next day. Chqs. P.O. & most major cards accepted. Mail Order Only.

135 Hunter Street Burton on Trent Staffs DE14 2ST
Tel: 01283 565435 Fax: 01283 546932
www.magenta2000.co.uk sales@magenta2000.co.uk

PIC n' Mix

Mike Hibbett

Our periodic column for PIC programming enlightenment

PIC RS232 terminal

For the last four months we have been looking at pushing the PIC24 processor to generate video, demonstrating how to use it to create a simple 1970s arcade game. Now we will look at bringing together everything we have covered in the last four months for a more useful purpose – creating a stand alone RS232 terminal based on just a PIC, keyboard and a television. This will make an ideal interface to other microprocessor circuits, and the author has already found it useful for debugging projects – the television set replacing a PC running Hypertextual to display debug information.

Software

The software for this article was developed in a couple of hours by progressing through a series of steps, creating working code at each step. To help make this process clear, the source code for each step is available for download from the Library area on the *EPE* website, on the usual *Pic n' Mix* page. The complete code for each step is stored in a zip file, which can be downloaded and extracted onto your PC.

The source code for the actual terminal application is stored in **video-term.zip**, which contains both the application and the two libraries. You do not need to download the other zip files containing the intermediate steps.

The first step is to glue together the video library with last month's keyboard library into a simple test application, and

to try running it on this month's circuit. As we designed the keyboard library with this application in mind, you will see from the circuit diagram in Fig.1 that it is a simple merging of the two previous circuits with the addition of an RS232 interface.

We modified the **videotest.c** source file from the video library, removing the bulk of the 'main' routine and modifying it to simply read a character from the keyboard and echo it to the display. Refer to Fig.2 for the complete application source code listing, and you can find the complete source files on the *EPE* website in file **video-a.zip**.

This code worked first time, but as expected, there were occasional 'flashes' on the display while typing as a result of the keyboard interrupt blocking the time-critical video interrupt from redrawing the display. The timing of the video routine is critical, and any delay results in the video timings being wrong for a fraction of a second – but long enough for us to notice. Solving this requires an understanding of how interrupts are handled, so let's take a look at this now.

Interrupts

Interrupts are a means by which an external device or on-board hardware peripheral can signal to the processor that it would like immediate attention – through the CPU pausing what it is doing and jumping off to a special interrupt routine designed to handle that specific event. The interrupt routine is stored (by you, or your C compiler)

at a predefined location in memory. Before jumping to the interrupt routine, the CPU will store vital information about the state of the processor prior to the interrupt.

The interrupt routine must, however, save any processor registers and restore them to their original state on exit. When the routine does exit, the processor restores the state of the CPU to exactly how it was, and your software continues operation oblivious to the fact that it was interrupted – except for the time that has passed.

The fun starts when two interrupts occur at exactly the same time or an interrupt occurs while the processor is already handling another interrupt, an event which is not as unusual as you might think. The processor has to choose one of these interrupts to execute first, and it does this using *Interrupt Priority*, a simple scheme of assigning an order of preference to potential interrupt sources. If an interrupt routine is currently running, and another lower priority interrupt occurs, that new interrupt will not be serviced until the current one completes.

Our video library uses the Timer2 interrupt; the keyboard library uses INT0.

INT0 is defined by the processor as having a higher default priority; therefore, it will occur first, and should a video timer interrupt occur the processor will wait until the keyboard interrupt completes before handling the new interrupt request. This is the wrong way round; our keyboard can wait a few milliseconds before being serviced by an interrupt; the video display most certainly cannot.

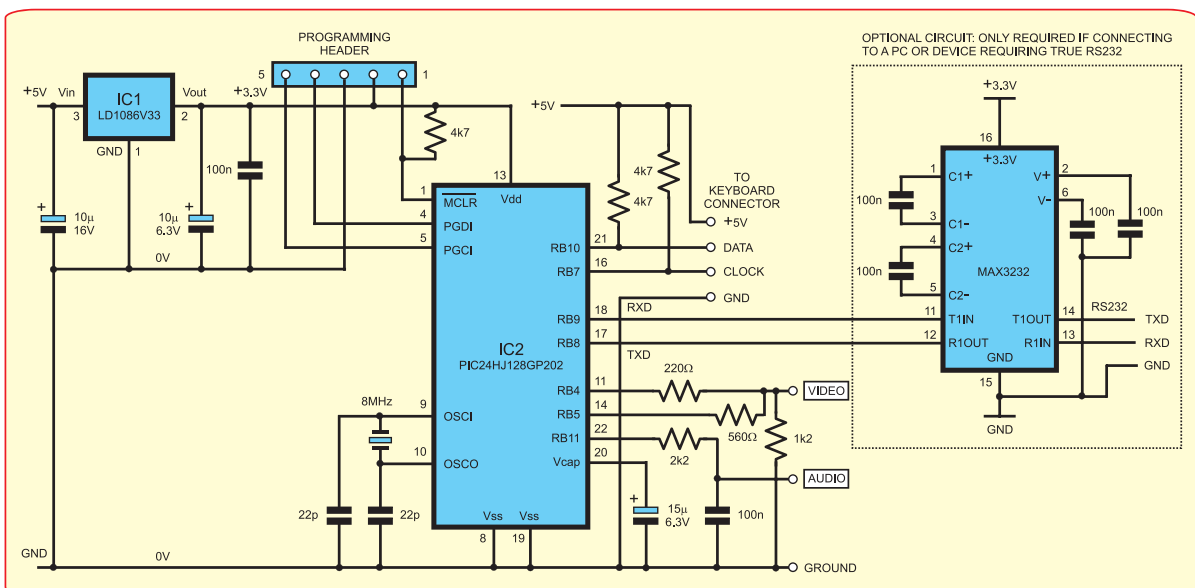

Fig. 1. Circuit diagram of the PIC-based terminal

```

int main(void)
{
    unsigned char lp;
    unsigned char keyval;
    unsigned int x = 0;
    unsigned int y = 0;

    // Set processor to run at appropriate speed
    CLKDIVbits.PLLPOST = 0;
    PLLFBDbits.PLLDIV = PLL_80MHZ;

    // Make digital pins I/O rather than analogue
    AD1PCFGL = 0xFFFF;

    PIC24VideoInit();
    PIC24ps2keyInit();

    do {
        keyval = PIC24pskeyGetKey();
        PIC24VideoPutChar(x, y, keyval);

        // Move to the next character space to the right
        x = x + 6;

        // Have we reached the far right edge of the TV?
        if ( x > (VID_WIDTH_PIXELS - 6) ) {
            // Move to the start of the next 'line'
            x = 0;
            y = y + 8;
        }
    } while (1);
    return 0; // Never reached
}

```

Fig.2. Source code – first try

Fortunately, we can assign different interrupt priorities. By default, all interrupts are set to a priority of four; we can raise the Timer2 interrupt to a higher level with a simple line of source code:

```
IPC1bits.T2IP = 7;
```

Adding this line of code immediately after the initialisation of the two libraries raises the priority of the video interrupt to maximum, and results in a perfect display while typing on the keyboard. Simple once you know how!

Serial

Now to glue in the next piece of hardware – the serial interface. We would like characters coming from the keyboard to go straight out over the serial interface, and any characters being received from the serial port to be displayed on the screen. We will use the serial port routines built into the Microchip C compiler rather than craft our own, and the code is so simple it does not warrant its own 'library' – we just include the code within the `videotest.c` source file.

The first task is to initialise the serial port to 9600 baud, which is done through a call to `OpenUART1()`. (The serial port routines built into the C compiler are documented in the PIC24F UART Library Help File.htm help file located in the `Microchip\MPLAB C30\docs\periph_lib` directory; rather difficult to find unless you know where to look).

Having initialised the serial port, handling the keyboard data is a simple case of calling `putcUART1()` for each character returned from the keyboard followed by a call to `while (BusyUART1());` to ensure that the character has been sent before we try sending another character.

Handling received characters is not so simple. Our keyboard routine `PIC24ps2keyGetKey()` blocks waiting for a key to be pressed, and so our main loop cannot also look to the serial receive buffer to see if data is coming in. We will have to handle this somewhere else.

```

void __attribute__((interrupt)) _U1RXInterrupt(void)
{
    unsigned int rxByte;
    IFS0bits.U1RXIF = 0;

    while( dataRdyUART1() ) {
        rxbyte = ReadUART1();

        if ( (rxByte > 0) && (rxByte < 0x7F) ) {
            PIC24VideoPutChar(xcurs, ycurs, rxByte);
            xcurs = xcurs + 6;

            if ( xcurs > (VID_WIDTH_PIXELS - 6) ) {
                xcurs = 0;
                ycurs = ycurs + 8;
            }
        }
    }
}

```

Fig.3. Source code – serial interrupt

That 'somewhere else' is, of course, in the serial port receive interrupt routine. (You may now be beginning to appreciate interrupt routines. Although a little tricky to write, they solve difficult programming problems.) Microchip's

serial port help file comes to the rescue, explaining how to write a receive interrupt routine. You simply create a function whose name looks like this:

```
void __attribute__((interrupt))
_U1RXInterrupt(void)
```

Don't worry about the lengthy name, it is designed to allow the C compiler to recognise that it needs to turn this into the serial port receive interrupt routine and place it at the correct position in memory. The compiler takes care of all the register preservation and restoring; we can write C code and ignore the other complexities. All we have to do is clear the corresponding interrupt flag (to tell the processor we have responded to the interrupt), read the character from the serial port and write it into the display buffer. The complete code for the interrupt routine is shown in Fig.3.

Terminal application

So we have solved the problem of integrating the keyboard and video libraries together, and how to interface over an RS232 serial port. Now we need to bind the three parts together into a terminal application. So what is it exactly that we want it to do? Here is a useful set of requirements that we might consider:

- As characters are received from the serial port, display them from top-left working towards bottom right
- When the printing reaches the bottom of the display, scroll the screen up a line
- Interpret line feed, carriage return, backspace and form feed characters
- Run at 9600 baud, no parity, one stop bit, one start bit (but be easy to change)

That should be simple enough to implement. As you might have guessed, requiring that the screen display scrolls upwards when the printing reaches the end of the screen means that we need to buffer the incoming data into a RAM buffer, arranged

as an array of 34 by 30 characters – almost 1KB of RAM. We have enough space in the processor to store that, and writing into this buffer is not going to be time critical.

These requirements are easily met through a small change to just the serial receiver interrupt routine. Rather than calling `PIC24VideoPutChar()`, we call a new function `storeRxChar()` and allow that routine to copy the received character into the RAM buffer, and then transfer the entire RAM buffer to the video display buffer. `storeRxChar()` can deal with scrolling by simply shifting up the characters stored in the RAM buffer, and then adding the new character to the end of the buffer before writing the entire contents out to the video buffer.

Scrolling is quite time consuming, but the video interrupt can jump in at any time, so the effects should not be visible. The completed code can be found in the file `video-term.zip`.

Taking it further

The key feature of this kind of system is that it gives you a *big* display – you will want to give up on the 2x16 LCD module once you have tried this out!

One possible application would be to hook up to a mobile phone to give you a big display for sending and receiving SMS messages, without the cost and power consumption of a PC.

As a PS/2 mouse follows exactly the same interface as a keyboard there is no reason why you could not add a second PS/2 socket and handle a mouse as well as a keyboard, creating an almost 'PC' like experience – albeit in text only!

Probably the most interesting application is to couple this with the Ethernet interface covered in earlier *PIC n' Mix* articles. With just three low power ICs (PIC18F processor, ENC28J60 Ethernet interface, PIC24H processor), one could create a simple 'thin web client' that could access the Internet. While the features would be limited, you could easily satisfy email and instant messaging requirements for a fraction of the cost of a PC – and more importantly, for a fraction of the power consumption.

PLEASE TAKE NOTE

July '09 – page 61, Fig 3. The PIC processor should be a type PIC24HJ128GP202 and annotated IC2, not as shown. Also note, that pin 1 from the 'prog. header' should go to pin 1 of the micro (IC2) – joining up with the pull-up resistor.

EPE IS PLEASED TO BE ABLE TO OFFER YOU THESE ELECTRONICS CD-ROMS

ELECTRONICS PROJECTS

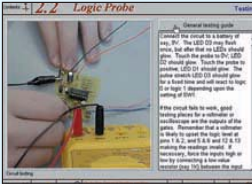

Logic Probe testing

Electronic Projects is split into two main sections: **Building Electronic Projects** contains comprehensive information about the components, tools and techniques used in developing projects from initial concept through to final circuit board production. Extensive use is made of video presentations showing soldering and construction techniques. The second section contains a set of ten projects for students to build, ranging from simple sensor circuits through to power amplifiers. A shareware version of Matrix's CADPACK schematic capture, circuit simulation and p.c.b. design software is included.

The projects on the CD-ROM are: Logic Probe; Light, Heat and Moisture Sensor; NE555 Timer; Egg Timer; Dice Machine; Bike Alarm; Stereo Mixer; Power Amplifier; Sound Activated Switch; Reaction Tester. Full parts lists, schematics and p.c.b. layouts are included on the CD-ROM.

ELECTRONIC CIRCUITS & COMPONENTS V2.0

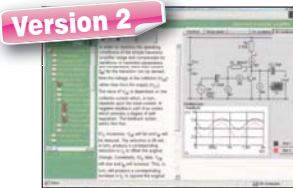

Circuit simulation screen

Electronic Circuits & Components V2.0 provides an introduction to the principles and application of the most common types of electronic components and shows how they are used to form complete circuits. The virtual laboratories, worked examples and pre-designed circuits allow students to learn, experiment and check their understanding. Version 2 has been considerably expanded in almost every area following a review of major syllabuses (GCSE, GNVQ, A level and HNC). It also contains both European and American circuit symbols. Sections include: **Fundamentals**: units and multiples, electricity, electric circuits, alternating circuits. **Passive Components**: resistors, capacitors, inductors, transformers. **Semiconductors**: diodes, transistors, op amps, logic gates. **Passive Circuits. Active Circuits. The Parts Gallery** will help students to recognise common electronic components and their corresponding symbols in circuit diagrams.

Included in the Institutional Versions are multiple choice questions, exam style questions, fault finding virtual laboratories and investigations/worksheets.

ANALOGUE ELECTRONICS

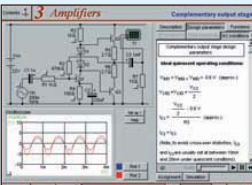

Complimentary output stage

Analogue Electronics is a complete learning resource for this most difficult branch of electronics. The CD-ROM includes a host of virtual laboratories, animations, diagrams, photographs and text as well as a SPICE electronic circuit simulator with over 50 pre-designed circuits.

Sections on the CD-ROM include: **Fundamentals** – Analogue Signals (5 sections), Transistors (4 sections), Waveshaping Circuits (6 sections). **Op Amps** – 17 sections covering everything from Symbols and Signal Connections to Differentiators. **Amplifiers** – Single Stage Amplifiers (8 sections), Multi-stage Amplifiers (3 sections). **Filters** – Passive Filters (10 sections), Phase Shifting Networks (4 sections), Active Filters (6 sections). **Oscillators** – 6 sections from Positive Feedback to Crystal Oscillators. **Systems** – 12 sections from Audio Pre-Amplifiers to 8-Bit ADC plus a gallery showing representative p.c.b. photos.

DIGITAL ELECTRONICS V2.0

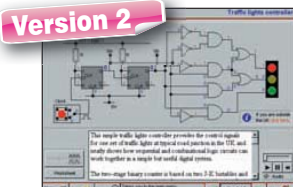

Virtual laboratory - Traffic Lights

Digital Electronics builds on the knowledge of logic gates covered in *Electronic Circuits & Components* (above), and takes users through the subject of digital electronics up to the operation and architecture of microprocessors. The virtual laboratories allow users to operate many circuits on screen.

Covers binary and hexadecimal numbering systems, ASCII, basic logic gates, monostable action and bistables – including JK and D-type flip-flops. Multiple gate circuits, equivalent logic functions and specialised logic functions. Introduces sequential logic including clocks and clock circuitry, counters, binary coded decimal and shift registers. A/D and D/A converters, traffic light controllers, memories and microprocessors – architecture, bus systems and their arithmetic logic units. Sections on Boolean Logic and Venn diagrams, displays and chip types have been expanded in Version 2 and new sections include shift registers, digital fault finding, programmable logic controllers, and microcontrollers and microprocessors. The Institutional versions now also include several types of assessment for supervisors, including worksheets, multiple choice tests, fault finding exercises and examination questions.

ANALOGUE FILTERS



Filter synthesis

Analogue Filters is a complete course in designing active and passive filters that makes use of highly interactive virtual laboratories and simulations to explain how filters are designed. It is split into five chapters: **Revision** which provides underpinning knowledge required for those who need to design filters. **Filter Basics** which is a course in terminology and filter characterization, important classes of filter, filter order, filter impedance and impedance matching, and effects of different filter types. **Advanced Theory** which covers the use of filter tables, mathematics behind filter design, and an explanation of the design of active filters. **Passive Filter Design** which includes an expert system and filter synthesis tool for the design of low-pass, high-pass, band-pass, and band-stop Bessel, Butterworth and Chebyshev ladder filters. **Active Filter Design** which includes an expert system and filter synthesis tool for the design of low-pass, high-pass, band-pass, and band-stop Bessel, Butterworth and Chebyshev op.amp filters.



ROBOTICS & MECHATRONICS



Case study of the Milford Instruments Spider

Robotics and Mechatronics is designed to enable hobbyists/students with little previous experience of electronics to design and build electromechanical systems. The CD-ROM deals with all aspects of robotics from the control systems used, the transducers available, motors/actuators and the circuits to drive them. Case study material (including the NASA Mars Rover, the Milford Spider and the Furby) is used to show how practical robotic systems are designed. The result is a highly stimulating resource that will make learning, and building robotics and mechatronic systems easier. The Institutional versions have additional worksheets and multiple choice questions.

- Interactive Virtual Laboratories
- Little previous knowledge required
- Mathematics is kept to a minimum and all calculations are explained
- Clear circuit simulations

PRICES

Prices for each of the CD-ROMs above are:
(Order form on third page)

Hobbyist/Student	£44	inc VAT
Institutional (Schools/HE/FE/Industry)	£99	plus VAT
Institutional 10 user (Network Licence)	£249	plus VAT
Site licence	£499	plus VAT

(UK and EU customers add VAT at 15% to 'plus VAT' prices)

PICmicro TUTORIALS AND PROGRAMMING

HARDWARE

VERSION 3 PICmicro MCU development board

Suitable for use with the three software packages listed below.

This flexible development board allows students to learn both how to program PICmicro microcontrollers as well as program a range of 8, 18, 28 and 40-pin devices from the 12, 16 and 18 series PICmicro ranges. For experienced programmers all programming software is included in the PPP utility that comes with the development board. For those who want to learn, choose one or all of the packages below to use with the Development Board.

- Makes it easier to develop PICmicro projects
- Supports low cost Flash-programmable PICmicro devices
- Fully featured integrated displays – 16 individual I.e.d.s, quad 7-segment display and alphanumeric I.c.d. display
- Supports PICmicro microcontrollers with A/D converters
- Fully protected expansion bus for project work
- USB programmable
- Can be powered by USB (no power supply required)

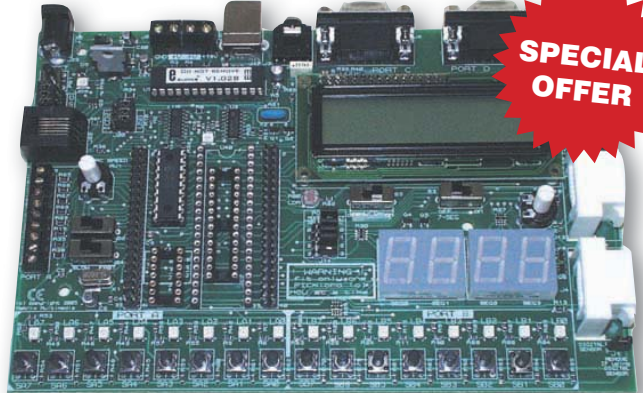

£155 including VAT and postage, supplied with USB cable and programming software

£40 OFF Buy the Development Board together with any Hobbyist/Student or Institutional versions of the software CD-ROMs listed below and take £40 off the total (including VAT) price.

SOFTWARE

ASSEMBLY FOR PICmicro V3

(Formerly PICTutor)

Assembly for PICmicro microcontrollers V3.0 (previously known as PICTutor) by John Becker contains a complete course in programming the PIC16F84 PICmicro microcontroller from Arizona Microchip. It starts with fundamental concepts and extends up to complex programs including watchdog timers, interrupts and sleep modes.

The CD makes use of the latest simulation techniques which provide a superb tool for learning: the Virtual PICmicro micro-controller. This is a simulation tool that allows users to write and execute MPASM assembler code for the PIC16F84 microcontroller on-screen. Using this you can actually see what happens inside the PICmicro MCU as each instruction is executed which enhances understanding.

- Comprehensive instruction through 45 tutorial sections
- Includes Vlab, a Virtual PICmicro microcontroller: a fully functioning simulator
- Tests, exercises and projects covering a wide range of PICmicro MCU applications
- Includes MPLAB assembler
- Visual representation of a PICmicro showing architecture and functions
- Expert system for code entry helps first time users
- Shows data flow and fetch execute cycle and has challenges (washing machine, lift, crossroads etc.)
- Imports MPASM files.

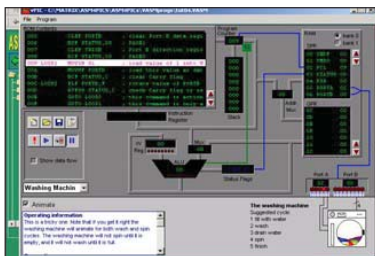

'C' FOR 16 Series PICmicro Version 4

The C for PICmicro microcontrollers CD-ROM is designed for students and professionals who need to learn how to program embedded microcontrollers in C. The CD contains a course as well as all the software tools needed to create Hex code for a wide range of PICmicro devices – including a full C compiler for a wide range of PICmicro devices.

Although the course focuses on the use of the PICmicro microcontrollers, this CD-ROM will provide a good grounding in C programming for any microcontroller.

- Complete course in C as well as C programming for PICmicro microcontrollers
- Highly interactive course
- Virtual C PICmicro improves understanding
- Includes a C compiler for a wide range of PICmicro devices
- Includes full Integrated Development Environment
- Includes MPLAB software
- Compatible with most PICmicro programmers
- Includes a compiler for all the PICmicro devices.

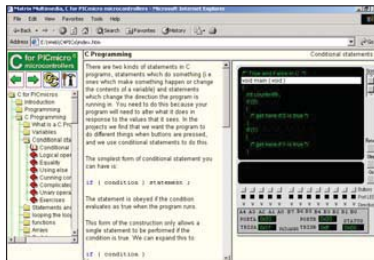

Minimum system requirements for these items: Pentium PC running Windows 98, NT, 2000, ME, XP; CD-ROM drive; 64MB RAM; 10MB hard disk space. Flowcode will run on XP or later operating systems

FLOWCODE FOR PICmicro V3

Flowcode is a very high level language programming system for PICmicro microcontrollers based on flowcharts. Flowcode allows you to design and simulate complex systems in a matter of minutes. A Powerful language that uses macros to facilitate the control of devices like 7-segment displays, motor controllers and I.c.d.s. The use of macros allows you to control these devices without getting bogged down in understanding the programming.

Flowcode produces MPASM code which is compatible with virtually all PICmicro programmers. When used in conjunction with the Version 3 development board this provides a seamless solution that allows you to program chips in minutes.

- Requires no programming experience
- Allows complex PICmicro applications to be designed quickly
- Uses international standard flow chart symbols
- Full on-screen simulation allows debugging and speeds up the development process.

- Facilitates learning via a full suite of demonstration tutorials
- Produces ASM code for a range of 18, 28 and 40-pin devices
- New features in Version 3 include 16-bit arithmetic, strings and string manipulation, improved graphical user interface and printing, support for 18 series devices, pulse width modulation, I2C, new ADC component etc. The Hobbyist/Student version is limited to 4K of code (8K on 18F devices)

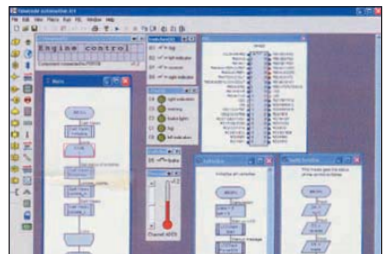

PRICES

Prices for each of the CD-ROMs above are:
(Order form on next page)

Hobbyist/Student	£44	inc VAT
Institutional (Schools/HE/FE/Industry)	£99	plus VAT
Institutional/Professional 10 user (Network Licence)	£300	plus VAT
Site licence	£599	plus VAT
Flowcode 10 user (Network Licence)	£350	plus VAT
Flowcode 50 user (Network Licence)	£699	plus VAT

(UK and EU customers add VAT at 15% to 'plus VAT' prices)

SPECIAL PACKAGE OFFER

TINA Pro V7 (Basic) + Flowcode V3 (Hobbyist/Student)

TINA Analogue, Digital, Symbolic, RF, MCU and Mixed-Mode Circuit Simulation, Testing and PCB Design

TINA Design Suite is a powerful yet affordable software package for analysing, designing and real time testing analogue, digital, MCU, and mixed electronic circuits and their PCB layouts. You can also analyse RF, communication, optoelectronic circuits, test and debug microcontroller applications.

Enter any circuit (up to 100 nodes) within minutes with TINA's easy-to-use schematic editor. Enhance your schematics by adding text and graphics. Choose components from the large library containing more than 10,000 manufacturer models. Analyse your circuit through more than 20 different analysis modes or with 10 high tech virtual instruments. Present your results in TINA's sophisticated diagram windows, on virtual instruments, or in the live interactive mode where you can even edit your circuit during operation.

Customise presentations using TINA's advanced drawing tools to control text, fonts, axes, line width, colour and layout. You can create, and print documents directly inside TINA or cut and paste your results into your favourite word-processing or DTP package.

TINA includes the following Virtual Instruments: Oscilloscope, Function Generator, Multimeter, Signal Analyser/Bode Plotter, Network Analyser, Spectrum Analyser, Logic Analyser, Digital Signal Generator, XY Recorder.

Flowcode V3 (Hobbyist/Student) – For details on Flowcode, see the previous page.

This offer gives you two separate CD-ROMs in DVD style cases – the software will need registering (FREE) with Designsoft (TINA) and Matrix Multimedia (Flowcode), details are given within the packages.

Get TINA + Flowcode for a total of just £50, including VAT and postage.

**£50.00
inc. VAT
and p&p**

DIGITAL WORKS 3.0

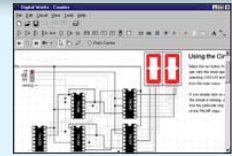

Counter project

Digital Works Version 3.0 is a graphical design tool that enables you to construct digital logic circuits and analyze their behaviour. It is so powerful that you will take you less than 10 minutes to make your first digital design. It is so powerful that you will never outgrow its capability ● Software for simulating digital logic circuits ● Create your own macros – highly scalable ● Create your own circuits, components, and i.c.s ● Easy-to-use digital interface ● Animation brings circuits to life ● Vast library of logic macros and 74 series i.c.s with data sheets ● Powerful tool for designing and learning.

**Hobbyist/Student £44 inc. VAT.
Institutional £99 plus VAT.
Institutional 10 user £249 plus VAT.
Site Licence £599 plus VAT.**

ELECTRONIC COMPONENTS PHOTOS

A high quality selection of over 200 jpg images of electronic components. This selection of high resolution photos can be used to enhance projects and presentations or to help with training and educational material. They are royalty free for use in commercial or personal printed projects, and can also be used royalty free in books, catalogues, magazine articles as well as worldwide web pages (subject to restrictions – see licence for full details). Now contains Irfan View image software for Windows, with quick-start notes included.

Price **£19.95** inc. VAT

PROJECT DESIGN WITH CROCODILE TECHNOLOGY An Interactive Guide to Circuit Design

An interactive CD-ROM to guide you through the process of circuit design. Choose from an extensive range of input, process and output modules, including CMOS Logic, Op-Amps, PIC/PICAXE, Remote Control Modules (IR and Radio), Transistors, Thyristors, Relays and much more. Click Data for a complete guide to the pin layouts of i.c.s, transistors etc. Click More Information for detailed background information with many animated diagrams. Nearly all the circuits can be instantly simulated in Crocodile Technology* (not included on the CD-ROM) and you can customise the designs as required.

WHAT'S INCLUDED

Light Modules, Temperature Modules, Sound Modules, Moisture Modules, Switch Modules, Astables including 555, Remote Control (IR & Radio), Transistor Amplifiers, Thyristor, Relay, Op-Amp Modules, Logic Modules, 555 Timer, PIC/PICAXE, Output Devices, Transistor Drivers, Relay Motor Direction & Speed Control, 7 Segment Displays. Data sections with pinouts etc., Example Projects, Full Search Facility, Further Background Information and Animated Diagrams.

Runs in Microsoft Internet Explorer

*All circuits can be viewed, but can only be simulated if your computer has Crocodile Technology version 410 or later. A free trial version of Crocodile Technology can be downloaded from: www.crocodile-clips.com. Animated diagrams run without Crocodile Technology.

Single User £39.00 inc. VAT.

Multiple Educational Users (under 500 students) £59.00 plus VAT. Over 500 students £79.00 plus VAT.
(UK and EU customers add VAT at 15% to "plus VAT" prices)

**Over 150 pages
Over 600 images**



Minimum system requirements for these CD-ROMs: Pentium PC, CD-ROM drive, 32MB RAM, 10MB hard disk space. Windows 95/98/NT/2000/ME/XP, mouse, sound card, web browser.

Please send me: CD-ROM ORDER FORM



- Electronic Projects
- Electronic Circuits & Components V2.0
- Analogue Electronics
- Digital Electronics V2.0
- Analogue Filters
- Electronics CAD Pack
- Robotics & Mechatronics
- Assembly for PICmicro V3
- 'C' for 16 Series PICmicro V4
- Flowcode V3 for PICmicro
- Digital Works 3.0

Version required:

- Hobbyist/Student
- Institutional
- Institutional/Professional 10 user
- Site licence

- PICmicro Development Board V3 (hardware)

- TINA Pro V7 Basic + Flowcode V3 Hobbyist/Student
- Electronic Components Photos; Version 1.1
- Project Design – Single User
- Project Design – Multiple User (under 500 students)
- Project Design – Multiple User (over 500 students)

Note: The software on each version is the same, only the licence for use varies.

Full name:

Address:

..... Post code: Tel. No:

Signature:

I enclose cheque/PO in £ sterling payable to WIMBORNE PUBLISHING LTD for £

Please charge my Visa/Mastercard/Maestro: £

Valid From: Card expiry date:

Card No: Maestro Issue No.

Card Security Code (The last 3 digits on or just under the signature strip)

ORDERING ALL PRICES INCLUDE UK POSTAGE

Student/Single User/Standard Version price includes postage to most countries in the world EU residents outside the UK add £5 for airmail postage per order

Institutional, Multiple User and Deluxe Versions – overseas readers add £5 to the basic price of each order for airmail postage (do not add VAT unless you live in an EU (European Union) country, then add 15% VAT or provide your official VAT registration number).

Send your order to:
**Direct Book Service
Wimborne Publishing Ltd
Sequoia House, 398a Ringwood Road
Ferndown, Dorset BH22 9AU**

To order by phone ring
01202 873872. Fax: 01202 874562

Goods are normally sent within seven days

E-mail: orders@wimborne.co.uk

Online shop:
www.epemag.com



READOUT

Email: editorial@wimborne.co.uk
Matt Pulzer addresses some of the general points readers have raised. Have you anything interesting to say? Drop us a line!



WIN AN ATLAS LCR ANALYSER WORTH £79
An Atlas LCR Passive Component Analyser, kindly donated by Peak Electronic Design Ltd, will be awarded to the author of the Letter Of The Month. The Atlas LCR automatically measures inductance from 1mH to 10H, capacitance from 1pF to 10,000nF and resistance from 1Ω to 2MΩ with a basic accuracy of 1%. www.peakelec.co.uk

All letters quoted here have previously been replied to directly

Chat Zone issues

Dear EPE

Two points: first, I tried to post a message to Alan Winstanley via the *Chat Zone*, but couldn't start a thread in the 'report a problem section', or reply to his notice there – hence this email.

Second, be aware that the *EPE* site is blacklisted by the content-monitoring software used by my local public library (and presumably by other libraries and educational establishments). The reason is the presence of 'ChatZone' (indiscriminately deemed unsuitable for children).

It's a shame that such a valuable educational resource as *EPE* is denied to children and others, as more recruits (particularly younger ones) to the hobby of electronics should be encouraged. Perhaps a change of name for *Chat Zone* would get round this blacklisting... or maybe not if the nanny software checks for site script behaviour, rather than just keywords such as 'chat'. Any thoughts?

Geoff (aka Alec_t), by email

Many thanks for your email Geoff. I am aware of the problem sometimes encountered with over-zealous public-access Internet terminals screening out our forum. Unfortunately, I can't see a suitable work-around. The software is deeply entrenched on the server under chatzones.co.uk and we can't migrate the forum to another domain name.

It might be worth trying to access it via www.epemag.com and use the *Chat Zone* link across the top to launch the forum in a 'frame', assuming the public access terminal will allow that. There is also a direct link at the bottom right of the *EPE* home page.

I did try to reproduce the issue with the 'report a problem' section – I logged in and posted a test message (previewed it anyway) so I'm currently a bit stuck on that.

Thank you for your interest, Alan Winstanley

Let there be light (measurement)

Dear EPE

I know nothing about electronics and just looking through your magazine makes me feel that to attempt it would be beyond my OAP capabilities. However, I can solder wires and this is about as far as I go when repairing old camera equipment such as exposure meters.

★ LETTER OF THE MONTH ★

Recycle It!

Dear EPE

Recycle It! – I love this part of *EPE*. Since you request readers to tell you about this type of project... here is one from me.

I had an old PC-CD player that stopped working. So, I took out the frame that contained the motor and gearbox which operates the tray. I glued two pieces of plastic to the last gear,

joined them at the end and glued a third piece of plastic to the end. I mounted this contraption on a wooden 'bridge' that sits on my etching tank. Last, I connected the system to a 5V power supply and *voila*, an unattended flow control for the etching fluid.

Harm, Netherlands, by email

Well done Harm – an excellent example of ingenious recycling. We'd love to hear about other readers' ideas.

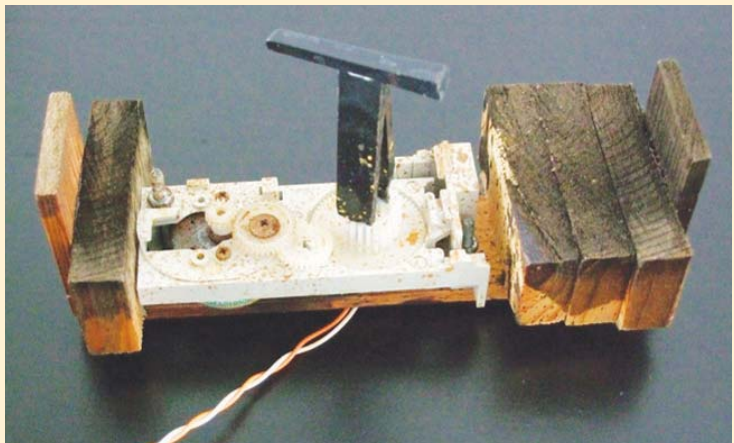

The problem is, old meters have electronic components that are difficult, if not impossible to source. In my younger days, just about every high street had a shop selling resistors, valves, and other bits and pieces. Component cannibalism means that you have to junk one device to restore another, and that is a pity, especially if the original has been superbly made.

At present, I am trying to restore a Gossen exposure meter in which the CdS light receptor resistor has died. However, I am having a time of it trying to find a replacement. Where do I start looking?

Terry Buchanan, by email

Terry – age is no barrier to (or excuse for avoiding!) electronics. I am quite sure that if you've mastered a technically demanding skill such as photography, and are able to solder, then with a bit of persistence electronics should not be a problem. Yes, it can appear intimidating at first, but there are plenty of good books and courses for novices. Wimborne Publishing produces quite a range of respected, tried and tested, and practical educational material – why not call the office to discuss your needs: 01202 873872, or see the book and CD-ROM pages in this issue.

As for sourcing CdS cells – do any readers have any tips?

Net Work

Alan Winstanley



The more things change...

More than a decade after the Melissa worm wriggled its way into the news headlines, unwanted spam continues to plague the inboxes of every email user. Melissa, old hands might remember, unleashed fear and havoc in its time; it was a self-propagating Word 97 macro that emailed itself to the first 50 Outlook addresses on an infected machine before promptly re-mailing itself out again. Unlike viruses, strictly speaking 'worms' do not damage file systems *per se*, they simply reproduce until the system grinds to a halt. Melissa was initially propagated by a single posting onto Usenet (newsgroups) through a compromised AOL account, before going on to choke mail servers everywhere. Melissa's creator, David Smith, was initially sentenced to 10 years in prison in recognition of his creativity.

Today, our Internet world is more fraught and dangerous than ever, with users facing constant threats from viruses, phishing attacks, dangerous websites that plant security-compromising files on your computer, identity theft, keystroke loggers and plain old-fashioned fraud. The need for constant vigilance coupled with the sheer volume of unwanted 'noise' has damaged the potential usability of the Internet enormously.

The professional antispam filtering service MessageLabs (www.messagelabs.co.uk), now owned by Symantec, reported in a monthly Intelligence bulletin that spam had reached a 19 month high, with a worrying (and annoying) return of 'image spam' – emailing a JPEG or GIF spam advert, typically for Viagra or pharmacy meds, in the body of a spam email. As antispam software cannot readily scan an inline image, the message often slips through undetected. In April 2009, MessageLabs reported that spam afflicted nearly 86% of all messages it scanned, with one in 305 containing a virus and one in 400 being a phishing scam, says the spam filtering firm. My ClearMyMail control panel states that 91% of my inbound email has been spam, and I notice clear 'spikes' in spam on some days.

My trusty old Eudora Email software does a fair job of shifting spam into its Junk folder, where the manic mutterings of various Nigerian fraudsters accumulate periodically. If nothing else, this Nigerian '419' fraud provides some light entertainment value: 419 spam seems to arrive in tidal waves, and one can imagine a whole gang of hopefuls feverishly dreaming up the most unlikely yarns in a Lagos Internet café.

A plateful of spam

In recognition of the creative skills of these people, my compliments go to Dr John Atkin, who seeks my help in transferring \$800,000 to a Swiss account. I must contact his secretary Dr Christopher Albert, who unfortunately quotes a Hong Kong Yahoo email account having a different name altogether. Not to be outdone, his buddy on the next café computer, Dr Ibrahim Abuya of the Benin Republic, has \$15 million to shift following the

death in a 'car crash' involving one of his customers. On the same day Mr Stanley Gunther Turner (British citizen) has a safety deposit box bursting with \$105 million and a Miss Hellen Kaloum, or is it Miss Nina Nijaro as it says in the body text, is sat on \$2.5 million somewhere in the Ivory Coast.

Good news! Western Union has \$700,000 heading for my email address and the money has come direct from the International Monetary Fund! The IMF states (it says here) that they choose to send it to me through Western Union instead of courier services because there are so many fake couriers around. I have also been awarded compensation by the United Nations, and I also welcome the efforts of one Dr Davis William to help me with an ATM card that has been charged up with \$1.5 million, but has only three days left before expiring. Mrs Steffany Clinton desires to transfer \$700,000 to me in \$5,000 tranches. A US soldier (Sgt Baker Johnson Jr, but with a Japanese Yahoo address) expressed a wish to smuggle \$10 million out of Iraq. As if I'm not rolling in dough already, a few minutes ago I won \$485,000 in a 'Yahoo MSN Live lottery'.

This lunacy continues unabated even as I write, but the biggest tragedy is that some otherwise rational and sensible people still fall for it. This 419 or 'Advance Fee Fraud' wreaks misery on its gullible and greedy victims and these highly adaptable perpetrators are supremely skilled in milking mercilessly those who are sucked in by these scams, by fleecing them with elaborate plots involving authentic-looking forged documents or demands for progress payments. I have even known an industrial acquaintance, who should have known better, almost fall for it: he was getting ready to phone the villain on a mobile number until I stopped him.

Most of us – especially *EPE Net Work* readers – know how to recognise these deceptive emails; don't we! The critical rule is that you should never engage with such people. They do not merely work from some Nigerian Internet café: in Europe, gangs of them operate typically out of London or Rotterdam and they are highly mobile.

It is quite possible that one's personal safety can be put at risk, yet victims really have arranged to meet at hotels to exchange suitcases full of 'cash'. A 22-year-old Canadian, John Rempel, really did divest himself, his friends and relatives of \$150,000 when chasing down a \$12 million 'inheritance', which included buying a 'magic cleansing liquid' that 'activated' piles of paper money.

Ten years after fighting off Melissa, we face ever more insidious threats to our personal accounts, identity and safety. The rule remains that if something sounds too good to be true then it invariably is. However, by being vigilant and following your honest instincts, and maintaining antivirus software as up to date as possible, you can avoid falling into the clutches of these villains. The Internet has myriad uses, but you must tread carefully.

Don't forget to check our website at www.epemag.com, and you can email me at alan@epemag.demon.co.uk



The MessageLabs website offers an insight into prevailing virus and spam trends

DIRECT BOOK SERVICE

Electronics Teach-In + FREE CD-ROM

Mike Tooley

A broad-based introduction to electronics – find out how circuits work and what goes on inside them. Plus 15 easy-to-build projects. The 152 page A4 book comes with a free CD-ROM containing the whole Teach-In 2006 series (originally published in EPE) in PDF form, interactive quizzes to test your knowledge, TINA circuit simulation software (a limited version – plus a specially written TINA Tutorial), together with simulations of the circuits in the Teach-In series, plus Flowcode (a limited version) a high level programming system for PIC microcontrollers based on flowcharts.

The Teach-In series covers everything from Electric Current through to Microprocessors and Microcontrollers and each part includes demonstration circuits to build on breadboards or to simulate on your PC.

In addition to the Teach-In series, the book includes 15 CMOS-based simple projects from the Back-To-Basics series by Bart Trepak, these are: Fridge/Freezer Alarm, Water Level Detector, Burglar Alarm, Scarecrow, Digital Lock, Doorchime, Electronic Dice, Kitchen Timer, Room Thermometer, Daily Reminder, Whistle Switch, Parking Radar, Telephone Switch, Noughts and Crosses Enigma and a Weather Vane. There is also a MW/LW Radio project in the Teach-In series.

152 pages + CD-ROM **Order code ETI** £8.50



CIRCUITS AND DESIGN

A BEGINNER'S GUIDE TO TTL DIGITAL ICs

R. A. Penfold

This book first covers the basics of simple logic circuits in general, and then progresses to specific TTL logic integrated circuits. The devices covered include gates, oscillators, timers, flip/flops, dividers, and decoder circuits. Some practical circuits are used to illustrate the use of TTL devices in the "real world".

142 pages **Order code BP332** £5.45

PRACTICAL ELECTRONICS CALCULATIONS AND FORMULAE

F. A. Wilson, C.G.I.A., C.Eng., F.I.E.E., F.I.E.R.E., F.B.J.M. Bridges the gap between complicated technical theory, and "cut-and-try" methods which may bring success in design but leave the experimenter unfulfilled. A strong practical bias – tedious and higher mathematics have been avoided where possible and many tables have been included.

The book is divided into six basic sections: Units and Constants, Direct-Current Circuits, Passive Components, Alternating-Current Circuits, Networks and Theorems, Measurements.

256 pages **Order code BP53** £5.49

MICROCONTROLLER COOKBOOK

Mike James

The practical solutions to real problems shown in this cookbook provide the basis to make PIC and 8051 devices really work. Capabilities of the variants are examined, and ways to enhance these are shown. A survey of common interface devices, and a description of programming models, lead on to a section on development techniques. The cookbook offers an introduction that will allow any user, novice or experienced, to make the most of microcontrollers.

240 pages **Order code NE26** £25.99

The books listed have been selected by *Everyday Practical Electronics* editorial staff as being of special interest to everyone involved in electronics and computing. They are supplied by mail order direct to your door. Full ordering details are given on the last book page.

FOR A FURTHER SELECTION OF BOOKS AND CDROMS SEE THE SHOP ON OUR UK WEBSITE

www.epemag.com

All prices include UK postage

EASY PC CASE MODDING

R.A. Penfold

Why not turn that anonymous grey tower, that is the heart of your computer system, into a source of visual wonderment and fascination. To start, you need to change the case or some case panels for ones that are transparent. This will then allow the inside of your computer and its working parts to be clearly visible.

There are now numerous accessories that are relatively inexpensive and freely available, for those wishing to customise their PC with added colour and light. Cables and fans can be made to glow, interior lights can be added, and it can all be seen to good effect through the transparent case. Exterior lighting and many other attractive accessories may also be fitted.

This, in essence, is case modding or PC Customising as it is sometimes called and this book provides all the practical details you need for using the main types of case modding components including: Electro luminescent (EL) 'go-faster' stripes; Internal lighting units; Fancy EL panels; Data cables with built-in lighting; Data cables that glow with the aid of 'black' light from an ultraviolet (UV) tube; Digital display panels; LED case and heatsink fans; Coloured power supply covers.

192 pages + CD-ROM **Order code BP542** £8.99

ROBOT BUILDERS COOKBOOK

Owen Bishop

This is a project book and guide for anyone who wants to build and design robots that work first time.

With this book you can get up and running quickly, building fun and intriguing robots from step-by-step instructions. Through hands-on project work, Owen introduces the programming, electronics and mechanics involved in practical robot design-and-build. The use of the PIC microcontroller throughout provides a painless introduction to programming – harnessing the power of a highly popular microcontroller used by students, hobbyists and design engineers worldwide.

Ideal for first-time robot builders, advanced builders wanting to know more about programming robots, and students tackling microcontroller-based practical work and labs.

The book's companion website at <http://books.elsevier.com/companions/9780750665568> contains: downloadable files of all the programs and subroutines; program listings for the Quaker and the Gantry robots that are too long to be included in the book.

366 pages **Order code NE46** £21.99

NEWNES INTERFACING COMPANION

Tony Fischer-Cripps

A uniquely concise and practical guide to the hardware, applications and design issues involved in computer interfacing and the use of transducers and instrumentation. Newnes Interfacing Companion presents the essential information needed to design a PC-based interfacing system from the selection of suitable transducers, to collection of data, and the appropriate signal processing and conditioning.

Contents: Part 1 – Transducers; Measurement systems; Temperature; Light; Position and motion; Force, pressure and flow. Part 2 – Interfacing; Number systems; Computer architecture; Assembly language; Interfacing; A to D and D to A conversions; Data communications; Programmable logic controllers; Data acquisition project. Part 3 – Signal processing; Transfer function; Active filters; Instrumentation amplifier; Noise; Digital signal processing.

295 pages **Order code NE38** £35.99

COMPUTING AND ROBOTICS

WINDOWS XP EXPLAINED

N. Kantaris and R. R. M. Oliver

If you want to know what to do next when confronted with Microsoft's Windows XP screen, then this book is for you. It applies to both the Professional and home editions. The book was written with the non-expert, busy person in mind. It explains what hardware requirements you need in order to run Windows XP successfully, and gives an overview of the Windows XP environment.

The book explains: How to manipulate Windows, and how to use the Control Panel to add or change your printer, and control your display; How to control information using WordPad, notepad and paint, and how to use the Clipboard facility to transfer information between Windows applications; How to be in control of your filing system using Windows Explorer and My Computer; How to control printers, fonts, characters, multimedia and images, and how to add hardware and software to your system; How to configure your system to communicate with the outside world, and use Outlook Express for all your email requirements; how to use the Windows Media Player 8 to play your CDs, burn CDs with your favourite tracks, use the Radio Tuner, transfer your videos to your PC, and how to use the Sound Recorder and Movie Maker; How to use the System Tools to restore your system to a previously working state, using Microsoft's Website to update your Windows setup, how to clean up, defragment and scan your hard disk, and how to backup and restore your data; How to successfully transfer text from those old but cherished MS-DOS programs.

264 pages **Order code BP514** £7.99

INTRODUCING ROBOTICS WITH LEGO MINDSTORMS

Robert Penfold

Shows the reader how to build a variety of increasingly sophisticated computer controlled robots using the brilliant Lego Mindstorms Robotic Invention System (RIS). Initially covers fundamental building techniques and mechanics needed to construct strong and efficient robots using the various "click-together" components supplied in the basic RIS kit. Explains in simple terms how the "brain" of the robot may be programmed on screen using a PC and "zapped" to the robot over an infrared link. Also, shows how a more sophisticated Windows programming language such as Visual BASIC may be used to control the robots.

Detailed building and programming instructions provided, including numerous step-by-step photographs.

288 pages + Large Format **Order code BP901** £14.99

MORE ADVANCED ROBOTICS WITH LEGO MINDSTORMS – Robert Penfold

Shows the reader how to extend the capabilities of the brilliant Lego Mindstorms Robotic Invention System (RIS) by using lego's own accessories and some simple home constructed units. You will be able to build robots that can provide you with 'waiter service' when you clap your hands, perform tricks, 'see' and

Covers the Vision command system

avoid objects by using 'bats radar', or accurately follow a line marked on the floor. Learn to use additional types of sensors including rotation, light, temperature, sound and ultrasonic and also explore the possibilities provided by using an additional (third) motor. For the less experienced, RCX code programs accompany most of the featured robots. However, the more adventurous reader is also shown how to write programs using Microsoft's VisualBASIC running with the ActiveX control (Spirit.OCX) that is provided with the RIS kit.

Detailed building instructions are provided for the featured robots, including numerous step-by-step photographs. The designs include rover vehicles, a virtual pet, a robot arm, an 'intelligent' sweet dispenser and a colour conscious robot that will try to grab objects of a specific colour.

298 pages **Order code BP902** £14.99

THE PIC MICROCONTROLLER YOUR PERSONAL INTRODUCTORY COURSE

– THIRD EDITION John Morton

Discover the potential of the PIC microcontroller through graded projects – this book could revolutionise your electronics construction work!

A uniquely concise and practical guide to getting up and running with the PIC Microcontroller. The PIC is one of the most popular of the microcontrollers that are transforming electronic project work and product design.

Assuming no prior knowledge of microcontrollers and introducing the PICs capabilities through simple projects, this book is ideal for use in schools and colleges. It is the ideal introduction for students, teachers, technicians and electronics enthusiasts. The step-by-step explanations make it ideal for self-study too: this is not a reference book – you start work with the PIC straight away.

The revised third edition covers the popular reprogrammable Flash PICs: 16F54/16F84 as well as the 12F508 and 12F675.

270 pages **Order code NE36** £20.99

INTRODUCTION TO MICROPROCESSORS AND MICROCONTROLLERS – SECOND EDITION

John Crisp

If you are, or soon will be, involved in the use of microprocessors and microcontrollers, this practical introduction is essential reading. This book provides a thoroughly readable introduction to microprocessors and microcontrollers. Assuming no previous knowledge of the subject, nor a technical or mathematical background. It is suitable for students, technicians, engineers and hobbyists, and covers the full range of modern micros.

After a thorough introduction to the subject, ideas are developed progressively in a well-structured format. All technical terms are carefully introduced and subjects which have proved difficult, for example 2's complement, are clearly explained. John Crisp covers the complete range of microprocessors from the popular 4-bit and 8-bit designs to today's super-fast 32-bit and 64-bit versions that power PCs and engine management systems etc.

222 pages **Order code NE31** £22.00

THEORY AND REFERENCE

THE AMATEUR SCIENTIST CD-ROM

The complete collection of The Amateur Scientist articles from Scientific American magazine. Over 1,000 classic science projects from a renowned source of winning projects. All projects are rated for cost, difficulty and possible hazards.

Plus over 1,000 pages of helpful science techniques that never appeared in Scientific American.

Exciting science projects in: Astronomy; Earth Science; Biology; Physics; Chemistry; Weather . . . and much more! The most complete resource ever assembled for hobbyists, and professionals looking for novel solutions to research problems.

Includes extensive Science Software Library with even more science tools. Suitable for Mac, Windows, Linux or UNIX. 32MB RAM minimum, Netscape 4.0 or higher or Internet Explorer 4.0 or higher.

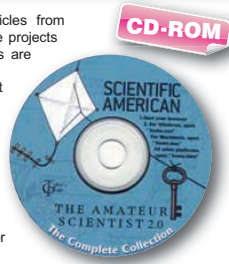

Over 1,000 projects

Order code AS1 CD-ROM £19.95

OSCILLOSCOPES - FIFTH EDITION

Ian Hickman

Oscilloscopes are essential tools for checking circuit operation and diagnosing faults, and an enormous range of models are available.

This handy guide to oscilloscopes is essential reading for anyone who has to use a 'scope for their work or hobby; electronics designers, technicians, anyone in industry involved in test and measurement, electronics enthusiasts . . . Ian Hickman's review of all the latest types of 'scope currently available will prove especially useful for anyone planning to buy - or even build - an oscilloscope.

The contents include a description of the basic oscilloscope; Advanced real-time oscilloscopes; Accessories; Using oscilloscopes; Sampling oscilloscopes; Digital storage oscilloscopes; Oscilloscopes for special purposes; How oscilloscopes work (1); the CRT; How oscilloscopes work (2); circuitry; How oscilloscopes work (3); storage CRTs; plus a listing of Oscilloscope manufacturers and suppliers.

288 pages

Order code NE37 £25.99

ELECTRONIC TEST EQUIPMENT HANDBOOK

Steve Money

In most applications of electronics, test instruments are essential for checking the performance of a system or for diagnosing faults in operation, and so it is important for engineers, technicians, students and hobbyists to understand how the basic test instruments work and how they can be used.

The principles of operation of the various types of test instrument are explained in simple terms with a minimum of mathematical analysis. The book covers analogue and digital meters, bridges, oscilloscopes, signal generators, counters, timers and frequency measurement. The practical uses of these instruments are also examined.

206 pages

Order code PC109 £9.95

UNDERSTANDING ELECTRONIC CONTROL SYSTEMS

Owen Bishop

Owen Bishop has produced a concise, readable text to introduce a wide range of students, technicians and professionals to an important area of electronics. Control is a highly mathematical subject, but here maths is kept to a minimum, with flow charts to illustrate principles and techniques instead of equations.

Cutting edge topics such as microcontrollers, neural networks and fuzzy control are all here, making this an ideal refresher course for those working in industry. Basic principles, control algorithms and hardware control systems are also fully covered so the resulting book is a comprehensive text and well suited to college courses or background reading for university students.

The text is supported by questions under the headings Keeping Up and Test Your Knowledge so that the reader can develop a sound understanding and the ability to apply the techniques they are learning.

228 pages

Order code NE35 £24.99

ALL PRICES INCLUDE UK POST & PACKING

NEW FULL COLOUR COMPUTING BOOKS

HOW TO FIX YOUR PC PROBLEMS

R.A. Penfold

What do you do when your laptop or desktop stops working properly. Do you panic, try to find the answer on the page of fault finding tips you may find at the back of the manufacturers manual. Or do you spend hours trying to get through to a telephone helpline or waste even more time waiting for an email reply from a helpdesk.

Well help is now at hand! This book will assist you in identifying the type of problem, whether it's hardware, software or a peripheral that is playing up? Once the fault has been identified, the book will then show you how to go about fixing it. This book uses plain English and avoids technical jargon wherever possible. It is also written in a practical and friendly manner and is logically arranged for easy reference.

The book is divided into four main sections and among the many topics covered are: Common problems with Windows Vista operating system not covered in other chapters. Also covers to a lesser extent Windows XP problems. Sorting out problems with ports, peripherals and leads. Also covers device drivers software and using monitoring software. Common problems with hard disc drives including partitioning and formatting a new drive. Using system restore and recovering files. Also covers CD-ROM and Flash drives. Common problems with sound and video, including getting a multi-speaker system set up correctly.

An extremely useful addition to the library of all computer users, as you never know when a fault may occur!

Printed in full colour on high quality non-reflective paper

128 pages

Order code BP705 £8.49

AN INTRODUCTION TO WINDOWS VISTA

R.R.M. Oliver and N. Kantarris

If you have recently bought a new desktop or laptop it will almost certainly have Windows as its operating system. Windows Vista manages the available resource of a computer and also 'controls' the programs that run on it.

To get the most from your computer, it is important that you have a good understanding of Vista. This book will help you achieve just that. It is written in a friendly and practical way and is suitable for all age groups from youngsters to the older generation. It has been assumed that Vista is installed and running on your computer.

Among the numerous topics explained are: The Vista environment with its many windows. How to organise your files, folders and photos. How to use Internet Explorer for your web browsing. How to use Microsoft Mail for your emails. How to control your PC and keep it healthy. How to use Vista's Accessibility features if you have poor eye sight or difficulty in using the keyboard or mouse. And much more besides. . . .

With the help of this book you will easily and enjoyably gain a better understanding of Microsoft's amazing Windows Vista operating system.

Printed in full colour on high quality non-reflective paper

120 pages

Order code BP703 £8.49

COMPUTING WITH A LAPTOP FOR THE OLDER GENERATION

R.A. Penfold

Laptop computers have rapidly fallen in price, increased in specification and performance and become much lighter in weight. They can be used practically anywhere, then stored away out of sight. It is therefore, not surprising that laptop sales now far exceed those of desktop machines and that they are increasingly becoming the machine of choice for the older generation.

You may want to use your laptop as your main computer or as an extra machine. You may want to use your laptop on the move, at home, at work or on holiday. Whatever your specific requirements are, the friendly and practical approach of this book will help you to understand and get

the most from your laptop PC in an easy and enjoyable way. It is written in plain English and wherever possible avoids technical jargon.

Among the many topics covered are: Choosing a laptop that suits your particular needs. Getting your new computer set up properly. Customising your computer so that it is optimised for your particular needs. Setting up and dealing with user accounts. Using the Windows 'Ease of Access Center'. Optimising the life and condition of your battery. Keeping the operating system and other software fully up-to-date. Troubleshooting common problems. Keeping your computer and data safe and secure. And much more besides. . . .

Even though this book is written for the older generation, it is also suitable for anyone of any age who has a laptop or is thinking of buying one. It is written for computers that use Windows Vista as their operating system but much will still apply to Windows XP machines. Printed in full colour on high quality non-reflective paper

120 pages

Order code BP702

£8.49

AN INTRODUCTION TO EXCEL SPREADSHEETS

Jim Gatenby

The practical and friendly approach of this book will help newcomers to easily learn and understand the basics of spreadsheets. This book is based on Microsoft's Excel 2007 spreadsheet, but much of the book will still apply to earlier versions of Excel. The book is written in plain English, avoiding technical and mathematical jargon and all illustrations are in full colour. It is suitable for all age groups from youngsters to the older generation.

Among the many topics explained are how to: Install the software. Use the exciting new features of Excel 2007. Create and use a spreadsheet. Enter, edit and format text, numbers and formulae. Insert and delete columns and rows. Save and print a spreadsheet. Present the information on a spreadsheet as a graph or chart. Manage and safeguard Excel files on disc. Use Excel as a simple database for names and addresses.

This book will help you to quickly gain confidence and get to grips with using spreadsheets. In fact, you will wonder how you ever managed without them.

Printed in full colour on high quality non-reflective paper.

118 pages

Order code BP701

£8.49

AN INTRODUCTION TO DIGITAL PHOTOGRAPHY WITH VISTA

R.A. Penfold

The friendly and practical approach of this book will help newcomers to digital photography and computing to easily learn the basics they will need when using a digital camera with a laptop or desktop PC. It is assumed that your PC uses Windows Vista, however, if it is a Windows XP machine the vast majority of this book will still apply. The book is written in plain English, avoiding technical jargon and all illustrations are in full colour. It is suitable for all age groups from youngsters to the older generation.

Among the many topics explained are how to: Understand the basic features of a digital camera. Transfer photographs from your digital camera to your computer. View your photographs. Save, sort and file your photographs. Manipulate, crop and carry out simple corrections to your photographs. Copy your originals on to CD or DVD. Print your photographs. Share images with family and friends anywhere in the world by email or with an online album.

This book will help you quickly get to grips with, gain confidence and expand your horizons in the fascinating hobby of digital photography.

Printed in full colour on high quality non-reflective paper.

120 pages

Order code BP700

£8.49



PROJECT BUILDING

ELECTRONIC PROJECTS FOR EXPERIMENTERS R. A. Penfold

Many electronic hobbyists who have been pursuing their hobby for a number of years seem to suffer from the dreaded "seen it all before" syndrome. This book is fairly and squarely aimed at sufferers of this complaint, plus any other electronics enthusiasts who yearn to try something a bit different.

The subjects covered include:- Magnetic field detector, Basic Hall effect compass, Hall effect audio isolator, Voice scrambler/descrambler, Bat detector, Bat style echo location, Noise cancelling, LED stroboscope, Infra-red "torch", Electronic breeze detector, Class D power amplifier, Strain gauge amplifier, Super hearing aid.

138 pages

Order code BP371 £5.45

BUILDING VALVE AMPLIFIERS Morgan Jones

The practical guide to building, modifying, fault-finding and repairing valve amplifiers. A hands-on approach to valve electronics – classic and modern – with a minimum of theory. Planning, fault-finding, and testing are each illustrated by step-by-step examples.

A unique hands-on guide for anyone working with valve (tube in USA) audio equipment – as an electronics experimenter, audiophile or audio engineer.

Particular attention has been paid to answering questions commonly asked by newcomers to the world of the vacuum tube, whether audio enthusiasts tackling their first build, or more experienced amplifier designers seeking to learn the ropes of working with valves. The practical side of this book is reinforced by numerous clear illustrations throughout.

368 pages

Order code NE40 £23.99

THEORY AND REFERENCE

GETTING THE MOST FROM YOUR MULTIMETER R. A. Penfold

This book is primarily aimed at beginners and those of limited experience of electronics. Chapter 1 covers the basics of analogue and digital multimeters, discussing the relative merits and the limitations of the two types. In Chapter 2 various methods of component checking are described, including tests for transistors, thyristors, resistors, capacitors and diodes. Circuit testing is covered in Chapter 3, with subjects such as voltage, current and continuity checks being discussed.

In the main little or no previous knowledge or experience is assumed. Using these simple component and circuit testing techniques the reader should be able to confidently tackle servicing of most electronic projects.

96 pages

Order code BP239 £5.49

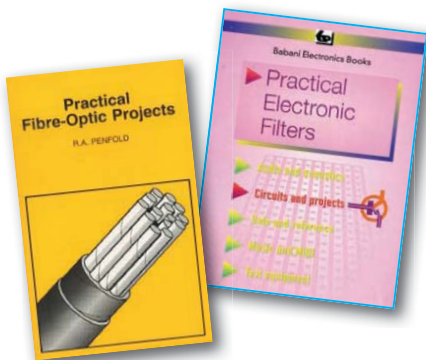

PRACTICAL ELECTRONIC FILTERS Owen Bishop

This book deals with the subject in a non-mathematical way. It reviews the main types of filter, explaining in simple terms how each type works and how it is used.

The book also presents a dozen filter-based projects with applications in and around the home or in the constructor's workshop. These include a number of audio projects such as a rhythm sequencer and a multi-voiced electronic organ.

Concluding the book is a practical step-by-step guide to designing simple filters for a wide range of purposes, with circuit diagrams and worked examples.

188 pages

Order code BP299 £5.45

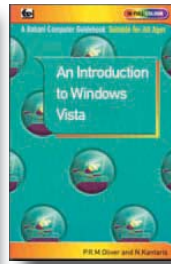
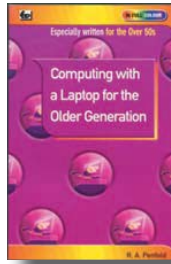

PRACTICAL FIBRE-OPTIC PROJECTS R. A. Penfold

While fibre-optic cables may have potential advantages over ordinary electric cables, for the electronics enthusiast it is probably their novelty value that makes them worthy of exploration. Fibre-optic cables provide an innovative interesting alternative to electric cables, but in most cases they also represent a practical approach to the problem. This book provides a number of tried and tested circuits for projects that utilize fibre-optic cables.

The projects include:- Simple audio links, F.M. audio link, P.W.M. audio links, Simple d.c. links, P.W.M. d.c. link, P.W.M. motor speed control, RS232C data links, MIDI link, Loop alarms, R.P.M. meter.

All the components used in these designs are readily available, none of them require the constructor to take out a second mortgage.

132 pages

Order code BP374 £5.45

STARTING ELECTRONICS, THIRD EDITION Keith Brindley

A punchy practical introduction to self-build electronics. The ideal starting point for home experimenters, technicians and students who want to develop the real hands-on skills of electronics construction.

A highly practical introduction for hobbyists, students, and technicians. Keith Brindley introduces readers to the functions of the main component types, their uses, and the basic principles of building and designing electronic circuits. Breadboarding layouts make this very much a ready-to-run book for the experimenter, and the use of multimeter, but not oscilloscopes, and readily available, inexpensive components makes the practical work achievable in a home or school setting as well as a fully equipped lab.

288 pages

Order code NE42 £12.99

VIDEO PROJECTS FOR THE ELECTRONICS CONSTRUCTOR R. A. Penfold

Written by highly respected author R. A. Penfold, this book contains a collection of electronic projects specially designed for video enthusiasts. All the projects can be simply constructed, and most are suitable for the newcomer to project construction, as they are assembled on stripboard. There are faders, wipers and effects units which will add sparkle and originality to your video recordings, an audio mixer and noise reducer to enhance your soundtracks and a basic computer control interface. Also, there's a useful selection on basic video production techniques to get you started.

Circuits include: video enhancer, improved video enhancer, video fader, horizontal wiper, improved video wiper, negative video unit, fade to grey unit, black and white keyer, vertical wiper, audio mixer, stereo headphone amplifier, dynamic noise reducer, automatic fader, pushbutton fader, computer control interface, 12 volt mains power supply.

124 pages

Order code PC115 £5.45

BOOK ORDERING DETAILS

All prices include UK postage. For postage to Europe (air) and the rest of the world (surface) please add £2 per book. For the rest of the world airmail add £3 per book. Note: Overseas surface mail postage can take up to 10 weeks. CD-ROM prices include VAT and/or postage to anywhere in the world. Send a PO, cheque, international money order (£ sterling only) made payable to Direct Book Service or card details, Visa, Mastercard or Maestro to:

DIRECT BOOK SERVICE, WIMBORNE PUBLISHING LIMITED, SEQUOIA HOUSE, 398a RINGWOOD ROAD, FERNDOWN, DORSET BH22 9AU.

Books are normally sent within seven days of receipt of order, but please allow 28 days for delivery – more for overseas orders. Please check price and availability (see latest issue of Everyday Practical Electronics) before ordering from old lists.

For a further selection of books see the next two issues of EPE.
Tel 01202 873872 Fax 01202 874562. Email: dbs@wimborne.co.uk
Order from our online shop at: www.epemag.com

BOOK ORDER FORM

Full name:

Address:

.....

.....

..... Post code: Telephone No:

Signature:

I enclose cheque/PO payable to DIRECT BOOK SERVICE for £

Please charge my card £ Card expiry date.....

Card Number Maestro Issue No.....

Card Security Code Card valid from date

(the last three digits on or just below the signature strip)

Please send book order codes:

.....

Please continue on separate sheet of paper if necessary

PCB SERVICE

Printed circuit boards for most recent *EPE* constructional projects are available from the *PCB Service*, see list. These are fabricated in glass fibre, and are fully drilled and roller tinned. Double-sided boards are **NOT plated through hole** and will require 'vias' and some components soldering to both sides. All prices include VAT and postage and packing. Add £1 per board for airmail outside of Europe. Remittances should be sent to **The PCB Service, Everyday Practical Electronics, Wimborne Publishing Ltd., Sequoia House, 398a Ringwood Road, Ferndown, Dorset BH22 9AU. Tel: 01202 873872; Fax 01202 874562; Email: orders@epemag.wimborne.co.uk. On-line Shop: www.epemag.com.** Cheques should be crossed and made payable to *Everyday Practical Electronics* (Payment in £ sterling only).
NOTE: While 95% of our boards are held in stock and are dispatched within seven days of receipt of order, please allow a maximum of 28 days for delivery – overseas readers allow extra if ordered by surface mail. Back numbers or photocopies of articles are available if required – see the Back Issues page for details. WE DO NOT SUPPLY KITS OR COMPONENTS FOR OUR PROJECTS.

Please check price and availability in the latest issue. A large number of older boards are listed on, and can be ordered from, our website.

Boards can only be supplied on a payment with order basis.

PROJECT TITLE	ORDER CODE	COST
MAY '08		
★ PC-Controlled Burglar Alarm – Keypad	668	£6.18
★ Electric Mobility Buggy Monitor	669	£6.02
Mini Theremin	670	£10.15
JUNE '08		
★ Monopoly Money	671	£7.30
★ Universal High-Energy LED Lighting System	673	£6.82
JULY '08		
★ PIC MIDI Sound Wave Generator	672	£11.20
Galactic Voice	674	£6.82
Coolmaster	675	£6.34
AUGUST '08		
Four-Channel A/V Selector	676	£9.51
DC Relay Switch For High Current Loads	677	£6.02
Versatile Temperature Switch	678	£6.66
★ Mains Monitor – Monitor	679	£7.13
– Interface	680	£5.71
SEPTEMBER '08		
Magnetic Cartridge Preampifier	681	£7.45
★ Super Speedo Corrector	682	£6.66
Ultrasonic Eavesdropper	683	£6.82
S-Video To Composite Video Converter (double-sided)	684	£9.98
OCTOBER '08		
★ Intelligent Car Air-Conditioner Controller	685	£6.66
★ Cordless Power Tool Charger Controller	686	£6.18
20W Class-A Amplifier Module – Left Channel	687	£7.29
– Right Channel	688	£7.29
– PSU	689	£6.50
NOVEMBER '08		
★ 50MHz Frequency Meter – Mk. 2		
– Version 1	581	£6.66
– Version 2	582	£6.66
– Version 3	583	£6.66
Variable Turbo Boost Control	690	£6.34
Fuel Cut Defeater	691	£6.34
DECEMBER '08		
★ Christmas Star	692	£6.97
20W Class-A Amplifier – Speaker Protector & Muting	693	£6.66
Radar Speed Gun – Head	694	£14.95
– Display	695	£14.95
JANUARY '09		
20W Class-A Amplifier		
– Preampifier and Remote Volume Control	696	£7.93
1000:1 UHF Prescaler (double sided)	697	£12.05
FEBRUARY '09		
1.3V To 22V Regulated Power Supply	698	£5.39
★ LED Tachometer – Control Board	699	£9.52
– Display Board	700	£9.52
MARCH '09		
Tank Water Level Indicator	701	£6.34
★ Digital Stereo VU/Peak Meter – Main Board	702	£8.24
– Switch Board	703	£8.24

PROJECT TITLE	ORDER CODE	COST
APRIL '09		
Versatile 4-Input Mixer	704	£10.31
★ Oscar Noughts & Crosses Machine	705	£7.29
★ GPS-Based Frequency Reference		
– Main Board	706	} set £11.10
– Display Board	707	
MAY '09		
Infrared Audio Headphone Link	708	} set £9.20
	709	
Microstepping Unipolar Stepping Motor Driver	710	£7.49
JUNE '09		
★ Spectacular Bike Wheel POV Display (double-sided)	711 (set of 3)	£23.73
★ Remote Volume Control & Preampifier Module		
– Main Board	714	} set £9.20
– Display Board	715	
– Power Supply Board	716	
JULY '09		
★ Solar Water Heating System Controller		
– Main Board	712	} set £15.00
– Display Board	713	
★ PIC Probe (double-sided)	717	£9.50
★ Simple Data-Logging Weather Station		
– Main Board	718	} set £6.66
– RS232 Board	719	
AUGUST '09		
★ Fast Charger For NiMH Batteries	720	£6.66
★ Rolling Code Keyless Entry System		
– Main Board	721	£7.29
– Transmitter (2off)	722 (2off)	£6.18



EPE SOFTWARE

★ All software programs for *EPE* Projects marked with a star, and others previously published can be downloaded free from the Library on our website, accessible via our home page at: www.epemag.com

PCB MASTERS

PCB masters for boards published from the March '06 issue onwards can also be downloaded from our website (www.epemag.com); go to the 'Library' section.

EPE PRINTED CIRCUIT BOARD SERVICE

Order Code	Project	Quantity	Price
.....
Name		
Address		
.....		
Tel. No.		
I enclose payment of £..... (cheque/PO in £ sterling only) to:			
Everyday Practical Electronics			
  			
Card No.		
Valid From	Expiry Date
Card Security No.	Maestro Issue No.
Signature		

Note: You can also order PCBs by phone, Fax or Email or via the Shop on our website on a secure server:

<http://www.epemag.com>

EPE EVERYDAY PRACTICAL ELECTRONICS

Everyday Practical Electronics reaches more UK readers than any other UK monthly hobby electronics magazine, our sales figures prove it. We have been the leading monthly magazine in this market for the last twenty-three years.

BTEC ELECTRONICS TECHNICIAN TRAINING

NATIONAL ELECTRONICS
VCE ADVANCED ICT
HNC AND HND ELECTRONICS
FOUNDATION DEGREES
NVQ ENGINEERING AND IT
DESIGN AND TECHNOLOGY

LONDON ELECTRONICS COLLEGE
20 PENYWERN ROAD
EARLS COURT, LONDON SW5 9SU
TEL: (020) 7373 8721
www.lec.org.uk

www.partridgeelectronics.co.uk

For The Electronic Components &
Hardware You Have Been
Looking For

BOWOOD ELECTRONICS LTD

Suppliers of Electronic Components
Place a secure order on our website or call our sales line
All major credit cards accepted
Web: www.bowood-electronics.co.uk
Unit 10, Boythorpe Business Park, Dock Walk, Chesterfield,
Derbyshire S40 2QR. Sales: 01246 200222
Send 60p stamp for catalogue

spinvent.co.uk



...invent with the Propeller
microcontroller and Spin programming
language from Parallax



The British Amateur Electronics Club

Archive Website. Archiving extracts for 140+ Newsletters from 1966-2002. Currently have interesting and useful selected articles from 19 Newsletters.

Also a section about built electronics projects with schematics and photos. Plus useful info., downloads and links. "NO ADVERTS!"

Website Address: <http://baec.tripod.com>

www.cstech.co.uk



28 & 40 pin USB
PIC
Prototyping Kits
From £12.99

CANTERBURY WINDINGS

UK manufacturer of toroidal transformers (10VA to 1kVA)
All transformers made to order. No design fees. No minimum order.
www.canterburywindings.co.uk
01227 450810

RSH ELECTRONICS

UK & International Suppliers of Electronic Components & Kits
Seasonal Velleman & Stripboard Project Kits Including:
Twinkling Christmas Tree, Flashing Star, Animated Bell
Plus a great range of hobby components for the electronics enthusiast.
P&P £2.50 (orders over £25 free P&P) No Min Order. No VAT
www.rshelectronics.co.uk

If you want your advertisements to be seen by the largest readership at the most economical price our classified page offers excellent value. The rate for semi-display space is £10 (+VAT) per centimetre high, with a minimum height of 2.5cm. All semi-display adverts have a width of 5.5cm. The prepaid rate for classified adverts is 40p (+VAT) per word (minimum 12 words).

All cheques, postal orders, etc., to be made payable to Everyday Practical Electronics. VAT must be added. Advertisements, together with remittance, should be sent to Everyday Practical Electronics Advertisements, Sequoia House, 398a Ringwood Road, Ferndown, Dorset BH22 9AU. Phone: 01202 873872. Fax: 01202 874562. Email: epeads@wimborne.co.uk. For rates and information on display and classified advertising please contact our Advertisement Manager, Stewart Kearn as above.

Versatile Programmable PIC On Screen Display System

Display text over any composite video signal



● Fully programmable I/O for sensor interfaces
● PIC 16F628A micro ● User definable fonts
● Example code for MSF, cash register, 1-wire & GPS data display

PAL - NTSC compatible
WWW.PIC-OSD.COM

www.apdanglia.org.uk

For RFID Components

EM4100 Cards .99p - Keyfobs £1.09
T5557 keyfobs £1.65 inc vat plus RFID Coils,
125 khz R/W modules - RFID RS232 PCB's,
RFID IC's EM4095 - U2270B- Prox keypads
Technical information pages
Visit our website for further details
No min order charge - UK Delivery £2.50

Miscellaneous

VALVES AND ALLIED COMPONENTS
IN STOCK. Phone for free list. Valves,
books and magazines wanted. Geoff Davies
(Radio), tel. 01788 574774.

1-0, 2-5 + 30-0 RPM MAINS MOTORS
240V 4W. Body 50mm diameter x 25mm
with lugs. Shaft 7mm diameter. £9.85 including
postage. C. Brittain, 12 Marina Drive,
Wolverton, MK12 5DW. 07986 824998

ELECTRONICS TEACH-IN

BY MIKE TOOLEY

plus FREE CD-ROM

ONLY £8.50

INCLUDING P&P FROM OUR
DIRECT BOOK SERVICE

A broad-based introduction to electronics – find out how circuits work and what goes on inside them. Plus 15 easy-to-build projects. The 152 page A4 book comes with a free CD-ROM containing the whole *Teach-In 2006* series (originally published in *EPE*) in PDF form, interactive quizzes to test your knowledge, TINA circuit simulation software (a limited version – plus a specially written TINA Tutorial), together with simulations of the circuits in the *Teach-In* series, plus Flowcode (a limited version) a high level programming system for PIC microcontrollers based on flowcharts.

See our *Direct Book Service* – pages 75 to 77

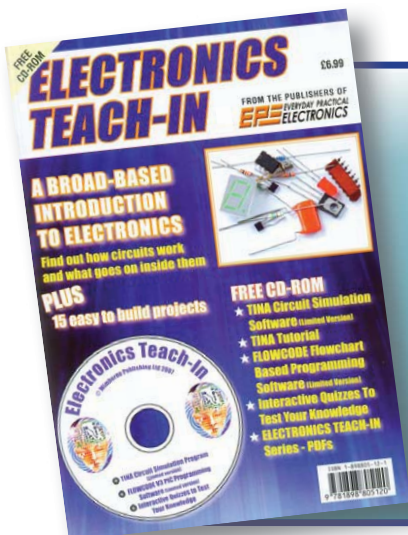

Europe's Largest Surplus Store

20,000,000 Items on line NOW !
New items added daily

Established for over 25 years, UK company Display Electronics prides itself on offering a massive range of electronic and associated electro-mechanical equipment and parts to the Hobbyist, Educational and Industrial user. Many current and obsolete hard to get parts are available from our vast stocks, which include:

- ◆ 6,000,000 Semiconductors
- ◆ 5,000 Power Supplies
- ◆ 25,000 Electric Motors
- ◆ 10,000 Connectors
- ◆ 100,000 Relays & Contactors
- ◆ 2000 Rack Cabinets & Accessories
- ◆ 4000 Items of Test Equipment
- ◆ 5000 Hard Disk Drives

We Ship Worldwide

Surplus Wanted

www.distel.co.uk

Display Electronics
29 / 35 Osborne Road
Thornton Heath
Surrey UK CR7 8PD

Telephone
[44] 020 8653 3333
Fax [44] 020 8653 8888

Rechargeable Batteries With Solder Tags

NIMH	NICAD
AA 2000mAh£2.82	AA 650mAh £1.41
C 4Ah£4.70	C 2.5Ah£3.60
D 9Ah£7.60	D 4Ah£4.95
PP3 150mAh £4.95	

Instrument case with edge connector and screw terminals

Size 112mm x 52mm x 105mm tall

This box consists of a cream base with a PCB slot, a cover plate to protect your circuit, a black lid with a 12 way edge connector and 12 screw terminals built in (8mm pitch) and 2 screws to hold the lid on. The cream bases have minor marks from dust and handling price £2.00 + VAT(=£2.35) for a sample or £44.00+VAT (=£51.70) for a box of 44.

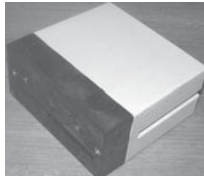

866 battery pack originally intended to be used with an orbital mobile telephone it contains 10 1.6Ah sub C batteries (42 x 22 dia. the size usually used in cordless screwdrivers etc.) the pack is new and unused and can be broken open quite easily £7.46 + VAT = **£8.77**



Please add £1.66 + VAT = £1.95 postage & packing per order

JPG Electronics
Shaws Row, Old Road, Chesterfield, S40 2RB.
Tel 01246 211202 Fax 01246 550959
www.JPGElectronics.com
Mastercard/Visa/Switch

Callers welcome 9.30 a.m. to 5.30 p.m. Monday to Saturday

EPE EVERYDAY PRACTICAL ELECTRONICS

NEXT MONTH

KEYLESS ENTRY SYSTEM – PART 2

Following on from last month's electronic introduction to this super secure door entry system, Part 2 covers installation and setting-up procedures. Plus, we will explain how to include an optional SOIC adaptor board to enable PIC programming.

PIC PROGRAMMER SOIC CONVERTER

Surface-mount PIC chips are great for building tiny smart circuits, but when its time for programming, how do you access the pins? The answer is our 18-lead surface-mount PIC Programmer SOIC Converter. This adaptor PC board accepts these handy devices and plugs directly into a conventional PIC programmer.

PROGRAMMABLE IGNITION – PART 1

Want to program the ignition timing on your car? Now you can, with this completely new design. It can even be used in older cars that don't have electronic ignition or used as an 'interceptor' for cars with engine management systems. Your spark plugs will thank you.

RECYCLE IT! – DRILLER THRILLER

Cordless drills are probably the most frequently discarded power tools. Rubbish to some, but a wealth of opportunity for *EPE* readers! Don't miss next month's recycling top tips for making the most of cheap-as-chips high quality components.

SEPTEMBER '09 ISSUE
ON SALE 13 AUGUST

Content may be subject to change

ADVERTISERS INDEX

BETA LAYOUT	67
CRICKLEWOOD	21
DISPLAY ELECTRONICS	80
ESR ELECTRONIC COMPONENTS	6, Cover (iii)
JAYCAR ELECTRONICS	4/5
JPG ELECTRONICS	80
LABCENTER	Cover (iv)
LASER BUSINESS SYSTEMS	67
MAGENTA ELECTRONICS	67
NURVE NETWORKS LLC	63
PEAK ELECTRONIC DESIGN	Cover (ii)
PICO TECHNOLOGY	21
QUASAR ELECTRONICS	2/3
SHERWOOD ELECTRONICS	21
STEWART OF READING	Cover (ii)

ADVERTISEMENT OFFICES:

Sequoia House, 398a Ringwood Road, Ferndown, Dorset BH22 9AU

PHONE: 01202 873872 Fax: 01202 874562

EMAIL: epeads@wimborne.co.uk

For Editorial address and phone numbers see page 7

Order Now
0845
251 4363



The UK's number 1 source of VELLEMAN® products.

We are the only current UK supplier able to offer the full range of **Velleman** - Mini Kits - Kits - Modules & Test Equipment. All the latest products added as released.

Audio Amplifier
 2 x 15Wrms (4 ohm) or 2 x 10Wrms (8 ohm). Overheating & short-circuit protected. No need for rectifier & smoothing, only AC supply required.
K4003 Kit £17.84
VM113 Assembled £19.99

Audio Amplifier
 100Wrms @ 4ohm DC supply circuit on board with LED indication ideal for active speaker system or subwoofer, guitar amp, home theatre systems, etc. Overload & short-circuit protected.
K8060 Kit £14.18
171-030 Heatsink for above £11.18
VM100 Assembled with heatsink £38.54
325-030 120VA Toroidal Transformer £14.25

Audio Amplifier
 Stereo 2 x 50Wrms or a Mono 100Wrms amplifier. Three input sensitivity settings. Overload & short-circuit protection, protection against incorrect power supply polarity. Speaker transient suppression.
K4004 Kit £54.88

High-End Control Amplifier
 4 Input, inc RIAA input Headphone output Audio Grade OpAmps Capacitor-less Coupling Including Solid Aluminium Housing
K8021 Kit £155.37

Sub-Woofer Amplifier
 Bass-reflex system with adjustable tube. Complete kit (exc wood panels) to build a 100W compact active sub-woofer. 25-100Hz
K8077 Kit £85.80

RGB LED Controller
 Ideal for LED strips, also suitable for incandescent lamps. Wide range of effects. Hi-power MOSFETs 3A per channel, 10-15Vdc supply.
K8088 RGB LED Controller Kit £15.15
VM146 Assembled version £22.52
VM151 Assembled version with remote control £29.53

Packet Audio Generator
 Microprocessor Technology Digital waveform audio generator. 50Hz, 100Hz, 1kHz, 10kHz & 20kHz
K8065 Kit £13.41
VM156 Assembled £20.00

High Power LED Driver
 Power up to four 1W or two 3W high-power LEDs (not incl.) Delivers accurate constant current required by most high-power LEDs, built-in rectifier for easy connection to AC source, compact size, short-circuit protected, no heatsink required.
K8071 Kit £5.86
VM143/1W for 1W LEDs £10.52
VM143/3W for 3W LEDs £11.07

3-30V 3A Power Supply
 Suitable as a power supply for all common Velleman kits using a stabilised DC voltage between 3 and 30V, 3A max. Of course this power supply unit can also be used for other purposes. By replacing the trimmer by a potentiometer, it may even be used as an adjustable power supply unit. Supplied with heat sink.
K7203 Kit £25.10

1A Power Supply
 Low cost universal symmetric power supply just add a suitable transformer and a heatsink, ... Trimmers can be replaced by potentiometers to allow continuous adjustment of output, LED output indicators.
K8042 Kit £7.78

PIC Programmer
 Suitable for a wide range of Microchip® PIC™ microcontrollers, on-board configurable 40 pin. ZIF socket, Microcontroller selection using patch jumper, easy to use programming PICprog2006™ software included, SUBD connector set included.
K8076 Kit £24.95

PIC Programmer
 For Microchip® FLASH PIC™ microcontrollers supports 4 different 300 mil. PICs: 8p, 14p, 18p and 28p test buttons and LED indicators. Supplied with programming examples & easy connection to a PC through the serial port. Supplied with a PIC16F627 and software to compile and program your source code.
K8048 Kit £25.38
VM111 Assembled £36.20

USB Interface
 A interface board with 5 digital input & 8 digital output channels. In addition, there are two analogue inputs & two analogue outputs with 8 bit resolution. All communication routines are contained in a Dynamic Link Library (DLL). You may write custom Windows (98SE, 2000, Me, XP) applications in Delphi, Visual Basic, C++ Builder or any other 32-bit Windows application development tool that supports calls to a DLL.
K8055 Kit £25.65
VM110 Assembled £38.78

USB Interface Board
 With a total of 33 input/outputs: including analogue / digital and + 1PWM output. Connection to the computer is galvanically optically isolated, so that damage to the computer is not possible thus providing a high level of secure implementation. Supplied with test software & examples.
K8061 Kit £66.48
VM140 Assembled £83.15

Mini PIC Application Module
 Create your own custom PIC application without the hassle of making the hardware. 9 Free programmable I/Os. Onboard Relay, LEDs & Buzzer. PIC16F630 inc.
VM142 Assembled £26.00

USB DMX Interface
 Control DMX fixtures using a PC and USB interface, test software and "DMX Light Player" software is included, a DLL is provided to write your own software. Stand-alone test function that outputs all 512 channels at a time, with adjustable levels. Supplied with case, lead & CDROM
K8062 Kit £55.55
VM116 Assembled £69.64

Record/Playback Kit
 10 to 35 second record time High Quality Audio Amplifier & Speaker Included Separate Line output External Trigger Speed Control 4.5Vdc Supply 1uA Standby
MK174 Mini Kit £11.87

Velleman Instruments

We also carry the Velleman range of fully assembled test equipment. This range of hand held Scopes and PC based measurement equipment, uses all the latest techniques to achieve "state of the art" equipment that would be at home in any industrial applications or in the hands of the enthusiast. **Full specs on our web site.**

New USB Scope & Function Generator
 A complete USB powered lab in a box. Feature-packed PCLab2000-LT software for two channel oscilloscope, spectrum analyser, recorder, function generator and bode plotter.
PCSGU250 USB Scope & Function gen. £113.67

Two channel USB PC Oscilloscope
 A digital storage oscilloscope uses the power of your PC to visualize electrical signals. Its high sensitive display resolution, down to 0.15mV, combined with a high bandwidth and a sampling frequency of up to 1GHz are giving this unit all the power you need.
PCSU1000 USB PC Scope & Probes £316.64

2MHz USB PC Function Generator
 A digital function generator which can be connected with a PC via USB. Standard signal waves like sine, triangle and rectangle are available; other sine waves can be easily created. The signal waves are created in the PC and produced by the function generator via DDS (Direct Digital Wave Synthesis).
PCGU1000 USB Function Generator £118.38

Handheld Oscilloscope
 •40MHz Sampling rate • 12MHz Analogue bandwidth • High resolution LCD with Backlight • Data recorder function •RS232 PC Link
 Supplied with Probe, Carry case & Leads.
HPS40 Handheld Scope £257.06

..... other Velleman Instruments
APS230 Advanced Personal Scope £385.00
HSP10 Handheld Scope £115.14
HSP10SE Handheld Scope inc case £128.22
HPS50 Handheld USB Scope £257.45
PCS500A PC Digital Storage Scope £317.46
PPS10 Personal Pocket Scope £115.13
VPS10 Panel Scope £115.53
PCS10 4 Channel Data Logger £32.68

see our web site for full specifications

Over 300 Kits, Mini Kits & Modules - check web site for details



Tel: 0191 2514363
Fax: 0191 2522296
sales@esr.co.uk

Station Road
Cullercoats
Tyne & Wear
NE30 4PQ



Prices Exclude Vat @15%.
 UK Carriage £2.50 (less than 1kg)
 £5.50 greater than 1kg or >£30
 Cheques / Postal orders payable to
 ESR Electronic Components Ltd.
 PLEASE ADD CARRIAGE & VAT TO ALL ORDERS



MARCONI / IFR 2030
Signal Generator 10KHZ-1.35GHZ
From **£1,000** Depending on options



HP3324A
Synthesised Function Generator 21MHZ
£500



SOLATRON 1250
Frequency Response Analyser
10 uHZ to 20MHZ
£ POA



HP35670A
FFT Dynamic
Signal Analyser 2
Channel
Unused in original
box
£ POA



HP 54600B
Dual Trace
100MHZ
20 MS/S
Special Offer
Price **£225**



AGILENT E4402B
Spectrum Analyser
100HZ - 3 GHZ with
options 1DN Tracking
Generator, 1DR
Narrow Res, A4H
GPIB, UKB
£ POA

HP 8591E
Spectrum Analyser
9KHZ-1.8GHZ
with Tracking
Generator **£1500**
No mouldings, no
handle **£1250**



HP8591A Spectrum Analyser
1MHZ-1.8GHZ 75ohm with Tracking Generator -
Special Offer Price **£950**
HP8590A Spectrum
Analyser
10KHZ-1.79GHZ 75 ohm
Special Offer Price **£750**



MARCONI 2022E
Synthesized AM/FM Signal Generator
10KHZ-1.01GHZ
Special Offer **£325**



STEWART OF READING

17A King Street, Mortimer, Near
Reading RG7 3RS
Telephone: (0118) 933 1111
Fax: (0118) 933 2375
9am - 5pm Monday - Friday

CHECK OUT OUR WEBSITE,
1,000's of items currently in stock
www.stewart-of-reading.co.uk
Extra Special Oscilloscope
offer still on

Used Equipment - **GUARANTEED**
Most Manuals Supplied
Please check availability before
ordering or calling.
Prices plus carriage and VAT

Special Offers AND Reduced VAT!



electronic design ltd

Atlas Star Pack

Atlas DCA and Atlas LCR in Premium Carry Case

Special Offer AND Reduced VAT!

Atlas DCA - Model DCA55 Semiconductor Analyser

Identifies type and pinout! Connect any way round.
Measures gain, junction characteristics and more.
Now with premium strong probes!!

Atlas LCR - Model LCR40 Passive Component Analyser

Automatic component identification (inductor, capacitor
or resistor). Auto frequency selection. Measures main
component value and other parameters too such as the DC
resistance of inductors automatically.....



only **£124.99 inc VAT**
(£108.69+VAT)
you save £20!

Atlas ESR - Model ESR60

Reduced VAT

Measure capacitance and ESR!
Capacitance from 1uF to 22,000uF
ESR from 0.01 ohms to 20 ohms
Battery included + Gold plated croc clips

Features our
unique
automatic
discharge
function



£87.10 inc VAT
(£76.74+VAT)

Network Cable Analyser

Special Offer AND Reduced VAT!

Automatically test and
identify your network
cables with the famous
Peak Atlas IT!
Supplied with all this:

only **£65.00 inc VAT**
(£56.52+VAT)
you save £20!



Atlas LCR

Reduced VAT

see description in main offer



£77.31 inc VAT
(£67.23+VAT)

Atlas DCA

Reduced VAT

see description in main offer



£53.83 inc VAT
(£46.81+VAT)

new
probes!

Peak Electronic Design Ltd, West Road House, West Road,
Buxton, Derbyshire, SK17 6HF.
tel. 01298 70012 www.peakelec.co.uk sales@peakelec.co.uk

Please add £2.00 p&p per order. Prices include UK VAT. See website for overseas prices. Special Offer prices for limited period or while stocks last

Order Now
0845
251 4363



velleman

The UK's number 1 source of VELLEMAN® products.

We are the only current UK supplier able to offer the full range of **Velleman** - Mini Kits - Kits - Modules & Test Equipment. All the latest products added as released.



Audio Amplifier
2 x 15Wrms (4 ohm) or 2 x 10Wrms (8 ohm). Overheating & short circuit protected. No need for rectifier & smoothing, only AC supply required.
K4003 Kit £17.84
VM113 Assembled £19.99



Audio Amplifier
100Wrms @ 4ohm DC supply circuit on board with LED indication ideal for active speaker system or subwoofer, guitar amp, home theatre systems, etc. Overload & short-circuit protected.

K8060 Kit £14.18
171-030 Heatsink for above £11.18
VM100 Assembled with heatsink £38.54
325-030 120VA Toroidal Transformer £14.25

Audio Amplifier

Stereo 2 x 50Wrms or a Mono 100Wrms amplifier. Three input sensitivity settings. Overload & short-circuit protection, protection against incorrect power supply polarity. Speaker transient suppression.
K4004 Kit £54.88



High-End Control Amplifier

4 Input, inc RIAA input
Headphone output
Audio Grade OpAmps
Capacitor-less Coupling
Including Solid Aluminium Housing



K8021 Kit £155.37

Sub-Woofers Amplifier

Bass-reflex system with adjustable tube. Complete kit (exc wood panels) to build a 100W compact active sub-woofer. 25-100Hz



K8077 Kit £85.80

RGB LED Controller
Ideal for LED strips, also suitable for incandescent lamps. Wide range of effects. Hi-power MOSFETs 3A per channel, 10-15Vdc supply.



K8088 RGB LED Controller Kit £15.15
VM146 Assembled version £22.52
VM151 Assembled version with remote control £29.53

Pocket Audio Generator
Microprocessor Technology Digital waveform audio generator. 50Hz, 100Hz, 1kHz, 10kHz & 20kHz



K8065 Kit £13.41
VM156 Assembled £20.00

High Power LED Driver

Power up to four 1W or two 3W high-power LEDs (not incl.) Delivers accurate constant current required by most high-power LEDs, built-in rectifier for easy connection to AC source, compact size, short-circuit protected, no heatsink required.



K8071 Kit £5.86
VM143/1W for 1W LEDs £10.52
VM143/3W for 3W LEDs £11.07

3-30V 3A Power Supply

Suitable as a power supply for all common Velleman kits using a stabilised DC voltage between 3 and 30V, 3A max. Of course this power supply unit can also be used for other purposes. By replacing the trimmer by a potentiometer, it may even be used as an adjustable power supply unit. Supplied with heat sink.



K7203 Kit £25.10

1A Power Supply

Low cost universal symmetric power supply just add a suitable transformer and a heatsink, ... Trimmers can be replaced by potentiometers to allow continuous adjustment of output, LED output indicators.



K8042 Kit £7.78

PIC Programmer

Suitable for a wide range of Microchip® PIC™ microcontrollers, onboard configurable 40 pin. ZIF socket, Microcontroller selection using patch jumper, easy to use programming PICprog2004™ software included, SUBD connector set included.
K8076 Kit £24.95



PIC Programmer

For Microchip® FLASH PIC™ microcontrollers supports 4 different 300 mil. PICs: 8p, 14p, 18p and 28p test buttons and LED indicators. Supplied with programming examples & easy connection to a PC through the serial port. Supplied with a PIC16F627 and software to compile and program your source code.
K8048 Kit £25.38
VM111 Assembled £36.20



USB Interface

A interface board with 5 digital input & 8 digital output channels. In addition, there are two analogue inputs & two analogue outputs with 8 bit resolution. All communication routines are contained in a Dynamic Link Library (DLL). You may write custom Windows (98SE, 2000, Me, XP) applications in Delphi, Visual Basic, C++ Builder or any other 32-bit Windows application development tool that supports calls to a DLL.
K8055 Kit £25.65
VM110 Assembled £38.78



USB Interface Board

With a total of 33 input/outputs: including analogue / digital and +1PWM output. Connection to the computer is galvanically optically isolated, so that damage to the computer is not possible thus providing a high level of secure implementation. Supplied with test software & examples.
K8061 Kit £66.48
VM140 Assembled £83.15



Mini PIC Application Module

Create your own custom PIC application without the hassle of making the hardware. 9 Free programmable I/Os. Onboard Relay, LEDs & Buzzer. PIC16F630 inc.
VM142 Assembled £26.00



USB DMX Interface

Control DMX fixtures using a PC and USB interface, test software and "DMX Light Player" software is included, a DLL is provided to write your own software. Stand-alone test function that outputs all 512 channels at a time, with adjustable levels. Supplied with case, lead & CDROM
K8062 Kit £55.55
VM116 Assembled £69.64



Record/Playback Kit

10 to 35 second record time
High Quality Audio
Amplifier & Speaker Included
Separate Line output
External Trigger
Speed Control
4.5Vdc Supply
1uA Standby



MK174 Mini Kit £11.87

Velleman Instruments

We also carry the Velleman range of fully assembled test equipment. This range of hand held Scopes and PC based measurement equipment, uses all the latest techniques to achieve "state of the art" equipment that would be at home in any industrial applications or in the hands of the enthusiast. **Full specs on our web site.**



New USB Scope & Function Generator
A complete USB powered lab in a box. Feature-packed Pclab2000-LT software for two channel oscilloscope, spectrum analyser, recorder, function generator and bode plotter.



PCSGU250 USB Scope & Function gen. £113.67

Two channel USB PC Oscilloscope

A digital function generator uses the power of your PC to visualize electrical signals. Its high sensitive display resolution, down to 0.15mV, combined with a high bandwidth and a sampling frequency of up to 1GHz are giving this unit all the power you need.



PCSU1000 USB PC Scope & Probes £316.64

Handheld Oscilloscope

•40MHz Sampling rate • 12MHz Analogue bandwidth • High resolution LCD with Backlight • Data recorder function •RS232 PC Link
Supplied with Probe, Carry case & Leads.



HPS40 Handheld Scope £257.06

..... other Velleman Instruments

APS230 Advanced Personal Scope £385.00
HSP10 Handheld Scope £115.14
HSP10SE Handheld Scope inc case £128.22
HPS50 Handheld USB Scope £257.45
PCS500A PC Digital Storage Scope £317.46
PPS10 Personal Poscket Scope £115.13
VPS10 Panel Scope £115.53
PCS10 4 Channel Data Logger £32.68



2MHz USB PC Function Generator

A digital function generator which can be connected with a PC via USB. Standard signal waves like sine, triangle and rectangle are available; other sine waves can be easily created. The signal waves are created in the PC and produced by the function generator via DDS (Direct Digital wave Synthsis).



PCGU1000 USB Function Generator £118.38

see our web site for full specifications

Over 300 Kits, Mini Kits & Modules - check web site for details



Tel: 0191 2514363
Fax: 0191 2522296
sales@esr.co.uk

Station Road
Cullercoats
Tyne & Wear
NE30 4PQ

Prices Exclude Vat @15%.
UK Carriage £2.50 (less than 1kg)
£5.50 greater than 1kg or >£30
Cheques / Postal orders payable to
ESR Electronic Components Ltd.
PLEASE ADD CARRIAGE & VAT TO ALL ORDERS

LEAP INTO THE FUTURE...



Powerful EDA Software at Affordable Prices

PROTEUS DESIGN SUITE Features:

- Easy to use, standard Windows interface.
- Publication quality schematics.
- Fully configurable bill of materials.
- Large component libraries for both simulation and PCB layout.
- Mixed mode SPICE circuit simulation.
- Co-simulation of PIC, AVR, 8051 and ARM7 microcontroller firmware.
- Integrates with MP-LAB and AVR Studio.
- Automatic component placement and gateswap optimization.
- Highly configurable design rules.
- Interactive design rule checking.
- Polygonal and split power planes.
- World class shape based autorouter.
- Automatic mitre/unmitre commands.
- Industry standard CAD/CAM & ODB++ output.
- Integrated 3D Viewer with 3DS and DXF export.

All levels of the **Proteus Design Suite** now include a world class fully integrated shape based autorouter at no additional cost - prices start from just £150 exc. VAT & delivery

labcenter  www.labcenter.com

Electronics

Labcenter Electronics Ltd. 53-55 Main Street, Grassington, North Yorks. BD23 5AA.
Registered in England 4692454 Tel: +44 (0)1756 753440, Email: info@labcenter.com

Visit our website or
phone 01756 753440
for more details