

NOTICE TO READER
When you finish reading this magazine, place a one-cent stamp on this notice, mail the magazine, and it will be placed in the hands of our soldiers or sailors destined to proceed overseas.
NO WRAPPING—NO ADDRESS

TK
780
E54
Vol 6
no. 2

JAN.
1919
20 CTS.

OVER
175
ILLUST.

ELECTRICAL EXPERIMENTER

SCIENCE AND INVENTION

REG. U.S. PAT. OFF.

SMOKE BARRAGE SAVES ESCAPING PLANE

SEE PAGE 612



LARGEST CIRCULATION OF ANY ELECTRICAL PUBLICATION

FREE BE A CERTIFICATED ELECTRICIAN



**YOU MEN
LISTEN**

The country needs more trained, graduate electricians. Thousands have gone into the Government service and there is such an unusual demand for competent electrical men that I am making a wonderful offer at this time. **HERE IS YOUR OPPORTUNITY!** I want to send you my splendid offer now.

Don't hesitate because of age or experience. Young men, boys and old men must now fill the gaps and keep business going. **DO YOUR PART.** Prepare yourself for a real position, by my **Home Study Course** in *Practical Electricity*. I am Chief Engineer of the Chicago Engineering Works. I have trained thousands of men and can help you better than anybody else. We also have large, splendidly-equipped shops where you can come at any time for special instruction without charge. No other correspondence school can give you this.

SPECIAL OFFER: Right now I am giving a big, valuable surprise that I cannot explain here, to every student who answers this ad. Write today!

\$46⁰⁰ to \$100⁰⁰ a Week

Go after some real money. Qualify for one of the thousands of splendid positions open. All you need to start is a few months snappy, *practical* instruction from a competent engineer. Come to me—*NOW*. I'll give you my personal care to ensure rapid and efficient progress. My course is intensely practical. It is highly condensed, simplified, up-to-date and complete. I am so sure you will make a splendid success in this study, that I will *Guarantee Under Bond* to return to you every cent paid for tuition, if you are not entirely satisfied when you receive your Electrician's Certificate granted you as a graduate of my school.

FREE—Lessons and Outfit—FREE

Send me the Free Outfit Coupon at once. Do it *now!* For a limited period I am making a slashing cut in the cost of tuition, and giving each new student a grand outfit of Electrical Tools, Material and Instruments—in addition—*Absolutely Free*. I will also send you—free and fully prepaid—Proof Lessons to show you how easily you can be trained at home to enter this great profession, by means of my new, revised and original system of mail instruction.

Use this "Free Outfit" Coupon

CHIEF ENG. COOKE, Dept. 21-
441 Cass St., CHICAGO, ILL.

SIR: Send at once—fully prepaid and entirely free—complete particulars of your great offer for this month.

Name

Address

ACT PROMPTLY

Get the full benefit of this great offer. Send the Coupon or a postal for free information without delay. Do it *now*—before my free offers and guarantee are withdrawn.

CHIEF ENGINEER COOKE

Chicago Engineering Works

DEPT. 21

441 Cass Street

CHICAGO, ILL.

Bigger Pay for YOU

"See them first-pay afterwards"

Small Monthly Payment if you're satisfied



You Can Now Know **ELECTRICITY**

As Experts Know It

When we observe the ever-increasing applications and usages of electricity, we wonder if all the present openings and the newly created positions in the electrical world can ever be filled.

The ending of the war lends a new and mighty impetus to the electrical end of American industries. Salaries are soaring. There is practically no limit to the earning power of the man who educates himself in the finer points of electrical work.

Actual working facts

With the advent of the new Library of Practical Electricity, by Terrell Croft, a new era is marked in the production of self educational electrical literature. This library satisfies a demand never heretofore met—the demand for a home study course which would bring out in detail the actual working facts. This great undertaking has been accomplished. It is a seven-year task completed.

No previous electrical training necessary

Three thousand pages, with twenty-one hundred of the clearest illustrations ever put into book form. Each of the eight volumes is indexed so that everything you want to know about electricity is at the finger's end. And when you find what you want, there is not merely a short question and a short answer. You are told everything you want to know. The explanation is clear to you, regardless of whether you have had a previous knowledge of electricity or not.

Know electricity as the highest paid engineers know it

When you are studying the Croft Library of Practical Electricity, you are studying electricity as experts know it. You are acquainting yourself with the methods employed by the highest paid electrical workers and engineers in America.

This Library of eight volumes sent to you FREE for 10 days' trial

So positive are we that you will be pleased with the Croft Library of Practical Electricity that we offer to send the entire ten volumes for ten days' free use. All you need do in order to have the books sent, charges prepaid, is to fill out the attached coupon and return to us. Keep the books ten full days. Then if you are not satisfied, return them at our expense. On the other hand, if you find that they will help you, as they are helping thousands of others, send us the small sum of \$2 per month for eight months.

McGraw-Hill Book Co., Inc. 239 W. 39th St. NEW YORK

- 8 Vols.
- Flexible binding
- Pocket size
- 3000 pages
- 2100 illustrations

A letter that means something to every man in America who is interested in electricity

McGraw-Hill Book Company, Inc., 239 West 39th Street, New York, N. Y. Gentlemen: In an attempt to express myself about CROFT'S NEW LIBRARY OF PRACTICAL ELECTRICITY, I have never seen and do not believe there was ever printed in the English language, a more comprehensive set of books. It is a library that is just as valuable to the novice as to the expert, because it is all practice.

Respectfully, GUY H. PEIFER, Chief, Doplax Silk Corporation, Hazleton, Pa.

McGraw-Hill Book Co., Inc.
239 West 39th Street, New York, N. Y.

ACT NOW

FREE EXAMINATION COUPON

Please send me the Library of Practical Electricity (shipping charges prepaid) for 10 days' free examination. If satisfactory, I will send \$2 in ten days and \$2 per month until \$16 has been paid. If not wanted I will send for return shipping instructions.

Name.....
Home Address.....
City and State.....
Name of Employer.....
His Address.....
Your Position.....

LIBRARY
SEP 28 1919
UNIVERSITY OF TORONTO

Electrical Experimenter

233 FULTON STREET, NEW YORK

Publish by Experimenter Publishing Company, Inc. (H. Gernsback, President; S. Gernsback, Treasurer;) 233 Fulton Street, New York

Vol. VI Whole No. 69

JANUARY, 1919

No. 9

SMOKE BARRAGE SAVES ESCAPING 'PLANE.....Front Cover	
From a painting by George Wall.	
AMERICAN DESTROYERS THROW DEPTH "BOMB BARRAGE"..... 605	
SOLAR ENGINE USES SUN'S ENERGY..... 607	
ELECTRIC DEATH TRAPS IN HUN'S RETREAT	
By H. Winfield Secor	608
SUBMARINES IN PEACE TIME—WHAT TO DO WITH SUR-	
RENDERED U-BOATS..... 610	
TELEPHONING FROM MOVING TRAINS..... 610	
SMOKE BARRAGE SAVES ESCAPING 'PLANE..... 612	
"THE LONG DASH"—A WIRELESS GUN SHOW..... 613	
AN ALL-ELECTRIC HOT AIR BALLOON..... 614	
THE CITY OF SPLENDID NIGHT.....By Amos Stote	615
"ODD PHOTO" PRIZE CONTEST—A GALAXY OF WORLD-	
BEATERS..... 616	
ELECTRICAL DENTAL AUTO FOR UPTON SOLDIERS..... 617	
NEW BRITISH 'PLANE COASTS 20 MILES TO SAFETY..... 617	
NEW FLASHLIGHT CUTS OFF AFTER ONE MINUTE..... 618	
FOOLING THE DRAFT BOARD?—IT CAN'T BE DONE..... 618	
WINTERTIME USES FOR ELECTRIC FANS..By Pauline Ginsberg	619
POPULAR ASTRONOMY—GIANT JUPITER AND HIS NINE	
MOONS.....By Isabel M. Lewis	620
NIKOLA TESLA TO WRITE "MY INVENTIONS" FOR "ELEC-	
TRICAL EXPERIMENTER" READERS..... 622	
NEW PROPOSED WIRELESS BILL AND DISCUSSION..... 624	
EXPERIMENTAL PHYSICS—ELECTRICAL CONDUCTION	
THRU GASES.....By John J. Furia, A.B., M.A.	626
MY RADIO "STATIC ELIMINATOR".....By Dr. Nikola Tesla	627
RADIOTELEPHONE GUIDED U. S. FLYERS MANY MILES	
AWAY..... 629	
THE MANUFACTURE OF VACUUM DETECTORS.	
By O. B. Moorehead.	630
A VERTICAL CABINET TYPE COUPLER..By Joseph H. Kraus, Jr.	631
BUILDING A 3-INCH SPARK STATIC MACHINE.	
By Dr. E. Bade	633
A 25-INCH MODEL GYRO-ELECTRIC DESTROYER—HOW I	
BUILT IT..... 634	
EXPERIMENTS IN RADIO-ACTIVITY—PART I—IONIZATION.	636
EXPERIMENTAL MECHANICS—LESSON IX. By Samuel D. Cohen	637



EDITORIAL

Electric Music

THERE are many different ways of producing music, and as our culture advances the desire for better and still better music becomes a craving of civilization. From the ancient tom-tom to a Stradivarius violin is a long cry, and the chances are that as our musical tastes become more refined, still better instruments will become necessary and highly desirable.

There are few instruments giving a more mellow and a more "human" sound and quality of tone than a fine violin, but we have no hesitancy in saying that it should be possible to obtain still better results by electrical means. The field of purely electrical music has hardly been touched. Some years ago an American inventor produced the Telharmonium. This was one of the earliest and best attempts at pure electrical music. The Telharmonium was invented by Dr. Thaddeus Cahill and he used alternating current generators, each of a certain frequency; if a telephone receiver were connected in the circuit, the latter would give forth a certain very pure note. By using a switchboard arranged in the form of an organ keyboard, wonderful musical effects were produced.

Another more recent attempt was the pure electrical music discovered thru researches of Dr. Lee de Forest. He used his audion bulbs in connection with a telephone receiver, and obtained beautiful flute-like tones of the greatest purity. The two devices just described necessitated the use of a telephone receiver to translate the electrical impulses into sonorous vibrations, and this is a great disadvantage, for it ties us to a thin diafram, which in itself cannot produce the very purest tones obtainable. As one can readily understand, the limita-

tions of a diafram are very great and while it is possible to obtain a single pure note, it is a different matter where several pure notes in different octaves are to be reproduced simultaneously.

A way out is suggested by the writer by pressing into service the thermo-telephone which employs no diafram at all, but uses a very fine platinum wire of microscopic cross-section. This platinum wire, heating and cooling in unison with the electrical vibrations, impress upon it imparts these impulses to the surrounding air. With this device very pure electrical music can be obtained.

There should be of course many other ways to actually produce pure electrical music, and here is a wonderful opportunity for experimenters and inventors. To the writer's mind, it seems not at all impossible that we should take a metallic wire stretched taut and by impressing an electric current upon it, vary its heating and cooling effects so as to produce pure sounds in a suitable receiver such as a thermo-telephone.

Dr. de Forest has shown us that beautiful music can be produced in a vacuum tube. Paradoxical as it seems, this nevertheless is a fact. There must be many other ways of producing vibrations in a vacuum tube which can be translated into an electrical current, thus producing music.

There are also certain ways of making electromagnets produce music—this without the adjunct of telephone receivers,—by vibrating their entire structure. Many other means will undoubtedly suggest themselves to our students and scientists.

H. GERNSBACK.

The ELECTRICAL EXPERIMENTER is published on the 15th of each month at 233 Fulton Street, New York. There are 12 numbers per year. Subscription price is \$2.00 a year in U. S. and possessions. Canada and foreign countries, \$2.50 a year. U. S. coin as well as U. S. stamps accepted (no foreign coins or stamps). Single copies, 20 cents each. A sample copy will be sent gratis on request. Checks and money orders should be drawn to order of EXPERIMENTER PUBLISHING CO., INC. If you change your address notify us promptly. In order that copies are not miscarried or lost. A green wrapper indicates expiration. No copies sent after expiration.

All communications and contributions to this journal should be addressed to: Editor, ELECTRICAL EXPERIMENTER, 233 Fulton Street, New York. Unaccepted contribu-

tions cannot be returned unless full postage has been included. ALL accepted contributions are paid for on publication. A special rate is paid for novel experiments; good photographs accompanying them are highly desirable.

ELECTRICAL EXPERIMENTER. Monthly. Entered as second-class matter at the New York Post Office under Act of Congress of March 3, 1879. Title registered U. S. Patent Office. Copyright, 1918, by E. P. Co., Inc., New York. The Contents of this magazine are copyrighted and must not be reproduced without giving full credit to the publication.

The ELECTRICAL EXPERIMENTER is for sale at all newsstands in the United States and Canada; also at Brentano's, 37 Avenue de l'Opera, Paris.

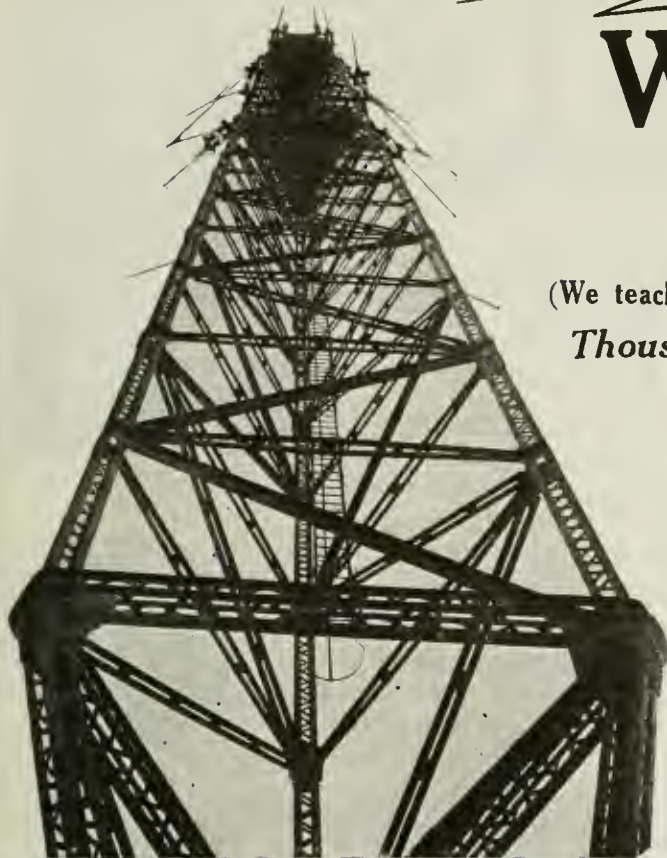

One of the giant wireless towers which keeps us in constant communication with Europe.

Wireless in Ten Weeks

(We teach you in your own home during your spare time)

Thousands of operators needed for America's Merchant Marine

The age of wireless is here. The experimental stage has passed. Wireless now equals in importance telegraphy, and telephony. It has assumed its place among the great commercial industries of the earth. So rapid has been the development and growth of wireless in recent years that there has been left in its wake a tremendous shortage of operators. Actually thousands upon thousands are now needed for permanent "peace time" positions offering wonderful opportunities for advancement.

Earn up to \$200 per month

In the short period of ten weeks we can make of you a wireless operator, a man with a profession, independent, and not subject to the rise and fall of wages in the labor market. Salaries are as high as \$200 per month. There is a position in the merchant marine, the army, the navy, or a land station, awaiting everyone completing our course. We give you this training at home, by mail, in your spare time. It is not necessary for you to lose any time from your work to take the course.

Free Instruments—

To every student enrolling with us we present a standard set of instruments with which wireless messages may be sent and received.

Travel the world over or locate at a land station in America.

America is spending billions of dollars on the mightiest navy and merchant marine in the world. Practically all vessels are being equipped with wireless apparatus of the most up to date type. Thousands of operators are needed now. The field affords a wonderful opportunity for the man who starts now to master wireless.

Our students actually pass the commercial examination in ten weeks or less.

Get your instruction from the Nation's Capitol. Our course is endorsed by officials of the U. S. Government.

The National Radio Institute, headed by authorities who have been closely allied with governmental training of students, has perfected an easily mastered course in wireless telegraphy whereby students are taught completely in ten weeks, either here in Washington at our large residence school or at home, by mail. Many of our students are ready to take up actual wireless work in much less time. The course is founded on actual practice, hence the rapid progress of the student.

NATIONAL RADIO INSTITUTE

Dept. 67

14th and U Streets, N. W. Washington, D. C.



A Valuable Book Free

Our booklet, "WIRELESS, the Opportunity of the Age," gives you complete information in regard to our course, the quick and easy methods by which you can master wireless, and other important facts you should know. It is free. Just mail the coupon. No obligation whatever on your part.

FREE COUPON

NATIONAL RADIO INSTITUTE,
Dept. 67, Washington, D. C.

Send me, free of charge, your booklet "Wireless, the Opportunity of the Age," with full particulars regarding your famous 10 weeks' Home Study Course, and your Special Free Instruments Offer.

Name
Address
Town State

ELECTRICITY

Learn
in
New York

Master Electricity By Actual Practice

Learn
by
Doing

The only way you can become an expert is by doing the very work under competent instructors, which you will be called upon to do later on. In other words, *learn by doing*. That is the method of the New York Electrical School.

Five minutes of actual practice properly directed is worth more to a man than years and years of book study. Indeed, Actual Practice is the only training of value, and graduates of New York Electrical School have proved themselves to be the only men that are fully qualified to satisfy EVERY demand of the Electrical Profession.



DIRECT CURRENT PRACTICE



WIRELESS TELEGRAPHY



ALTERNATING CURRENT PRACTICE



ELECTRICAL DRAFTING



ELECTRICAL REPAIRS

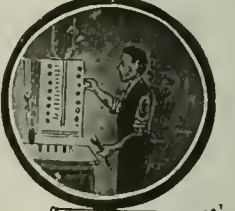

TELEPHONE INSTALLATION

The Oldest and Only Institution of the Kind in America

At this "Learn by Doing" School a man acquires the art of Electrical Drafting; the best business method and experience in Electrical Contracting, together with the skill to install, operate and maintain all systems for producing, transmitting and using electricity. A school for Old and Young. Individual instruction.

Over 5,000 Students now holding Successful Positions in the Electrical World

5,000 of our students are today successful electricians.

No previous knowledge of electricity, mechanics or mathematics is necessary to take this electrical course. You can begin the course now and by steady application prepare yourself in a short time. You will be taught by practical electrical experts with actual apparatus, under actual conditions.

Let us explain this course to you in person. If you can't call, send now for 64-page book—it's FREE to you.

New York Electrical School

29 West 17th St., New York



TEST BOARD



ARMATURE WINDING



ELECTRO-MECHANICAL ENGINEERING



ESTIMATING & CONTRACTING

New York Electrical School,
29 W. 17th St., New York, N. Y.

Please send FREE and without obligation to me your 64-page book.

Name

Address



ILLUMINATING ENGINEERING



MACHINE SHOP



STORAGE BATTERY SYSTEM



ELECTRIC VEHICLE CONTROL

You benefit by mentioning the "Electrical Experimenter" when writing to advertisers.



American Destroyers Throw "Depth Bomb Barrage"

AN American destroyer, with her depth bombs ready to be discharged, is a dangerous craft. Running without lights in the darkness she is a menace not only to the enemy but to herself and other ships should a collision occur.

The arrangement of the American destroyer's depth bomb armament that struck terror into the heart of German submarine commanders is shown in the accompanying illustration. These depth charges are dangerous to a submarine, even if they are 500 to 1200 feet away from the

square inch for every foot of head or depth. Thus for 1 foot depth the hydrostatic pressure acting on the shell, and also the diafram, would be .433 lb. for every sq. in. of surface area. For a depth of 20 ft. the water-pressure per sq. in. would be 8.6 lb.; for 50 ft. depth, 21.6 lb., and

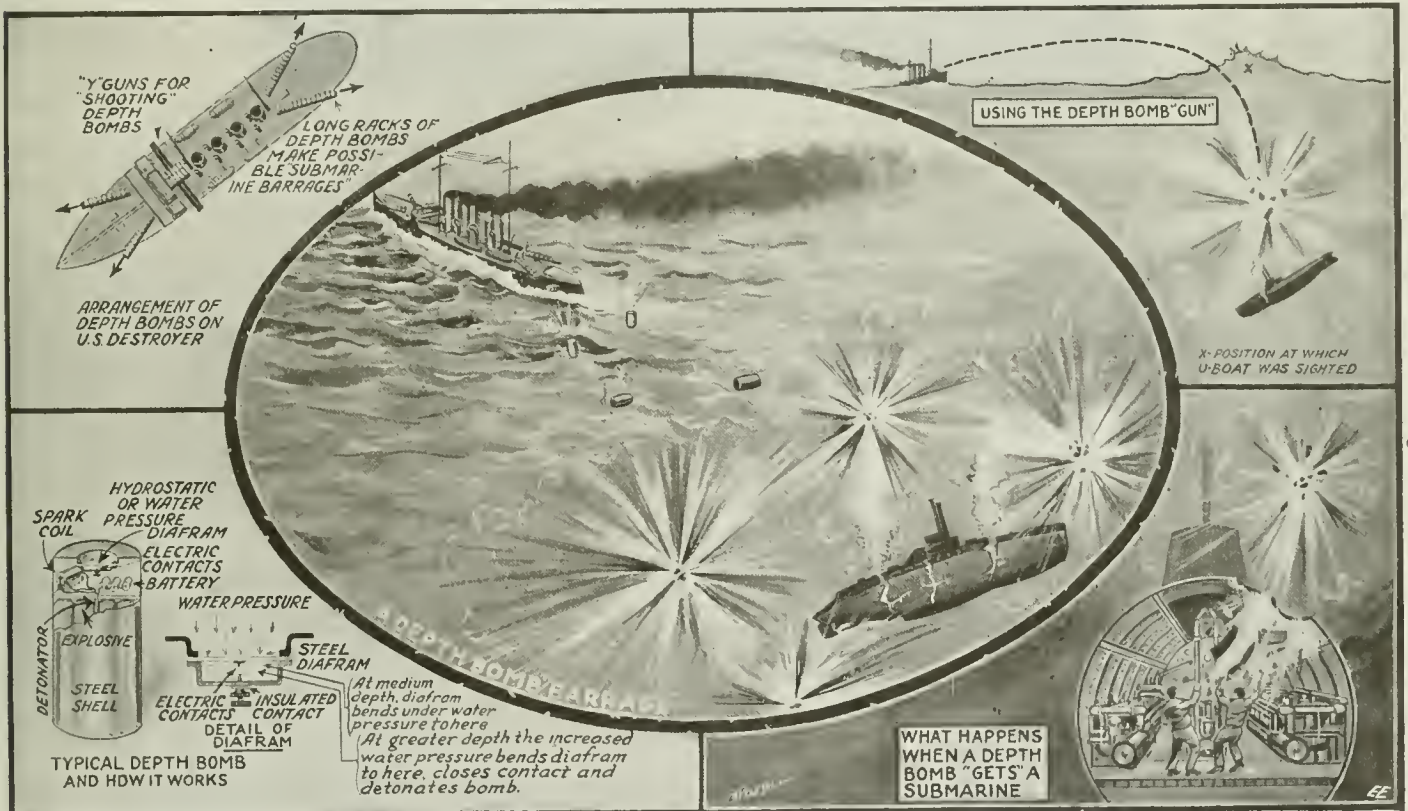

Copyright, 1918, by E. P. Co.

U. S. Destroyers Have Greatly Profited By Actual War Experience, for They Became So Proficient in the Use of the "Depth Bomb"—a Wonderful New Weapon in Itself—That They Could Set Up a Veritable "Sub-aqueous Barrage." Also They Can "Shoot" Depth Bombs for a Distance of One-half Mile or More. Unlike Shells They Do Not Ricochet or Slip, But Penetrate the Water to a Certain Depth and Then Explode.

The bombs are now released from every quarter of the destroyer. Two can be dropped from the bridge by pressure of a button; "Y guns," amidships, with two barrels, can throw bombs to port or starboard; astern there are two long lines of bombs running on miniature railway tracks, so a complete *barrage* may be fired at any

point where the subaqueous explosion occurs.

The detail view herewith of one of these depth bombs shows clearly the principle upon which they operate. The steel tank container is a simple affair, fitted with a sensitive water-pressure diafram. The pressure of the water increases .433 lb. per

for 100 ft. depth, 43.3 lb. per sq. in. Hence it is clear how it becomes possible to "set" the diafram of the detonating device, whether electrical or mechanical, to trip off the latter at any desired depth. The farther the contact pin, or trip finger, is set back or away from the diafram, the greater the water-pressure or depth required to press it in that far.

AND NOW THE ELECTRICIAN-ETTE!

We have conductorettes, female bartenders, police women, elevator operators, usherettes and farmerettes, but this is the first instance of its kind where we are having an electricianette.

Mrs. Ada B. Vail of the Atlantic City Electric Company, Atlantic City, New Jersey, has complete charge of an installation of sixty-five electric ranges in one apartment house located at the above address. She is responsible for the proper maintenance and operation of the entire equipment of these stoves and handles her position capably. Beside, she takes care of some thirty-five odd electric stoves thru-out the city. In all, she supervises one hundred of these intricate electrical devices.

Her entire tool kit can be summed up into a testing lamp, screw driver and two pair of pliers, one large and one small. Compare this neat and compact equipment that most certainly reflects the characteristics of a woman as its owner, with the modest (?) tool chest of the male species of electrician and the carrying of a large assortment of unnecessary junk, approximating one-half ton in weight, and when he finds that the job will require a screw driver one-sixteenth of an inch smaller in size, we would be asking too much if we should expect him to use one of the next size. Instead he takes an afternoon's vacation on your time, going to the movies or to Coney Island, or Kalamazoo, as far as we know, and by the length of time that he consumes to get this tool.

Can you imagine upon arising from your warm bed on a cold Winter morning, making a quick dash to the electric stove in the

sitting room, turning on the switch, and in anticipation of the warmth that you are to get, you find the electric stove is as cold as a chunk of ice. The heat of your indignations warms you thoroly, and you make

attired young lady, in *over-alls*. Taken back with this surprise, you ask her what she desires. "Oh, Sir," says she, "I am the *electrician!* You sent a call for me, and I am here to repair your heater." Her intention is very agreeable to you, and with military precision she brushes past you, takes off the top of the heater, yanks out the heating elements, mutters a monosyllable that sounds like "burnt out," inserts a new unit, attaches another fuse, turns the switch, and the job is finished. It has taken her exactly ten minutes, and the most incredible part of it, when you ask her the charges, and receive a reply, "Oh, that is all right, sir, I am paid by the firm that owns the building." She goes out closing the door very gently, and without even looking for a tip.

Cheer up, fellows, it will be a great old world after the fair sex take our jobs. We will have nothing to worry about except washing the dishes and scrubbing the floor.



Photo Courtesy Edison Electric Illuminating Co. of Boston

Yes, the "Electricianettes" Are Here! The Present Photo Shows Them Hard at Work at One of the Dynamo Switch-Boards of the Boston Edison Company

one grand dive for the telephone. After you have stood there for about a half hour with your teeth chattering, waiting for the telephone boy in the hall below to answer your call, you are finally rewarded for your patience by being allowed the honor to speak with the janitor. After you have told him what you thought of him and his entire family, back to his great, great, great grandfather, he very sweetly answers with a roar like the Kaiser; and tells you that your need will be attended to.

Within a few seconds you hear a short staccato knock upon the door, and upon opening it you are almost stricken speechless by the appearance of a very neat and chicly

WORLD RADIO SYSTEM URGED FOR SOCIALISTS.

Active steps are being taken by the International Socialist movement to establish a private system of wireless thruout the world. Five installations are now definitely projected. Stations will be immediately set up in England, France, Belgium and ultimately in other countries, including America.

Three of the new stations will link up with the German and possibly the Russian Socialist wireless. They will be used to connect Socialist organs in various countries.

In collision there is no danger of the shock exploding the bomb, but some might be thrown into the water and explode when at the proper depth.

And this is not all of the Depth Bomb's story, either. Did you ever hear of the depth bomb "gun"? It shoots depth bombs accurately for a distance of half a mile or more. The merchant ships that dodged the U-boats were equipt with such guns, which operate with compressed air, similar to the well-known torpedo tube. The illustration shows how the depth bomb gun is sighted to drop the bomb just at the point where it will complete its trajectory thru the water and explode near the enemy submarine, which has submerged and is sneaking off, or trying to.

Imagine also the effect of a subaqueous barrage on the enemy subsea fighters. Talk about land barrage fire! The water transmits the noise and vibrations from the exploding depth bomb many times better than

in the air. Cases have been known where a submarine's plates have been dented in and the seams started at a distance of nearly one-half mile. The concussive wave transmitted thru the water is exceedingly powerful because, for one reason, water is practically incompressible.

Remembering that stores of mutinies in the German naval ports first gave clear intimations that Germany's military machine was breaking down, it is not surprising that the revolutionary movement first should have assumed serious form among the sailors. And according to the current reports, the terrible hardships and the ghastly number of fatalities among the U-boat crews are what started the final fatal break in discipline and morale.

It can be said, therefore, with some approximation to truth, that not only did unrestricted undersea warfare hasten and make certain the defeat of Germany by bringing into the war the American land

and water forces needed to turn the scale against her, but it was the thing which, working from the other side, added speed to the downfall of the Kaiser's hopes and his empire. The fears and the despairs which the submarines could not create in the minds of the Allies they did create in those of the men who had been ordered to commit the atrocious crimes by which the world was shocked.

They did what they were told to do, but the task proved too much for even their docility, and they rebelled against it at last, not, however, so far as any evidence yet presented has shown, because of indignation against the orders received, but because the execution of those orders so often meant for them the fate of drowning rats. Too many of the U-boats that went out did not return, and the mystery of their fate was intolerable to the survivors.



Some Day in the Near Future We Shall Undoubtedly See Hundreds of These Solar Energy Plants Sprinkled Over the Country. This Large Plant is in Texas. The Mirrors Reflect the Sun's Rays Onto Special Boilers, the Steam Produced Running a Steam Engine, Connected to a Dynamo. Current From the Dynamo Runs a Motor Pump Which Lifts Water to a Height of Sixty Feet.

Solar Engine Uses Sun's Energy

SIX thousand degrees Centigrade is the computed temperature of the sun. Its light giving power is equal to 27,000,000,000 candlepower, a quarter of a mile away. Scientists tell us that only the 2,735-millionth part of the total energy radiated from the sun reaches our earth, but if this were ever caused to stop for any reason our planet would turn into a dead, frigid ball of rock; the present average annual temperature of 13° C., would change, without the heat of the sun, to 73° C., of frost, it is calculated.

Experiments show that the power of the atmosphere to trap heat is largely due to the water vapor that it contains. It is also due to some extent, to the carbon dioxide gas that is one of its minor constituents, points out Prof. Garrett P. Serviss. Carbon dioxide is a remarkable heat retainer, but there is only a very small quantity of it in the air compared with the vast bulk of the atmosphere. It only amounts to about 3/100 of 1 per cent. But there is this significant fact about it, viz., that its amount is variable, to a slight degree at the present time, while there is evidence from past geological history that once it was vastly more abundant than it is now.

Now, how much carbon dioxide must the air gain in order that a perceptible effect on the temperature may be produced? Arrhenius answers this question for us. He says that if all the carbon dioxide now in the air were removed, the average temperature would fall nearly 38 degrees Fahrenheit. On the other hand, if the present amount were doubled the temperature would rise more than 7 degrees, and if it were quadrupled the rise would amount to nearly 14½ degrees which would be far more than enough to banish all the glacial suffering that we had to endure last winter. Even

the smaller amount of increase (7 degrees) would probably suffice for that.

These facts are very interesting from a technical point of view, indeed. The practical aspect of solar energy lies at present in the hands of those who are endeavoring to perfect a solar motor—i.e., an engine or electric generating device which, when the sun's rays strike it, will develop steam to operate a steam engine, or electricity to charge electric accumulators or storage batteries. Those interested in this branch of science will find of great interest several articles which have appeared in back numbers of this journal.*

Considering later developments of a practical nature in the line of solar engines and boilers, we may take up the work of Mr. Shuman, of Philadelphia, Pa., who later collaborated with a Mr. Boys, of England. They were able in their final developments to operate a 100 horsepower engine by means of solar energy. This plant was built at Meadi on the Nile, Egypt. Prior to this excellent work, however, we may consider briefly the early solar engines developed and tried out at Philadelphia, Pa., by Frank Shuman, upon which work he started in 1906. One of these solar engine plants installed in

*The Utilization of the Sun's Energy—by H. W. Secor, March, 1916, issue; page 605.

Electricity Direct from Sunlight—The photo-electric cell. September, 1916, issue; page 316.

Volcano-Electric Plant in Italy Develops 15,000 H.P., March, 1917, issue; page 789.

Texas being illustrated herewith. The heat of the sun's rays strikes a large number of mirrors, which reflect the heat to special boilers. These produce steam to run an engine, the latter operating an electric dynamo. The current thus produced was capable of operating an electric motor pump which pumped water to a height of 60 feet above the ground.

Mr. Shuman had running at Tacony, Pa., a practical plant of this type, which developed about 3½ horsepower by using 1,200 square feet of sunshine that was allowed to fall on a fixed horizontal water box. This box was fitted with a glass top and a series of parallel horizontal black pipes were immersed in the water. These pipes, containing ether, exposed 900 square feet of surface to the solar radiation. The water also became heated and carried the heat to the underside of the pipes, thus realizing a greater efficiency. The ether boiled and its "steam" drove a small vertical, single cylinder engine. The exhaust ether vapor past into an air surface condenser and the liquid ether from this was pumped back into the tubes of the sun boiler. It was found that this plant worked well even with snow on the ground, which is explainable from the fact that the permeability of the atmosphere is about 20 per cent. greater in winter than in summer.

Further tests and refinements to the Tacony plant by Mr. Shuman resulted in 1911 in an engine and boiler which showed considerable strides forward in their design, the ratio of 245 square feet of sunshine per one brake horsepower having been attained.

It may be mentioned here that the pipes constituting the sun boilers have invariably been blackened. For low temperatures lamp-black has been used as the absorber, but where high temperatures were required platinum black was used.

(Continued on page 672)

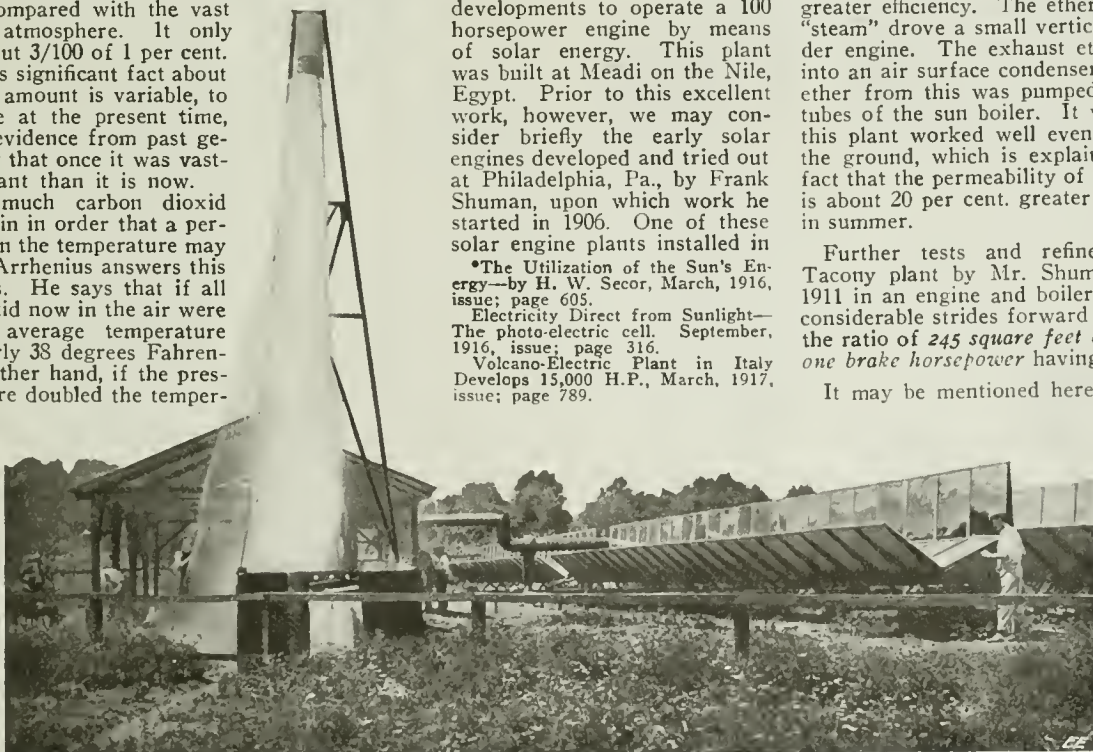

Here We See the Sixty Foot Stream of Water, Discharging. The Electric Power to Pump This Stream of Water is All Furnished By the Mirrors Which Gather and Reflect the Sun's Rays Onto Special Boilers.

Photos (C) by International Feature Service.

Electric Death Traps in Hun's Retreat

By H. WINFIELD SECOR

IF you have any doubt that the Teuton is possess of a cunning mind, then you have but to read the reports that have come back to us every now and then from various reliable sources on the battle-fields of Europe, where the Allied troops have always had to contend with multifarious and indescribable forms of deadly and inhuman offensive schemes, such as liquid fire and gas, which horribly mutilates and disfigures its victims in thousands of cases. The Allies were never sure of what they might expect when they advanced on enemy territory. The Huns resorted to every possible underhand scheme their wily brains could think of in a desperate effort to spread terror among the Allied soldiers, and some of the despicable "traps" they have used, not to mention hundreds of others which we have not the space here to describe, are illustrated herewith.

Fig. 1 shows how the Germans often mined the town pump, or any other pumps on which they could operate, so that when a thirsty Allied soldier endeavored to draw some water, he would be instantly killed by a charge of explosive set off by an electric contact and battery inside the pump, the fuse circuit being closed on the first downward stroke of the pump handle. Of course, hundreds of mechanical traps were used, as well as electrical ones. The electric trap which has been extensively used in these operations is a simple affair, and comprises nothing more than a small dry or other battery, together with a pair of electric contacts arranged to be closed by the movement of some piece of furniture, et cetera, and a piece of fine fuse wire which is placed in the explosive. When the circuit is closed, the fine piece of wire melts, and the heat produced detonates the explosive. Some times the contacts are caused to close a battery circuit thru a spark coil, the secondary circuit of which is connected up with a spark plug, buried in the explosive. There are, of course, numerous other schemes, many of them having been provided with time clocks or switches, for delaying the explosion, as the official reports have frequently indicated.

The open fire place, which is ever a source of welcome to the footsore Doughboys when they have a chance to stop in a captured town, is not always the most healthy place in the world, for as Fig. 2 shows, it may contain a high explosive shell planted within the fire wall, so that when a good fire is kindled on the hearth the shell will be caused to explode, very possibly killing all those within the room.

Fig. 3 illustrates how the retreating Germans often left a trap for the conquering troops of the enemy by placing high explosive mines under the trails of cannon and machine guns, so that as soon as anyone moved the cannon carriage, the spring actuated pin of the mine would spring up and detonate the explosive, thereby possibly killing several men.

One of the cleverest, altho hellish, tricks ever played by the retreating Teutonic hosts probably is that of the "wireless bomb." Fig. 4 shows this trap in action, and the story of its operation is as follows: Before the enemy retreated, he took care to place a number of wirelessly operated bombs in the walls or possibly under the floor of various dwellings and other buildings, so that in the event the victorious troops as they entered the town or locality, might set up a wireless set in proximity to

one of the bombs, the first spark would cause the bomb to explode with death-dealing violence. The bomb in this case is detonated by an electric fuse or spark circuit, actuated by a radio coherer and relay, or other similar radio receptor apparatus.

"Say, Hen," sang out a jolly faced Doughboy to one of his "buddies," as they sat about a table enjoying the mid-day meal of "Boston baked" and canned sardines a la Rhine in an old French chateau, "there's a telephone on the wall, why don't you call up your best girl," and full of Yankee play spirit the Doughboy arose. But something seemed to tell him not to touch the telephone instrument, and it was well that he did not; for one of the party, who had been cautioned by the intelligence officers to be extremely careful of touching anything in the captured territory until it had been carefully examined ascertained that the telephone instrument contained several pounds of explosive which was connected up with an electrical igniter attached to the switch-hook, so that as soon as the receiver was lifted from the hook, the explosive would

In Fig. 7 there is shown the famous German "watch trick." This trick used to be pulled quite often at various points along the battle-line until the Allied troops got so skittish of all such devices that they would not touch anything with their hands, but would poke it with a stick, which invariably caused one of these death-dealing traps to explode harmlessly. In the watch trick, a favorite setting was in a trench or dug-out from which the Teutons had been forced to retire, and when the Allied soldiers had taken the trench, one of them would probably be surprised to see a perfectly good watch hanging on a nail or stick projecting from the trench wall and ticking away merrily. Now who would refuse to take such a watch? But many a brave soldier has undoubtedly lost his life by thinking just that way, and the moment the watch was removed from the nail or other projection from which it hung, this act caused a high explosive trap to detonate.

And the churches—what haven't the Teutonic sons of the mailed fist done to these! One case which happened in Belgium comes to mind where a number of Allied soldiers were endeavoring to hold church in a captured town. The priest had no sooner started to ascend the steps of the altar, when a terrific explosion occurred, which demolished the altar and seriously wounded the preacher. This trap utilized an electric contact spring arranged under the step, the riser of one of the steps being cut away so that when a person's weight rested on the tread, it would force it down a slight distance, closing a contact which detonated the bomb. See Fig. 8.

One of the most heinous and criminal death-dealing devices ever planted by the retreating Huns was recently witnessed in actual operation by a New York soldier who came home not many months ago. To start with, the soldier who related this tale was a member of a Company which had been marching for several days, and one night when they prepared to rest and get some sleep they discovered a large cave. See Fig. 9. Naturally, unless the weather is quite warm, anyone would rather sleep in a cave than out in the open, for obvious reasons. And so they went to sleep, but long before morning several of the men awoke and were surprised to smell gas fumes, and, what was more astonishing, a large number of the men who were sleeping in the cave were found to be "gast." Those who had awakened, and who were not totally overcome by the gas, at once removed the gast men from the cave and started to investigate, as no fumes of gas had been noticed whatsoever on the previous evening when they had found the cave. "Dirty work, sure enough," said the Sergeant, as he and two of his men started back in the cave to find out what kind of a new trap the crafty Huns had concocted; before long they discovered it, planted several feet below the earth in the rear of the cave, and with a small gas tube leading up to the surface of the ground. They dug up the infernal machine, and were astounded to find that not only did the box contain a small gas generator with a time-clock arrangement rigged up to a valve on it, so that gas would be generated and sent into the cave at a certain pre-arranged hour, but that also there was a sufficiently large quantity of high explosive in the container

(Continued on page 669)

DON'T MISS THESE ARTICLES IN FEBRUARY "E. E."

"My Inventions"—No. 1 of a series especially written for the ELECTRICAL EXPERIMENTER by Dr. Nikola Tesla himself.

"Cold Light!—What it is and is not," by Rogers D. Rusk, B.Sc.

"Subways of New York"—A wonderfully complete panorama of the underground, surface and elevated systems. An interesting and instructive article.

"How Jimmy Saved the Bank"—A story that will surprise you, by F. W. Russel.

"The Unknown Purple"—A 20th Century drama of Ultra-Science and Psychology.

New Electrical and Wireless "Movie" Stunts.

The "Alkaline" Storage Battery—Its Operation and Maintenance, by J. F. Springer.

Experiments in Radio-activity, Part II, by Ivan Crawford.

Producing Ball Lightning in the Laboratory. With Excellent photos. by Samuel S. Weisiger, Jr.

Wood Finishing for the Amateur, by Arno A. Kluge.

Besides the usual "Constructor", "Wireless", "Chemistry", and "Machine Shop" Departments, and hundreds of other valuable, time-saving wrinkles, ideas and formulas.

be detonated, and so the story rolls on—backed by the facts. See Fig. 5.

Nor were the German dead allowed to rest in peace, for even after life had ceased in their bodies, they must serve the "Fatherland." This is true "Schrecklichkeit" efficiency to the Teutonic mind, if not to ours. So the crafty Teutons, when they were forced to retreat, got into the habit of planting small explosive traps under the dead bodies, with the hope in their hearts that when the on-marching Yankees or Poilus got on this territory and attempted to clear it up by lifting the dead bodies, they would meet with unexpected fatalities. See Fig. 6.

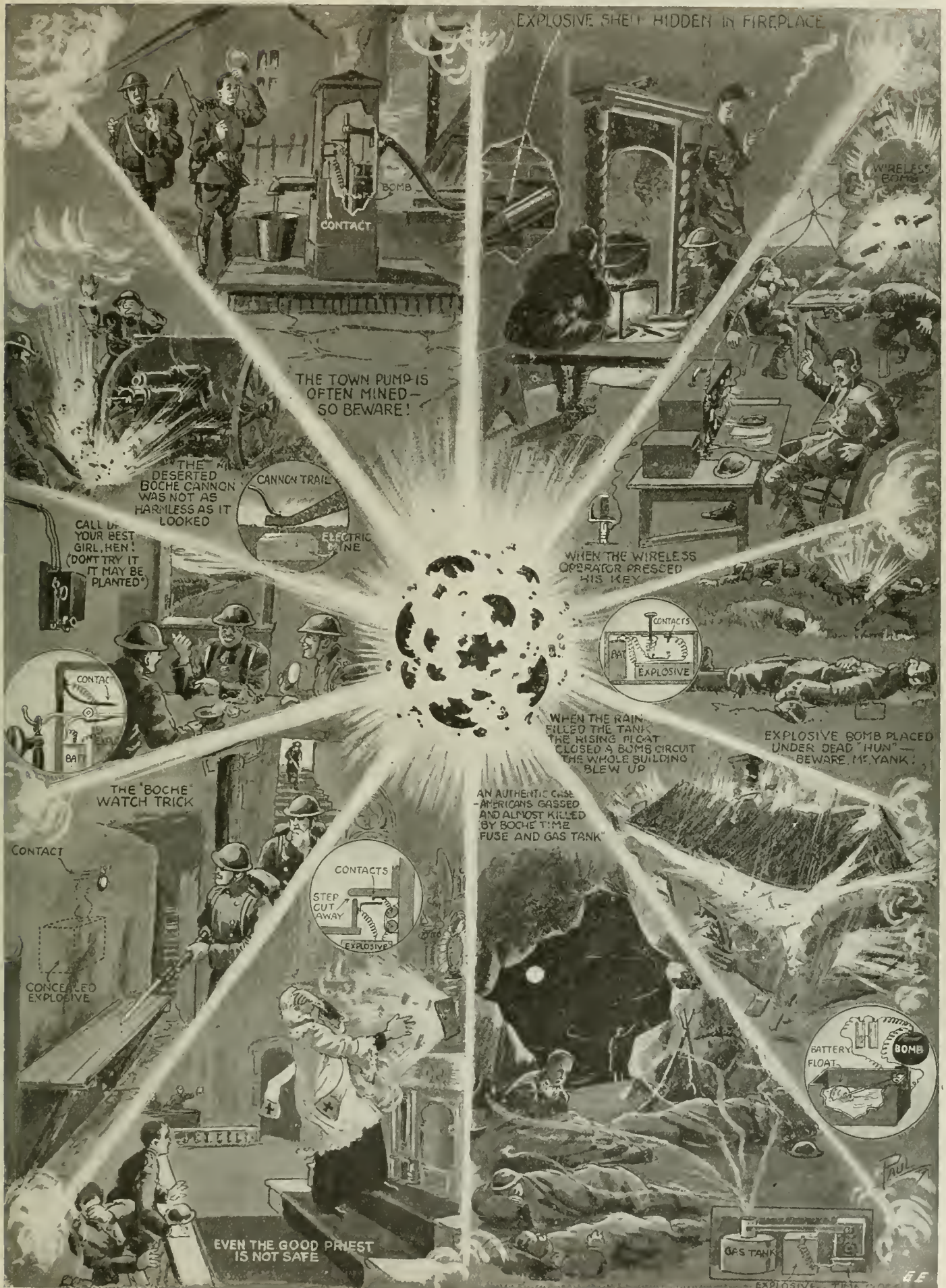

(For Description See Opposite Page)

Submarines in Peace-time

Now that the great world cataclysm is practically over, we have to think of many reconstruction problems, and one of these will undoubtedly have to do with many of the meritorious as well as military apparatus and devices which have been developed and built in unbelievable quantities. For one thing, there will be a superfluity of "submarines"—especially surrendered U-boats. A New York inventor, Mr. George Wall, has proposed and here illustrated a novel use for these superfluous submarines, namely, to utilize them as freight carriers, and not only to perform this service in the ordinary sense, as has been done when the giant submarine "Deutschland" crossed the Atlantic Ocean with a cargo, but to arrange for these submarines to pass thru a submarine tunnel for example. Let us consider, as Mr. Wall points out, the freight-handling problem at Manhattan Island, New York, where incoming steamers are un-

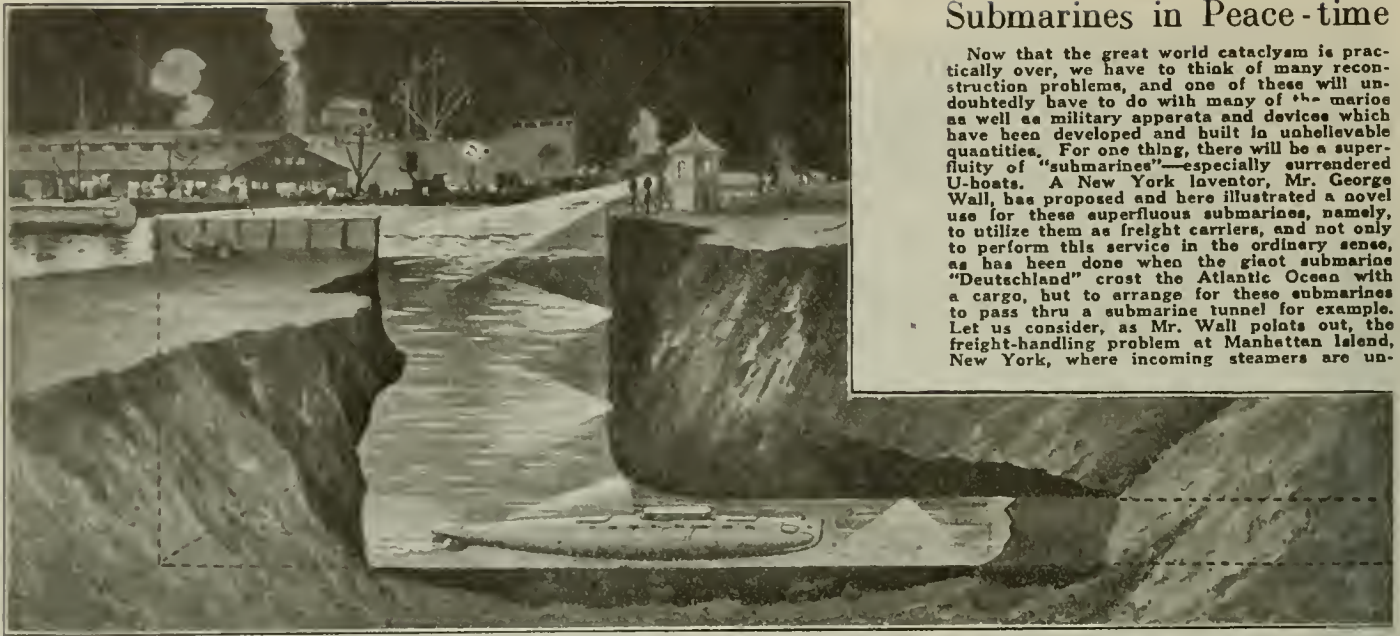

The Above Illustration Shows Mr. George Wall's Peace-Time Utilization of Germany's Surrendered U-boats, or Any Other Submarine Which May Be Scrapped by Uncle Sam or His Co-Allies as Being Unfit for Further Naval Use, but Which with a Little Overhauling Can Be Readily Put in Condition for Use as Freight Carriers. The Scheme Here Illustrated and Described Would Involve the Use of Electrically Operated Locks at Points on the North and East Rivers, If Used to Carry Freight Under New York City, and Also the Submarine Tunnel Would Be Illuminated with Powerful Electric Lights Placed in Sunken Reflectors, So as to Leave the Passage of the Tunnel Smooth and Even.

Telephoning To and From Moving Trains

THREE Americans residing in Toronto, Canada, Messrs. Isidor, Abraham and Samuel Berliner, have invented a moving train telephone apparatus for telephoning to and from trains en route, as depicted in the illustration. This apparatus permits voice transmission to be made automatically and directly thru the ordinary car wheel and axle, without the assistance of any contributing medium, by a special instrument connected to the wheel. Thus electrical

connection between the instrument and the rail is made thru the car wheels, and in combination with the ordinary rails properly bonded for the block-signal system, but it will work equally well on any track where the rails are similarly bonded, without regard to the absence or presence of a block-signal installation.

Telephonic speech or voice transmission is conducted thru the ordinary existing axle, thru the wheels and down to the rails, along which it runs and is picked up by

other moving trains or any of its desired joined cars, train dispatcher's offices, signal towers, stations, city exchanges, cities, towns, villages, hamlets, or with that of any regular telephone subscriber. This railroad telephone invention consists of an apparatus including standard equipment only comprising the well-known telephonic retardation or repeating coils, ordinary rolling stock of wheels and axle, requisite bearing instrument from which it is connected to the wheels, and the usual rails, properly bonded. This transmission and reception is carried on, it is claimed, without regard to the trains' speeds or of trains moving in the same direction, opposite directions, trains crossing over at right angles to another, or any other moving

positions. whether this be upon the same track as in the case of a double-track line, or between any tracks.

The control of the system differs in no respect from ordinary telephone operation, and artificial amplifiers requiring delicate adjustment are not employed. The invention now makes it possible for connection to be made between the train instrument and that of any regular telephone subscriber. Train speed is of no material consequence, for the same results are attained traveling 60 miles an hour as when barely moving.

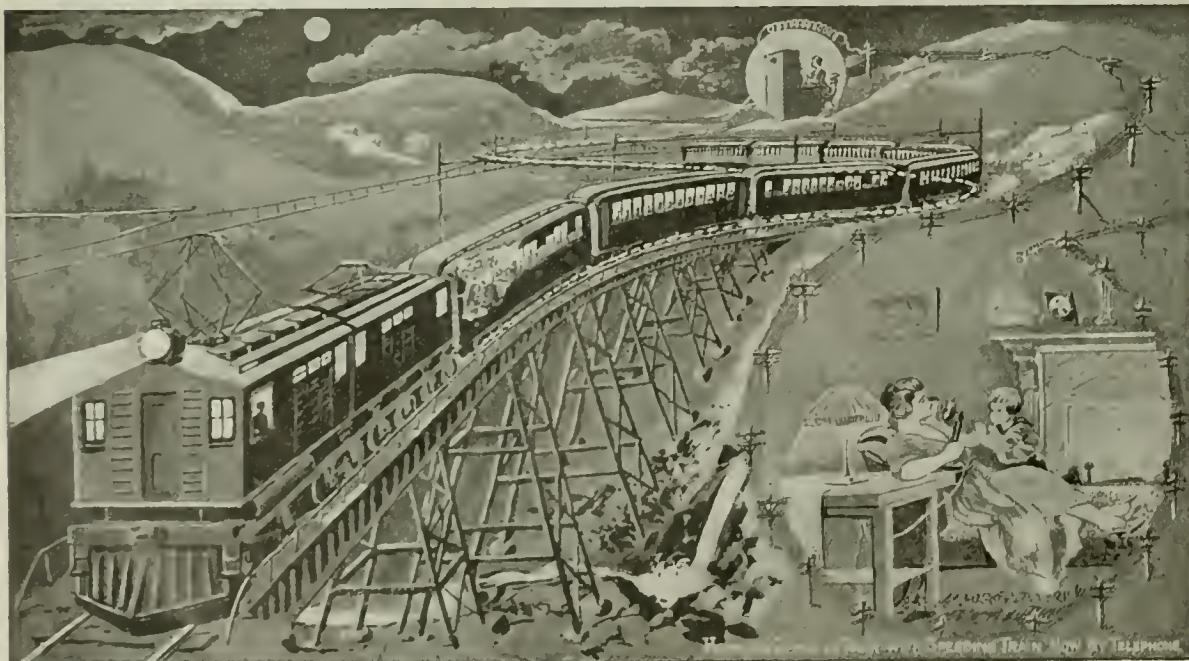

Telephoning Between a Moving Train, Irrespective of Its Speed, and Any Fixed Station, Office, or Home, is Now Possible—Thanks to a Recent Invention, Which Enables the Telephonic Currents to Travel Thru the Car Wheels and Along the Rails to the Nearest Telephone Exchange.

Submarines in Peace-time

loaded in some cases on the piers at the North River. This freight is frequently trans-shipt by auto-truck or otherwise to points directly across the city. In other words, the goods are often carried thru thickly congested streets over to the East River or in that vicinity. If we had a submarine channel bored thru the solid rock many feet below all of the present subways, it would provide a feasible and economical method of trans-shipping freight from the North to the East River and vice versa. As it is, goods are often shipt by auto-truck or across the city at considerable expense, or else by boat down the East River, around the Battery and up the North River. This is bound to be so, in some cases, owing to the fact that vessels frequently carry mixt shipments of goods. This scheme is undoubtedly feasible and economically applicable to many shipping localities in various other parts of the world.

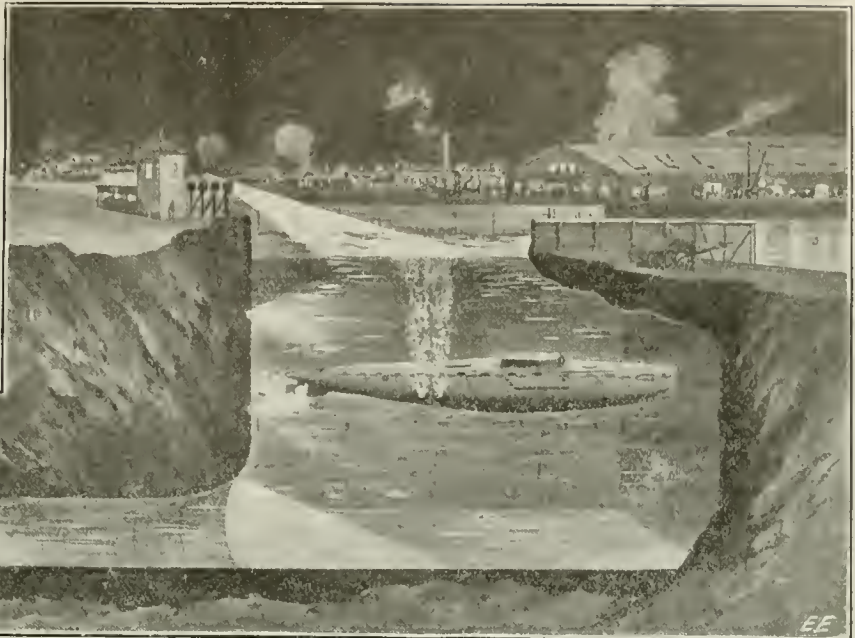

Copyright, 1918, by E. P. Co.

Thus "Subs" Could Be Economically and Efficiently Used, Which Would Be Applicable in Many Shipping Localities Thruout the World. Where a Great Deal of Shipping Would Have to Be Handled, There Would Be Employed Two Tunnels and Two Sets of Locks, the "Subs" Loading at Either Side of Large Piers to Which the Steamships Anchor. Very Little Handling of the Freight Would Be Necessary—Thanks to the Modern Electric Belt Conveyor and Other Systems. The Submarines Could Be Handled by a Small Crew and the Steering Bearings Taken by Observation Thru Large Glass Windows in the Superstructure of the Submarine.

This system also permits telephoning to be done from one end of a train to the other or to any part of the train. The conversation may be held as easily as from house to house. The tone of the voice is just as clear as with the telephone on a city circuit. One cannot tell that the train is moving, as far as the sound in the instrument is concerned, it is claimed.

A working model of a new moving train telephone apparatus has been very successfully demonstrated by the Canadian Government Railways on their road by Mr. W. W. MacFarlane of New York, who conducted the tests of his new invention, which was tested at Moncton, N. B., Canada, from July 16, 1917, to March 28, 1918, inclusive.

During these tests, which were very complete, the conversations were carried on between the moving train and the dispatcher's office in a clear and distinct manner.

The engine was cut off from the car and proceeded a mile down the track by orders telephoned from the conductor to the engineer. The engine was then stopt by telephone orders from the conductor, who was on the car, and instructed to come back and couple up again. Then an order was given by the conductor to back up the train and take on the flagman, who had gone back to flag.

Before backing up, a telephone message was sent to the dispatcher's office, asking if it was safe to back up, and the answer by telephone from the dispatcher was that this would be all right. After backing up to the flagman, the order was received from the dispatcher's office to go ahead to Humphrey's and cross over to the other track and come back to Moncton. Before reaching Humphrey's a second telephone message was received from the dispatcher countermanding the previous order to cross over, but to return to Moncton on the same track, as the train was protected from the rear.

All these instructions were transmitted by telephone from the dispatcher's office to the conductor on the car and by him transmitted to the engineer by telephone, while the car was running, showing that it is per-

fectly feasible to control a moving train by telephone from the dispatcher's office at a distant point. The invention is patented in the United States and Canada as well as in foreign countries. This new railroad telephone system promises to completely revolutionize modern railroading.

INDIAN PRINCESS LEARNS WIRELESS.

The accompanying photograph shows an Indian princess learning wireless telegraphy—Miss Emily Moran, descendant of a famous Indian chief. She promptly offered her services to her country in this national crisis, and is rapidly learning the art of radio operating so that she can graduate from clerical work to the wireless room of an ocean liner or possibly a transport.

Many young women have taken up wire-

less operating, several of the leading schools having classes at which young ladies attend. At the present time there has not been a very large opportunity to place these fair radio graduates, for the reason that the Navy Department controls all the wireless stations, and it is against their rules to have women in any government radio stations. However, there are many ways in which women trained as radio operators can help and have been helping. For one thing, they can be of considerable aid in helping to teach the soldier and sailor "rookies" the rudiments of radio operating—particularly the code, which is always a great stumbling block to most of them. Women should prove particularly efficient in teaching this part of the radio art, for they have proven themselves very adept and successful in imparting knowledge to students of all ages in our public schools thruout the country.



Photo from Paul Thompson

Here We See a Well-Known Indian Princess Learning the Wireless Code. She Is Miss Emily Moran, Descendant of a Famous Indian Chief.

A New Aërial Smoke Barrage

THE airplane has surely come into its own during the recent world war. Hundreds of 'planes were to be seen in the air on various sections of the great battle-front many times during the day, their glistening wings sparkling in the bright sunshine. Pursuer and pursued

hurtled thru the air at prodigious speeds. These airplane attacks looked all very tame from the ground until one of them closed in on his adversary, when many a spectacular battle was enacted. Perhaps one of the most spectacular of all aërial battles is that mentioned in a number of the interesting stories that have come to us from the lion-hearted fighters of the air, where an enemy 'plane has dropt out of a cloud, in order to pounce down and surprise an unsuspecting flier below. Some of the German aviators used to practise this trick regularly, sailing upward thousands of feet, only to suddenly disappear in a cloud or cloud bank. Then the crafty flier would suddenly dart out of a cloud at the side or at the bottom, and if a hostile 'plane happened to be anywhere in the vicinity, the factor of surprise would in practically all cases be on the side of the emerging war-'plane.

But clouds would not always be conveniently at hand for carrying on such maneuvers. There is not now, nor is there likely to be an international law on the conduct of aërial warfare to the effect that battle 'planes may not play hide and seek among the clouds if they choose to. Wherefore and hence, we have the latest invention in aërial warfare—the "airplane smoke producer"—the particular form of this invention here

illustrated and described being due to John Koltko, of Watertown, Connecticut.

As the front cover and accompanying views show, this invention enables an aviator to quickly send out a large quantity of heavy smoke which will entirely envelop the 'plane and prevent, or at least make it ex-

the air, but it would in a few minutes produce a long trailing cloud of black smoke, and it would indeed be quite difficult for an aviator to tell at exactly what point in this cloud the enemy 'plane was.

The technical details of this smoke-producing apparatus for aircraft are quite

simple and it operates as follows: A steel tank is mounted in the body of the 'plane with which there is connected a bypass pipe connecting with the exhaust of the engine. A suitable valve controlled from the pilot's seat is connected with this pipe, so that when it is desired to produce a smoke cloud to envelop the 'plane, it is only necessary to open the valve and allow the engine exhaust to pass into the tank. The tank contains certain chemicals which when acted upon by the gases from the motor exhaust, produce smoke rapidly in great volume.

As the illustration shows, the diffusing heads consisting of conically-shaped drums with perforated faces on them, are placed around various parts of the airplane, under the wings and along the fuselage.

THE MAGNETIC SURVEY VESSEL, "CARNEGIE."

The Magnetic Survey Vessel, *Carnegie*, arrived safely at her home port, Washington, D. C., a short time ago, where she was put out of commission during the period of the war. During her cruise from Buenos Aires, Argentina, round the Horn to Valparaiso, Chile, Callao, Peru, thence thru the Panama Canal to Newport News, she was in command of Dr. N. W. Edmonds and a number of other scientists of the Government staff.



Copyright, 1918, by E. P. Co.

Not Only Can the Naval Destroyers and Other Vessels Throw a Dense Smoke Screen, but the Battle-plane as Well. This Recently Perfected Invention Causes the Exhaust Gases from the Engine to Pass Into a Tank Containing Certain Chemicals, Which, When Thus Acted Upon, Produce a Dense Smoke in Great Quantities. The Smoke is Distributed Thru Diffuser Heads About the Planes.

tremely difficult for, an enemy 'plane to "plant" a good shot on him. This is more apparent when it is considered that the 'plane would not simply have a dense cloud of smoke blown around it at one point in

paraiso, Chile, Callao, Peru, thence thru the Panama Canal to Newport News, she was in command of Dr. N. W. Edmonds and a number of other scientists of the Government staff.

“The Long Dash”—A Wireless Gun Show

BACKED by an absorbing story enacted and assisted by elaborate scenic and stage effects, “The Long Dash” has proven one of New York’s latest and greatest theatrical successes. The play was written by Robert Mears MacKay and Victor Mapes, co-author of “The Boomerang.” It has a distinguished cast, including Robert Edeson, Henry E. Dixey, Violet Kemble Cooper, Milicent Evans, and others. The dramatic story revolves around the invention of a marvelous new “radio controlled” cannon. The secret of its operation is stolen by a spy. With the inventor of the gun dead and the radio code by which the gun is operated lost, many curious and exciting incidents result. Interspersed with all these affairs there is a delightful love story in which two brothers, Paul and John Hazelton, both impersonated by Robert Edeson, are concerned.

Now for the dirty work. Those who have seen this show have undoubtedly wondered just how the wireless controlled gun, a large sized and faithfully reproduced model of which is used on the stage, as the accompanying photographs show, is operated. For it surely does give one, no matter how sophisticated in scientific matters he may be, a genuine dramatic thrill. Robert Edeson, who endeavors to solve the mystery of the lost code, presses the key of the wireless transmitter located across the stage from the gun, and every time he presses the key a crashing blue-white spark several inches long leaps across the spark gap at the transmitting apparatus. A similar spark also appears simultaneously at the spark gap fitted on the gun pedestal. Being of a scientific turn of mind, he eventually gets down to the point where he can cause the gun to train around a circle, and also up and down vertically, besides firing. The controlling signals comprise a number of dots or short sparks, and after the proper number of these have been transmitted, a long dash or spark is required to cause the particular function in hand to take place. Thus when the gun is to be fired, after being trained with a previous set of signals or sparks, a number of short flashes are

rapidly transmitted, and then the “long dash” or spark is the signal that the gun will fire. A thirty-eight caliber Colt revolver is cleverly arranged inside of the

and cause a shell to pass thru the target without killing a few dozen actors standing off stage. The truth is, there “ain’t no such animal” as a bullet used, but a trusty



The Wireless Controlled Cannon Speaks—and Hits the Bull’s-Eye Every Time. An Exciting Moment from the New York Dramatic Success, “The Long Dash.” Mr. Robert Edeson Plays the Role of the Radio Genius, Who Works Out the Code Which Will Operate the Gun, Its Inventor Having Died.

model cannon and this, operated by a stage assistant, produces the explosion whenever the gun is fired.

But this is not all, for to lend still more enchantment to the seeming mystery of this pseudo-scientific drama, the target at the rear of the stage plays a very important rôle, for every time the gun operates another “bullet” goes thru the target. At least the audience thinks so, for does not a hole appear in the target each time the gun fires? Sure it does, and little Willie in the front row as well as his grand-dad probably wonders how in the dickens they can fire a small naval cannon right on the stage

assistant stands ready with a string in his hand, and each time the gun fires he yanks another wad of paper out of a previously prepared hole in the bull’s-eye of the target. “Ye gods!” little Willie remarks, Mr. Edeson is sure some sharp-shooter, and in truth he is, so far as the story of the drama is concerned.

As will be recollected, in the introduction it was mentioned that Mr. Edeson impersonates two rôles—that of Paul Hazelton as well as John Hazelton. In another act a clever bit of stage work is carried out, and a few words describing it will undoubtedly prove of interest. In this scene one of the brothers sits down in a large high-back, old-fashioned chair, and presently turns the chair with its back to the audience and starts eating at a table. The audience sees the actor’s arms moving as he proceeds to eat his dinner, but the old saying that the “hand is quicker than the eye” still holds good to a dot, for right before your very eyes and while the good Mr. Hazelton No. 1 apparently is enjoying his meal an unseen transposition takes place in a few seconds. The seat of the chair is a spring-actuated affair and collapses when desired. The actor escapes down thru the bottom of the chair by means of an electrically operated dumb-waiter, or “trap,” as it is called in stage parlance, and another actor rises on the trap, gets into the chair and carries on the arm movements and other embellishments that go with the assimilation of a hearty repast; and in the meantime the door of the room opens, and in walks the other brother, Mr. Hazelton No. 2, who is no other than our old friend, Mr. Robert Edeson.

An electrically controlled machine for sorting coffee beans has been invented by a native of Munich.

India has increased its annual coal production to 12,000,000 tons and is introducing electrical machinery into some mines.



A Close-Up View of the Wireless Gun and Radio Transmitter, with Mr. Edeson Studying Its Response to Various Dot and Dash Combinations, from the Play—“The Long Dash.”

Nikola Tesla and His Inventions

By H. Gernsback

AN ANNOUNCEMENT

SEVERAL years ago, in the course of a discussion, a well-known journalist asked me whom I considered at present the world's greatest inventor. I said: "If you mean the man who really *invented*, in other words, *originated* and *discovered*—not merely *improved* what had already been invented by others, then without a shade of doubt, Nikola Tesla is the world's greatest inventor, not only at present, but in all history."

My friend was much surprised and voiced his astonishment. "Surely," said he, "you do not mean to place Tesla ahead of such great men as Archimedes, Faraday or Edison?"

"That is exactly what I mean," I replied, "and before twenty-five years have elapsed the world at large will echo my opinion."

"But listen," persisted my friend, "who on earth is this man Tesla anyway? What are his wonderful inventions, what great thing has he ever done? How is it that the world at large does not know him?"

"To begin with, and the better to impress you," I replied, "Tesla has secured more than one hundred patents on inventions, many of which have proved revolutionary. Science accords to him over 75 original *discoveries*, not mere mechanical improvements. Tesla is an originator in the sense that Faraday was an originator. Like the latter he is a pioneer blazing the trail; aside from this he is a discoverer of the very highest order."

"Ninety percent of the entire electrical industry pays tribute to his genius. All electrical machinery using or generating alternating current is due to Tesla. High tension current transmission without which our long distance trolley cars, our electrified lines, our subways would be impossible, are due to the genius of Tesla. The Tesla Induction Motor, the Tesla Rotary Converter, the Tesla Phase System of Power Transmission, the Tesla Steam and Gas Turbine and the Tesla Coil and Oscillation Transformer are perhaps his better known inventions.

"As to your last question, namely, why the world at large does not know Tesla, it is answered best by stating that he has committed the unpardonable crime of not having a permanent press agent to shout his greatness from the housetops. Then, too, most of Tesla's inventions, at least to the public mind, are more or less intangible on account of the fact that they are very technical and, therefore, do not catch the popular imagination, as, for instance,



Nikola Tesla, from a Painting by the Famous Princess Lwoff-Parlaghy. This Picture Has Never Been Published Before.

wireless, the X-ray, the airplane, or the telephone."

The trouble with Nikola Tesla is that he lives a century ahead of his time. He has often been denounced as a dreamer even by well-informed men. He has been called crazy by others who ought to know better. For Tesla talks in a language that most of us do not as yet understand. But as the years roll on Science more and more appreciates his greatness, and begins to pay him tribute more and more.

In 1893, three years prior to the earliest attempts in Hertz wave telegraphy, Tesla first described his wireless system and took out patents on a number of novel devices which were then but imperfectly understood. Even the electrical world at large laughed at these patents. But large wireless interests had to pay him tribute in the form of real money, because his "fool" patents were recognized to be fundamental. He actually antedated every important wireless invention.

A few weeks ago the world read thru news dispatches of a great wireless

discovery—the static eliminator. But Tesla had not only patented systems overcoming this and other forms of interference but had actually constructed and successfully operated devices years ago in Colorado, under conditions where static interference was troublesome to an extraordinary degree. A photograph of one form of his apparatus is published with a note from him for the first time elsewhere in this issue of the *ELECTRICAL EXPERIMENTER*. And so it goes. The world smiles an unbelieving smile, but Tesla's master mind invariably sets the world aright.

I first read about Tesla in a well-known German weekly publication when I was less than 15 years old. The Editor of that publication reproduced his picture on a full page and paid high tribute to Tesla, hailing him as the world's coming greatest electrician.

H. W. Buck, Chief Engineer, President of the American Institute of Electrical Engineers, among others, said: "The work of Nikola Tesla in his great conception of his rotary field seems to me one of the greatest feats of imagination which has ever been attained by human mind."

Lord Kelvin, before the British Association, commenting upon the Tesla Transformer exhibited, said: "This is a wonderful development of the induction coil destined to be of great importance."

Electrical Review, commenting upon the wireless: "Mr. Tesla's

researches in this field have attracted world-wide attention, and his is undoubtedly the master mind."

Der Electro-Technische Anzeiger, Berlin, and *Elektrizität*, Leipzig, Germany, (commenting upon Tesla's work): "It is a combination of the grandest power of technical performance with the most vivid imagination, such as has never before manifested itself in the human mind."

Brigadier Allen, of the United States War Department (commenting upon Tesla's Turbine): "Something new in the world. Officers are greatly impressed with it."

While studying abroad I read every scrap of his work I could lay my hands on. I performed most of his high frequency experiments, and the more I saw of his work the more impressed I became. Some years ago as Editor of *Modern Electrics*, I met him in a New York shop where his famous turbine models were first built. I was fascinated with the tall, gaunt man, then about 50 years old, but looking less than 30. His extraordinary face, with his deep set blue eyes, proclaimed the intense thinker—the philosopher. A few minutes' chat with him left me more than ever convinced of his greatness.

Further contacts during the past few years still enhanced my opinion of him. Tesla is a man of extraordinary knowledge. He is remarkably well read and has a photographic memory whereby it is possible for him to recite page after page of nearly every classical work, be it Goethe, Voltaire or Shakespeare. He speaks and writes twelve languages. He is an accomplished calculator, who has little use for tables and text-books and holds the sliding rule in contempt. Tesla has received numerous honors and distinctions of all kinds. He is a knight of several orders, holder of many titles and diplomas. Some time ago he was awarded the Elliott Cresson gold medal by the Franklin Institute and last year the Edison medal by the American Institute of Electrical Engineers. Many extraordinary distinctions have been offered to him which he has declined. As of timely interest one instance may be mentioned. At the announcement of Tesla's high frequency discoveries, while the former Emperor of Germany was all-powerful and great men were eager for his favors, Tesla received an invitation from him and the Empress to repeat his celebrated experiments at the Royal Palace in Berlin. He forgot all about it and did not answer for one year, when he politely apologized for his inability to avail himself of the honor. Later the invitation was renewed and nearly two years past before Tesla answered to the same effect. After a lapse of time, however, upon the announcement of another important invention, he received the invitation for the third time, with the assurance that an altogether unusual honor was reserved for him. "Well, boys," said Tesla to his assistants after he laid the invitation which he never answered aside, "the Emperor must be a great man. I do not think that I would be capable of acting in this way if I were in his place."

Perhaps the most remarkable tribute was paid to him when he made his famous experiments in Colorado in 1899. It was by J. Pierpont Morgan, the elder, who donated \$150,000, which enabled Tesla to produce artificial lightning and incidentally to electrify the entire earth.

Some of Tesla's inventions have been of far-reaching importance in the War. The resources and productive powers of the country have been greatly increased thru extended use of his system of alternating current transmission and transformation of energy. Nearly ten million horsepower of water falls have been

harnest by this means, thus saving forty percent of the entire coal output of the United States. The railroads have been electrified and his induction motor has revolutionized the steel industry and operation of factories. His electric drive has been adopted on the largest cruisers and battleships as the most perfect means of propulsion. His wireless inventions have proved indispensable and his oscillatory apparatus has been of inestimable service in chiralurgical and therapeutic treatment in the field.

The technical prints abound with his work, his inventions, his discoveries. The following is only

BY special arrangement the ELECTRICAL EXPERIMENTER will, beginning with the next issue, publish a series of articles entitled "My Inventions", by Nikola Tesla. The great inventor will contribute a signed article monthly, which articles will run for several years. Most of this material has never appeared in print before. The articles will be published in book form later. We consider this announcement the most important we ever made.

THE PUBLISHERS.

a partial list of terms now adopted and published in text books and technical works:

- | | |
|--|--|
| Tesla two-phase, three-phase, multi-phase, poly-phase system of power transmission | Tesla electro-therapy |
| Tesla principle | Tesla electrical massage |
| Tesla rotating magnetic field | Tesla currents |
| Tesla rotating magnetic field transformer | Tesla transmission |
| Tesla induction motor | Teslaic experiments |
| Tesla split-phase motor | Tesla capacity |
| Tesla system of distribution | Tesla arclight system |
| Tesla rotary transformer | Tesla third brush regulation |
| Tesla system of transformation by condenser discharges | Tesla devices |
| Tesla coil | Tesla sparks |
| Tesla oscillation transformer | Tesla arrangements |
| Tesla electrical oscillator | Tesla theory |
| Tesla mechanical oscillator | Tesla point |
| Tesla high frequency machines | Tesla Steam Turbine |
| Tesla dynamo-electric oscillator | Tesla Gas Turbine |
| Tesla tube | Tesla Water Turbine |
| Tesla lamp | Tesla Pump |
| Tesla high-potential methods | Tesla Compressor |
| Tesla inductor | Tesla Igniter |
| Tesla marvels | Tesla condensers |
| Tesla impedance phenomena | Tesla electro-static field |
| | Tesla effects |
| | Tesla wireless system |
| | Tesla methods of wireless transmission |
| | Tesla magnifying transmitter |
| | Tesla telautomata |
| | Tesla insulation |
| | Tesla underground transmission, etc. |

NIKOLA TESLA, in the opinion of authorities, today is conceded to be the greatest inventor of all times. Tesla has more original inventions to his credit than any other man in history. He is considered greater than Archimedes, Faraday, or Edison. His basic, as well as revolutionary, discoveries for sheer audacity have no equal in the annals of the world. His master mind is easily one of the seven wonders of the intellectual world.

H. GERNSBACK.

The other night the Editors of the "Experimenter" had the opportunity of passing an evening with Tesla. We talked about many things, so interesting, that I will reserve them for another article—but mostly, of course, the conversation centered about Tesla himself.

"Dr. Tesla," I said to him, "you are aware of our great admiration for you, which may or may not be important. But the great public knows little of your mark. Even many of those technically educated—excuse the frankness—think that you are

(Continued on page 657)

"Odd Photo" Contest

WELL, Readers, what do you think of this perfect galaxy of "Odd Photos"? Fit for a king, eh. That's what we thought and so decided to publish them. Have you ever tried to enter a photo in our "Odd Photo" contest? Now is the time. Just look over this collection, gathered from all parts of the country, and you will gain a clear idea of just what we are after in this direction. We want brainy pictures as well as freak photos. Electrical, Radio and Scientific subjects give you a wide field to

am told, was caused by the film being wound too fast, thereby causing static electricity.

What caused the lines to be in double, or in pairs? Can anyone explain this?

What causes the lines to have those peculiar peaks?

I hope that your readers can answer it.
Wm. P. Ullrich, Ansonia, Conn.

LIGHTNING AT THE SEASHORE

Here is an excellent photograph of an

held in the shadows cast by a tree, when the sun was a crescent. It will be noticed that the shadows are all shaped like a crescent—in fact, an exact image of the sun at that time. The explanation of this is that the small apertures in the foliage acted like small lenses and projected the image of the sun on to the ground, or in this case the sheet. During the eclipse the ground and the sides of houses were covered all over with these minute crescents, and it was very interesting to watch them and to note how they corresponded with the changing



choose from. See announcement of "Odd Photo" contest elsewhere in this issue.

WELDING CAR TRACKS AT NIGHT

Herewith is an interesting night picture of men welding car tracks in Buffalo. The welding, of course, is electric, the trolley wire being tapt and a wire fastened to a weight placed on the track, making the connections. The 550 volt current is reduced thru a bank of resistance grids carried on a cart. The men are equip with a heavy glass mask of special design, to protect their eyes and ears.

Kenneth Strickfaden, New York City.

IS IT AN A. C. OSCILLOGRAM?

I here present a print which resembles an alternating current oscillogram. This, I

electrical storm at the seashore.

Last August, while at the seashore, I was awakened about 1 A. M. by the loud crashes of a storm. The flashes were very bright, so I got out my camera. Herewith is the best picture I obtained. In the foreground is a boys' camp and the board walk. The beach can be made out very clearly.

C. M. Fairbanks, Ocean City, N. J.

MYSTIC SHADOWS CAST BY SOLAR ECLIPSE

One of the many interesting phenomena occasioned by a partial eclipse of the sun is the shape of the shadows cast by the light filtering thru the trees. The present picture is one taken during the eclipse of June the eighth, at a spot where the eclipse was 85 per cent. The picture is of a sheet

images of the sun on this particular occasion.

James L. Clifford,
Evansville, Ind.

A 2-HEADED MAN

The photo herewith, altho it does not bear any relation to electricity or radio, you will admit is odd. It is prized especially because of its history. The photo itself is a double duplicate of my homely physiognomy and was taken under several difficulties. In the first place I was home with the mumps and the measles and, being at a loss for something to do, I started to pester my peaceful camera. Secondly, I was alone and had to take the picture myself. Thirdly, my camera is a box type, and I had to rig up a series of wire rings, so
(Continued on page 673)

ELECTRICAL DENTAL AUTO FOR UPTON SOLDIERS.

There's nothing like having a "pull"—especially if you happen to be one of Camp Upton's sons. Just think of the pleasure of sitting down in this elaborately equipt dental palace—why we'll bet the D. D. S. hates to leave it at night. Believe the "Doc." when he says—"We send them away with a smile!"

In examining Upton's portable dental car we note that electricity is used to almost the same extent in this portable office as it is used in the private practise of the modern dentist. Altho Camp Upton has an elaborate dental equipment, with twenty-two chairs at the Dental Infirmary, five more for the Depot Brigade, and three at the Base Hospital, and a staff of Assistant Dental Surgeons, there is still need for the dental ambulance, for among the thousands of soldiers who pass thru the cantonment, there are many who for various reasons cannot come to any one of the three permanent offices. With its complete equipment, no case is too severe to be treated, a fact which is admirably borne out by the records of the office. As many as a hundred patients have been treated in a day, the work including everything from preliminary examination to the relief of aching molars or the filling of cavities.

The dental chair, which we here see so well "filled" with a 180 pound Upton patient, with its fountain cuspidor is exactly similar to the chairs found in any well-appointed office. Conveniently located on one side is the familiar bracket table for instruments, while in front of the chair are the electric motor and extension arm of the all important and nerve twiddling drill. The foot control is on the

New British 'Plane Can Coast 20 Miles to Safety

In a recent report from an aviation camp behind the British lines in France comes the news that while the absolutely foolproof airplane has possibly not yet been invented, in the opinion of American pilots who are

cept for slight damages which may follow a landing. They are so balanced and the wings so arranged that when the engine stops they glide gradually and easily to earth, without the pilot's attention.

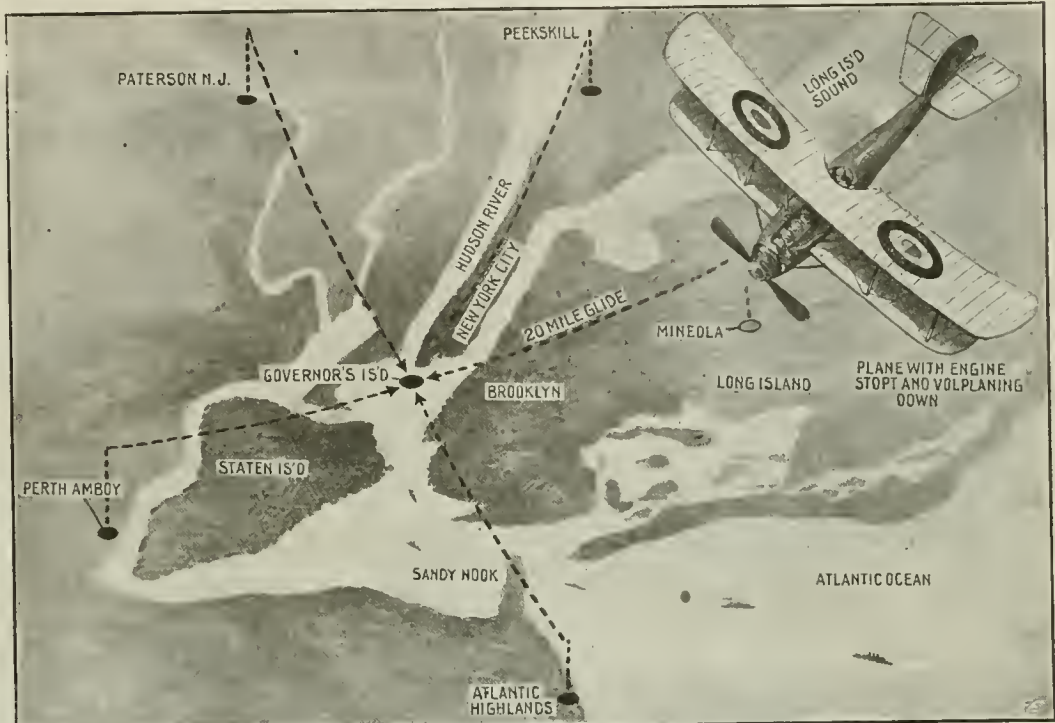

The One Great Problem Confronting the Flying World Has Always Been—"How Far Can I Glide or Coast, If My Engine Should Stop?" The Answer Is—Twenty Miles; that Is, If You Have One of These Newest British 'Planes, One of Which Has Glided That Distance in an Actual Test.

working in a British airdrome the newest British machines have very nearly solved the problem.

Left to themselves these latest machines will make their way safely to earth, ex-

floor behind the chair. Overhead are two incandescent lamps in special reflectors, which assure adequate and well-directed illumination. Even a motor-driven lathe is on hand.

The electric equipment operates at six volts, current being provided by a three-cell storage battery. This battery provides sufficient energy to operate the entire electric equipment for a two weeks' period. It is the only source of electric energy in the outfit, for the auto-engine is not fitted with a dynamo. A rectifier enables the battery to be charged from any lamp socket, however. Also this permits current to be taken direct from the lighting mains when the battery is low.—Photo courtesy New York Edison Co.

The following test shows how remarkably stable these airplanes are: A pilot climbed to a sufficient height, stopt his engine and took his hands off the controls, merely keeping his feet on the rudder bar.

He steered for an airdrome twenty miles away and, except for keeping it straight, he let the airplane do what it liked. It traveled the whole twenty miles as steadily as a bicycle coasting down a long, straight and gentle hill.

The accompanying illustration shows just what such a performance means to the aviator, who has heretofore always been in danger of being forced to volplane down at a sharp angle as soon as the engine stopt. Thus the aviator had to make a landing while coming down at a fairly sharp angle, and in some cases the plane has practically "dropt out of the sky," killing the aviator and demolishing the machine.

Just think what it will mean to the birdmen when they can volplane down a distance of twenty miles, such as from Mineola, L. I., to Governor's Island, or vice versa. It's really a wonder our flying machine inventors have not perfected such a device before this, when we stop to think of the many military aviators who have had their engines stall when over the German lines, which invariably meant they had to descend in enemy territory, with subsequent capture. The cities and towns shown about New York City in the accompanying view are all situated approximately 20 miles distant.

Electrical apparatus taking current from a light socket has been invented by a French scientist to purify the air in a room by literally pumping it into a reservoir and washing it.

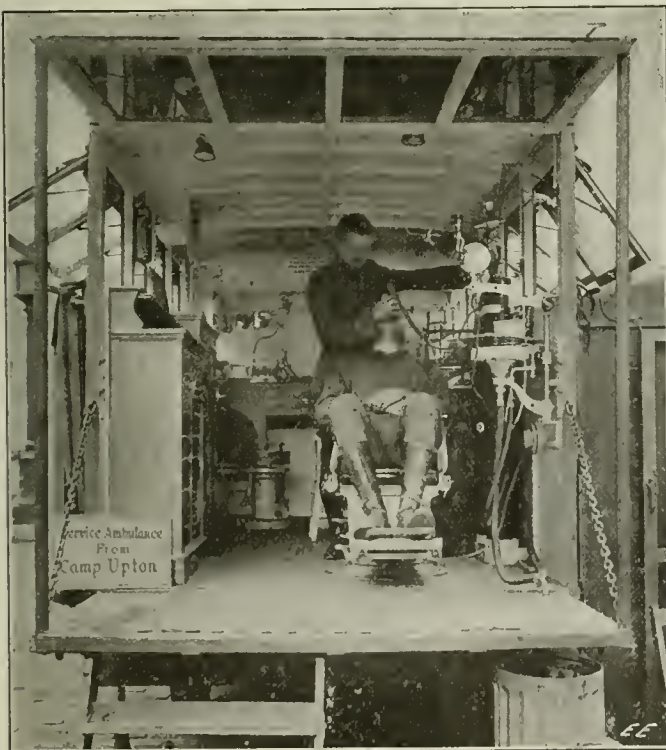

The Camp Upton Boys All Had a Real Pull with the Dental "Docs," for Electricity Provided Every Convenience Necessary for Pulling and Filling Aching Molars "Painlessly."

New Flashlight Cuts Off After One Minute

The newly invented and extremely novel electrical flashlight here illustrated incorporates a feature not possessed by any other flashlight so far developed, in that when the push button is depressed the lamp circuit is kept closed for a predetermined and spe-



You Push the Button of This Flashlight—a Minute Later the Lamp Extinguishes Itself Automatically. Result—a Saving in Battery Power and Life.

cific length of time, such as one minute, and it then opens the circuit automatically. This

feature results in a great saving of battery energy, particularly in such forms of the dry battery electric lamp as those made in the form of an ordinary lantern, which are provided with a switch instead of a push button, and which the owners thereof have a great habit of thinking that because it is an electric lantern, it will stand almost any abuse. It would make the heart of any good electrician flutter with extreme anxiety to watch some users of these electric lanterns and see them close the switch and then forget it—a dry battery to them is a veritable electric dynamo; they never give a thought to the fact that the dry cells used in every one of these flashlights, will give several times the life if they would but open the switch or button periodically—say at intervals of one-quarter to one-half minute—in order to give the battery a chance to recuperate.

It is to guard against just such misuses of the electric flashlight that the inventor of the present automatic cut-off push button, Mr. G. H. Parsons of Stamford, Conn., has evolved and patented the device here illustrated. One illustration shows the exterior of his new flashlight, called the "Tempolight," while the second illustration shows a diagrammatic view of the interior arrangements. These are simple and comprise the usual lamp bulb, a dry cell, and a circuit-closer or push button, to which he attaches a small air bellows. When the button is depressed this bellows is also depressed, and the air exhausted within it. By means of a slow acting air valve or other suitable arrangement, the bellows, after an appreciable length of time of one-half to

one minute, depending upon the period for which it is set to operate, expands and opens the push button contact trigger. A spiral spring on the push button rod tends always to push it outward.

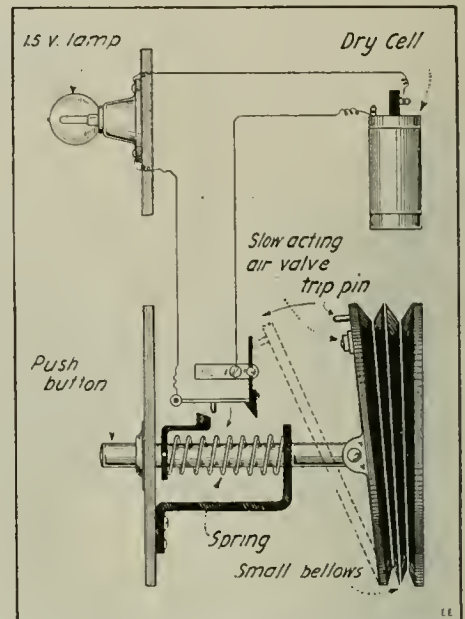

Here is the Secret of the Automatic Cut-off Mechanism of the Flashlight that Opens Its Lamp Circuit After Burning for a Minute. A Small Air Bellows Does the Trick.

FOOLING THE DRAFT BOARD?—IT CAN'T BE DONE.

THE sad and distressing fact has been brought forth that to escape a righteous duty, one that every full-blooded American should be proud to fulfill, there are amongst us mortals in this free land, a new generation—small in numbers, to be sure—who deliberately seek to evade the greatest of all things—the protection of the Stars and Stripes and the preservation of the Union.

Amongst the false claims is that of *partial or total deafness*.

The French military specialists have already experienced considerable difficulty in this direction. It appears that the malingerer most difficult to detect is the one claiming *complete loss of hearing in one ear*. A moment's thought will show why this should be. Were only partial deafness claimed it would not be difficult to trap him, as he could not possibly be consistent in all his statements thruout an extended series of tests; but, with complete unilateral deafness as the claim, he simply and uniformly replies in the negative to all tests applied to the *alleged* defective ear.

Dr. R. R. Brownfield has devised a test which not only definitely determines the acuity of hearing in either ear, but also quickly detects the unilateral malingerer.

In the device as evolved by Dr. Brownfield batteries and make-and-break contacts are entirely dispensed with. The ordinary 110 volt alternating commercial lighting current is used. The variable current is produced by a potentiometer, and is variable from an absolute zero to maximum. No vibrating iron is used, and the maximum strength of current employed is dependent on no factor except the ratio of the electrical resistances employed. The

sound producer is similar to a telephone receiver except in one very important respect—the core is of soft iron and is not magnetized. This results in eliminating the variability due to demagnetization and doubles the pitch, so that the ordinary 60

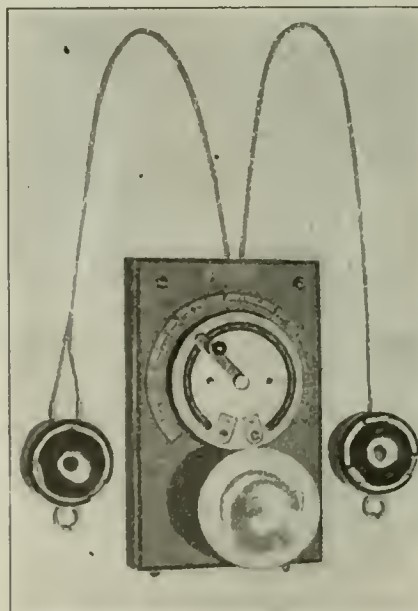

The "Slacker" Tries to Fool the Draft Board—But Here's the Electric Telephone "Hearing Test" Apparatus that Fools the Would-be Shirker.

cycle current produces 240 vibrations per second—about equal to the average tone used in conversation.

The sound producer is provided with three lugs to hold it away from the ear, so that the sound will be transmitted solely by air conduction. By simply turning the indicator from 100 to zero, one can cause the sound to increase from the point at which it is just perceptible to one of normal hearing, the threshold of audition, or 100 per cent. acuity, to a degree of intensity at which failure to perceive it indicates that the subject has no practical hearing. In addition to the variable receiver, there is a *supplementary* one that always operates at *maximum intensity*, irrespective of the loudness of the other.

In the usual test for the acuity of hearing, only the variable receiver is used. As the subject holds this to the ear, the pointer is gradually moved from zero to a point on the scale is reached, that would normally indicate very defective or almost no hearing for the good ear.

The very nature of the test, it will be noted facilitates the detection of fraud, because the better he can hear in the alleged defective ear, the less he will hear in the other—a condition just the opposite of what he might expect, so that when he makes his usual negative reply he is for once telling the truth and trapping himself. Under these conditions the sound appears to come in some mysterious way from a point at the center of the head; and if the two ears are approximately equal in acuity, there is absolutely no possibility of identifying the gradually increasing sound in the supposedly good ear until a point is reached on the scale away beyond the reading that would be obtained when the loud receiver is disconnected. Hence in the case of the pretender, the physician has only to repeat the test with the loud receiver disconnected, and a totally different reading will be secured, thus proving the deceit.

Wintertime Uses for the Electric Fan

By PAULINE GINSBERG

HAS it ever occurred to you that the electric fan can be used to great advantage in the wintertime as a labor and time saver? Probably it has not. This is but natural on account of the popular idea that the fan has only one mission, that of cooling the air. What the fan really does do is to circulate it. By impelling circulation, for instance, about the body, the displacement of the warm air for the cooler, as well as surface evaporation accordingly gives a cooling sensation, but in hot weather such as in July, the forced air from the fan does not change for the cooler, it being equally warm both indoors and out and the fan sometimes causes more discomfort than comfort. As many of us have entertained the idea that the fan cools the air, naturally the fan was invariably hustled to a secluded nook in the attic or down the cellar until the warm zephyrs

of the next spring reminded us that it was "fan-time" again.

odor will have vanished in a much shorter time than had it not been used. Incidentally dust will have been prevented from settling on the wet paint; also, it having dried more quickly, there will be a marked luster added to the painted surface. The fan can also be played on any small article that has been painted or enameled, such as a kitchen chair or table.

Gas heaters were never in such favor as they were last year and will be this year (the coal problem still being the chief reason). As a rule, with the oncoming of a substitute, some unfavorable feature is bound to spring up—in this case the reduction of humidity—the gas flame consuming a high percentage of the precious vapor which contains the oxygen, so necessary to our lungs. The electric fan again clears the situation. Place a pan about three-quarters full of water anywhere convenient, so that the fan can play di-

rectly across it. Over the pan put a thin board or piece of heavy cardboard, which has been perforated a number of times, so that small wicks or pieces of cloth can fit snugly into the perforations. They should be long enough to pass down into the water. The board or cardboard should be of the correct size so as to exactly suit the handles, and so be held in position; it should not be blown off by the fan. This arrangement need not necessarily be kept for a great length of time in one room, but it can be employed for a short period in every room, especially in bedrooms and sick rooms to promote comfort and good respiration, which in turn produce sound healthful sleep. A fan should invariably be kept in the sick room so as to insure good ventilation. It should of course be turned away, and at a considerable distance from the patient. It will greatly ease his suffering and discomfort which come from the difficulty of breathing and from the inability to sleep. The fan can be kept going at intervals and near a slightly lowered window. As the impure air rises and escapes thru the upper opening of the window, and the pure air enters thru the lower section, a good plan would be to have a small shelf made to hold the fan near the upper opening, the suction pumping out the impure air. It should also

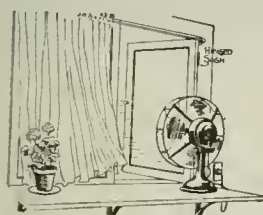

Removing Odors from the Kitchen.

When the master of the house (or was it the janitor?) goes down to the cellar, and after much ado about the furnace (no, not "nothing"), finally makes a heroic attempt at starting a fire on a sultry day and it won't work—what to do for a forced draft? Just apply a fan opposite the front or side ashpit door of the furnace as herewith illustrated, and the fire will soon be crackling away merrily. Along this same line of the heating problem it can often be placed behind or in front of the steam radiator to circulate the air around and thru it so that the room is heated more rapidly and evenly.

Something that many women will appreciate is the use of the fan in the laundry for drying clothes. You will notice, in the third photograph, how the fan is placed away from the clothes lines in order to give a freer circulation of air so that it passes over all the clothes, and has therefore almost the effect of a light wind were the

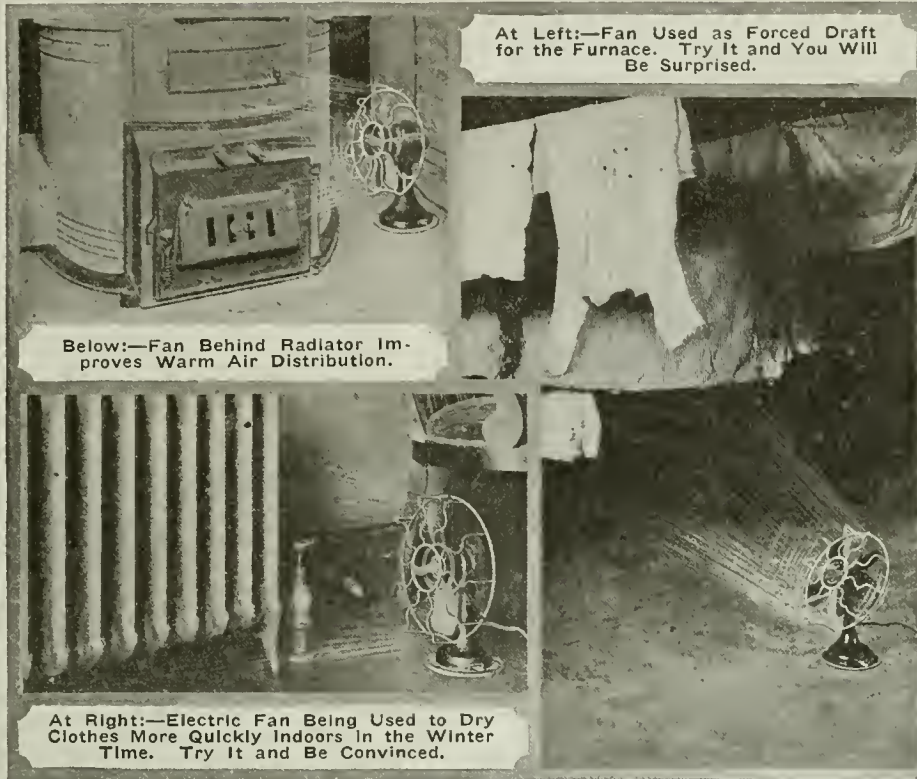

At Left:—Fan Used as Forced Draft for the Furnace. Try It and You Will Be Surprised.

Below:—Fan Behind Radiator Improves Warm Air Distribution.

At Right:—Electric Fan Being Used to Dry Clothes More Quickly Indoors in the Winter Time. Try It and Be Convinced.

The fan in the kitchen window solves a problem that confronts every housewife—what to do to prevent cooking odors and smoke from spreading over the whole house? It is particularly annoying when friends pay a visit. Any handy piece of board the length of the window can be attached as a shelf. It should be about three-quarters of an inch thick and can be fastened in place with a pair of brackets and a few screws. On this the fan is placed so as to face the open window and create a strong suction. In a short time the smoke and odors will have vanished. Also to beautify the kitchen a flower or two may adorn the other end of the shelf.

Something we all dislike is the unpleasant odor that is the result of a room or rooms having just been painted. With the windows kept open a few inches at the top and bottom and with our friend, the electric fan, kept going, the paint will dry quickly and the

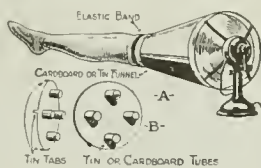

Drying Stockings and Gloves.

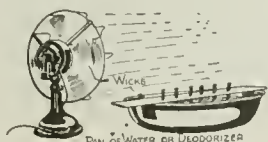

Humidifying and Deodorizing.

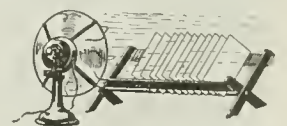

Drying Photo Negatives Quickly.

As the impure air rises and escapes thru the upper opening of the window, and the pure air enters thru the lower section, a good plan would be to have a small shelf made to hold the fan near the upper opening, the suction pumping out the impure air. It should also

(Continued on page 654)

Popular Astronomy

GIANT JUPITER AND HIS NINE MOONS

By ISABEL M. LEWIS

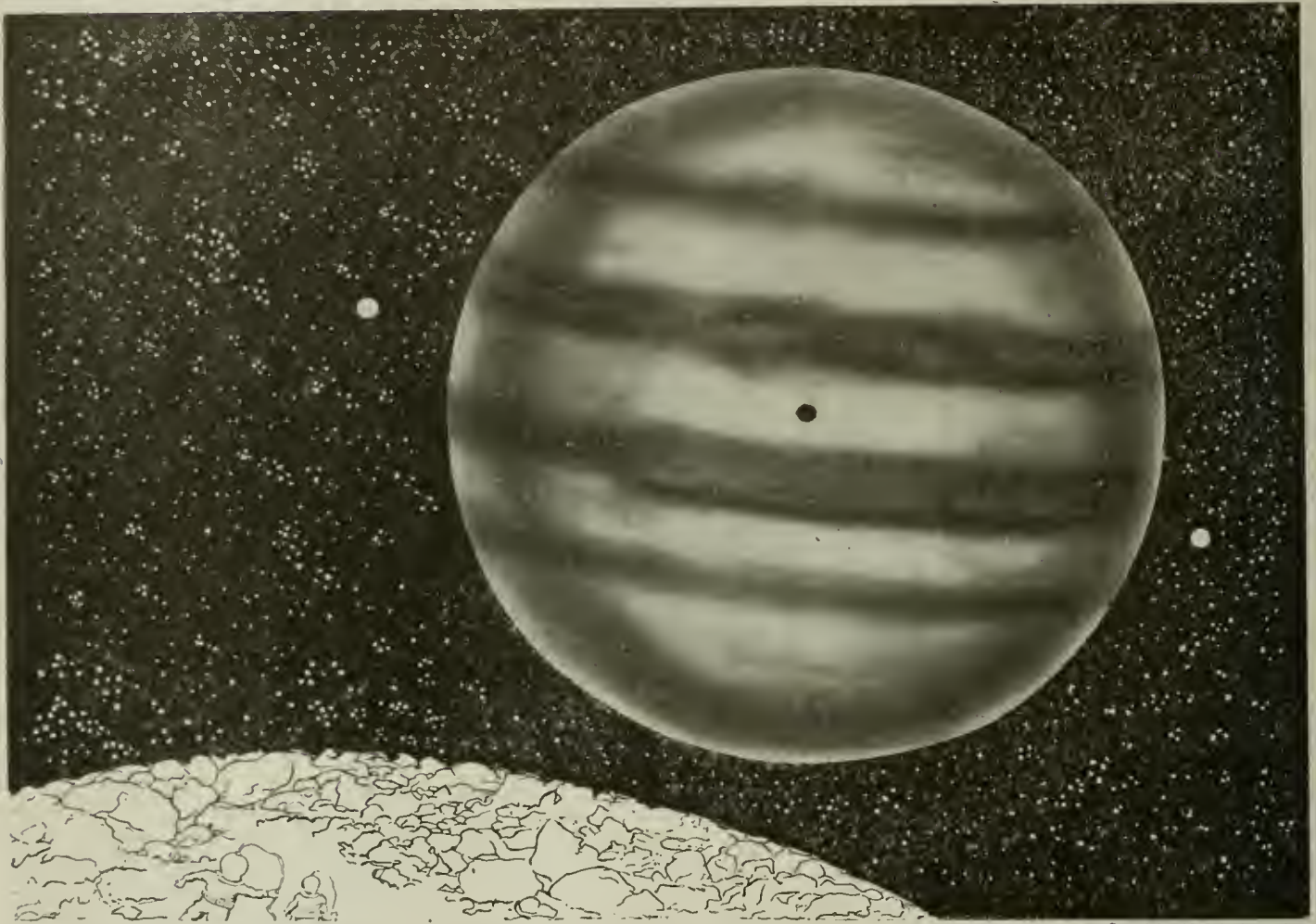

Copyright, 1918, by E. P. Co.
 Jupiter as Seen from Its Nearest Moon—Satellite V. This Tiny Moon Is Only 67,000 Miles from the Surface of Jupiter. Its Diameter Is Less Than 100 Miles. The Black Spot on the Face of Jupiter Is the Shadow of Another Moon Projected onto the Giant Planet.

THE most beautiful object in the midnight sky during these winter months is the planet Jupiter, which will continue to be in excellent position for observation far into the spring. Upon New Year's Day Jupiter will be in opposition to the sun and therefore directly on the meridian at midnight. It is then seen at its best and will be visible thruout the night, rising in the east as the sun sets and setting in the west at sunrise.

Jupiter shines by reflected sunlight with twice the brilliancy of the brightest of the stars, Sirius. When seen during the midnight hours the remarkable, unflickering brightness of this largest and most distinguished member of the solar system at once serves to set it apart from the scintillating stars far beyond.

There is but one planet, Venus, that surpasses Jupiter in brilliancy, and as Venus never departs more than forty-eight degrees from the sun Jupiter always shines without a rival at midnight. To one who has observed the two planets together the silvery radiance and surpassing brilliancy of Venus, due not to its size, but to its comparative nearness to the earth, at once

serves to distinguish it from the golden yellow glow of Jupiter.

Even the smallest telescopes of two or three inch aperture will show the four historic moons of Jupiter which were the first celestial objects to be discovered when Galileo turned his crude telescope to the heavens in the year 1610.

The fact that these tiny points of light were actually revolving around the great planet was soon detected by the famous astronomer and we can imagine with what breathless interest he observed these satellites of another world whose discovery dealt such a severe blow to the old Ptolemaic theory that the earth was the center of the universe. It was not until the great telescopes of modern times were invented that the five additional moons of Jupiter were discovered. The four satellites first observed by Galileo were fancifully named Io, Europa, Ganymede and Callisto, in the order of their distances outward from the planet, but these names are rarely used now, the satellites being designated for convenience I, II, III and IV, respectively. The first of the new satellites to be discovered was Satellite V, which is the nearest to Jupiter of all the nine moons. It is an extremely small body, not more than one hundred miles in diameter, and to discover this tiny body as it skirted rapidly around the great planet within sixty-seven thousand miles of its surface, nearly lost in the glaring rays, was a diffi-

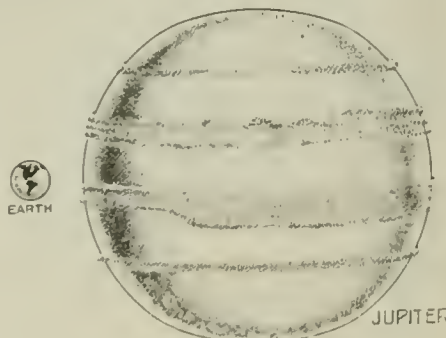

Comparative Size of Jupiter and the Earth. 90,000 Miles in Diameter, Jupiter's Mass Is 300 Times That of the Earth.

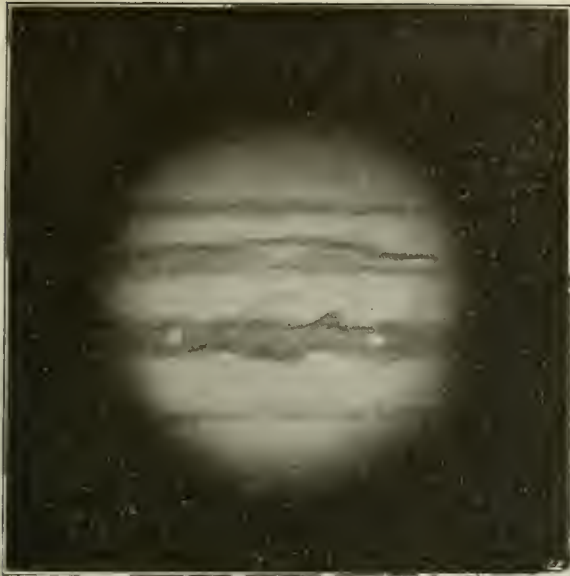

Jupiter Photographed October 19, 1915, with the 24-Inch Refractor by E. C. Slipher of the Lowell Observatory.

twelve hours at a distance of only sixty-seven thousand miles from its surface we realize what tremendous differences exist in the distances and periods of revolution of the nine moons. There is also great disparity in the sizes of the various moons. The five moons discovered in modern times are all excessively faint and therefore extremely small. The diameter of the largest of these, Satellite V, is less than one hundred miles. On the other hand, the four historic moons of Jupiter are of planetary dimensions. The smallest, Satellite II, is slightly larger than our own moon, while the largest, Satellite III, has a diameter according to measurements made with the 40 in. Yerkes refractor in 1916, of three thousand nine hundred and eight miles, which is only four hundred miles less than the diameter of Mars. The periods of revolution of these four satellites range from one day and eighteen hours for the

suddenly disappears from the observer's view, tho it may be considerably to one side of the planet. Its reappearance later on is just as sudden, or it may pass out of the shadow while hidden from us behind the disk of the planet, in which case its reappearance is invisible from the earth. The occultations of the satellites, or, in other words, their disappearance behind the planet's disk, are also interesting phenomena to observe, as are their "transits" across the disk of the planet as the satellite passes in front of the planet. Not only the satellite itself but its shadow as well can be seen, a small black dot passing over the surface of Jupiter. The satellite is totally eclipsing the sun for this small dark portion of the planet. Two satellites and their shadows are frequently seen crossing the face of the planet at the same time. It is possible to observe all the phenomena of the satellites' transits and shadows, eclipses and occultations with very small telescopes. From observations of the eclipses of Jupiter's satellites the important discovery of the finite velocity of light was first made as far back as the year 1675.

cult feat even for an experienced observer. It was accomplished, however, by Prof. Barnard with the great Lick refractor in 1892. Satellite V is hopelessly beyond the reach of any but the greatest telescopes, as are also the four satellites discovered since that date. In fact, most of these tiny moons are observed photographically. Satellites VI and VII were discovered photographically in 1905. They are both about seven million miles from the planet and their paths loop thru one another; they are, moreover, highly inclined to each other at an angle of nearly thirty degrees. When nearest together they are separated by a distance of two million miles. Two more extremely small bodies, known as Satellites VIII and IX, have been discovered quite recently, one at Greenwich, England, in 1908, the other at the Lick Observatory in 1914. These excessively faint bodies are the most remote satellites of Jupiter and they are of particular interest because they travel around the planet in a direction *opposite* to the direction of revolution prevailing in the solar system. The ninth and most distant satellite of Saturn also retrogrades; that is, it revolves in a clockwise rather than a counter-clockwise direction around the planet. One explanation given for this peculiarity of the outermost satellites of Jupiter and Saturn is that this backward revolution around the planet is more stable when the satellites are at great distances from the primary and the gravitational control that the planet exerts, therefore weak. The moons of the planets are, of course, subject to the attraction of the sun as well as to the attraction of the controlling planet, and the greater the distance of the satellite from the planet the stronger the pull exerted by the sun and the weaker the bonds that bind such a moon to the planet. Beyond a certain limit it would be impossible for the planet to hold the satellite against the sun's greater attraction and the satellite would leave the planet to revolve directly around the sun, thereby becoming a planet. It appears that as this danger limit is neared it is safer for the satellite to "back" around the planet than to follow the usual "west to east" direction of revolution. The eighth satellite of Jupiter is more than fourteen million miles from the parent planet and they require about two years and three years, respectively, to complete one trip around Jupiter. When we consider that Satellite V darts around the planet in less than

nearest, which is about two hundred and sixty-one thousand miles from the center of Jupiter, to sixteen days and sixteen and one-half hours for the most distant, which is more than one million one hundred and sixty thousand miles from the planet. These four moons of Jupiter are most interesting members of the solar system. They are so near to the great planet that they are continually dipping into his huge shadow and experiencing an eclipse of the sun's rays, which, owing to the nearness and great size of Jupiter, lasts for two or three hours. At times of eclipse the moon

Faint surface markings have been made out at certain times on the largest of the four satellites, Satellite III, and also on Satellite I, or Io. Observations of the markings on the former seem to indicate that it always keeps the same face turned toward Jupiter as does our own moon toward the earth.

There are also reasons for believing that the equatorial regions of Satellite I are light colored and the polar regions dark.

(Continued on page 668)

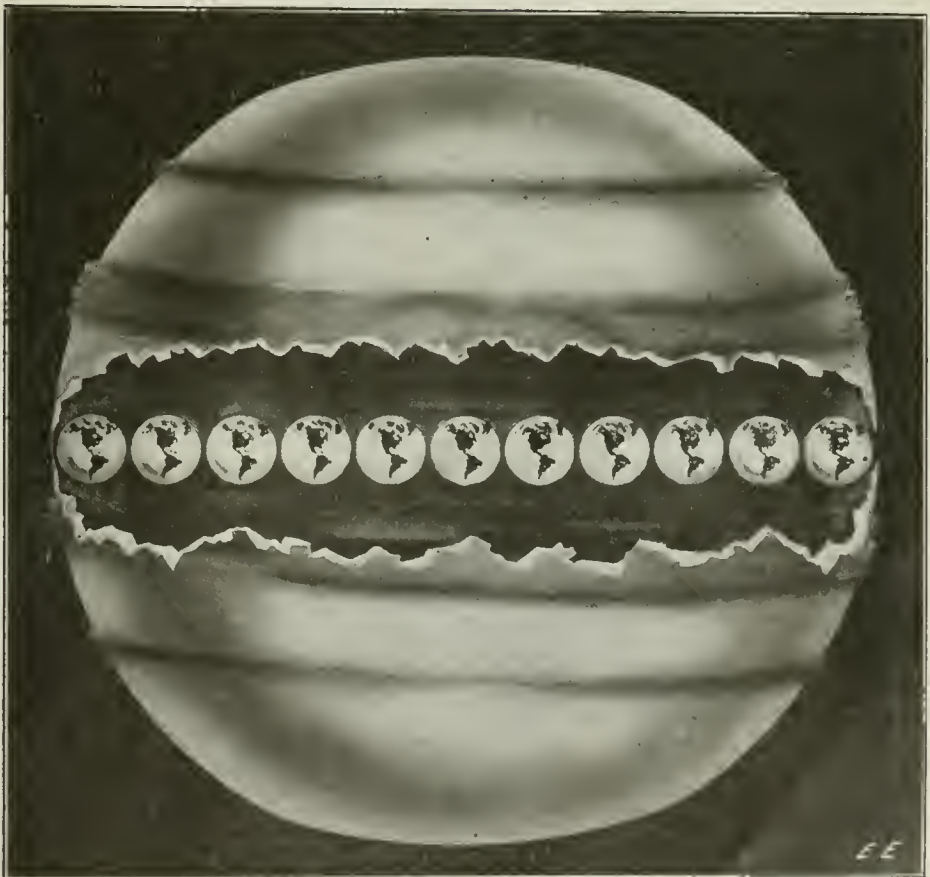

How Immense This Monster Planet Is,—the Largest of Our Planetary System,—Can Be Judged Best by This Illustration. If We Took Eleven Globes the Size of Our Earth, They Could All Revolve Within Jupiter Without Touching Each Other, and Still Have Room to Spare.

An All-Electric Hot Air Balloon

THE captive balloon as used by the Allied armies at the present time is invariably filled with hydrogen or other gas supplied from steel bottles containing this gas stored at a high pressure, or else it is obtained from manufacturing supply stations on the field. The first balloons ever used—the old "Montgolfières" of 1783—were made to rise by means of hot air, for, as we all know,

and after a short time the heated air rushing up into the balloon causes the envelope to become very light and it rises in the air. Some of these balloons will travel for miles, and years ago it was not an uncommon sight in Europe to see hot-air balloons ascend with several men.

There has always been, however, a serious objection to a hot-air balloon where the heater was of the flame or similar type,

point to another. Either the automobile engine or a separate gasoline engine mounted on the truck drives a dynamo, which supplies current for an electric heater in the balloon. By means of suitable clutches, the engine may be caused to drive the dynamo, or else thru a chain drive, it may be connected up to rotate the cable winch drum. The dynamo makes connection to a duplex power cable reeled around the drum, and this leads up to the balloon basket.

Also the telephone circuit is carried up to the balloon thru the drum or otherwise, so that those on the ground are in telephonic connection at all times with the observer in the balloon basket, and under battle conditions he would also be in telephonic communication at all times with "field headquarters," so as to report the position of enemy guns, troops, etc.

Referring to the balloon in detail, we find that it is provided with an electric grid heater, and also a motor-driven blower and connecting tube, so that whenever the blower is operated, air is pumped up into the balloon envelope, the air passing thru the electric grid heater. The balloon bag is fitted with a suitable damper in the lower opening and a relief valve at the top in the usual manner, the relief valve being connected to the observer's basket by means of a small rope. When it is desired to descend, the observer may open the motor blower switch in the basket, and thus aid the hauling in of the balloon, for as the temperature of the air within the balloon bag falls the balloon naturally tends to descend toward the earth.

8,700,000 AMERICAN HOMES LIGHTED BY ELECTRICITY.

From the compilation made by the *Society for Electrical Development* it is shown that there are 20,689,000 families in this country, of which 7,000,000 have yearly incomes of \$900 or more. However, the yearly average family income before the war was under \$626.

Over 13,000,000 families are too poor, too illiterate, or otherwise unfitted to buy electrical goods. Over 8,700,000 homes are electrically lighted and 120,000,000 sockets contain Mazda lamps. In over 30,000,000 sockets are carbon lamps. It is estimated that 9,000,000 sockets are empty.

Homes lighted by other means, 15,000,000; some are wired but not connected up for service. Electric service is available in 10,613 communities of the United States, compared with 3,545 communities that are being served with gas.

ELECTRIC SEARCHLIGHTS.

Ranges of electrical searchlights vary from between one thousand to two thousand yards in foggy weather to ten thousand yards or more when the air is very clear. The average sea range is approximately six thousand yards, but there are cases on record where ships have been spotted at a distance of nine miles. These figures are based on a sixty-inch mirror and a twenty-thousand watt arc.

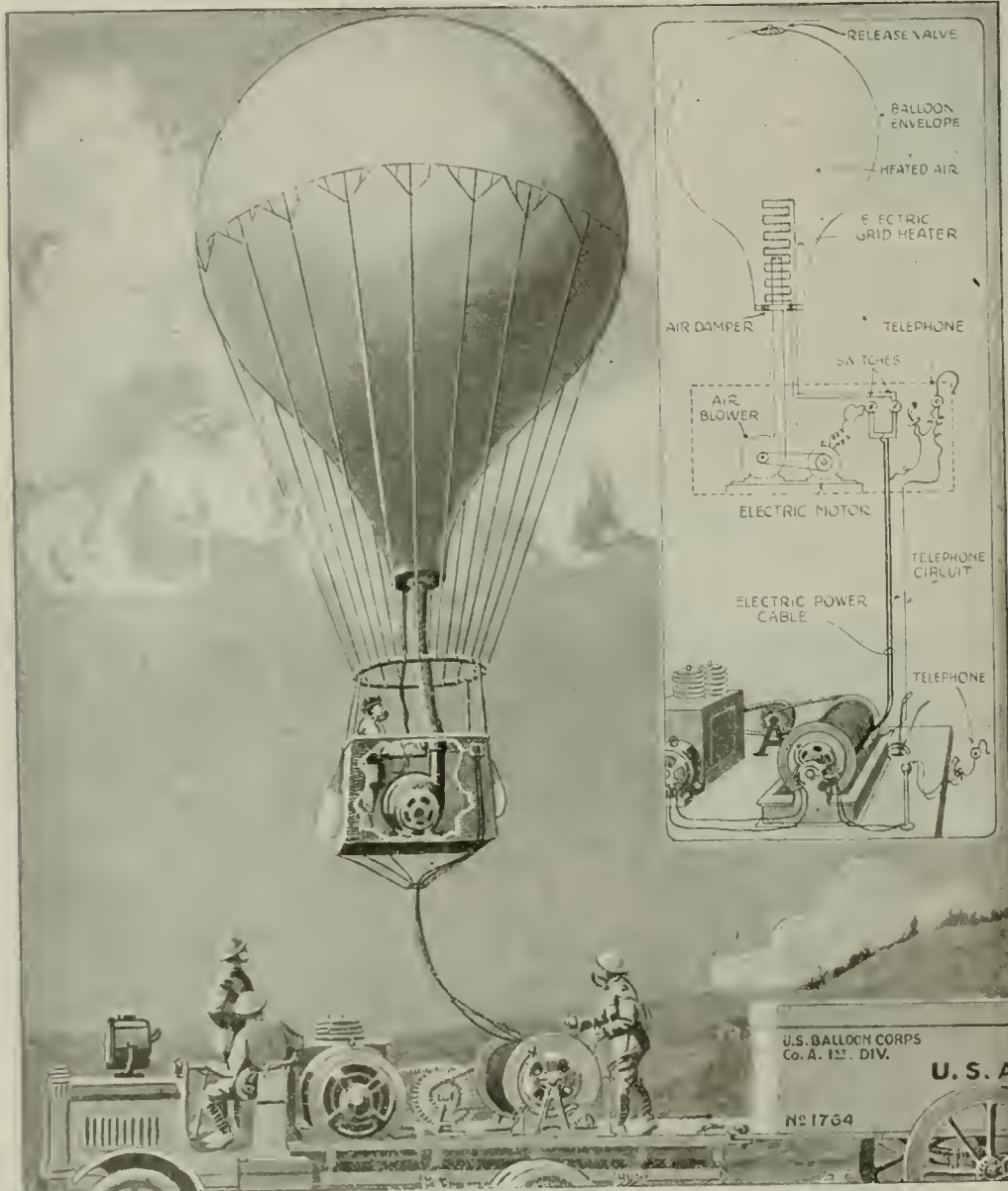

A New Form of Heated Air Balloon, the Air in the Bag Being Kept Continually Hot, to Any Degree Desired, by an Electric Heater in the Neck of the Envelope. Current is Sent Up to the Balloon Basket from a Gasoline Engine-Dynamo Set Mounted on the Truck Below. Telephone Connection Between the Truck and the Observer Aloft Is Available. A Motor-Blower Drives Heated Air Into the Balloon Envelope.

heated air is lighter than cold air, and will always rise. If the heated air is of sufficient volume, it will also carry a body up with it, such as a balloon envelope for example. All of us have seen the simple balloons which patriotic Americans are wont to liberate on the Fourth-of-July, and which are composed of nothing more than a balloon-shaped paper bag at the bottom opening of which there is secured either an absorbent wick containing gasoline, or a small alcohol lamp. We simply light the lamp,

for there was always in this case the constant danger of the balloon becoming ignited, with disastrous results. It has remained for Mr. James N. Lewis of Detroit, Michigan, to invent and patent an all-electric hot-air balloon, which is illustrated in detail in the accompanying illustration. Mr. Lewis makes use of an automobile winch to haul in the balloon, and to act as a mobile station, a trailer being hooked behind the winch, in which to carry the balloon bag and basket while being transported from one

The City of Splendid Night

By AMOS STOTE

A 20th Century poet strolled at night enraptured thru the highways and byways of Manhattan, a gleam in all her nocturnal glory—not one night, but many nights—some moonlit, others rainy, but always—the magic of millions of electric lights threw its spell over him. And as he walked along this street or that, or mayhap thru the park, or along the shimmering Hudson, the very soul of the city seemed to commune with him. The poet's name was Amos Stote, and he has here set down three literary gems describing New York City at night as it appealed to him. We like Mr. Stote's soulful word-pictures of the Greater City electrified—he gives us something to think of besides the lights themselves. Thought is the keystone of all intellectualism. Our poet has given us a new pair of soul spectacles thru which to view many splendid sights—which the everyday man never as much as suspects.

softened hours that tread upon the heels of the noontide of the night, those hours that have gained a new, entrancing charm be-

I have wandered down unfavored streets, idle channels from which the thinning traffic of the closing day has been diverted



"Blot Out the Stars! Let the Skies Open Every Pore. . . . Fields Are Sodden, Villages Sordid. . . . But Old New Amsterdam Is Glorious. The Romance of Masonry and Electricity Is Before You. It Is a Drama Done In Pouring Pantomime."

THERE is a habit, born of Manhattan, that comes to possess the souls of men who wander thoughtfully. It is the habit of night. Not the starstrewn night of mountain tops where God's myriad incandescents sow the skies. Not those shores concerning which poetic folk write rhapsodies around the central station of the heavens. (To me the moon across the sea is a great searchlight laying a restless path that I long to follow.) No, it is not to mountain or shore, not even to deep, mysterious woods, where the firefly sprinkles sparks amid green leaves, that I would go in quest of those good men who have the habit of night.

To these men, and to me, the night of nights is to be found in the rugged, slumberless zone of Manhattan and its fringes of resting streets. Perhaps you know those



New York—"the City of Splendid Night." A Wonderful View of the Theater Section from Times Square—the Hub of Manhattan's Ever-Seething Traffic. The Hotel Astor Appears in the Left Foreground.

cause—because of a man named Edison. In the old days of shrouded streets, when darkness threw a mantle of mourning over the city, good men went in groups for safety sake. Then only the brave and the brute ernised singly abroad, for of course we except the gallant, suffering from love's fever. But now a million gleams of light insure the safety of the streets and give the nightbedecked city over to the admiring glances of those who have learned the beauty that lies in the silent battlements of commerce; and in the old homes and highways.

into the congested spillways of frivolity. Here, along these hushed courses, where life dozes on the border of gaiety, as an outworn chaperone naps in the antechamber to the ballroom, here I have seen ancient doorways with the beauty of the binding of a rare first edition.

Once upon a time periwigged and gouty old gentlemen, and haughty grand-dames, past in and out these doors. On state occasions, when they ventured forth at night, armed servants escorted them and fleet-

(Continued on page 673)



And a "Night in the Park." For Within the Sylvan Solitude the Voice of the City Speaks Faintly, and Its Sparkling Eyes Are Velled with the Romance of Contrast.



The RADIO LEAGUE of AMERICA

HONORARY MEMBERS
CAPT. W.H.G. BULLARD, U.S.N. NIKOLA TESLA.
PROF. REGINALD FESSENDEN. DR. LEE DE FOREST.



Manager, H Gernsback

Prussianizing the American Ether

By H. GERNSBACK

WHEN, on April 6, 1917, the President of the United States, by executive order, closed all wireless stations, the order was carried out to the letter by all Radio amateurs willingly and cheerfully. No notice has come to our attention where an amateur disobeyed the President's wishes.

All amateurs stood solidly behind the President when war was declared because all realized that everyone had to bear great sacrifices willingly and cheerfully. When the armistice was finally signed, the whole world breathed a sigh of relief, including the American amateur who had been given to understand that as soon as peace was actually declared the ether would be free for all once more. The amateurs were satisfied to go back to pre-war conditions, to take up their studies in an art which has few parallels as far as instruction and ennobling of the mind is concerned.

Unfortunately, however, in certain quarters in Washington, a feeling seems to exist that the amateur at best is a nuisance and should be done away with entirely. On November 21st two identical bills were introduced, Senate 5036 and H. R. 13159, the former by Senator Fletcher, the latter by the Honorable Joshua W. Alexander. These bills are reproduced elsewhere in this issue, as well as a statement given out by the Navy Department. The Navy Department frankly admits that these bills are not a war measure and it also endorses these bills. The Navy Department also makes the extraordinary statement that "experimenters" and scientists will not be "interfered with, to wit:

IT SHOULD BE NOTED THAT THIS BILL IS NOT TO CREATE A COMPLETE GOVERNMENT MONOPOLY. THE SCIENTIST, MANUFACTURER, AND SHIP OWNER ARE SPECIALLY PROVIDED FOR, AND NO CHANGE IS PROPOSED IN THEIR STATUS UNDER EXISTING LAW. STATIONS MAY BE LICENSED FOR SPECIAL COMMUNICATION, AND THESE ARE EXEMPTED FROM GOVERNMENT OPERATION.

Any intelligent person reading this paragraph must come to the conclusion that amateurs would revert to their *ante bellum* days the minute peace was declared by Presidential proclamation.

So far, so good. We now turn to the Alexander and Fletcher identical bills, and read them attentively. To our amazement not a word is mentioned about the amateur. This bill also contains the extraordinary statement that:

"Experiment station means a radio station actually used for conducting experiments for the development of the science of radio communication or the

apparatus appertaining thereto, and used for no other purpose except as a technical and training school station."

In other words, a technical training school station is an experiment station and vice versa. Of course, this statement alone, unless modified means that if the bill is actually past by both Houses the amateur will be just as dead as that sensitive spot on a galena detector after it was hit by lightning.

A second reading of the Navy Department's statement also informs us that the President approved a similar bill: H.R. 2573.

We now turn our attention to this bill

NAVY DEPARTMENT
NAVAL COMMUNICATION SERVICE
OFFICE OF THE DIRECTOR

WASHINGTON, November 23, 1918

Gentlemen,

In reply to your request of November 22, 1918 for information relative to reopening amateur radio stations, you are informed that as all radio stations not necessary to the Government of the United States were closed for the duration of the war by an Executive Order dated April 6, 1917, no further action will be taken regarding these stations until peace has been declared by the President.

Very respectfully,

E. B. Woodworth
Commander, U. S. Navy
Assistant Director Naval Communications

Electrical Experimenter
133 Pulton Street,
New York, N. Y.

and read it carefully. We are struck with the fact that it was first introduced in the House of Representatives by Mr. Padgett under date of April 9, 1917, a year and a half before Messrs. Alexander and Fletcher introduced their bills. Strange to say, all the three bills read alike *except* that Mr. Padgett's bill right after the fifth paragraph, referring to the technical and training school stations, has the following:

The term "Amateur" station means any station not an experiment station or a technical and training school station and not operated for financial profit.

We also find in this bill, under Section 3, the following:

This section shall not apply to experiment stations, technical and training school stations and amateur stations, duly licensed by the Secre-

tary of Commerce as provided by the act to regulate radio, approved August 13, 1912.

Here the similarity ends. In all other respects the three bills read actually and almost entirely word for word the same. We heartily approve Mr. Padgett's bill, which also has the approval of the President as admitted by the Navy Department.

Now then, as Mr. Padgett's bill was introduced on April 9, 1917, and as Mr. Alexander's bill was introduced on November 21, 1918, one and one-half years later, and inasmuch as Mr. Alexander's bill reads exactly alike word for word all the way

thru with the exception of the paragraphs mentioning amateurs, Mr. Alexander necessarily must have copied Mr. Padgett's bill. But when he came to the paragraphs mentioning amateurs he ran his blue pencil right over them.

And that is the joker. President Wilson approves of Mr. Padgett's bill favoring amateurs. Mr. Alexander with the stroke of his pen,—or was it the blue pencil?—wants to shut out the amateur from the ether forever.

Not that Mr. Alexander is not familiar with the amateurs. He knows them well. For Mr. Alexander was the author of the original radio bill before it was a law. The writer in 1912, as will be remembered by most amateurs, fought the Alexander bill for the reason that it did not make mention of the amateurs. Finally Mr. Alexander and his committee became convinced that it would be an injustice to silence the amateurs, and in April of that year the Alexander Wireless Bill *amended* appeared. As will also be remembered, Mr. Alexander and his advisers accepted the writer's recommendation pertaining to amateurs as set forth in the writer's editorial in the February, 1912 issue of *Modern Electrics*, and this bill later in the year was signed by President Taft, thus making it the present wireless law.

It strikes us as remarkable that inasmuch as in 1912 Mr. Alexander could not see the amateurs with an ultra-microscope, his eyesight as far as the amateur is concerned has not grown better in 1918. As soon as we knew that there was to be a new wireless measure, we got busy immediately and we found out that there will be a hearing of Mr. Alexander's bill on December 12th which will continue from day to day until all have had a chance to be heard. Inasmuch as this issue of the *ELECTRICAL EXPERIMENTER* does not come out until about the 12th of the month, it would have been impossible to inform all amateurs of the impending measures, and for this reason we took it upon ourselves to mail out at once some 50,000 letters broadcast to all amateurs giving them the facts of the case.

Of course it is not too late even now for those who have not received our letter. Mr. Alexander's bill has not as yet been

past, and we doubt very much if it will. What we want is Mr. Padgett's clauses reinstated—in other words, what we want as far as the amateurs are concerned is the passing of the bill H.R.2573, which has the full approval of the President, so admitted by the Navy Department; or, what amounts to the same thing we want Mr. Padgett's clauses regarding amateurs inserted in Mr. Alexander's bill. One is exactly the same as the other. This is all that we want, and it is fair to all concerned. It simply means that the present wireless law is to remain the same, and this, we are certain, will satisfy every amateur in the country.

The licensing system whereby the amateur was licensed by the Department of Commerce for the five years during which the law was in force, proved satisfactory to all concerned. No amateur has ever harmed anyone, and as the stations were licensed the amateurs refrained from sending out false calls or otherwise making a nuisance of themselves, a condition which prevailed before the 1912 wireless law was past.

It has been proved time and again that radio apparatus enormously sharpen the senses of a young man by making him keener all the way around, besides teaching him an art that is worth while.

Hundreds of thousands of radio amateurs in the Signal Corps have helped towards winning the war, and they will do so again when called upon. If it had not been for wireless, the United States would not have had such a large body of telegraphers at the outset of the war, and nearly all of these volunteered. Furthermore, radio telegraphy has been the great cause to keep the young man away from questionable company during his spare evenings, and this alone overbalances any criticism that could possibly be brought against the amateur. Any parent who has a growing son is thankful for being allowed to spend all he possibly can for radio apparatus because he realizes more than anyone else that it keeps together the home ties between son and home.

It is not too late as yet to protest against Mr. Alexander's bill, and those who have not as yet done so should write

or wire to Mr. Alexander's committee at once. When you write refer to H.R. 13159 and address your letter to the Honorable J. W. Alexander, House of Representatives, U. S. Committee on The Merchant Marine and Fisheries, Washington, D. C.

A BILL TO FURTHER REGULATE RADIO COMMUNICATION.

Statement by the Navy Department.

This bill was introduced by Senator Fletcher, Chairman of the Senate Committee on Commerce, and by Judge Alexander, Chairman of the House Committee on the Merchant Marine and Fisheries, on November 21, 1918 (S. 5036 and H. R. 13159). A similar bill (H. R. 2573) has had the direct approval of the President, and the principles contained in the bill have the approval of practically all of the executive departments, as shown in the previous hearings before the House Committee on the Merchant Marine and Fisheries.

In general, the bill provides for the acquisition and operation, by the Navy Department, of all radio stations on shore used for commercial purposes. Irrespective of the general subject of government ownership, this principle is clearly indicated as necessary in the case of this particular public utility. Since the early days of the use of radiotelegraphy many companies have tried to operate radio stations as a commercial enterprise in the United States generally, or in certain localities. Except in very special circumstances, these enterprises have failed to make an adequate return, and in most cases no profit has been made except through the sale of stock. The reason for this is that a complete monopoly is necessary. That is, all stations must belong to one system. A period of about 18 years has clearly demonstrated that the United States Government is the only concern able to obtain and maintain such a monopoly, although many attempts have been made.

The first law regulating radio stations was enacted in 1912. At that time Congress recognized the fact that a complete system of radio stations having been established by the Navy Department for the national defense, the maximum public good could be obtained from them if they were permitted to assist commerce by handling the radio business of merchant ships. A certain number of naval radio stations were authorized to handle commercial business. This business has been successfully handled for four years. The Navy Department has demonstrated its ability to handle smoothly and efficiently, wherever permitted to do so, all communication between ship and shore, without any restrictions on the nationality of the ship or the ownership of the radio set on board, and quite irrespective of the ownership of the connecting land lines and cables to which the radiograms were delivered for further transmission if originating at sea, or from which traffic was received if destined seaward. The Navy Department is now prepared and desires to handle all commercial work of all stations.

The part played by high-power stations in this war and before the United States became a party to it, shows very clearly the necessity for Gov-

ernmental operation of these stations. Transoceanic radiotelegraphy is not a serious competitor of the cables. High-power stations are not yet able to receive from one another all day in all seasons, cable communication is secret, while signals from radio stations are transmitted in all directions, and all nations can read the business of all others. Only the most carefully devised codes can make radio traffic secret, and experts will not admit that any code or cipher cannot be broken in time. Signals from high-power stations become international matter at once. Even the signals of an ordinary shore station transcend the three-mile limit and are capable of interfering with the legitimate work of an installation under a foreign flag. Only by the most careful regulation of radio traffic, through international agreement, can the maximum good be obtained, and only by each nation having the operation of radio stations under its direct control can international agreements be properly executed.

In spite of the claims of inventors, radio communication is still hampered by atmospheric disturbances commonly termed "static" and by interference. In congested districts, as in the case of important seaports, communication is limited and must be controlled by a central organization, otherwise a serious situation ensues. In the case of high-power stations where there is a limit to the number of long wave lengths which can be used, interference is encountered regardless of the distance between stations. For instance, a station in Washington is liable to be interfered with by a station in San Francisco, while attempting to receive from France or Italy.

IT SHOULD BE NOTED THAT THIS BILL IS NOT TO CREATE A COMPLETE GOVERNMENT MONOPOLY. THE SCIENTIST MANUFACTURER AND SHIP OWNER ARE ESPECIALLY PROVIDED FOR, AND NO CHANGE IS PROPOSED IN THEIR STATUS UNDER EXISTING LAW. STATIONS MAY BE LICENSED FOR SPECIAL COMMUNICATION, AND THESE ARE EXEMPTED FROM GOVERNMENT OPERATION.

By agreement with the Department of Commerce, the licensing of stations above mentioned, the licensing of ship stations and of commercial operators for them would be transferred to the Navy Department, since naval operation of commercial shore stations would eliminate a number of the duties assigned to the Secretary of Commerce.

This is not a war measure. In accordance with the Act of 1912, all radio stations in the United States and possessions, which were not already in the Government's hands, were taken over by the Navy Department as a war measure, and are now being operated by that Department, promptly in April, 1917. Many changes have occurred during the war. Stations formerly operated commercially have been found to be unnecessary for either commercial or war purposes. On account of the submarine menace the necessity for instant control of troop convoys, and the sudden rise in importance of transatlantic communication for naval and military purposes, a few additional stations and some special arrangements were necessary on the Atlantic coast. The busi-

(Continued on page 665)

Radio Law and Existing Restrictions

By WILLIAM B. DUCK

The following interesting article by an attorney well versed in the subject, should answer the thousands of letters with which we, as well as all amateur Radio Supply Houses have been bombarded since Nov. 11th of this year.—
EDITOR.

MANY wireless amateurs never had very clear notions concerning the regulations of Congress upon wireless sets, and fewer yet grasped the legal effect of the existing restrictions upon the use of such apparatus.

The existing wireless law derives its authority and likewise its legality from the so-called interstate commerce clause of our national constitution, giving to Congress the right to regulate commerce among the several states. Were it not for this provision in our constitution, Congress never would have had any authority to legislate upon any phase of this subject. Our national constitution embodies a wide variety of powers given up by the thirteen sovereign states when the constitution was adopted. All other powers and rights were reserved by

the states. Consequently when Congress enacts any law, it must find its authority in some provision in the constitution. For instance Congress cannot pass any law regulating the rates of railroads both terminals of which are within the borders of the same state. The state only has such authority.

Our supreme court has given a very wide interpretation to the interstate commerce clause of our constitution. It has declared, for instance, that communication carried on by line wires extending from one state into another may be regulated by it. No wireless amateur has ever bothered to go to the expense of having the courts pass upon the question as to whether Congress has the power to license a transmitting station for exclusive use *between two cities in the same state*, if as an incident to this communication, the station may be heard beyond the borders of the state. In fact it is better for the amateurs that Congress compels the high power amateur stations to submit to its decrees in the regulation of their stations.

It is for this reason that the wireless law provides that no license is necessary for a

receiving station or for a transmitting station with a range within the limits of the state where located. If Congress had attempted to exercise jurisdiction over these stations the entire law would have been unconstitutional.

When the United States entered the world war, the president, on April 6th, 1917, as Commander in Chief of the Army and Navy, ordered all the wireless stations dismantled. The existence of a previous law on this subject in no way added to his power to order the stations closed. It was a military act, and its authority was founded on recognized law on this subject, which it is unnecessary to discuss here. It will be observed that the order of the president embraced all wireless equipment, both transmitting and receiving. The moment peace is declared, all amateurs will "ipso facto," without promulgation of any decree by the president or any one else, have the right to use their receiving sets and small power transmitting sets whose range does not extend beyond the border of the state. A great many other war powers will likewise cease at this time.

Experimental Physics

By JOHN J. FURIA, A. B., M. A., (Columbia University)

LESSON EIGHTEEN

Conduction of Electricity Thru Gases.

GASES, the air included, under normal conditions will not conduct electricity. However, when a high potential is established between two points in a gas, as for example when a Wimshurst Machine is excited or a spark coil operated, the gas offers less and

charge in that the former is the passage of electricity from one point in a gas to another point and the latter is the passing of a gas from a point into the surrounding gas. As more current is past thru the primary of the spark coil a higher potential is developed at the secondary terminals and therefore a longer spark is produced, i. e., the length of the spark is proportional to the potential; a one inch spark being produced by a potential of about 30,000 volts.

and hence form shadows when striking an obstruction. In figure 95A *c* is the cathode. A piece of metal hinged at its lower end stands in the path of the rays. A distinct shadow of the same shape as this obstructing metal is formed at the end of the tube. On dropping the tube down at the hinge by shaking the tube the shadow disappears.

Experiment 106

In figure 95B the cathode is concave and spherical. The other electrode (anode)



Fig. 95-A. Vacuum Tube for Demonstrating That Cathode Rays Cast a Shadow. The Rays Travel in Straight Lines, as the Metal Cross and Its Shadow Prove.

less resistance as the potential is increased and finally electricity is discharged between the two points. The subject of the conduction or the discharge of electricity thru gases with its causes, effects and results is a vastly important one. It has attracted the attention of the foremost Physicists and has given rise to modern Physics with all its information regarding the *electron*.

Experiment 103

Attach the terminals of a spark coil to a pair of combs consisting of several needle points and keep the pair separated by a distance several times greater than the rated spark length of the coil. Darken the room and a glow will be observed surrounding the points. If more current is supplied to the coil so that a higher voltage is developed, the glow will increase in size and intensity. This glow is technically known as a *brush discharge* or *corona*, see Fig. 93-A. Now bring the terminals of the spark coil close together. A spark jumps across the gap in a straight line path. See Fig. 93-B. As the terminals are gradually separated the spark passes thru an irregular path until finally the limit of the coil is reached and no spark passes. The *spark discharge* then differs from the brush dis-

Experiment 104

A straight glass tube about an inch and a half in diameter and fifteen inches long has platinum electrodes attached to aluminum discs. An air pump is connected at the opening *a*. The electrodes are connected to the secondary of a spark coil and also to the spark gap in figure 94, the gap being smaller than the rated spark of the coil. If the coil is now operated, a spark passes thru the gap *g* and nothing is observed in the tube. As the air in the tube is gradually exhausted by the pump the spark thru the gap disappears and a discharge is seen thru the tube which is neither spark nor brush. It will have the appearance of a ribbon of crimson light. The discharge then broadens out into a bluish, fuzzy column. When the pressure reaches about five-tenths of a millimeter of mercury, the negative electrode (cathode) becomes covered with a thin luminous layer. Next to this we find a dark space known as *Crookes' dark space*, next to which is a luminous part called the *negative glow*, and beyond this a second dark region known as

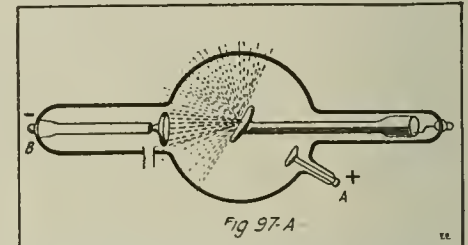

Fig. 97-A. For the Production of Concentrated X-Rays, a Special Form of Focus Tube is Used. Cathode Rays Coming from the Concave Electrode at Left, Converge and Strike Platinum Target at Right, Where X-Rays Are Generated.

consists of a small piece of very thin sheet platinum. The cathode rays are converged, focus on the platinum and are therefore very concentrated. The platinum incandesces, showing the heating effect of the cathode rays. Of far greater importance than either the fluorescent, the shadow, or the heating effect is the *magnetic effect*, especially as this gives us an insight into the nature of the cathode rays.

Experiment 107.

In figure 96 *a-b* is a fluorescent screen of zinc sulfid, or barium platino-cyanid; *c* is a mica strip with a narrow slit in it. The cathode rays emerging at *d* are absorbed by the mica *c*, except for a small part passing thru the slit. These travel straight thru for the full length of the tube and cause a narrow band of the screen *a-b* to fluoresce brilliantly. Hence, the path of the rays, which are themselves *invisible*, is readily seen. If now a horseshoe magnet is brought near the tube the rays are deflected toward it at right angles to the magnetic field. This is precisely what would happen if the cathode rays con-

(Continued on page 670)



Fig. 96. Deflection of Cathode Rays by a Magnet. The Screen *a-b* is of Fluorescent Material, So as to Make the Rays Visible.

the *Faraday dark space*. From this space to the positive electrode we have the *luminous positive column*. By adjusting the pressure slightly the positive column can be made to divide up into a series of luminous and non-luminous spaces called *striae*. (Geissler tubes are partially evacuated tubes bent into fancy shapes and surrounded with jackets containing colored liquids to produce pretty color effects.) If the pressure is lowered still further, to about 1/100 part of a millimeter, the column will gradually disappear and the walls of the tube will begin to fluoresce, the fluorescing color depending on the nature of the glass. This fluorescence is produced by streams of small particles issuing from the cathode and we consequently call them *cathode rays*. This fluorescent property of cathode rays is useful as a means of detection and observation of the rays. Glass is not the only substance to fluoresce under the bombardment of cathode rays. Calspar, barium platino-cyanid, potassium cyanid, yttrium and thorium also fluoresce.

Experiment 105

Cathode rays travel in straight lines



Fig. 97-B. Typical X-Ray View of the Hand, Showing Rings on the Finger.

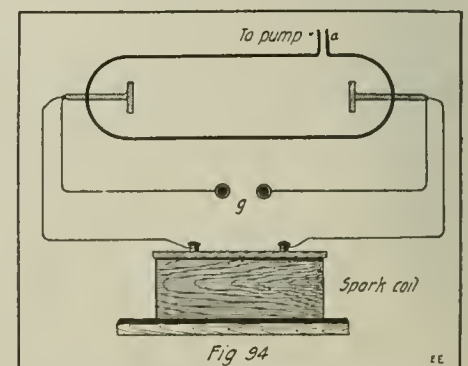

A Variable Vacuum Tube Experiment with a Spark Coil. As the Vacuum Increases an Electrical Discharge Begins to Take Place Within the Tube.

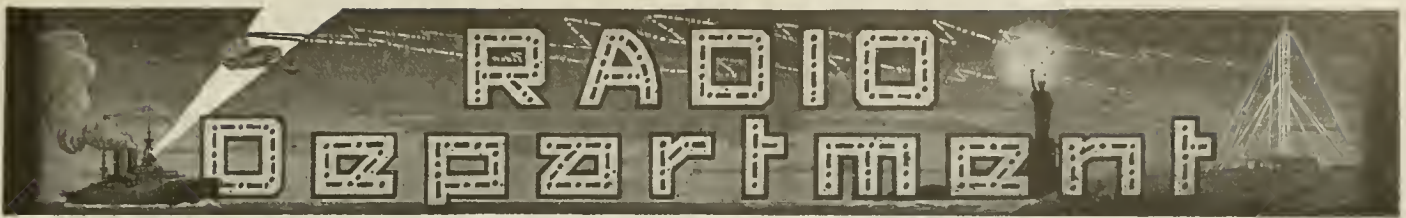

The Effect of Statics on Wireless Transmission

By NIKOLA TESLA

Written for the ELECTRICAL EXPERIMENTER

A FEW statements regarding these phenomena, in response to a request of the ELECTRICAL EXPERIMENTER, may be useful at the present time in view of the increasing interest and importance of the subject.

The commercial application of the art has led to the construction of larger transmitters and multiplication of their number, greater distances had to be covered and it became imperative to employ receiving devices of ever increasing sensitiveness. All these and other changes have co-operated in emphasizing the trouble and seriously impairing the reliability and value of the plants. To such a degree has this been the case that conservative business men and financiers have come to look upon this method of conveying intelligence as one offering but very limited possibilities, and the Government has deemed it advisable to assume control. This unfortunate state of affairs, fatal to enlistment of capital and healthful competitive development, could have been avoided had electricians not remained to this day under the spell of a delusive theory and had the practical exploiters of this advance not permitted enterprise to outrun technical competence.

With the publication of Dr. Heinrich Hertz's classical researches it was an obvious inference that the dark rays investigated by him could be used for signalling purposes, as those of light in heliography, and the first steps in this direction were made with his apparatus which, in 1896, was found capable of actuating receivers at a distance of a few miles. Three years prior to this, however, in lectures before the Franklin Institute and National Electric Light Association, I had described a wireless system radically opposite to the Hertzian in principle inasmuch as it depended on currents conducted thru the earth instead of on radiations propagated thru the atmosphere, presumably in straight lines.

The apparatus then outlined by me con-

sisted of a transmitter comprising a primary circuit excited from an alternator or equivalent source of electrical energy and a high potential secondary resonant circuit,

nature of the effects, are making installations so defective in construction and mode of operation as to preclude the possibility of the great realization which might

be brought within easy reach by proper application of the underlying principles and one of which—the most desirable at present—is the complete elimination of all static and other interference.

During the past few years several emphatic announcements have been made that a perfect solution of this problem had been discovered, but it was manifest from a casual perusal of these publications that the experts were ignoring certain truths of vital bearing on the question, and so long as this was the case no such claim could be substantiated. I achieved early success by keeping the steadily in mind and applying my efforts from the outset in

the right and correct scientific direction.

I may contribute to the clearness of the subject in answering a question which I have been asked by the Editors of the ELECTRICAL EXPERIMENTER with reference to the report contained in the last issue, that signals had been received around the globe, an achievement the practicability of which I have fully demonstrated by experiment eighteen years ago.

The question is, how can Hertz waves be conveyed to such a distance in view of the curvature of the earth? A few words will be sufficient to show the absurdity of the prevailing opinion propounded in text books.

We are living on a conducting globe surrounded by a thin layer of insulating air, above which is a rarefied and conducting atmosphere. If the earth is represented by a sphere of $12\frac{1}{2}$ " radius, then the layer which may be considered insulating for high frequency currents of great tension is less than $1/64$ of an inch thick. It is held that the Hertz waves, emanating from a transmitter, get to the distant receiver by successive reflections. The utter impossibility of this will be evident when it is shown by a simple calculation that the amount of

(Continued on page 658)

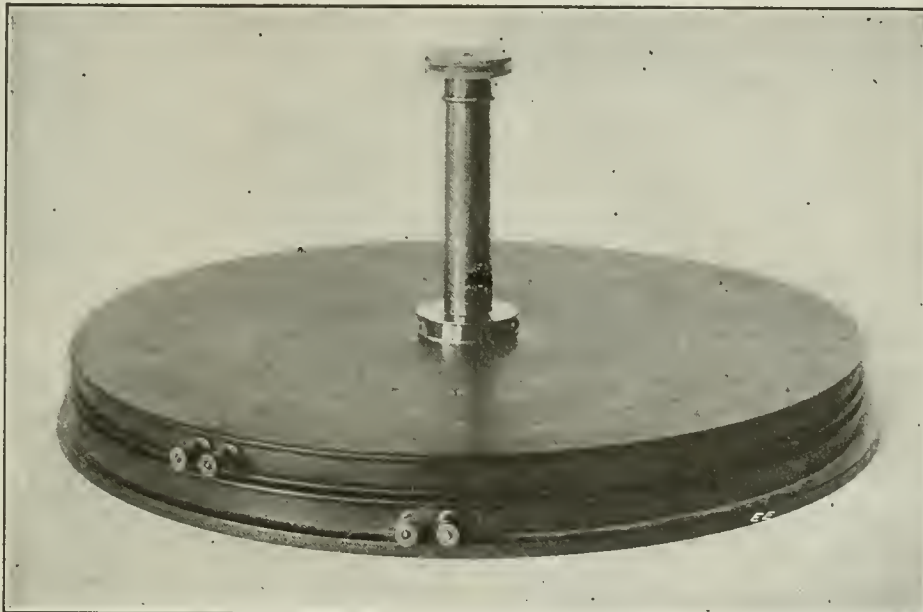

Tesla's Static Eliminator, Patented and Used by Him over Twenty Years Ago. It Will Be Fully Described In an Early Issue of the Electrical Experimenter

connected with its terminals to ground and to an elevated capacity, and a similar tuned receiving circuit including the operative device. On that occasion I express myself confidently on the feasibility of flashing in this manner not only signals to any terrestrial distance but transmitting power in unlimited amounts for all sorts of industrial purposes. The discoveries made and experimental results attained I made with a wireless power-plant erected in 1899, some of which were disclosed in the Century Magazine of June, 1900, and several U. S. patents subsequently granted to me have, I believe, borne-out strikingly my foresight. In the meantime the Hertzian arrangements were gradually modified, one feature after another being abandoned, so that now not a vestige of them can be found and my system of four tuned circuits has been universally adopted, not only in its fundamentals but in every detail as the "quenched sparks", "ticker", "tone wheel", high frequency and rotating field alternators, forms of discharges and mercury breaks, frequency changers, coils, condensers, regulating methods and devices, etc. This fact would give me supreme satisfaction were it not that the engineers, misinterpreting the

GERMANS USE BICYCLE DYNAMO TO OPERATE RADIO SET.

The accompanying illustration shows an ingenious German method of generating the



The Above Illustration Shows an Ingenious German Method of Generating Electricity for a Wireless Installation in the Trenches, Captured in a British Advance. A tandem bicycle with its wheels removed has been fixed to the ground, and the pedal wheels connected by belting with a small dynamo.

necessary electric current for operating a radio installation in the trenches, which was captured in a recent British advance. As the photograph shows, a tandem bicycle with its wheels removed has been fitted with a supporting frame so as to stand upright and the pedal wheels connect with a belt to a small dynamo.

Such an outfit will produce considerable

electricity which can be used for radio or lighting purposes, etc. In fact, this scheme is not new to the American wireless amateur, for we published an article on such a device for producing current to operate a wireless transmitter several years ago. A person sitting on a bicycle fitted with proper gearing, exerts a great deal more power than would be imagined off hand, and besides for warfare requirements the outfit is noiseless, albeit it is not quite so handy as the small gasoline engine outfits used by some of the other armies.

NEW TELESCOPING RADIO TOWER.

A device that promises to be of great importance to the field wireless service is a telescopic tower that can be raised almost instantly on the throwing of a lever. This tower,

the invention of R. W. Dean, of Des Plaines, Illinois, has been presented to the Government, says *The Oscillator*.

The tower that carries the wireless aerial works on an extremely simple principle. A number of light steel pipes fit inside of one another, the space between them being made air-tight by a series of washers at the top of each but the middle pipe. The

base-pipe connects with a compressed-air reservoir which is always kept filled by an air-pump.

The operators turn on the compressed air lever. Air from the tank rushes to the top of the innermost pipe and pushes up on it with a force upward of twenty-five pounds for every square inch of its surface. The sections shoot upward, one after another.

Of the 8,000 girls who applied for service as military telephone operators with the American forces abroad 650 were accepted.



No Wonder the Naval Radio Students at "Harvard" Get a Headache Now and Then. Excuse Him, Folks, If He Don't Write Every Day. The Boy Is Busy! What?—Courtesy the "Oscillator."

Marconi Company Claims Famous "Static Preventer" Discovery

"With the conditions that pledged us to absolute secrecy no longer prevailing, the Marconi Wireless Telegraph Company of America is permitted to announce a discovery and invention in wireless telegraphy that will mark a new era in world communication," says a statement issued by Edward J. Nally, Vice-President and General Manager of the Marconi Wireless Telegraph Company of America.

"Ever since the genius of Marconi made wireless telegraphy a fact, the only limitation of this method of communication was the deadly phenomena of 'static conditions.'

"It remained for an American radio expert, Roy A. Weagant, Chief Engineer of the Marconi Wireless Telegraph Company of America, to discover the solution of the static problem.

"Among the revolutionary changes that the new system effects in wireless installations will be the immediate disappearance of the huge steel towers, heretofore built at great heights to catch the incoming wireless waves. Equipped with the Weagant invention, the wireless receiving antennae are stretched merely a few feet above the ground.

"Heretofore, also, the increasing number of high power stations that were being erected in every part of the world raised the difficult question of 'interference.' Crossing wireless messages that shot thru

the ether sometimes made the wireless signals so indistinct that they could not be understood, or drowned the weaker transmission entirely. The Weagant system, based on a unique selective principle, eliminates 'interference' and permits absolutely clear communication, regardless of the operation of other stations even in the immediate vicinity.

"The notable contribution to wireless telegraphy opened by Mr. Weagant's discovery makes continuous wireless communication over the oceans and between continents an absolutely assured fact for twenty-four hours of the day and at every season of the year, regardless of atmospheric conditions. All the Marconi high power stations are being equipped with the Weagant system, and the stations of the Pan-American Wireless Telegraph and Telephone Company, which are to link North and South America, will likewise be equipped."

This invention sounds almost too good to be true. However, Mr. Weagant, in an interview with the *ELECTRICAL EXPERIMENTER's* representative, stated that by very careful study of the subject over a considerable period, discovery of an entirely new basic principle had been made, and by accident at that. It was not expected, but while making investigations along other lines this particular effect became more and more noticeable until it developed into a full-fledged invention. "As soon as of-

ficial 'Peace' is declared," said Mr. Weagant, "I will present a technical paper before the Institute of Radio Engineers, describing the invention. Also a body of technical men will be invited to one of our stations to hear it work."

SHIPS PERMITTED TO USE RADIO AGAIN.

Announcement has been made by the Naval Communication Service that commercial wireless traffic between United States merchant vessels and naval radio shore stations would be resumed at once.

This means that wireless messages may be sent to passengers on board steamships and that travelers at sea may communicate with shore.

During the war steamships were forbidden to use their wireless except to listen, the precaution being taken to prevent submarines and surface raiders from learning of the positions of Allied vessels.

OCTOBER MEETING OF INSTITUTE OF RADIO ENGINEERS.

The Institute of Radio Engineers held a meeting on the evening of Wednesday, October 9, 1918, in the Engineering Societies Building, New York.

A paper on "SPECIAL HEATING EFFECTS OF RADIO FREQUENCY CURRENTS," by PROF. EDWIN F. NORTHROP of Princeton University was given.

Radiotelephone Guided U. S. Flyers Many Miles Away

SQUADRONS of American airplanes fighting in France up to the moment of the armistice, were maneuvering under the vocal orders of the squadron commander that reached each pilot by radiotelephone. News of the successful development of

greatly resembles an ordinary incandescent lamp. This bulb contains two additional elements besides the usual incandescent filament, which are known as the *plate* and *grid* respectively. In these oscillations, the grid consists of a spiral winding of very fine tungsten or other wire wound upon a glass frame, and so placed as to entirely surround but not touch the filament. The plates, of which there are two, are placed one on each side of the filament, outside of, but not in contact with, the grid. In operation, the oscillation or vacuum bulb, oscillation generator requires two sources of potential, one of low voltage for lighting the filament, and one of high potential for supplying current from plate to filament across the vacuous space within the tube. A small motor-generator suitably wound to supply the proper voltage is generally

which is capable of generating oscillations by a re-action between two or more tuned circuits, so that either damped or undamped oscillations can be interpreted. Fig. 1 of the accompanying views shows a complete airplane Radiophone oscillation transmitter, especially designed for military

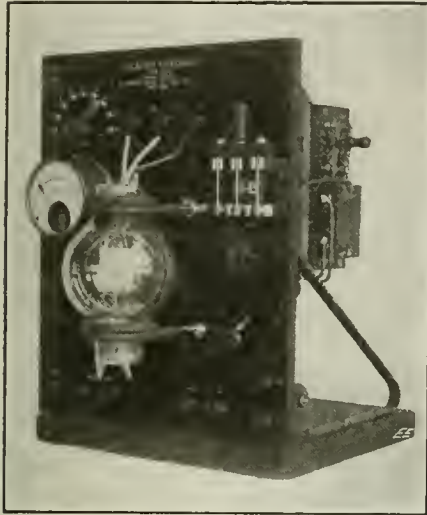

Fig. 5. High Power Oscillation Bulb Radiotelegraph Transmitter. The Meter At the Left of the Panel is a Hot-Wire "Radiation Current" Indicator.

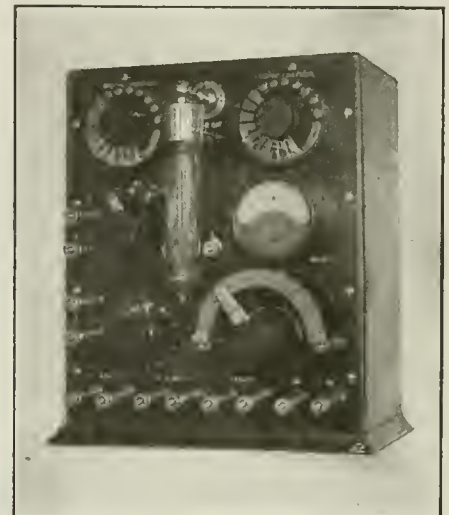

Fig. 4. New Vacuum Tube Control Cabinet. 110 Volt Direct Current is Frequently Used On These Sets for the Wing Circuit, Using a Suitable Potentiometer in the Circuit.

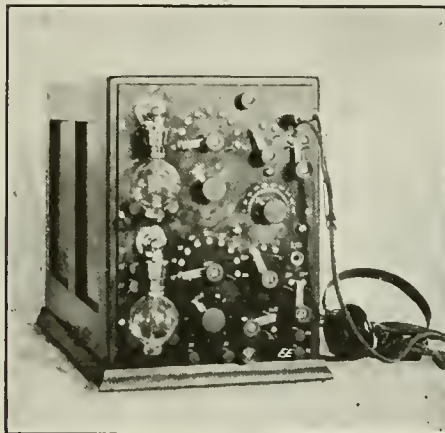

Fig. 2. New Combination Audion, Ultra-audion and One-Step Amplifier Designed By de Forest.

this device, hitherto a military secret, tho some inkling of it had reached the Germans just before hostilities ceased, was made public recently by John R. Ryan, Director of Aircraft Production.

"There are some details concerning it which we cannot discuss yet," Mr. Ryan said, "but the radio devices worked out during months of experiment went into actual service some weeks ago. I have myself, standing on the ground, given orders to a squadron flying in the air and watched them maneuver accordingly.

"The transmission of the voice is clear enough to be heard distinctly thru the sound of the airplane motor. It is in every way the most satisfactory means of communicating between 'planes in the air and from the ground to 'planes."

The distance over which the radiotelephone talks from earth to 'plane is a matter of several miles.

"For some months," said William C. Potter, of the Equipment Division of the Bureau, "it has been possible in our offices in Washington to hear the 'planes flying miles over the city, talking to each other and to the ground as they worked out and perfected the device."

The accompanying views show several new wireless telephone apparatus which can also be used for wireless telegraphic transmission when desired and utilizing the De Forest *Oscillation* bulb, having a filament, grid and wing. The oscillation comprises an exhausted glass tube or bulb, the size of which depends upon the output in watts, and which

employed as the most convenient source of current. Reception of radio-telephonic or telegraphic waves is accomplished by the use of a similar but smaller sized vacuum bulb,

use. In this set the weight has been reduced to a minimum. A special *chopper* or calling key is fitted to the instrument as well as a special type of microphone for modulating the oscillations in the form of speech waves. At the left of the photograph will be observed a small dynamo resembling an airplane bomb, one end of which is fitted with a small size propeller. This dynamo is driven by the force of the air turning the propeller, as the airplane speeds along, and thus current is produced for the operation of the oscillation. The

large oscillation bulb is enclosed in a wire cage to protect it from breakage, and the necessary measuring instruments are mounted on the front of the panel, viz: a hot wire ammeter in series with the antenna circuit to measure the radiation current, a milli-ammeter indicating the "B" battery current, and a filament battery ammeter. Suitable tuning inductance and capacity control knobs are mounted on the front of the panel. The connections between the various parts of the apparatus are accomplished with flexible twin conductors sewn in leather straps, the ends of which are provided with separable jack plugs.

The illustration in Fig. 2 shows a combination audion, ultra-audion and one-step amplifier. This combination is similar to the audion two-step amplifier outfit, with the exception that the apparatus is arranged for one-step amplification. This set will meet conditions perfectly, it is claimed, where the intensity of the normal signals does not

(Continued on page 651)

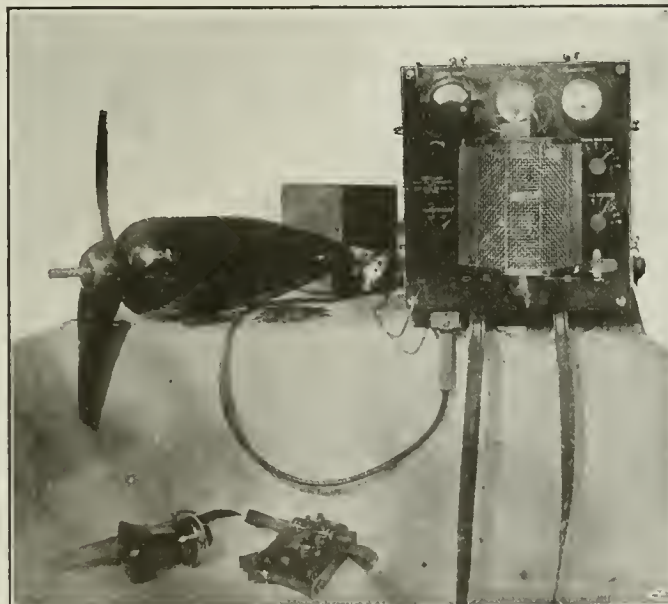

Fig. 1. Complete Airplane Radiophone Oscillation Transmitter Fitted With Self-Exciting Generator of the Wind-Driven Propeller Type (Left), "Chopper" Calling Key and Oscillation Bulb in Guard.

The Manufacture of Vacuum Detectors

By O. B. MOOREHEAD

ALTHO the majority of radio engineers are familiar with the use and operation of vacuum tube detectors, a brief description of their manufacture may be interesting. In the early experimental work on this type of device, we strove to produce a detector which would combine maximum operating efficiency with inexpensive manufacture. The next point considered was the production of desirable conditions, i. e., tubes that possess oscillating characteristics, tubes that were exceptional detectors, and tubes that displayed both qualities, says O. B. Moorehead, in a paper recently presented before the Institute of Radio Engineers. The third consideration was the production of a device easily handled and shipped without disturbing the adjustment of the elements and damaging the filaments.

Tubes and bulbs of various shapes and sizes were tried, using a gaseous medium ranging from one millimeter to 0.025 millimeter of vacuum, many materials being employed as elements. Various exhausts were applied, but it was soon found that the employment of a gaseous medium introduced considerable difficulty in the matter of accurate reproduction of a desired result. Gases at pressures ranging from one millimeter to 0.0013 millimeter were next experimented with.

I found that a tube containing a platinum filament in an atmosphere of hydrogen, at pressures comparable with one millimeter, gave fair results. Tungsten filaments were then tried in higher vacua as well as at the so-called "gaseous medium" pressure. It was immediately noticed that conditions could be duplicated as soon as a vacua above that which allowed a "gaseous medium" to exist, were obtained. Moreover, tungsten was ideal as a filament not only because of its refractory qualities and low volatility but also because it acts as a purifying agent by attacking any traces of residual gases that may remain in the tube and forming compounds which are then volatilized on the walls of the tubes.

As the parts are small and complicated, the glass is worked before the blowpipe, after it has been brought into the form of tubes by the glass works. This tubing is obtained by first blowing a bulb, then fusing an iron rod to a point diametrically opposite the blowpipe and rapidly separating the two points of attachment from each other.

Various grades of glass were experimented with, and a mixture containing a high percentage of lead and a small quantity of silicic acid was found to be the easiest to work and produced a detector of

maximum sensitiveness when used in conjunction with the aluminum plate and copper grid. In the selection of the glass to be used, the devitrification of the glass had to be considered, as during exhaustion of the tubes it is necessary to subject them to

successfully closes the pores of the metal.

The exhaustion of the tubes is the most important operation because of the fact that the low vacuum of the round bulb, nickel element audion which permits of gas conduction is not used in the tubular "electron relay,"

wherein all gas phenomena must be eliminated.

To produce the high vacuum necessary, I have found that a Gaede mercury pump capable of producing a vacuum of 0.00001 millimeter, backed by a piston pump, such as the Geryck type, is the most satisfactory method of evacuation.

The manifold to which the tubes to be exhausted are attached and the vacuum line connecting the manifold to the pumps, are preferably made of large diameter tubing. A container filled with pentoxid of phosphorus is connected in the vacuum line between the pump and the manifold. The manifold is contained in an oven heated by gas and arranged so that the tubes during exhaustion may be



"A Great Moment We All Experienced"—Not Many Moons Ago. This Self-explanatory Oscillation the Third, Comes From Over the Bounding Foam Via Wireless Operator H. B. Burney, of H. M. C. S. Stadacona.

a temperature near the point of softening and nearly all glasses, when maintained at this temperature for any length of time, have a tendency to separate out into the crystalline state.

There has been considerable discussion regarding the elements in this type of device and I may say that aluminum plates and copper grids were first selected on account of their electro-chemical relation to the tungsten filament. Later, numerous other metals were tried under the same and other conditions of exhaustion and showed widely different operating characteristics.

The selection of metals for the elements is very difficult, as a slight difference in either the copper or aluminum changes the whole system of exhaust. For instance, copper and aluminum purchased from one factory lot will require a certain degree of applied temperature during the evacuation, while another factory lot of the same weight and size will require an entirely different exhaust.

I have eliminated this variation to some extent by subjecting the aluminum plates to a temperature of approximately 600 degrees Fahrenheit (315° C.), immersing them in a saturated solution of cyanide of potassium, and finally rinsing in alcohol. The copper is subjected to heat until it glows, when it combines with the oxygen of the air to form a black, brittle oxid which breaks off in scales and exposes the underlying metal which is of rose red color. It is then placed in a current of moist air and becomes covered with a layer of oxygen compounds, which remains very thin but

heated to high temperatures.

The lead glass tubing, used as the container for the elements in the tubular type detector, is obtained from the glass works in lengths of 6 feet (2 m.) with an inside diameter of 0.875 inch (2.2 cm.) and a wall of 0.032 inch (0.7 mm.) thickness. This tube is cut in lengths of about 6 inches (15 cm.) and one end is drawn down to a point. Two stems are made of glass tubing similar to those used in an incandescent lamp, one stem contains the grid and two filament leads, and the other contains the plate connection and one filament lead. After the wire is sealed into these stems, they must be annealed very carefully. The annealing consists in allowing the temperature to drop very slowly, since quickly cooled glass is subject to internal strains which arise in the following manner: In rapid cooling, a low temperature is soon established at the surface and the outermost layer solidifies while the interior tends to contract, thereby exerting a pressure on the outer layer which is directed inwards. This may cause the stem to crack.

After the stems are annealed, the grid is wound to the proper diameter and the filament is clamped onto the two leads. The plate is mounted on the other stem and the two stems are then connected together by means of the filament. Final adjustment of the plate and grid is then made. The spacing between the elements is not very critical in this type of device, but it is best to wind the grid to a large enough diameter so that it will strike the plate rather

(Continued on page 671)

A Vertical Cabinet Type Coupler

By JOSEPH H. KRAUS, Jr.

CABINET couplers, altho handsome and efficient, are quite expensive, even if the amateur attempts to make one himself. In the following article is given a description of a large cabinet coupler which did remark-

is being wound and the nails will act as grips for the axle (Fig. 1). A crank is now fastened to one end of the axle and the whole is suspended from two "Y" shaped uprights nailed to the opposite ends of a small box (Fig. 2). By using this cotton-waste method there is no necessity of fitting a rod tightly into the tube and a lathe is not essential. The winding is now commenced three-fourths of an inch from one end of the tube and a tap eight inches long is taken off every turn for the first twenty turns. Number these starting with the first wire as No. 20, then 19, 18, 17 and so on down until we get No. 1, and then No. 0. These taps must not be taken off directly under each other, but they zig-zag or spiral one-third around the tube, so as not to allow the least chance for a short circuit between two turns. Each must be carefully insulated and No. 22 black enamel wire used.

The manner in which a tap is taken off doesn't make much difference and every Amateur has a method of his own. However, here are two "standard" methods. For the primary the preferred method is to solder a wire to the place where the tap is taken off and insulate it carefully. Another method is to twist a loop into the wire and then continue winding; this will constitute a double wire lead (see Fig. 3). (This method will save trouble in the secondary winding.)

After the twentieth tap has been taken off (No. 0) the wire is wound for twenty turns and then a tap taken off. In this way the tube is wound until one-half inch

wound with No. 30 enamel wire. Leave a length of eight inches at one end and commence winding one-half inch from the end. A tap of the loop variety (Fig. 3) is taken

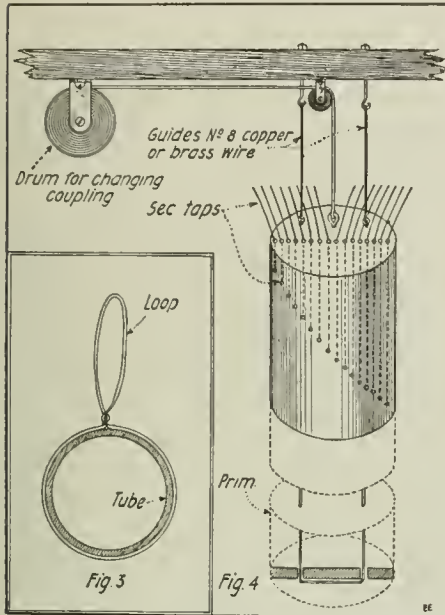

Arrangement of Vertical Coupler Secondary, Showing Friction Held Drum on Which Cord Supporting the Secondary is Wound. The Taps Are of Flexible Stranded Lead and Cabled Together.

able work and the cost was surprisingly low. An instrument such as this is an asset to any station and will well repay the ambitious Radio Amateur for the time and trouble involved.

THE PRIMARY (WINDING WITHOUT A LATHE)

Two cardboard tubes are first procured, eleven inches long by five and four and one-half inches in diameter, respectively.

The five inch diameter tube is first wound in the following manner: In the center of a rod of wood about two feet long and of a diameter that will easily pass into both the five and four and one-half inch tubes (a broomstick handle will do) drive several nails, in such a manner that their heads protrude about one-half inch from the wood. This wooden rod is then placed in the five inch primary tube and held as near to the central axis as possible while cotton waste is packed in around the axle. The friction of the cotton waste against the tube will prevent it from slipping when it

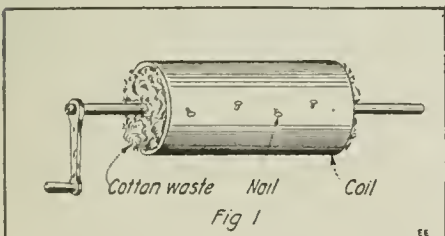

The Cardboard Tube on Which the Wire is to Be Wound is Mounted on the Crank of the Winding Rig by Stuffing Cotton Waste Inside It.

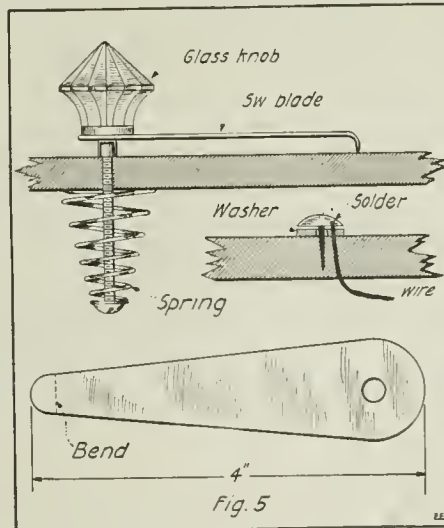

Detail of "Glass" Knob Switches Used on Vertical Coupler Here Described. They Give Very High Insulation Efficiency.

from the other end and one tap taken off every twenty turns. These may be taken off in a perpendicular line, as there is enough winding between each to prevent a short. Number the taps in order from one to fifteen. The wire if carefully wound will result in about thirty-six turns per linear inch, and wound for a little more than 8 3/4 inches, will net 320 turns, giving twenty taps of one turn each and fifteen taps of the twenty turn variety. Remove from crank and shellac well.

THE SECONDARY

The secondary or four and one-half inch tube is now mounted in the same way and

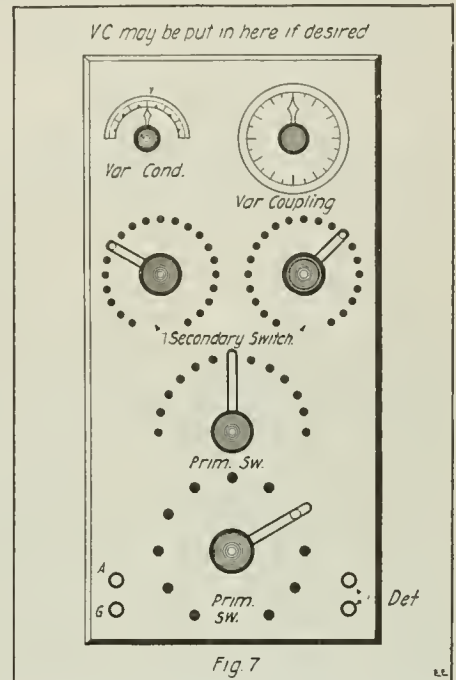

Front View of Finished Panel of Vertical Coupler Receiving Set. The Variable Coupler Control Handle is Placed in the Upper Right Corner of the Panel.

off every three-quarters of an inch of winding. These loops are made one inch long and are taken off spirally one-third way around the tube. As the winding proceeds and as each tap is taken off a hole is punched into the cardboard tube immediately under each tap and a match stick inserted into the opening; each respective tap is to be drawn thru its particular opening. When complete there should be fifteen taps. Now to each of these is soldered a piece of flexible cotton or silk covered wire about twenty inches long, a piece of rubber tubing slipped over the joint and the wire drawn thru the center of the coil toward one end thru its respective opening. Number each tap in order, shellac and allow to dry.

Note: These wires are not soldered on until the tube has been fully wound and removed from the crank.

(Continued on page 671)

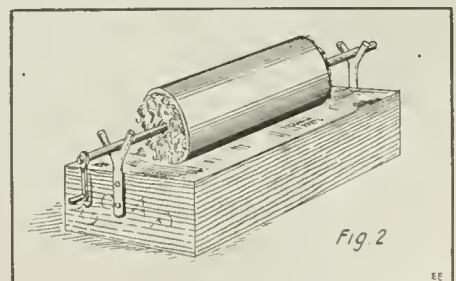

Where No Lathe is Available for Winding the Coil, Resort May Be Had to a Home-made Winding Rig Like That Shown.

NEW "BUMBLE-BEE" HY-TONE CODE PRACTISE SET!

Here's the hy-tone code teaching outfit you have been looking for, Radiobugs!

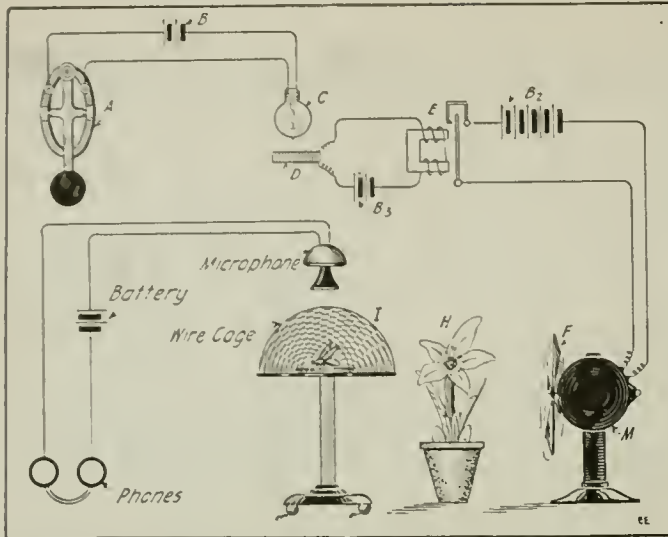

No Buzzer Gives a True Musical Note—But the Bumble-bee Does! Hence, Combine the Bee, a Fan to Waft, Periodically, an Aroma of Hyacinth His Way, When We Have a Pure Musical Note Producer. The Microphone Carries His Tuneful Buzzings to Our Ears, Via the Telephone Receivers.

The set works as follows: The sending key (A) closes the circuit thru the battery (B) and lamp (C). The light works the selenium cell (D), operating the relay (E), which closes the circuit of the specially quick-starting and stopping motor (M). A fan (F) on the shaft of this motor plays a breeze on the plant (H), wafting an *Aroma de hyacinth* to the unsuspecting bumble-bee (I), which is tuned to a clear hy-tone. The microphone picks up the bumble-bee's buzzes faithfully and reproduces them in the telephone receivers. Every time you press the key it buzzes. Voila! Contributed by

WM. E. R. MIDDLETON.

WIRELESS MESSAGES REACH ARCADIA, CAL., FROM BROOKLYN YARD.

The wireless station at Arcadia, Cal., by using for an aerial the cable of a balloon, put aloft from the training field, has intercepted messages sent by the Brooklyn Navy Yard wireless station, according to an announcement by the War Department. This balloon cable probably makes the highest aerial in the world.

This announcement was made by the Division of Military Aeronautics, indicating increasing efficiency in both the work of students and the equipment of the War Department's various balloon training fields. The balloon school at Arcadia has 106 miles of wire in use for teaching military communication. For the purpose of demonstration it has a complete system of wiring strung as it would be in the front line trenches on the battlefield. Communication posts and stations for all kinds of messages are used by the students the same as soldiers use them at the front.

A good part of the country southeast and southwest of Arcadia is laid out with lines of communication to this balloon school, similar to part of a sector at the front. All of the balloons, when aloft, are so wired that they can be lined together with any trench, doubled up for any work together, or they can be cut off from the trenches and talk only with their own chart room and winch or operating crew on the ground below.

It is reported that the U. S. Government purchased the Sayville, L. I., Radio Station shortly after the declaration of war.

SPAIN TO AMERICA BY AIR IS PROJECT IN MADRID.

Captain Herrera, chief of the Spanish military air forces, has had a number of interviews with King Alfonso on the subject of an aerial postal and passenger service between Spain and the United States. The scheme also has been discussed at Cabinet meetings and it is said that a leading shipping company is willing to finance it.

The plan, it is understood, is to manufacture large airships capable of carrying forty passengers, besides the mails. The rate charged for a passenger, if the scheme is carried out will be \$400, and letters will be charged for at the rate of \$1 per hundred grams weight (about three ounces and a half). It is estimated the journey would take two and a half days.

A BATTERY-LESS TELEGRAPH.

A simple telegraph set may be put up between two chums' houses by running a small wire from house to house about 20 feet above the ground and 50 feet from the lighting wires in the street; connecting a key and receiver as shown in the following diagram. No batteries will be needed. One wire is grounded to the gas or water

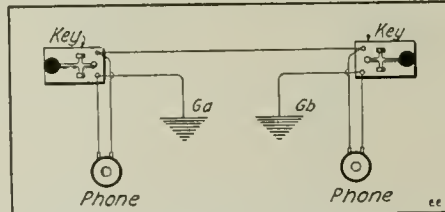

A Batteryless Telegraph System. It Operates by Induction from a Nearby A. C. Lighting Circuit.

pipe. It works by induction from the lighting circuit.

Contributed by RAY I. MILLER.

[Where no lighting line is in the neighborhood, bury a zinc plate in moist earth at G_a and a copper plate at G_b . This system was once used by the editor, and by using a 75 ohm receiver at each station, satisfactory results were had over 1/2 mile. This "ground battery" gives about .07 volts. —Editor.]

AN ENANT THAT RADIO COMPUTATION GRAPH.

By K. N. Cummings, Asst. Engineer, Marconi W. T. Co., of Canada.

WITH regard to the article in your September issue, "A Graph for Solving Wave Length, Frequency, Inductance and Capacity," I would like to point out that all the commercial values of the quantities can be represented by use of the two squares of the published diagram bounded by the lines representing one milli-henry, 0.1 milli-henry, 10^{-4} uf. and 10^{-2} uf. (uf. = microfarad.) To do this two inductance scales are required as in the diagram herewith.

Each diagonal line represents two wave lengths, one being ten times the other, as shown for 600-6,000 and 2,000-20,000 meters; giving directly a range of 600 to 20,000 meters, the left-hand inductance scale being used for the lower range of wave length, the right-hand for the upper range.

Only a part of the commercial waves below 600 m. are obtainable directly, but values not on the chart can easily be obtained as follows: To find, say, the inductance required for 300 m. with 0.003 uf., note that the 0.003 uf. line intersects the 3,000 m. line at 0.00084 h. Divided by 100 we obtain 0.0000084 h., the required value. In general, using the line representing 10 times the wave length, divide the value indicated by the graph by 100 and vice versa. Values of inductance and capacity not shown directly may be used as follows: Suppose we wish to find the inductance required with a wave of 8,000 m. and capacity of 1.7 uf., which are approximate values of the Glace Bay transmitter primary; divide the capacity by 1,000. The line for 1.7×10^{-3} intersects the 8,000 m. line at about 1.06×10^{-3} h. Dividing by the same number by which we divided the capacity (1,000) we obtain 1.06×10^{-6} h., the required value. The procedure would be exactly similar with a known inductance and wave length.

By extension of the above procedure, which is simply based on the fact that wave length varies as the square of the capacity or of the inductance, as the case may be, and that the product of capacity and inductance is constant for any particular wave length, we can obtain any wave length, inductance and capacity, but if many values are required which are not on the chart, it would be better to construct another pair of squares of the original graph from which the values could be read directly. The advantage of this graph over the original one is its increased scale, which is ten times that of the original for the same size paper. It is also easier to construct, the number of logarithmic lines required being but 3/17 of the number required for the original.

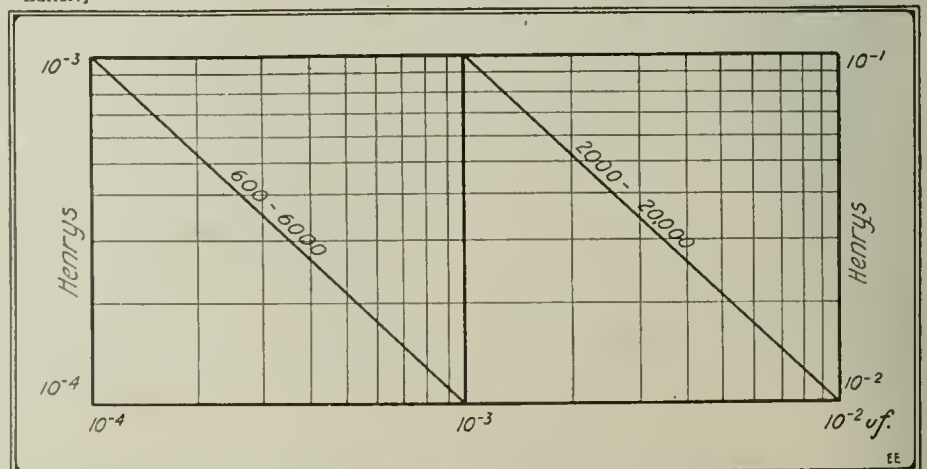

For All Ordinary Radio Calculations This Simplified Graph Fills the Bill as Well as the Larger One Published in the September Issue. It Gives the Value of Inductance and Capacity for Wave Lengths from 600 to 20,000 Meters.



Building a 3-Inch Spark Static Machine

By DR. E. BADE

FRICTION is one of the commonest sources of static electrical excitation. Every one has noticed how the hair crackles under the comb in dry weather. The same sound is heard on stroking the back of a cat, and, if the room is dark, sparks may be drawn from pussy's fur. But for developing large quantities of electricity by friction a static machine is

up. But before they are fastened two holes of suitable size for a glass rod which is used as an axle are provided for.

A round glass plate one foot in diameter is procured. This is usually the most expensive part of the machine. It is best to purchase it from a large electrical supply house, so that one does not get a plate unsuited for electrical purposes. A glass

Each of the two rubbers consist of a board on which soft, thick felt is glued. A spring presses the rubbers lightly against the glass plate. In order to prevent the rubbers from falling out a short piece of wood is nailed to them so that it projects and catches against the frame. Each rubber is now covered with an amalgam consisting of two parts of mercury, one part of tin, and one

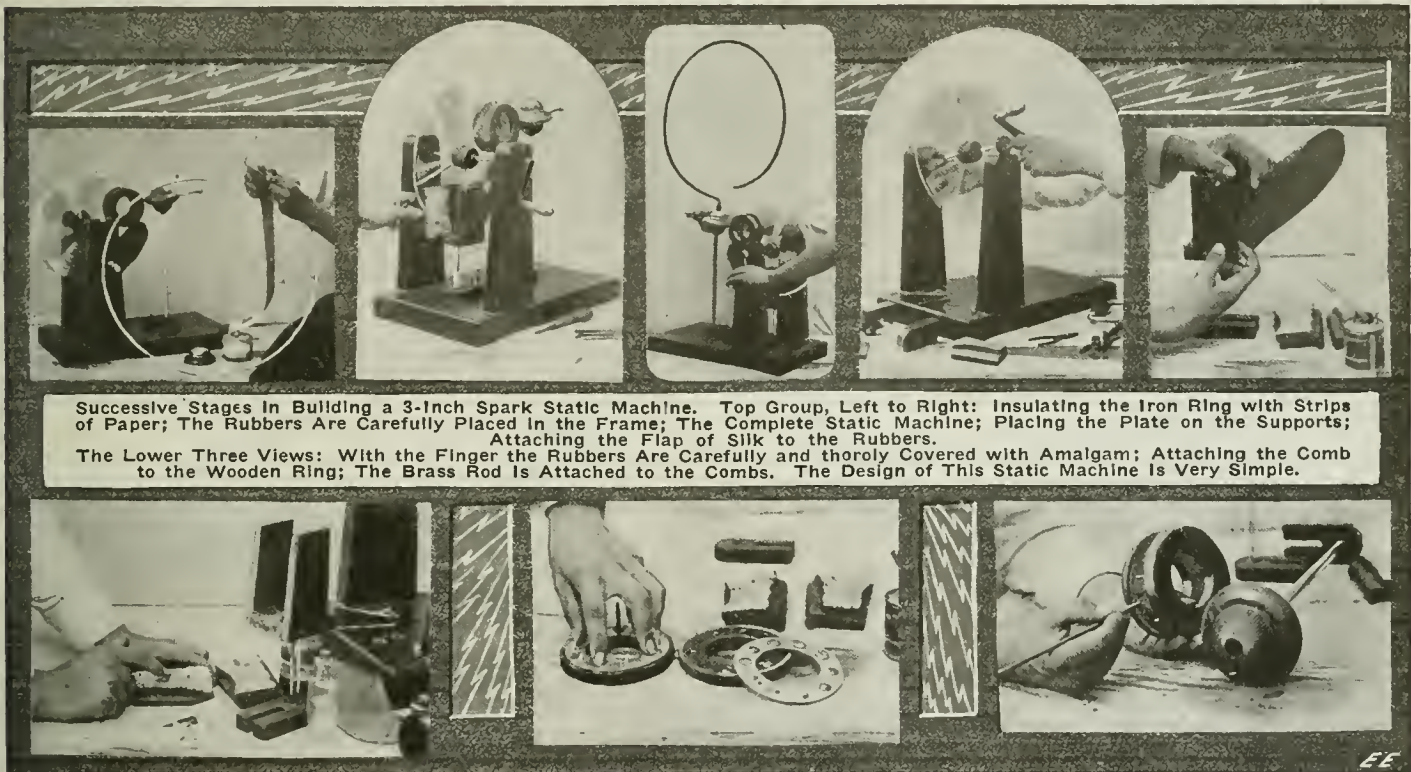

Successive Stages In Building a 3-Inch Spark Static Machine. Top Group, Left to Right: Insulating the Iron Ring with Strips of Paper; The Rubbers Are Carefully Placed in the Frame; The Complete Static Machine; Placing the Plate on the Supports; Attaching the Flap of Silk to the Rubbers.

The Lower Three Views: With the Finger the Rubbers Are Carefully and thoroly Covered with Amalgam; Attaching the Comb to the Wooden Ring; The Brass Rod Is Attached to the Combs. The Design of This Static Machine Is Very Simple.

utilized. The simplest form of such a static machine which will develop sufficient electricity for all kinds of devices, as it gives a spark ranging from *one to three inches in length*, according to the neatness and exactness of the finished apparatus, altho one of excellent construction will give a larger spark, consists of a revoluble glass plate, a rubber and a conductor. The capacity of the conductor can be heightened with a well insulated iron ring capable of being attached or taken off from the conductor at will.

The wooden frame is to be made first. It is constructed from hard dry wood (walnut or mahogany); the base is 20 inches long, 12 inches wide, and 2 inches thick; the edges are beveled off. The two supporting arms can be made from thinner wood, but each should be 15 inches long, 4½ inches wide at the bottom, and 3 inches wide at the top. These arms, which are dovetailed to the base, are fastened with two screws countersunk; the holes being later plugged

rod one foot long and a half to ¾ of an inch in diameter is taken for an axle. Two small wooden rings serve to hold the cemented plate to the rod. One should be careful to see that the axle is perfectly horizontal and the plate exactly perpendicular. One end receives a handle and a wooden ring which prevent it from slipping from the supports.

Now a "rubber" is made from three pieces of wood. The lower part is made from a piece 2½ inches wide and 4 inches long. The sides, which are made to slant slightly upward, are 4½ inches high. This frame is supported by a glass rod 4 inches long which is sunk into the wood. The other end is placed in a fork 4 inches long, 2 inches wide, and ½ inch thick. With the aid of this fork the frame is fastened to the base board by winged screws. But before this is done a small brass knob or ball is attached to the frame which in turn is attached, by means of tinfoil, to the rubbers.

part of zinc. This must be evenly distributed over the surface with the finger. If this will not adhere a little lard (fat) may be used.

The conductor with the metal comb is made next. The former consists of a four or five inch hollow brass ball fastened to a glass support. The ball receives two holes thru which a brass rod is placed carrying the comb. The top of the ball also receives a hole which will later carry the ring as well as other pieces of apparatus for experiments. The metal points of the comb are attached to two rings of tin, each of which is fastened to a wooden ring. The metal rings are each 3 inches in diameter. The points consist of ordinary thumb tacks. When the rings are placed between the glass plate, the points should be at least ⅛ of an inch from the glass. Under no circumstances should they touch the plate.

A flap of silk is glued to the rubber which
(Continued on page 673)

How I Built a Model Gyro-Electric Destroyer

By LeROY H. MAHONY

THE illustration represents a 25-inch model of Mr. Gernsback's "Gyro-Electric Destroyer." The entire machine with the exception of the Gyroscope and the driving motors was built of "Meccano" parts.

I next turned my attention to the main axle and the gyroscope. The gyroscope I turned from two pieces of $\frac{7}{8}$ inch wood 8 inches in diameter. To the side of it I secured a small sprocket for the driving chain. The gyroscope must run FREE of

the large quantity of silex in the substance require the tools to be extremely hard and even then they are subject to rapid wear. It also contains an oil which prevents nails driven into it from rusting.

EINTHOVEN GALV. STRING.

A commercial form of Einthoven galvanometer string is shown below. The case, E, contains the fine wire carrying the current to be measured. The figure shows schematically the detailed construction of the suspension for the fine wire E, which must be as fine as possible. Platinum, silver or aluminum can be used, but it was found that even a smaller diameter can be obtained by using quartz or glass fibers, these being platinized or silvered. The ends of the wire are soldered to T-shaped members, which are held by the set screws C and F at the ends. Adjusting the tension of the wire is a close operation and it is carried out by mounting the upper wire carrier upon a rod having the cam K at the upper end, the rod being normally pushed up by a spring L. The lever K¹, presses the rod down, this lever being operated by the micrometer screw J. With this arrangement a very fine adjustment of the wire is secured.

Contributed by SAMUEL COHEN.

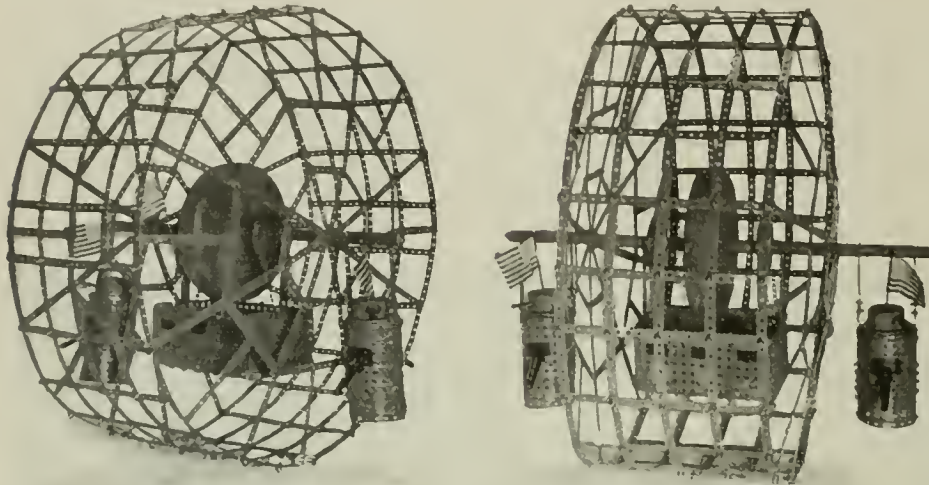

Here is a Fine Model of the "Gyro-Electric Destroyer." It is Fitted with Electric Motors and All. It Was Constructed by the Author from "Meccano" parts. It Stands 25 Inches High and Weighs 15 Pounds.

I first constructed each side of the big wheel. To a bush wheel I bolted eight $12\frac{1}{2}$ inch strips equally divided into angles of 45 degrees. I then bolted together seven $12\frac{1}{2}$ inch strips overlapping two holes each. I bent this around the ends of the side braces and fastened it to them by means of angle brackets. In the same way I constructed the other side. I selected pairs of $5\frac{1}{2}$ inch strips and bolted each pair together, overlapping them one hole. Three center treads, the same in circumference as the sides, were then made of seven more $12\frac{1}{2}$ inch strips, overlapping two holes. It now remained to connect the two side and the center tread together by means of the preconstructed pairs of $5\frac{1}{2}$ inch strips. One pair was bolted at right angles to each side brace and one equally placed between them. To preserve more stability, I connected the side braces with $3\frac{1}{2}$ inch strips. This completed the main wheel.

The next part to consider was the engine cage. Three small plates fastened side by side with $3\frac{1}{2}$ inch strips, composes each side, while each end comprises a large plate with the flanged edges flattened out. The sides and ends were fastened together by angle brackets. It is necessary to fasten inside the cage two motors (preferably electric), one to drive the gyroscope separately, and the other to propel the entire machine. As to the position in the cage for these motors—that is left to the discretion of the builder as his type and size of motors may differ from those of the writer. However, the motor driving the gyroscope must be placed in the center as the gyroscope must be driven in the center. The other motor must turn the axle of the wheel by means of chain and sprocket. On each side of the cage is fastened a $3\frac{1}{2}$ inch strip so that the cage is suspended from the center axle.

the main axle. The axle itself is 18 or 20 inches long and must be securely fastened to both sides of the wheel. The axle carries two armored cars (the construction of which I will explain further on), two sprockets, equidistant from the center, and also securely fastened to the main axle, the gyroscope, and the engine cage. A lever action that moves the gyroscope from left to right may be constructed also, at the discretion of the builder, because his material for the gyroscope will again undoubtedly differ. The lever action must be extended down into the engine cage.

The armored cars were lastly put together. For each car, eight large plates, with the flanged edges flattened out, were bent so as to form half a cylinder. Each pair was fastened together, overlapping one hole and making a complete cylinder. Then two of the cylinders were fastened, one on top of the other, with strips bolted to each side and extending over the top so that the car might hang from the main axle. Two inch axles (or better wooden models) were collared to the front and rear of the car to give the appearance of projecting guns. The model was now complete. The builder may elaborate on his model by cross-bracing with string, and so forth. The entire model weighs 15 pounds.

TEAK THE HARDEST OF ALL TIMBERS.

People familiar with different kinds of wood are aware that African teak is the hardest timber known to the mechanical industries. So indestructible is this teak wood that vessels built of it have lasted over one hundred years. The peculiarity of this wood is its hardness and great weight, causing extraordinary durability. Its weight varies from 42 to 52 pounds per cubic foot. It works easily considering its hardness, but

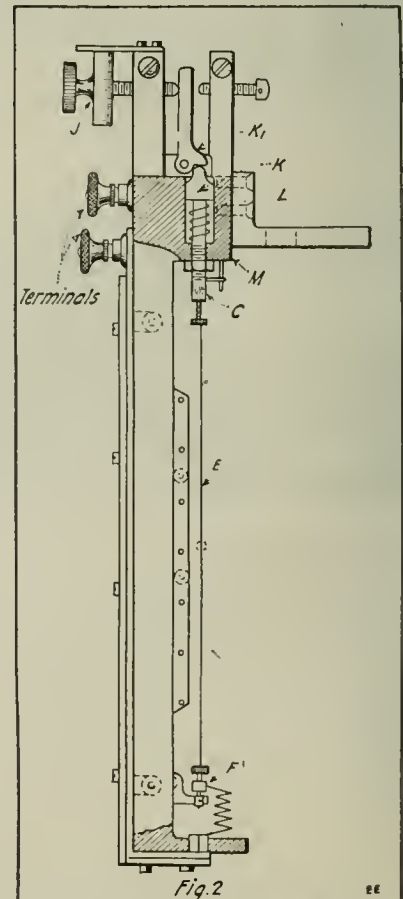

Those Who Are Interested In Building an Einthoven String Galvanometer for Measuring and Recording Radio Signal Currents, as Described in the September and October Issues, Will Find This Detail of the String Suspension of Value.

A Simple Study of Currents and Magnets

By Prof. E. H. JOHNSON, Dept. Physics, Kenyon College

(Conclusion)

IF now the wires J and K are joined to a direct current circuit of several volts, the wire, H, will rotate about the iron rod, D, which is now a magnet, and it will be found that the direction of this motion will depend on the direction of the current in the wires. It may take a little study to see how the action is in accordance with the principles previously defined, but it will be found to be no exception to the rule.

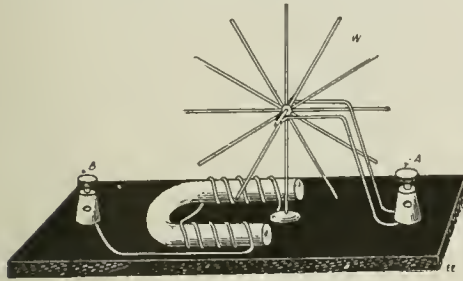

Barlow's wheel Fig. 6

Barlow's Wheel—the Simplest Electric Motor for Experimental Studies in Magnetism. The Spoked Metal Wheel Makes and Breaks Contact for the Field Magnet, by Passing Thru a Mercury Well.

Another method of producing motion by the interaction of a magnetic field and a current-bearing conductor is illustrated in Fig. 5. A heavy wire, A, is bent into the form shown with a hook at the upper end, B, from which is suspended loosely a straight wire, C. The lower end of this wire just touches in a pool of mercury, G, which is contained in a small hollow in the supporting base board. A horseshoe electromagnet, M, lies with one pole on each side of the drop of mercury. This magnet may be made from a rod of soft iron 6 inches long and 1/4 inch in diameter, bent

into the required form, and having its two limbs wound with several layers of insulated copper wire (about No. 20 or No. 24). One end of the wire from the magnet dips into the mercury and the upper end is joined to a binding post, E. When a direct current is past between the posts, F and E, the wire, C, will be moved sidewise so as to leave the mercury contact, and thus break the circuit at that point. Then, since the magnetic field about the wire, C, is gone, it will again swing back into the mercury, completing the circuit. Thus the process will go on much after the manner in which an electric bell continues ringing.

Again, one of the rules should be applied to see why the wire, C, moves just as it does, and how its motion is effected by the direction of the current.

Still another simple device illustrating the same principle is that known as Barlow's wheel. See Fig. 6. The electromagnet used in the preceding experiment may also be used here. The wire C (Fig. 5) is replaced by a carefully balanced, rimless wire wheel, W, which is mounted on two wire supports held by the post A. The wheel may be made of light copper wire (say No. 20) with spokes about 3 inches long, and the only difficulty will be to get it accurately balanced. It should have 10 or 12 spokes, which may be soldered to a heavier copper wire for a shaft to be laid across the slightly hooked ends of the supporting wires from the post, A. When the balancing is fair the wheel should turn as easily in one direction as the other, or remain at rest in any position. The mercury pool, with which the ends of the spokes make contact, is connected as before, by a wire to one end of the coils of the magnet, and their other end is joined to the other binding post, B, so that a current may pass thru the apparatus between A and B. In this case the action will be continuous with the proper current, and we have a fair type

of electromagnetic motor. Again, our right-hand rule should be applied, considering the current as flowing up or down, as the case may be, in the spoke touching the mercury, to see if the rotation is what should be expected.

Other experimental devices such as these will readily suggest themselves to the ex-

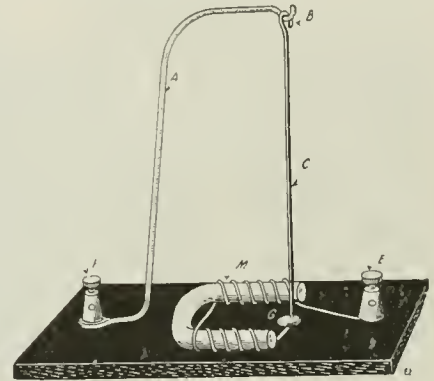
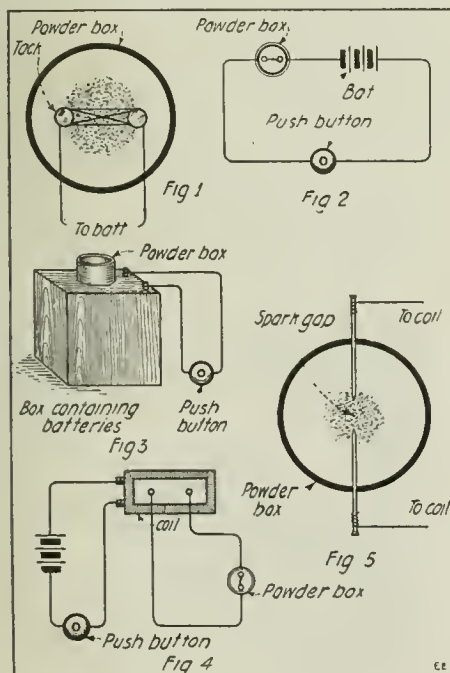

Fig 5

An Interesting Method of Producing Motion by the Interaction of a Magnetic Field and a Current-Carrying Conductor "C." The Suspended Wire "C" Dips Into a Mercury Well "G," Completing the Field Coil Circuit. The Wire Swings Back and Forth Rapidly.

periment, and he should learn to look at all such arrangements with that keen appreciation which sees not only the wires and mechanism, but which recognizes at once the underlying principle of its operation. When this habit has been formed and some of the information which it will inevitably bring, has been acquired, the entire field of electromagnetism, including dynamo-electric machinery in all of its phases, will open up with a surprising simplicity and consequently with endless interest.



Several Useful Schemes in Igniting Flash-light Powder Electrically.

ELECTRIC FLASH-LIGHT IGNITER.

Having some difficulty when taking flash-light pictures with cartridges, with the fuse not igniting the powder or putting the subject on guard, frequently catching him with his eyes closed, and being badly burnt by the powder once, I constructed the apparatus shown in the accompanying sketch. It will run nicely on four dry cells. The principle is that when the batteries are short-circuited, the wire gets red hot.

The wires leading from the powder box are the kind known as bell or annunciator wire. Inside the box, the wire wound between the tacks is about No. 40 gage. When the box is constructed, place some powder in the box, press the push button, and off goes the powder. To make the apparatus portable, put the batteries in a box, and mount the powder box on top of this. In this way the operator may appear in the picture himself, if the wires are concealed behind furniture and his person. This also catches the subject off his guard, giving him a natural pose; it enables the operator to be at a safe distance from the powder. If a spark coil is procurable, it can be used instead of batteries by running a pin thru each side of the box making a spark gap, connecting up to the coil, and pressing the button. I have used this apparatus extensively and successfully myself.

Contributed by FRED C. DAVIS.

A "BATTERY-LESS" MAGNETO DOOR BELL.

A small magneto generator is placed in a box (properly stained and finished) on the back of the door. A turn of the knob rings the bell, which may be an ordinary vibrating bell. Best results are obtained by rewinding it to from 100 to 300 ohms. An old

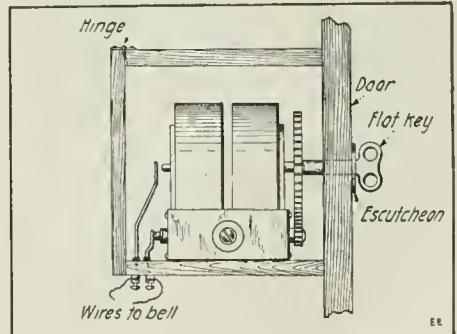

Turn the Key Handle—and, Presto! the Generator Rings the Bell, Doing Away with Batteries.

crank escutcheon plate from a magneto telephone may be placed on the front of the door. This device when properly made is neat in appearance and does away with all battery troubles.

Contributed by CHURCHILL GERRY.

Experiments in Radio-Activity.

By IVAN CRAWFORD

PART 1—Ionization

RADIO-ACTIVITY is one of the greatest mysteries of today. The modern scientists, however, thru extensive experiments have succeeded in throwing considerable light upon the subject. The term radio-active is generally

employed in referring to such elements as uranium, thorium, radium and their compounds which possess the property of emitting radiations capable of penetrating many substances opaque to ordinary light. These radiations also have the power of affecting photographic plates, ionizing the gas thru which they pass and causing fluorescence on certain substances placed in their vicinity. It is deemed unnecessary to enter further into the explanation of radio-activity as it has been well described by Mr. Jerome Marcus in previous issues of this magazine. It is the purpose of this series of articles to merely outline some experiments on this extremely interesting subject.

substance furnishes an efficient means of measuring the intensity of the activity. The construction of a super-sensitive electroscop suitable for making these measurements is clearly depicted in Fig. 1. The metal shell consists of a large oil can with the bottom and spout removed. Two round holes are cut opposite each other about half way up the side. As is clearly shown in the drawing the gold leaf is fastened to a brass strip which in turn is suspended from a sulphur bead. Into the other side of this bead is fastened a wire which passes thru the sulphur block at the top of the chamber. Another wire is then past thru the block and bent as shown. The sulphur block is made by pouring melted sulphur into the opening and allowing it to harden. In order to charge the electroscop the bent wire, A, is turned so that the lower portion makes a contact with the brass strip. A charged rod is then applied to the other end, B, until the desired charge is attained, when the wire may be turned back with the rod. The gold leaf is attached to the brass strip by means of a small drop of some adhesive. In order to observe the discharge, a small low power microscope having a scale on the eyepiece is used. This is mounted in one of the apertures by fastening a brass tube to the shell of sufficient size to allow the microscope to be easily adjusted. A similar brass tube with a ground glass window is mounted in the opposite aperture. This is to facilitate the illumination of the chamber. Using this instrument the rate of discharge may be accurately measured by noting the fall of the gold leaf on the scale. The substance to be measured is placed on a grounded plate and the electroscop placed over it. The radiations by means of their ionizing properties cause the charge of the gold leaf to be dissipated. In Fig. 2 is shown a photograph of such an instrument which was constructed by the author. Some very accurate measurements have been made using this instrument.

Substance.	Formula.	Time.	Relative activity.
Empty.....		412 sec.	
Uranium oxide.....	UO ₂	26	1.00
Uranium nitrate.....	UO ₂ (NO ₃) ₂ ·6H ₂ O	86	.26
Uranyl chloride.....	UCl ₂	41	.61
Thorium nitrate.....	TH(NO ₃) ₄ ·12H ₂ O	63	.38

It will readily be seen that the activity of a substance is proportional to the amount of uranium or thorium it contains. There are other considerations, however, which affect the experimental results, such as the state of the substance, whether powdered or in lumps. Every electroscop also is different, and all quantitative experiments should be conducted using the same instrument.

It will be found that the distance between the substance and the gold leaf affects the rate of discharge. For uranium compounds the most effective distance is about 3 c.m., while for thorium compounds it is about 5 c.m. Ionization by radio-active rays is by no means uniform along the path of the rays. In Fig. 3 is shown the ionization caused by a sheaf of parallel rays as determined by Geiger. The range is laid out horizontally in c.m., the number of ions are laid out vertically. It will be seen from this graph that when the alpha particle begins to lose some of its enormous speed it becomes a more effective ionizer; near the end of its path, however, its power suddenly decreases.

The experimenter will find innumerable other applications for this electroscop to (Continued on page 673)

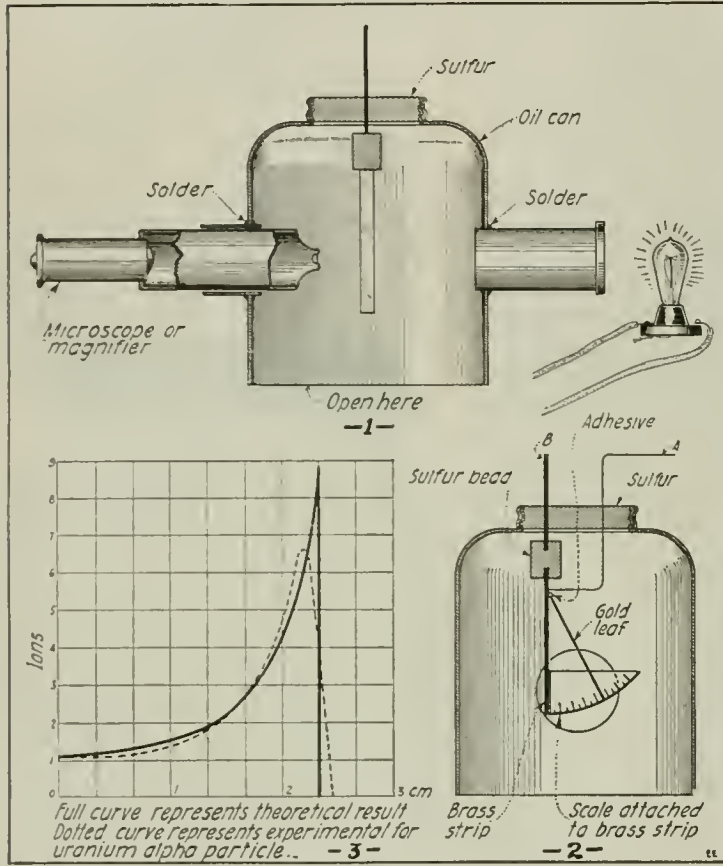

The Most Important Property Possessed by the Radiations of Radio-Active Substances Is the Power of Discharging Electrified Bodies. Hence, the Discharge of an Electroscop Placed in the Vicinity of the Radio-Active Substance, Furnishes an Efficient Means of Measuring the Intensity of the Activity.

The most important property possessed by the radiations of radio-active substances is the power of discharging electrified bodies. The theory has been formulated that this discharge is due to the production of positively and negatively charged carriers by the rays. These carriers, or ions as they have been termed, move with uniform velocity and the rate of production is proportional to the intensity of the radiation. The discharge of an electroscop placed in the vicinity of the radio-active

substance to be measured is placed on a grounded plate and the electroscop placed over it. The radiations by means of their ionizing properties cause the charge of the gold leaf to be dissipated. In Fig. 2 is shown a photograph of such an instrument which was constructed by the author. Some very accurate measurements have been made using this instrument.

To determine the activity of an unknown substance the electroscop should first be charged until the gold leaf coincides with one of the markings on the scale. The time required for the leaf to pass over five divisions on the scale should then be noted with the electroscop empty. The recip-

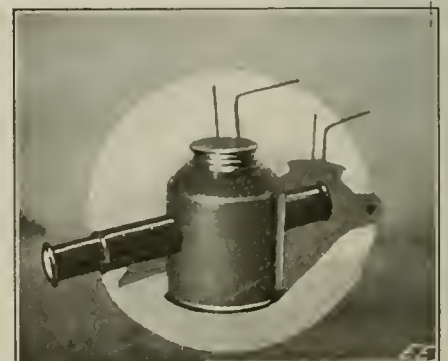

Finished Super-Sensitive Electroscop for the Measurement of Radio-Activity. It is Made from an Oil Can.

TESTING THE VACUUM GAGE.

The experimenter often wishes to test a vacuum gage. The best way to test such a gage is to compare it with a glass U-tube mercury gage as indicated in the

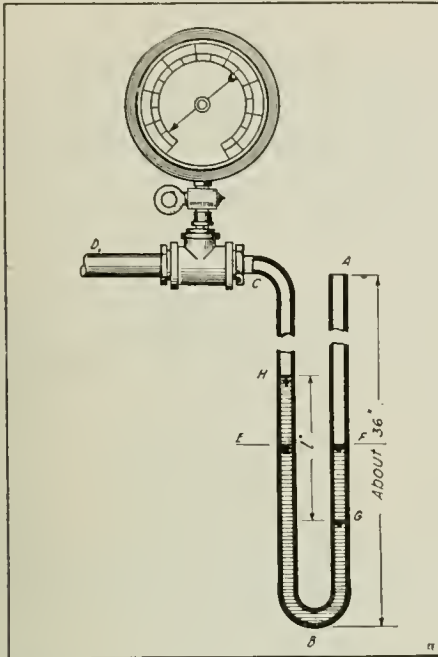

Testing the Vacuum Gage With a Glass U-tube Mercury Gage. The Latter is a Common Instrument Used by All Engineers and Can Be Made Very Easily. The Atmospheric Pressure Acts on the Mercury in the Open Tube "A."

sketch. The bent tube ABC, having about 3/8-inch bore, is connected by suitable fittings to the pipe or nipple D, and the latter is connected with an air pump or condenser. The gage to be tested is placed on a tee-connection. The U-tube should be about 36" over all and about half filled with mercury. When there is a partial vacuum made at D, the atmospheric pressure acting on the surface of the mercury in the open tube AB, being greater than the pressure acting on the surface of the mercury in the tube CB, the mercury at the original level EF will fall in AB, as to G, and rise in CB, as to H, and the difference of level between H and G as indicated by the dimension "1," measured in inches, will be the inches of vacuum which the vacuum gage should indicate. While most manufacturers of vacuum gages are equipt with a U-tube mercury gage, they generally make comparisons with another gage, known to be correct with the U-tube gage. For testing a vacuum gage at a plant not equipt with a mercury gage, the usual practise is to compare the gage to be tested with one considered to be correct.

Contributed by **PETER J. M. CLUTE.**

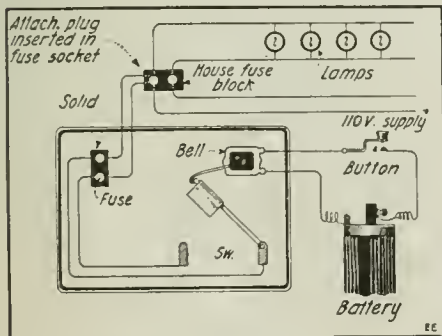

Hook-up of Remote Control Attachment to a Two-wire Lighting Circuit. The Control Circuit Wires May Be Ordinary Bell Wire as This is a Battery Circuit Only.

REMOTE CONTROL SWITCH FOR LIGHTING CIRCUITS.

After obtaining the necessary material listed below, remove the handle from the knife switch and substitute a weight made from 2" length of conduit pipe and 1/16" x 2 1/2" stove bolt. The head of stove bolt is filed flat on one side so as to be properly engaged by the trip arm. The bolt is placed in one side of pipe, and pipe filled with melted lead and allowed to cool off. The threaded end of bolt is then inserted thru hole (in insulating bar across knife switch) formerly occupied by screw holding handle. If properly placed this weight does not come in contact with either of the switch blades.

Now place the fuse block in upper left-hand corner of the iron box as shown on sketch, then place knife switch in bottom, the one side of base being against back of iron box and the whole switch so mounted as to allow weight to swing down and close switch without hitting side of box. The rubber bumper is then placed on bottom of box either with small stove-bolt counter-sunk in the rubber or with a small wood screw from the under side.

The object of the bumper is to prevent the weight from snapping off the insulating cross piece of switch when switch drops.

The casting on bell for holding gong should be removed with a hacksaw just beyond the screw hole, and the ball hammer can be cut off with a pair of cutting pliers, leaving the hammer arm intact.

In placing the bell it will probably be necessary to build it out from the back of box so that the trip arm centers over weight on switch. This building out should be done with either a piece of fibre, porcelain or iron washers. No wood or combustible material should be used. Bend trip arm as shown in sketch, so as to engage the filed side of stove-bolt-head which protrudes thru the weight.

All mountings should be made with stove-bolts, drilling holes in iron box where necessary. If box is thick enough to allow threading machine screws may be used.

The rubber bushing to protect bell wires can be inserted in the box at any convenient place and a narrow piece of linen tape or wire twisted tightly around the inside will serve to hold it intact.

Place the attachment plug on one end of the lamp cord, knock out one of the punchings in the iron box and place the B. X. connector, insert the cord thru this and wind the cord with tape on the inner side of the connector so that the clamping device can be tightened thereby holding lamp cord, preventing pull on the connections at fuse block and at the same time serving as a bushing for the cord. Connect other end of cord to fuse block as shown.

Make all connections as shown using the No. 14 wire for the lighting circuit and ordinary bell wire for battery circuit.

Only one blade of the knife switch carries current for the ordinary two-wire lighting circuit. For the three-wire circuit the two blades are used and an additional lamp cord and attachment plug are required.

Installation: This apparatus should be mounted on wall close to house fuse box and not more than 6 or 6 1/2 ft. from floor.

To connect to an installation one fuse is removed from the house fuse box and the attachment plug inserted in its place, the fuse can then be placed in the "fuse" socket of the apparatus. The bell circuit can easily be run and the button and batteries installed at any convenient point.

Operation: By closing battery circuit, the

bell magnets become energized, which lifts the hammer or trip arm and disengages the weight, allowing switch to drop and close lighting circuit.

To reset and cut out lights; open door of iron box and lift weight until engaged by

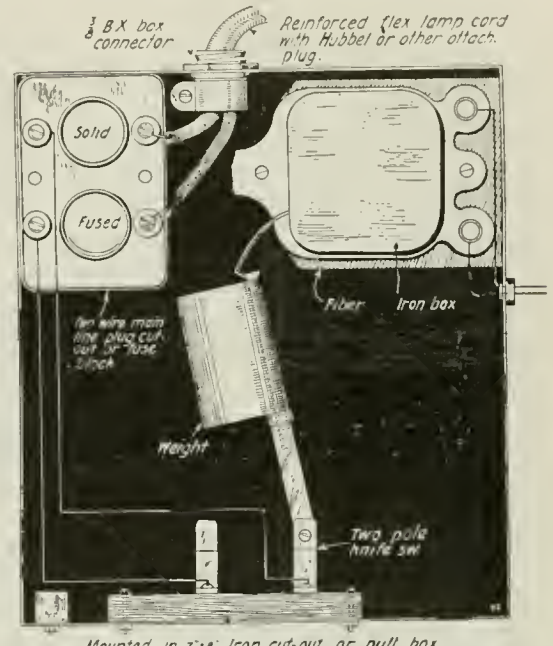

Construction of "Remote Control" Switch Which Can Be Made With a Buzzer or Bell Movement to Trip the Weighted Knife Switch Blade.

hammer arm of bell, then close the door.

Keep pivoted and contact clips of knife switch lubricated with vaseline. This switch can be used for distant cut-in control or in conjunction with burglar or fire alarm systems, cutting in the lights when alarm operates, and doing away with the necessity of running heavy lighting wires.

Where the law requires it, a ground wire can be attached to the iron box with a short stove-bolt, and the box grounded to the electric conduit system.

The following material is required to make this apparatus:

- One 7" x 8" iron cut-out or switch box.
- One two-wire main line plug fuse cut-out block.
- Two dry batteries
- One two-pole single-throw knife switch,
- One iron box bell.
- One push button.
- One 3/16" B. X. box connector.
- One rubber lamp socket bushing.
- One attachment plug.
- One 3/16" x 2 1/2" stove bolt.
- One rubber knob from old door bumper.
- One 2-inch length of 1" conduit pipe.
- Two ft. No. 14 B. S. gage double-braided wire.
- Two ft. reinforced flexible lamp cord.
- Proper quantity of bell wire.

Contributed by **E. C. O'DONNELL.**

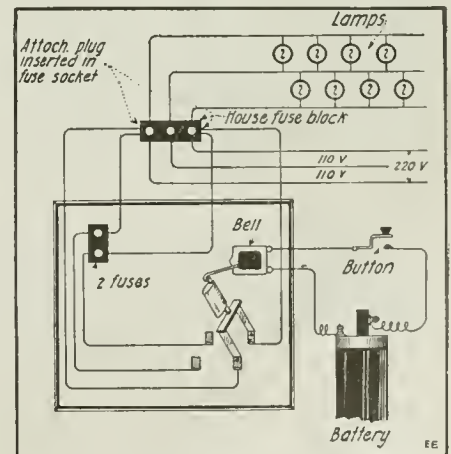

How the Remote Control Switch is Connected Up to a Double-pole Knife Switch For Controlling Lamps on a Three-wire System.

Experimental Mechanics

By SAMUEL D. COHEN

LESSON IX

Boring and Drilling.
THAT the lathe can be used with success for drilling purposes is mentioned in one of the earlier lessons of this course. The subject will be further considered in the present lesson, and several useful kinks regarding

the size of the hole should be marked with a pair of compasses, first chalking the surface, and four center impressions should be made at opposite points on the line. These are necessary to act as guides should the line get effaced. A start is then made, but before the point of the drill has fully entered the metal an examination should be made to see that it is cutting truly within the circle marked out. If so, the work may be proceeded with.

Should the drill by chance happen to cut slightly to one side, the fault can be remedied by cutting a narrow groove at one side of the hole. This may be done with a narrow-pointed diamond chisel. The groove should be made at the side toward which the hole requires to be corrected.

Here the drill may again be applied, the effect of the newly made groove being to draw the drill toward the center of the circle. The drill should then be turned several times and the hole again examined. If necessary, the drawing process can again be repeated until the hole is exactly central. The reader, of course, fully understands that this drawing process should be done before the full diameter of the drill commences to cut, as the grooving plan can have no further effect in drawing over the hole, after the full diameter of the drill enters the hole.

At certain times it happens that the relative positions of the parts are reversed. Thus the work to be drilled is held in the chuck, the drill being fed up to the work. Many times it proves convenient to first drill a small hole, then a larger size, and lastly use the full size drill.

If the work is held in the *live* chuck, the drill should be fed by means of the tail-stock center, and held firmly thereto. The drill can be held either in a drill chuck fitted with a mandrel for the dead center spindle, as shown in Fig. 10, Lesson 6, or by setting the center hole of the drill onto the dead center, its shank being held with a wrench in order to prevent it from turning, see Fig. 1. When the hole is made in this manner it is necessary to start the drill centrally. An accurate starting point is obtained by the use of the cutting tool placed in the slide rest. This method will insure a proper drilling point.

Boring is chiefly used when it is desired to make a large hole. However, at times it is simpler and easier to bore a small hole of proper diameter and accuracy than it is to drill it. But care must be exercised to see that there is a proper clearance at the lower part of the cutting tool, as indicated in A, Fig. 2. If the tool is improperly set so that the lower part scrapes against the side of the work, as shown in B, Fig. 2, its proper functioning will then be interfered with. The tool will not only be prevented from cutting into the metal, but due to the rubbing action against the metal, it will be heated and caused to lose its temper, thus destroying the cutting qualities of the tool, besides making an inaccurate hole.

It is advisable to make the first cut a fairly heavy one, in order that the hole may

be cleaned up perfectly true around its circumference. Thereafter several lighter cuts may be made, until the diameter is brought to the proper size. The *inside caliper* should be used in this work to ascertain the diameter. Precaution should be taken to set the slide-rest perfectly true

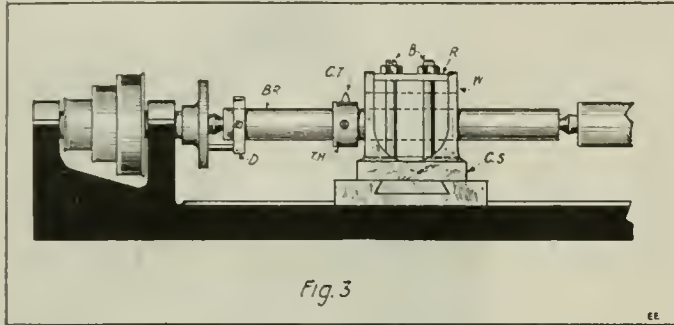

Fig. 3
 Boring Out a Casting in the Lathe by Means of a Boring Bar "BR." The Casting is Secured by Bolts "B" to the Saddle "CS."

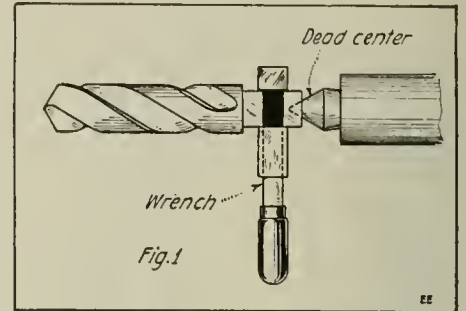

Fig. 1
 Holding a Twist Drill in the Lathe by Means of a Monkey Wrench. The Back of the Drill is Placed on the Tail-stock Center.

drilling in the lathe will be given. Whenever it is desired to make a hole of general size in some material, it is usually done by the use of a drill of the desired diameter, said hole being made in one operation. There is still another method of making a hole, and that is by *boring*. It can be done by a single pointed tool cutting into the material in successive cuts, which gradually enlarges the opening until the desired diameter is obtained.

Practically all small holes are always drilled, while large ones are bored. In order to drill a large hole it requires considerable driving power, also the removal of a considerable amount of metal. However, if the method of boring is utilized, a rough hole may be *cored* thru the casting when the latter is made in the foundry, and this can be enlarged later by the use of the boring tool. If the work is not made of cast material, it will be necessary to drill a hole large enough to permit the boring tool to make its first cut.

In drilling small holes, say up to one inch in diameter, it will be found that twist drills give most favorable results, as they are dependable for producing an accurate and straight hole. It is usual, in practise, to fasten the drill in a self-centering chuck, as explained previously, and to feed the work up against the drill by means of the mandrel of the tail stock in the lathe. The first step before attempting to drill is to accurately mark the spot where the hole is desired, making a heavy center-prod or mark, so as to guide the point of the drill at the start. To drill large holes, a circle

so as to insure a parallel hole being bored. If the diameter is found to alter, (should it taper, for example), the slide rest can be changed accordingly. By the use of a self-acting feed on the slide rest, the hole should be perfectly parallel, provided the head stock and lathe bed are set true, the position of the slide rest not at all affecting the work in this case.

If it is desired to bore certain work which is too large to be chucked on the face-plate or chuck of the *live* spindle, it is practical to secure the work to the saddle of the lathe, as shown in Fig. 3. This is done by supporting the boring rod between the live and dead centers, the boring rod carrying the cutting tool. Engine and pump cylinders, field magnets for dynamos and motors, also bearings of engine bed plates are examples of work which can be done in this manner. It is essential to have a lathe with a saddle, actuated by a self-acting feed motion, unless a complicated boring bar fitted with its own screw feed motion is used. Fig. 3 shows a cylinder W of an engine, which is secured to the lathe saddle, C. S. This is done by clamping the cylinder with two bars, each having two holes, the distance between which should be greater than the diameter of the work to be secured. The bars, R, R, are laid across the top of the work and clamped down by means of two bolts, B. These heads fit into the slides of the lathe saddle. The cutting tool, C. T., is held on the boring rod, B. R. It is revolved by the *live* center while the cylinder is slowly carried along the lathe bed toward the live headstock by the self-acting feed motion applied to the saddle.

Before attempting to bore into the work, it is advisable to see that the work is firmly
 (Continued on page 670)

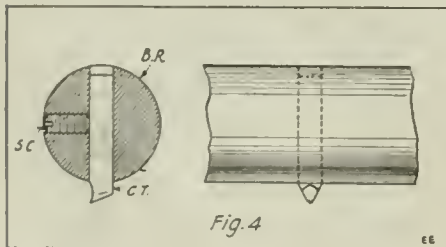

Fig. 4
 How the Boring Tool is Made: a Self-Hardening Tool Steel Point is Fitted Slidably in a Hole in the Boring Bar. The Point May Be of Square or Round Stock.

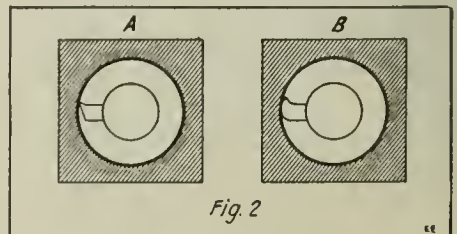

Fig. 2
 Proper Clearance on Boring Tool (Left) and Improperly Ground Tool at Right.

Experimental Chemistry

By ALBERT W. WILSDON

Thirty-second Lesson

PHOSPHOROUS: History.

PHOSPHOROUS was discovered by Brandt, an alchemist, in 1669 at Hamburg. He gave it the name *Phosphor* [light bearer]. Gahn, in 1769, found it to be a constituent of boneash, and about 1775 Scheele first published his method

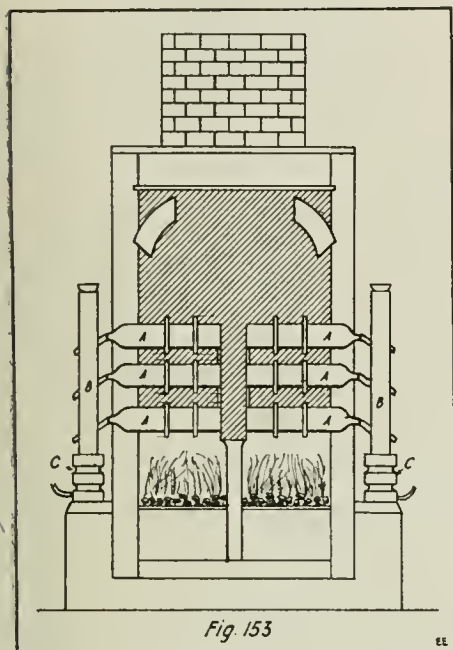

Fig. 153

In the Preparation of Phosphorous Great Care is Taken Not to Have the Hot Phosphorous in Contact with the Air, and the Retorts are Arranged so That the Phosphorous Runs Into Cold Water.

of preparation from this source. Liebig in 1840 used phosphates as a fertilizer for plants, while Romer [about 1833] first applied it to matches, thus revolutionizing the means of obtaining fire and light.

Occurrence.

It never is found in the free state, but chiefly as calcium phosphate [$\text{Ca}_3[\text{PO}_4]_2$], the principal constituent of bones. This occurs in certain minerals as *Apatit* [$3\text{Ca}_3[\text{PO}_4]_2$] and *Phosphorite* [$\text{Ca}_3[\text{PO}_4]_2$]. The latter being also known as *Phosphate Rock*, being extensively used for fertilizing purposes.

Phosphorous is always found in plant and animal tissues, in the soil, and in sea water.

Preparation and Manufacture.

It is obtained mainly from bones of vertebrate animals, which usually contain from 55 to 60% of calcium phosphate, the hard parts of invertebrates being mostly Calcium Carbonat, CaCO_3 . These bones are first burned or else distilled. In either case the ash is the same, but in the latter the carbon is retained as boneblack, which in the former gives rise to carbon dioxide. The volatile substances driven off are ammonia and other nitrogenous products, such as water, carbon dioxide, etc. The ash, mostly Calcium Phosphate with a little calcium carbonate, is reduced and phosphorous obtained by three steps.

First.—It is treated with Sulfuric Acid, which changes it to a soluble phosphate $\text{H}_2\text{Ca}[\text{PO}_4]_2$.

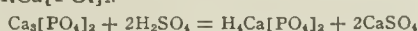

It might be expected that the Sulfuric Acid would change the phosphate salt into phosphoric acid, but the Sulfuric acid used is not very strong and the reaction goes but halfway, producing an acid salt. It, however, changes the insoluble phosphate to a soluble one and precipitates the Calcium Sulfate, which is then separated by filtration or settling.

Second.—The liquid is next evaporated, and the solid residue from the evaporation is strongly heated, a process which breaks it up into Calcium Metaphosphate [$\text{Ca}[\text{PO}_3]_2$].

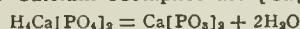

Third.—The reducing agent, carbon, is next added and thoroly mixed, and heat is again applied. When two-thirds of the Phosphorous distills over, the remainder again forms Calcium Phosphate.

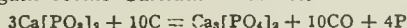

To obtain the whole of the Phosphorous, Silica [SiO_2] in the form of sand is introduced, and the following reaction takes place:

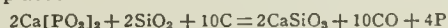

Great care is taken not to have the hot Phosphorous in contact with air, and retorts are arranged so that the Phosphorous runs into cold water. See Fig. 153. The Phosphorous must be either redistilled or prest thru chamois skin to get rid of carbon particles, etc. It is then run into small moulds of copper or glass.

The manufacturing process is detrimental to the health of the workmen. Some of the fumes have to be inhaled, and the breath at night is often luminous. The element attacks the teeth and jawbones, especially the lower jaw, which is sometimes entirely eaten away thru failure to cleanse the teeth.

The electrical process has practically replaced the old method. In an upright pear-shaped furnace, an intimate mixture of Carbon, phosphate, and flux is heated by means of carbon electrodes in the electric furnace, as shown in Fig. 154. The mixture is fed in thru the hopper H, the carbon electrodes entering at GG. The phosphorous vapors pass off above to a condenser, being condensed under water, while the slag is tapt off below at C.

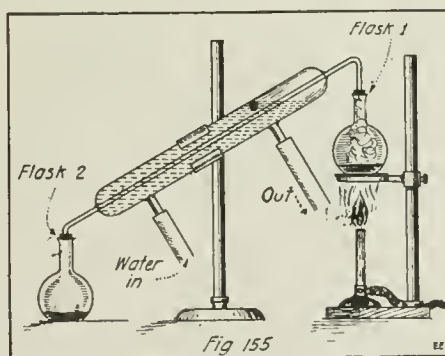
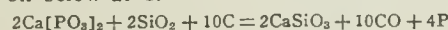

Fig. 155

An Interesting Experiment in Which the Phosphorous from Match-heads is Extracted by Means of Distillation.

Physical Properties.

1. It is found in several *allotropic* forms, the most important being the yellow and the red varieties.

2. *Yellow phosphorous* is a colorless, transparent to translucent, wax-like solid. At ordinary temperatures it is sufficiently soft to be cut with a knife, but at lower temperatures it becomes more brittle.

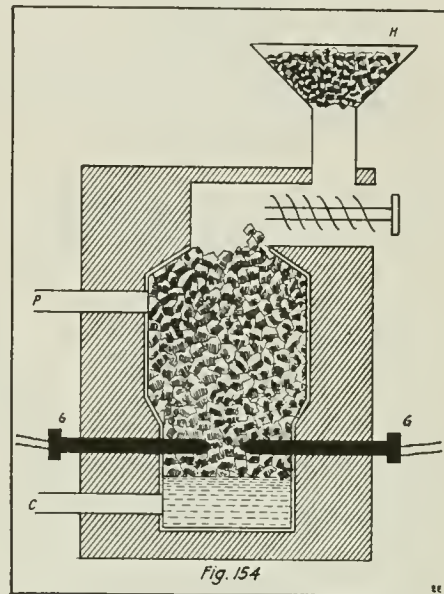

Fig. 154

Preparation of Phosphorous in the Electric Furnace. A Mixture of Carbon, Phosphate and Flux is Heated by the Passage of the Electric Current. Electrodes at G-G. The Phosphorous Vapors Pass Off Above to a Condenser, Being Condensed Under Water, While the Slag is Tapt Off Below at C.

3. It burns the flesh when handled out of water, and these burns are slow to heal, on account of the poison absorbed. For this reason this element should always be manipulated with a pair of forceps.

4. It is insoluble in water. It is soluble in 350 parts of absolute alcohol at 15° C, and in 240 parts of boiling absolute alcohol. It is soluble in 85 parts of absolute ether, in 25 parts chloroform, and in about 50 parts of any fatty oil. Carbon-disulfid is probably its best solvent, dissolving from 18 to 20 times its weight without losing its fluidity. All solutions of phosphorous in carbon disulfid should be preserved with the greatest care. When spilled or otherwise exposed, the solvent rapidly evaporates, leaving the phosphorous in such a finely divided condition that it *inflames spontaneously*.

5. It possesses a garlic odor, and is very poisonous. This odor somewhat resembles *Ozone*.

6. The phosphorescence, visible in the dark, when exposed to the air appears to be due to the slow formation and spontaneous combustion of phosphin.

7. Phosphorous is a very inflammable element, igniting spontaneously in air at 50° C. For this reason it is kept and cut under water. Phosphorous, when kept under water and exposed to the light, undergoes slow oxidation, becoming covered first with a white, opaque film, which slowly turns red.

(Continued on page 666)

AN ELECTRIC FIRE DETECTOR.

Herewith is a plan of a fire detector which I made myself. It consists of two batteries, a cigar box, an electric bell, a

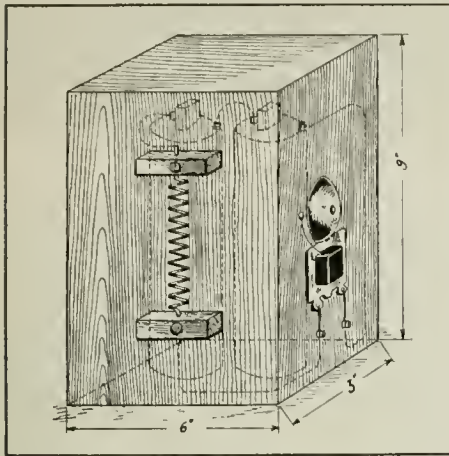

In Case of Fire the Heat Expands the Copper Wire Spiral, Causing it to Touch the Lower Contact Block, Thus Ringing the Bell.

piece of bare copper wire made into a spiral spring, two blocks of wood, four screws, and two binding posts. Normally the wire made into a spring does not touch the lower contact block, but when fire breaks out it expands the wire spiral and completes the contact, causing the bell to ring.

Contributed by JOSEPH WOHLPART.

SPARK PLUG TESTER MADE FROM SPARE PLUG.

Most autoists carry a spare spark plug in their tool chests which can be made to serve as a spark plug tester without destroying its usefulness.

The only thing necessary is to cut a piece of fiber or heavy cardboard to the shape shown in the illustration. The hole in the end is made large enough to pass the threaded end of the plug and serves as a holder.

To test the plug in the engine, hold the spare plug, sparking points up, by means of the fiber strip. Touch the post on the plug to the engine cylinder and bring the thread end of the plug in the strip against the binding posts of the plug in the engine.

A small spark or none at all will indicate a broken porcelain or carboned and short circuited plug. A heavy spark will show that the points of the plug in the engine are too far apart. In cases of emergency any means may be employed that will hold the test plug without giving the driver a shock.

Contributed by THOS. W. BENSON.

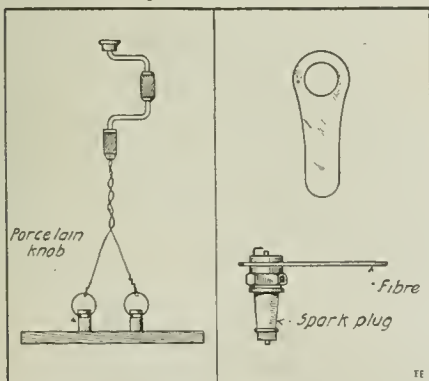

At Left—Twisting Cables With a Bit Brace. At Right—Using the Spare Spark Plug as a "Test" Plug for the Auto Engine.

TWISTING CABLES IN THE SHOP.

In looking over your October, 1916, issue under the head of "How-to-make-it," I

noticed a scheme for twisting telephone wires, contributed by Mr. Leach. While this is a good method, I would like to suggest one that will not ruffle or twist the insulation of the individual wires as other methods do.

Porcelain knobs may be used as swivels. Attach two knobs to shop wall, do not tighten up screws, knobs should turn freely. Attach No. 14 wire loops to receive ends of insulated wires. Have wires same length; turn brace five or six times, pulling on it to take up slack and keep knobs from turning. Now slack off slightly on brace and knobs will spin, thus relieving the twist in each individual wire. Almost any length of wire can be handled in this manner, equalling the factory product.

Contributed by J. ESHLIMAN.

A REVERSING SWITCH FOR SMALL MOTORS AND TOYS.

A small but thoroly effective reversing switch for small battery motors and other apparatus can be made from scraps found about most any workshop.

First procure a fiber base about 1 1/2" square and 3/8" thick. Next cut four strips, each 1/2" long and 1/4" wide out of a piece of brass about 1/16" thick. Then bore a hole in one end of each strip and fasten it to the base by means of small wood-screws as shown in Fig. 1.

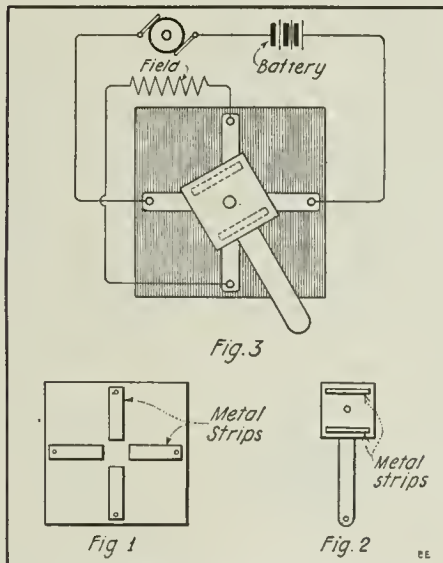

A Handy Reversing Switch for Battery Motors, Toy Railway Cars, Locomotives, Etc. Throw It to Either Side to Reverse the Motor.

Then take another piece of fiber about 3/4" square and 1/8" thick and fasten two metal strips to it as shown in Fig. 2. A handle may then be made and soldered to one of the strips. (In constructing this reverser, be sure and do not short-circuit any of the strips because it will not work.)

A hole should then be bored exactly in the center of the small piece of fiber and fastened to the main base by means of a wood or machine screw. The complete reverser and connections are shown in Fig. 3. If desired a metal base and body can be made to enclose the working parts. If so constructed a slot should be cut in the body for the extending handle so the switch can be easily operated.

Contributed by WALTER SELLENEIT.

HOW TO MAKE A S.T.D.P. SWITCH OUT OF TWO S.P. KNIFE SWITCHES.

Nail a block of wood on to a base of proper size. Next procure two S. P. battery knife switches. It must be made certain that one opens to the right and the

other to the left. The reason for this can be seen when they are mounted. If they are the same, just take off the knife and terminals and remount them in reverse or-

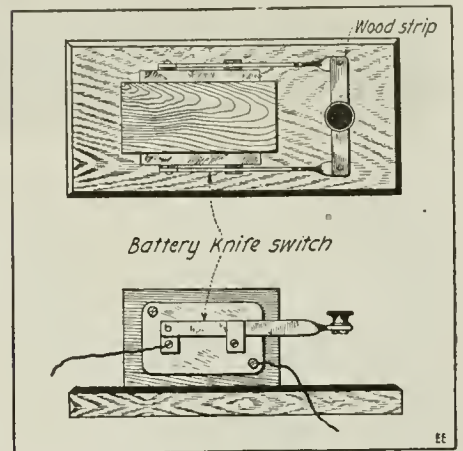

An Effective Double-Pole Single-Throw Knife Switch Constructed from Two S. P. S. T. Knife Switches.

der. Then get a thin strip of wood or fiber to fit across the ends of the knives. This can be fastened on with small stove-bolts. In the center of the strip bolt a small porcelain knob.

Contributed by HENRY RHEIMS.

DRAFTING HINTS.

Tracings may be very readily cleaned and pencil marks removed by the use of benzine, applied with a cotton swab. It may be rubbed freely over the surface without fear of injury to the lines drawn in ink, or even water colors, but pencil marks and dirt will quickly disappear. The benzine evaporates almost immediately, leaving the tracing unharmed. The surface, however, will be somewhat softened, and should be rubbed down with a little powdered talc or chalk before drawing more ink lines.

Always sprinkle chalk or talc on surface (dull side) of cloth, rub in with fingers, and wipe off before starting to draw ink lines.

SIMPLE HOME-MADE SNAP SWITCH.

This is a very durable but simply constructed snap switch. (A) is the screw from an old dry cell carbon, the head (E) being filed flat and inserted in a small block of wood (I) drilled as shown. The block (I) is fastened to wood base (G) with screw (B). A strip of spring bronze (D) inserted thru the slot in spindle (F) assures an excellent contact. (C) is a pin for handle and (H) the supporting screw holes.

The spindle is held in the base by a small rivet at the bottom. This can be

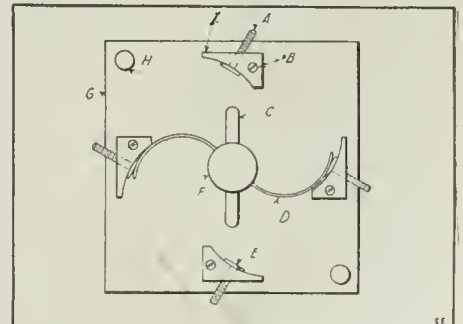

Here's a Way to Make Home-Made Snap Switches. It Works Very Well, Too.

used either as a single or double-pole switch.

Contributed by HENRY O. WUELFING.



SPIRIT LAMP FROM FAN GREASE-CUP.

A novel but efficient spirit lamp can be made from a fan grease-cup when cleaned and filled with alcohol and a wick inserted.

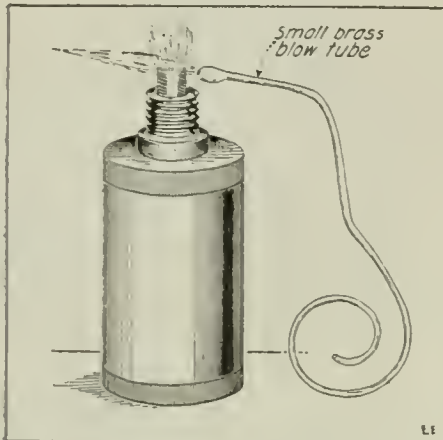

Simply Fill a Fan Grease Cup with Wood Alcohol, Insert a Wick in the Hole, and You Have a Serviceable Little Spirit Lamp for Light Soldering

It will burn for one hour. This lamp can be used for numerous purposes, such as removing enamel from enameled wires, et cetera. A small brass tube can be easily soldered to the cup for the purpose of providing a blast of air and a side-wise concentrated flame tip, by blowing thru the tube. The upper end of the tube must be closed, and a tiny hole drilled in it—about No. 64 drill.

Contributed by EDWIN WOLBER.

SOME INTERESTING CHEMICAL EXPERIMENTS.

When a very little dry powdered potassium permanganat is moistened with sulfuric acid, brownish-green oily drops of permanganic anhydrid (Mn_2O_7) are formed. This compound is volatile, giving a violet vapor and is apt to decompose explosively into oxygen and manganese dioxid. Its oxidizing power is such that combustibles like paper, ether and illuminating gas are set on fire by contact with it.

White phosphorous, when heated with sulfur unites with explosive violence. By using red phosphorous the action can be controlled. The product is phosphorous sulfid and the kind depends upon the proportions used.

If a small piece of sodium is placed on a piece of filter paper and placed on water, the water is decomposed and the heat liberated is sufficient to set fire to the sodium, which burns with a characteristic yellow flame.

Powdered magnesium and potassium chlorat in the proportions of 10:17 is used in making flashlights for use in photography.

Cordite, a variety of smokless powder, is made by dissolving gunccotton (65 parts) nitro-glycerin (30 parts) and vaseline (5 parts) in acetone. The resulting paste is rolled out and cut into small pieces. When the acetone evaporates the horny cordite remains.

Javelle water (solution of sodium hypochlorit) is an ingredient of ink eradicators. The solution is first applied to the ink and a dilute solution of hydrochloric acid is rubbed over it. The chlorin which is liberated is responsible for the bleaching effect.

Contributed by ALBERT TOTH.

TEST CLIP MADE FROM BINDING POST.

For making contact with insulated wires take an old binding post and file the thumb screw to a point. Also cut a portion of one side out with a hack-saw as shown in the drawing. To make contact with an insulated wire, simply slip the wire in the slit in the side and force the thumb screw point thru the insulation. This saves the time and bother of skinning the wire. It also may be used as a helix clip.

Contributed by MERLE E. NANTZ.

FITTING A MINIATURE BULB TO STANDARD SOCKET.

First we need a broken Edison bulb, a miniature lamp and some sealing wax or paraffin. Then break all the glass from the bottom of the large lamp base. Now solder the two wires from the Edison shell to the rim and center of the miniature bulb. Heat some sealing wax and pour in around the shell and set aside to harden. This attachment will be useful to anyone who has a socket with a snap on the side or a pull-chain socket.

Contributed by STAN. DIRVIN.

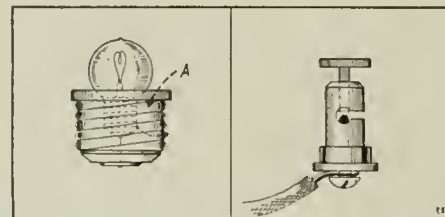

At Left: Standard Lamp Base Fitted to Miniature Lamp. At Right: Handy Test Clip Made from Binding Post.

CHEMICAL EXPERIMENTS.

No. 1: Put on a clean white plate or saucer, a mixture of pulverized sugar and potassium chlorat. Upon adding a few drops of sulfuric acid a vivid combustion will ensue. By adding with the sugar a few iron and steel filings, and performing the experiment in a dark room, or out of doors at night, fiery rosettes will flash thru a rose colored flame, and produce a fine effect.

No. 2: Mix a teaspoonful of nitric acid with a teaspoonful of sulfuric acid; place a little turpentine in a teacup out of doors, and pour the mixture upon it at arm's length. The turpentine will burn with almost explosive violence.

No. 3: Make a saturated solution of sodium sulfate (Glauber's Salt), in warm water; pour the mixture in a bottle, and let it stand. The salt will remain for months without crystallizing; but if taken up, and shaken a few times, the whole mass will instantly form

into crystals, so filling the bottle that not a drop of water will escape. Should there be any hesitation at the moment of shaking, drop a small crystal of the salt into the bottle, and the effect will be instantly seen, by the darting of new crystals in every direction.

No. 4: Heat a piece of tin until the coating begins to melt; then cool quickly in water and clean in aqua regia. The surface will be found covered with beautiful crystals of the metal.

No. 5: Pour dilute nitric acid upon bits of tin. Dense red fumes will pass off.

No. 6: Throw crystals of any nitrat on red hot coals; they will deflagrate with dense red smoke.

Contributed by GLENN HELWAGEN.

PERCENTAGE SOLUTIONS.

The difficulty about percentage solutions, says *Studio Light*, will disappear if the worker will always bear in mind that one fluid ounce of water weighs 437½ grains, which is, of course, equivalent in weight to one ounce avoirdupois. It follows that if one-tenth that number of grains—i.e., 43.75 grains—of any ordinary soluble chemical is put into a graduated glass and water added to make up one fluid ounce, the result will be a 10% solution.

In the following table the figures are worked out for solutions of various strengths. If the number of grains indicated in the table are taken and sufficient water added to make up one fluid ounce, it will be found that the solution has the required strength.

For a 1% solution take	4.37 grains
" 5%	" 21.87 "
" 10%	" 43.75 "
" 20%	" 87.50 "
" 30%	" 131.25 "
" 40%	" 175.00 "
" 50%	" 218.75 "

HOW TO FILE SOFT METALS.

The teeth of a file are soon filled when the file is used on lead, tin, soft solder or aluminum. It cannot be cleaned like the wood rasp by dipping it into hot water, but if the file and the work are kept wet with water, there will be no trouble as the already wet particles of lead, soft solder, etc., do not readily adhere to the file.

HANDY COMPUTER FOR MECHANICS.

Here's the latest vest-pocket computer for electrical and mechanical men. By rotating the cap on end it shows at a glance the size of drill to use for taps from ¼ to 2 inches. U. S. S. Pipe ¼ to 3½ inches. A. L. A. M. to 1 inch. S. A. E. to 1½ inches also 15 small numbered sizes below 1¼ inches. It has the advantage over blue-prints and chart that it can be easily carried in the vest-pocket.

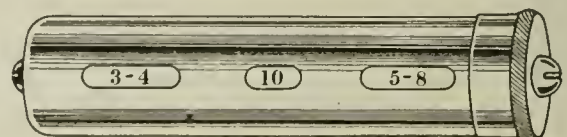

A Useful Computer for Machinists and Experimenters. It Shows the Size of Drill for Any Tap Instantly.

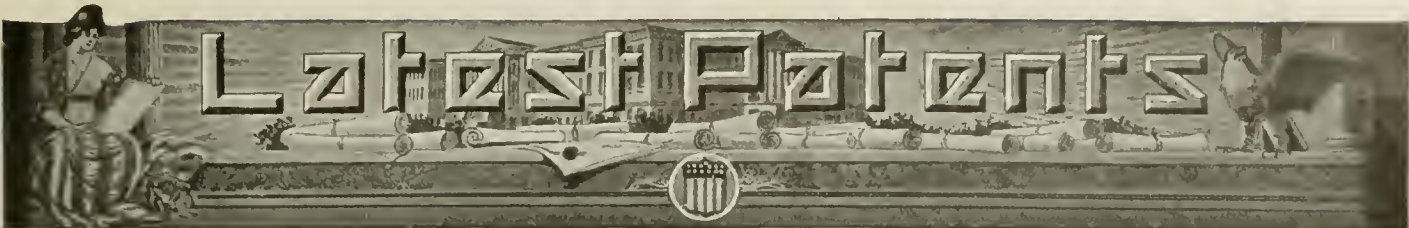

Loose Coupler

(No. 1,276,618, issued to Carlyle B. Campbell.)

This patent relates to an improvement in tuning transformers and particularly to a switching arrange-

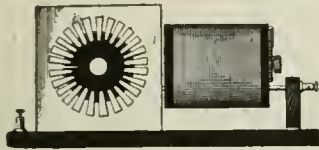

ment by which unused portions of the inductance or winding are completely cut off from the circuit, thereby eliminating undesired effects on the wave lengths. The arrangement shown provides for a plurality of separate coils in close inductive relation. The terminals are connected with solid and spring contacts, adapted to be separated by a revolvable insulating disk in order to cut out certain coils when so desired. In other words, it incorporates a revolvable form of dead-ending switch.

Electrically Heated Radiator

(No. 1,276,573, issued to James J. Kohan.)

An electrically heated steam radiator of novel design in which there is provided a radiator of the usual form, together with an electrically heated steam generator, this latter being very rapid and economical in operation, it is claimed. Simple and positive means are provided for

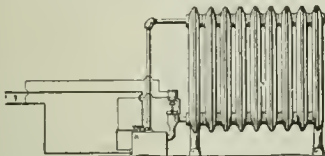

automatically controlling the flow of electric current to the heater, and likewise for automatically controlling the flow of water of condensation from the radiator back to the heating device; this automatic control being effected thru the medium of the steam pressure developed within the heating device.

Electric Shutter Trip for Cameras

(No. 1,277,592, issued to Gilbert R. Horton and John M. Miller.)

By means of this electromagnetic actuating mechanism for camera shutters, photographs may be taken at a considerable distance from the operator, such as where animals are to be photographed. The length of circuit over which this shutter device may be operated is governed only by the strength of the battery used. A push button or switch is located at the battery, the current completing a circuit thru the small electromagnet fitted to the shutter trip as shown. When the magnet is actuated the shutter is opened; continued pressure on the push button will hold the shutter open.

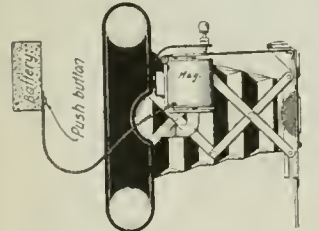

Electric Headlight

(No. 1,276,605, issued to Overton Winston.)

An improved electric headlight for automobiles and other machines and providing a special means for shifting the electric light bulb with respect to the reflector, whereby the bulb may be moved transversely toward and from the axis of the reflector. A soft iron or steel collar is secured to the rear end of the lamp base, which serves as an armature in cooperation with an upper and lower control electromagnet. These electromagnets are secured to and supported by an annular ring mounted in the lamp housing back of the reflector. Thus the lamp bulb proper may be thrown up or down, simply by actuating one or

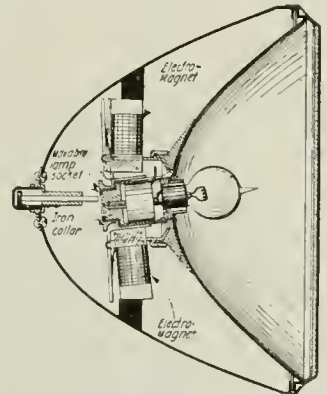

the other of the electromagnets, throwing the light beam either far ahead of the machine or else just in front of it on the ground, as may be desired.

Apparatus for Concentrating and Projecting Radiant Energy

(No. 1,278,026, issued to Salvatore Salto.)
An apparatus for the concentration of light, heat and electric rays and for the projection of these rays in a certain desired manner. This apparatus for concentrating and directing light rays has for its purpose to illuminate objects by concentrating light rays thereon, by means of reflectors with elliptical curvature.

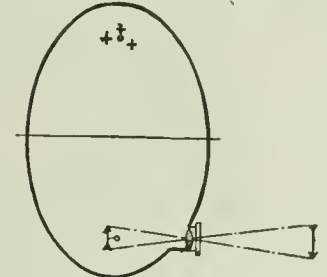

The object to be examined or illuminated may be observed directly by placing it inside the hollow ellipsoid, or projected on a screen by means of a suitable device such as a microscope or a magnifying lens. Thus extremely high specific luminous or calorific intensities are obtainable by concentrating emanations from several sources of energy and causing them to be projected. An apparatus such as this may be used as a marine searchlight or coast light, or as a projector for motion picture machines, automobile headlights, etc. The apparatus can also be used for concentrating heat radiations.

A Sound Operated Dog

(No. 1,279,831, issued to Christian Berger.)

When you clap your hands or whistle to this "pup" he jumps out

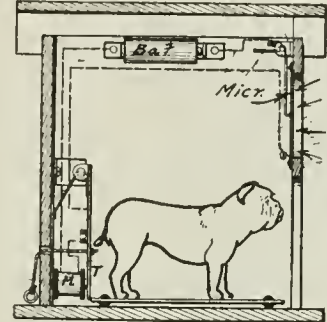

of his kennel in great delight. All because of a clever arrangement of a simple microphone and electromagnet which holds the trip retaining the dog within the kennel, until the sound produced by the clap of the hands or whistle strikes the microphone. At this instant the normal constant current thru the retaining electromagnet drops to a comparatively low value, thus releasing the powerful spring which kicks "Fido" out the door.

Primary Battery

(No. 1,276,754, issued to Walter Grothe.)

A novel arrangement for supporting the electrode elements within a

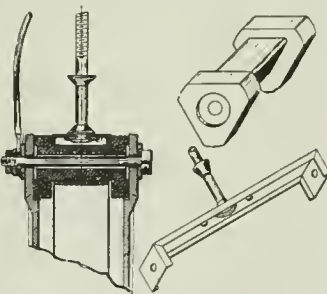

primary battery. The supporting member for the electrodes consists of a flanged yoke having depending ends, while a suspending bolt passes thru a hole in the yoke and is riveted therein. A spool of porcelain is arranged to be clamped against the yoke as shown. The shank and heads are preferably of triangular shape. A perforated container closed on all sides excepting the top, is adapted to be clamped between the depending ends of the yoke and the ends of the clip.

Crystal Detector

(No. 1,277,627, issued to Thomas B. Miller.)

A crystal detector for radio receivers which is claimed to be exceptionally rugged and reliable in design; also its operation is not likely to be interfered with by mechanical jars or concussions. This

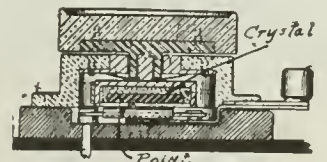

adjustable feature enables the contact member to be placed at any point upon the surface of the crystal desired, and the contact point and and crystal are both enclosed.

Motor-Driven Revolving Door

(No. 1,278,145, issued to Edward C. Haviland.)

Where a revolving door is continuously rotated, electric current is being continuously consumed regardless of the egress or ingress of people thru the door. The object of the present invention is to provide a means whereby a motor for revolving the door is only put in operation when a person is passing thru the door. This device comprises switches carried by the individual wings of the door in prox-

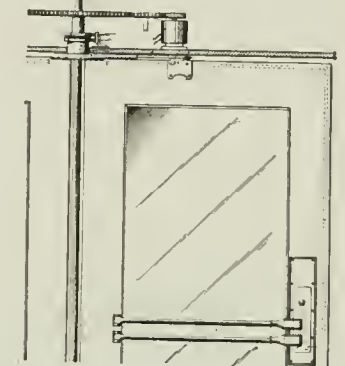

imity to the usual hand-rails, so that they may be either consciously or unconsciously actuated by the person passing thru the door. These switches establish electrical circuits to the actuating motor, but only for such time as is necessary for the person to pass in or out of the door.

Radio-Telegraph Transmitter

(No. 1,278,507, issued to Oscar C. Roos.)

A system in which the discharge of the oscillating circuit condenser may be readily controlled over a wide tone range. The operation is as follows: The high-frequency generator A cannot break down a larger gap than S and the arresters, therefore prevent the discharge of the condenser C' across the gap unless they are simultaneously broken down. They

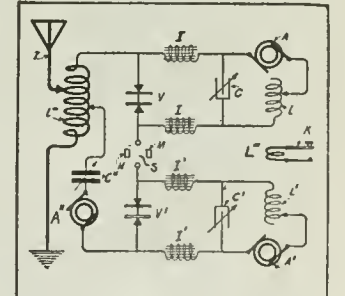

will be simultaneously broken down 2(n-m) times a second where "n" and "m" represent the frequencies of the generators A, A' respectively, so that the tone produced in the receiving system will be the "beat frequency" of said generators. This tone, as will be obvious, may be widely varied by slightly altering the speed of one or both generators. This scheme will thus be seen to afford a very simple and flexible electrical substitute for various mechanical devices such as the "tone wheel," the rotating spark gap, etc.



Our Amateur Laboratory Contest is open to all readers, whether subscribers or not. The photos are judged for best arrangement and efficiency of the apparatus. To increase the interest of this department we make it a rule not to publish photos of apparatus unaccompanied by that of the owner. Dark photos preferred to light-toned ones. We pay \$3.00 prize each month for the best photo. Address the Editor, "With the Amateurs" Dept.

"Amateur Electrical Laboratory" Contest

THIS MONTH'S \$3.00 PRIZE WINNER—ALFRED STACEY

HEREWITH are photographs of my laboratory. On the large table in the center of the room may be seen the radio outfit which was assembled in its original place to take this photograph. When set up it was used with an aerial one hundred and fifty feet high, one hundred feet long, with four stranded wires placed three feet apart. The transmitting set consists of a $\frac{1}{2}$ K. W. transformer, condenser, rotary gap, oscillation transformer, aerial inductance, aerial condensers, and hot-wire meter, keys, etc., also a Poulsen arc and transmitter for radiotelephony. For receiving, I have receiving transformers, variable condensers, fixt condensers, audion, loading coils, Ferron, Galena, and Silicon detectors, two pairs of 'phones, etc. On the experimental table to the left of the radio table may be seen Tesla, audion, step-up and step-down transformers, meters, batteries of different types, motors, generators, telegraph and telephone instruments, condensers, measuring instruments and other electrical apparatus. To the right of this apparatus may be seen the two switch-boards containing circuit breakers, switches, and rheostats for controlling various instruments. To the right of the switch-board may be seen the work-bench for building and repairing instruments. To the right of work-bench, chemicals, elements, retorts, graduates, flasks, hydrometers, thermometers, *ad infinitum*. To the right of this bench will be seen another bench used for the manufacture of chemicals such as bromine, chlorine, etc. Next may be seen the stock-room and dark-room used for photo developing and printing. I have a book-shelf containing over one hundred and fifty chemical and electrical books. This laboratory is the result of ten years' hard work assisted by the famous "Electrical Experimenter" and "Modern Electrics."—ALFRED STACEY, Hamilton, Ontario, Canada.

HONORABLE MENTION (1 Year's Subscription to the "ELECTRICAL EXPERIMENTER") GERALD DITTMAN

I PRESENT herewith photograph of myself and two of my laboratory. I am eighteen years old and have had my laboratory for about a year. I have a great number of chemicals which I use for testing foods and for mixing up different solutions to see what effect they have on electricity. I have made an arc light which furnishes all my illumination. I use an ammeter to show how much current I am drawing and in that way save fuses, because when the pointer approaches ten amperes, I know a fuse will blow and I can shut it off in time. I also have a number of motors, a transformer, spark coils, condensers, Leyden jars and other instruments which I use for various experimental purposes.—GERALD DITTMAN, Chicago, Ill.

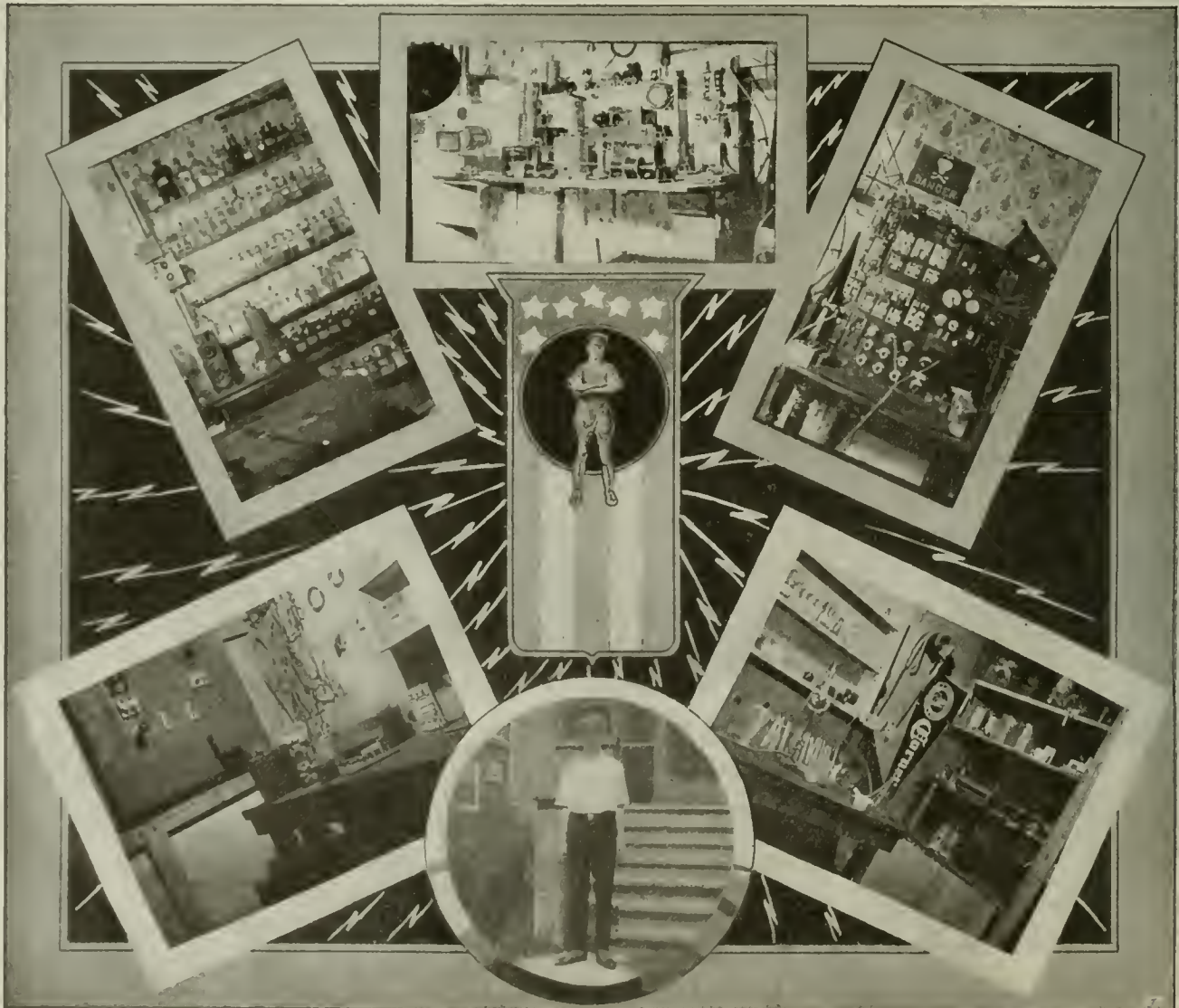

Phoney Patents

Under this heading are published electrical or mechanical ideas which our clever inventors, for reasons best known to themselves, have as yet not patented. We furthermore call attention to our celebrated Phoney Patent Office for the relief of all suffering daffy inventors in this country as well as for the entire universe.

We are revolutionizing the Patent business and OFFER YOU THREE DOLLARS (\$3.00) FOR THE BEST PATENT. If you take your Phoney Patent to Washington, they charge you \$20.00 for the initial fee and then

you haven't a smell of a Patent yet. After they have allowed the Patent, you must pay another \$20.00 as a final fee. That's \$40.00! We PAY YOU \$3.00 and grant you a Phoney Patent in the bargain, so you save \$43.00!! When sending in your Phoney Patent application, be sure that it is as daffy as a lovesick hat. The daffier, the better. Simple sketches and short descriptions will help our staff of Phoney Patent Examiners to issue a Phoney Patent on your invention in a jiffy.

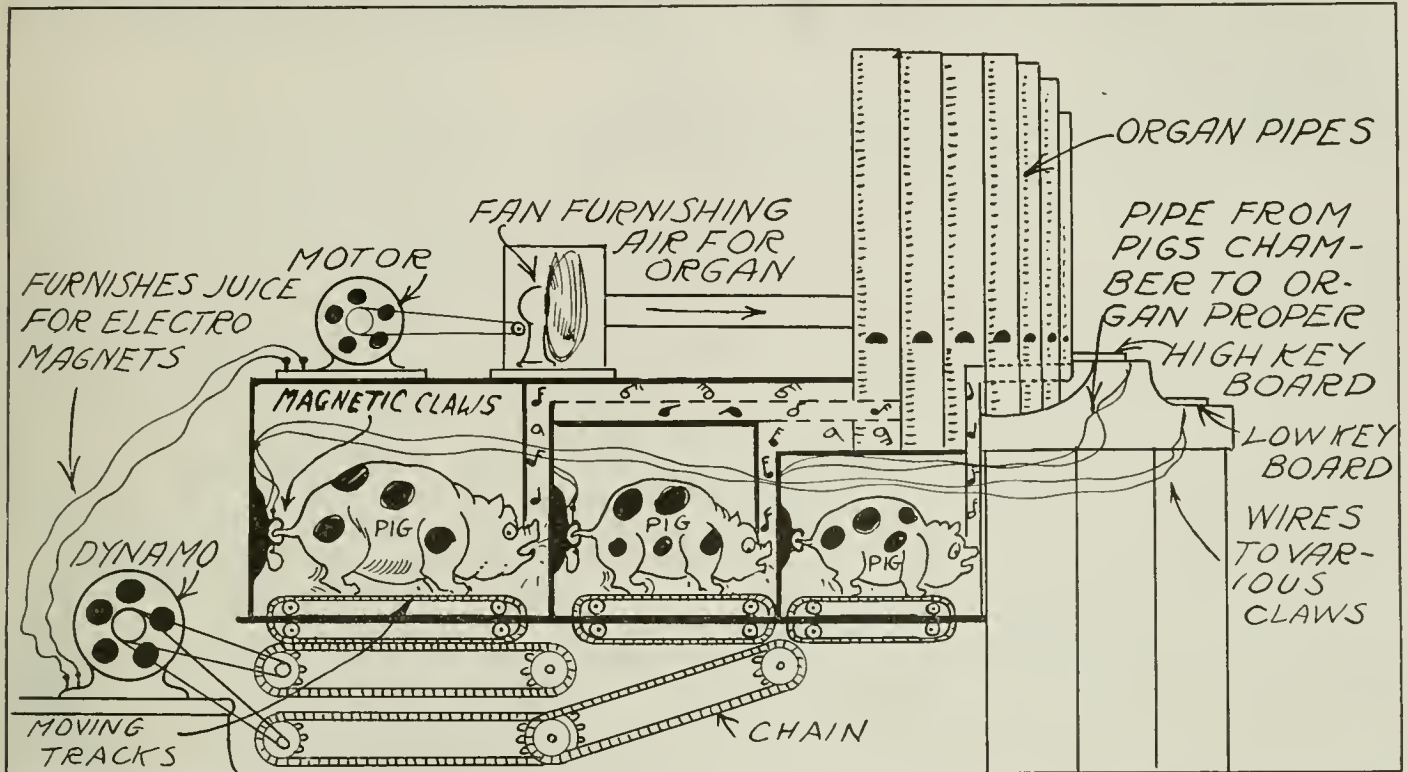

Prize Winner: WEEWEEPIGORGAN. Take one gross pigs fresh and lusty, assort according to musical scale, put each in soundproof chamber, attach tails to electromagnetic claws operated by keyboard. Pigs run on endless belts furnishing power for organ. Depressing keys on keyboard pinches pigs' tails. Pig sings weee—weeeee—weeee, as long as key is pressed. Don't use old sows. They sow discord. French airs go well on this organ due to the oul, oull! Inventor: Paul Gaugewere, Bethlehem, Pa.

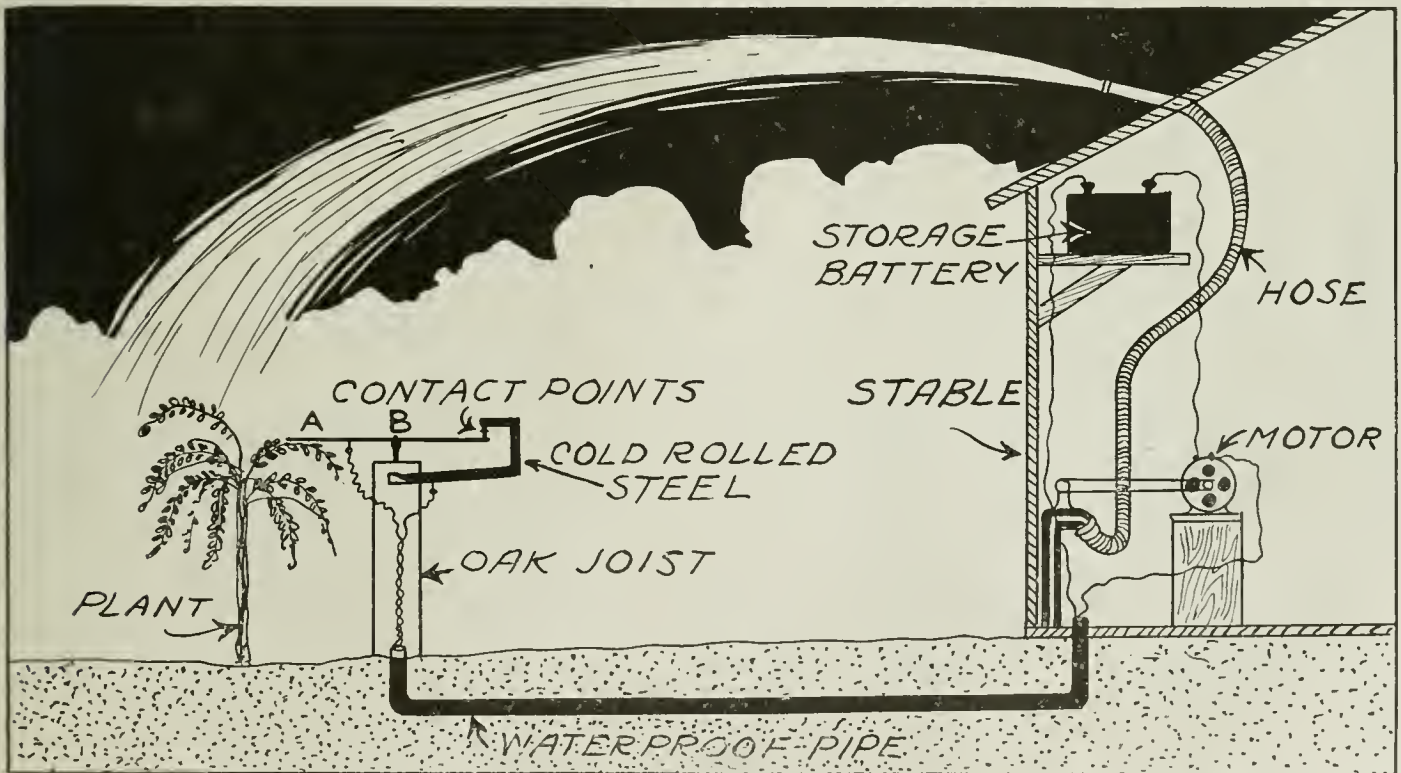

MIMOSA ELECTRICUS AUTOMATICUS. Sun. More Sun. Heat. Dry. Draught. Plant. Droops. A, B, UP. Contacts. Kiss. Bliss. Juice. Motor. Battery. H₂O. Hose. Spurts. H₂O. Drops. Rain. Plant. Branches. Newlife. Upshego. A, B. Down. Contacts. DIVORCE. Rain. Nix. Simple. Fix. See? Oul. Oull! Inventor: Frank Truka, 280 Woolsey Ave., Astoria, L. I.

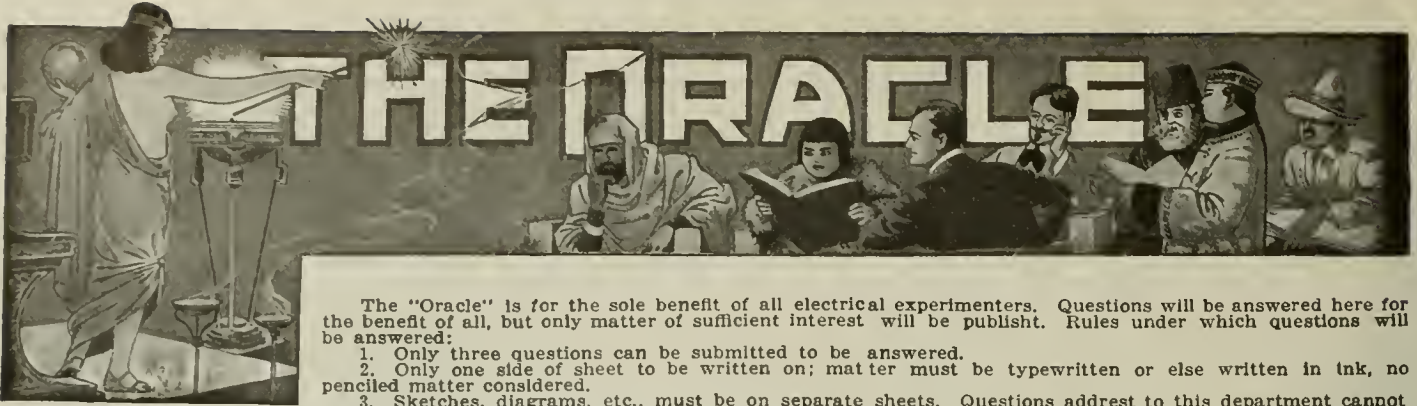

The "Oracle" is for the sole benefit of all electrical experimenters. Questions will be answered here for the benefit of all, but only matter of sufficient interest will be published. Rules under which questions will be answered:

1. Only three questions can be submitted to be answered.
2. Only one side of sheet to be written on; matter must be typewritten or else written in ink, no penciled matter considered.
3. Sketches, diagrams, etc., must be on separate sheets. Questions addressed to this department cannot be answered by mail free of charge.

4. If a quick answer is desired by mail, a nominal charge of 25 cents is made for each question. If the questions entail considerable research work or intricate calculations a special rate will be charged. Correspondents will be informed as to the fee before such questions are answered.

FIRING TWO FLASH-LIGHT POWDER PANS SIMULTANEOUSLY.

(970) Fred Wheeler, Galt, Ont., Can., wants to know:

Q.1. How to fire two or more flash-light pans simultaneously.

A.1. For firing flash-light powder at

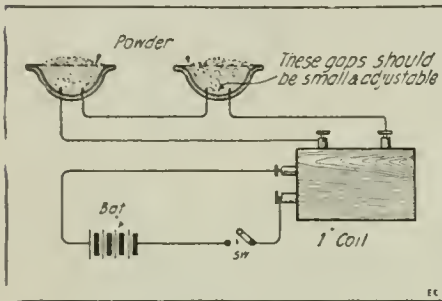

Firing Two Flash-Light Powder Pans at Once by Means of Spark Coil. Several Flashes May Be Ignited at Once.

two places simultaneously, we refer you to arrangement as per diagram. Use a spark coil and battery as indicated in diagram. Wire the two or more flash pans in series. Keep the spark gap in each pan small— $1/16$ " gap is sufficient.

HOW TO TELL DYNAMO POLARITY.

(971) Paul Miles, Chicago, Ill., inquires: Q.1. How can the positive terminal of a small D. C. dynamo be determined?

A.1. Off-hand we cannot tell you which is the positive brush. However, we advise you to make the following test: In a 50% solution of salt water put two wires connected to the dynamo, and note from which wire the most bubbles come off. This is the negative wire.

A 4-volt dynamo will give about 3 amperes. However, much depends upon the condition of the brushes (contact, pressure, etc.), and the condition of the batteries. We would advise you to refer to "Lessons in Practical Electricity and Magnetism," by Swoope, which can be purchased thru our Book Department for \$2.25, postpaid.

SPEED CONTROL OF A.C. MOTORS.

(972) Hugh McPherson, Borden, Sask., Can., asks:

Q.1. How can I control the speed of a 30 H.P. A.C. 3-phase motor?

A.1. The speed of the 30 H.P. A.C. 3-phase motor can be regulated in several ways, some of the best of which are as follows:

The voltage applied to the motor is varied by a transformer from which several taps are brought out to a controller, thereby

varying the speed. Again, by means of an induction regulator which consists of a primary and secondary winding, having an iron core with one of the windings so arranged as to allow of being varied thru 180 magnetic degrees.

The above methods are really best for single-phase service, while the following method is very good for the three-phase service: In this method the speed can be varied by changing the number of poles of the motor connected in the circuit by

means of suitable switches or by varying the current by a suitable rheostat connected in the respective legs of the wound rotor circuits. This last method also applies to the single-phase system, wherein the current is varied by means of a rheostat.

LOOSE COUPLER AND DISTRIBUTED CAPACITY.

(973) C. W. Opert, Freeport, Ill., wishes to know:

Q.1. Several points about making a loose coupler transformer for radio receiving circuits.

A.1. In constructing a loose coupler, the best way to take the taps off is as follows: At the required part of the coil, punch a hole in the cardboard tube and bring about 18 inches of wire right thru this hole by looping the wire, and then pushing it thru. All that remains to be done now is to continue winding the coil until all the taps have been made.

We provide coils with dead-end switches in order to get rid of the distributed capacity. Distributed capacity is the capacity which exists between the turns of a helical coil, and for your benefit we refer you to an extensive article on this subject which was printed in the May, 1917, issue of this journal.

TESLA COIL FOR 2-INCH SPARK COIL.

(974) R. Conover, New York, N. Y., inquires of "The Oracle":

Q.1. For data on a Tesla coil suitable for use on a 2-inch spark coil as an exciter.

A.1. The ordinary Tesla coil, especially designed to work with a spark up to 2 inches on the primary side will do, and is briefly described as follows. The primary should consist of 14 turns No. 10 solid, rubber-covered copper wire in one layer on a spool $4\frac{1}{2}$ inches in diameter, while the secondary consists of a coil $2\frac{3}{4}$ inches in diameter and 12 inches long, wound its full length with a layer No. 28 enamel wire.

This size of Tesla coil can be furnished by the leading companies who advertise in our magazine. It is best to use two one-pint Leyden jars connected in parallel or a one-quart Leyden jar.

The construction for a glass plate condenser for the above Tesla coil is as follows: Procure five glass plates $6 \times 7 \times 1/16$ " and four pieces of tin-foil 5×6 inches. The tin-foil should be placed between the five plates so that two ends of the tin-foil protrude from the sides of the glass. The size of the spark obtained from the above Tesla coil will be about $3/4$ to 1 inch and can be taken thru the body without any harm.

(Continued on page 648)

ODD PHOTOS WANTED AT \$1.00 EACH!!!

Now is the time to make your Kodak pay for itself in a real practical way. We are after interesting photographs of out-of-the-ordinary electrical, radio and scientific subjects and are willing to pay \$1.00 cash for every one we can use. Please bear in mind that for half-tone reproduction in a magazine, a photograph should be particularly sharp and clear. Of course, if a subject happens to interest us particularly well, we can have the photo re-touched. For the general run of subjects, however, it does not pay to go to such expense. Therefore, please take pains to properly focus and expose your pictures. It often happens that a really mediocre subject well photographed wins approval over an excellent subject poorly photographed. And don't send us plate or film "negatives"; send unmounted or mounted "prints", preferably a light and dark one.

As to what to photograph: Well, that's hard for us to say. We leave that up to you, and every reader now has the opportunity to become a reporter of the latest things in the realm of Electricity, Radio and Science. But, please remember—it's the "odd, novel or practical stunts" that we are interested in. Every photo submitted should be accompanied by a brief description of 100 to 150 words. Give the "facts"—don't worry about the style. We'll attend to that. Enclose stamps if photos are to be returned and place a piece of cardboard in the envelope with them to prevent mutilation. Look around your town and see what you can find that's interesting.

Address photos to—Editor "Odd Photos", ELECTRICAL EXPERIMENTER, 233 Fulton Street, New York City.

Free Test Lesson in Draftsmanship

TEST LESSON IN DRAFTSMANSHIP

Prepared Especially for Our Prospective Students to Enable Them to See How Simple and Easy Is Our Method of Home Instruction
The Most Practical Correspondence Course Ever Written on the Subject

Send for this free lesson which explains the Chicago "Tech" method of teaching Draftsmanship by mail. Positions at big salaries are now waiting for competent men. The call of men to the war has left vacancies everywhere. Even draftsmen of limited training and experience are snapped up and paid good salaries. If you are dissatisfied with your opportunities, learn Draftsmanship. Chicago "Tech" will train you in the most practical way in the shortest time. Mail the coupon today and let us tell you about the Chicago "Tech" method. This free lesson will show you how well equipped you are to follow Draftsmanship. Enroll in the course only if you decide that you can take it up to advantage. No cost, no obligation on you to make this investigation.

Come to the College or Learn At Home

Hold your present position while training. Our experts will instruct you by mail. Only your spare time is required. You are directly under practical draftsmen and engineers. You are taught exactly the work required in the drafting rooms of big concerns. No time to put in on unnecessary studies. This means thorough instruction and early graduation.

\$25⁰⁰ to \$100⁰⁰ a Week

Draftsmen earn good salaries in normal times. They command extra high salaries now—and the tremendous work to be done after the war will bring a permanent and intensive demand for good men. Make your spare time count now for a higher salary and a better position.

Auto and Gas Engine Course

All about automobile mechanism—its construction, operation and REPAIR—taught by mail. You train directly under the Chicago "Tech" automobile experts. Splendid opportunities open now.

Learn All This In Spare Time

Principles of the Automobile. Every point made clear about the basic principles of propulsion, power, transmission systems, etc., etc.
Gasoline Engines. All about the different types. A complete course in gas engine construction, operation and repair.
Power Plants and Transmissions. Application of power, by 4-6-8-12 cylinder engines. Types of clutches, Gears, Drives, Axles, etc.
Carburetors and Fuel Supply Systems. All methods demonstrated. Fuel values. How to test. Gasoline and air mixtures. Regulation, etc., etc.
Lubrication and Cooling. All about oils and how to test them. Splash and circulating systems. Operation in different cars explained. Diagrams, etc., etc.
Batteries. Electrical principles explained. Insulative diagrams of wiring and connections, etc., etc.
Magneto Ignition. Principles and practical operation of various types and systems with diagrams.
Generation of current. Field, armature, high and low tension, all explained. Complete in every point.
Starting and Lighting Systems. All modern methods. Starters—spark, mechanical, air, acetylene, electric, battery—shown in detail with diagrams and full explanations. Charging. Motor and generator adjustments, etc., etc.

Know How to Fix Troubles

Most complete instruction in auto repair work. Equips you for high pay or to start a business. Big demand for trained repair men.

WRITE

Send the coupon and get catalog and all information—now.

Easy Payments

The fees for Chicago "Tech" Courses are very moderate—and you can pay on easy terms. And also—you obtain in a few months what it would take several years to acquire by ordinary methods. You can get an early start. You are soon ready to take a paying position and to quickly get back the cost of your course.

Send the Coupon

The sooner you are prepared the sooner you will be holding a job that pays a large salary and opens the way to advancement. Many executives, general managers and superintendents began as draftsmen.

Other institutions ask you to pay first—and then to find out later how well qualified you are for this profession. We send the free lesson first and place you under no obligation at all. Discover your qualifications before you pay anything.

The coupon will bring the Test Lesson, free. Also information about the profession of Draftsmanship and detailed facts about Chicago "Tech" methods, the fees, terms, etc. Mark with X the branch you are interested in—or if in doubt about which course to take, write a letter stating facts about yourself and asking our advice which will be freely given. Mail either the coupon or the letter today.

FREE Instruments

Every student of the Chicago "Tech" Course in Draftsmanship receives this set of instruments, or a cash credit in case he already has a set. These instruments are of the same make and sizes as used by high salaried experts in drafting rooms of factories, shops, railroads, etc. You use them while learning—then take them right into your practical work.

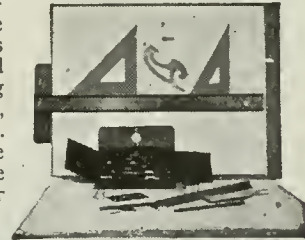

Chicago Technical College, 145 Chicago "Tech" Building, Chicago

Without obligation to me, please send me your FREE Test Lesson and other interesting literature covering the subject indicated below. Mark X opposite work in which you are specially interested.

- | | |
|---|--|
| <input type="checkbox"/> Architectural Drafting | <input type="checkbox"/> Plan Reading—Builders |
| <input type="checkbox"/> Machine Drafting | <input type="checkbox"/> Plan Reading—Shop Men |
| <input type="checkbox"/> Electrical Drafting | <input type="checkbox"/> Estimating |
| <input type="checkbox"/> Structural Drafting | <input type="checkbox"/> Surveying |
| <input type="checkbox"/> Sheet Metal Drafting | <input type="checkbox"/> Map Drafting |
| <input type="checkbox"/> Builders' Course | <input type="checkbox"/> Auto & Gas Engines |

Name

Address

City State

College or Home Study? State which

Mesco Telegraph Practice Set

For Learning Telegraph Codes

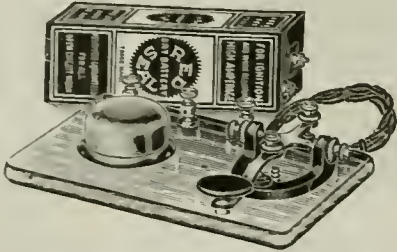

The Practice Set comprises a regular telegraph key, without circuit breaker, a special high pitch buzzer, one cell Red Seal Dry Battery, and four feet of green silk covered flexible cord.

The key and buzzer are mounted on a highly finished wood base, and three nickel plated binding posts are so connected that the set may be used for five different purposes. List No. Price

342 Telegraph Practice Set, with Battery and Cord.....\$3.24

Weights 4 lbs. packed. Price does not include postage.

MESCO Combination Practice Set for learning the Morse and Continental Visual and Audible Codes

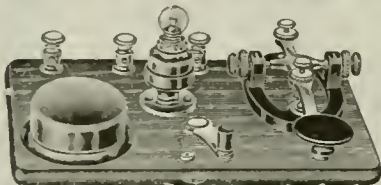

This outfit is the only reliable instrument which will enable students to become proficient operators in the U. S. Naval Service, because it is equipped with a buzzer and miniature lamp enabling the user to master both the visual and audible signals quickly.

List No. 52—Practice Set with Red Seal Battery and Cord.....\$4.05

Weights 4 lbs. packed. Price does not include postage.

Send for the New Edition of Our Catalog W28

It is pocket size, contains 248 pages, with over 1,000 illustrations, and describes in plain, clear language all about Bells, Push Buttons, Batteries, Telephones and Telegraph Material, Electric Keys, Burglar and Fire Alarm Contrivances, Electric Call Bells, Electric Alarm Clocks, Medical Batteries, Motor Boat Horns, Electrically Heated Apparatus, Battery Connectors, Switches, Battery Gauges, Wireless Telegraph Instruments, Ignition Supplies, etc.

Send for the Catalog Now

Manhattan Electrical Supply Co., Inc.

NEW YORK: 17 Park Place CHICAGO: 114 S. Wells St. ST. LOUIS: 1106 Pine St.
San Francisco Office: 604 Mission St.

MECHANICALLY RIGHT—A REAL LATHE

A Regular lathe, not a toy

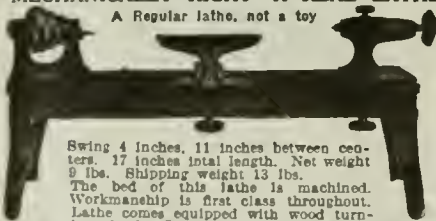

Swing 4 inches, 11 inches between centers, 17 inches total length. Net weight 9 lbs. Shipping weight 13 lbs. The bed of this lathe is machined. Workmanship is first class throughout. Lathe comes equipped with wood turning chuck. Lathe can be fitted with 3 inch face plate and drill chuck as special equipment. Order one today. Price \$4.50 cash with order. **SYMPHER MFG. CO., DEPT. C., TOLEDO, OHIO**

Feldman's "Geyser" Electric Water Heater

Instantaneous Hot Water

FELDMAN MFG. CO.

1500 Times Bldg. New York City

THE ORACLE.

(Continued from page 646)

RECORDING SPEECH ON A MOVING IRON WIRE.

(975) Miss Clara B. Griffin, Carthage, Ill., writes this Department:

Q. 1. Can an instrument known as the *Telegraphone* record speech?

A. 1. Relative to your inquiry regarding the *Telegraphone*, an instrument invented by Valdemar Poulsen of Denmark, we are pleased to state the following:

This instrument will record speech on a thin steel wire by recording the fluctuations of the magnetic lines of force set up thru a set of magnet coils. A full description of this machine was given by Samuel Cohen in the June, 1915, issue of this Journal; an article also appeared in a back issue describing iron disc type of *Telegraphone* designed as a dictating machine for business offices.

CHARGING LEYDEN JARS.

(976) Mr. B. Brewster, Dedham, Mass., asks:

Q. 1. Different ways to charge Leyden jars.

A. 1. We are giving a sketch herewith how to charge the ordinary Leyden jar by means of a static machine. The best way is to hold the jar in the hand and let sparks from one of the balls of the static machine jump over to the central ball of the Leyden jar. At first the sparks will jump fast, then as the jar becomes charged they will grow smaller and smaller, finally hardly any sparks will jump at all. This shows that the Leyden jar is fully charged. It can then be discharged by means of the ordinary discharger as shown in Fig. 2.

The important part to remember is that not every glass can be used for Leyden jars. Here is where many an experimenter is disappointed. Only *potash* glass can be charged—all the other varieties, such as *flint* and *lead* glass, "leak"—it being impossible to sustain a charge for even one second if such glass is used in the Leyden jar. If no *potash* glass is procurable, an ordinary phonograph disc coated on both sides with tinfoil will answer. Good results can also be had by using hard rubber sheeting. This material does not "leak."

It is not possible to charge Leyden jar by means of spark coils in the way the jars are charged with a static machine. In other words, the jars can never be fully charged and kept standing for a few seconds and subsequently discharged as if they had been charged with the static machine. The method to charge the jars with a spark coil is shown in our illustration, Fig. 3. In

order to get the charge, it is necessary to hold the discharger as shown, and a continuous discharge will flow across the two knobs. The quality of the spark is the same whether charged by a static machine or Leyden jar, except that in the case of a static machine the spark will sometimes leap several inches, while the jar charged with a spark coil will only leap an eighth or one-quarter of an inch, and in extreme cases one-half inch.

DOES A PERSON WEIGH MORE AFTER EATING.

(977) Querist, New York City, inquires:

Q. 1. Does a person weigh more after drinking say, 25 glasses of beer, or eating 10 lbs. of beefsteak (as often happens at beefsteak eating contests), or will their weight remain the same? "A" says they will weigh the same; "B" says their weight will increase in exact accordance with the amount of food or drink taken into the stomach.

A. 1. This is an interesting question and one that has been asked hundreds, even thousands, of times. The Editor of this column recollects that the usual answer by the man in the street is to the effect that he will weigh exactly the same. He will, eventually, but—well, listen to the learned

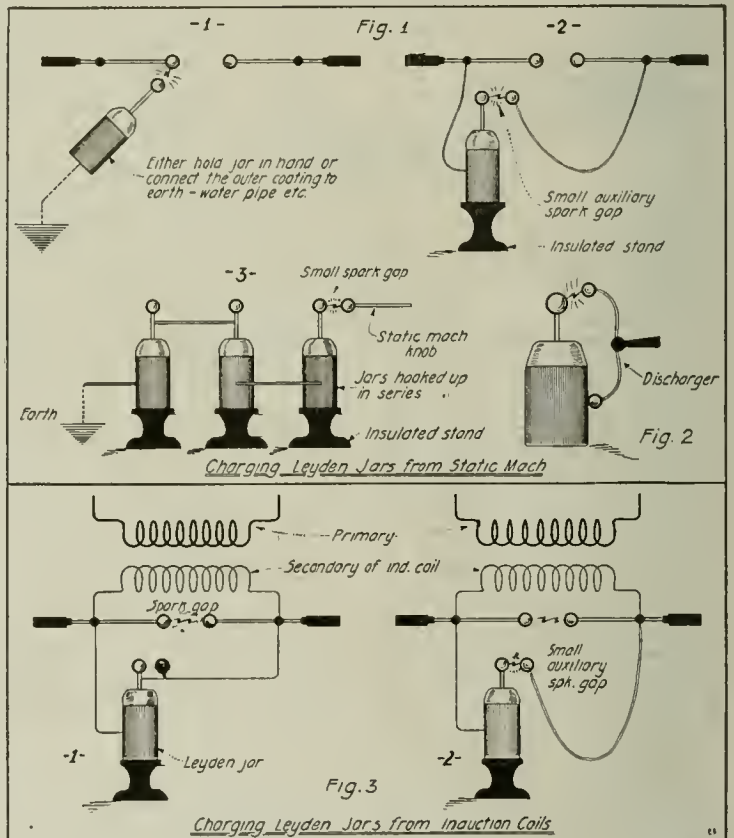

Various Ways in Which to Charge Leyden Jar Condensers from Static Machines and Induction Coils.

arguments put up by three well-known New York medical authorities.

Says the New York Medical Journal: In the case of eating, say, a pound of meat or drinking a pint of water, the weight of the human being is increased immediately after. In the course of two or three hours, however, the weight will return to normal, due to evaporation of moisture from the lungs and pores of the skin, also to digestion.

Dr. Sinclair Tousey, the well-known New York medical authority, says: Immediately after eating one pound of meat, the person in question would have less than one pound added to his weight. Owing to the increased evaporation of moisture from the

(Continued on page 650)

Learn Electricity

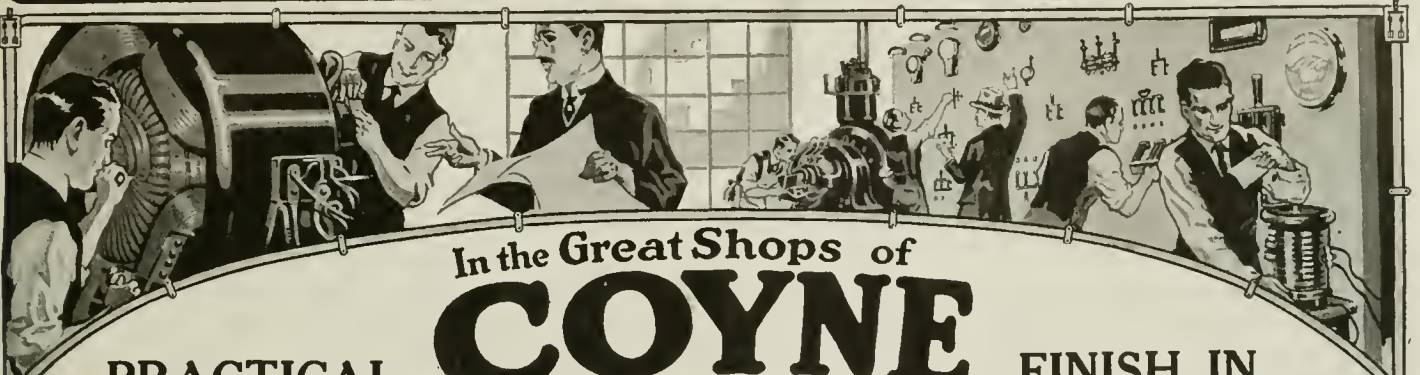

In the Great Shops of **COYNE**

**PRACTICAL
INSTRUCTION**

Trade and Engineering Schools
Dept. 21, 39-51 E. Illinois St., Chicago, Ill.

**FINISH IN
3 MONTHS**

Thousands of skilled Electricians are needed. The demand is becoming more urgent every day. The Government is employing every one they can get which is causing a great scarcity throughout the country and big salaries are being paid everywhere. Right now is *your* big opportunity. Make up your mind now to prepare for one of these big jobs and then get here as quick as you can for your training.

Earn \$100.00 To \$300.00 A Month

In the Electrical business. Come here where you will be trained in these great \$100,000 shops. Experts show you everything and you learn right on the actual apparatus. You work on everything from the simple bell to the mighty motors, generators, electric locomotives, dynamos, switchboards, power plants, everything to make you a master electrician. We have thousands of successful graduates. Just as soon as you have finished we assist you to a good position. We now have more positions than we can fill. Think of it.

PREPARE TO SERVE YOUR COUNTRY

War Demands Have Taken Thousands of Men from this Profession. Men *Must* be Trained to Fill their Places. Prepare Now for a Big Paying Position.

These courses are thorough, short and practical. All instruction given on the actual equipment. Each man is trained individually and stays until thoroughly trained. Start any time—day and evening classes.

Our graduates are in great demand. We are continually receiving letters, telegrams, and telephone calls from contractors, manufacturing firms, etc., seeking our graduates to fill responsible positions. We have now more positions than we can fill and the demand is steadily growing. Every comfort is given our students while here. They live in comfortable homes in the most beautiful section of Chicago—on the lake.

The War is Over—Yes!

but the men "over there" will not be back for months—perhaps years, for their work "over there" isn't over. And so you, and thousands more must fill up the gap now that the absence of these brave workers has made in the ranks of skilled labor. Trained Electricians are needed more, perhaps, than any other class of men. The sudden ending of the war has caused the big industries to start up work sooner than any of us expected and in consequence the Manufacturers are Calling for Trained Men, and we are training men as fast as we can to meet these urgent calls. You are needed, Young Man, now! Don't wait. Don't put it off. Get in touch with us Today. Get ready to join the great "Peace Army" here at home. Your country calls. Again we say, prepare to serve your country! We'll make a trained electrician of you in three months! Let's go!

LEARN DRAFTING

Skilled Draftsmen are always in demand. Our courses are thorough—short—practical, preparing a man fully to hold a position of responsibility. We have more positions than we can fill. We also have thorough practical courses in Plumbing and Heating, Motion Picture Operating and Bricklaying.

EARN YOUR WAY

Many students earn their living expenses by doing a little work in their spare time. Our employment dept. furnishes these positions without charge.

**COYNE TRADE AND
ENGINEERING SCHOOLS**
Dept. 21, 39-51 E. Illinois St.
Chicago, Ill.

Please send at once your big Free Book—I am interested in
 Electricity Drafting Plumbing
 Motion Picture Operating Bricklaying
(Check trade interested in)

Name.....

Address.....

**MAIL COUPON FOR FREE BOOK
NOW!**

You benefit by mentioning the "Electrical Experimenter" when writing to advertisers.

A-K TABLETS

FOR
**Grippe
Cold
in the
Head**

**Headaches
Neuralgias
Spanish Influenza
Women's Aches and Ills
Rheumatic and Sciatic Pains**

Ask Your Druggist for A-K Tablets
Sold in Convenient Pocket Packages

Small Size  Dozen Size
10c **25c**

See Monogram  on the Genuine
The Antikamnia Remedy Company
St. Louis, Mo.

HOTEL ST. JAMES

Times Square, New York City
Just off Broadway at 100-113 West 45th St.
1 1/2 Blocks from 45th Street Entrance
to Grand Central Station.



Women will find here a home atmosphere and absence of objectionable features of ordinary hotel life.

40 Theatres, all principal shops, 8 to 5 minutes walk.

2 minutes of all subways, "L" roads, surface cars, bus lines.

An excellent Restaurant, at moderate prices.

Write for "What's Going On In New York"

All Outside Rooms
With adjoining bath - - from \$1.50
With private bath - - from \$2.00
Sitting room bedroom, bath, from \$4.00

Furnished Apartments by the year, month or week, at special rates.

RAYMOND L. CARROLL, Pres. and Mgr.

Build Your Own PHONOGRAPH,

It's Easy With Our Help

A few hours interesting work saves many dollars and gives you a machine exactly to suit your ideals. We furnish motors, tone arms, case material, blue prints and full instructions. Plays any record. You can make fine profit building phonographs for your friends.

Write Today for Our Free Blue Print Offer. Agents wanted for our ready built Choraleons.

CHORALEON CO.
701 Meager Bldg., Elkhart, Ind.



SAVE OVER HALF

"Electrical Worker's Friend"

An electrical book of 66 motor drawings with complete instructions for rewinding and reconnecting.

PRICE, ONLY \$3.50
Write for full particulars

J. SMITH & SON
1524 Lowrie Street, N. S. Pittsburgh, Pa.

THE ORACLE.

(Continued from page 648)

pores of the skin, also from the lungs, this slight difference would occur immediately. But in two or three hours, due to the foregoing causes, also digestion, the weight will gradually decrease to normal.

Dr. William Benham Snow, of New York one of the leading American electro-therapists and medical men, states: The increase of weight in the human being after eating, say, one pound of meat varies greatly. In some instances there is no increase at all; while in others there is a slight (but never the full weight) increase, all depending upon the individual's respiratory and digestive organs. In the case of water, the full weight of the water is added to the person's weight, but within a very short time after the weight will rapidly decrease to normal.

It has been a widespread and popular idea that if a person were to lie on his back and hold his breath that he could be lifted with two fingers. This has been done by hypnotism, but not otherwise.

ELECTROLYTIC RECTIFIER.

(978) H. H. Mosehauer, Wortendyke, N. J., writes:

Q. 1. I have made a small Electrolytic Rectifier for charging storage batteries. This rectifier was built from instructions in the Scientific American Supplement No. 1644. According to the instructions, the liquid consists of one pound of crystallized sodium orthophosphate (per jar).

I am having great trouble getting this chemical. Some drug houses I have been to do not seem to know what it is at all. Could you advise me where I can get it? Or what other chemical I could use instead?

A. 1. Relative to your electrolytic rectifier, would advise that the majority of these rectifiers, even the larger sizes, are operated with a solution composed of sodium bicarbonat (baking soda) dissolved in water until the solution is saturated, i. e., until the water will not absorb any more of the bicarbonat. Another very good solution is composed of water in which there is mixed ammonium phosphate. A saturated solution of this is also employed.

The matter of the solution used is not a very important one, it being more important that a good, pure grade of aluminum is employed. Ordinary salt and water has been used in electrolytic rectifiers in emergency for that matter, and also wherever a solution seems to have too high a resistance or where a sufficient current is not obtained, a few drops of sulfuric acid may be added to the water to make it more conductive. If you have further trouble in getting the rectifier to operate, it is well to note that the aluminum plates have to be "formed" and this has sometimes to be accomplished by running the rectifier for five or ten minutes or so connected to a lamp bank so that this or similar resistances on the D. C. side can pass a fairly strong current thru the rectifier, and cause the necessary oxid to form on the aluminum electrodes.

2 K.W. "PIPE THAWING" TRANSFORMER.

(979) Mr. Wm. E. Newton, Ontario, Canada, writes the "Oracle" Dept.:

Q. 1. I would like to make a transformer for thawing 1/2-inch frozen water pipes and want a secondary current of 150 amperes at 10 or 12 volts, as I would only need to thaw about 10 or 12 feet at a time. The primary winding is to be supplied by 110 volts, 25 cycle alternating current. I have plenty of soft stove pipe iron at hand from which I could make the core, which, I

suppose, would be of the closed core type. Please give dimensions of core, size, number of turns, and weight of wire required for primary. What kind, size, number of turns of wire required for secondary?

A. 1. We give below data for constructing the transformer in question:

Data for 2 K. W. 150 amp. 13.3 volt secondary "pipe thawing" transformer, for operation on 110 volt, 25 to 30 cycle A. C.

Core Data:—The sheet iron core should measure about 17 1/2 inches in length by 8 3/4 inches in width outside dimensions, its thickness and breadth should be 3 inches, or, in other words, 3 inches square. Both of the longer legs of the core should be thoroly insulated with five to six layers of oiled linen or Empire cloth, well shellacked.

Primary Winding:—This may consist of 244 turns of No. 9 B. & S. gage D. C. C. copper magnet wire wound in even layers on one of the long legs of the core. This will require about 2 pounds.

Secondary Winding:—The secondary coil to deliver 150 Amp. and 13.3 volts at full load may comprise 31 turns of No. 0, B. & S. gage D. C. C. copper magnet wire, or if this is not convenient, owing to its large size, you may wind on simultaneously two No. 3 B. & S. gage D. C. C. conductors side by side, or four No. 6 B. & S. gage D. C. C. conductors. The terminals of the separate wires, if a multiple winding is used, are joined together so as to connect all the wires on parallel.

The efficiency of this size of transformer is about 95 per cent with respect to the watts input at the primary and the watts output at the secondary

Knowing the size of the core you can readily compute the weight of wire for the windings by consulting any wire table. The circular mils area of the No. 9 B. & S. gage wire is 13,594 c.m., while the circular mils. area of the No. 0 B. & S. gage conductor is 105,592 c.m.

A NEW TOGGLE SWITCH.

The toggle surface switch illustrated differs from the ordinary snap switch in that manipulation is by the throw of a lever or toggle, instead of by the turning of a



Showing Interior View of Single Pole Switch.



Appearance of New Toggle Switch.

key or button. Throwing the lever up makes the circuit; throwing it down breaks the circuit. The movement is positive—the make-and-break quick and snappy. The toggle switch has been used in Europe for a number of years, but was slow to find favor in America.

The advantages of the toggle movement in a surface switch are stated as three-fold—first, it permits making the switch more attractive and stronger than the ordinary switch; second, manipulation is much more convenient by means of the lever than by the turning of a key; third, the switch is self-indicating, the position of the lever showing at a glance whether the current is "on" or "off" without any marker or dial.

It combines in unusual degree the best mechanical and electrical features, with an appearance which makes quick appeal to those seeking the dignity of simplicity and richness.

RADIO-TELEPHONE GUIDED U. S. FLYERS MANY MILES AWAY.

(Continued from page 629)

require amplifying more than from ten to fifteen times.

Fig. 3 shows a new form of oxid filament tubular audion as supplied on U. S. Army and Navy sets. This bulb is provided with a special base, making it very convenient for attachment or replacement, and tests made with this bulb show the life to be about five thousand hours.

Fig. 4 shows an improved form of audion control panel. A number of new radio engineering features are incorporated in this apparatus, including deeply grooved, insulating terminal blocks which carry the binding posts. Integrating condenser switches are employed for regulating the capacity of the bridge and stopping condensers. The ammeter at the right of the panel indicates the filament current at all times. A special form of grafito potentiometer is mounted just below the filament

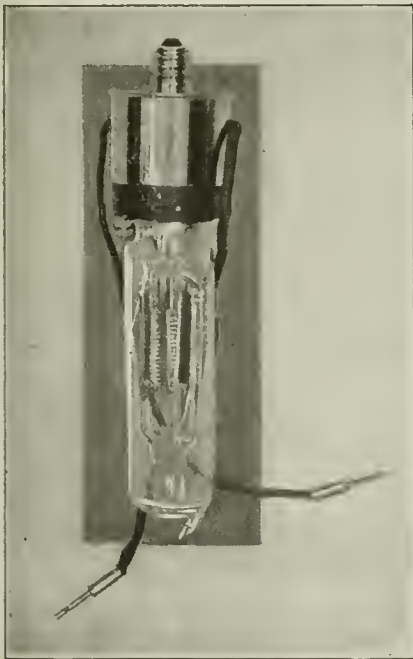
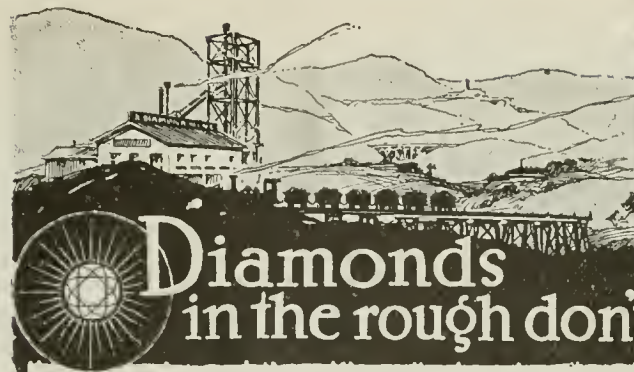

Fig. 3. New Form of Oxid Filament Audion as Supplied on U. S. Army and Navy Radio Sets.

ammeter to regulate the wing current.

Fig. 5 shows a large capacity oscillion bulb and control instruments mounted on a self-supporting panel for radio-telegraphic transmission. The bulb is mounted between upper and lower rings of heavy, rubber-covered wire. The loading coil switch for varying the antenna wave length is mounted in the upper left hand corner of the panel. Terminals for the Morse telegraph key are fitted at the bottom of the panel. A radiation hot-wire ammeter is seen at the left of the switchboard, while a three-pole switch controlling the filament and wing current appears at the right. The necessary condensers and auxiliary apparatus are compactly mounted on the back of the panel.

A 1/2 K. W. oscillion is good for 150 miles radiophone transmission over water, or 250 miles radio-telegraph signaling over water. A 1 K. W. outfit has a range of 200 miles radiophone or 300 miles radio-telegraph over water. A 2 K. W. will talk 300 miles or telegraph 400 miles over water. These ranges can be greatly increased by the use of two to six stage audion amplifiers. The six stage audion amplifier has an amplifying factor of one million times.



Diamonds in the rough don't sparkle

WITHOUT training you are a diamond in the rough. You can't make the most of your natural ability. Your real value is hidden—always will be until you cut away the rough spots and polish up with practical training. That's all you have to do to put yourself in the position where you want to be—and where you rightly belong. There is no secret to success. It is just a question of mentally equipping yourself with practical training. You have the same chance as the "other fellow"—if you train. What are you going to do?

Why Not Get a Better Job?

What would it mean to you if your salary was doubled tomorrow? What would \$5.00, \$10.00 or \$20.00 more a week enable you to do? It would mean a whole lot more pleasure in life—a lot more satisfaction, wouldn't it. Then why not get it? You can! It is not impossible or even a hard task. It is simply a matter of fitting yourself for the position and pay you want. Only by

training can you capitalize on your natural ability. If you can get what you are now earning without training, think what you could make with it. You have a lifetime of work ahead of you—so why not put in your time in congenial, profitable work. Thousands of American School Students will tell you it pays to train. Let us send you some proof of what our training has done for others,

Wonderful Opportunities Await Trained Workers

If you are untrained, take a look into the future. Now that the war is won, there is a period of reconstruction coming which will mean unparalleled opportunity for men who can think and act for themselves—trained men. The war-torn countries of Europe must be reconstructed and America must do its

share. America must also catch up with time lost in its own industrial activities. If you want to share in the prosperous times ahead you can do it. Get busy—now—and fit yourself with practical instruction that is guaranteed to satisfy you, and, therefore, guaranteed to make you make good.

Do Yourself a Favor

Make up your mind today to fit yourself for a more congenial position and bigger pay. You can do this—easy—if you will devote a part of your spare time to study. Keep on earning while you're learning. Check and mail the Coupon for Big Free Bulletin and details of Money-Back Guarantee.

TRAINING IS THE KEY TO SUCCESS
 PLEASE SEND ME BOOKLET AND TELL ME HOW I CAN FIT MYSELF FOR THE POSITION MARKED X **ASC**

-High School Graduate
-Electrical Engineer
-Elec. Light & Power Supt.
-Hydroelectric Engineer
-Telephone Engineer
-Telegraph Engineer
-Wireless Operator
-Architect
-Building Contractor
-Civil Engineer
-Structural Engineer
-Mechanical Engineer
-Shop Superintendent
-Steam Engineer
-Draftsman and Designer
-Lawyer
-Business Manager
-Certified Public Accountant
-Accountant and Auditor
-Bookkeeper
-Stenographer
-Fire Insurance Expert
-Sanitary Engineer
-Master Plumber
-Heating and Vent. Engineer
-Automobile Engineer
-Automobile Repairman
-Airplane Mechanic
-General Education Course
-Common School Branches



American School of Correspondence
 Dept. G-7441
 Chicago, U. S. A.

Name

Address

WHY DON'T YOU GET AN AUTO-WHEEL?

FELLOWS who know will tell you that the Auto-Wheel Coaster and the Auto-Wheel Convertible Roadster are the best wagons ever built for speed and strength. Wheels have roller bearings, steel axles and tires, and the spokes are oval, like an auto.

Send For Free Felt Pennant

Write us names of three coaster wagon dealers and we'll send you a beautiful Felt Pennant FREE. We will also tell you how to organize a Coaster Club. It's great fun. Each member receives a cap and the captain a special cap. Write today.

BUFFALO SLED COMPANY

163 Schenck Street - N. Tonawanda, N. Y.
(In Canada: Preston, Ont.)

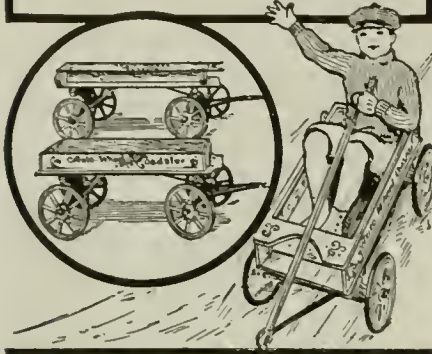

BOYS Build and Fly Your Own Training Plane



Train yourself in Aviation. Be an Amateur Aviator with an Aeroplane of your own. Learn how Aeroplanes are built; learn the principles of construction, operation and control. We sell IDEAL Accurate Scale Drawings, and Building and Flying Instructions which show you how to build a perfect Model Aeroplane, 3 ft. size, that will rise from the ground by its own power and fly like a big one. Send now for the Drawings and Instructions for the one you want to build.

- Drawings and Instructions for Curtiss Military Tractor
- Bleriot Monoplane
- Hauptort Monoplane
- Tauba Monoplane
- Curtiss Flying Boat
- Wright Biplane
- Cecil Peall Race

25c EACH

New Aeroplane Catalog 5 cents—None Free
Tells about Model Aeroplanes, Racing Aeroplanes, Flying Toys, and parts and supplies to build them with 48 pages. Sent only upon receipt of 10 cents.
IDEAL AEROPLANE & SUPPLY COMPANY
76-82 West Broadway New York City

CHEAPEST WAY TO GO

is on a bicycle—a dozen miles for a cent. That's why in Europe one every six persons rides a bicycle. All armies use them by thousands. It is the workman's street car, with the cost of the rides saved. A complete outdoor gymnasium that keeps you fit in mind and muscle.

Mead's Factory to Rider
Sales Plan Saves you \$10 to \$20 on all latest war approved Ranger models.
30 Days Free Trial and Free Delivery.

TIRES Parts, Repairs at half usual prices. Don't buy until you get our Big Free Catalog describing all the wonderful new offers, liberal terms and low prices. Write a postal now.

MEAD CYCLE COMPANY
Department C-17 CHICAGO

15 PHONOGRAPH RECORDS \$1
ALL GOOD TITLES

Sent PARCEL POST PREPAID anywhere in the United States. Enclose Money Order or Currency.
INDEPENDENT DRUG CO.
Dept. 100 204 S. Wabash Ave., Chicago

SALT FROM THE SEA BY ELECTRICITY.

A company is about to start the exploitation on a large scale of a method for extracting salt from sea water. The undertaking is being backed up by a number of men of exceptional standing. The process is due to Professor Helland Hansen, and the venture is backed by \$5,000,000. It will in all probability be found expedient to erect several works along the coast of Norway as more electric energy becomes available. The comparatively large capital is principally necessary on account of the large plant needed, pumping stations, etc., absorbing the bulk of the power; the production of the salt itself only requires a small amount of energy and is consequently cheap. As to the location of the new factories, no definite decision has been arrived at, but Stavanger has been mentioned as a likely place for the first factory, and the Gjaamfjord for the second.

A MELODIOUS PHONOGRAPHIC REPRODUCER.

By Frank C. Perkins.

The accompanying illustrations show the details of construction of a new phonographic reproducer, developed at Milwaukee, Wis., which it is said "Humanizes a Talking Machine". It is claimed that this reproducer plays perfectly all disc record selections, even the subtle tones of the instrumental accompaniments and prevents

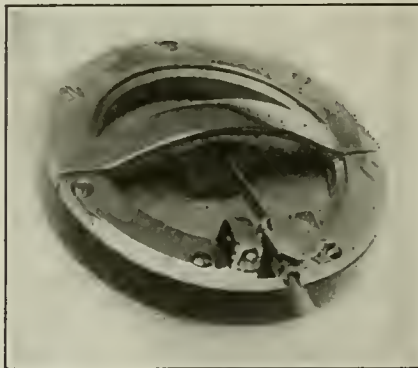

Something New in Phonograph Reproducers. This Particular Type Has a Diaphragm of Special Composition, and the Stylus Arm is Secured Thru a Bridge Arrangement, Similar to the Sounding Board of a Guitar. It is Said to Give Excellent Reproduction.

clash and approaches the living voice, whether of soprano, contralto, tenor, baritone or bass, quite as natural as life. Even the resonance of the violin and the tone of the flute are marvelously perfect.

It is held that band records are reproduced with all the tone values of instruments, every overtone and undertone brought out harmoniously, without nerve-wrecking stridency, while orchestral combinations are greatly improved. The recordings of the great symphonies are revived with all the original sublimity; re-animated in just the right volume for home enjoyment. The violins, cellos, oboes, clarinets, bassoons, saxophones, flutes, piccolos, horns, the "brasses" including the great tuba, the "percussion" containing drums, cymbals, bells, special effects as the imitations of birds, church chimes, are all as real as the record is made.

Any talking machine can be equipt with this reproducer in a moment, without tools. Either steel or fiber needles will work perfectly with the reproducer, whose weight is less than four ounces, so that records wear indefinitely if care is used.

BOOK REVIEW

EXPERIMENTAL STUDIES IN ELECTRICITY AND MAGNETISM, by Prof. Francis E. Nipher. Publish by P. Blakiston's Son & Co., Philadelphia, Pa. 72 Pages, size 9 1/2 x 6 3/8 inches, illustrated, cloth bound. Price \$1.25.

The student of electricity and magnetism will find many novel, new and decidedly interesting experiments described in this work. The author is well known in scientific circles and of very high standing. Furthermore, what he has to say to us in this presentation is of more than ordinary interest. Some very interesting photographs of sparks and spark shadows are given with some new theories as to their meaning; causes of local magnetic storms; the effect of "wind" on magnetism; and also the effect of "clouds" on the magnetic needle. These effects are indeed wonderful, and so new as to demand the attention of every earnest electrical student. Professor Nipher has performed some very interesting experiments in the laboratory and also in the field along these lines, and if you wish to read something refreshingly new in the realm of experimental electricity and magnetism, then you should by all means study this excellent and clearly written explanation of these little known scientific phenomena.

ALTERNATING CURRENT: THEORY, PRACTISE AND DIAGRAMS, by Horstmann and Tousley. Cloth covers, 296 pages, 173 illustrations, size 6 1/2 x 4 1/2 inches. Price \$1.00. Publish by Frederick J. Drake & Company, Chicago, Ill.

One of the well-known Horstmann and Tousley practical handbooks for electrical men, giving the theory and practice of this branch of electrical engineering so that the non-mathematical student can learn the exact meaning of the various terms used. The work starts with the generation of alternating currents and discusses inductance, capacity and resistance and their effect on the voltage and current in alternating current circuits. Next we find an interesting discussion on impedance, wattless current, and skin effect.

Other interesting chapters treat on the calculation of power in A. C. circuits; transformers; the theory and construction of transformers and how they are connected in lighting and distribution circuits; alternating-current generators, their theory and construction; A. C. motors, including the synchronous motor and its characteristics; synchronous converters, their theoretical and practical operation; the split-pole and also inverted converters; A. C. to D. C. rectifiers of various types; including electrolytic and vibrating rectifiers; potential regulators; measuring instruments for A. C. work, including synchroscopes and power-factor meters, with numerous tables for the calculation of A. C. circuits for different frequencies and voltages. A clearly written handbook which explains in untechnical terms the principles and practise of alternating currents for the practical electrician and student.

GERMAN ENVOYS TOLD TO SURRENDER, VIA RADIO.

A wireless message sent to the German delegates from German headquarters authorized them to sign the armistice.

The German commissioners remained up all night waiting for final instructions. When the radio message arrived they hastened to a private train in which Marshal Foch was living, and which formed his headquarters. Marshal Foch was asleep at the time. He was aroused. He received formal word that the Germans had come to sign.

The first to affix his signature to the momentous document was Dr. Mathias Erzberger, civilian head of the commission. The other delegates followed.

As they signed, one by one, they saluted, Marshal Foch and his aide-de-camp responding courteously.

In the meantime, across the network of wires running from Marshal Foch's headquarters to the various battlefields, the order for cessation of hostilities at 11 o'clock, Nov. 11th, began to be flashed up and down the far-flung western front, while from Paris and London the news started on its joyous trip around the world.

**7 Big Volumes
7 Cents a Day
Shipped for
Examination
FREE**



Greatest Electrical Books Now Brought to Your Home!

Partial Contents

Vol. I. Elements of Electricity: Magnets -- Electromagnets. The Electric Current: Resistance--Underwriters Requirements -- Power Stations and Equipments -- Outside Wiring--High Tension--Special Installations--*Electrical Measurements:* Instruments--Measuring Methods: Resistance Insulation -- Distribution Systems -- Watt -- Hour Meters: Construction, Installation, Testing.

Vol. II. Dynamo Electric Machinery: Magneto Electric Induction -- Generators -- Construction--Practical Design, Types of Generators and Motors: Direct and Alternating Generators and Motors. Motor Generators--Induction Motors.

Vol. III. Direct Current Motors: Efficiency--Torque--Speed--Power--Multi-Voltage Systems, Management of Dynamos and Motors: D. C. and A. C. Plants--Lighting: Incandescent Lamps--Tungsten Lamps -- Nitrogen Filled and Mercury Vapor -- Arc Lamps -- Residence -- Photometry.

Vol. IV. Alternating Current Machinery: Simple Alternator--Instruments -- Polyphase Systems -- Armature Windings--Transformers -- Rectifiers--Motor Generators.

Vol. V. Power Transmission: Conductors--Distributing Systems--Voltage Regulation -- Underground Construction -- Electric Railways: Car Equipment--Maintenance--Power Plants--Signal Systems.

Vol. VI. Power Stations: Plant Location-- Electrical Equipment -- Switchboards: Wiring Diagrams of ratings, Storage Batteries: Types--Charging and Discharging--Troubles and Remedies -- Small Battery Installations. *Applied Electrochemistry:* Metal Refining and Plating--Chemicals-- Electric Furnaces--High Tension Work.

Vol. VII. Modern Land Telegraphy: Wireless Telegraphy and Telephony, Electric Elevators Electric Heating, Welding.

Note:---This is but a partial list of contents. The set contains every electrical subject known!

7 Big Volumes—Written by 27 Great Authorities—Yours for 7 Cents a Day

THE hardest way to learn Electricity is through your own experience. The easiest way to learn is through the experience that others have paid for in time and money. Here in practical, easy-to-understand form, you get the benefit of what 27 greatest electrical authorities in America and all over the world have learned, and you get this vast fund of experience in convenient book form, so that you can read and study in your own home in your spare time.

This is the greatest opportunity of your life to become an electrical engineer, sub-station operator, dynamo tender, or to get any one of the other big-pay jobs in the electrical field. For less than you spend for tobacco or movies, you can train yourself to step up to the jobs paying \$2,500 to \$5,000 a year.

Shipped on Free Examination **No Money in Advance**

Just glance at the partial list of contents of these 7 volumes in the panel at the left. Think how much there is for you in this great home-study library of electricity. Then write at once for the books themselves. Examine them in your own home for a week. Send them back if you are not satisfied. But if you decide to own this pay-raising set, send only \$2 and then only \$2 a month until the special half price is paid. Examine the books—see how they take you through every detail of each special branch of electricity. See how they give you all the necessary tables and formulas in simple, untechnical form. Note the frequent test questions which enable you to examine yourself. Note the 2,600 illustrations, full page plates, diagrams, etc. You be the judge of their value to you!

HALF PRICE—NOW

For a limited time we are offering this remarkable self instructor Electrical library at half price. Regular price \$35—special price \$19.80 on easy terms of only 7 cents a day. With each set we include a year's Consulting Service Membership free—worth \$12. The 7 volumes contain 3,000 pages, each 7 x 10 inches, bound in American Morocco, Gold Stamped.

Mail Coupon—Send No Money

If you are interested in electricity you need these books. You will prize them for the new, up-to-date information they give you on every phase of electrical work. We ship the 7 volumes right to your home on your simple request. Send no money until you are satisfied after 7 days free examination. Put your name and address on the coupon now and send at once before this offer is withdrawn.

AMERICAN TECHNICAL SOCIETY
Dept. E3381, Chicago, U. S. A.

Mail This Coupon Now

AMERICAN TECHNICAL SOCIETY
Dept. E3381, Chicago, U. S. A.

Please send Cyclopedia of Applied Electricity for seven days' examination, I to pay shipping charges. I will send \$2 within seven days and \$2 a month until I have paid \$19.80 or notify you and hold the books subject to your order. Title not to pass until fully paid.

Name

Address

Reference

AMATEURS! Get Ready for the Opening Day

Practical Wireless Telegraphy

By Elmer E. Bucher,
Director of Instruction Marconi Institute
The recognized standard wireless text book. Treats each topic separately and completely, and furnishes a progressive study from first principles to expert practice. Covers completely the entire field of wireless (fundamentals, construction and practical operation). More than 50,000 copies of this book have already been sold. Size 6 x 9 inches. 352 pages, 340 illustrations. Handsomely bound in full cloth with cover stamping in gold and black. Price, \$1.75 postpaid.

Radio Telephony

By Alfred N. Goldsmith, Ph.D.
Director of Radio Laboratory, College of the City of New York
Written in clear style to appeal to even the beginner. Treats all aspects of Radio Telephony including a description of Radio Telephony in practice for a distance of more than five thousand miles. Covers the subject of construction and operation thoroughly and will be found an invaluable aid to men who seek to improve their position in the wireless profession. Size 6 x 9 inches. 258 pages, 228 illustrations. Handsomely bound in full cloth stamped in gold. Price, \$2.00 postpaid.

These Text Books Have Been Used in Training Over 60,000 Men During the Past Year

THE WIRELESS AGE

The only American magazine devoted exclusively to the wireless art. Records all developments in the scientific, experimental and commercial fields. A magazine that keeps you posted on all the latest doings and gives you a broader working knowledge of the art of wireless than possible through any other sources. Live, up-to-date and newsy feature articles with vivid illustrations and practical suggestions for red-blooded Americans. Practical training courses by experts on wireless telegraphy, aviation, military signaling, etc., in each issue. Go to the nearest news-stand and secure your copy, or, we will mail postpaid upon receipt of price. 20c per copy, \$2.00 per year.

SPECIAL OFFER The Wireless Age for one year and your choice of Practical Wireless Telegraphy, Vacuum Tubes or Practical Aviation for \$2.75 or Radio Telephony for \$3.00. Save money and subscribe now.

THE WIRELESS PRESS, Inc.

33 ELM STREET
NEW YORK CITY

Attractive circular fully describing our complete line of books, sent free upon request. Ask for Circular E.

Complete text books written by leading experts. Up-to-date, describing all 1918 apparatus and practices. These books furnish all information required to enter the wireless and aviation services. Written to prepare you for active service in the shortest possible time. In use at all army and navy schools and camps, universities, colleges and technical schools. Each book is a practical home study course covering the entire subject and giving information not to be found in any other sources.

Vacuum Tubes in Wireless Communications

By Elmer E. Bucher
An elementary text book for experimenters, students and operators. Gives complete description and makes clear every fundamental operating principle of the vacuum tube. Graphic diagrams reveal at a glance the various uses of the vacuum tube. The only text book on the market devoted solely to the various applications of the oscillation valve. Shows over one hundred different circuits. Size 6 x 9 inches; 130 diagrams and illustrations. Handsomely bound in cloth. Price, \$1.75 postpaid.

Practical Aviation

Including Construction and Operation
By J. Andrew White
An invaluable book for intensive study by men preparing to become aviators. Gives the complete working knowledge required for actual flying and air combat. The subjects covered include operation and care of aviation engines, reconnaissance, map reading, signaling and operation with military bodies, radio and its uses, meteorology, and night flying. Size 6 x 9 inches; hundreds of illustrations. Bound in full cloth. Price \$1.75 postpaid.

WINTERTIME USES FOR THE ELECTRIC FAN.

(Continued from page 619)

be screwed down so as not to fall over and injure anyone.

Another illustration shows a very effective aid in the drying of milady's silk stockings, gloves and handkerchiefs. A funnel "B" can be easily constructed out of ordinary cardboard to fit the protective guard, and attached with wire. Or, it can be made a bit larger so as to slip a few inches over the protector, perforated at two or four places and tied at the back with string. Of course the width of the other end should be much narrower in order to produce the conical shape, as the sketch illustrates. A small piece of cardboard formed into a cylinder, and sewn or pasted together so as to exactly fit the end of the cone, is also fastened to it with wire. This is done by perforating both and sewing the wire from one hole to the other. The stocking is then slipped on and can be clamped down. (The clamps that are used on jam jars to make them air-tight would serve very nicely here.) Also small hooks made of wire (picture wire would do), invisible hairpins, etc., can be affixed to the end of the funnel, on which handkerchiefs, stockings and gloves can be fastened. In the latter case it is not necessary to make the small cardboard attachment. It is readily

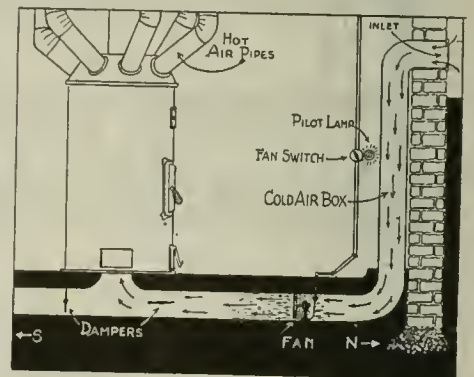

To Improve the Cold Air Box Draft To Your Furnace, Install An Electric Fan in the Draft Passage After the Manner Illustrated. A "North" and "South" Cold Air Box, Fitted With Suitable Cut-Off Dampers, Makes a Very Dependable Furnace, No Matter Which Way the Wind Blows.

understood that the forced air thru this funnel dries the articles in no time. Should it be inconvenient for you to make this funnel, the handkerchiefs, stockings, et cetera, can be attached to the protector itself by pins or hairpins. With this method it will take slightly longer for them to dry. Care should be taken to attach the articles before you set the fan going. Take them off after you have cut off the current with the snap switch and the fan has fully stopt. This precaution should be taken whenever the electric fan is handled in any way.

Figure "B" shows a handy device that can quickly be affixed to or taken off the guard. A circle of tin is cut in the manner illustrated, allowance being made for small projections which are bent over and formed into hooks. It can be affixed to the protector guard with the projecting tabs. If the tin is not handy, cardboard will do just as well, except that the hooks must be made of wire or old hairpins. A good way to make these hooks is to thrust the hairpin thru the perforation, the two ends first, twisting them around at the other side of the perforation and then spreading them apart. About four cardboard tubes are inserted and sewn with wire as aforementioned to a piece of cardboard large enough to fit the wire cage pro-

The House of Taylor



HOTEL MARTINIQUE

BROADWAY, 33D STREET, NEW YORK
One Block from Pennsylvania Station.

Equally Convenient for
Amusements, Shopping or Business

157 Pleasant Rooms, with Private Bath,
\$2.50 PER DAY.

257 Excellent Rooms, with Private Bath,
facing street, southern exposure,
\$3.00 PER DAY.

Also Attractive Rooms from \$1.50.
The Restaurant Prices Are Most Moderate.

400 Baths
600 Rooms

"THERE'S MONEY IN IT"

AT HOME LEARN TELEGRAPHY AT HOME MORSE AND WIRELESS

TEACH YOURSELF

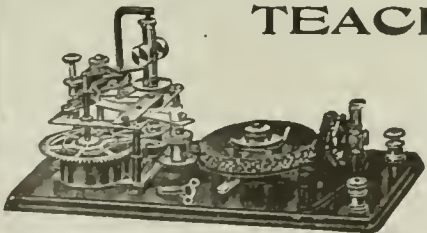

In half the usual time, at trifling cost, with the wonderful Automatic Transmitter, THE OMNIGRAPH, Sends unlimited Morse or Continental messages, at any speed, just as an expert operator would.

Adopted by U. S. Gov't. 4 styles. Catalogue free.

OMNIGRAPH MFG. CO.
39L Cortlandt St. New York



Monuments—Mausoleums—Statuary

No matter what your needs, we can serve you most advantageously. Estimates and designs submitted. Mail orders as carefully executed as though you had called in person. Write for particulars.

J. L. Wegenaar Co., 299A B'way, N. Y.
SPECIALISTS IN DESIGN AND CONSTRUCTION

You benefit by mentioning the "Electrical Experimenter" when writing to advertisers.

lector or guard, to which it is in turn fastened. The use of hooks or rubber bands is also made here in securing the articles to the tubes.

Another use to which the electric fan can be put is the drying of photo negatives. The draft of air from the fan causes the water on the negative to evaporate, so that they will dry much sooner than under the ordinary process, which is to spread them on racks and allow them to dry by themselves. It proves of great help to the amateur as well as the commercial photographer, who particularly should make use of this method when business is rushed, or certain pictures are in special demand.

Nothing, perhaps, is more exasperating than to enter a public telephone booth and having to breathe the suffocating air, which is many times laden with the odor of stale tobacco. The electric fan might well be employed in all such instances.

Have you ever tried to look thru the window of a bakery or lunch room covered with frost, and dimly make out a few of the many delicacies therein? After the windows have been cleaned till they shine like mirrors, and a great deal of effort been expended to make the articles for sale most appealing, along comes Jack Frost and spoils it all. Some store-keepers have tried filling the window with warm air, but this is rather bothersome and expensive, as the cold window-pane cools it and a fresh supply of warm air must be employed. The most effective, least troublesome, and in the end the cheapest way, is—the electric fan. It circulates the air evenly, thus keeping a fixt temperature, with the result that no frost will form on the window.

One of the accompanying illustrations shows a very good use for an electric fan in the wintertime to help out the cold air circulating system to hot-air and other furnaces. This suggestion was made by one of the Westinghouse engineers, and the sketch shows clearly how the fan is placed directly in the cold air duct. The fan may be placed anywhere in the duct, its function being to create a very strong draft or suction so as to act firstly as a forced draft for the furnace, and also to draw in a sufficient quantity of fresh air at all times thru the inlet in the cellar wall. Especially is this suggestion of value when the wind or air currents blow from the opposite side of the house in which the cold air intake is situated. In wiring up and installing such a fan arrangement, it is best to connect a small 4 c.p. pilot lamp on the motor side of the switch as a reminder to the furnace tender that the fan is operating, for it is not necessary to keep it going except at certain intervals, as for instance when a house is very cold or when the wind is blowing on the opposite side of the house.

A very good idea in this direction is to provide a two-way cold air box; one inlet being located in the north wall and the other in the south wall of the house. Suitable dampers should be used of course to cut off one or the other as the case may be, so that when the wind blows from the north, as the arrows show, then cold air can be taken from this inlet; while when the wind blows from the south, the cold air intake from that direction can be utilized by closing the north damper and opening the south damper. Great care must be taken in every instance to keep the cold air duct thoroly air-tight thruout its entire length, and it is often best to have a plumber or furnace man install the fan if you are not familiar with the work, as you may easily leave openings in the duct, thus creating a false draft and losing as much or more than what you at first set out to gain. Hot-air furnaces are widely used, but in some cases do not operate satisfactorily for sev-

How it Feels to Earn \$1000 a Week

By a Young Man Who Four Years Ago Drew a \$25 a Week Salary. Tells How He Accomplished It.

How does it feel to earn \$1000 a week? How does it feel to have earned \$200,000 in four years? How does it feel to be free from money worries? How does it feel to have everything one can want? These are questions I shall answer for the benefit of my reader out of my own personal experience. And I shall try to explain, simply and clearly the secret of what my friends call my phenomenal success.

Let me begin four years ago. At that time my wife and I and our two babies were living on my earnings of twenty-five dollars a week. We occupied a tiny flat, wore the simplest clothes, had to be satisfied with the cheapest entertainment—and dreamed sweet dreams of the time when I should be earning fifty dollars a week. That was the limit of my ambition. Indeed, it seemed to be the limit of my possibilities. For I was but an average man, without influential friends, without a liberal education, without a dominating personality, and without money.

With nothing to begin with, I have become the sole owner of a business which has paid me over \$200,000 in clear profits during the past four years and which now pays me more than a thousand dollars a week. I did not gamble. I did not make my money in Wall Street. My business is not a war baby—on the contrary, many others in my line have failed since the war began.

In four years, the entire scheme of my life has changed. Instead of living in a two by four flat, we occupy our own home, built for us at a cost of over \$60,000. We have three automobiles. Our children go to private schools. We have everything we want, and we want the best of everything. Instead of dreaming of fifty dollars a week I am dreaming in terms of a million dollars—with greater possibilities of my dream coming true than my former dream of earning fifty dollars a week.

What brought about this remarkable change? What transformed me, almost overnight, from a slow-going, easily-satisfied, average man—into a positive, quick-acting, determined individual who admits no defeat, who overcomes every obstacle and who completely dominates every situation? It all began with a question my wife asked me one evening after reading an article in a magazine about a great engineer who was said to earn a \$50,000 salary.

"How do you suppose it feels to earn \$1000 a week?" she asked. And without thinking, I replied "I haven't the slightest idea, my dear, so the only way to find out is to *earn it*." We both laughed, and soon the question was apparently forgotten.

But that night, and for weeks afterward, the same question and my reply kept popping into my brain. I began to analyze the qualities of the successful men in our town. What is it that enables them to get everything they want? They are not better educated than I—indeed, some are far less intelligent. But they must have possessed some quality that I lacked. Perhaps it was their mental attitude; perhaps they look at things from an entirely different angle than I. Whatever it was, that "something" was the secret of their success. It was the one thing that placed them head and shoulders above me in money-earning ability. In all other ways we were the same.

Determined to find out what that vital spark of success was, I bought books on every subject that pertained to the mind. I followed one idea after another. But I didn't seem to get anywhere. Finally, when almost discouraged, I came across a copy of "Power of Will." Like a bolt out of a clear sky there flashed in my brain the secret I had been seeking. There was the real, fundamental principle of all success—Power of Will. There was the brain faculty I lacked, and which every successful man possesses.

"Power of Will" was written by Prof. Frank Channing Haddock, a scientist, whose name ranks with such leaders of thought as James Bergson and Royce. After twenty years of research and study, he had completed the most thorough and constructive study of will power ever made. I was astonished to read his statement that, "The will is just as susceptible of development as the muscles of the body!" And Dr. Haddock had actually set down the very rules, lessons and exercises by which anyone could develop the will, making it a bigger, stronger force each day, simply through an easy, progressive course of training.

It is almost needless to say that I at once began to practice the exercises formulated by Dr. Haddock. And I need not recount the extraordinary results that I obtained almost from the first day. Shortly after that, I took hold of a business that for twelve years had been losing money. I started with \$300 of borrowed capital. During my first

year I made \$30,000. My second year paid me \$50,000. My third year netted me \$70,000. Last year, due to increased costs of materials, my profits were only \$50,000, though my volume of business increased. New plans which I am forcing through, will bring my profits for the present fiscal year up to \$65,000.

Earning a thousand dollars a week makes me feel secure against want. It gives me the money with which to buy whatever will make my family happy. It enables me to take a chance on an investment that looks good, without worrying about losing the money. It frees my mind of financial worries. It has made me healthier, more contented, and keener minded. It is the greatest recipe I know for happiness.

Prof. Haddock's lessons, rules and exercises in will training have recently been compiled and published in book form by the Pelton Publishing Co., of Meriden, Conn. I am authorized to say that any reader who cares to examine the book may do so without sending any money in advance. In other words, if after five days' reading, you do not feel that the book is worth \$3, the sum asked, return it and you will owe nothing. When you receive your copy for examination I suggest that you first read the articles on the law of great thinking; how to develop analytical power; how to perfectly concentrate on any subject; how to guard against errors in thought; how to drive from the mind unwelcome thoughts; how to develop fearlessness; how to use the mind in sickness; how to acquire a dominating personality.

Never before have business men and women needed this help so badly as in these trying times. Hundreds of real and imaginary obstacles confront us every day, and only those who are masters of themselves and who hold their heads up, will succeed. "Power of Will" as never before, is an absolute necessity—an investment in self-culture which no one can afford to deny himself.

Some few doubters will scoff at the idea of will power being the fountainhead of wealth, position and everything we are striving for. But the great mass of intelligent men and women will at least investigate for themselves by sending for the book at the publisher's risk. I am sure that any book that has done for me—and for thousands of others—what "Power of Will" has done—is well worth investigating. It is interesting to note that among the 250,000 owners of "Power of Will" are such prominent men as Supreme Court Justice Parker; Wu Ting Fang, Ex-U. S. Chinese Ambassador; Lieut.-Gov. McKelvie, of Nebraska; Assistant Postmaster General Britt; General Manager Christeson, of Wells-Fargo Express Co.; E. St. Elmo Lewis; Governor Arthur Capper of Kansas, and thousands of others. In fact, today "Power of Will" is just as important and as necessary to a man's or woman's equipment for success, as a dictionary. To try to succeed without "Power of Will" is like trying to do business without a telephone.

As your first step in will training, I suggest immediate action in this matter before you. It is not even necessary to write a letter. Use the form below, if you prefer, addressing it to the Pelton Publishing Company, Wilcox Block, Meriden, Conn., and the book will come by return mail. This one act may mean the turning point of your life, as it has meant to me and to so many others.

The cost of paper, printing and binding has almost doubled during the past three years, in spite of which "Power of Will" has not been increased in price. The publisher feels that so great a work should be kept as low-priced as possible, but in view of the enormous increase in the cost of every manufacturing item, the present edition will be the last sold at the present price. The next edition will cost more. I urge you to send in the coupon now.

PELTON PUBLISHING COMPANY

30-A Wilcox Block, Meriden, Conn.

I will examine a copy of "Power of Will" at your risk. I agree to remit \$3 or remail the Book in 5 days.

Name

Address

City State

You benefit by mentioning the "Electrical Experimenter" when writing to advertisers.

The Gift of Gifts

FOR THOSE WHO
LOVE GOOD MUSIC



THE ELLIS "MUSIC MASTER" REPRODUCER

is the ideal Christmas gift for anyone who owns a phonograph or talking machine using disc records. This wonderful little reproducer bears the same relation to the reproduction of records as does Stradivarius to the making of violins. Both are masters.

There is as much difference in the effect of the Ellis Reproducer and ordinary reproducers, as there is between a genuine Stradivarius and a cheap factory made violin. As one user said: "Mr. Ellis, your reproducer is soulful and inspiring. The overtones are remarkable and wonderful, and the tone shading very beautiful."

Ordinary reproducers, such as are supplied with all phonographs or talking machines, give a harsh, rasping, annoying sound and reproduce the human voice with a disagreeable nasal twang. The Ellis Music Master makes every note and tone as clear as a bell—and reproduces it in its true tone coloring. It is a marvelous little instrument that will please anyone who appreciates and can comprehend the difference between good and indifferent rendition of music. It is truly a "Music Master."

The Ellis "Music Master" is made for all machines using disc records. It is lighter than ordinary reproducers, therefore preserves and prolongs the life of records. The cost is little, but the satisfaction great.

Write today for circular E, which gives full details.

J. H. ELLIS, P. O. Box 882, Milwaukee, Wis.

eral reasons. Among these are insufficient area of the cold air duct; furnace not located low enough in cellar bottom; or else hot air pipes rise at too low an angle. These should rise at a sharp angle, preferably not less than 45 degrees at the top of the furnace, and will always work better when kept close to this angle or approaching the vertical, than they will in the horizontal direction. In the majority of cases it is usually found that the wind blows from the north or some northerly direction more than any other. Therefore, where but one fan is available for this use, it should be installed in the north cold air box.

A large and airy but unfinished attic room in a building occupied by a school was suddenly needed in order to accommodate an extra class. It took only a few days to wire and plaster it but the time required for natural drying could not be spared and use of the common salamanders was inadvisable because of fire hazard. Three 16-inch electric fans were placed on boxes and turned so as to keep a continual circulation of air thruout the room. With windows open and the fans running for a day and night, the fresh plaster dried quickly so that carpenters and decorators could finish the room shortly.

2 MEN MILE APART BURNED BY SAME ELECTRIC FLASH.

Recently two men, R. C. Deyo and Henry Nisson, both in the employ of the San Joaquin (Cal.) Light and Power Company, were working on the top of telephone poles for the company, 50 miles apart, when an unaccountable and unknown current of 10,000 volts went flashing over the wires and gave each man such a shock that it is a miracle that they escaped instant death. Both men were similarly burned about the hands, both were rendered unconscious, and only restored to consciousness by extraordinary efforts. The men are now recovering from burned hands and the electric shock at the San Joaquin hospital.

Deyo was at work on the top of a telephone pole about twenty miles west of Bakersfield, Cal. He was busy on what the electricians call the 60-phone line, when a shock came to him. He fell to the ground, a distance of 25 feet.

When, after an hour, Deyo came to his senses, he was put in an automobile and hurried to the San Joaquin hospital in this city. Dr. N. J. Brown was called for attendance. Both of Deyo's hands are burned to a crisp at the palms, and he is suffering from hurts he received in his fall from the top of the telephone pole.

At the same moment Henry Nisson, aged 28 years, was engaged in exactly the same sort of work for the San Joaquin Light and Power Company at Pond. He, also, was at the top of a telephone pole, and he was served the same as Mr. Deyo. He fell unconscious, and his companion rushed to Dr. Copeland's office for help. His hurts are the same as Mr. Deyo's, only he has not the bruises by the fall.

GAS VERSUS ELECTRIC RANGE.

The gas range is little better than half as efficient as the electric range. Recent tests show that the top surface of the electric range requires but 64 per cent of the energy necessary to do the same work on the top surface of the gas range. The electric range oven requires but 23 per cent of the energy necessary for the same work in a gas range oven. The electric range oven is much more efficient in proportion than the top surface as compared with the oven and top surface of the gas range. Under actual household conditions the electric range requires about 55 per cent of the energy used by the gas range to do the same work.

Wireless Stations Will Shortly Re-open Date, only, uncertain

Heed Our Advice

ORDER NOW

As a matter of law Congress loses all control over wireless receiving stations and transmitting stations with a range within the borders of the state where located as soon as peace is declared. The Radio Inspector of this district has already asked our co-operation in printing in the next edition of our catalog the necessity of securing licenses for transmitting sets with a range beyond the borders of the state. No wireless manufacturer wants the stations to open tomorrow. They could not take care of the business. Order now and be prepared.

We have a big stock of wireless instruments.

No. 11 is our latest catalog. No new price list.

Please do not write for catalog if you have No. 11. Paper costs three times as much as formerly. Let the amateur without a catalog secure one. Write for prices in advance. Just now we have no price list, because the changes have been so frequent. Will advise through this magazine when revised price list is ready, which will be as quickly as possible.

Send 8c in coin or stamps today for our big 300 page No. 11 Electrical and Wireless Catalog. Any wireless amateur will tell you it is the one catalog to have. You need no others. Our catalog contains most everything in wireless worth while, and is a guarantee that the goods are dependable.

THE WILLIAM B. DUCK CO., 230-232 Superior St., Toledo, Ohio

He Learned
K. I. Shorthand
in 5 evenings
—You can!



A VAUGHN M. AMES, the young man in the picture, did it. So have legions of others. We guarantee you can learn the entire system in five evenings; then acquire speed, become proficient in a tenth of the time it would take you with any of the old, complex systems. K. I. Shorthand is the new simplified stenography that experts consider the most concise and most legible shorthand in the world. Learn by mail.

Why go through months of drudgery and spend ten times as much money learning some troublesome system? K. I. students are found in every walk of life—among doctors, lawyers, teachers, electricians, engineers, and business-men, as well as stenographers and secretaries. Used in army and navy, and acknowledged by progressive commercial schools as the most practical of shorthand systems.

30 Days Approval

K. I. Shorthand will be a big help to you in any vocation. You can afford to learn it because it is so easy and costs so little. Don't think K. I. Shorthand is meant only for stenographers. Learn this invaluable system so you can be more than a stenographer. It conserves your time, does your remembering for you. Hence promotes your efficiency and puts you in line for more rapid advancement. Valuable in your electrical or mechanical enterprises.

We teach you the entire course on approval for 30 days with the understanding that you need not pay one cent if you do not learn. Prove it for yourself by receiving two first lessons FREE.

More Than a Text Book!

Do not compare our system with offers of text books on stenography. We give you personal mail tuition. Experts guide you in acquiring proficiency and accuracy in the shortest time. Free Lessons, testimonials and complete information sent on request.

KING INSTITUTE, Inc. Station F, (EH-300), New York, N. Y., or 2 S. Wabash Av., (EH-300), Chicago, Ill.

You benefit by mentioning the "Electrical Experimenter" when writing to advertisers.

NIKOLA TESLA AND HIS INVENTIONS.

(Continued from page 615)

either a dreamer or, worse yet, crazy. The fact is the world does not understand you because you live in the next century. Moses was a great man, but the Bible teaches us that he was "heavy of tongue" and could not make himself understood. His brother therefore always spoke in his stead, announcing to his hearers what Moses had to say. Why not let the EXPERIMENTER be your brother? Why not let us translate your work into a language that the man in the street can readily understand? We have the knowledge and the technical training to do your inventions justice by means of graphic illustrations and wash drawings. The public does not want patent drawings or patent language. It wants pictures and plain English. You are a great inventor, but your 21st Century training prevents you from making yourself understood to a 20th Century public. My plan is to run one of your inventions every month, in plain English fully illustrated. That means that it will probably take over two years to deal with all of your more important inventions. At the end of this period the articles can be published in book form, a thing that does not exist at present. The plan is two-fold. First, the world at large will at last understand the highly important work you have accomplished and will fully recognize you. Second, it will be of greatest benefit to Science, to whom your inventions will then not be the sealed book they are today."

Knowing that Tesla had in the past continuously refused similar offers of dozens of great publishers of this country as well as abroad, I was not at all sanguine of my own plan. Great was my surprise therefore, that he not only gave his consent, but he actually agreed to prepare each article personally with the Editors' collaboration.

Dr. Tesla wants it expressly understood that he is undertaking this great work chiefly to educate the young generation. He felt that he could not possibly reach such a large electrically trained young manhood, save thru the medium of the ELECTRICAL EXPERIMENTER. With its circulation above 100,000, all enthusiastic experimenters, Tesla feels that his greatest mission in life, namely, to assist our rising generation, will come near fulfillment.

Nikola Tesla's articles will therefore run serially every month in the ELECTRICAL EXPERIMENTER. The articles will be entitled: "My Inventions"—by Nikola Tesla. Every article will be entirely original; each will be illustrated with our own new illustrations and with such wash drawings as made this journal so successful. The first article will appear in our February number.

We wish to congratulate EXPERIMENTER readers for having obtained for them probably the greatest technical news feature of a generation. I caution you: *Expect much!*

FARMERS AND ELECTRICITY.

Within the past three years the farmers of the United States have purchased one million automobiles and 100,000 tractors and innumerable pumping engines, and other devices run by electricity, according to widely published estimates. Farmers everywhere are rapidly advancing in the same direction, progress in labor-saving contrivances being phenomenal in this country. A motor does the churning; a motor runs the sewing machine and the washing

machine. The rural telephone is invading country districts at the rate of many miles per day, and all farm machinery is being operated by the aid of tractors, which now haul the wagon and work the hay loader in the hay field. Next year, it is said, reapers and mowers in great numbers will be drawn by tractors.

DEVICE FOR PROTECTING ELECTRIC MOTORS.

A motor protection system which, it is claimed, does away with the trouble and expense of cleaning motors, has been devised and marketed. The usual type of installation, it is pointed out, in working out this system consists of casings which enclose each end of the motor and make it dust proof. A fan is attached to the end of the motor shaft, a dust separator, and an air intake pipe running to a clean air supply out of doors. When the motor is started, the fan draws in the cool, fresh air thru the dust separator and forces it against the rear end of the motor, thru the windings and out thru the laminations. Part of the air is forced thru a by-pass to the front hood so that the same action takes place on both sides of the motor.

As a result, it is pointed out that the motor is kept clean and has a large volume of cool, clean air constantly passing thru it which carries away the heat as fast as generated. Motor casings are provided with

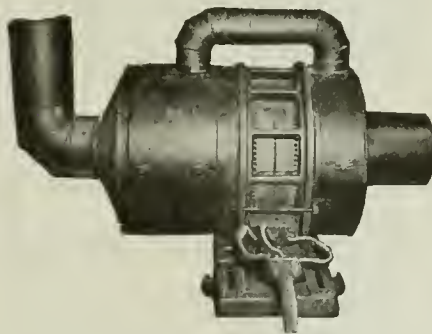

Forced Air Cooling Apparatus Shown Installed on a Motor.

large doors to permit of a ready inspection of brushes, resistance, air-gap, bearings, and the like. The dust separator is also provided with doors so that the screens can be readily removed. The equipment can be applied to motors without moving them and requires a short time to install. Besides reducing the temperature and increasing the efficiency, the maker points out that the protection provided allows the carrying of a large overload without shortening the life of the motor and eliminates fire hazards.

DANIELS TELLS OF FOE RADIOS SCOUTS FOUND.

A telegram from Secretary of the Navy Daniels received by the Boy Scouts of America characterized them as "chivalrous young crusaders" because of their work during the war. It also disclosed that the Scouts, working on behalf of the Government, had discovered hundreds of illegal wireless plants.

Twenty-six of these plants were found in one day. A German alien, operating an underground radio station with a small New England river supplying the motive power, was taken into custody and interned. This plant was said to have been exchanging German Government messages between America and Berlin. Details of these scout activities are expected to be made public later.



"I Can Succeed!"

"What other men have done with the help of the International Correspondence Schools, I can do. If the I. C. S. have raised the salaries of other men, they can raise mine. If they have helped others to advance, they can help me. To me, I. C. S. means 'I CAN SUCCEED.'"

Make up your mind right now that not another day shall pass until you have made your start toward success.

For 27 years men in offices, stores, shops, factories, mines, railroads, and in the Army and Navy have been winning promotion and increased salaries through the I. C. S. More than 100,000 men and women are getting ready right now with I. C. S. help for the bigger jobs ahead.

No matter where you live, the I. C. S. will come to you. No matter what your handicaps, or how small your means, we have a plan to meet your circumstances. No matter what career you may choose, some one of the 280 I. C. S. Courses will surely suit your needs.

When everything has been made easy for you—when one hour a day spent with the I. C. S. in the quiet of your own home will bring you a bigger income, more comforts, more pleasures, all that success means—can you let another single priceless hour of spare time go to waste? Make your start right now! This is all we ask: Without cost, without obligating yourself in any way, put it up to us to prove how we can help you. Just mark and mail this coupon.

INTERNATIONAL CORRESPONDENCE SCHOOLS
BOX 6170, SCRANTON, PA.

TEAR OUT HERE

- Explain, without obligating me, how I can qualify for the position, or in the subject, before which I mark X.
- | | |
|--|---|
| <input type="checkbox"/> ELECTRICAL ENGINEER | <input type="checkbox"/> SALESMANSHIP |
| <input type="checkbox"/> Electric Lighting and Wires | <input type="checkbox"/> ADVERTISING |
| <input type="checkbox"/> Electric Wiring | <input type="checkbox"/> Window Trimmer |
| <input type="checkbox"/> Telegraph Engineer | <input type="checkbox"/> Show Card Writer |
| <input type="checkbox"/> Telephone Work | <input type="checkbox"/> Sign Painter |
| <input type="checkbox"/> MECHANICAL ENGINEER | <input type="checkbox"/> Railroad Trainman |
| <input type="checkbox"/> Mechanical Draftsman | <input type="checkbox"/> ILLUSTRATING |
| <input type="checkbox"/> Machine Shop Practices | <input type="checkbox"/> Cartooning |
| <input type="checkbox"/> Toolmaker | <input type="checkbox"/> BOOKKEEPER |
| <input type="checkbox"/> Gas Engine Operating | <input type="checkbox"/> Stenographer and Typist |
| <input type="checkbox"/> CIVIL ENGINEER | <input type="checkbox"/> Cert. Pub. Accountant |
| <input type="checkbox"/> Surveying and Mapping | <input type="checkbox"/> TRAFFIC MANAGER |
| <input type="checkbox"/> MINE FOREMAN or ENG'G | <input type="checkbox"/> Railway Accountant |
| <input type="checkbox"/> STATIONARY ENGINEER | <input type="checkbox"/> Commercial Law |
| <input type="checkbox"/> Marine Engineer | <input type="checkbox"/> GOOD ENGLISH |
| <input type="checkbox"/> Ship Draftsman | <input type="checkbox"/> Teacher |
| <input type="checkbox"/> ARCHITECT | <input type="checkbox"/> Common School Subjects |
| <input type="checkbox"/> Contractor and Builder | <input type="checkbox"/> Mathematics |
| <input type="checkbox"/> Architectural Draftsman | <input type="checkbox"/> CIVIL SERVICE |
| <input type="checkbox"/> Concrete Builder | <input type="checkbox"/> Railway Mail Clerk |
| <input type="checkbox"/> Structural Engineer | <input type="checkbox"/> AUTOMOBILE OPERATING |
| <input type="checkbox"/> PLUMBING AND HEATING | <input type="checkbox"/> Auto Repairing |
| <input type="checkbox"/> Sheet Metal Worker | <input type="checkbox"/> Navigation <input type="checkbox"/> Spanish |
| <input type="checkbox"/> Textile Overseer or Supt. | <input type="checkbox"/> AGRICULTURE <input type="checkbox"/> French |
| <input type="checkbox"/> CHEMIST | <input type="checkbox"/> Poultry Raising <input type="checkbox"/> Italian |

Name _____
 Present Occupation _____
 Street and No. _____
 City _____ State _____

You benefit by mentioning the "Electrical Experimenter" when writing to advertisers.

"THE SET UNCLE SAM USES"

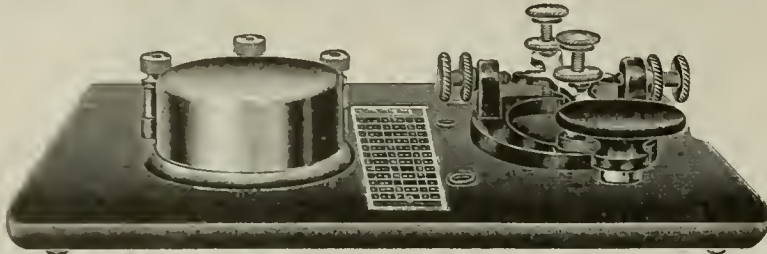

"Uncle Sam" needs thousands of operators and is calling for more all the time. Here is your chance to become an expert telegrapher at a small cost. The practice outfit shown here is exactly the same as used by the United States Signal Corps and comprises the following:

A highly polished mahogany finished wood base, a real high frequency buzzer giving a high note, with nickel-plated case, regulation nickel-plated steel lever key. Also brass etched plate showing the three international codes mounted on the base for quick practice. A new feature not found on any other set. You simply cannot mislay this code.

This outfit quickly gives you speed, and enables you to learn telegraphy, Morse or wireless code in a short time. Special attention is called to the buzzer which gives a clear high note, not a rattling noise as many inferior outfits now on the market. IMMEDIATE DELIVERY. We ship the same day that order is received. Your money refunded if you are not satisfied.

Price as illustrated. Shipping weight 2 lbs. Size over all 5"x2"x7 1/4".

\$2.80

Includes sufficient postage for mailing. Send for free illustrated folder.

THE TEWNO CO.

150 CHAMBERS ST., NEW YORK

The Breakers

Atlantic City's Newest Fire-Proof Hotel

Ocean Front. Unusually attractive during the Autumn and Winter seasons.

American and European Plans

Luxurious lobbies, spacious verandas and sun parlors overlooking the ocean. Charming afternoon musicales and evening concerts. A palatial residence for those seeking rest and recreation. Sea water baths. Fireproof garage. Illustrated booklet sent on request.



MAGNETIC RECTIFIER

Patented April 18, 1916

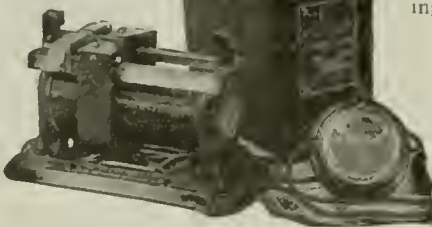

YOUR lights will shine and sparkle with delight, your horn will squawk raucously and your engine will turnover enthusiastically if you play godfather to your starting and lighting battery by giving it an

F-F BATTERY BOOSTER

A few minutes of your time once a month or so will rejuvenate your battery and prolong indefinitely its working life.

Write today for bulletin No. 12 and obtain a prescription for this battery panacea.

The France Manufacturing Company

10325 Berea Road, Cleveland, O.

Super-Sensitive Microphone Only \$7.50



This instrument is offered at an extremely low price. It is excellent for building your own radio amplifier. Can also be used in many experiments where a sensitive microphone is required.

DETECTAGRAPH \$15

This detecting instrument of marvelous sensitivity can be used for detecting secret conversations. Outfit consists of Sensitive Transmitter, 25 ft. Black Cord, Receiver, Headband, Case and Battery. Send for One Today and Convince Yourself!

GASTON BOISSONNAULT

26 Cortlandt Street

Makers of Super-Sensitive Microphone Apparatus

New York

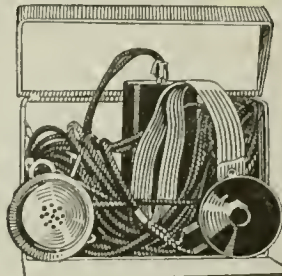

DETECTAGRAPH \$15

A WIRELESS OUTFIT FOR 20c

We at last have a low-priced wireless telegraph system. With this outfit you can receive and send messages to your friends and sweethearts or neighbors across the hall, etc. This outfit consists of two mechanical snapper sounders, one for each station; also two codes of Morse Alphabet, which, with practice, will enable you to operate any telegraph system. Complete, postpaid, for 20c in coin.

THE A. S. CO. 1305 Peoria St. CHICAGO

DEAFNESS IS MISERY

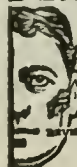

I know because I was Deaf and had Head Noises for over 30 years. My invisible Anti-septic Ear Drums restored my hearing and stopped Head Noises, and will do it for you. They are Tiny Megaphones. Cannot be seen when worn. Easy to put in, easy to take out. Are "Unseen Comforts." Inexpensive. Write for Booklet and my sworn statement of how I recovered my hearing. **A. O. LEONARD** Suite 369 70 5th Ave., N. Y. City

THE EFFECT OF STATICS ON WIRELESS TRANSMISSION.

(Continued from page 627)

energy received, even if it could be collected in its totality, is infinitesimal and would not actuate the most sensitive instrument known were it magnified many million times. The fact is these waves have no perceptible influence on a receiver if situated at a much smaller distance. It should be remembered, moreover, that since the first attempts the wave lengths have been increased until those advocated by me were adopted, in which this form of radiation has been reduced to one-hillionth.

When a circuit, connected to ground and to an elevated capacity oscillates, two effects separate and distinct are produced; Hertz waves are radiated in a direction at right angles to the axis of symmetry of the conductor, and simultaneously a current is passed through the earth. The former propagates with the speed of light, the latter with a velocity proportionate to the cosecant of an angle which from the origin to the opposite point of the globe varies from zero to 180°. Expressed in words, at the start the speed is infinite and diminishes, first rapidly and then slowly until a quadrant is traversed when the current proceeds with the speed of light. From that region on the velocity gradually increases, becoming infinite at the opposite point of the globe. In a patent granted to me in April, 1905, I have summed up this law of propagation in the statement that the projections of all half waves on the axis of symmetry of movement are equal, which means that the successive half waves, tho of different length, cover exactly the same area. In the near future many wonderful results will be obtained by taking advantage of this fact.

There is a vast difference between these two forms of wave movement in their bearing on the transmission. The Hertz waves represent energy which is radiated and unrecoverable. The current energy, on the other hand, is preserved and can be recovered theoretically, at least, in its entirety. If the experts will free themselves from the illusions under which they are laboring, they will find that to overcome static disturbances all that is needed is a properly constructed transmitter and receiver without any additional devices or preventives. I have, however, devised several forms of apparatus eliminating statics even in the present defective wireless installations in which they are magnified many times. Such a form of instrument which I have used successfully is shown in the annexed photograph. These phenomena have been studied by me for a number of years and I have found that there are nine or ten different causes tending to intensify them, and in due course I shall give a full description of the various improvements I have made, in the ELECTRICAL EXPERIMENTER. For the present I would only point out that in order to perfectly eliminate the static interference, it is indispensable to redesign the whole wireless apparatus as now employed. The sooner this is understood the better it will be for the further evolution of the Art.

A means of making use of the electric magnet under water has been devised in Japan, and it promises to be of great assistance in locating sunken vessels, to recover which salvage operations on a big scale are expected after the war.

With the aid of special oxygen masks airplane experts believe that air fighters will be able to carry on battles five miles above the earth.

NEW BATTERY CHARGER SIMPLICITY ITSELF.

For the Garage Man going into Battery or Service work on an ample scale, or for the Garage that has outgrown its present equipment, an Ohio concern has brought out a new 32 battery capacity Charging Outfit shown herewith.

With this outfit batteries in all stages of charge can be handled by the four charging lines provided, caring for eight batteries in each line. Batteries requiring different charging rates can be handled according to their individual needs, due to the ample output of the machine. Different voltage batteries can also be charged in the same line, due to the automatic voltage control of the Generator.

With this outfit, battery charging work is claimed to be very profitable, and the makers state they have designed the outfit wholly with the idea of bringing the Garage the largest profits possible from this class of work.



Compact Battery Charging Outfit of capacity Ample for Average Public Garage and Service Station.

DO YOU ASSOCIATE COLORS WITH FIGURES?

The recent letter to *Science* from David Starr Jordan called to my attention a fact which I did not know before, says Arthur Bessey Smith, the well-known telephone engineer, in that journal. On mentioning it to my laboratory assistant, Mr. Herbert Edward Clapham, he said that he, too, associated colors with the letters of the alphabet, but not with all, and that figures were also associated with colors. At my request he wrote out the following list:

- | | | |
|---------------|----------------|-------------|
| A gray | O black | 1 white |
| B light red | P brown | 2 red |
| C black | Q ---- | 3 light red |
| D pink | R ---- | 4 gray |
| E scarlet | S white | 5 white |
| F pink | T red | 6 white |
| G ---- | U golden brown | 7 golden |
| H yellow | V gray | 8 brown |
| I white | W ---- | 9 red |
| J white | X ---- | 0 black |
| K ---- | Y white | |
| L ---- | Z red | |
| M olive green | | |
| N olive green | | |

Altho I have never associated colors with letters or figures, from my earliest recollection I have always thought of letters and of figures arranged in certain relative positions. The origin of this I do not know. It might have been something in the presentation of these things by my first teacher, or the manner in which little wooden sticks were laid out on my desk in the first number work. These little sticks, each about 3 mm. in diameter and 20 mm. long, had been split out of pine for me by my father.

Which Job Can You Fill?

WANTED!
OFFICE MEN
Auditors, Accountants, Office Managers, Credit Men, Cashiers, Bookkeepers and Cost Clerks—\$1,200 to \$7,500.
FACTORY MEN
Electrical and Mechanical Engineers, Factory Managers, Superintendents, Foremen, Designers, Draftsmen—\$1,500 to \$12,000.
CONSTRUCTION MEN
Civil and Structural Engineers, Transmitters, Construction Superintendents and Foremen, Estimators, Designers and Draftsmen—\$1,200 to \$10,000.
TRADES—Machinists and Tool-makers, Auto Repairers, Electricians, Stationary Engineers, Firemen, Plumbers, Carpenters, etc.—\$1,200 to \$2,000.

All these positions were advertised in a single issue of a Chicago newspaper

Which one of them could you fill? If you haven't the knowledge necessary to break into the *big-pay class*, decide to *get that knowledge NOW!* Any of the books listed below will quickly fit you for a well-paid job—at home—in your spare time.

Carpentry and Contracting
Five volumes, 2133 pages and more than 400 illustrations. Prepares for Contractor, Building Superintendent and Carpenter Foreman. Regular price, \$25.00. Special price, \$17.50.

Fire Prevention and Insurance
Four volumes, 1500 pages and 600 illustrations, diagrams, forms, etc. Prepares for Comptroller, Rate Clerk, Inspector or Agent. Regular price, \$20.00. Special price, \$15.00.

Civil Engineering
Nine volumes, 3900 pages and 2000 illustrations, plates and diagrams. Prepares for Civil or Structural Engineer, Transmitter, Estimator, Designer or Chief Draftsman. Regular price, \$45.00. Special price, \$29.50.

Electrical Engineering
Seven volumes, 3000 pages and 2600 illustrations, plates and diagrams. Prepares for Electrical Engineer, Power Plant Superintendent, Substation Operator or Electrician. Regular price, \$35.00. Special price, \$19.50.

Telephony and Telegraphy
Four volumes, 1723 pages and 2000 illustrations, plates and diagrams. Prepares for Telephone Engineer, Wire Chief, Exchange Manager, Trouble Man or Telegrapher. Regular price, \$20.00. Special price, \$12.50.

Accountancy and Business Management
Ten volumes, 3680 pages and 1987 illustrations, forms, etc. Prepares for Certified Public Accountant, Auditor, Office Manager, Accountant, Credit Man or Bookkeeper. Regular price, \$50.00. Special price, \$24.50.

One Week Free Trial

We'll gladly send you any set for seven days' examination. Don't send us a penny; just pay the small shipping charge when the books arrive. Examine them carefully—use them at your work for an entire week. At the end of that time, if you feel they aren't worth far more than we ask, return them *at our expense*. If you keep them, pay the bargain price on the easy terms explained below.

American Technical Society
Dept. X3389 Chicago, U. S. A.

50c A WEEK

Yes, if you decide to keep the set you have selected, send \$2 within seven days and then \$2 a month (50c a week) until the present low price has been paid. Have you ever heard of a more generous offer? Remember, you take no chances whatever—we send the books for examination and you are not obliged to keep them if you do not care to buy. Mail the coupon *now*—before you turn the page.

American Technical Society, Dept. X3389, Chicago, Ill.

Please send me set of
for 7 days' examination, shipping charges collect. I will examine the books thoroughly and, if satisfied, will send \$2 within 7 days and \$2 each month until I have paid the special price of If I decide not to keep the books, I will return them by express at your expense. Title not to pass to me until the set is fully paid for.

Name

Address

Reference

?

CHEMISTRY!

DO YOU KNOW?

- Do you know how to make chemical tricks?
- Do you know how cloth is bleached?
- Do you know how to test soil?
- Do you want to make invisible ink?
- Do you know how to test flour?
- Do you know how Chlorine Smoke and Chlorine Gas (German War Gas), is made?
- What do you know about chemistry in general?

These and hundred other interesting questions are answered and demonstrated with our Chemistry Laboratory which we present herewith.

The chemicals furnished are all technically pure and put up in appropriate wooden boxes and glass bottles, and there is a sufficient quantity to make dozens of experiments with each. The apparatus are of standard laboratory size and quality.

Altho all chemicals have nearly doubled in price, we have decided not to raise the price for this outfit for the present.

Read the list of chemicals and apparatus and look at the actual photograph of the outfit at your right.

And order one today!

We present herewith to our friends our new E. I. Co. Chemical Laboratory which contains real chemicals and apparatus to perform real chemical experiments. This outfit is not a toy, put up merely to amuse, but a practical laboratory set, with all the chemicals, apparatus and reagents necessary to perform real work and to teach the beginner all the secrets of inorganic chemistry. With this outfit we give free a book containing a *Treatise in Elementary Chemistry*, useful data and recipes, and 100 instructive and amusing experiments.



44
Chemicals
17
Apparata
1
Instruction
Book with
100 Ex-
periments

PRICE
\$5.00

Shipping
Weight 10 lbs

CAN BE SHIPPED
BY EXPRESS ONLY

THE E. I. Co. CHEMICAL LABORATORY

DESCRIPTION OF THE OUTFIT

It contains the following 44 chemicals:

Ammonium Chloride
Alum
Antimony
Boracic Acid
Charcoal
Sodium Nitrate
Sodium Carbonate
Sodium Borate
Sodium Sulphate
Manganese Dioxide
Oxalic Acid

Brimstone
Iron Oxide
Sulphate of Zinc
Magnesia Carbonate
Zinc, Metallic
Sodium Bicarbonate
Sodium Sulphate
Sodium Chloride
Calcium Sulphate
Barium Chloride
Lead Acetate

Ferrous Sulphate
Nickel Sulphate
Sodium Phosphate
Zinc Carbonate
Ammonium Sulphate
Ammonium Carbonate
Ammonium Aqua
Calcium Chloride
Chloride of Zinc
Copper Sulphate
Glycerol

Iron Chloride
Calcium Oxide
Stannous Chloride
Nickel Chloride
Hydrochloric Acid
Sulphuric Acid
Iodine
Mercury, Metallic
Tin, Metallic
Litmus Paper
Ferrous Sulphide

The following apparatus are furnished:

One Standard Washbottle
One Alcohol Lamp
One Conical Glass Measure
One Erlenmeyer Flask
One Glass Funnel
One Delivery Tube

Six Assorted Test-Tubes
One Test-Tube Holder
Ten Sheets of Filter Paper
One Glass Dropper
One Spoon Measure

Glass Tubing
One book containing *Treatise on Elementary Chemistry* and 100 Chemical Experiments to be performed with this outfit.

THE ELECTRO IMPORTING Co., NEW YORK, 231 FULTON STREET
SEE OUR FULL PAGE AD ON PAGE 679 FOR FREE CYCLOPEDIA

PATENT ADVICE

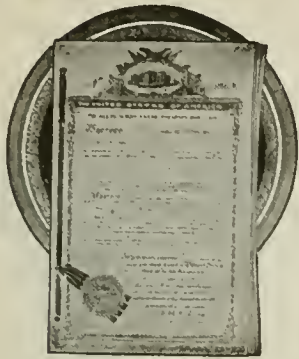

Edited by H. GERNSBACK

In this Department we publish such matter as is of interest to inventors and particularly to those who are in doubt as to certain Patent Phases. Regular inquiries address to "Patent Advice" cannot be answered by mail free of charge. Such inquiries are published here for the benefit of all readers. If the idea is thought to be of importance, we make it a rule not to divulge all details, in order to protect the inventor as far as it is possible to do so.

Should advice be desired by mail a nominal charge of \$1.00 is made for each question. Sketches and descriptions must be clear and explicit. Only one side of sheet should be written on.

Readers' attention is called to the fact that due to the great amount of letters to this department it is quite impossible to answer them all thru these columns. The inquiries answered in this issue date as far back as July, and if readers wish speedy service they should carefully note the announcement appearing in the preceding paragraph.

Code Practise Instrument.

(289) Geo. R. Griffin, Troy, N. Y., writes: "I have noticed in the November number of the ELECTRICAL EXPERIMENTER an article by A. E. Kopp, New Middletown, Ind., called 'Code Practise Instrument' and the fault you had found with it. I have an idea which might be of value to Mr. Kopp's instrument, and am enclosing copy of same with the request to publish the device at your convenience."

Mr. Griffin suggests putting the lamp of the practise outfit right on the key lever as shown in our illustration. By this means the bulb is screwed in the socket made for that purpose on the lever of the key. This has a tendency to light the bulb on the downward stroke instead of the upward stroke.

A. This strikes us as a good solution of Mr. Kopp's idea, but of course in this case Mr. Griffin and Mr. Kopp should really be joint inventors in any future patent action. The solution seems satisfactory offhand.

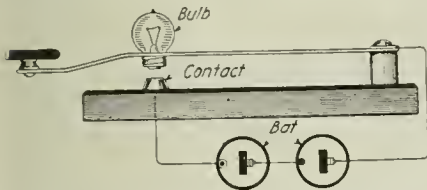

Improved Code Practise Instrument.

Diving Mine.

(290) W. F. Ashe, Jacksonville, Fla., writes: "Has there been a patent issued for a 'diving mine'—power to be furnished by small motor or clockwork—one that will take in water on the surface of the sea, which will cause it to sink to let mine rakes pass by, and after it has gone down to about fifty feet, it will throw out water, and thus cause it to rise in time to blow a battleship up?"

A. To our knowledge there has never been anything of this kind invented before, and we have never seen any reference to it. We think a device of this kind is more or less impossible.

Safety Soap.

(291) W. L. McGowan, Holdenville, Okla., writes: "To your knowledge has there been any device patented for preventing soap from being stolen or destroyed from public places? Furthermore what do you think of such a device. The device which I speak of is composed of a flat steel which runs thru the center of the soap and is fastened by chain at one end and small lock on the other. Any information that you can give me concerning this matter will be greatly appreciated."

A. This is a very old idea, and one which we have seen in actual use in hotel and public wash-rooms years and years ago. There is nothing novel about this, and nearly all of these devices

have been superseded by automatic soap dispensing machines, such as liquid soap, where you only have to press a button to get a thimblefull of liquid soap in your hand, or the other device whereby you turn a handle which puts soap shavings into your hand.

Invisible Periscope.

(292) Mr. Geo. Ulrich, Newark, N. J., submits an idea of what he calls "invisible periscope" scheme. The outside of the periscope tubing is to be surrounded with a heavy glass tube while the space between the periscope tube and glass tube is to be filled with sea water. The periscope tube is to be painted to match the sea water. Our advice is asked.

A. While an ingenious idea, this is not different from many other similar devices which have been suggested in the past. The trouble is that it is not the periscope itself which makes the trouble, but the V-shaped wake of churned, white water which is left behind as the submarine speeds thru the water. The periscope itself can be and has been camouflaged in the past in such a way as to render it almost invisible within a hundred yards. Of course, this is all right while the submarine is not moving, but once it starts moving, the periscope immediately leaves a tell-tale wake behind.

Ice-Cream Cone.

(293) Gardner S. Wyman, Pittsburgh, Pa., says: "I would like to submit a plan for a paper ice-cream cone that is to take the place of cake cones now in use, as I understand there is a shortage of the latter; the plan is to make a cone of the same shape as cake cones out of fairly heavy wax paper, the latter to unroll like a paper pencil as the cream is eaten away." Our advice is asked on this idea.

A. We are afraid that while it looks feasible on paper, it would not work out in practise for the reason that it would at best be a very messy operation to thus unroll the wax paper, which surely would splash melted cream over the eater.

U.S. PATENTS

SEND FOR THIS FORM

Don't Lose Your Rights

Before disclosing your invention to anyone send for blank form "Evidence of Conception" to be signed and witnessed. A sample form together with printed instructions will show you just how to work up your evidence and establish your rights before filing application for patent. As registered patent attorneys we represent hundreds of inventors all over the U. S. and Canada in the advancement of inventions. Our schedule of fees will be found reasonable. The form "Evidence of Conception," sample, instructions relating to obtaining of patent and schedule of fees sent upon request. Ask for them,—a post card will do.

LANCASTER & ALLWINE

255 OURAY BLDG., WASHINGTON, D. C.

PATENTS

INVENTORS. Send us a sketch, model, or photo and written description of your invention for advice regarding patent protection. No charge for this service.

Patents we secure advertised without charge in Popular Mechanics Magazine.

20 years' experience. Prompt personal service. Our experience and knowledge in patent matters often enables us to advise regarding patentability without expense to the inventor. Particulars Free. Write us today.

TALBERT & TALBERT, Patent Lawyers
4287 Talbert Bldg., Washington, D. C.

PATENTS

Inventors Invited to Write for Information and Particulars
Highest References. Best Results.
Promptness Assured.

WATSON E. COLEMAN
Patent Lawyer
624 F Street N. W. Washington, D. C.

PATENTS TRADE-MARKS AND COPYRIGHTS

Before disclosing an invention, the inventor should write for our blank form "EVIDENCE OF CONCEPTION". This should be signed and witnessed and returned to us together with model or sketch and description of the invention, and we will give our opinion as to its patentable nature.

Our Illustrated Guide Book, HOW TO OBTAIN A PATENT, sent Free on request. Contains full instructions regarding Patents, Trade-Marks, Foreign Patents, Our Methods, Terms and 100 Mechanical Movements illustrated and described. Articles on Patent Practice and Procedure, and Law Points for inventors.

An actual search of United States patents made in all cases before preparing application for patent.

Electrical Cases a Specialty **Highest References** **Prompt Attention** **Reasonable Terms**

FREE COUPON!
VICTOR J. EVANS & CO., Patent Attorneys

New York Offices: 1001 to 1007 Woolworth Bldg.	Pittsburgh Offices: 514 Empire Bldg.	Philadelphia Offices: 135 S. Broad St.
Main Offices: 779 Ninth Street, N. W., Washington, D. C.		

Name _____ Address _____

You benefit by mentioning the "Electrical Experimenter" when writing to advertisers.

AMERICA NEEDS YOUR IDEAS



MILLIONS OF DOLLARS

are being spent NOW for new ideas of all kinds. Never before has the demand for good things **PROTECTED BY OWEN PATENTS** been so great—or profitable to the man who will but use his brains. Send for my four free books and find out what inventions are needed.

THESE ARE FREE! SUCCESSFUL PATENTS—a 72-page guide to success; **STEPPING STONES**—hundreds of hints of ideas wanted; truth about prizes for inventions; **PATENT BUYERS**—contains over 400 requests for OWEN PATENTS, with ideas desired; **PATENT PROMOTION**—tells how to sell your patent, etc.

I'll help without charge to sell your idea by advertising it and otherwise putting you in touch with prospective buyers. Send sketch or model for free opinion as to patentability, cost of patent, etc. Advice costs nothing. Write today for my books. A postal request will do.

RICHARD B. OWEN, Patent Lawyer
184 Owen Building 2276-8 Woolworth Bldg.
Washington, D. C. New York City

PATENTS and Trade Marks

Send sketch or model for actual search and report. Write for Booklet of instructions on patent practice and procedure. Prompt personal service. . . .

Geo. P. Kimmel

Patent Lawyer

88-M Oriental Bldg., Washington, D. C.

PATENTS LACEY & LACEY

Attorneys-at-Law—Patent Practice Exclusively
Solicitors of

**U. S. and Foreign Patents
Trade-Marks, Copyrights**

642 F Street, N. W., Washington, D. C.

Write Us for Our Inventors' Book
PATENT-SENSE
ESTABLISHED 1869

U. S. PATENTS

Our facilities for securing patents enable us to give prompt and reliable service at reasonable rates. Inventors are invited to write to us regarding questions appertaining to securing patent protection. All matters receive prompt attention. Send sketch for preliminary examination. Books free on request.

A. M. BUCK & CO., Patent Attorneys,
205 Second Nat'l Bank Bldg., Washington, D. C.

Electric Radiator.

(294) Earl F. Hobbs, St. Louis, Mo., has an idea of a hot water radiator, electrically heated with expansion tank and built on wheels so it could be moved from one location to another and from room to room. It could be made out of 3/4 inch pipe with about a 500 watt element made from nichrome wire. The radiator to have a medium and a low point.

A. There is nothing fundamentally new in electrically heated water radiators as our correspondent suggests in his letter. We have in the **ELECTRICAL EXPERIMENTER** often described numerous electrically heated radiators of this sort.

Poison Shell.

(295) Joseph Vierthaler, Philadelphia, Pa., submits description and device of a poison shell which comprises an ordinary shell with a hollow center. Poisoned gas is enclosed in the shell, the latter is put in the shell when manufactured. Our advice is asked.

A. There is nothing new at all about this, and the present gas shells as have been used by the Germans as well as all the Allies and the United States are made along precisely this plan.

Fan Guard.

(296) Ladimir H. Svoboda, Cleveland, Ohio, writes: "As editor of the 'Patent Advice' I would appreciate your advice on the following: Would it be advisable to employ a guard for a small special electrical fan having blades but 3" long? The guard if employed must be disectable. I have been advised to use a 'sand guard.' Could you give me details as to this or any other disectable guard?"

A. We see nothing fundamentally difficult in making a detachable fan guard to work in conjunction with a small fan. It seems that any model shop or a clever experimenter ought to be able to devise such a guard, which seems a very simple undertaking. We do not know, however, what you mean by sand guard. We do not know to what this refers.

Telephone Receiver.

(297) Frank W. Harrington, Fulton, Ill., sends in a sketch of a telephone receiver which we reproduce herewith. The idea is to employ two bobbins having a central opening which are to pull in two soft iron needles 1/32 inch in diameter attached to the diafram as shown. We are asked if this design is good, whether the telephone is sensitive and whether the device has ever been tried before.

A. This is a similar idea to one described some time ago in these columns. Right here we want to say that any telephone receiver as a rule,—with very few exceptions,—which has its diafram weighed so as to interfere with the free vibration of the latter, usually is less sensitive than the diaframs which swing free. We are quite convinced that the construction shown by

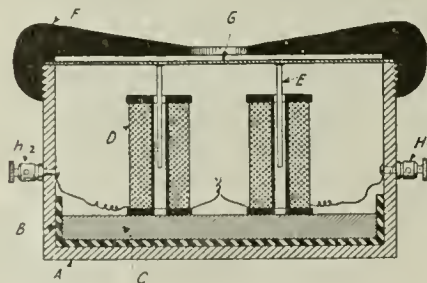

Novel Idea in Telephone Receiver Design.

our correspondent would not prove very sensitive. The idea is of course not new, having been tried quite a number of times before.

Soldering Iron.

(298) K. Mowat, Atkins, Mich., writes: "Will you please tell me if an electric soldering iron which operates on six volts, six amperes is patentable. It has three holes bored in the iron in which is placed carbon of a certain size insulated by asbestos and connected together by copper strips, the whole being wrapped in asbestos which is held on by iron wire twisted at the ends.

A. Without knowing all the details of the construction, it is impossible to tell where this device would be patentable or not, and if it would work out in practise. We would advise our correspondent to first build a model and convince himself if it works satisfactorily before attempting to patent it.

NEW "GERMAN" ALARM CLOCK.

An electric alarm clock which awakens deaf sleepers by jarring their beds has been invented in Germany.

They should put one under the Kaiser's bed to awake him to the fact that the Potsdam Gang is "spurlös versenkt!"

NEW ELECTRIC FIRE DETECTOR AND ALARM.

The new quick alarm fire detector here shown supplements and supersedes watchmen. It is superhuman in responsiveness,



incessantly watching every part of the home or building. It operates the moment the air in close proximity to the ceiling becomes heated at the rate of 4 degrees Fahrenheit per minute. For example: A single newspaper on fire in a room having as much as 500 sq. ft. of floor space heats the air suddenly enough to cause a single detector to operate in 5 seconds.

This detector is radically different from common types of automatic alarms, thermostats and sprinklers which depend upon alloys, soft solder, bi-metallic compositions, dissimilar metal or mercury requiring a slow rise or fixt temperature of from 110 to 250 degrees. Before such systems operate, the fire gains tremendous headway, making it necessary to call the fire department to the scene, which means another delay of at least five minutes and inevitable damage. The inventor claims that this new fire detector enables one to locate the seat of the fire and to extinguish it single-handed, long before it gets hot enough to operate automatic sprinkler systems. The principle upon which it operates is simplicity itself. The very air heated by the incipient fire inflates a (non-metallic) diafram, joining two solid silver contact points, instantly closing the electric circuit. The detector is as sensitive below zero as above, but, by reason of its automatic compensating feature slow or local rises in temperature such as produced by hot water systems, furnaces, open grates, kitchen stoves or steam boilers cannot cause a false alarm. The automatic compensator insures that the air pressure under normal conditions is always the same inside the detector as that of the surrounding atmosphere.

The detector is very largely composed of a stone-hard insulating compound in which various elements have been permanently molded for permanent protection against wear and short-circuiting. It may be installed as easily as the ordinary household door bell or call bell systems, making use of bells, horns, signal lights, annunciators and batteries. It is compact, requires no assembling or adjusting, can easily be detached and removed from one building and again installed in another without the slightest damage.

CABLE BOX FIRE EXTINGUISHER.

To extinguish fires in electric cable boxes, where water might cause short circuiting, a device has been invented for injecting flame-smothering gases.

**ONE READER'S EXPERIENCE
WITH DR. ABRAMS'
THOUGHT TRANS-
FERENCE
THEORY.**

As our reader's will recollect, we suggested in the September issue in connection with the article therein entitled "Popular Demonstration of Thought Transference and Other Phenomena," by Dr. Albert Abrams, that they write us as to what success they have attained in conducting any of the experiments outlined by Dr. Abrams in this little known realm of science, and we are pleased to give herewith the views of Mr. J. W. White of Brooklyn, N. Y., Mr. White having witnessed a number of these tests as conducted by Dr. Abrams himself, when visiting San Francisco several years ago. Furthermore, Mr. White, who is in the electrical business in New York City, and a thoroughly wide-awake student of electrical and allied matters, had the satisfaction of taking part in some of the experiments in Dr. Abrams' laboratory, and his views as given below are those of an unprejudiced and unbiased student.

Many people undoubtedly who have read the article in question have tried, unsuccessfully perhaps, to obtain results by *unipolar currents*, according to the theory of Dr. Abrams, such as for instance where the "percipient" or person interpreting the thought transference signal or message is connected to another person or body which forms the exciting point in the unipolar (single wire) circuit.

Here, for example, is what Mr. White experienced, and in this connection it is well to remember that the high professional standing of Dr. Abrams in the medical and scientific fields precludes all doubt of any fake or misrepresented reactions or phenomena, however little we may as yet know as to the exact mode in which such phenomena take place. First Dr. Abrams placed Mr. White in a separate laboratory room and gave him a permanent steel bar magnet, which as we all know has a *North* and *South* pole at the alternate ends. The Doctor instructed Mr. White to present either magnet pole as he might elect to the steam radiator in the room, when he would be able to tell in his instrument laboratory just which end of the magnet he had presented. According to the theory of Dr. Abrams, the action here was as follows: That the electronic discharge from the magnet, even when held a short distance from the radiator, charged the metal piping system, and this particular discharge past along thru the radiator and metal piping to the laboratory where an instrument or a human substitute for the instrument was connected by *one wire* to another radiator connected to the system. In this connection it is interesting to note that Dr. Abrams usually prefers to employ some delicate human reflex, such as the heart or stomach reflex, for indicating when one of these extremely minute electric currents arise, and which agents he claims are many *hundred thousand times* more sensitive to minute currents than are the most delicate scientific instruments such as galvanometers, etc. To sum up this experiment, Dr. Abrams was able to tell quickly just which magnet pole Mr. White had presented to the radiator, not making a single miss in twenty tests.

One of the most astounding phases of this particular experiment was when the Doctor informed Mr. White that it was not at all necessary that he present the magnet to the radiator, so as either to touch it or approach close up to it, but that he could determine which pole of the magnet the investigator was *thinking of* if he would but lay it on the floor and *concentrate his mind*

Answer the call of Your Calling Now



If you like electricity and are electrically inclined—there is where you will be most successful; for electricity is your calling. And the great field of electricity, with its superior advantages, opportunities and possibilities is calling to you *now*. Answer that call by obtaining the thorough, complete and practical electrical education, training and development this school offers. You will need ability because only electrical men with ability are chosen for the high electrical places. But don't just *work* at electricity, *learn* electricity. Don't just be *ambitious*. Be *determined* to succeed as one of the thorough efficient electrical men so anxiously sought. Enroll with this school now—don't wait and waste your time.

Become An Electrician In One Year Here Or Learn An Electrical Trade in 6 Months

THE courses here are practical, with the essential theory, mathematics, drafting, etc. You will have electrical appliances, tools, instruments, machines, motors, generators, etc., to work with while learning, to design, build, repair and operate—learning by actually doing as well as from classroom study and lectures. Also, there are fully equipped laboratories here—students performing 383 experiments a year. And you will obtain here in a short time the electrical knowledge and ability the electrical world requires, which you will need to succeed.

You Can Earn While You Learn

All your school periods here will be confined to morning or afternoon—with a half day free. And, if you choose, you can work one-half day at good pay in a position provided you by this school. And thus you can earn while you learn and help defray your school expenses—and obtain, as well, the valuable experience by working. Evening classes are likewise conducted and you can work all day and earn more money, if you prefer. Clip the coupon at the right here—get catalog and details of this school's courses, the "Earn While You Learn" plan and the many advantages here for you. Clip and mail the coupon.

Next Term Starts January 2

Department of Practical Electricity
SCHOOL OF ENGINEERING
An Electrical Technicians' Institute. **OF MILWAUKEE**
73-373 Broadway, Milwaukee, Wisconsin.

Mail This Coupon

**School of Engineering
of Milwaukee**
73-373 Broadway, Milwaukee, Wis.

I have checked the subjects I am interested in—please send complete details.

- Electrician Course A. C. & D. C.—1 yr.
- Electrical Engineering Course—3 years.
- 6 months Electrical Trade Courses
- Electrical Troubleshooting and Lineman.
- Electrical Meterman.
- Electrical Wireman.
- Electrical Motor and Generator Repairman.
- Telephone Trouble and Repairman.
- Draftsman.
- Earn While You Learn Plan.

Name.....
Address.....
City..... State.....
Age..... Education.....

LEARN TO FLY

We are NOW enrolling Student Aviators for our **SPRING CLASS** which starts **March 1st**.

Modern type, high speed biplanes used for training. Students continue training until Pilot's license is obtained from AERO CLUB OF AMERICA.
The opportunities for Licensed Aviators are greater than ever, for the Aeroplane is now the means of fast transportation of mail, passengers and light express goods.
Our Flying Course, also includes 6 weeks training in care and operation of engines, airplanes, use of instruments, map reading, navigation of the air, etc.

Write for our Illustrated Booklet "H"—"A Message to You on Aviation."

at AMERICA'S PIONEER AVIATION SCHOOL under Former Aviator Officers Back from the Front.

(Members of Aeronautical Society of America)



Telephone Bryant 9078
110-114 West 42d Street, New York

ACTIVE SERVICE

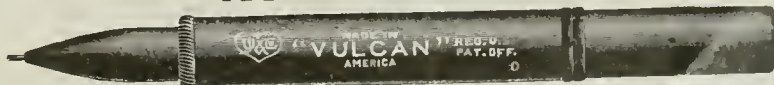

\$1.25 Dependable for a life time. Made right to write right. Long or short—Red or Black. Absolute necessity to any business man or woman. Unequaled for general writing, billing, ruling and manifolded. Made of pure vulcanized rubber with non-corrosive, durable writing point. Lock-Cap prevents leaking. Extra size, 8 in., black only, \$1.50. Your name in gold inlay 35c. FREE: Liberal supply of ink with retail orders. Agents wanted. Good profits.
J. R. ULLRICH & CO., 27 Thames St., New York

Learn Telegraphy-Wireless

Right In Your Own Home, in your spare time

Remarkable opportunities are offered experienced wireless operators and telegraphers. The demand is greater than the supply—steady positions at increased pay and rapid advancement are assured.



Combination Wireless-Telegraphy Outfit

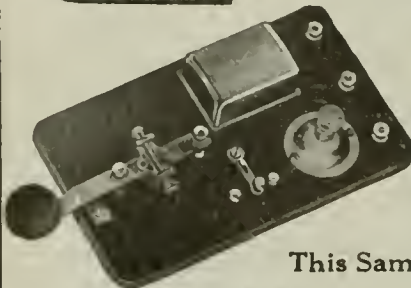

will soon make you an accomplished operator. Teaches Light and Sound Signals, both Radio and Morse. Outfit consists of exceptionally fine Telegraph Key, Buzzer, 3 Binding Posts, Lamp, Lamp Socket and Control Switch—all mounted on a highly finished base. Two outfits can be operated at considerable distance apart for sending and receiving practice.

\$3.00

This Same Outfit Without Lamp \$2.50

Or your dealer can secure it for you. Order to-day. Descriptive circular and catalog of celebrated Knapp Motors and Electrical Specialties from 10c up mailed free on request.

Knapp Electric & Novelty Co., 523 W. 51st St., N. Y.

BECAUSE OF THE SHORTAGE of CRUDE RUBBER You can SAVE \$10.00 on our Standard VIOLET-RAY MACHINE

Being afraid that we could not get delivery on hard rubber used for the outside casing of the Violetta machine, we made 250 of these in wood. Now these machines are exactly alike in construction mechanism and workmanship as our latest model standard machine which costs \$25.00.

The only difference being that instead of using hard rubber for the casing, wood is used, but it is finished in a beautiful black piano finish, and the difference is hardly noticeable.

Now, we cannot send these out as standard machines so are placing them in a special lot at

\$15.00

so actual saving to you of \$10.00. Besides we guarantee these machines to be new. The Outfit includes the generator, one general electrode and a handsome carrying case.

How to secure one of these machines:

Send only one dollar to pay express charges and we shall send you one of these instruments by express for your examination. This amount will be deducted from total cost of machine. You need not accept if not satisfactory.

Send at once for this is the only lot we shall have of these machines and prices on the standard machine will advance in 30 days.

BLEADON-DUN CO.

DEPT. 2 B 11-17 SO. DESPLAINES ST., CHICAGO

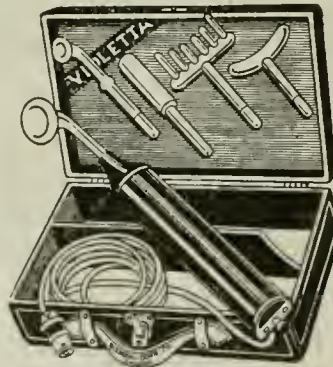

What 15¢ will bring You from the Nation's Capital

Washington, the home of the Pathfinder, is the nerve center of civilization; history is being made at this world capital. The Pathfinder's illustrated weekly review gives you a clear, impartial and correct diagnosis of public affairs during these strenuous, epoch-making days.

who is sincere, reliable, entertaining, wholesome, the Pathfinder is yours. If you would appreciate a paper which puts everything clearly, fairly, briefly—here it is. Send 25c to show that you might like such a paper, and we will send the Pathfinder on probation 13 weeks. The 15c does not repay us, but we are glad to invest in our friends. The Pathfinder, Box 76, Washington, D. C.

The little matter of 15c in stamps or coin will bring you the Pathfinder 13 weeks on trial. The Pathfinder is an illustrated weekly, published at the Nation's center, for the Nation; a paper that prints all the news of the world and tells the truth and only the truth; now in its 26th year. This paper fills the bill without emptying the purse; it costs but \$1 a year. If you want to keep posted on what is going on in the world, at the least expense of time or money, this is your means. If you want a paper to your home



TYPEWRITER SENSATION PROMPT SHIPMENT.

\$4.00 per month buys a beautifully reconstructed, latest model visible typewriter, with back spacer, decimal tabulator, two-color ribbon, etc. Every late style feature and modern operating device. Sent on approval. Catalogue and special prices free.

Harry A. Smith, 738, 218 N. Wells St., Chicago, Ill.

You benefit by mentioning the "Electrical Experimenter" when writing to advertisers.

on one of the poles. This experiment was checked up by a considerable number of tests, and Dr. Abrams was able to tell the pole concentrated on in Mr. White's mind each time.

One of the experiments which will interest our readers very greatly, especially those who read the article referred to in the September issue, was that where Mr. White became the "percipient." To show the effect of the electric currents in the body, Dr. Abrams had a strong man placed in a separate laboratory, several rooms away from where Mr. White was located, and both this man and Mr. White were connected by a single copper wire. A number of heavy weights were placed in the room with the strong man. The percipient—Mr. White—had attached to one of his fingers a pulse detector of these minute electronic currents, as devised by Dr. Abrams, comprising a small rubber tube strap to the finger; this tube being connected by means of a rubber tube with a small pneumatic chamber attached to a pivoted arm, the free end of which carried an electric contact for opening and closing a signal circuit. The contacts on this instrument were connected with a battery and an electric signaling bell. This pulse indicator was connected and acted in the same way, upon the receipt of each electronic wave or current, as the straw pulse needle indicator described in the article referred to.

This is what happened every time the strong man lifted the weights in the distant part of the laboratory buildings: An electronic current apparently shot along the wire and acted to cause a heart reflex in the percipient's (Mr. White's) body, which manifested itself at the pulse, and in turn this action repeated itself thru the rubber tube attached to the finger, thus causing the pneumatic diaphragm chamber to vibrate and move the pivot arm attached to it, which in turn caused the electric signal bell to ring each time a weight was lifted by the "agent."

Probably some of the most remarkable tests which Mr. White personally saw performed by Dr. Abrams were those where he was enabled to differentiate between different disease germs, and in some cases even the disease affecting a patient over a telephone or other wire. For some of these and other tests Dr. Abrams has devised a very interesting instrument to take the place of the stomach reflex, thus doing away with the necessity of a "live" percipient. This instrument comprises an aluminum cylinder covered at one end with a tightly stretched diaphragm of goldbeater's skin. The metallic bell or rather shell of this instrument is connected to the single unipolar terminal used in this arrangement, instead of connecting the wire to a human percipient or interpreter, and whenever an electronic current was received over the wire, the tone of the bell, as produced by striking the diaphragm with a small hammer, is caused to be either resonant or full, or else dull, according to the reaction taking place. Moreover, disease germs such as tuberculosis, cancer, and pneumonia have their own vibration period or wave length, according to his most remarkable work, "New Concepts in Diagnosis and Treatment." He outlines forms of wireless tuning apparatus comprising condensers, tuning coils, etc., for the purpose of measuring the exact wave length or vibration index of these electronic currents as they are received over a telephone or other wire and interpreted by the instrument just described, or by recourse to a human percipient employing the stomach or other reflex. The stomach reflex is one in which the percussion sound given by the stomach when struck with the fingers over that portion of the body is dulled when an electronic current is received.

THE WIRELESS SITUATION.

(Continued on page 625)

ness of all companies having been suspended, and their operators having made an instant show of patriotism by joining the Navy in the earliest days of the war, it is believed that most of the companies owning radio stations would be glad at this time to sell their stations to the Government at a fair price, which is provided for in the bill; especially so, since all who have made a study of conditions under which radio communication is held must realize that it is only a question of time when Congress will enact some measure similar to this.

At this time, when most of the world is to be made over, when the United States is fostering the beginnings of a great merchant marine, whose servant radio-telegraphy is, and when the American news and American viewpoint are to be disseminated throughout the nations, it is submitted that the greatest good to the people of the United States as a whole will accrue to them from well-regulated communications with their ships at sea and with foreign nations at reasonable rates without interference from a variety of rival interests within our own borders, utilizing the system of stations which is absolutely necessary for the control of the Fleet. There is no such thing as successful naval operations these days without efficient radio communication, and this must be provided by stations running smoothly and efficiently in the hands of the Government long before hostilities actually commence.

The Navy Department has the confidence of Congress and of the people of the United States, and deserves the confidence which would be placed in it through the enactment of this very necessary measure.

THE FATAL BILL.

H. R. 13159. 65th CONGRESS. 2d Session. IN THE HOUSE OF REPRESENTATIVES.

November 21, 1918.

Mr. Alexander introduced the following bill; which was referred to the Committee on the Merchant Marine and Fisheries and ordered to be printed.

A BILL

To further regulate radio communication. BE IT ENACTED BY THE SENATE AND HOUSE OF REPRESENTATIVES OF THE UNITED STATES OF AMERICA IN CONGRESS ASSEMBLED, That when used in this Act—

The term "signals" means the signals used in communication by any electrical system or method without the aid of a wire or other conducting connections;

The term "radio station" means any place, vessel, or vehicle containing apparatus used, or capable of being used, for transmitting or receiving signals;

The term "experiment station" means a radio station actually used for conducting experiments for the development of the science of radio communication or the apparatus appertaining thereto, and used for no other purpose except as a technical and training school station;

The term "technical and training school station" means a station actually used for purposes of instruction in radio communication and of training operators, and used for no other purpose except as an experiment station;

The term "person" includes partnerships, corporations, and associations.

Sec. 2. That the President shall requisition and take permanent possession of, for the use of the Government, every radio station on land or on a permanently moored vessel, now in existence within the jurisdiction of the United States or any of its possessions, other than experiment stations, technical and training school stations, and stations belonging to the United States or the Government of the Philippine Islands.

Sec. 3. That no person shall maintain or operate, on land or on a permanently moored vessel, (first) within any State any radio station capable of being used, (a) for the transmission of signals, the effect of which extends beyond the jurisdiction of such State or causes interference with the transmission or receipt of signals to or from any place beyond the jurisdiction of such State, or (b) for the receipt of signals which originate outside such State, or (second) any radio station within any Territory, district, or possession of the United States. This section shall not apply to experiment stations and technical training school stations duly licensed, as provided by the Act to regulate radio communication, approved August thirteenth, nineteen hundred and twelve, and stations belonging to the United States or the Government of the Philippine Islands. Whoever violates this section shall be punished by a fine of not more than \$500 for the first offense, and by a fine of not more than \$1,000 or imprisonment for not more than one year, or both, for each subsequent offense; and any radio apparatus operated in violation of this section shall be forfeited to the United States.

Sec. 4. That from the date of the passage of this Act the Secretary of the Navy shall be charged with the execution of the provisions of the Act approved July twenty-third, nineteen hundred and twelve, amending section one of an Act entitled "An Act to require apparatus and operators for radio communication on certain ocean steamers," approved June twenty-fourth, nineteen hundred and ten, with the Act entitled "An Act to regulate radio communication," approved August thirteenth, nineteen hundred and twelve, and any amendments to the said Acts, and the provisions of the International Radiotelegraphic Convention, signed in London in nineteen hundred and twelve and proclaimed by the President July eighth, nineteen hundred and thirteen, and future international radiotelegraphic conventions which may be ratified by the United States, except in so far as the provisions of the above-mentioned Acts, conventions, or treaties apply to stations operated by other departments of the Government of the United States or by the government of the Philippine Islands.

Sec. 5. That the Secretary of the Navy may issue special licenses, subject to such conditions and restrictions, and for such periods, as he deems proper, for the establishment and operation of stations for special emergency use in cases where no other rapid means of communication are available. Any violation of such conditions and restrictions shall constitute cause for revocation of the license without compensation therefor, and the owners of such station shall be punished by a fine of not more than \$500 or by imprisonment for not more than one year, or both.

Sec. 6. That when the United States is at war or when war is threatened, or during any war in which the United States is a neutral nation, or during any national emergency, such fact being evidenced by the proclamation of the President—

(a) The President may issue regulations for the conduct and censorship of all radio stations and radio apparatus within the jurisdiction of the United States or of any of its possessions. Whoever knowingly violates any such regulation shall be punished by a fine of not more than \$10,000 or by imprisonment for not more than three years, or both, and in case of any violation the radio station or apparatus shall be forfeited to the United States; and

(b) The President may cause the closing of any radio station on land or on a permanently moored vessel within the jurisdiction of the United States or any of its possessions and the removal therefrom of any radio apparatus, or may authorize the use of the station or its apparatus by the United States.

The regulations for the conduct and censorship of radio stations, the closing of a radio station, and the removal of apparatus therefrom shall continue no longer than the duration of such war or emergency. The fact that the war or emergency has ended shall be evidenced by the proclamation of the President.

Sec. 7. That if, in the opinion of the Secretary of the Navy, the operation of any radio station would interfere with the receipt of signals by radio stations belonging to the United States or the government of the Philippine Islands, or by radio stations on shipboard, or would be otherwise prejudicial to the interests of the United States, no license under the Act entitled "An Act to regulate radio communication," approved August thirteenth, nineteen hundred and twelve, shall be issued to such station, and any such license already issued to such station shall be revoked or suspended for such time as the Secretary of the Navy may prescribe.

Sec. 8. That when any radio station is requisitioned, taken possession of temporarily or permanently, or closed, or its license revoked or suspended, the United States shall pay to the persons interested therein just compensation for the property or interest so taken, provided that a claim for such compensation is made on the Secretary of the Navy, within two years after the date of passage of this Act. In case of disagreement as to such just compensation, the Secretary of the Navy shall make an offer, and if such offer is not accepted there shall immediately be paid to the person interested three-quarters of the amount offered. The person interested shall be entitled to sue the United States to recover the balance justly due, in the manner provided by section twenty-four, paragraph twenty, and section one hundred and forty-five of the Judicial Code. An amount sufficient to pay such just compensation is hereby permanently appropriated out of any money in the Treasury not otherwise appropriated.

Sec. 9. That all radio stations taken possession of by the President shall be operated under the direction of the Secretary of the Navy.

Sec. 10. That the Secretary of the Navy shall, so far as may be consistent with the transactions of Government business, open naval radio stations to general public business under regulations prescribed by him and shall fix the rates for such service. He shall establish special rates for the handling of press dispatches by transoceanic or other special stations. The receipts from such services, less an amount not to exceed twenty-five per centum per annum for expenses, shall be turned into the Treasury as miscellaneous receipts.

BROWNING GUN SUCCESSFUL IN AIRPLANE PROPELLER TEST.

The Browning machine gun has successfully undergone a test to determine its value for use with aircraft. This is one of three types of machine guns with which the rate of fire can be so synchronized that the gun can be fired by the pilot of a combat plane thru the revolving blades. Firing in that fashion, it is necessary to aim the machine gun by steering the plane directly at the target. The direction of the plane gives direction to the fire and the pilot can fire the machine gun while controlling the plane.

Airplane propellers revolve at from 800 to 2,000 revolutions per minute. The machine gun is connected with the airplane engine by a mechanical, hydraulic or electrical device, and impulses from the crank shaft are transmitted to the machine gun. The rate of fire of the machine gun is constant, and its fire is synchronized with the revolving propeller blades by "wasting" a certain percentage of the impulses it receives from the airplane engine and by having the remaining impulses trip or pull the trigger, so that the gun fires just at the fraction of the second when the propeller blades are clear of the line of fire.

The pilot operates the gun by means of a lever which controls the circuit and allows the impulses to trip the trigger. It has occurred in practise that as many as 15 shots have hit the propeller without putting the plane out of commission.

A FAKE ELECTRIC PISTOL TO SCARE THIEVES.

A new electric flashlight pistol of French invention for scaring criminals not only displays a bright light when the trigger is pulled, but also makes a noise like a real weapon as well.

BOYS



Learn Drafting

The United States Government and employers everywhere are looking for skilled draftsmen. They are offering splendid salaries, and still good positions are always open, because thousands of draftsmen have gone into the service. Others must take their places and carry on their work.

No line offers greater opportunity for advancement. Drafting itself not only commands good pay, but it is the first step toward success in Mechanical or Structural Engineering or Architecture. And drafting is just the kind of work a boy likes to do. There is an easy delightful way in which you can learn right at home in spare time. For 27 years the International Correspondence Schools have been giving boys just the training they need for success in Drafting and more than 200 other subjects. Thousands of boys have stepped into good positions through I. C. S. help, but never were opportunities so great as now.

Let the I. C. S. help you. Choose the work you like best in the coupon, then mark and mail it. This doesn't obligate you in the least and will bring you information that may start you on a successful career. This is your chance. Don't let it slip by. Mark and mail this coupon now.

INTERNATIONAL CORRESPONDENCE SCHOOLS
BOX 6171, SCRANTON, PA.

Explain, without obligating me, how I can qualify for the position, or in the subject, before which I mark X.

- | | |
|---|---|
| <input type="checkbox"/> MECHANICAL DRAFTING | <input type="checkbox"/> SALESMANSHIP |
| <input type="checkbox"/> STRUCTURAL DRAFTING | <input type="checkbox"/> ADVERTISING |
| <input type="checkbox"/> SHIP DRAFTING | <input type="checkbox"/> Show Card Writer |
| <input type="checkbox"/> ELECTRICAL DRAFTING | <input type="checkbox"/> Sign Painter |
| <input type="checkbox"/> ARCHITECTURAL DRAFTING | <input type="checkbox"/> ILLUSTRATING |
| <input type="checkbox"/> SHEET METAL DRAFTING | <input type="checkbox"/> Cartooning |
| <input type="checkbox"/> ROLLER MAKER DRAFTING | <input type="checkbox"/> BOOKKEEPER |
| <input type="checkbox"/> BRIDGE DRAFTING | <input type="checkbox"/> Stenographer and Typist |
| <input type="checkbox"/> MACHINE DESIGN | <input type="checkbox"/> Cert. Public Accountant |
| <input type="checkbox"/> ELECTRICAL ENGINEER | <input type="checkbox"/> TRAFFIC MANAGER |
| <input type="checkbox"/> Electric Lighting and Hallways | <input type="checkbox"/> Railway Accountant |
| <input type="checkbox"/> Electric Wiring | <input type="checkbox"/> 6000 ENGLISH |
| <input type="checkbox"/> Telegraph Engineer | <input type="checkbox"/> Teacher |
| <input type="checkbox"/> Telephone Work | <input type="checkbox"/> Common School Subjects |
| <input type="checkbox"/> MECHANICAL ENGINEER | <input type="checkbox"/> Mathematics |
| <input type="checkbox"/> Machine Shop Practice | <input type="checkbox"/> CIVIL SERVICE |
| <input type="checkbox"/> Gas Engine Operating | <input type="checkbox"/> Railway Mail Clerk |
| <input type="checkbox"/> CIVIL ENGINEER | <input type="checkbox"/> AUTOMOBILE OPERATING |
| <input type="checkbox"/> Surveying and Mapping | <input type="checkbox"/> Auto Repairing |
| <input type="checkbox"/> STATIONARY ENGINEER | <input type="checkbox"/> PLUMBING AND HEATING |
| <input type="checkbox"/> Marine Engineer | <input type="checkbox"/> Textile Overseer or Supt. |
| <input type="checkbox"/> ARCHITECT | <input type="checkbox"/> CHEMIST |
| <input type="checkbox"/> Contractor and Builder | <input type="checkbox"/> Navigation <input type="checkbox"/> Spanish |
| <input type="checkbox"/> Concrete Builder | <input type="checkbox"/> AGRICULTURE <input type="checkbox"/> French |
| <input type="checkbox"/> Structural Engineer | <input type="checkbox"/> Poultry Raising <input type="checkbox"/> Italian |

Name _____
 Present Occupation _____
 Street and No. _____
 City _____ State _____

TELEGRAPHY AND RADIO

Day and Evening Classes in Radio for Army, Navy and Merchant Marine. Women in special "Radio Corps". Similar classes in TELEGRAPHY for men and women. Prepares for all branches of telegraph work.

EASTERN RADIO INSTITUTE
899B Boylston St. Boston, Mass.

BE AN ARTIST

CHECK FROM MAGAZINE



DRAWN BY 14-YEAR-OLD BOY

The above cartoon was drawn by Master Bob Brennan of the Washington School of Art. Bob writes that he is selling his work and that he is cartoonist on a small paper in Evansville, Ind. He is but one of our many students and graduates who are making money as cartoonists, illustrators and designers.

Learn By Mail at Home!

By our new method of teaching drawing by mail you can learn in your own home, in a short time. Get into this fascinating work yourself and earn \$50 to \$100 or more per week!

The study is fascinating. Only a few minutes a day! Have your own studio or secure high-salaried position. Or work in spare time. Many students earn while they are learning.

FREE! BOOK AND ARTISTS' OUTFIT WRITE TODAY

A complete outfit free to all students. Includes everything required to produce hundreds of dollars' worth of pictures. Write today. Special terms to a limited number of new students. Mail postal or letter for beautiful Booklet, "How to Become an Artist," filled with drawings and full particulars of our extraordinary offer. Do it now—before you forget.

WASHINGTON SCHOOL OF ART, Inc.
1391 H Street, N. W. Washington, D. C.

"I Would Not Part with it for \$10,000"

So writes an enthusiastic, grateful customer. In like manner testify over 100,000 people who have worn it. Conserve your body and life first.

The Natural Body Brace

Overcomes WEAKNESS and ORGANIC AILMENTS of WOMEN AND MEN. Develops erect, graceful figure.

Brings restful relief, comfort, ability to do things, health and strength.

Wear It 30 Days Free at Our Expense

Does away with the strain and pain of standing and walking; replaces and supports misplaced internal organs; reduces enlarged abdomen; straightens and strengthens the back; corrects stooping shoulders; develops lungs, chest and bust; relieves backache, curvatures, nervousness, ruptures, constipation. Comfortable and easy to wear.

Keep Yourself Fit

Write today for illustrated booklet, measurement blank, etc., and read our very liberal proposition.
HOWARD C. RASH, Pres. Natural Body Brace Co.
286 Rash Building SALINA, KANSAS



For Children Also

Don't Wear a Truss



C. E. BROOKS, 203B State Street, Marshall, Mich.

BROOKS' APPLIANCE, the modern scientific invention, the wonderful new discovery that relieves rupture will be sent on trial. No obnoxious springs or pads. Has automatic Air Cushions. Binds and draws the broken parts together as you would a broken limb. No salves. No lies. Durable, cheap.

Send on trial to prove it. Protected by U. S. Patents. Catalogue and measure blanks mailed free. Send name and address today.

STAMMERERS

You can be cured quickly, permanently and privately. Write me personally for free booklet, "How to Stop Stammering".
Samuel O. Robbins, Pres., Boston Stammerers' Institute, 248 Huntington Ave., Boston, Mass.

PHILA. TO BE BIGGEST ELECTRICAL CENTER.

Philadelphia is to be made the largest electrical center in the world after the declaration of peace, according to plans now being perfected by the Westinghouse engineers.

The largest of forty-one plants under the Westinghouse management will be located on the Tinicum township tract near Lester, in buildings now devoted to war purposes. Twenty-five thousand men will be employed at the plant. All goods will be shipped from piers to be erected on the tract.

Experimental Chemistry

(Continued from page 639)

Chemical Properties.

1. *Yellow phosphorous* possesses great affinity for many of the elements, uniting with all directly, except nitrogen and Carbon. With Bromin and Sulfur it reacts violently. Characteristic is its affinity for Oxygen. When exposed to the air at 40° C. or at a lower temperature, if in a finely divided state, ignition takes place, burning to Phosphoric acid, according to the supply of oxygen present.

2. It is luminiscent in the dark, even the minute particles adhering to the fingers on handling matches.

3. Because of its great affinity for oxygen, phosphorous is an energetic reducing agent. Sulfuric acid is reduced to Sulfur dioxide. Nitric Acid is deoxidized with explosive violence, salts of the metals are reduced to their metals and phosphides, thus silver nitrate is reduced to Silver and Ag₃P, Copper sulfate to Cu₃P₄.

Red Phosphorous. Properties. 1. This is an *allotropic* modification, and possesses properties essentially different from the yellow variety. It forms a dark red to reddish-brown powder, which is insoluble in carbon disulfid and all other solvents. It does not phosphoresce, and is stable in the air. It does not fuse at red heat, but when quickly heated above 260° C. the vapors change to those of yellow phosphorous. This variety is prepared by heating the yellow variety to 300° C. in closed air-tight vessels, and after the conversion, the product is then treated with carbon disulfid to remove any of the unchanged phosphorous. If a little iodine is added, this change will take place below 200° C.

Scarlet Phosphorous. Properties. This is another modification, being obtained by boiling a solution of yellow phosphorous in phosphorous tribromid. It resembles the red variety except that it is more active, reducing salts of the metals, and with the alkalis, it yields *phosphin* [PH₃] and a *hyposulfite*.

Metallic Phosphorous. Properties. This form is obtained by heating the yellow variety in a sealed tube free from air to 530° C. It thus forms black metallic shining crystals, which are less active than the red variety.

Luminescence or Phosphorescence.

If a match is scratched in a dark room, a faint line of light may be observed as the minute particles of phosphorous which are left glow and oxidize. The same thing occurs if the element is exposed in darkness, and the phenomenon is called **PHOSPHORESCENCE**. It is due to slow combustion [or oxidation]. Substances rubbed with phosphorous give the same effect.

Many other minerals and chemical compounds have the power to emit light in darkness, and some of these form the basis of the so-called luminous paints. The sulfides of Barium, BaS, Ba₂S, Ba₃S, etc., are examples.

Some animals, as fireflies, glowworms, etc cetera, emit a light from a certain part of

the body, without heat above that of the rest of the body. In Cuba, a species of luminiscent insect is bottled up and used sometimes for lighting purposes, about *forty* of these equalling *one candle-power*. The light is apparently due to an oxidation of animal tissue which is under the control of the insect. To produce the same light by the oxidation of gas or oil, we have a temperature of about 2,000° F. and 99% of the energy of the flame is lost, while these creatures utilize possibly 100% of the energy of oxidation, without any apparent rise in temperature. The animal supplies its own light.

Uses.

Phosphorous is used mostly in the manufacture of matches. A kilogram (2.2 lbs.) of it will tip about *two million matches*. It is also used to some extent for medicinal purposes.

Matches.

The making of matches after the splints are prepared includes two processes. First, one end is dipped into melted sulfur, some of which adheres to the wood. Second, it is tipped with a paste consisting of a mixture of phosphorous, an oxidizing agent, and glue. A little coloring matter is quite frequently added. The oxidizing agent may be Potassium chlorat [in which case the match snaps and burns vigorously on being scratched], potassium nitrat, Manganese dioxide, or red lead [Pb₃O₄]. This result is accomplished by pressing the end on a slate slab covered with the paste. Sulfur is necessary, as the heat liberated in the burning of phosphorous is not enough to set the wood on fire, and a coating of P₂O₅ forms over it. Sometimes paraffin is utilized in place of the sulfur. The well-known Swedish [or Safety] match head does not contain phosphorous, but consists of a mixture of potassium chlorat and dichromat with red oxide of lead and antimony sulfid. They are ignited by scratching them on the prepared surface of the box, which is essentially a mixture of red phosphorous, antimony sulfid and powdered silica. A machine has been constructed to cut the splints, tip the matches, and dry and pack them in boxes, all four processes being automatic and continuous, besides eliminating the poisonous fumes.

A Burning Match.

Whenever one ignites so simple and common a thing as an ordinary match, little does he realize that he is performing one of the most wonderful and complicated of chemical experiments. The mere fact that fire could be obtained by simply scratching the end of a stick was regarded less than three-quarters of a century ago, as a truly remarkable triumph of science.

Friction on the end of a match over a rough surface liberates heat enough to cause the phosphorous to unite with the oxygen of the oxidizing agent in the paste, and produce combustion, the main product of which is P₂O₅. If the oxidizer is potassium

chlorat, then potassium chlorid is left. The heat of the burning phosphorous is enough to set fire to the sulfur, which unites with the oxygen of the air to form sulfur dioxide, and this in turn sets the wood on fire.

The reactions of a burning match are many. Try and complete the following and explain from what each comes, then the next time you strike a match you will probably stop to think of the complicated change which takes place. This only goes to illustrate that many seemingly unimportant operations made during our daily routines may, if carefully analyzed, show the complicated changes which take place unobserved.

1. $KClO_3 = ?$
2. $2P + 5O = ?$
3. $2P + 3O = ?$
4. $P_2O_5 + H_2O = ?$
5. $P_2O_5 + 3H_2O = ?$
6. $P_2O_5 + H_2O = ?$
7. $P_2O_5 + 3H_2O = ?$
8. $S + 2O = ?$
9. $SO_2 + H_2O = ?$
10. $C + O = ?$
11. $C + 2O = ?$
12. $CO_2 + H_2O = ?$
13. $2H + O = ?$

Phosphates.

Wheat contains compounds of phosphorous, and most food plants in order to come to fruitage must take phosphates from the soil in which they grow. The phosphates must be soluble, so that, as the rain dissolves it, it can be absorbed by the roots and circulated in the sap of the plant. Soils have to be renewed or fertilized, and fertilizers contain, among other things, the soluble phosphate $H_2Ca[PO_4]_2$, made according to the first step in reducing the element. This is absorbed, transformed, and assimilated by the plant, especially the fruit.

Animals eat the fruit, and thus the compounds of phosphorous are again transposed, circulated in the system, and deposited wherever needed, as in the bones and nervous tissues, and especially in the brain. Man feeds upon either plant or animal, and thus obtains his phosphorous. From the human system it is excreted by means of the blood and kidneys, as phosphates and microcosmic salt $[HNANH_2PO_4]$. When the brain is hard worked, more than usual is excreted;—in fact, there seems to be a direct ratio between the amount excreted and the vigor of brain action, as the each intellectual effort was attended by the combustion of phosphorous. A simple test of the urine will demonstrate this. At the start of the day the urine will, under normal conditions, appear clear yellow. Examine a sample of urine from the same subject taken after a hard day's brain work, and you will be surprised to see many little white specks floating about. This represents the phosphates, and while the laboring man may show but little, if any, of these suspended phosphates in the urine at the end of a working day, the brain worker will invariably manifest this condition regularly. To clear the urine in order to test it for any solids or sediment, add a little nitric acid. It will clear up perfectly if the urine is normal.

Experiment No. 147.

Place about 12 heads of ordinary (not safety) matches in a flask, as shown in Fig. 155. Have this flask (1) about half filled with water. Proceed to distill the same by applying the Bunsen burner under the flask, taking care that the action does not become too violent.

If this experiment is performed in a darkened room a ring of greenish light appears at the level of the water in the condenser, where the steam condenses. After a short time little colorless spheres of a waxy solid collect under the water in the second flask, which acts as a receiver for the drippings from the condenser. If the water is poured away, this solid begins to give off a white smoke, and is luminous in the dark.

(To be continued)

Learn to Treat Disease This Way

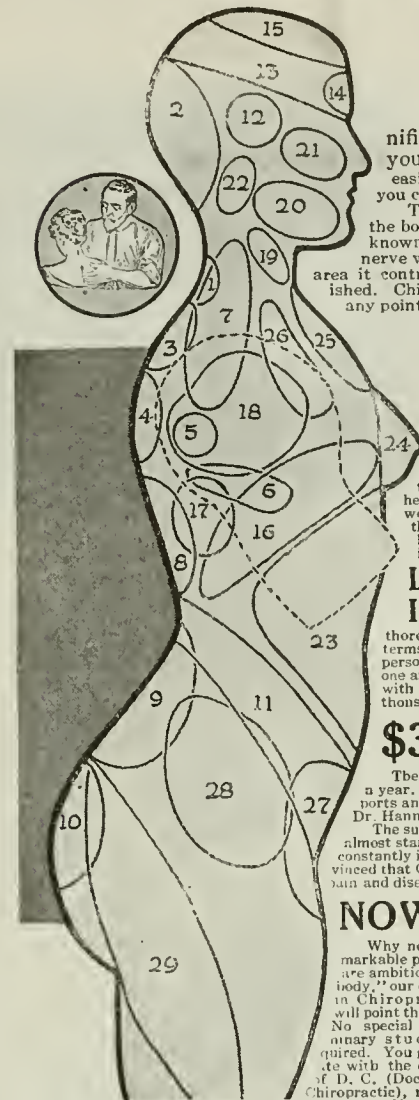

This is a small reproduction of one of 22 magnificent charts all of which we want to send you **ABSOLUTELY FREE**, just to show you how easily you can master Chiropractic and how successfully you can treat disease by this modern drugless healing method. These charts show the different pain and nerve areas of the body. The science of Chiropractic is based upon the well known principle that when there is bone pressure on a trunk nerve where it leaves the spinal column there will be pain in the area it controls; and that by relieving the pressure the pain is banished. Chiropractic teaches you how to locate nerve pressure at any point along the spinal column and how to relieve it.

BE A DOCTOR OF CHIROPRACTIC

Advanced Science of Spinal Adjustment

The great profession that within the past few years has taken the longest forward strides ever known in the history of drugless healing. It has called to its ranks thousands of ambitious men and women from every walk of life. Today it is calling more insistently than ever because the tide has turned strongly in favor of drugless healing. Right now the demand for Doctors of Chiropractic is far greater than the supply.

Learn at Home In Spare Time

The American University method of teaching enables you to study by mail or in class and obtain a complete mastery of Chiropractic in the shortest time consistent with thoroughness, while you hold your position. You can pay on easy terms. From the day you enroll your instruction will be under the personal direction of a splendid faculty of Chiropractic experts. Our one aim will be to make you successful. We will work whole-heartedly with you to advance your interests so that in a short time you, like thousands of Chiropractors, can earn a good income.

\$3000 to \$5000 a Year

There are many instances of Chiropractors earning from \$3000 to \$5000 a year. Some upwards of \$10,000. Dr. M. D. Moore, of Kentucky, reports an income of \$9,000 a year. Dr. L. H. Roche, New Jersey, \$5,000; Dr. Hanna, of Kentucky, over \$5,000 yearly. The success of Chiropractors in many cases has come so quickly as to be almost startling. And yet, it is not to be wondered at when you consider the constantly increasing number of intelligent, thinking people who are now convinced that Chiropractic is the common-sense and really scientific way to relieve pain and disease and who, therefore, demand the services of Chiropractors.

NOW—Your Great Opportunity

Why not qualify now for this splendid profession that offers such remarkable possibilities for making you prosperous and independent? If you are ambitious to make money, increase your social standing and be "somebody," our course in Chiropractic will point the way. No special preliminary study required. You graduate with the degree of D. C. (Doctor of Chiropractic), receive handsome diploma, FREE, and are ready at once to open your office.

AMERICAN UNIVERSITY

Manierre Bldg., Dept. 372 Chicago, Ill.

Without cost or obligation send me by mail, your new illustrated, 72-page book and your Free Charts offer.

Name.....

Street No. or R.F.D.....

City.....State.....

Get Free Charts offer at once. Regular value of the 22 magnificent charts is \$31.50. Many of these charts are handsomely lithographed in life-like colors. Mail coupon and get all the facts. We will send you our beautiful new illustrated book, full particulars regarding course, easy terms, together with free charts offer immediately. Don't put it off—mail coupon or send your name on a postal card—today.

AMERICAN UNIVERSITY
Manierre Bldg., Dept. 372 Chicago, Ill.

1/4 H.P., 110 volts, A.C. 60 cycle, single phase, 1750 R.P.M.

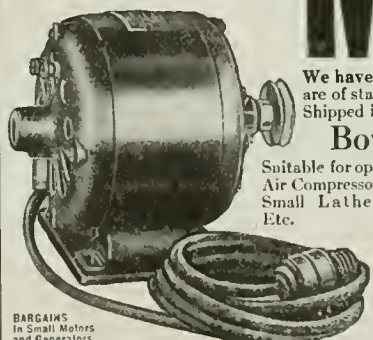

MOTORS

We have 1000 NEW WASHING MACHINE MOTORS. These are of standard manufacture and carry the regular factory guarantee. Shipped in original boxes. Complete as cnt.

Bought from Bankruptcy Stock

Suitable for operating Coffee Grinders, Cream Separators, Bottle Washers, Air Compressors, Small Lathes, Etc.

Mail \$3.00 cash or Money Order. We will send C.O.D. subject to full examination MONEY BACK GUARANTEE

\$18.50 EACH

Special Quantity Prices Regular Value \$34 MANUFACTURERS' DISTRIBUTOR

GHAS. H. JOHNSTON - West End - Pittsburgh, Pa.

HEL-MET THE KAISER



Send one to your boy in camp; all the boys will want them. Anyone against the Kaiser or Germany should wear this pin. Same size as picture. Handsome metal, black letters. Will wear for years. Men and women wear them—causes laughter wherever seen.

Price 10 Cents

Voice Thrower 10c

Learn to throw your voice into a TRUNK, under the bed, out in the hall or anywhere. Lots of FUN fooling the Teacher, Janitor, Policeman, Parents, Neighbors, or Friends.

THE VENTRILO

is a little instrument that fits into the mouth out of sight. BOYS or GIRLS can use it. NEVER FAILS! A 32-page book on Ventriloquism sent with the VENTRILO for TEN Cents.

NEW FORD JOKE BOOK 1919

All the latest jokes on the Ford auto. Hundreds of them, and all good ones. Spring a new one on your neighbors. Large book with colored cover by mail, 10c.

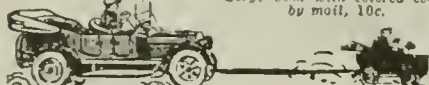

Devil Resigns to the Kaiser



Everyone who reads this book is wild over it. Contains the following:—The Kaiser's Dream, A Letter from the Devil to the Kaiser, Kaiser's Prayer, How Satan Resigns to the King of Devils, The Kaiser, etc. any other stories, jokes, etc., about the German Emperor. Book mailed 10 cents, postage 2 cents extra.

ROGEN X-RAY

Price 10 Cents

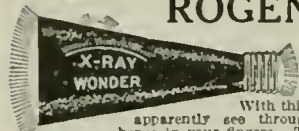

HERE, BOYS, is just what you want. With this instrument you can apparently see through clothes, see the bones in your fingers. Think of the fun you can have with it! Sample, by mail, TEN CENTS.

SKULL RING



Here is a handsome, up-to-date Ring, representing a Skull and Cross-bones. Has stones in the eyes and looks something frightful. Women won't like it, but for men or boys it is a great novelty. Sample, by mail, 15c.

Gee! What a Wad!

This is STAGE MONEY



Looks like the GENUINE STUFF. Some Green backs and some Yellow backs. Create a BIG sensation among your friends. The girls will all be after you when they see the wad. BIG roll of 15 pieces by mail, 10 cents.

Boys Own Toy Maker

and Nine Other Books for 10c
Tells how to make a Telephone, Magic Lantern, Kites, Sail Boat, Sults, Electric Telegraph, Pop Gun, Red Fire, Galvanic Battery and many other things. This book, with nine other interesting books, mailed for 10c.



ENCHANTED BARREL

The Most Wonderful Pocket Trick Made CHANGE A CENT INTO A DIME



Ask your friend to drop a dime in the barrel. When he takes it out, behold! It is a CENT. You make 9 cents every time you fool them. Never fails. They cannot get on to it. Sample barrel, with directions, only... 10c

Any three of the above articles for 25c or any six for 50c

Royal Novelty Co. 250 EAST AVENUE SOUTH NORWALK, CONN

110 VOLT A. C. GENERATORS ONLY \$5.00!

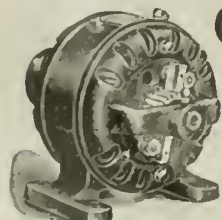

Holtzer-Cabot hand generators, while stock lasts, \$5.00. Order today.

Battery chargers, 6 v. 6amp. \$10.00; 7 v. 11 amp. (like cut) \$27.00; Hydro-Electric Generator complete, giving up to 25 v. 3 1/2 amp. D.C. \$25.00. Immediate shipment while stock lasts. Order from this ad.

Watson Electric Co., Dept. 11, Gas Bldg., Chicago

POPULAR ASTRONOMY.

(Continued from page 621)

There is the possibility that forms of life may exist on these satellites of Jupiter, tho they may, on the other hand, be barren, lifeless worlds, such as Mercury and the Moon. Their great distance from the

highly heated interior and spread out into belts parallel to the equator and in the direction of the planet's rotation. From its nearest satellite all the interesting changes of color and form that constantly take place in the atmosphere of this great globe could be observed in great detail.

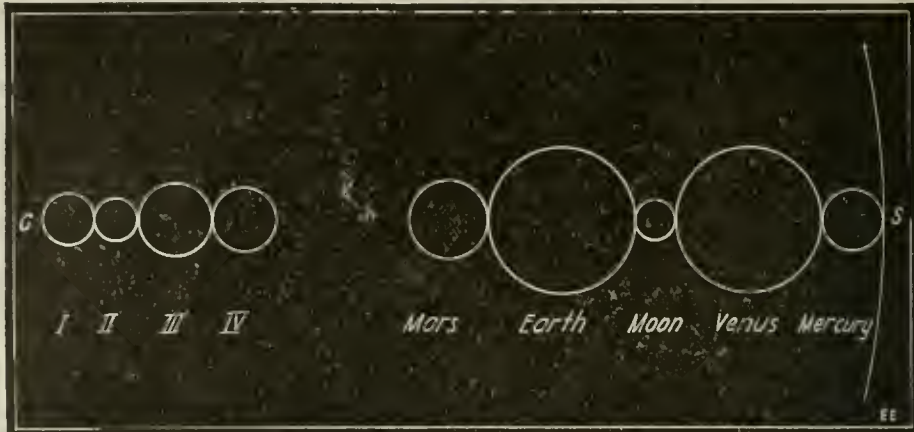

Diagram 1.—Showing the Relative Sizes of the Four Moons of Jupiter, Io, Europa, Ganymede and Callisto, or Satellites I, II, III and IV Respectively, and the Moon and Terrestrial Planets Mercury, Venus, Earth and Mars. The Distance from C to S is the Distance from the "Center" to the "Surface" of Jupiter. So if All the Satellites of the Planet and the Terrestrial Planets and Moon Were Placed Side by Side Their Combined Diameters Would Fall Short of the Surface of the Planet by a Distance About Equal to the Diameter of the Earth.

earth, never less than three hundred and sixty-eight million miles, makes observations of their surface markings very difficult.

How beautiful beyond description must the heavens appear as viewed from the satellites of Jupiter! From the nearest of these, Io, or Satellite I, the mighty planet Jupiter presents a spectacle such as the eye of man has never been privileged to behold. The huge flattened globe, ninety thousand miles in equatorial diameter, equal in mass to three hundred planets such as our own and in volume to nearly fourteen hundred, fills a space in the heavens nearly twenty degrees in extent as viewed from this satellite. Fifteen hundred of our own full moons would hardly fill the same space. Whirling on its axis with frightful speed in a period of less than ten hours, the huge ball glides rapidly but majestically onward thru the sky. A far distant sun shrunk to but one-fifth the diameter of the full moon throws light and shade across the rapidly-changing surface of the planet, rich in the reds, browns and yellows and all the gorgeous shades and tints of its dense, seething, gaseous envelope. The phases of the moon on a greatly enlarged scale rapidly succeed each other on Jupiter as the satellite views it from all positions with reference to the sun. The cause of the belts of Jupiter, that lie parallel to the planet's equator and are constantly changing in number, width and shade, as well as of all the peculiar splashes of color and intensely white flecks that come and go in the dense atmosphere of the planet, could doubtless be explained were it possible to view the great planet from its nearest satellite, which is about as far from the surface of Jupiter as the moon is from the earth. It is uncertain whether the planet is entirely gaseous thruout or has a central core of solid or liquid matter. Its density is only one and one-quarter that of water and slightly less than that of the sun, showing that it is composed largely, if not entirely, of matter in a gaseous state. Jupiter is a world as different from our own as it is possible to imagine. There is no visible surface crust and there are no permanent markings. Different spots on the planet's disk give different periods of rotation showing that atmospheric phenomena are observed. All is constant flux and change. Dense vapors arise from a

The high percentage of light and heat that Jupiter reflects from the sun to its nearer satellites would make it a secondary sun to them of tremendous size but feeble strength. As seen from the nearest moon the other three major moons of Jupiter present all the phases of our own moon in rapid succession, due to their constantly changing positions with reference to the sun. The five small moons, discovered in modern times, are so minute that they are simply star-like points of light even when viewed from the other moons of Jupiter.

When nearest each other some of the moons appear even larger than our own moon does to us, but when approaching opposite sides of the planet their disks rapidly diminish in size tho they never appear as small as the far distant sun nearly five hundred million miles away whose apparent diameter is less than one-fifth that of the full moon.

To keep track of the rapidly changing positions and various phases of the moons of Jupiter as seen from any one of them,



Diagram 2.—Orbits of the Four Old Satellites of Jupiter, and Satellite V, the First to be Discovered of the New Moons. Satellites VI and VII Are Nearly Seven Times More Distant and Satellites VIII and IX Nearly Fourteen Times More Distant Than Satellite IV. The Period of Revolution of Satellite V is 12 hours and of Satellite IX 3 Years. Scale .5 Cm. = 200,000 Miles.

NEW SCIENTIFIC WONDER
"X-RAY" CURIO
 PRICE **12 C.** SILVER ONLY. **BIG FUN BOYS**
 You apparently see thru Clothes, Wood, Stone, any object. See Bones in Flesh. A Magic Trick Novelty given FREE with each X-Ray. MARVEL MFG. CO., Dept. 52, New Haven, Conn.



\$500 REWARD
 We will pay \$500.00 reward to anyone who can permanently dim the brilliancy of the RAJAH Im. Diamond without destroying it.
 RAJAH Im. Diamonds
 They stand all diamond tests—fire, acid, file and glass cutting. Their brilliancy is eternal. Guaranteed for a lifetime. Set in solid gold, and sent to you on **30 DAYS' FREE TRIAL** if you can tell it from a real diamond return it. Send today for our beautiful, FREE illustrated jewelry catalog in colors. Write now. KRAUTH & REED, 159 N. State St., Dept. 200, CHICAGO, ILL.



You Can Secure a Motor-Cycle at Little Cost
 by mounting a STEFFEY motor on your bicycle.
 They are best made, most reliable and best hill climbers. We sell you the complete attachment at a low manufacturer's price, or we can supply the finished parts from which you can assemble the motor yourself. Instructions and full size blueprints of drawings, 25c.
 STEFFEY MFG. CO., 5025 W. Brown St., Phila., Pa.



110 V. TRANSFORMER
8 Volts Secondary ONLY \$1.00
 A reliable transformer for all experimental work, ringing bells, etc. Consumes so little power it will not move ordinary meter. \$1.00, postpaid. Cord and plug, 50c extra.
 Transformer No. 10, giving 8, 12 and 18 volts secondary, with plug, \$2.00 postpaid. Order from this ad.
EMPIRE TRANSFORMER CO.
 Dept. 11 2214 Sedgwick St., CHICAGO

PLUS
Be an Accountant— Step Into the Job Higher Up Through Accountancy
Our Free Book, "Stories of Success"
 shows how the I.A.S. intensive home-study course prepared many for the bigger job and how they got it. Low tuition; easy terms; quick results; simple, efficient method.
International Accountants Society
 624 So. Michigan Ave. Dept 39-A Chicago Ill.

EVERY INVENTOR
 should have this book. "PATENTS AND PATENT POSSIBILITIES." It is chock full of ideas and practical advice, telling what to invent and where to sell. Write for your copy today. IT IS FREE.
 I have requests for patents upon sound inventions of all kinds. Can you help supply the demand?
 My service is individual, prompt and efficient (14 years experience). Every expedient is employed to secure patents at least possible cost.
H. S. HILL, 804 McLachlan Bldg., Washington, D. C.



STAMPS
 50 diff. Belgium (large bi-color) China, Jamaica, Portugal, Venezuela, etc., 10c; 1,000 well mixed, 40c; 100 var. U. S., 50c; 1,000 hinges, 10c; Agts. wanted, 50%. List free. I buy stamps. L. B. Dover, Overland, Mo.

INDEX TO ELECTRICAL EXPERIMENTER SCIENCE & INVENTION
 FOR VOLUME 1, 2, 3, 4, 5
 This index contains 24 pages and shows every article of interest that has been published since the inception of the magazine up and including April, 1918.
 It is absolutely indispensable to everybody interested in any kind of electrical research work. With it everything of importance in the advancement of electrical science during the last five years can be readily found.
 Price **15c.** Postpaid
EXPERIMENTER PUBLISHING CO.
 Book Dept. 231 Fulton St., N.Y.

as well as the rapid apparent motion of the planet thru the sky due to the revolutions of the satellite itself, would be a troublesome task for an astronomer stationed on one of these far distant worlds. It would be a common sight to see in the sky at one time the huge planet, the sun itself, and one, two or three moons. Seen from the moons of Jupiter the constellations would appear as they do to us on earth for such a slight change in position as five hundred million miles, more or less, is trivial when one is measuring the relative distances of the stars. Observations of the stars from the nearest moon of Jupiter would be attended with difficulties at times, however, since reflected sunlight from a body nearly twenty degrees in diameter would be extremely troublesome, especially were the phases of the planet near that of the full moon. Even from the fourth or most distant of the major satellites the planet would subtend an angle of nearly five degrees. Occultations of the stars would be many and frequent as the huge planet globe glides swiftly thru the heavens. Many a moonlight night would appear almost as day owing to the presence of the enormous brilliantly reflecting ball of light and occasionally two or three moons in addition. Only the brightest stars would be seen under such circumstances. When, however, the small worlds pass into the shadow of the great mother planet and not only the light of the sun but also the reflected light of Jupiter disappears for many minutes the stars shine forth in all their glory there as here. In the sky would appear, possibly, some of the larger moons feebly shining by the reflected light of the far distant sun. Saturn also might be visible, but beautiful Venus and ruddy Mars would fail to appear. Tiny bodies, mere specks of light at this distance, they are lost to view in the glare of the sun.

(The next installment will appear in an early issue.)

ELECTRIC DEATH TRAPS IN HUN'S RETREAT.

(Continued from page 608)

to blow the cave to pieces, and which was connected up with an electric device to the time-clock also. Thus did the Boches not only hope to gas their victims, but to kill them as well, one way or the other.

The daily press had considerable to say in the later months of the war concerning the many devilish and ingenious *delayed time-fuse bombs* which were left behind in many of the towns and cities of northern France as the Hun army was being driven toward the Rhine by General Foch's victorious armies. One of the simple devices of this nature, which was used to blow up buildings, etc., a considerable length of time after the Huns had retreated from a certain locality, is shown in Fig. 10. It comprised nothing more than a float tank similar to those used on all modern plumbing for flushing purposes. As soon as it started to rain, such weather being frequent in northern France, the tank filled up and caused the float to rise. When the float ball reached its uppermost position it closed an electric circuit, connected by wires running inside the building, to a heavy charge of explosive, with results that can be better imagined than described. These cowardly and dastardly tricks sound quite tame and harmless when you read them "Over Here,"—but imagine what havoc and untold death they have spread "Over There," where it often happened that troops had occupied a town for several days before some of these delayed time fuses functioned at unexpected moments!

NEW LIFE!
 Health-Strength-Beauty
 You can have bodily vigor, success-attaining energy— attractive healthful beauty! All yours at *practically no cost*—the great benefits of the famous **VIOLET RAY TREATMENTS** heretofore only procurable at big expense from Physicians and Beauty Specialists. **TREAT YOURSELF** at home with



Renulife Violet Ray HIGH FREQUENCY GENERATOR

transforms electricity into the most powerful, effective, purifying Health and Beauty giving agency known to science, yet gentle, soothing, perfectly safe—no shock nor pain. Eradicates disease from blood, flesh, bone and nerves; tones and restores. While relieving pains and aches and the manifest results of disorders, it removes the deep seated cause. Saturates the system with invigorating, life-laden violet rays bringing back normal functioning.

- TREATS Successfully**
 Rheumatism
 Neuritis
 Lumbago
 Chest Pains
 Catarrh
 Headache
 Ear Diseases
 Hardening of Arteries
 Wrinkles
 Skin Diseases
 Falling Hair
 Etc., Etc.



Treatment for general debility, nervousness, etc.



Quick relief for rheumatism



Inhaling ozone. For Catarrh, throat and lungs. Marvelous local results with general tonic effect.

Painless Electricity

Science has modified electricity that the weakest may stand its force without fear or pain. Every tissue and fibre is saturated, patient experiencing only a sensation of relief, as if standing in a ray of sunshine. *Violet Ray high frequency* has no comparison with old, crude, electrical batteries and shocking current. Every jar and shock is removed. The effects are marvelously rapid.

Lowest Priced—Most Effective

Violet Ray For Home Use

Every person would be wonderfully benefited by a few minutes' daily use. Its astonishing low price places it within the reach of all. Write at once for full information regarding uses, benefits, price, etc.

Liberal Trial Plan Proves Value

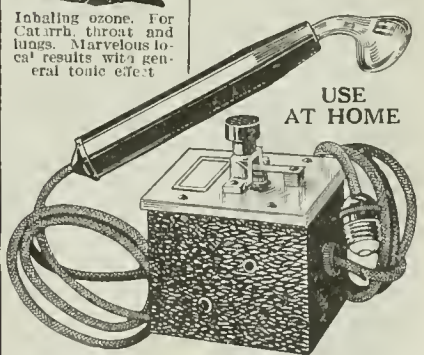

GET FREE BOOK telling the whole marvelous story of the Violet Ray. Its wonderful successes—its many uses—specified by physicians for rheumatism, neuritis, headache, catarrh, wrinkles, blemishes, falling hair and 100 other bodily ailments and beauty defects, chronic and acute. Get this valuable book by return mail.

RENULIFE ELECTRIC CO.
 532 Marquette Bldg. Detroit

Wanted: Representatives to demonstrate to physicians and individuals. Fine money making opportunity.

STOP SNUFFLING!

Sneezing, hawking, spitting and coughing. Why do you have catarrh anyway? You were not born with catarrh—you contracted it. This offensive, unwholesome, disagreeable complaint fastened itself upon you and grew. Nature is trying to prevent more serious consequences due to the congestion in your body, finds an outlet for the accumulated waste, by way of catarrh. You cannot get rid of it the way you are going—sprays, lotions, snuffing powders, drugs and medicines won't stop it. You know catarrh leads to other troubles—serious ones—throat, lungs, stomach, intestines—all become affected. You can never enjoy good health if you have catarrh; you won't be efficient in anything as long as you have catarrh, and it detracts from your personality to be hawking and snuffing around others.



Strongfort
The Perfect Man

Be Clean—Wholesome—Healthy—Virile. Go at it the right way. Nature's way: no drugs, no medicines, and you banish catarrh from your system. Let me show you how, by my method of health building, body developing called

STRONGFORTISM

Its practice never fails—it builds new tissue, gives brawn and muscle, it invigorates heart action, strengthens kidneys, and makes the bowels move by their own natural strength. It makes every organ in your body pulsate to health. Under this kind of influence, catarrh quits for good, so will constipation, indigestion, nervousness, palpitation, rupture, rheumatism, weak heart, poor memory, physical weakness, vital losses, short wind, and all sorts and kinds of ailments and disorders. If you are too stout or too thin, fat chested, or round shouldered—Strongfortism will alter it. It will make you grow in vigor and virility—and nervous energy—it will restore your vitality and keep your forces vital. No matter what your condition is now, or what habits you contracted or indulged in—I will show that you can renew yourself. You want to be strong, healthy—a virile man—you want to be all that a man ought to be and I can and will show you how to make yourself the man that is desirable from every standpoint.

Tell me your ailment and send three 2-cent stamps to cover mailing expenses, and I will send you my book, "PROMOTION AND CONSERVATION OF HEALTH, STRENGTH AND MENTAL ENERGY," written for your interest and welfare.

LIONEL STRONGFORT

Physical and Health Specialist
735 Park Bldg. Newark, N. J.

Skinderviken Transmitter Button

Nothing like it on the market. Will make an old transmitter better than new. Adjusted in a jiffy. Supersensitive. Talks at all angles. See our ad in the December or coming February number for innumerable uses to which it can be put.
Price \$1.00 each. Discount in quantities.
Send us One Dollar, for which we will mail one button prepaid under our money-back guarantee.
Booklet No. 3 free for the asking

Skinderviken Telephone Equipment Co.
For your convenience in writing us, address
STECO 2134 Clark St., Chicago, Ill.

DO YOU WANT A Wonderful Muscular Development,

with perfect health, abundance of vitality and great strength? You can get all the above, if you want them, and I can show you how. The results of my system are shown on my own person, and that is recommendation enough. I have prepared a booklet, illustrated with photographs of myself, which will tell you how you can obtain a development the same as I did. The name of it is "Muscular Development" GET IT—it will interest and benefit you. A copy of this instructive and illustrated booklet will be sent you upon receipt of 10¢—stamps or coin.

EARLE E. LIEDERMAN
Why not look as healthy and be as strong as I am?

EARLE LIEDERMAN, Dept. 204, 203 Broadway, New York City

TYPEWRITERS

ALL MAKES. SAVE \$25 TO \$50 on rebuilt by the well-known "Young Process." Sold for low cash—installment or rented. Rental applies on purchase price. Write for full details and guarantee. Free trial.

Young Typewriter Co., Dept. 659, Chicago

EXPERIMENTAL MECHANICS.

(Continued from page 638)

secured to the saddle. The circle should be marked with a sharp scriber where the boring is to be done, also its final diameter. By bringing the work forward to the sharp point of the scriber which is attached to the boring rod, and slowly revolving said boring rod, the scriber making the proper mark, this will aid in boring the hole to the proper diameter. At the same time you can see whether the work is secured to the saddle with respect to the central line of the cutting tool, also live and dead centers. The cutting tool is held on block T. H., or tool holder, and is secured to the boring rod by a set screw. The boring rod is run between the centers and firmly attached to the live spindle by means of a lathe dog D to the face plate.

The novice can construct a very simple form of boring cutter, such as that shown in Fig. 4. This consists of the usual boring rod, B. R., which may be of any desired length, depending on the character of the work. The rod should be made of tool steel, heavy enough to prevent its springing or bending when used in boring. The longer the rod, the greater the chance of springing. It is therefore advisable to make the rod as short as possible. A one-half inch hole is made in the center of the boring rod, which is used to secure the cutting tool. This is about the size cutting tool that the novice will need in his work. Another hole is drilled at right angles to this one with a one-quarter inch drill and tapped for No. 18-5/16 inch thread. A headless set screw is threaded in, a saw cut being made on the outer end in order that it may be screwed in with a screw driver. The cutting tool should be made of the highest grade, self-hardening tool steel. Its length should not exceed one-half inch, the diameter of the boring rod. The cutting side of the tool is ground as indicated in Fig. 4, its bottom edge being slightly rounded, so that it will be prevented from chipping or breaking.

In boring a hole in cast iron, it will be found advisable to start with a heavy cut. This is done so that the sand or other silica particles that may have adhered to the cast iron when taken from the mould are immediately removed.

In the forthcoming issue the subject of "Taper Cutting" will be considered.
(To be continued)

Madrid gets its electricity for lighting and power from a hydro-electric plant 120 miles from the city.

A company in Japan has begun the production of soda by an electrical process.

Electrically operated cash carriers for stores have been invented, the motors of which are supplied with current thru the wires on which they run.

EXPERIMENTAL PHYSICS.

(Continued from page 626)

sisted of negatively charged particles, remembering that an electric current is an electric charge in motion, and that an electric current tends to move in an electric field in a direction given by the three-finger motor rule (see Lesson 16). Hence, our present belief that the cathode rays are negatively charged electrons. The fact that these rays give a negative charge to bodies on which they fall doubly strengthens the theory. The deflectibility of the cathode rays in magnetic and electric fields furnishes us with the necessary data for computing the size, weight, and speed of the electron. The size and weight is extremely small, the speed tremendously large (about 100,000 miles per second).

Experiment 108.

In 1895, Roentgen while working with cathode rays found that a photographic

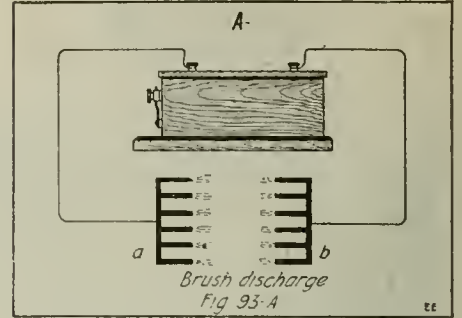

A Brush Discharge is Composed of Many Fine Sparks, Forming an Effluve.

plate which he happened to have near the cathode ray tube blackened on development, just as if it had been exposed to light. On investigating, he found that a radiation outside the tube always accompanies the production of cathode rays. These radiations differ in many ways from cathode rays and are called Roentgen (or Röntgen) rays after their discoverer, also X-rays, the name given to them by their discoverer. These rays result from the sudden stopping of the cathode ray. The kinetic energy of the cathode ray when suddenly stopt by encountering an obstruction produces an electromagnetic disturbance which travels outward from the suddenly arrested particle.

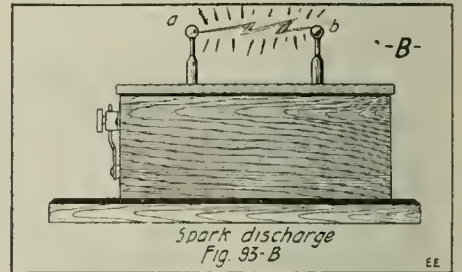

A Simple Spark Discharge from an Induction Coil.

The velocity of the X-ray is found to be the same as that of light. For the production of concentrated X-rays, a special form (the focus tube) of cathode ray tube is used (see Fig. 97a). Cathode rays coming from the concave spherical surface c converge and strike platinum plate P, where X-rays are generated which radiate in a hemisphere as illustrated in diagram.

By moving a zinc sulfid screen around the tube, we find that the X-rays cause fluorescence. If the hand or some other object is placed on a photographic plate and X-rays are allowed to strike the plate, a short exposure will give an X-ray photograph (see Fig. 97b), because of the ability of X-rays to penetrate many substances opaque to light. This makes possible the photographing of interior parts of the human body for diagnosis. X-rays are similar to cathode rays in that they cannot be re-

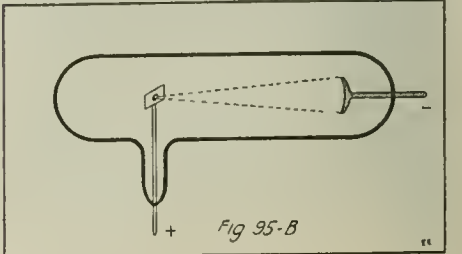

Fig. 95-B. The Cathode is Concave and Spherical. The Anode Consists of a Small Piece of Very Thin Platinum. The Cathode Rays Are Converged, Focus on the Platinum and Are Therefore very Concentrated. The Platinum Incandescences, Thus Showing the "Heating Effect" of the Cathode Rays.

flected or refracted as light can, but they are different in many important respects. X-rays penetrate many substances which cathode rays cannot (X-rays pass right thru glass, whereas the cathode rays do not). X-rays cannot be deflected by electric or magnetic fields and hence cannot, like cathode rays, consist of electrically charged particles. The real nature of X-rays is still unknown. Lead seems to be the most difficult substance for X-rays to penetrate. Hence, lead is used as a screen to shield objects from X-ray action. Care should be taken in experimenting with X-rays as their penetrating power results in serious flesh burns under either protracted or oft repeated exposure to them.

(To be continued)

THE MANUFACTURE OF VACUUM DETECTORS.

(Continued from page 630)

than the filament when the tube is jarred. After adjustment on the plate and grid has been made, the assembly is inserted into the prepared tubes and the end seals made. A short length of small diameter tubing is attached to the seal at one end of the tube, this being for connection to the pump manifold. The tube is then carefully annealed and is ready for exhaustion.

A number of tubes are sealed on the manifold in the oven and the temperature is gradually increased to 900 degrees Fahrenheit (480° C.) at which point the pumps are started. The tubes are heated in this manner before the pumps are started so that the air contained in the tubes may conduct the heat to the central elements and drive off the occluded gases (i.e., gases held in the molecular interstices of the wing, filament and grid structure). When the pumps have produced a vacuum of one micron, the temperature of the tubes is very gradually increased to 1000 degrees (540° C.). At this point they must be watched very closely as the melting point of this glass varies greatly and should the walls of the tubes become soft, the vacuum would cause collapse. From one micron, the vacuum slowly increases, and after about five hours of continuous pumping the tubes are sealed off at the manifold and allowed to cool in the oven.

McLeod gages are used in the measurement of vacua but I have found that a much more accurate vacuum comparison can be made using a large induction coil. For this purpose an electrode is sealed to the manifold or at some point in the vacuum line. One terminal of the coil is connected to this electrode and the other coil terminal is connected to the low vacuum pump. A calibrated spark gap is used on the coil and when the vacua is high enough and the residual gases are properly pumped from the tube a spark will jump the gap *without a glow in the vacuum line or tubes*. The vacuum used in the tubular detector will permit a five inch (12.5 cm.) spark between needle points in air.

Prof. Richardson has shown that when new metals are heated to incandescence they emit positive ions, probably because of the impurities or gases in the metal. I have found that this positive discharge must be eliminated to obtain maximum sensitiveness of the tubular detector, and this is accomplished during the manufacturing stage by burning the filament on alternating current for about two hours. Tubes that have not been treated in this manner are found to be less sensitive than those in which the positive ionization has been destroyed.

A VERTICAL CABINET TYPE COUPLER.

(Continued from page 631)

ENDS FOR THE COILS

It is necessary now to cut a base end to fit the five inch primary coil and two for

the four and one-half inch or secondary coil, from three-eighths inch wood (white pine may be used, as it is quite soft and easy to handle). When thus cut they are placed on top of each other and two one-eighth inch holes drilled about one and one-half inches apart and toward one end. They must, of course, be in alignment, as they are for the slider rods. The center must also be free as in one of the four and one-half inch covers fifteen holes are to be drilled for the fifteen secondary taps. The respective taps of the secondary are drawn thru in order and the ends nailed to the coil with brass nails. Care must be taken to get the openings for the sliders directly under each other. The completed secondary is shown at Fig. 4, and also the sliders and their arrangement. The sliders are made from No. 8 copper wire which is stretched taut by screws at the top of the cabinet. A screw eye is inserted into the top for varying the coupling, as will be described presently, and the primary is screwed in place (see Fig. 4).

THE CABINET

Very little need be said about the material for the cabinet, perhaps, as the building of this depends entirely upon the ways and means of the Amateur, so only the measurements will be given. The cabinet is made like a box except that the top and back are not put into place until the apparatus is mounted. The front panel is one-half inch thick, twenty-six inches high and eight and one-half inches wide (3/4 inch Bakelite makes an excellent job); the sides are six inches wide.

SWITCHES, SWITCHPOINTS AND METHOD OF VARYING THE COUPLING

The switches were made at a cost of eight cents each, using also such odds and ends as are found in any laboratory. The knobs



The Electric Safety razor makes shaving a pleasure. Blade vibrating 7,200 times a minute cuts the beard smoothly and without slightest pull or irritation—feels like a gentle massage. Can be used with or without electric current.

All users of the **Lek-Tro-Shav** speak well of it.

A barber says—"Have shaved for years and have never used any shaving device near its equal."

A home user says—"The most pleasing shave I've ever had in my life. Shaves my face closer than I used to shave, but there is no after irritation or ill effects as I usually get from another razor."

No. 1 Made for use from Light Sattery.
No. 2 Made for use from Dry Sattery.

Write for illustrated circular describing Lek-Tro-Shav Safety Razor fully.

VIBRATING ELECTRIC RAZOR CO
Dept. 122. Omaha, Nebr.

WIRELESS

OPERATORS WANTED

If you are ambitious and wish to better yourself this is your opportunity.

America's new Merchant Marine needs trained wireless operators. Good pay and splendid chance to see the world and help in the reconstruction of Europe. Our classes have supplied hundreds of expert Wireless and Land Line Operators.

Write for illustrated booklet giving full particulars. "The Best Radio School in New York City."

Y. M. C. A.

East Side Branch
Lenox 6051
86th St. and Lexington Ave.
New York

Learn Mechanical Drawing

Thousands of Draftsmen
Wanted — Salaries
\$35-\$100 Per
Week



ARE you earning more than the average man? If not, my offer will interest you. I offer you the best service that my school affords. I offer you my personal instruction in mechanical drawing. I offer to teach you expert draftsmanship in your own home. I offer to fit you for the high-paying position of draftsman in one of the United States government departments or one of the great machine shops of America. I offer to do all this at a reasonable expense to you, and in a comparatively short time. The drafting field is not crowded. It never was. It probably never will be. You cannot make a mistake by taking up draftsmanship. I do not know of any single profession open to men today which offers better opportunities. As I have said at the beginning of this article, draftsmen are earning \$35 to \$100 per week.

There is a demand for men who complete my course. I cannot supply graduates fast enough. Many of them are taken even before they complete their course. This unusual demand is explained by the fact that my students enter on actual drawing work the day they enroll with me. They spend no time with preparation and useless theory.

ONE OF THE FINEST AND BEST EQUIPPED INSTITUTIONS IN AMERICA TEACHES YOU MECHANICAL DRAWING AT YOUR HOME.

With the ending of the war, the day of big opportunities for trained men is here. Especially is this true in the case of draftsmen, on whom the mechanical industries of America depend. On no one profession does the reconstruction of Europe so nearly center.

Columbia School of Drafting
ROY C. CLAFLIN, Pres.
Dept. 868, 14th & T Sts., N.W., Washington, D. C.

ROY C. CLAFLIN, President
COLUMBIA SCHOOL OF DRAFTING

Free drawing instruments—Each of our students is presented at the beginning with a set of professional drawing instruments.

A valuable book sent without charge—Merely fill in the coupon below for a valuable book on drawing, and complete information in regard to our course.

COLUMBIA SCHOOL OF DRAFTING

Dept. 868, 14th and T Sts., N.W., Washington, D. C. Without obligation to me, please send me your illustrated book on Drafting and tell how I may secure your complete Home Study Course, the **DRAWING OUTFIT FREE**, and your help in securing a position as Draftsman.

Name.....
Address.....
City..... State.....



GET "CHEMCRAFT" for Christmas!
Perform all kinds of wonderful chemical experiments and tricks that will amaze and puzzle your friends. Learn the principles of Chemistry and have real fun at the same time. Get your outfit now!

- Chemcraft No. 1—\$1.25
West of Mississippi River and in Canada—\$1.50
- Chemcraft No. 2—\$2.50
West of Mississippi River and in Canada—\$3.00
- Chemcraft No. 3—\$5.00
West of Mississippi River and in Canada—\$6.00

Be sure you get "CHEMCRAFT," the original and most complete and scientific chemical outfit. Ask for it by name at your Toy Store, or send price and we will deliver direct prepaid.

The Porter Chemical Company
Industrial Bldg., W. Washington St.
Hagerstown Maryland

35 MILES PER HOUR

Is Record of This Car

Built by a boy from Junior parts furnished by us. Any boy can build this car. Parts very cheap. Send 26 cents for blue prints and price list of parts showing how to build this speedy little car.

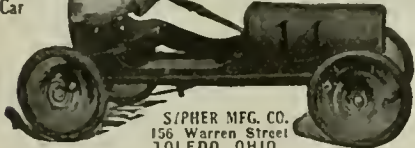

S/PIER MFG. CO.
156 Warren Street
TOLEDO, OHIO.



FREE \$20
Violin, Hawaiian Guitar
Ukulele, Gollar, Mandolin, Cornet or Banjo

Wonderful new system of teaching music by mail. To first pupils in each locality, we'll give a \$20 superb Violin, Mandolin, Ukulele, Gollar, Hawaiian Guitar, Cornet or Banjo absolutely free. Very small charge for lessons only expense. We guarantee success or no charge. Complete outfit free. Write at once—no obligation. SLINGERLAND SCHOOL OF MUSIC, Dept 422, CHICAGO, ILL.



ZIP
Patented Sept. 3, 1918

BOYS! We have received scores of letters like this: **W. A. ROTHWELL, M.D., Kendrick, Idaho** Automatic Rubber Co., Columbia, S. C. Gentlemen: Enclosed find personal check for \$1. Kindly oblige me by forwarding two Zip-Zips: the last I ordered were perfect in every way. Yours sincerely, W. A. Rothwell, M.D.

The doctor says they are O. K., boys. Order from us or your Sporting Goods Store. Zip-Zip complete only..... **50c**
AUTOMATIC RUBBER CO., COLUMBIA, S. C.

TELEGRAPH PICTURES

This picture of Wilson received over Leishman Picture Telegraphing Machines. Will transmit pictures, maps, drawings and handwriting. Send for descriptive folder.

L. J. Leishman, Dept. T
Ogden, Utah



FREE BOOK ON AVIATION

Learn of the great opportunities in this new \$1,000,000,000 industry. Thousands of men needed. Learn by mail—free book tells how. Write at once. NATIONAL AERO INSTITUTE, Dept 7441 Morris Bldg., Chicago

were purchased from a hardware store. These are glass drawer knobs and have a brass shell into which the glass knob is cemented; also a screw is fitted into the end. Five of these are needed. The switch blade is cut from a piece of springy brass or nickel. Cut two pieces three inches long and taper down one end (see Fig. 5). The other end must be made to fit the knob. A hole is drilled into this end and the blade is soldered to the brass cup; bend the contact end as shown. Also cut two pieces one and one-half inches long for the secondary switches and fasten in the same way and to the fifth knob solder the hand of a clock.

The switch points are common upholsterer's nails with the brass tops and small washers to fit the under side. After the wire has been drawn thru a hole drilled in the cabinet for it, it is twisted around the nail and the loop thus formed pushed far down into the hollow of the cup of the nail. A small amount of flux and a piece of solder about one-quarter the size of a split pea is placed into the cup which is held hollow upward. A hot iron is now touched to the nail, and the solder will melt flush and make an excellent connection. The washer is now slipped over the nail and the nail driven in place. The washers are not essential but make the heads of the switch point protrude more. (Fig. 5.)

The method of varying the coupling is by a cable and drum arrangement. Rack and pinion methods need accurate workmanship for them to operate correctly, so this novel home-made method was devised. After the clock hand has been soldered to No. 5 knob, a twenty-four inch (circumference) wooden wheel is fastened to the screw of this knob. This wheel is locked in place and a bearing is made to fit the other end of the screw, so that there will be a fairly good axle and bearings formed, one bearing being the front panel. A bent piece of brass will answer for the other end. A piece of leather is fastened in such a way as to cause friction against the wooden wheel. A piece of cord is nailed to the wheel and wound around the groove; the cord passing over a small pulley and secured to the screw-eye on the upper end of the secondary (see Fig. 4).

ASSEMBLY

Along the mid-line of the panel and four and eight inches up from the bottom, respectively, drill two holes to fit the screws of the switches. Above each of these drill two smaller holes for wires which will go to antenna and ground. Draw the flexible wires thru; solder to switch blade (Fig. 5) and put switch in place. Place a spring on the under side of switch to keep it tight. Describe an arc with each switch and using about two-thirds of a complete circle for the arrangement of switch points, divide them equally into the area thus allowed. Drill holes for the wires of the switch points, solder to switch points as already described and hammer into place. Then seventeen inches from the bottom and two inches from the mid-line each way, drill holes for the switches of the secondary. Mount the sixteen switch points in place as per diagram for connections.

Put the top on the cabinet with the bolts (eye-bolts) for slider rods and tighten the

rods; finally put on back. The diagram of the assembled coil is shown in Fig. 7.

There are many advantages of this type cabinet, as it is both compact, inexpensive and neat. It does not allow dust to settle between the windings and prevents the entrance of other foreign matter. One complete turn of the coupling knob will change the coupling completely. Accurate tuning of the primary is worked out to a very fine extent and the novel arrangement of the secondary tuning will be seen to have many merits, as any portion of the coil may be used and the direction of current may also be reversed. Often the coupling will not have to be changed in order to vary the secondary, as both switches may be moved and so bring another portion of the coil into play.

With a galena detector stand and using a "radiocite" crystal, this outfit cannot be beaten and other stations were brought in that never were heard before. This may have been due to the excellency of the

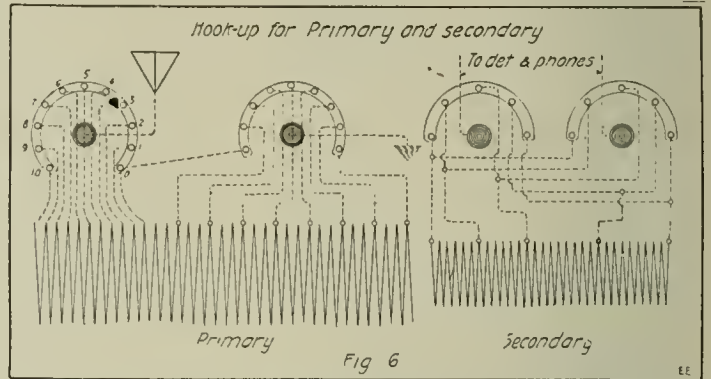

Hook-Up of Primary and Secondary Windings On Vertical Coupler. Note That Secondary Switching Circuit Permits of Reversing the Polarity of the Circuit.

crystal, but the coil has something to do with it, in my estimation.

SOLAR ENGINE USES SUN'S ENERGY.

(Continued from page 607)

Messrs. Shuman, Boys, and Ackerman, engineered and built a large solar energy plant at Meadi on the Nile, Egypt. This plant developed 100 h.p. The total area of sunshine collected was 13,269 square feet. The maximum pounds of steam generated was 12 pounds per 100 square feet of sunshine, or the equivalent, to 183 square feet per brake horsepower. The best hour's run developed, at atmospheric pressure, 1,442 pounds of steam. Hence (allowing 22 pounds steam per brake horsepower) the maximum output for an hour was 55.5 horsepower (about ten times better than any previous results). This means 63 brake horsepower per acre of land occupied by the plant. Moreover, no marked reduction in the horsepower produced was noticeable in the early hours of the morning or in the late hours of the afternoon.

The temperature of the sun, as aforementioned, has been calculated to be about 6,000 degrees centigrade. Several authorities point out that this terrific heat therefore precludes any possibility of the sun being a molten mass in the process of combustion. It has been thought recently by many to be a great mass of matter possessing to a remarkable degree radio-activity akin to radium. Helmholtz proposed that the sun could keep on producing energy at its present rate by accounting for some on the basis of a slight annual shrinkage in its size. From observations and measurements

of this heavenly body made from year to year it has been computed that the age of the sun would, on the shrinkage basis, be 17,000,000 years.

The radiant energy received from the sun at the outer surface of the earth's atmosphere is equivalent to 7,300 horsepower per acre. Of this about 70 per cent. or, roughly speaking, 5,000 horsepower per acre, is transmitted thru the atmosphere to the land surface proper of the earth, at noon on a clear day. Lesser amounts, of course, are received in the early morning and late afternoon, owing to the greater thickness thru which the energy must pass.

Relative to the basis upon which solar energy is calculated for the earth's surface, this is generally made, it may be said, on the "solar constant," as it is termed, ascertained from 696 tests conducted by the Smithsonian Institute of Washington, in various parts of the world, which resulted in accepting 1.93 calories per square centimeter per minute, equal to 7.12 British thermal units per square foot per minute. This is an average value, all things considered.

Only about three-fifths of the solar radiation produce any impression on the earth, and it is only the radiant energy which falls on some material body that is converted into heat. The best body for this conversion having been ascertained to be a dead black one.

"ODD PHOTO" CONTEST.

(Continued from page 616)

as to work the strings. Fourthly, it was indoors on a cloudy day. I simply guest at the time—about 25 seconds for each exposure (double exposure) and let 'er go at that. The streaks are the strings; the lenses were between the two strings. I didn't expect it to be any good at all. So if you have any extra dollars flying around, send one out to Iowa. Fred Wagner, Burlington, Iowa.

NOVEL PHOTO OF CITY AND LIGHTNING AT NIGHT.

The photo I submit is a picture of a city at night, taken from a high mountain nearby. The object of taking the picture was to "snap" the lightning.

Rob't Sullivan, Canon City, Colo.

AT LAST—A PHOTO OF "BALL LIGHTNING."

Speaking of "Odd Photos" or something for the "bug" to worry about, I think I have it here, in the form of two actual photographs, either of which contain any kind of lightning one would want, i.e., chain, ribbon or ball.

These photos were taken about six months ago (Pardon the selfishness) on the same night and about five minutes apart, during a very damaging electrical disturbance in this locality.

I may be wrong in my conception of the impression on the right side of photo No. 1 (the upper left photo) being ball lightning, but would suppose it to be such. This picture is an exposure of 30 seconds. There was no artificial light of any kind in front of the camera. This phenomenon was not perceptible to the eye—or at least was not observed.

If this be ball lightning we then know that ball lightning is of an oscillating or pulsating nature, as is evident from the path taken by the ball. Possibly this is a

potential of one sign seeking its affinity or opposite potential sign, in order that it may neutralize. Following the path of the ball it comes in at the base of the ribbon discharge at the left, whence it travels straight across, almost parallel to the wires in the background, then it comes to rest in the upper right hand corner. It now slowly follows an irregular path with a few stops and makes its exit into the heavens, no doubt to join its patiently waiting other half.

Photo No. 2 (lower center) is a 3 minute exposure, during which time the camera was moved once but very slightly, as you see from the double print of the chimneys in the background. In this picture will be seen innumerable paths of the light ball where it has traveled at various speeds.

L. E. Church, Bailesville, Okla.

EXPERIMENTS IN RADIO-ACTIVITY.

(Continued from page 636)

radio-active study. It is thought unnecessary here to give further experiments in this phase of the subject as they will suggest themselves to the reader. It is an intensely interesting subject and the reader will derive both beneficial knowledge and pleasure from his experiments. There are many other properties of these substances besides their ionizing power which will be taken up in later articles.

(To be continued)

BUILDING A 3-INCH SPARK STATIC MACHINE.

(Continued from page 633)

should reach the comb and thus prevent the escape of the electricity before it reaches the metal points.

An iron ring placed on the conductor heightens its capacity. This consists of an iron wire bent in a circle and then well insulated with paper, which is later varnished with shellac.

If the handle of the machine is turned towards the combs, electric sparks can be drawn from the small ball attached to the end of the brass wire holding the comb.

It is unnecessary to explain the uses of Leyden jars and other apparatus which can be used in connection with this machine, as any "Physics book," under the heading of "Electricity," describes a number of them.

THE CITY OF SPLENDID NIGHT.

(Continued from page 623)

footed torch-bearers led the way. None of them, proud souls, ever saw their doorways in fullest beauty, the beauty that is electric, that softens rude prominences while it throws a lustrous, enchanting glow over fine design and decoration.

The "City of Splendid Night" forever calls me to fresh delights. I go the way of a side street at the beckon of a light and, anon, find myself before the stately pile of a church, mirrored against the sky by the guardian pillar of radiance that stands before it. Later I come upon a green park bordered with electric jewels. Here I seat myself and watch the trees play tag with beams of electric brilliance.

Big Money for Boys!

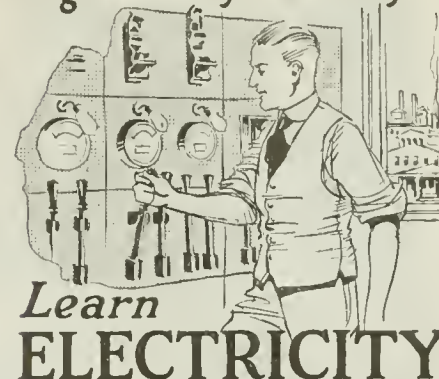

There is a wonderful opportunity right now for boys who like electricity. Thousands of men from the electrical industry have gone into the service and others are going every day. Boys who are ambitious and will train themselves in spare time can step into good positions and play a real part in winning the war by carrying on their work. Good salaries are offered with rapid promotion.

For 27 years the International Correspondence Schools have been training boys for success in electricity and over 200 other subjects. They will help you prepare right at home for a position in the line of electrical work you like best—or in any other work that appeals to you. Thousands of boys, through I. C. S. training, have stepped into fine jobs, but never were opportunities so great as now.

Let the I. C. S. help you. Choose the work you like best in the coupon below, then mark and mail it today. This doesn't obligate you in the least, and it will bring you information that may start you on a successful career. This is your chance. Don't let it slip by. Mark and mail this coupon now.

INTERNATIONAL CORRESPONDENCE SCHOOLS
BOX 6172, SCRANTON, PA.

Explain, without obligating me, how I can qualify for the position, or in the subject, before which I mark X.

- | | |
|--|--|
| <input type="checkbox"/> ELECTRICAL ENGINEER | <input type="checkbox"/> CHEMICAL ENGINEER |
| <input type="checkbox"/> Electrician | <input type="checkbox"/> SALESMANSHIP |
| <input type="checkbox"/> Electric Wiring | <input type="checkbox"/> ADVERTISING MAN |
| <input type="checkbox"/> Electric Lighting | <input type="checkbox"/> Window Trimmer |
| <input type="checkbox"/> Electric Car Running | <input type="checkbox"/> Show Card Writer |
| <input type="checkbox"/> Heavy Electric Traction | <input type="checkbox"/> Outdoor Sign Painter |
| <input type="checkbox"/> Electrical Draftsman | <input type="checkbox"/> RAILROADER |
| <input type="checkbox"/> Electric Machine Designer | <input type="checkbox"/> ILLUSTRATOR |
| <input type="checkbox"/> Telegraph Expert | <input type="checkbox"/> DESIGNER |
| <input type="checkbox"/> Practical Telephony | <input type="checkbox"/> BOOKKEEPER |
| <input type="checkbox"/> MECHANICAL ENGINEER | <input type="checkbox"/> Stenographer and Typist |
| <input type="checkbox"/> Mechanical Draftsman | <input type="checkbox"/> Cert. Pub. Accountant |
| <input type="checkbox"/> Ship Draftsman | <input type="checkbox"/> Traffic Management |
| <input type="checkbox"/> Machine Shop Practice | <input type="checkbox"/> Commercial Law |
| <input type="checkbox"/> Toolmaker | <input type="checkbox"/> GOOD ENGLISH |
| <input type="checkbox"/> Gas Engineer | <input type="checkbox"/> STATIONARY ENGINEER |
| <input type="checkbox"/> CIVIL ENGINEER | <input type="checkbox"/> CIVIL SERVICE |
| <input type="checkbox"/> Surveying and Mapping | <input type="checkbox"/> Railway Mail Clerk |
| <input type="checkbox"/> MINE FOREMAN OR ENGINEER | <input type="checkbox"/> Textile Overseer or Supt. |
| <input type="checkbox"/> ARCHITECT | <input type="checkbox"/> AGRICULTURE |
| <input type="checkbox"/> Architectural Draftsman | <input type="checkbox"/> Navigator |
| <input type="checkbox"/> PLUMBING AND HEATING | <input type="checkbox"/> Poultry-Raising |
| <input type="checkbox"/> Sheet Metal Worker | <input type="checkbox"/> Automobiles |
| | <input type="checkbox"/> French |
| | <input type="checkbox"/> Italian |

Name _____
 Present Occupation _____
 Street and No. _____
 City _____ State _____

YOU CAN MAKE BIG PROFITS WITH HB BATTERY CHARGER
 Others are making \$100 to \$150 a month extra profit. So can you. No experience necessary. Write for full particulars or send \$15 with this ad. to put this money-making HB 500 watt Charger in your garage on trial order. Balance in 9 monthly payments of \$20 each. No risk. Absolute money-back guarantee. Delay means lost profits. Order today.
 Hobart Bros. Co. Box 1E, Troy, Ohio

Bliss Electrical School
 ELECTRICAL ENGINEERING Condensed Course—Complete in One Year. Sound, scientific, practical—without frills. For young men of energy and character. 26th year opens September 25th. Write for new catalogue. 260 Takoma Avenue, Washington, D. C.

FREE BOOK ON AVIATION
 Learn of the great opportunities in this new \$1,000,000,000 industry. Thousands of men needed. Learn by mail—free book tells how. Write at once. NATIONAL AERO INSTITUTE, Dept 7441, Morton Bldg., Chicago

LEARN OF US Chiropractic (DRUGLESS HEALING)



You can easily and quickly get your Doctor's degree and graduate University Diploma from the well-known educational institution, Chicago University of American Sciences, and enter a modern profession paying others \$5,000 and more a year, simply by taking our true PERSONAL SERVICE INSTRUCTIONS in CHIROPRACTIC during spare time at home. ONLY course offered by a legally organized school that Guarantees Satisfaction or Refunds Money

My students today have big incomes. Thousands helped to success and riches. Let us help YOU. Write for prospect and special offer of a 12 volume Reference Library FREE for a few days.

Dr. D.E. WOOD, 17 N. State, Suite E 1 Chicago.

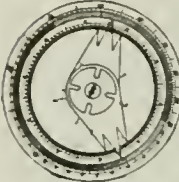

THE MIDGET SLIDE RULE will add, subtract, multiply, divide; solve problems involving even and uneven roots and powers. Also gives the logarithms of numbers and the Sines and Cosines, Tangents and Cotangents of all angles. Its operation is very simple; quickly solves any mathematical problem. Durable made of metal. Adapted for shop and office use. Fits the pocket, 3/4 inches diameter. Price with instructions, \$1.90 Your money back if you are not satisfied. Gilson Slide Rule Co., Niles Mich

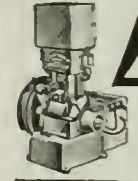

SMALL ENGINES
Perfected Gasoline Engines—
1/2, 1 and 1 1/2 h. p.—for Farm and Shop use. Price \$27.50 and up. Also
WASHING MACHINES
We ship on trial. Send for Booklet and Special Offer.
SIEVERKROPP ENGINE CO.
1401—19th St., Reeds, Wis.
STARTER for FORD CARS

MUSIC TAUGHT FREE

You can read music like this quickly
In Your Home. Write today for our booklet. It tells how to learn to play Piano, Organ, Violin, Mandolin, Guitar, Banjo, etc. Beginners or advanced pupils.
American School of Music, 57 Lakeside Bldg., Chicago



PHONOGRAPH
PARTS FOR ANY STYLE MACHINE
Build your own cabinets
We show you how
Circulars and instructions 10c.
Motors, Reproducers, etc. sold
Electro Mechanical Parts Co.
Dept. E 160 Na. Wells St., Chicago, Ill

MATHEMATICS MADE EASY

The Arcascope—the Combination Triangle with a Brain—will multiply, divide, figure percentage and proportion, solve all problems in trigonometry and geometry, draw symmetrical figures, plot arcs, etc. Superior to any slide rule. Simple to operate. Also included is a **TRANSPARENT TRIANGLE, PROTRACTOR and THREE RULES.** Used at Columbia University, West Point, U. S. Aeronautic Schools, etc. Only 85 cents Postpaid. Order today before you forget.
Dept. S. L. J. LEISHMAN CO., Ogden, Utah

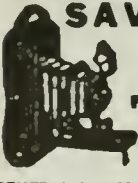

SAVE 25% to 60%
on slightly used
GRAFLEX-KODAKS
Cameras and Lenses of every description. Equal to new. Save money. Write now for **Free Bargain Book and Catalog** listing hundreds of money-saving bargains in slightly used and new cameras and supplies. All goods sold on 10 days' Free Trial. Money back if not satisfied. You take no chances dealing with us. We have been in the photographic business over 18 years. Write Now

CENTRAL CAMERA CO., Dept. 171 124 So. Wabash Ave., Chicago

WHY "FLUNK"?

A Latin Student? "CAESAR"—FIRST 8 BOOKS—"CICERO"—"OR VIRGIL"—and others, translated, word for word into ENGLISH. Complete, clothbound, \$2.00 each, postpaid.
MONONGAHELA NOVELTY CO., BOX 299, MONONGAHELA, PA.



Printing Cheap
Cards, circulars, labels, book, paper. Press \$8. Larger 30 Job press \$35.00. Save money. Print for others, big profit. All easy, rules sent. Write factory for press catalog, TYPE, cards, paper. **THE PRESS CO., D-47 Meriden, Conn.**



INSIDE TYRES INC. Armor
for Auto Tires. Double mileage, prevent blow-outs and punctures. Easy to apply in any tire. Thousands sold. Details free. Agents wanted.
Amer. Accessories Co., Dept. 83, Cincinnati

Learn Watchwork, Jewelrywork and Engraving A fine trade commanding a good salary, and your services are always in demand. Address **HOBOLOGICAL Department**, Bradley Institute, Peoria Ill for our latest catalog

You may know the white lights of the night, so do I, but I also know where are to be found those more precious sights of the city, made possible by night and electricity. And so I wander lovingly thru the "City of Splendid Night," and visit its shimmering shrines.

The Park at Night

WHEN next you walk abroad at night, choose Central Park, and preferably that part of it which ranges south of Seventieth Street. Enter to the left of General Sherman and follow the friendly bypath that skirts the Japanese Lake, where the swan boats ride at anchor. I call it the "Japanese Lake" because the first sight of it, thru certain trees bent and burdened with weird charm, suggests a Japanese print, wherein the towering Plaza becomes Fujiyama. The while you stand the lake gathers lustre from many sources, taking toll of light until its tiny, radiant body seems a great, luminous tear, dropt from the eye of God.

You can't know Central Park until you see it at night, and then it is no more the park than the city surrounding it that thralls you. Each season has its own particular charms; but it is best to consult your almanac prior to making the excursion, for no moon is wanted at such a time. The lights of Manhattan should not be disturbed, or marred, and a cloudy night, with rain yet a long way off, is to be especially desired.

In truth some of the rarest charms of this great enclosure are the vantage points it offers for viewing the glowing city. From each hill and hollow and rustic bridge you see sights that make you feel Nature has prepared a wonderful gallery in which you may stand and see the thousand pictures painted by Night and Electricity.

And the wonder of the lighting. Never have pictures been hung for exhibition with more rare understanding of the art of presentation. Never has favored critic at private view found color and arrangement, composition and subject, more effectively displayed than finds he who will be guest of Central Park as he stands witness to the glory of Manhattan.

Off to the South and West flare great electric signs surmounting high buildings. Warm and colorful they hang in the sky; aerie, detached beacons of fantastic shape, winking at the night and rippling thru darkness. Rows of lighted windows speak cheerfully of life. From the summit of a tiny hill streaking traffic is visible in its shooting rays of warning speed.

Within the sylvan solitude the voice of the city speaks faintly, and its sparkling eyes are veiled with the romance of contrast, that ever comes when Nature spreads her green mantle in the midst of man's activities.

Oh, the wonder of the city from the park; and then the wonder of the park within the city. Here Robin Hood might dwell and Peter Pan feel a charm as luring as his finest scenes in Kensington Gardens.

If you would really see all the spirits of the wood gathered together in carnival, then stand at the Northern limits of the Mall and, half closing your eyes and rising on tiptoe, look down its length. Fill yourself with the full beauty of the fairy court. It is precisely lighted with soft, glowing globes. Here and there stand set pieces of statuary, grotesquely gigantic, forever trying in their rigid way to cast strange shadows for each competing light that falls on them from either side and from across the Mall's milky way.

As sure as you believe in fairies, they are here. Some lurking behind these statues, snuggled in the robust curves of

back and base. All waiting in thrilling expectancy their turns to dance and frolic in the silvery glow. The scene will surely enchant you. Earth-weight passes, the senses are ethereally acute, you feel the pulse of Beauty, and the heart within you takes fire.

So lives the radiant poetry of Central Park. It is there for all of you who will go with vision for its picturing. It is the great gallery exhibiting the Light of Manhattan.

New York in the Rain.

BLOT out the stars. Draw a leaden mantle of cloud across the heavens. Let the skies open every pore, until earth rejects the surfeiting torrents. Fields are sodden, woods sullen, villages sordid, and all the open country a sticky mass of morbid moisture.

But old New Amsterdam is glorious!

So fare you forth and witness the wonders of this city of cities in the rain. The perfect time is during the first silent hours of the morning. Then you may surprise it in the full splendor of its bath. The buildings stand stark, dripping, and in great masses rise triumphant thru the drenching.

The gutters are long panels of flowing mirrors which break and shatter into ten million fractions in reflections, where treacherous corner grills suck them into roaring depths. About each light that punctuates the avenues and streets there is a hazy glow. Here sparkle the jewels thrown overboard by the clouds in an effort to lighten their ballast.

As the hoisting themselves on the liquid ladder of the storm, the ascending mingled lights of the city burnish the grey vault above with golden copper, as the hearth-flames picture themselves in the kettle swinging from the crane.

The romance of *Masonry* and *Electricity* is before you. It is a drama done in pouring pantomime. The scenery is made of steel and stone, with all the city on the stage. Footlights and spotlights get their life from giant dynamos and turbines swiftly milling greater light than Nero made when sacrificing Rome.

Now pause, while the clouds are discharging their cargoes; if you will halt between tall buildings and bear your face to the rain for a full upward glance you will know somewhat of the feeling of the mountain traveller when he stands in the spray of some vast waterfall. Deep down in the cañon he pauses while the rays of an unseen sun paint a rainbow on the struggling torrent at the spot where the unleashed waters hurl themselves from the cold embrace of the rocky heights.

Again you stand before great arches opening into the halls of commerce and mark the silent sentinels picking luminous arcs out of the night and rain and sending many-colored reflections into the shadowed recesses as fire-brands challenge the darkness of some echoing cave.

So we see the many-sided city at its bath. The city that has been the sweetheart of an endless procession of goodly men. The city of which O. Henry sang so sweetly and of which he wrote so understandingly. Great is Diana of the Madison Square Campanile. Great is the Lady of Liberty Light. But greater still is the city over which they reign.

When storm breaks at night Manhattan blooms; she blossoms gorgeously in the downpour, and bathes majestically. And so, when drenching clouds cut off our view of the campfires of the guardsmen of the heavens, we feel an increased thrill in the shining of our faithful keepers of the curb, the stars of the street.

MAGAZINES GOING UP!

Further Increases Coming! NOW IS YOUR CHANCE!

With this issue, the price of the EXPERIMENTER, as announced on another page, goes to \$2.00 a year. With the paper market in chaos and soaring prices, printers demanding another large wage increase, engravings going up 90%, we feel sure that before spring ALL magazines will go much higher than now.

By subscribing now for from one to five years, YOU POSITIVELY WILL SAVE BIG MONEY.

The prices below are unquestionably the lowest for standard magazines that it is possible to obtain anywhere. Only by a special arrangement with the publishers are these prices possible and they are good only until December 15th, after which date all prices as given on this page are withdrawn. Make up your list at once—do not delay. If you are already a subscriber and your subscription to the EXPERIMENTER runs for a long time, you may subscribe for any other magazine by deducting the price of the EXPERIMENTER from the clubs at the rate of \$1.85 (the special price allowed in clubbing with other magazines). Thus you can make up any club yourself of as many magazines as you wish from the list below.



The Publishers
Will Mail the Magazine
Direct From Their
Own Office to You

All prices quoted are for subscribers in U. S. only. Canadian and foreign subscriptions require additional postage.

Electrical Experimenter \$2.00	Our Price	Popular Science..... 2.00	Our Price
Illustrated World, (Technical World) .. 2.00	\$5.50	Regular Price.....\$6.00	
Electrical Experimenter \$2.00	Our Price	Scientific American.... 5.00	Our Price
Regular Price.....\$7.00	\$6.50	Regular Price.....\$7.00	
Electrical Experimenter \$2.00	Our Price	Popular Astronomy... 3.50	Our Price
Regular Price.....\$5.50	\$5.15	Regular Price.....\$5.50	
Electrical Experimenter \$2.00	Our Price	Wireless Age..... 2.00	Our Price
Etude 1.75	\$4.95	Regular Price.....\$5.75	
Regular Price.....\$5.75		Electrical Experimenter \$2.00	Our Price
Electrical Experimenter \$2.00	Our Price	American Boy..... 1.50	Our Price
Boya' Magazine..... 1.50	\$4.35	Regular Price.....\$5.00	

Electrical Experimenter \$2.00	Our Price	American Boy..... 1.50	Our Price
St. Nicholas..... 3.00	Our Price	Regular Price.....\$8.50	
Youth's Companion.... 2.00	\$7.85	Electrical Experimenter \$2.00	Our Price
Regular Price.....\$8.50		Today's Housewife.... .75	Our Price
Electrical Experimenter \$2.00	Our Price	McCall's Magazine.... .75	Our Price
Regular Price.....\$3.50	\$3.00	Regular Price.....\$3.50	
Electrical Experimenter \$2.00	Our Price	Literary Digest..... 4.00	Our Price
Collier's Weekly..... 2.50	Our Price	Regular Price.....\$8.00	

Electrical Experimenter \$2.00	Our Price	Etude 1.75	Our Price
Regular Price.....\$3.75	\$3.20	Regular Price.....\$3.75	
Electrical Experimenter \$2.00	Our Price	Boys' Magazine..... 1.50	Our Price
Regular Price.....\$3.50	\$3.00	Regular Price.....\$3.50	
Electrical Experimenter \$2.00	Our Price	Everybody's Magazine. 2.00	Our Price
Dellneator (all to one address) 2.00	Our Price	Regular Price.....\$6.00	
Regular Price.....\$6.00	\$5.35	Electrical Experimenter \$2.00	Our Price
Electrical Experimenter \$2.00	Our Price	Motion Picture Magazine 2.00	Our Price
Regular Price.....\$4.00	\$3.60	Regular Price.....\$4.00	
Electrical Experimenter \$2.00	Our Price	Everybody's 2.00	Our Price
American Magazine... 2.00	Our Price	Regular Price.....\$6.00	
Regular Price.....\$5.50	\$5.50		

Electrical Experimenter \$2.00	Our Price	World's Work..... 4.00	Our Price
Regular Price.....\$6.00	\$4.85	Regular Price.....\$6.00	
Electrical Experimenter \$2.00	Our Price	Smart Set..... 3.00	Our Price
Regular Price.....\$5.00	\$4.10	Regular Price.....\$5.00	
Electrical Experimenter \$2.00	Our Price	Parisienne 2.00	Our Price
Regular Price.....\$4.00	\$3.50	Regular Price.....\$4.00	
Electrical Experimenter \$2.00	Our Price	Youth's Companion... 2.00	Our Price
Review of Reviews... 3.00	Our Price	Regular Price.....\$7.00	
Regular Price.....\$7.00	\$6.10	Electrical Experimenter \$2.00	Our Price
Electrical Experimenter \$2.00	Our Price	Pictorial Review..... 2.00	Our Price
McClure's Magazine... 1.50	Our Price	Regular Price.....\$5.50	
Regular Price.....\$5.50	\$5.00		

Special Clubbing Prices of Electrical Experimenter WITH

	Regular Price	Our Rate Per Year		Regular Price	Our Rate Per Year
Adventure	\$5.00	\$4.70	Literary Digest	\$6.00	\$5.70
American Boy	3.50	3.00	McClure's Magazine ...	3.50	3.00
American Magazine ...	4.00	3.85	Metropolitan	5.00	4.75
Black Cat	3.50	3.00	Modern Pricella	3.50	3.25
Blue Book	4.00	3.75	Nation	6.00	5.95
Boys' World	2.50	2.25	Outlook	5.00	4.75
Century	6.00	5.30	Pearson's Magazine ...	4.00	3.50
Christian Herald	4.00	3.60	Popular Science Monthly	4.00	3.75
Collier's	4.50	4.25	Red Book	4.00	3.75
New Country Life	7.00	6.65	Review of Reviews	5.00	4.00
Dellneator	4.00	3.60	St. Nicholas	5.00	4.75
Etude	3.75	3.20	Scientific American ...	7.00	6.50
Everybody's	4.00	3.60	Scribner's Magazine ...	6.00	5.35
Field & Stream	4.00	3.50	Smart Set	5.00	4.10
Film Fun	3.50	3.25	Wireless Age	4.00	3.50
Orit	4.00	3.60	Woman's Home Com-		
Illustrated World (Tech-			pnsion	4.00	3.75
nical World)	4.00	3.50	World's Work	6.00	4.65
Judge (Weekly)	7.00	6.75	Youth's Companion ...	4.00	3.75
Leslie's Weekly	7.00	6.75			

Write for Special Prices on ANY Publication not listed here

We will save you money

SEND ALL ORDERS TO "CIRCULATION DEPARTMENT"

EXPERIMENTER PUBLISHING CO., Inc.

233 Fulton Street, New York City, N. Y.

SEND FOR OUR FREE SUBSCRIPTION CATALOG



Scores of Publishers are increasing their prices overnight. Protect yourself by subscribing NOW

You benefit by mentioning the "Electrical Experimenter" when writing to advertisers.

Opportunity Ad-lets

YOU will find many remarkable opportunities and real bargains in these columns. It will pay you to read and investigate the offerings made every month by reliable firms and dealers from all over the country. No matter what you may be seeking, whether supplies, automobile accessories, the opportunity to make money, or anything else, you will find listed here the best and most attractive specials of the month. Advertisements in this section seven cents a word for each insertion. No advertisement for less than 50c accepted. Name and address must be included at the above rate. Cash should accompany all classified advertisements unless placed by accredited advertising agency. Ten per cent discount for 6 issues, 20 per cent discount for 12 issues from above rate. Objectionable or misleading advertisements not accepted. Advertisements for the February issue should reach us not later than December 22.

SPECIAL NOTICE Owing to the large increase in circulation the classified advertising rate beginning with the February issue will be 7c per word. However, all orders or reservations for a period not to exceed one year, which are received not later than December 20, will be accepted at the old rate of 6c per word.

EXPERIMENTER PUBLISHING CO., INC., 233 Fulton Street, New York, N. Y.

Automobile Accessories

More Power, Less Fuel, No Carbon. No mystery, plain facts, results guaranteed. Write for booklet, S. O. Automobile Accessories Co., Baltimore, Md.

Fords Start Easy in Cold Weather with our new 1919 carburetors. 34 miles per gallon. Use cheapest gasoline or half kerosene. Increased power. Styles for any motor. Very slow on high. Attach it yourself. Big profits to agents. Money back guarantee. Thirty days' trial. Air-Friction Carburetor Co., 270 Madison, Dayton, Ohio.

Lubricant Carbon Remover Solves the Carbon Problem. When your motor loses power, when it knocks, bucks and overheats, don't monkey with the carburetor. Send for a can of Lubricant Carbon Remover. Every can guaranteed. Price \$1 prepaid. Agents wanted. W. A. Engelke, 327 Bishop St., Cincinnati, Ohio.

Kwik-Fix Rubber Compound. Better than anything you have ever used. Repairs auto tires, inertubes, ignition wires, leaky auto taps, cuts and thin spots in rubbers, rubber boots, hot water bottles. At your garage or by mail 35c. Merriman, Freehold, N. J. Dept. E.

Motorcycles

Motorcycles from \$25 up—New and second-hand. Easy terms, large list to choose from, all makes. Send 4c stamps for Bulletin "A." Peerless Motorcycle Co., Watertown, Mass.

Agents Wanted

Insyde Tyres, inner armor for automobile tires, double mileage and prevent punctures and blow-outs. Quickly applied. Costs little. Demand tremendous. Profits unlimited. Details free. American Automobile Accessories Co., Dept. 54, Cincinnati, O.

Hel-Met The Kaiser Pin—Latest war novelty. Biggest hit out, every patriotic citizen wants one. Sample 10c. Wedge Mfg. Co., "KM," Binghamton, N. Y.

\$10 Daily refinishing chandeliers, brass beds, automobiles by new method, without capital or experience. Free particulars and proofs. Write today. Gunmetal Co., Ave. D, Decatur, Ill.

Hindoo Magical Secrets. Wonderful book, 1919 edition limited, 25c. Sample 12c. \$2 per 100. Better order quick. Dept. X, Lindhorst Magic Shop, St. Louis, Mo.

Sterling Fibre Brooms: Outwear five corn brooms, guaranteed one year, \$1.25 postpaid; agents wanted. Keystone Fibre Broom Co., 618 Duquesne Way, Pittsburgh, Pa.

Help Wanted

Men Wanted to make Toy Soldiers, Army, Navy and other toys. Homeworers on small scale, manufacturers on large scale. Greatest chance for industrious people for independent business. Enormous demand and future in "American-made toys". This new American work stands out conspicuously. Factories have been established, people trained, machinery made with energy and success. Dealers don't want to handle any others except "American-made". We buy these goods all year, paying fixed prices. Experience or tools not necessary. Hundred and more made complete per hour. Casting form outfits \$3 up. Booklet and information free. Toy Soldier Manufacturing Co., 32 Union Square, New York.

To Ascertain the Vocation for which you are best adapted send for Zancig's Revised Horoscope. Send date of your birth and 25c. Prof. Zancig, 109 West 87th St., New York.

Monthly income paid those writing lists of names for us at home, spare time; no supplies to purchase, no investment, expense or other work required; postal brings particulars. National Exchange, Box 1001, New York.

Phonographs

Build Your Own Phonographs and manufacture them for profit. Drawing instructions, Parts, Price List, Blue Prints, etc., complete, sent free upon request. Write today. Associated Phonograph Co., Dept. E-1, Cincinnati, Ohio.

Phonographs—Continued

Build Your Phonograph. "Perfection" high-quality spring and electric Motors, Tone Arms, Reproducers, Wonderful results. Big saving. New catalog and building instructions mailed for ten cents. Indiana Phonograph Supply Co., Indianapolis, Indiana.

Charlotte, N. C.
Oct. 4, 1918.

Electrical Experimenter Pub. Co.,
233 Fulton St., New York.

Dear Sirs:

It certainly was **SOME RESULTS.** I've almost worn out a good typewriter. Just about exhausted myself writing. Used all the paper in this part of America. And about "Gone Busted" buying postage stamps.

Now, I'm a-going quit, and will never do it again, or at least I won't promise to answer all the letters I received from an Ad that I put in the "E. E."

The letters are still coming in.—The apparatus advertised has long since been sold. Every piece of it. The letters are from all over the United States, AND ELSEWHERE. Received one today from Sbangbai, China. Can you beat that. I'm enclosing the letter from China.

It's a great life, if you don't weaken. I wish to THANK the "E. E."—Some circulation.

Very Respectfully,

G. R. SMATHERS,
403 N. Brevard St., Charlotte, N. C.

Miscellaneous

Tobacco or Snuff Habit Cured or no pay. \$1.00 if cured. Remedy sent on trial. Superba Co., SA, Baltimore, Md.

Catch Fish. Descriptive folder containing valuable information mailed for stamp. George Julian, Albany Building, Boston.

Wanted—Small Gasoline and Steam Engines. Cash paid for 1 to 4 cylinder light weight Motors. 1/4 to 10 H.P. Johnston, West End, Pittsburgh, Pa.

Your Technical Troubles can be solved. We handle all technical problems pertaining to design, calculation, installation, etc., promptly and correctly for \$1 and up. We invite your correspondence. E. Duski, Technical Advice Bureau, 1760 Bergen St., Brooklyn, N. Y.

Cigarette, pipe or chewing habit conquered. Nature's method. Guaranteed. Write for free brochure. Edw. J. Woods, TA-300, Station F, New York.

Fountain Pen Free with a \$1.75 order of ink. Eighteen packages, each package contains enough material to make twenty cents' worth of blue-black ink. Trial package ten cts., three for 25 cts. Kralovec & Co., 2344 Altgeld St., Chicago, Ill.

"Quick Process Duplicators." Makes 100 copies in 10 minutes. Remarkable time-savers. Thousands in use. Write for free illustrated circular. Heyer Duplicator Co., 160-EE, N. Wells St., Chicago.

Pyorrhea—H. E. Kelty, D. D. S., M. D., pyorrhea specialist for 15 years, has developed a successful home treatment for pyorrhea, Purifying, healing, preventative. Full month's treatment and booklet, \$1. Circular free. Dr. H. E. Kelty, Glenwood & Woodland Aves., Leonia, N. J.

We Have a limited number of beautiful art pictures on hand of Nikola Tesla and Dr. Lee De Forest. These make a handsome decoration for any laboratory or workshop and should be prominently displayed. Price for both, prepaid, 10c. Experimenter Pub. Co., 233 Fulton St., New York City.

"Opportunity Ad-Lets" bring quick results. Over 100,000 circulation, net. Other firms are making money—so can you. For proof address Classified Department, Electrical Experimenter, 233 Fulton St., New York City.

Business Opportunities

I made \$20,000 here past four years making burial vaults. Will start you in same permanent business without capital. Absolutely no selling. Stamp brings details. Charles Murphy, Dept. 3, Bloomington, Ind.

Enter a New Business. Earn \$3,000 to \$6,000 yearly in professional fees making and fitting a foot specialty, openings everywhere with all the trade you can attend to; easily learned by anyone at home in a few weeks, at small expense; no further capital required; no goods to buy; job hunting, soliciting or agency. Address Stephenson Laboratory, 18 Back Bay, Boston, Mass.

I Made \$30 a Week, easy money, evenings home. Free Booklet explains. Mail Order Business. Send stamp. Alec. Scott, Cohoes, New York.

Make Die-Castings. Sketch, Sample, Booklet, and Proposition, 12c. R. Byrd, Box 227, Erie, Pa.

"Quick-Action Advertising—How it is Building Business for the Progressive Advertisers of America"; A little story of RESULTS, told by the advertisers themselves—not the publisher. You will be interested in reading this little booklet, which we have prepared for prospective advertisers, a copy of which will be gladly mailed to you upon request. It tells you how to talk business with 1,000,000 intelligent, interested and responsive Americans every month—men who know what they want and who have the money to buy it. Write for particulars and rates today. Douglas Wakefield Cutlee, 225 West 39th Street, New York.

Build up an Income in Oil—Others are doing it—Why not you? Today is the opportunity. Join our easy monthly payment plan NOW—it may mean hundreds in profits. Write for information. National Oil Drilling Co., Dept. K, Houston, Texas.

WANTED—Specialties for mail order house. What have you to offer. Stone Specialty Co., 11 Broadway, N. Y.

Manufacturers: Advertising and Toy novelty with an unlimited field. Protected. 3166 Third Ave., New York City.

Amazing profits manufacturing backyards Fuel Briquettes, cheapest fuel known. Stamp. California Products Company, San Mateo, California.

You can letter Automobiles, Windows, Trunks, etc., without previous experience, by Transfer Process. Make \$27.50 on \$2.50 outfit. Auto Monogram Supply Co., 87 Niagara Building, Newark, N. J.

Incorporate your business under the common law. No organization tax; no franchise tax; no federal corporation tax; certificates not taxable; stockholders exempt from company debts; do business anywhere; directors reside where you wish; lowest cost organization possible. Common Law Organization Co., 4 Randolph, Detroit, Mich.

Dollars Yearly in Your Backyard. No ginseng, mushroom dope. New ideas. Investigate. Particulars free. Metz, 313 East 89, New York.

Business Worthwhile. I Start You silvering mirrors, Plating tableware; Plans Free. Clarence Sprinkle, Dept. 48, Marion, Indiana.

\$30 a Week, Evenings. I made it with a small mail order business—continued my regular job daytimes. Free booklet tells how, 2c postage. Alex. W. Scott, Cohoes, N. Y.

Auctions

Auctioneers make from \$10 to \$50 a day. Free catalog. Missouri Auction School, Kansas City.

Postcards

Twenty Pretty Assorted Postcards 10c. 45—20c. Castle Co., N. Locust, Hagerstown, Md.

Wireless

Bargains—10,000 $\frac{3}{4}$ " Wireless Coils complete, guaranteed, 90c, send postage. Also, 25,000 Wireless Coils without vibrators, 45c, send postage. A. Dubs, 1534 Pitkin Ave., Brooklyn, N. Y.

Best Radio Hook-ups for Damped and Undamped Waves, Amplifiers, etc. Blueprinted with full instructions, 60 cents postpaid. Luther Reiner, Bexley, Ohio.

Better stock up now on switches and switch points for that new set. Circular describing the most perfect on the market sent free. Eureka Secondary Co., 6939 S. May St. Chicago, Ill.

Morehead All-Purpose Vacuum Tubes: Last 50% longer; require less hi-voltage; eliminate STATIC; SUPER-sensitive! Have one ready Avoid the RUSH later! Satisfaction GUARANTEED; ABSOLUTELY. \$6.50 each—FIVE for \$25.00! Somerville Radio Laboratory, Eastern Agents, 102 Heath, Somerville, Mass.

Electrical Supplies and Appliances

Recharge 2 dry cells for five cents. Directions 10c. Gilbert, 8 Chestnut, Binghamton, N. Y.

Tungsten Steel Magnets U type. Have a number of these magnets weighing 2 lbs. each and will lift 6 or more times their own weight. \$1.75 while they last. Henry Althaus, Bluffton, Ohio.

Blueprints for building of Spark Coils from $\frac{1}{2}$ " to 12" with Instructions. 50c. each. Also for Wimshurst Machines, etc. Also repairs made and parts machined, after sketch. The B. & H. Electric Laboratory, City Hall Station, General Delivery, N. Y.

Electricians. Send \$1.50 for 16 blue prints of Motor Windings. 10 A. C. Single, two and three-phase, and 6 D. C. or set of 20 A. C., 6 D. C., and 6 Rotary Converter Drawings for \$2.25. Connecting and Winding made easy. Superior Electric Company, Lock Box, 1372, Pittsburgh, Pa.

Electricians and garagemen: You need the blueprint for building the E102 test and trouble finder and directions for making tests. Locates shorts, grounds, opens in armatures; Oil or water soaked secondary cables on ignition units; Traces any power or lighting circuit; Hundreds of tests can be made with it. Send 25c for blueprint and directions. The Data Exchange, P. O. Box 1018, 7th Floor, U. B. Bldg., Dayton, Ohio.

Formulas

160 Formulas, resilvering mirrors, renewing dry batteries, luminous paints, mechanics' soap 25c, lists 2c. "Bestovall," Box 543-E, Chicago.

Formulas for Every Purpose. H. Krause, 2746 So. Karlov, Chicago.

For Inventors

Inventors—Market and secure your inventions through National Institute of Inventors, World Bldg., New York City. Membership co-operative organization.

Legal advice on any subject, Mfg., commercial, trade information in Re. inventions—patents. Hanlon, 1201-Arch, Philadelphia.

Inventors! Attention! I have valuable information how you can protect your inventions for two years before patenting it without expense or risk, full instructions, 25c. H. B. Lambert, 55 Willow Ave., North Pelham, N. Y.

Tricks, Puzzles and Games

1000 stage tricks with 500 illustrations. Catalogue 10c, small catalogue FREE. Hornmann Magic Co., Sta. 6, 470 Eighth Avenue, New York.

Tricks, Puzzles, Jokes, Toys, Games, Novelties, Doll and Cane Racks, Plays, Wigs, Stage Supplies, Escapes and Illusions. Large 1917 catalogue free. Oakes Magical Co., Dept. 549, Oshkosh, Wis.

Black Art Hindoo Experiments, copyright 1919 Edition, 25c. Invisible Ink. Free Trick. Catalog each order. Lindhorst Magic X Shop. St. Louis.

Stamps and Coins

Stamps—61 all different free. Postage, 3c. Mention paper. Quaker Stamp Co., Toledo, Ohio.

California Gold, Quarter size, 27c; Half-dollar size, 53c; Dollar size, \$1.10; Large cent, 1820, and catalogue, 10c. Norman Shultz, Kings City, Mo.

500 Finely Mixed United States or Foreign Stamps, 12c. Philatelic Star, Madison, N. Y.

225 Different Stamps 25c. Fred Onken, 546 Carlton Avenue, Brooklyn, New York.

We buy and Sell Old Money. \$2 to \$500 each paid for hundreds of coins dated before 1895. Keep all Old Money. Send 10 cents for new illustrated Coin Value Book, 47c. You may have valuable Coins, get posted. Clarke Coin Company, Box 110, Le Roy, N. Y.

200 all different really fine Postage Stamps, 23c. Dayton, East Foxboro, Mass.

Scenery for Hire

Collapsible Scenery for all Plays. Amelia Grain, Philadelphia, Pennsylvania.

For Inventors

Inventions Commercialized. Cash or royalty. Adam Fisher Mfg. Co., 205 St. Louis, Mo.

For Advertisers

20 Word Ad. in 100 Pulling magazines, \$1.00. About 75,000 readers. Send copy now. Lindhorst Magic Shop, St. Louis.

Advisory Correspondence free. Profitable letters, folders, booklets, follow-ups, plans. Reasonable charges. Pontifex, 62 Frank Street, Ottawa, Canada.

"Quick-Action Advertising—How it is Building Business for the Progressive Advertisers of America"; A little story of RESULTS told by the advertisers themselves—not the publisher. You will be interested in reading this little booklet which we have prepared for prospective advertisers, a copy of which will be gladly mailed to you upon request. It tells you how to talk business with 1,000,000 intelligent, interested and responsive Americans every month—men who know what they want and who have the money to buy it. Write for particulars and rates today. Douglas Wakefield Coutlee, 225 West 90th St., New York.

Printing

100 Bond Noteheads, 4 lines and 100 envelopes, prepaid, \$1.00. Southwestern, 1413-H Berendo, Los Angeles.

50 Bond Letterheads, 50 linen cards, 50 envelopes, 3 lines, \$1.00. Shamrock Press, 86 Mitchell, Columbus, Ohio.

Calling Cards. Your name on 25 high-grade, pasted bristol cards together with a famous Brown cardcase, 25c. The Barker Press, 17 Gibson St., Medford, Mass.

Song Poems Wanted

Write the Words for a Song. We write music and guarantee publisher's acceptance. Submit poems on war, love, or any subject. Chester Music Co., 538 S. Dearborn St., Suite 265, Chicago.

Chemicals

80 Chemicals \$5. Chemical outfits as previously advertised containing 80 chemicals now again for sale at \$5. Swimmer Chemical Co., 1849 Park Place, Brooklyn, N. Y.

Novelties

Genuine Indian Baskets—Wholesale and Retail. Catalogue. Gilham, Highland Springs, California.

News Correspondents

Earn \$25 Weekly, spare time, writing for newspapers, magazines. Experience unnecessary; details free. Press Syndicate, 566 St. Louis, Mo.

Motors, Engines and Dynamos

Small Motors and Generators: 1000 New Motors and Generators from Bankruptcy Stock, $\frac{1}{4}$ H. P. A. C., \$18.50 each; $\frac{1}{2}$ H. P., \$30.00. **Battery Charging Sets**—Robbins & Myers new outfits, all sizes, \$30.00 each and up. **Charging Lighting and Moving Picture Arc Generators,** \$10.00 each and up. Motors for all phases of current. Immediate delivery. Less than $\frac{1}{2}$ regular prices. Write for late bulletin. Johnston, West End, Pittsburgh, Penna.

Boilers, Engines and Machinery. Werner Extract Company, Mechanicville, New York.

For the Hair

I Was Bald. Obtained hair growth by an Indian's ointment containing genuine bear oil and rare plant juices. Many others have good hair-growing results. Will send box, postpaid, with recipe, 10c. John Hart Brittain, 150 E. 32nd St., BA-300, New York.

Photo Developing

Mail Us 15c with any size film for development and 6 velvet prints. Or send 6 negatives any size and 15c for 6 prints, 8 x 10" mounted enlargements 35c. Prompt, perfect service. Roanoke Photo Finishing Co., 255 Bell Ave., Roanoke, Va.

Kodakers: How would you like to get a 9 x 11 enlargement of your best negatives free? Drop us a card right now asking about it. Films developed at 10c per roll, prints 3c, 4 and 5c each. Satisfaction guaranteed. Ford's Photo Studio, Ellensburg, Washington.

Telegraphy

Telegraphy and Railway Accounting taught thoroughly and quickly. Unprecedented demand for both sexes at Big Salaries. Oldest and largest school—Est. 45 years. Catalog free. Dodges Institute, Seventh St., Valparaiso, Ind.

Patent Attorneys

Patents—Without advance attorney's fees. Not due until patent allowed. Send sketch for free report. Books free. Frank Fuller, Washington, D. C.

Inventions Wanted! Manufacturers constantly writing us for patents. List of inventions actually requested and book "How to Obtain a Patent" sent free. Send rough sketch for free report regarding patentability. Special assistance given our clients in selling patents. Write for details of interest to every inventor. Chand-lee & Chand-lee, Patent Attorneys, Est. 21 years. 551 7th St., Washington, D. C.

Patent Your Own Inventions. Save attorney's fees; we prepare applications; furnish full instructions and give satisfaction. Free information. Carl Larsen Co., Park Row Building, New York City.

Millions Spent Annually for Ideas! Hundreds now wanted! Patent yours and profit. Write today for free books—tell how to protect yourself, how to invent, ideas wanted, how we help you sell, etc. 212 Patent Dept., American Industries, Inc., Washington, D. C.

M. F. Miller, Ouray Building, Washington, D. C., Patent Attorney, Mechanical and Electrical Expert. Best quality of work and results. Moderate charges. Advice free.

Your Idea Wanted. Patent Your Invention. I'll help you market it. Send for 4 free books, list of patent buyers, hundreds of ideas wanted, etc. Advice free. Patents advertised free. Richard B. Owen, Patent Lawyer, 130 Owen Bldg., Washington, D. C., or 2278T Woolworth Bldg., New York.

Dogs, Birds, Pets

Ideal Xmas Gifts: Collier, Fox terrier, B. & Tan, Pekinges, Pomeranian, Boston, Canaries, Angora Kittens. Send 3c for bargain list. Shady-dell Kennels, Work, Pa.

Books

Free—\$5,000 worth of valuable books as premiums. Write for more information and catalogue; it's free. I have many books on Natural healing, personal magnetism, Clairvoyance, seer-ship, Hypnotism, Mesmerism, concentration, character reading, mind power, etc. Tell me your wants. A. W. Martens, JX8, Burlington, Iowa.

Electricity Made Simple, 233 pages, 108 illustrations, \$1 each prepaid, or send for circulars. Satisfaction guaranteed. M. E. Kraybill, Jr., Boiling Springs, Pa.

Blueprinted Charts—Send 25c for "15 Experiments in Chemistry" and circular of other new things. Royal Publishing Co., Box 1054, St. John, N. B., Canada.

Books for Real Live People. Lists free. J. E. Sheridan, 417 E. 151st St., New York.

Money saving magazine offers. Send for free catalogue. F. C. Johnson, 1620 East 68th Street, Chicago, Ill.

Bookkeepers and Business Men—Something different in Bookkeeping. Perfection Business Summary. Makes business 100% more interesting and satisfactory. 800 in 4 cities. John Caphart, Frankfort, Ky.

World-Romic System, Masterkey to All Languages. Six Textbooks, \$1.44. French Chart, 37c; Spanish, 37c; Aviation Dictionary, \$1.50. French-English Aviation Dictionary, 61c. Languages, 143 West 47th, New York.

Learn to Become an Acrobat—Our 10 lesson course teaches you. Send 75c for Lesson No. 1, or circular free. Only course in America on acrobatics. Royal Publishing Co., Box 1054, St. John, N. B., Canada.

How to Locate Oil, Minerals and Valuable Substances by Wireless; Scientific Book, \$3 postpaid. Astral Child Publishing Co., Corpus Christi, Texas.

To Get Better Pictures: Read the Amateur Photographer's Weekly; illustrated; weekly prize competitions; print criticisms; many unique features; \$1.50 per year; three months' trial subscription 25c. Abel Publishing Company, 401 Caxton Bldg., Cleveland, Ohio.

Old E. E. Back Numbers: We have some valuable old E. E. back numbers on hand as follows: 1915—Jan., March, April, June, July, Aug., Sept., Oct., Nov., Dec., price each 35c. 1916—Jan., Feb., March, May, June, August, Sept., Oct., Nov., Dec., price each 35c. 1917—Jan., Feb., March, Apr., May, June, July, Aug., Sept., Oct., Nov., Dec., each 35c. 1918—Jan., Feb., Mar., Apr., May, June, July, Aug., Sept., Oct., Nov., Dec., each 20c. We can fill orders at once upon receipt of your remittance, and if you have not these numbers already, now is your chance to get them, as they probably will be snapped up very quickly. Experimenter Publishing Co., 233 Fulton St., New York City.

A Binder for The Electrical Experimenter will preserve your copies for all time. Price, 50c. Postage on 3 lbs. is extra. Send for one today. Experimenter Publishing Co., 233 Fulton Street, New York City.

Scientific Exchange Columns

THE quickest medium in the country for buying what you need or disposing of anything for which you have no further use. Read these ads. each month—you'll not find bigger bargains anywhere.

NOTICE of CHANGE

Effective with February, 1919, Issue.

Advertisements for the February issue must reach us not later than Dec. 22.
EXPERIMENTER PUBLISHING CO., 233 Fulton St., New York City

Beginning next month, these exchange ads. will be run in the regular opportunity ad-let columns under a separate sub-heading, "scientific exchange ads." This will give exchange ads. a better position and insure their being seen by every reader of the magazine. The rate will be the same as for all other classified ads.—7c per word, with a discount of 10% for six consecutive insertions and 20% for twelve.

For Sale—6 H.P. 4 cylinder Universal Engine and 55 amp. 60 volt D.C. Generator, \$250. Will take typewriter or wireless as part payment. Herbert Lauber, Geneva, Nebr.

Swap—Electrical apparatus or small camera for field glasses or telescope or what you have. Lloyd Solomon, Cordele, Ga.

First—Twenty Dollars takes Goodell-Pratt bench lathe. Same as new, been in use only one month. Am buying large engine lathe so must sell. C. C. Cole, Whittier, Cal.

Trade—Movie Machine and Seneca Camera for wireless goods. Frank Gaede, Winamac, Ind.

Blacksmith Post Drill, \$5. 1918-9 Volume Machine Shop Library, \$9. Bosch Magneto Twin Indian Motor less carburetor, \$15. A. Ryder, Box 58, Argo, Ill.

Exchange—Winchester .22 Repeating for .22 Automatic. Good condition. Panaro, 1478 First Ave., New York City.

Swap—Two \$5 Erectors, books and magazines for phonograph or offer. Beaver, 556 West 184th St., New York City.

Exchange—2a Anasco Camera with leather carrying case. Mecanno Set 4; 29 Test tubes 1x6. Want good wireless instruments; receiving preferred. Letters answered. Kenneth Cook, Trenton, Mo.

Sell—New \$25 Electric Train, \$10. Harold Tinker, 3448 Aldrich, So., Minneapolis, Minn.

Edison Exhibition Motion Picture Machine to Exchange—Want chemicals, chemical apparatus, motorcycle, or typewriter. Valuation, \$85. H. E. Robinson, 126 S. Stewart, Sedalia, Mo.

Swap—Electrical goods. Want half to two K.W. Transformer and Rotary spark gap. Warwick, 2535 10th Ave. So., Minneapolis, Minn.

Wanted—Wireless transformers, ammeters, quenched gap, etc. Sell or trade Automatic Photo Button Machine, cost \$150; also Automatic Stereopticon, capacity eighteen slides. Prefer Wireless goods. Radio Amateur, Marion, Ill.

Wanted—Screw-cutting Bench Lathe. W. T. Gravely, Danville, Va.

For Sale—1/4 H.P. turbine with flash boiler and condenser. Want omnigraph. Joe Martin, Hopkinsville, Ky.

Wanted—Wireless goods, describe fully. Will pay cash. Merle Hawkins, 1015 Prescott, Canon City, Colo.

Wanted—Round Audion, 1 K.W. Oscillation Transformer, Aerial Switch, Rotary Gap. Eugene Beckley, Milton, Pa.

Sell—15 dial omnigraph and other things. Hersee, Burlington, Ontario.

Electrical Laboratory for Sale. Send for list of apparatus and parts. Ray Wengel, 29 W. Doty St., Madison, Wis.

Will Buy—No reasonable offer refused. Tubular Audions, other makes also, variable condensers mounted and unmounted, Blitzen preferred; Blitzen amplifying transformer. Audion impedance coils. Sell now, give description and time used. State lowest price. Aubrey Tholin, 1339 5th Ave., Rockford, Illinois.

Wanted—A few old hand telescope views, 50c each for certain kinds. Write for information. John Murray, Remington Hotel, Eddystone, Pa.

For Sale—Hydroplane. Length sixteen feet, beam 5 feet. Electric lights including searchlight. Automobile Steering Wheel and controls. Name: Sea Gull. Double cylinder Gray two cycle, high speed, twelve horsepower motor. Speed 20 miles per hour. Decks and bulkhead mahogany finished and varnished. Double waterproof hatch. Fastest boat of her class on Indian River. Winner of many races. In perfect condition; just painted. Don't wait until someone beats you to it. Shipped for first \$200 check. Atlee Gullidge, c/o Coast Guard Station 206, Fort Pierce, Fla.

For Sale—One set E. I. Co. S. P. 2000 ohm Phones, new, \$2.50. One 120 Egg Electric Incubator, 110 volts, \$18. One 3 pole 75A Knife Switch, \$2. One Small Moving Picture Machine with 100 w. 110 v. lamp (without reels), \$2. One large Electric Bell, \$1. One Boy's Mechanic Vol. 2, \$1. One 2 cap. 110 v. Electric Stove, \$8. Edwin L. Murrill, Lewisburg, W. Va.

Will Exchange complete motorcycle engine for Johnson skates. W. A. Schoenheider, 5431 So. Ashland Ave., Chicago.

Amateurs—Bugs—Send stamp for my list of Radio Apparatus, Electrical Goods, Ancient and Modern Coins, Swords, Arrowheads, Chemical Laboratory, Rifle, Movie Projector Lens, etc. Luther Reiner, Bexley, Ohio.

Marionettes, miniature people who walk, talk, sing and dance. Five professional figures. Will sell for cash or exchange for Smith Motor Wheel or similar outfit. The Wallace, Baraboo, Wis.

Bargains—New \$25 Stewart Speedometer, \$15. Book and others. Write Worth Bailey, Park Ave., Johnstown Pa.

CARNOTITE

(Radium Mineral.) The American Pitchblende found in Colorado, from which Radium is extracted.

A generous piece, enough to conduct experiments, such as affecting photographic plates thru opaque material (similar to X-Ray pictures), first made by Sir W. Crookes and Mme. Curie, is furnished in neat, wooden box.

URANIUM ORE (Radio-Active)

Containing about 35% of pure Uranium; also Radium and Vanadium. One of the most rare and interesting minerals. Twenty milligrams are furnished in glass vial protected by lead cover.

One box of Carnotite and one vial of Uranium Ore as described above sent prepaid. 50c.

SIDNEY SPECIALTY CO.
233 Fulton St., New York City

BOYS, LOOK!

A REAL Electric MOTOR 50c

Some hummer. Develops wonderful power. Will run your Erectors, Meccanos, etc. Works on 1 to 6 dry cells, storage battery or A. C. transformer. Mounted on hardwood base. Has 1/4 in. grooved pulley. On two cells you can hardly stop it with your finger. Runs all kinds of toys. Has nicked steel frame and copper armature. Put 50 cents in stamps in an envelope.

FREE A 3 1/2 volt tungsten flashlight lamp if you order at once.

Use Coupon Below. Return mail will bring you Motor.

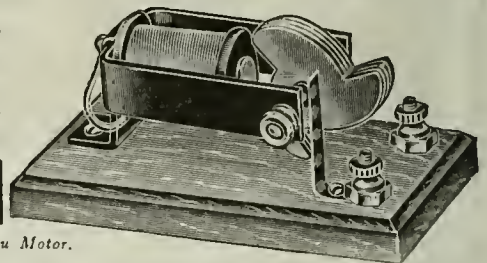

C. D. WOOD ELECTRIC CO., Dept. 60, 441 Broadway, New York City.
 SIRS: Send me a MONOCOIL Motor. Enclosed find 50 cents.

Name
 Address

CORE WIRE

We have been fortunate in securing thru auction several tons of guaranteed pure, double annealed Norway Iron Core Wire and are selling this wire to "Experimenter" readers

AT PRE-WAR PRICES 20cts LB.

This wire is just the thing for spark coils, transformers, etc., and it is, of course, a very much more superior product than the usual iron wire. We absolutely guarantee the quality.

If you ever thought of building a spark coil, transformer, or similar apparatus, now is the chance to get the right material for it. As far as we know this is the only lot of Iron Norway Core Wire in the hands of any dealer at the present time, and none can be gotten until after the war.

We have only two sizes left:

26 INCHES

36 INCHES

Thickness about No. 21 B and S

If either of these sizes should be too long we advise cutting the wire down yourself by means of shears. It will pay you to do so as real Norway Iron Wire, sold by a few dealers last year, brought from 40c to 50c a pound. American core wire now sells for from 30c upwards per pound. As long as the supply lasts we offer this wire as described above to our customers at the very low price of 20c a pound. Order at once.

ELECTRO IMPORTING CO., 231 Fulton St., N. Y. C.

\$5.

EXPERIMENTERS!

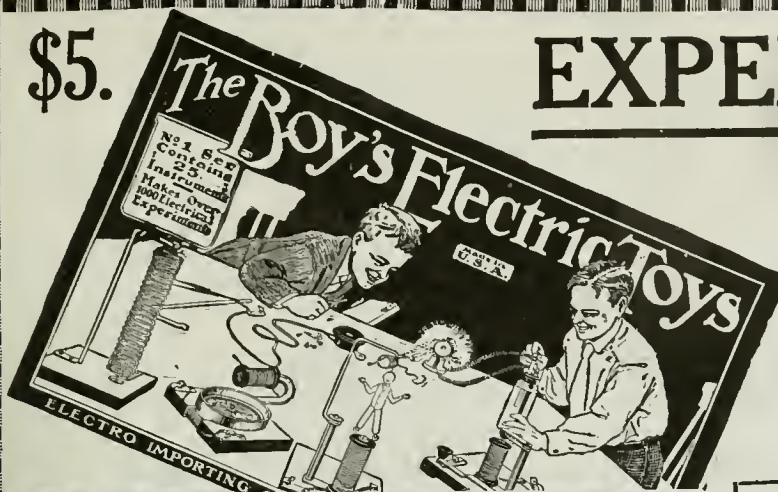

A Sample of What You Can Do With This Outfit

This illustration, made from an actual photograph, shows only a very few instruments that can be made with the Boy's Electric Toys: Electric Pendulum, Electric Telegraph, Current Generator, Electric Spectra Spiral, Galvanometer. Space does not permit us to show the hundreds of experiments that can be performed with this wonderful outfit.

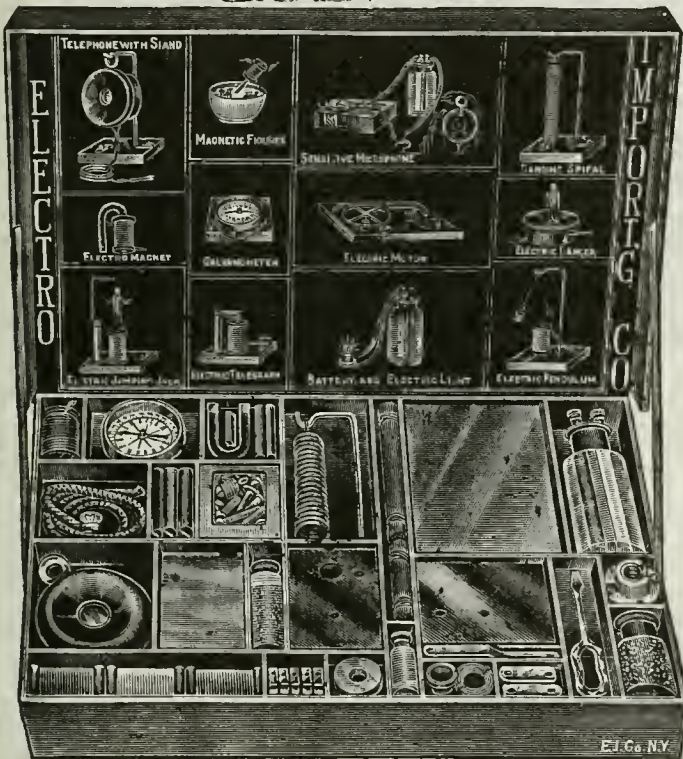
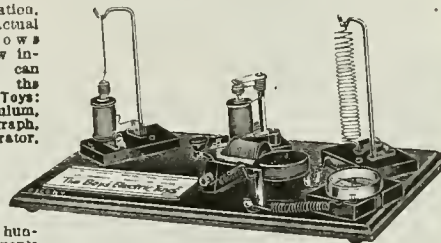

No. EX2002

"THE BOY'S ELECTRIC TOYS" contains enough material to make and complete over TWENTY-FIVE DIFFERENT ELECTRICAL APPARATUS without any other tools, except a screw-driver furnished with the outfit. The box contains the following complete instruments and apparatus which are already assembled:

Student's chromic plunge battery, compass-galvanometer, solenoid, telephone receiver, electric lamp. Enough various parts, wire, etc., are furnished to make the following apparatus:

Electromagnet, electric cannon, magnetic pictures, dancing spiral, electric hammer, galvanometer, voltmeter, hook for telephone receiver, condenser, sensitive microphone, short distance wireless telephone, test storage battery, shocking coil, complete telegraph set, electric riveting machine, electric buzzer, dancing fishes, singing telephone, mysterious dancing man, electric jumping jack, magnetic geometric figures, rheostat, erratic pendulum, electric butterfly, thermo electric motor, visual telegraph, etc., etc.

This does not by any means exhaust the list, but a great many more apparatus can be built actually and effectually.

With the instruction book which we furnish, one hundred experiments that can be made with this outfit are listed, nearly all of these being illustrated with superb illustrations. No other materials, goods or supplies are necessary to perform any of the one hundred experiments or to make any of the 25 apparatus. Everything can be constructed and accomplished by means of this outfit, two hands, and a screw-driver.

The outfit contains 114 separate pieces of material and 24 pieces of finished articles ready to use at once.

Among the finished material the following parts are included: Chromic salts for battery, lamp socket, bottle of mercury, core wire (two different lengths), a bottle of iron filings, three spools of wire, carbons, a quantity of machine screws, flexible cord, two wood bases, glass plate, paraffine paper, binding posts, screw-driver, etc., etc. The instruction book is so clear that anyone can make the apparatus without trouble, and besides a section of the instruction book is taken up with the fundamentals of electricity to acquaint the layman with all important facts in electricity in a simple manner.

We guarantee satisfaction. The size over all of the outfit is 14 x 9 x 2 3/4. Shipping weight, 3 lbs. \$5.00 No. EX2002 "The Boy's Electric Toys" outfit as described.....**\$5.00**
IMMEDIATE SHIPMENTS

ELECTRO IMPORTING CO., 231 Fulton St. NEW YORK

The "Electro" Radiotone HIGH FREQUENCY SILENT TEST BUZZER

This instrument gives a wonderful high pitched MUSICAL NOTE in the receivers, impossible to obtain with the ordinary test buzzer. The **RADIOTONE** is built along entirely new lines; it is NOT an ordinary buzzer, reconstructed in some manner. The **RADIOTONE** has a single fine steel reed vibrating at a remarkably high speed adjusted to its most efficient frequency at the factory. Hard silver contacts are used to make the instrument last practically forever.



Yes, the **RADIOTONE** is SILENT. In fact, it is so silent that you must place your ear on top of it to hear its beautiful musical note. You will be astounded at the wonderfully clear, 500 cycle note, sounding sharply in your receivers. To learn the codes, there is absolutely nothing like it. With the radiotone, a key and one dry cell and ANY telephone, a fine learner's set is had. Two or more such sets in series will afford no end of pleasure for intercommunication work. Shipping Weight 1 lb. Radiotone as described.....each **\$.90**
IMMEDIATE SHIPMENTS

The "Electro" Telegraph

is not a toy, but a practical, honestly built telegraph outfit, which not only sounds but works like the big commercial instruments. By studying the code for 30 days you can become a first-class telegraph operator. Such operators are in big demand now. Outfit consists of TWO complete telegraph instruments each measuring 3 1/2 x 2 1/2 x 2 1/4. All metal parts are highly nickel plated, including key lever. Note hard rubber knob. Telegraph Code Chart, telegraph blanks and connecting wire comes with set, but no batteries. Outfit works on 2 dry cells (one cell for each instrument). The "Electro" is the ONLY outfit that works both ways, each station can call; no switches, no extras. Nothing to get out of order. Guaranteed to please you or money back. Price Complete as illustrated (TWO INSTRUMENTS).. **\$1.25**
Shipping Weight, 2 lbs. IMMEDIATE SHIPMENTS



The "Electro" Codophone (Patents Pending)

What this remarkable instrument is and does.

The "Electro" Codophone is positively the only instrument made that will imitate a 500 cycle note exactly as heard in a Wireless receiver. The loud-talking receiver equipped with a horn, talks so loud that you can hear the sound at the end of the room, even if there is a lot of other noise.

THAT'S NOT ALL. By lessening or tightening the receiver cap, a tone from the lowest, softest quality, up to the loudest and highest screaming sound can be had in a few seconds.

FOR INTERCOMMUNICATION. Using two dry cells for each instrument, two Codophones when connected with one wire and return ground, can be used for intercommunication between two houses one-half mile apart. One outfit alone replaces the old-fashioned learner's telegraph set, consisting of key and sounder.

The "Electro" Codophone is a handsome, well made instrument, fool proof, and built for hard work. Contacts are of hard silver 3/8 inch in diameter that will outlast the instrument.

There is also a neat code chart and full directions enabling any intelligent young man or girl to learn the codes within 30 days, practising one-half hour a day. Sizes: 6 3/4 x 3 x 2 3/4. Shipping weight, 2 lbs. The "Electro" Codophone as described, complete..... **\$1.50**

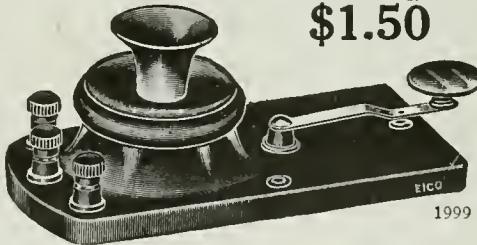

"The Livest Catalog in America"
Our big, new electrical cyclopedia No. 19 is waiting for you. Positively the most complete Wireless and electrical catalog in print today. 228 Big Pages, 600 illustrations, 500 instruments and apparatus, etc. Big "Treatise on Wireless Telegraphy." 20 FREE coupons for our 160-page FREE Wireless Course in 20 lessons. FREE Cyclopedia No. 19 measures 7x5 1/4. Weight 1/2 lb. Beautiful stiff covers.



ELECTRO IMPORTING COMPANY
231 Fulton St., New York City

I enclose herewith 6 cents in stamps or coin for which please send me your latest Cyclopedia Catalog No. 19 as described.

NAME
ADDRESS
STATE

"The Baby" Double Action Hammerless Revolver

A HANDSOME AND MOST EFFECTIVE WEAPON

\$5.50

Measures but 4 1/2 inches long. Takes regular .22 calibre cartridges. The new Baby Double Action Hammerless Revolver has been produced to meet the ever increasing demand for a revolver that would combine small size and light weight with the essential features of efficiency and practicality.

The CONJURER'S CASKET

Apparatus and Directions for a Number of Mysterious Tricks. Enough for an Entire Evening's Entertainment. ANYONE CAN DO THEM. PRICE 50c POSTPAID

Get this Conjurer's Cabinet. It contains the apparatus for seven first-rate tricks, including The Disappearing Rose, that, when placed on the table of your coat...

The Border Bandit Books

Thrilling Adventures and Daring Deeds of Notorious Outlaws



PRICE 25 CENTS OR THE FULL 19 BOOKS \$4.00 POST ONLY 25 CENTS EACH; SERIES OF 19 FOR \$4.00 PAID

- 1. The Border Bandits, by Harry Hawkeye. 2. The Dalton Boys and Their Gang of desperadoes, by Harry Hawkeye. 3. Buffalo Bill, King of the Scouts, by Harry Hawkeye.

Trim Your Own Hair With the Utility Safety Hair Cutter

Cuts the Hair Any Length, Short or Long—Saves Its Cost First Time Used.

PRICE ONLY 35c POSTPAID. EXTRA BLADE \$.35c E. O. C. H. If you can COME your hair you can TRIM your own hair with this marvelous invention.

7-in-1 Combination Bill Book

With Name Stamped In 23-Karat Gold Letters

A new view of getting our name still more widely known is to have each of our new customers make this RE-MARKABLE OFFER of a handsome leather combination Bill Book. It contains 23 Karat Gold Lettering for ONLY 50 cents postpaid.

NEW BOOK ON ROPE SPlicing

USEFUL KNOTS, HITCHES, SPLICES, ETC. How Different Knots Are Made and What They Are Used For. Knots to Use and Knots to Avoid.

A most practical handbook giving complete and simple direction for making all the most useful knots, hitches, rigging, splicing, etc. Over 100 Illustrations. All about wire rope attachments, lashing, blocks, pulleys, etc. Price 50c postpaid.

THE EXPO WATCH CAMERA

The most wonderful and ingenious camera made

It is but little larger than a watch, which it closely resembles. You can carry the Expo about in your pocket and take pictures without any one being the wiser.

Price \$2.50. QUICK AS A FLASH Time and instantaneous shutter; weighs but 8 ounces; nickel plated. Endorsed by amateurs and professionals the world over.

EXPO WATCH CAMERA \$2.50. FILMS 10 Exposures 15c, 25 Exposures 25c. Exp. watch camera, 10c. Exp. watch camera, 10c. Exp. watch camera, 10c.

ELECTRIC INSOLES

Comforting to the Feet and Healthful. You will never suffer from Cold Feet while you wear these Electric Insoles. Any size. Comfortable even in a tight shoe.

THE FIGHTING DREADNAUGHT

Sensationally Realistic! Exact Model of Modern Warship

The greatest toy sensation of the day. The Fighting Dreadnaught is an exact model of Uncle Sam's latest fighting monster. It carries eight big guns, each of which flashes at correct intervals, from twelve to twenty times.

INVISIBLE INK

The most confidential message can be written with this Ink, for its writing MAKES NO MARK. Cannot be seen unless you know the secret. Invisible for many reasons.

LUMINOUS INK

writing can be READ ONLY IN A DARK ROOM; writing shines like fire. Quite invisible at daytime. Very remarkable. 15c bottle; 3 for 40c postpaid.

THE MINSTREL SHOW

Only 10c Postpaid. This is the most amusing and hilarious farce. The very best marks, as they never suspect the real source, but think they have caught it from the other.

New Vamping Card

No Teacher Needed Surprisingly Simple System. Persons having neglected their Musical Education need not despair, for with the aid of our new VAMPING CARD (placing the card upright over the piano keys), you can at once learn every tone of the grand instrument.

MUSICAL KAZOO MAGIC FLUTE

With the Musical Kazoo you can, without previous practice whatsoever, play a very fine line right off. imitate the cry of an animal, such as, enare drum, Punch and Judy, etc.

Sneezing Powder

Place a very small amount of this Sneezing Powder on the tip of your nose and blow it into your nose. The air, and everyone in the room, will begin to sneeze without knowing the reason why.

Serpent's Eggs

Each box contains 10 eggs, which are much larger than a regular egg. When it with a match, however, each one gradually hatches itself into a Snake several feet long, which curls and twists about in a most lifelike manner.

CIGARETTE ROLLER

Very neat and handy. Weighs less than a quarter of an ounce. It makes better cigarettes than you can buy and makes them easily and quickly.

STAGE MONEY

With a bunch of these bills, it is easy for each person of limited means to appear prosperous. By flashing a roll of these bills at the proper time and preying off a genuine bill or two from the outside of the roll, the effect created must be found to be all that can be desired.

A Great Curiosity Midget Illustrated Bible

The Midget Bible is a perfect gem, and a work of art. It is about the size of a postage stamp and contains TWO HUNDRED AND FIFTY PAGES OF THE HOLY TESTAMENT, profusely illustrated.

Latest Novelty: Aerial Balloon

Floating gracefully in or outdoors. VELOCITY IN STAIRS. A brightly colored balloon that measures sixteen inches long is blown up in the usual way and, when released, the air pressure sends the balloon soaring UPWARD, the effect is startling. It is a graceful tier that makes the youngsters WILD WITH JOY.

LUMINOUS PAINT

The very latest discovery in the scientific world. Either, presciently or as a result of accident, it was discovered that certain substances, when applied to the surface of any article, emit rays of white light, rendering it perfectly visible in the dark.

Thumb Brander

WRITES with WATER 600 words you dip. Makes its own ink. Writes fashionable violet color. Dries at once, and is cheaper than fountain pens. Writes a long letter with one dip in plain water. No trouble—no bother—no noise. A pleasure to use. With Nickel Plated Resilient Rubber to CARRY, 3 for 25c postpaid. Extra Points 5c, 6 for 25c.

All the Latest Surprising and Joke Novelties

- Pharo's Serpents, Eggs, box, 10c. Miniature Water Pistol, 10c. Elephant (two feet high), 10c.



Every Electrical Man Wants These Books and we ship them for your inspection **FREE**

Flexible
Covers
—
Handy
Pocket-
Size
Volumes



10
Volumes
3500
Pages
4700
Pictures
\$1 Per
Volume
\$1 Per
Month

Just what you need to know to succeed in **ELECTRICITY**

EVERY electrician, every engineer, every mechanic should know about these wonderfully helpful instructive books, which give in plain words a complete working knowledge of electrical engineering in all its phases.

You run into some new electrical problem almost every day. The information you need to help you in your every day work is in

HAWKINS ELECTRICAL GUIDES

These books place electricity at your finger ends. They cover every imaginable subject, principle, theory, problem, trouble, and way of doing things electrically. Every subject is indexed so that you can turn right to it. They are a study course and a reference guide in one, written in plain every day language—no wasted words—only what you need to know—chock full of up-to-the-minute electrical knowledge. The guides are a complete course in electrical engineering. They will help you in every detail of the day's electrical work. You can't ask an electrical question that Hawkins Guides can't answer.

Pocket-Size Flexible Covers

The books are small enough to slip into your coat pocket—handsomely bound in flexible black covers. You can carry each volume with you until you have mastered its contents. 3,500 pages of actual information and 4,700 illustrations. "Once you see these books and put them into actual use you will never again want to be without them. Try it at our expense."

SEND NO MONEY

It will cost you nothing to receive these books—to look them over—ask them all the questions you can think of—use them in your work—study them—pick up some information that will increase your earning ability. We will ship you the entire set of 10 volumes entirely FREE. This is a sign of our confidence in the guides. Pure gold does not object to being tested. Keep them for seven days and if you do not decide that you can't get along without them, return them to us and owe us nothing.

When you decide to keep them you only have to pay \$1.00 down and remit the balance of \$9.00 on the easy payment of \$1.00 a month till paid for. Use this coupon to get the books. It will pay you many times over.

THEO. AUDEL & CO.
72 Fifth Ave. New York, N. Y.

SEND NO MONEY-USE THE COUPON

READ THIS PARTIAL LIST OF CONTENTS

- No. 1** Contains 348 pages, 398 illustrations. Electrical signs and symbols—static and current electricity—primary cells—conductors and insulators—resistance and conductivity—magnetism—induction coils—dynamo principles—classes of dynamos—armatures—windings—commutation—brushes, etc.
- No. 2** Contains 342 pages, 394 illustrations. Motor principles—armature reaction—motor starting—calculations—brake horsepower—selection and installation of dynamo and motors—galvanometers—standard cells—current measurement—resistance measurement—voltmeters—wattmeters—watt hour meters—operation of dynamos—operation of motors, etc.
- No. 3** Contains 300 pages, 423 illustrations. Distribution systems—wire and wire calculations—inside, outside and underground wiring—sign flashers—lightning protection—rectifiers—storage battery systems, etc.
- No. 4** Contains 270 pages, 379 illustrations. Alternating current principles—alternating current diagrams—the power factor—alternator principles—alternator construction—windings, etc.
- No. 5** Contains 320 pages, 614 illustrations. A. C. Motors—synchronous and induction motor principles—A. C. commutator motors—induction motors, transformers; losses, construction, connections, tests—converters—rectifiers, etc.
- No. 6** Contains 298 pages, 472 illustrations. Alternating current systems—switching devices—circuit breakers—relays—lightning protector apparatus—regulating devices—synchronous condensers—indicating devices—meters—power factor indicators—wave form measurement—switch boards, etc.
- No. 7** Contains 316 pages, 379 illustrations. Alternating current, wiring power stations—turbines; management, selection, location, erection, testing, running, care and repair—telephones, etc.
- No. 8** Contains 332 pages, 436 illustrations. Telegraph—simultaneous telegraphy and telephony—wireless—electric bells—electric lighting—photometry, etc.
- No. 9** Contains 322 pages, 627 illustrations. Electric railways—electric locomotives—car lighting—trolley car operation—miscellaneous applications—motion pictures—gas engine ignition—automobile self-starters and lighting systems, electric vehicles, etc.
- No. 10** Contains 613 pages, 599 illustrations. Elevators—cranes—pumps—air compressors—electric heating—electric welding—soldering and brazing—industrial electrolysis—electro plating—electro-therapeutic—X-rays, etc.

Also a complete 126-page ready reference index of the complete library. This index has been planned to render easily accessible all the vast information contained in the 10 electrical guides. There are over 13,500 cross references. You find what you want to know instantly.

THEO. AUDEL & CO.
72 Fifth Avenue
New York, N. Y.

Please submit me for examination Hawkins Electrical Guides (price \$1 each). Ship at once, prepaid, the 10 numbers. If satisfactory I agree to send you \$1 within seven days and to further mail you \$1 each month until paid.

Signature

Occupation

Business Address

Residence

Reference

What Electrical Men Say

Helped Him Make Good

"It is only right for me to recommend highly the Hawkins Guides, for they have been of the greatest assistance to me in placing me in my present position as Superintendent of Construction Department of one of Ohio's largest Electrical Companies. I would like to see every man have a set of Hawkins Guides."
Geo. Knecht, Columbus, Ohio.

In the Naval Electrical Dept.

"The Hawkins Guides are great help to me in the Naval Electrical Department, which they cover very thoroughly."
C. J. Cornell,
U. S. Receiving Ship, Brooklyn, N. Y.

Superintendent

"I am now superintendent of the Dunnville Hydro-Electric Systems, and Hawkins Guides were a great help to me in holding down a responsible position."
W. E. Swartz, Dunnville, Ontario.

Wireless Operators

"I have worked wireless for ten years—but I wish I had these books years ago, as they have saved me a great deal of trouble."
H. Marshall,
Steamer M & B No. 2,
Walkerville, Or.



These Are The Hours That Count

MOST of your time is mortgaged to work, meals and sleep. But the hours after supper are *yours*, and your whole future depends on how you spend them. You can fritter them away on profitless pleasure, or you can make those hours bring you position, money, power, *real success* in life. Thousands of splendid, good-paying positions are waiting in every field of work for men *trained to fill them*. There is a big job waiting for *you*—in your present work or any line you choose. Get ready for it! You can do it without losing a minute from work or a wink of sleep, without hurrying a single meal, and with plenty of time left for recreation. You can do it in one hour after supper each night, right at home, through the International Correspondence Schools.

Yes—You Can Win Success in an Hour a Day

Hundreds of thousands have proved it. The designer of the Packard "Twin Six" and hundreds of other Engineers, climbed to success through I.C.S. help. The builder of the great Equitable Building, and hundreds of Architects and Contractors, won their way to the top through I.C.S. spare-time study. Many of this country's foremost Advertising and Sales Managers prepared for their present positions in spare hours under I.C.S. instruction.

For 26 years men in offices, stores, shops, factories, mines, railroads—in every line of technical and commercial work—have been winning promotion and increased salaries through the I.C.S. Over 100,000 men are getting ready *right now* in the I.C.S. way for the bigger jobs ahead.

TEAR OUT HERE

INTERNATIONAL CORRESPONDENCE SCHOOLS

Box 6169, SCRANTON, PA.

Explain, without obligating me, how I can qualify for the position, or in the subject, before which I mark X.

- | | | |
|--|---|--|
| <input type="checkbox"/> ADVERTISING | <input type="checkbox"/> ELECTRICAL ENGINEER | <input type="checkbox"/> MECHANICAL ENGINEER |
| <input type="checkbox"/> SALESMANSHIP | <input type="checkbox"/> Electrician | <input type="checkbox"/> Mechanical Draftsman |
| <input type="checkbox"/> Traffic Management | <input type="checkbox"/> Electric Wiring | <input type="checkbox"/> Machine Designer |
| <input type="checkbox"/> BUSINESS (Complete) | <input type="checkbox"/> Electric Lighting | <input type="checkbox"/> Machine Shop Practice |
| <input type="checkbox"/> Commercial Law | <input type="checkbox"/> Electric Car Running | <input type="checkbox"/> Boilermaker or Designer |
| <input type="checkbox"/> Certified Public Accountant | <input type="checkbox"/> Heavy Electric Traction | <input type="checkbox"/> Patternmaker |
| <input type="checkbox"/> Higher Accounting | <input type="checkbox"/> Electrical Draftsman | <input type="checkbox"/> Toolmaker |
| <input type="checkbox"/> Railway Accountant | <input type="checkbox"/> Electric Machine Designer | <input type="checkbox"/> Foundry Work |
| <input type="checkbox"/> BOOKKEEPER | <input type="checkbox"/> Telegraph Engineer | <input type="checkbox"/> Blacksmith |
| <input type="checkbox"/> Stenographer & Typist | <input type="checkbox"/> Telephone Work | <input type="checkbox"/> Sheet-Metal Worker |
| <input type="checkbox"/> Good English | <input type="checkbox"/> ARCHITECT | <input type="checkbox"/> STEAM ENGINEER |
| <input type="checkbox"/> Window Trimmer | <input type="checkbox"/> Architectural Draftsman | <input type="checkbox"/> Stationary Fireman |
| <input type="checkbox"/> Show-Card Writer | <input type="checkbox"/> Contractor and Builder | <input type="checkbox"/> MARINE ENGINEER |
| <input type="checkbox"/> Sign Painter | <input type="checkbox"/> Building Foreman | <input type="checkbox"/> GAS ENGINE OPERATING |
| <input type="checkbox"/> CIVIL SERVICE | <input type="checkbox"/> Carpenter | <input type="checkbox"/> Refrigeration Engineer |
| <input type="checkbox"/> Railway Mail Clerk | <input type="checkbox"/> Concrete Builder | <input type="checkbox"/> CIVIL ENGINEER |
| <input type="checkbox"/> Mail Carrier | <input type="checkbox"/> PLUMBER & STEAM FITTER | <input type="checkbox"/> Surveying and Mapping |
| <input type="checkbox"/> CARTOONIST | <input type="checkbox"/> Heating and Ventilation | <input type="checkbox"/> R. R. Constructing |
| <input type="checkbox"/> Distractor | <input type="checkbox"/> Plumbing Inspector | <input type="checkbox"/> Bridge Engineer |
| <input type="checkbox"/> Perspective Drawing | <input type="checkbox"/> Foreman Plumber | <input type="checkbox"/> SHIP DRAFTSMAN |
| <input type="checkbox"/> Carpet Designer | <input type="checkbox"/> CHEMIST | <input type="checkbox"/> Structural Draftsman |
| <input type="checkbox"/> Wallpaper Designer | <input type="checkbox"/> Analytical Chemist | <input type="checkbox"/> Structural Engineer |
| <input type="checkbox"/> Bookcover Designer | <input type="checkbox"/> RISE POWER ENGINEER | <input type="checkbox"/> Municipal Engineer |
| <input type="checkbox"/> TEACHER | <input type="checkbox"/> Coal Mining | <input type="checkbox"/> NAVIGATION <input type="checkbox"/> Spanish |
| <input type="checkbox"/> Common School Subjects | <input type="checkbox"/> Metal Mining | <input type="checkbox"/> Motor Boat Buoy <input type="checkbox"/> French |
| <input type="checkbox"/> High School Subjects | <input type="checkbox"/> Metallurgist or Prospector | <input type="checkbox"/> AGRICULTURE <input type="checkbox"/> Italian |
| <input type="checkbox"/> Mathematics | <input type="checkbox"/> Assayer | <input type="checkbox"/> Fruit Growing |
| <input type="checkbox"/> AUTOMOBILE OPERATING | <input type="checkbox"/> TEXTILE OVERSEER OR SUPT. | <input type="checkbox"/> Vegetable Growing |
| <input type="checkbox"/> Automobile Repairing | <input type="checkbox"/> Cotton Manufacturing | <input type="checkbox"/> Live Stock and Dairying |
| <input type="checkbox"/> Auto. Electrical Work | <input type="checkbox"/> Woollen Manufacturing | <input type="checkbox"/> POULTRY RAISING |

Name _____

Occupation _____ Employer _____

Street and No. _____

City _____ State _____

Canadians may send this Coupon to
International Correspondence Schools, Montreal, Can.

Your Chance Is Here!

No matter where you live, the I.C.S. will come to *you*. No matter what your handicaps, or how small your means, we have a plan to meet your circumstances. No matter how limited your previous education, the simply written, wonderfully illustrated I.C.S. textbooks make it easy to learn. No matter what career you may choose, some one of the 280 I.C.S. Courses will surely suit your needs.

Make Your Start Now!

When everything has been made easy for you—when one hour a day spent with the I.C.S. in the quiet of your own home will bring you a bigger income, more comforts, more pleasures, all that success means, can you afford to let another single priceless hour of spare time go to waste? Make your start right now! This is all we ask: Without cost, without obligating yourself in any way, put it up to us to prove how we can help you.

**Just Mark
and Mail This Coupon**